



# Tourguide Wireless Transmitter SR 2020 D



Instruction manual



# Contents

Important safety instructions .....	2
Delivery includes .....	4
System components .....	4
Tourguide system overview .....	4
Areas of application .....	5
Connection possibilities .....	6
Product overview .....	7
Indications and displays on the transmitter .....	8
Putting the SR 2020 D into operation .....	9
Preparing the transmitter for use .....	9
Connecting the transmitter to the mains .....	12
Connecting external devices .....	12
Connecting the headphones .....	13
Operating the SR 2020 D .....	14
Switching the transmitter on/off .....	14
Working with the operating menu .....	14
Selecting the menus .....	16
Overview of the operating menu .....	22
Cleaning the SR 2020 D .....	24
If a problem occurs.... ..	24
Accessories and spare parts .....	25
Specifications .....	26
Manufacturer Declarations .....	27
Index .....	29

Thank you for choosing Sennheiser!

We have designed this product to give you reliable operation over many years. Over 60 years of accumulated expertise in the design and manufacture of high-quality electro-acoustic equipment have made Sennheiser a world-leading company in this field.

Please take a few moments to read these instructions carefully, as we want you to enjoy your new Sennheiser products quickly and to the fullest.

# Important safety instructions

- Read this instruction manual.
- Keep this instruction manual. Always include this instruction manual when passing the device on to third parties.
- Clean only with a dry cloth.
- The configuration of the transmitter must only be carried out by professionally trained personnel.
- Refer all servicing to qualified service personnel.  
Servicing is required if the device has been damaged in any way, liquid has been spilled, objects have fallen inside, the device has been exposed to rain or moisture, does not operate properly or has been dropped.
- **WARNING:** To reduce the risk of fire or electric shock, do not expose the device and the mains unit to rain or moisture.
- Do not place objects filled with liquids, such as vases or coffee cups, on the device.
- Disconnect the mains connector from the wall socket
  - to completely disconnect the device from the mains,
  - during lightning storms or when unused for long periods of time.
- Use only the supplied mains unit.
- Ensure that the mains unit is:
  - always readily operable and easily accessible,
  - properly plugged into the wall socket,
  - only operated within the permissible temperature range (see “Specifications” on page 26).
  - not covered or exposed to direct sunlight for longer periods of time in order to prevent heat accumulation.

## Overloading

Do not overload wall outlets and extension cables as this may result in fire and electric shock.

## Replacement parts

When replacement parts are required, be sure the service technician has used replacement parts specified by Sennheiser or those having the same characteristics as the original part. Unauthorized substitutions may result in fire, electric shock, or other hazards.

## Danger due to high volumes

This is a professional device. Commercial use is subject to the rules and regulations of the trade association responsible. Sennheiser, as the manufacturer, is therefore obliged to expressly point out possible health risks arising from use.

This device is capable of producing sound pressure exceeding 85 dB(A). 85 dB(A) is the sound pressure corresponding to the maximum permissible volume which is by law (in some countries) allowed to affect your hearing for the duration of a working day. It is used as a basis according to the specifications of industrial medicine. Higher volumes or longer durations can damage your hearing. At higher volumes, the duration must be shortened in order to prevent hearing damage. The following are sure signs that you have been subjected to excessive noise for too long a time:

- You can hear ringing or whistling sounds in your ears.
- You have the impression (even for a short time only) that you can no longer hear high notes.

## Intended use of the device

Intended use of the device includes:

- using the device for professional purposes,
- having read these instructions especially the chapter "Important safety instructions" on page 2,
- using the device within the operating conditions and limitations described in this instruction manual.

"Improper use" means using the device other than as described in these instructions, or under operating conditions which differ from those described herein.

## Delivery includes

- 1 SR 2020 D transmitter
- 1 NT 2 mains unit
- 1 telescopic antenna
- 1 GA 2 rack adapter, consisting of:
  - 2 rack mount "ears"
  - 1 blanking plate
  - 1 jointing plate
  - 2 blanking plugs for closing off unused BNC holes
  - 12 recessed head screws M 3x6
  - 2 recessed head screws M 6x10
- 4 device feet
- 1 instruction manual

## System components

The SR 2020 D transmitter allows the stationary use of the Tourguide 2020 D system. The transmitter can be combined with the following individual components:

- HDE 2020 D stethoset receivers
- EZL 2020-20 L charging case including instruction manual of the overall system
- L 2021-40 charger (incl. "Conference Control" software)

## Tourguide system overview

Together with the SR 2020 D transmitter, the Tourguide 2020 D system offers optimum digital speech transmission for the following applications:

- simultaneous interpretations and
- stationary guided tours

## Areas of application

### Simultaneous interpretations during conferences ("Conference" mode)

The main application of the stationary SR 2020 D transmitter is its use for simultaneous interpretations during conferences.

Eight fixed transmission frequencies allow for interference-free simultaneous interpretations in up to eight languages (see "Transmitting several languages simultaneously" on page 17).

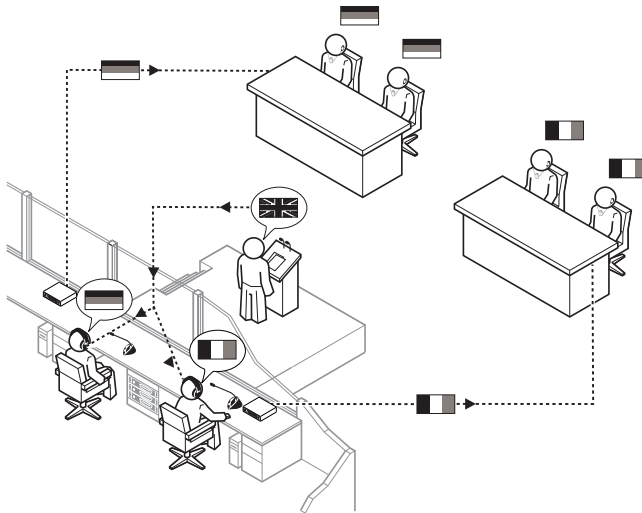

### Stationary guided tours ("Tourguide" mode)

With a stationary guided tour, both the group and the transmitters are in a fixed location.

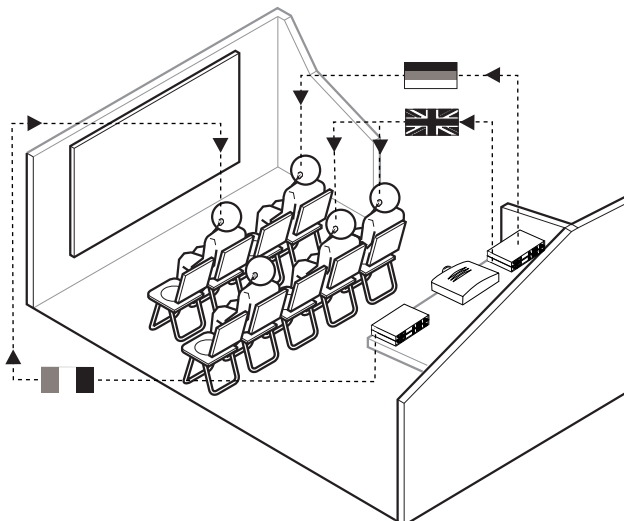

Examples for stationary guided tours are multimedia presentations, movie shows as well as boat and bus tours in several languages.

Six fixed transmission frequencies allow for simultaneous transmission in up to six languages (see "Transmitting several languages simultaneously" on page 17).

The Tourguide 2020 D system operates in the 863 MHz– 865 MHz frequency band, which is license-free in Europe (see "Specifications" on page 26).

## Connection possibilities

You can connect one of the following [phantom-powered Sennheiser condenser microphones](#) (not included) to the SR 2020 D transmitter:

- ME 34, ME 35, ME 36

In addition, you can connect an audio source to the transmitter:

- Conference/interpretation systems
- MP3 player
- CD /DVD player



# Product overview

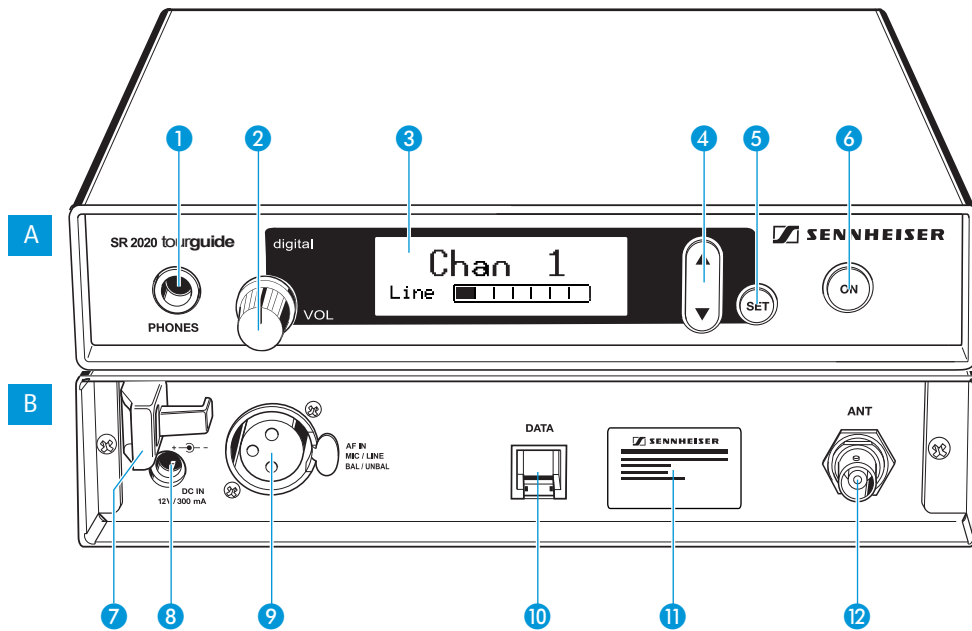

## A Operating controls - front

- 1 Headphone output (**PHONES**), 1/4" (6.3 mm) jack socket
- 2 Headphone volume control (**VOL**)
- 3 Display, backlit
- 4 ▲/▼ rocker button, backlit
- 5 **SET** button, backlit
- 6 **ON** button, backlit (serves as the ESC (cancel) key in the operating menu)

## B Operating controls - rear

- 7 Cable grip for mains cable
- 8 Socket for connection of mains unit (**DC IN 12 V/300 mA**)
- 9 Audio input (**AF IN MIC/LINE**), XLR-3F socket
- 10 Service interface (**DATA**)
- 11 Type plate
- 12 Antenna output (**ANT**), BNC socket

## Indications on the display panel

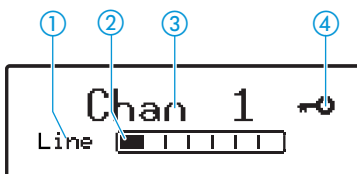

- 1 Display for the selected signal source (**Mic/Line**)
- 2 **Mic/Line** level display
- 3 Channel display
- 4 Lock mode icon (lock mode is activated)

## Indications and displays on the transmitter

### Display for the selected signal source (Mic/Line)



You can connect either a condenser microphone or an external audio source to the transmitter.

If you connect a condenser microphone, select "Mic" via the operating menu. If you connect an external audio source, select "Line" (see page 19).

"Mic" or "Line" appears on the display ①.

#### Note:

If the "Mic" microphone input is selected but no microphone is connected, "No Mic" appears on the display.

### Mic/Line level display

The Mic/Line level display ② shows the input level.

When the transmitter's audio input level is excessively high, the Mic/Line level display ② shows full deflection.

In addition, the display panel is in backlit in red and the text "PEAK" flashes in alternation with the channel display (see page 19).

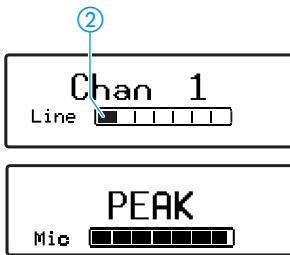

### Channel display

The channel display ③ provides information on the currently selected channel (see page 17).

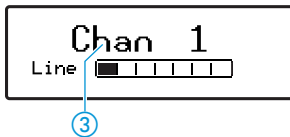

### Lock mode icon

The lock mode icon ④ appears when the lock mode is activated (see page 20).



# Putting the SR 2020 D into operation

## Preparing the transmitter for use

You can set up the SR 2020 D transmitter on an even surface or mount it into a 19" rack.

### Note:

Do not fit the rubber feet when rack mounting the transmitter.

### Setting up the transmitter on an even surface

To ensure that the transmitter cannot slip on the surface on which it is placed, four self-adhesive soft rubber feet are supplied.

#### CAUTION! Risk of staining of furniture surfaces!



Some furniture surfaces have been treated with varnish, polish or synthetics which might cause stains when they come into contact with other synthetics. Despite a thorough testing of the synthetics used by us, we cannot rule out the possibility of staining.

- ▶ Do not place the transmitter on delicate surfaces.

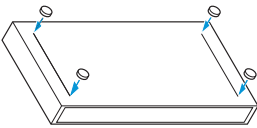

- ▶ Ensure that the base of the transmitter is clean and free from grease before mounting the rubber feet.
- ▶ Fix the rubber feet to the base of the transmitter by peeling of the safety paper and fitting them as shown in the diagram on the left.

### Connecting the antenna

- ▶ Connect the telescopic antenna to the antenna output 12 at the rear of the transmitter.

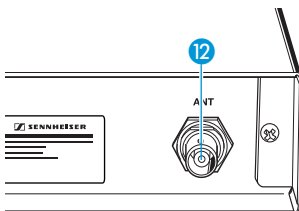

To obtain the best possible radiation power:

- ▶ Align the antenna vertically.

## Rack-mounting

### CAUTION! Risks when rack mounting the transmitter!



When installing the device in a closed or multi-rack assembly, please consider that, during operation, the ambient temperature, the mechanical loading and the electrical potentials will be different from those of devices which are not mounted into a rack:

- ▶ The ambient temperature within the rack must not exceed the temperature limit specified in the specifications.
- ▶ When installing the device in a rack, take good care not to affect the ventilation required for safe operation. If necessary, provide additional ventilation.
- ▶ Make sure the mechanical loading of the rack is even to avoid a hazardous condition such as a severely unbalanced rack.
- ▶ When connecting the device to the mains, observe the information indicated on the type plate. Avoid circuit overloading. If necessary, provide overcurrent protection.
- ▶ When installing the device in a closed or multi-rack assembly, please note that intrinsically harmless leakage currents of the individual mains units may accumulate, thereby exceeding the allowable limit value. As a remedy, ground the rack via an additional ground connection.

### Mounting the antennas to the front or rear of the rack

For the best possible radiation power, you should align the antennas vertically. If this is not possible, use one of the optional antenna mounts (see "Accessories and spare parts" on page 25):

You mount...	Antenna mount
... 1 transmitter	AM 2
... 2 transmitters	GA 3030 AM

When using several transmitters simultaneously, make sure that, in order to avoid interference, the distance between the antennas is sufficient. If necessary, use active transmitter combiners (see "Accessories and spare parts" on page 25):

You mount...	Active Transmitter Combiner
... 1 transmitter	AC 2
... 2 transmitters	AC 3200

### Mounting two SR 2020 D side by side

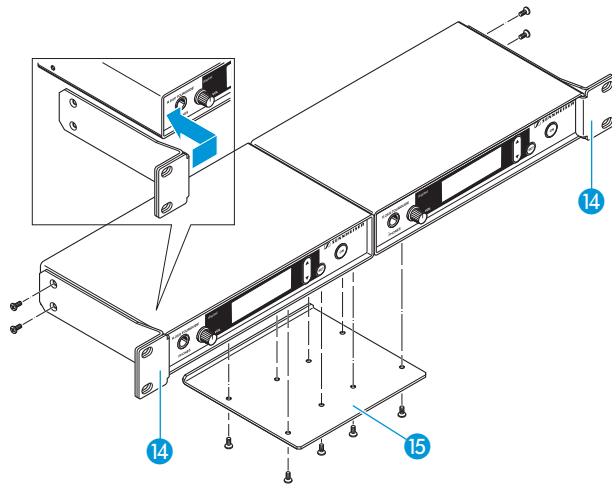

- ▶ Place the two transmitters side by side upside-down onto a flat surface.
- ▶ Align the jointing plate 15 over the holes in the bottom sides of the transmitters.
- ▶ Secure the jointing plate 15 to the transmitters using eight of the supplied recessed head screws (M 3x6).
- ▶ Hook the two rack mount "ears" 14 to the front panels of the transmitters.
- ▶ Secure the rack mount "ears" 14 to the transmitters using two of the supplied recessed head screws (M 3x6) respectively. If you wish to mount the antenna connections to the front of the rack, use the rack mount "ears" of the optional GA 3030 AM antenna mount .
- ▶ Slide the transmitters into the 19" rack.
- ▶ Secure the rack mount "ears" 14 to the rack.

**Mounting only one SR 2020 D** When mounting only one transmitter into the rack, use the blanking plate **13** instead of the second transmitter.

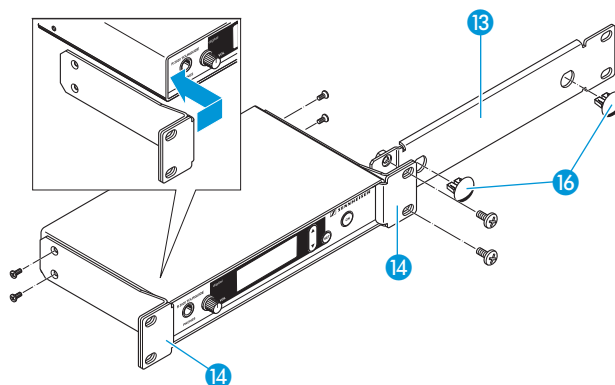

- ▶ Hook the two rack mount "ears" **14** to the front panel of the transmitter.
- ▶ Secure the rack mount "ears" **14** to the transmitter using two of the supplied recessed head screws (M 3x6) respectively.
- ▶ Secure the blanking plate **13** to one of the rack mount "ears" **14** using two of the supplied recessed head screws (M 6x10).
- ▶ If you are not front mounting the BNC output connector, insert the two blanking plugs **16** into the holes of the blanking plate.
- ▶ Slide the transmitter into the 19" rack.
- ▶ Secure the rack mount "ears" **14** to the rack.

## Connecting the transmitter to the mains

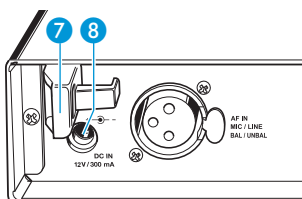

- ▶ Pass the cable through the cable grip **7**.
- ▶ Connect the cable of the mains unit to the DC IN socket **8** of the transmitter.
- ▶ Plug the mains connector into the wall socket.

## Connecting external devices

You can connect either a microphone (**Mic**) or an external audio source (**Line**, e.g. CD or MP3 player) to the transmitter.

To do so, use a suitable audio cable with a length of up to 3 m.

### Connecting an external audio source to the transmitter

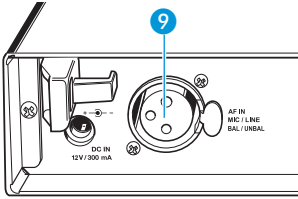

- ▶ Connect the line output of the external audio source to the XLR-3F socket 9 of the transmitter.

### Connecting a condenser microphone

The microphone input of the SR 2020 D transmitter is exclusively designed for use with condenser microphones. Suitable microphones are listed on page 6.

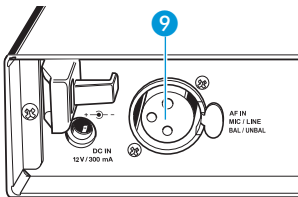

- ▶ Connect the condenser microphone to the XLR-3F socket 9 of the transmitter.

### Connecting the headphones

The Mic/Line level display 2 displays the strength of the input signal (see page 8). The SR 2020 D transmitter also features a headphone output for monitoring purposes.

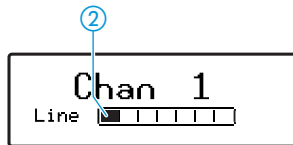

#### CAUTION! Danger of hearing damage!



Listening at high volume levels for long periods can lead to permanent hearing defects.

- ▶ Use the headphone volume control (VOL) 2 to set the volume for the connected headphones to the minimum before putting the headphones on.

To monitor the audio signal via headphones:

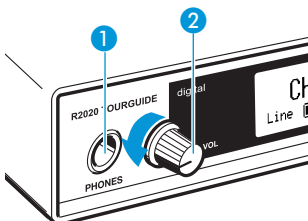

- ▶ Set the headphone volume control 2 to the lowest volume by turning it to the left as far as possible.
- ▶ Connect headphones with a 1/4" (6.3 mm) stereo jack plug to the headphone output 1.
- ▶ Put the headphones on.
- ▶ Gradually turn up the volume.

# Operating the SR 2020 D

## Switching the transmitter on/off

To switch the transmitter on:

- ▶ Press the **ON** button **6**.  
The display panel indicates the device name and then switches to the standard display.

To switch the transmitter off:

- ▶ Press the **ON** button **6** until “OFF” appears on the display.
- ▶ Release the **ON** button **6**.  
The display panel goes off and the transmitter switches off.

### Note:

The transmitter can only be switched off when the standard display is shown on the display panel. When in the operating menu, the **ON** button **6** serves as the ESC (cancel) key, i.e. you cancel your entry and return to the standard display.

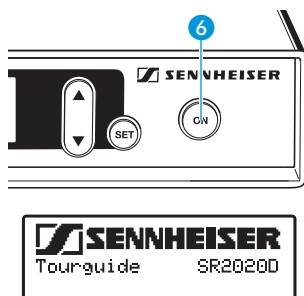

## Working with the operating menu

By way of example of the “**Chan. mode**” menu (**Channel mode**), this section describes how to use the operating menu.

For an overview of the operating menu, please see page 22.

- ▶ Make sure that the lock mode is deactivated (see page 20).

### Getting into the operating menu

To get from the standard display into the operating menu:

- ▶ Press the **SET** button **5**.  
The “**Channel**” menu is highlighted with a black bar.

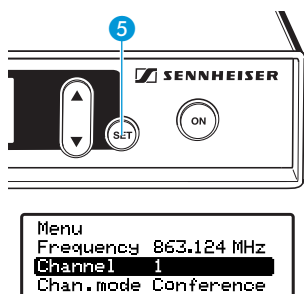



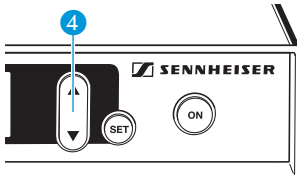

Menu  
Channel 1  
Chan. mode Conference  
Input Line

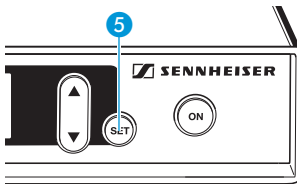

Conference  
Chan. mode Tourguide

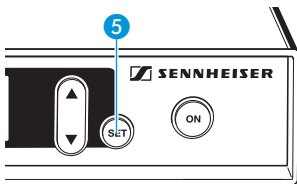

STORED

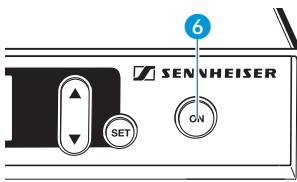

## Selecting a menu

- ▶ Use the ▲/▼ rocker button 4 to select the “Chan. mode” menu:

Rocker button	Display
Press ▲	jumps to the previous menu
Press ▼	jumps to the next menu
Keep ▲ or ▼ pressed	cycles continuously

- ▶ Press the SET button 5 to get into the setting mode of the “Chan. mode” menu.  
The current setting of the menu is displayed.

## Adjusting a setting in the setting mode

- ▶ Use the ▲/▼ rocker button 4 to jump between the settings, in this example between “Tourguide” and “Conference”.

## Storing a setting

- ▶ Press the SET button 5 to store the selected setting.  
“STORED” briefly appears on the display.

## Exiting a menu

- ▶ Press the ON button 6 to return to the operating menu.

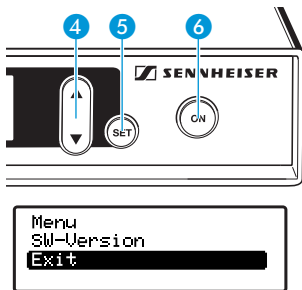

### Exiting the operating menu

- ▶ Use the ▲/▼ rocker button 4 to select the “Exit” menu and press the SET button 5. The standard display is shown on the display panel.

Or:

- ▶ Press the ON button 6 until the standard display is shown on the display panel.

### Selecting the menus

The transmitter’s operating menu contains the following menus:

Menu	Function of the menu
“Channel”	Selecting a channel (see page 17)
“Frequency”	Displaying the frequency of the current channel (see page 17)
“Chan. mode”	Selecting the channel mode (see page 18)
“Input”	Selecting the input signal (see page 19)
“Sensitiv”	Adjusting the input sensitivity (see page 19)
“Phantom”	Displaying the phantom power (see page 20)
“Contrast”	Adjusting the contrast (see page 20)
“Lock”	Activating/deactivating the lock mode (see page 20)
“Reset”	Loading the factory-preset default settings (see page 21)
“Version”	Displaying the current software version (see page 21)
“Exit”	Exiting the operating menu

## Setting a channel ("Channel")

To set a certain channel, proceed as follows:

1. Make sure that the transmitter and the receivers are set to the **same** channel mode ("Tourguide" or "Conference"), otherwise no connection can be established (see page 18).
2. Set the SR 2020 D transmitter to the desired channel (see next section).
3. Set one of the receivers to the same channel.
4. Automatically set all other receivers to the same channel using the channel copy function (for information on the channel copy function, please refer to the instruction manual of the Tourguide 2020 system).

To set the transmitter to the desired channel:

- ▶ Select the "Channel" menu.  
"Channel" appears on the display and the current channel is shown.
- ▶ Press the ▲/▼ rocker button ④ to change the channel.
- ▶ Press the SET button ⑤ to store the selected channel.

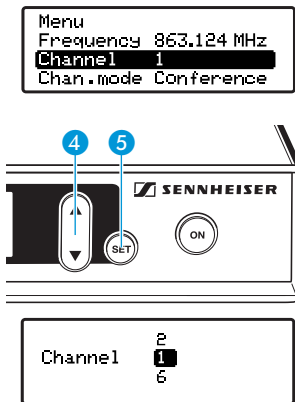

### Transmitting several languages simultaneously

In order to be able to transmit several languages simultaneously, you require one SR 2020 D transmitter and one or several receivers per language:

- ▶ Set the transmitter and the receivers assigned to certain language to the same channel.
- ▶ Do not use this channel for any other language.

### Displaying the frequency of the selected channel ("Frequency")

You can display the frequency of the selected channel. This function is useful, if you are using other Tourguide systems in the vicinity which interfere with your transmission (see previous section).

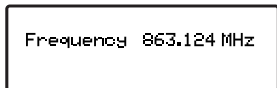
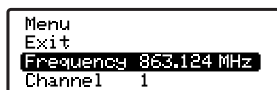

- ▶ Select the **“Frequency”** menu. **“Frequency”** appears on the display and the frequency of the current channel is shown.

### Changing the channel mode (‘‘Chan. mode’’)

You can choose between the two channel modes **“Conference”** and **“Tourguide”**. The two modes have been designed for different applications and differ from each other in the number of available channels:

Channel mode	Application	Number of channels
Conference	Simultaneous interpretations	8
Tourguide	Tourguide systems	6

To change the channel mode:

- ▶ Select the **“Chan. mode”** menu.
- ▶ Use the ▲/▼ rocker button **4** to change the channel mode (**“Tourguide”**/**“Conference”**).
- ▶ Press the **SET** button **5** to store the selected channel mode.

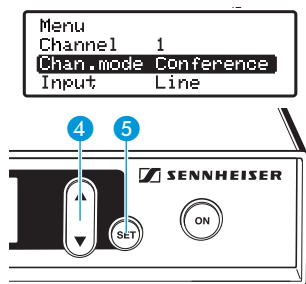

**Display of the channel mode**

The selected channel mode appears on the standard display as follows:

Display	Channel mode
	<b>“Tourguide”</b>
	<b>“Conference”</b>

### Selecting the input signal ("Input")

You can connect either a condenser microphone or any other audio source (e.g. CD and MP3 player, see page 6) to the transmitter.

To select the input signal:

- ▶ Select the "Input" menu.
- ▶ Press the **SET** button **5** to display the current setting (Mic/Line).

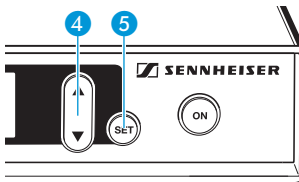
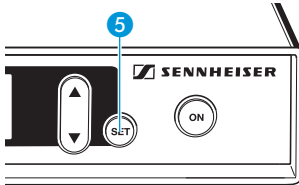
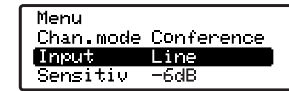

- ▶ Use the ▲/▼ rocker button **4** to select the desired input signal:

You connect ...	Select
a condenser microphone?	Mic
an external audio source?	Line

- ▶ Press the **SET** button **5** to store the selected input signal.

### Adjusting the sensitivity of the Mic/Line input ("Sensitiv")

If you connect a microphone to the transmitter, the microphone signal **has to be** amplified by the transmitter. Other audio sources **can be** amplified, if their audio signal is too low.

To adjust the input sensitivity:

- ▶ Select the "Sensitiv" menu.
- ▶ Use the ▲/▼ rocker button **4** to change the setting. The Mic/Line level display **2** should show full deflection during the loudest passages.

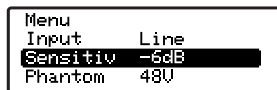

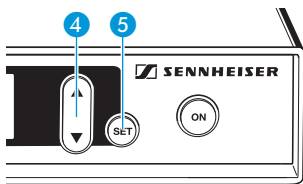

- ▶ Press the **SET** button **5** to store the input sensitivity of the Mic/Line input.

### Displaying the phantom power ("Phantom")

When you activate the transmitter's microphone input (see page 19), the phantom power is automatically available. The display show the value of the phantom power.

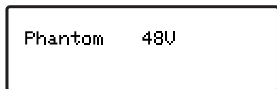

### Adjusting the contrast of the display ("Contrast")

To adjust the contrast of the display to the ambient light:

- ▶ Select the **"Contrast"** menu. **"Contrast"** appears on the display and the current setting is shown.
- ▶ Use the **▲/▼** rocker button **4** to change the setting.
- ▶ Press the **SET** button **5** to store the setting.

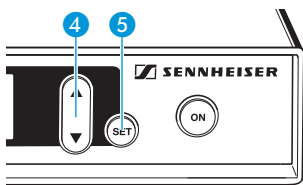

### Activating/deactivating the lock mode ("Lock")

The lock mode prevents that the transmitter is accidentally programmed or switched off during operation.

To **activate** the lock mode:

- ▶ Select the **"Lock"** menu.
- ▶ Select the setting **"Lock On"**.
- ▶ Press the **SET** button **5**.

The lock mode is activated and the lock mode icon appears on the standard display.

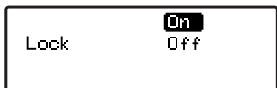

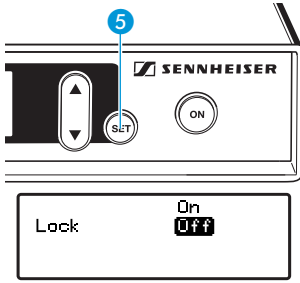

To **deactivate** the lock mode:

- ▶ Press the **SET** button **5**.
- ▶ “Lock On” appears on the display.
- ▶ Select the setting “Lock Off”.
- ▶ Press the **SET** button **5** to deactivate the lock mode. The lock mode icon disappears from the standard display.

Standard display	Lock mode is ...
Chan 1 	activated
Chan 1	deactivated

### Loading the factory-preset default settings (“Reset”)

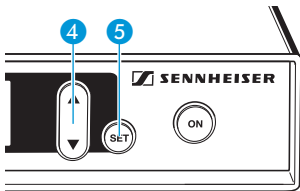
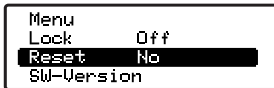

- ▶ Select the “Reset” menu. “Reset No” appears on the display.
- ▶ Press the **▲/▼** rocker button **4** until “Reset Yes” appears on the display.
- ▶ Press the **SET** button **5** to reset the device to the factory-preset default settings. “DONE” appears on the display. The transmitter is reset to the following factory-preset default settings:
  - Channel mode: Tourguide
  - Input signal: Line input
  - Channel: 1
  - Input sensitivities:
    - Line input: 0 dB
    - Microphone input: 0 dB
  - Lock mode: deactivated

### Displaying the version number of the software (“Version”)

#### Note:

This function is for servicing purposes only.

To display the version number:

- ▶ Select the “Version” menu. The version number appears on the display.

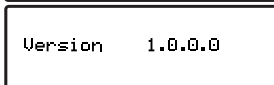
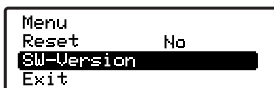

## Overview of the operating menu

Pressing the **ON** button **6** will cancel your entry in all menu modes.

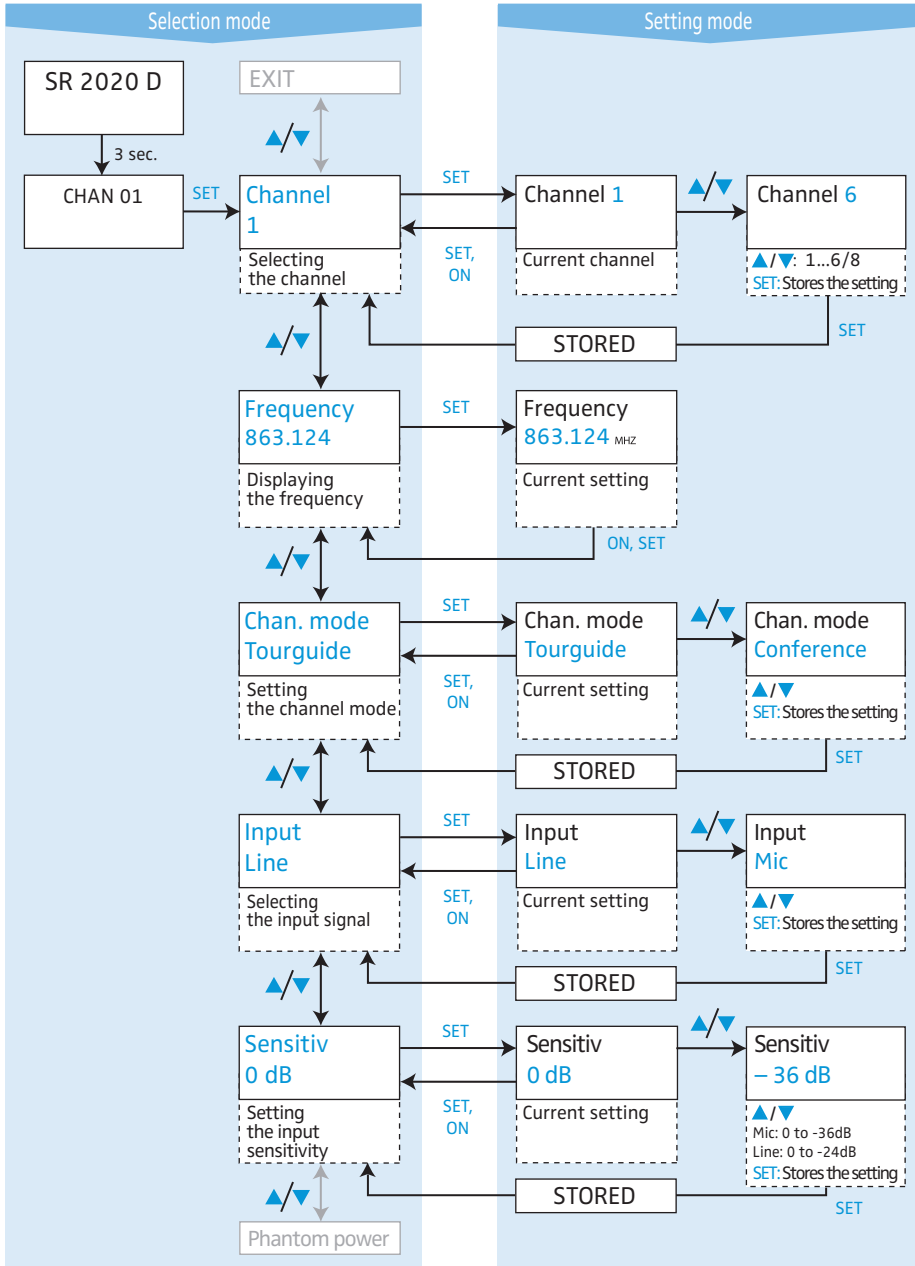



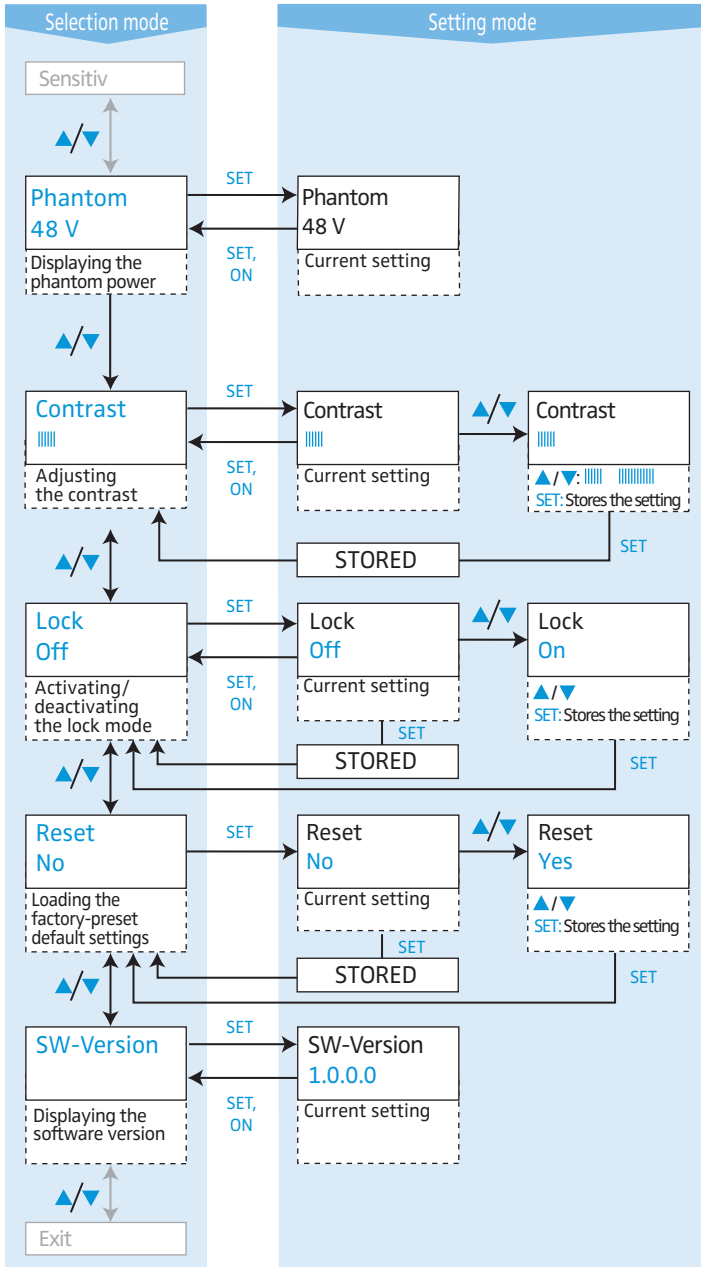

# Cleaning the SR 2020 D

**CAUTION!** Liquids can damage the electronics of the transmitter!



Liquids entering the housing of the device can cause a short-circuit and damage the electronics.

- ▶ Keep all liquids away from the device.
- ▶ Do not use any solvents or cleansing agents.

- ▶ Before cleaning, disconnect the device from the mains.
- ▶ Only use a soft and dry cloth to clean the device.

## If a problem occurs....

Problem	Possible cause	Possible remedy
No operation indication on the transmitter	No mains connection	Check the mains unit and the connection to the DC IN socket (see page 12)
Audio signal is distorted	Transmitter sensitivity is adjusted too high	Change the sensitivity of the microphone input or line input (see page 19)
		Select the source of the input signal (see page 19)
Occasional drop outs in the audio signal	Distance to the transmitter is too great	Reduce the distance to the transmitter
	Interference of unknown origin	Set the transmitter and receiver to a different channel (see page 17)
	Interference is being received from a second transmitter	Change the transmitters to different channels (see page 17)
No radio waves on the receiver display	Antenna is badly positioned	Improve the position of the transmitting antenna
		Mount the antenna to the front of the rack
	No RF signal: transmitter and receiver are not on the same channel	Set the transmitter and receiver to the same channel (see page 17)
	No RF signal: transmission range is exceeded	Reduce the distance between receiver and transmitter
Improve the position of the transmitting antenna		

If a problem occurs that is not listed in the above table or if the problem cannot be solved with the proposed solutions, please contact your local Sennheiser agent for assistance.

# Accessories and spare parts

Only use original Sennheiser accessories and spare parts. Components from other manufacturers may impair the quality of the devices and/or damage them.

<b>Cat. No.</b>	<b>Product name and description</b>
009823	GA 2 rack adapter
087244	NT 2-1-EU mains unit
087245	NT 2-1-UK mains unit
087246	NT 2-1-US mains unit
072817	Telescopic antenna
082875	Device feet (4 pieces)
500543	HDE 2020 D stethoset receiver
500544	HDE 2020 D-US stethoset receiver (US version)
004368	GA 3030-AM antenna mount (2 transmitters)
009912	AM 2 antenna mount for GA 2 rack adapter (1 transmitter)
009822	AC 2 active transmitter combiner for 4 transmitters
502048	AC 3200 active transmitter combiner for 8 transmitters

# Specifications

## SR 2020 D transmitter

Modulation	2 FSK
RF frequency range	863 – 865 MHz
RF frequency range (US)	926 – 928 MHz
Channels	6 for the Tourguide system, switchable to 8 for conferences
RF output power	10 mW (ERP)
RF output power (US)	max. 50 mV/m (distance 3 m)
AF frequency response	100 Hz–7 kHz
Input voltage range of the audio input	Microphone: $1.6 \text{ mV}_{\text{rms}} - 100 \text{ mV}_{\text{rms}}$ Line: $120 \text{ mV}_{\text{rms}} - 2 \text{ V}_{\text{rms}}$
Headphone output	$\frac{1}{4}$ " (6.3 mm) jack socket
Output power at headphone output	max. 100 mW at $32 \Omega$
Power supply	12 V DC (10.5 V–16 V)
Current consumption at nominal voltage	max. 300 mA
Ambient temperature	0 °C to 50 °C
Humidity	$\leq 95 \%$
Dimensions	approx. 212 x 145 x 38 mm
Weight	approx. 1100 g

## NT 2-1-EU/UK mains unit (Cat. No. 087244/087245)

Nominal input voltage	230V AC
Mains frequency	50 Hz/60 Hz
Max. power consumption	9 VA
Nominal output voltage	13V DC
Nominal output current	300 mA
Operating temperature range	0 °C to +40 °C

## NT 2-1-US mains unit (Cat. No. 087246)

Nominal input voltage	120V AC
Mains frequency	60 Hz
Max. power consumption	9 W
Nominal output voltage	13V DC
Nominal output current	300 mA
Operating temperature range	0°C to +40°C

The devices comply with the following European standards:

Radio: ETSI EN 301357-1/-2, Class 1 **CE 0682**  
EMC: ETSI EN 301489-1/-9, EN 55103-1/-2  
Safety: EN 60065, EN 61558

Frequency range 863 – 865 MHz, approved in: AT, BA, BE, CH, CY, CZ, DE, DK, EE, ES, FI, FR, GB, GR, HU, IE, IS, IT, LI, LT, LU, LV, ME, MK, MT, NL, NO, PL, PT, RO, RS, SE, SI, SK, TR, UA.

The SR 2020 D transmitter complies with the following US and Canadian standards:

USA: FCC-Part 15 C FCC ID: DMO SR 2020 D  
Canada: RSS-210 Issue 6 IC: 2099 A - SR 2020 D

## Manufacturer Declarations

### Warranty

Sennheiser GmbH & Co. KG gives a warranty of 24 months on this product. For the current warranty conditions, please visit our web site at [www.sennheiser.com](http://www.sennheiser.com) or contact your Sennheiser partner.

### CE Declaration of Conformity

**CE 0682**

This equipment is in compliance with the essential requirements and other relevant provisions of Directives 1999/5/EC and 2006/95/EC. The declaration is available on the internet site at [www.sennheiser.com](http://www.sennheiser.com).

Before putting the equipment into operation, please observe the respective country-specific regulations!

## Statements regarding FCC and industry Canada

This device complies with Part 15 of the FCC Rules and with RSS-210 of Industry Canada. Operation is subject to the following two conditions: (1) this device may not cause harmful interference, and (2) this device must accept any interference received, including interference that may cause undesired operation.

This equipment has been tested and found to comply with the limits for a Class B digital device, pursuant to Part 15 of the FCC Rules. These limits are designed to provide reasonable protection against harmful interference in a residential installation. This equipment generates, uses and can radiate radio frequency energy and, if not installed and used in accordance with the instructions, may cause harmful interference to radio communications. However, there is no guarantee that interference will not occur in a particular installation.

If this equipment does cause harmful interference to radio or television reception, which can be determined by turning the equipment off and on, the user is encouraged to try to correct the interference by one or more of the following measures:

- Reorient or relocate the receiving antenna.
- Increase the separation between the equipment and receiver.
- Connect the equipment into an outlet on a circuit different from that to which the receiver is connected.
- Consult the dealer or an experienced radio/TV technician for help.

This class B digital apparatus complies with the Canadian ICES-003.

Changes or modifications made to this equipment not expressly approved by Sennheiser electronic Corp. may void the FCC authorization to operate this equipment.

Before putting the device into operation, please observe the respective country-specific regulations!

# Index

## Areas of application

- Conferences 5
- Stationary guided tours 5

## Cleaning 24

## Connection

- of antennas 10
- of condenser microphones 13
- of external devices 12
- of headphones 13
- of microphones and external devices 6
- of the telescopic antenna 9
- to the mains 12

## If a problem occurs .... 24

## Indications and displays

- Channel display 8
- Lock mode icon 8
- Mic/Line level display 8
- Signal source 8

## Installation

- in a rack 10
- on an even surface 9

## Operating menu

- Activating/deactivating the lock mode 20
- Adjusting the contrast 20
- Adjusting the input sensitivity 19
- Changing the channel mode 18
- Changing the settings 15
- Displaying the frequency 17
- Displaying the phantom power 20
- Displaying the version number of the software 21
- Exiting the operating menu 16
- Getting into the operating menu 14
- Loading the factory-preset default settings 21
- Overview of the operating menu 22
- Selecting the input signal 19
- Setting a channel 17
- Storing the settings 15
- Working with the operating menu 14

## Suitable condenser microphones 6









Sennheiser electronic GmbH & Co. KG  
Am Labor 1, 30900 Wedemark, Germany

Phone: +49 (5130) 600 0  
Fax: +49 (5130) 600 300  
[www.sennheiser.com](http://www.sennheiser.com)

Printed in Germany  
Publ. 08/08  
524167/A02