

TEST REPORT

Test Report No.: 1-1910/21-01-17

BNetzA-CAB-02/21-102

Testing Laboratory

CTC advanced GmbH

Untertuerkheimer Strasse 6 – 10
66117 Saarbruecken/Germany
Phone: + 49 681 5 98 - 0
Fax: + 49 681 5 98 - 9075
Internet: <https://www.ctcadvanced.com>
e-mail: mail@ctcadvanced.com

Accredited Test Laboratory:

The testing laboratory (area of testing) is accredited according to DIN EN ISO/IEC 17025 (2018-03) by the Deutsche Akkreditierungsstelle GmbH (DAkkS). The accreditation is valid for the scope of testing procedures as stated in the accreditation certificate starting with the registration number: D-PL-12076-01.

Applicant

Sennheiser electronic GmbH & Co. KG

Am Labor 1
30900 Wedemark/GERMANY

Phone: +49 5130 600-0

Contact: Nils Knauer
e-mail: Nils.Knauer@sennheiser.com
Phone: +49 5130/600-9524

Manufacturer

Sennheiser electronic GmbH & Co. KG

Am Labor 1
30900 Wedemark/GERMANY

Test Standards

IEC/IEEE
62209-1528-2020

Measurement procedure for the assessment of specific absorption rate of human exposure to radio frequency fields from hand-held and body-mounted wireless communication devices – Part 1528: Human models, instrumentation, and procedures (Frequency range of 4 MHz to 10 GHz)
Radio Frequency Exposure Compliance of Radiocommunication Apparatus (All Frequency Bands)

RSS-102 Issue 5

For further applied test standards please refer to section 3 of this test report.

Test Item

Kind of test item:	Plug-On Transmitter
Device type:	portable device
Model name:	EW-DP SKP
S/N serial number:	see technical details
FCC-ID:	DMOSKPEWDP
ISED Number:	2099A-SKPEWDP
Product Marketing Name (PMN):	EW-DP SKP
Hardware Version Identification No. (HVIN):	EW-DP SKP
HMN:	-/-
FVIN	1.5.0.
Hardware status:	589600_06
Software status:	1.5.0
Frequency:	see technical details
Antenna:	internal antenna
Power supply:	3.80 V DC by battery Li-Ion BA 70 or 2x AA type 1.50 V DC
Accessories:	--
Test sample status:	identical prototype
Exposure category:	general population / uncontrolled environment

This test report is electronically signed and valid without handwritten signature. For verification of the electronic signatures, the public keys can be requested at the testing laboratory.

Test Report authorised:



Alexander Hnatovskiy
Lab Manager
Radio Labs

Test performed:



Marco Scigliano
Testing Manager
Radio Labs

1	Table of contents	
1	Table of contents	2
2	General information	3
2.1	Notes and disclaimer	3
2.2	Application details	3
2.3	Statement of compliance	3
2.4	Technical details	4
2.5	Transmitter and Antenna Operating Configurations	4
3	Test standards/ procedures references	5
3.1	RF exposure limits	6
4	Reporting statements of conformity – decision rule	7
5	Summary of Measurement Results	7
6	Test Environment	8
7	Test Set-up	9
7.1	Measurement system	9
7.1.1	System Description	9
7.1.2	Test environment	10
7.1.3	Probe description	10
7.1.4	Phantom description	11
7.1.5	Device holder description	12
7.1.6	Scanning procedure	13
7.1.7	Comparison of DASY 52 NEO and cDASY6/DASY8	17
7.1.8	Spatial Peak SAR Evaluation	18
7.1.9	Data Storage and Evaluation	21
7.1.10	Tissue simulating liquids: dielectric properties	23
7.1.11	Tissue simulating liquids: parameters	23
7.1.12	Measurement uncertainty evaluation for SAR test	25
7.1.13	Measurement uncertainty evaluation for System Check	27
7.1.14	System check	28
7.1.15	System check procedure	29
7.1.16	System validation	30
8	Detailed Test Results	30
8.1	Conducted power measurements UHF	30
8.2	Conducted power measurements Bluetooth LE 2.4 GHz	31
8.3	SAR test results	31
8.3.1	General description of test procedures	31
8.3.2	Results overview	32
8.3.3	Multiple Transmitter Information	35
8.3.4	SAR correction for deviations of complex permittivity from targets	36
9	Test equipment and ancillaries used for tests	37
10	Observations	37
Annex A:	System performance check	38
Annex B:	DASY measurement results	45
Annex B.1:	Liquid depth	54
Annex C:	Photo documentation	55
Annex D:	Calibration parameters	55
Annex E:	RSS-102 Annex A1	55
Annex F:	Document History	56

2 General information

2.1 Notes and disclaimer

The test results of this test report relate exclusively to the test item specified in this test report. CTC advanced GmbH does not assume responsibility for any conclusions and generalisations drawn from the test results with regard to other specimens or samples of the type of the equipment represented by the test item. The test report may only be reproduced or published in full. Reproduction or publication of extracts from the report requires the prior written approval of CTC advanced GmbH.

This test report is electronically signed and valid without handwriting signature. For verification of the electronic signatures, the public keys can be requested at the testing laboratory.

The testing service provided by CTC advanced GmbH has been rendered under the current "General Terms and Conditions for CTC advanced GmbH".

CTC advanced GmbH will not be liable for any loss or damage resulting from false, inaccurate, inappropriate or incomplete product information provided by the customer.

Under no circumstances does the CTC advanced GmbH test report include any endorsement or warranty regarding the functionality, quality or performance of any other product or service provided.

Under no circumstances does the CTC advanced GmbH test report include or imply any product or service warranties from CTC advanced GmbH, including, without limitation, any implied warranties of merchantability, fitness for purpose, or non-infringement, all of which are expressly disclaimed by CTC advanced GmbH.





All rights and remedies regarding vendor's products and services for which CTC advanced GmbH has prepared this test report shall be provided by the party offering such products or services and not by CTC advanced GmbH. In no case this test report can be considered as a Letter of Approval.

2.2 Application details

Date of receipt of order:	2022-11-08
Date of receipt of test item:	2023-04-10
Start of test:	2023-04-27
End of test:	2023-05-05

2.3 Statement of compliance

The SAR values found for the EW-DP SKP Plug-On Transmitter are below the maximum recommended levels of 1.6 W/Kg as averaged over any 1 g tissue according to the FCC rule §2.1093, the ANSI/IEEE C 95.1:1992, the NCRP Report Number 86 for uncontrolled environment, according to the Health Canada's Safety Code 6 and the Industry Canada Radio Standards Specification RSS-102 for General Population/Uncontrolled exposure.

Accreditation	Description	
D-PL-12076-01-01	SAR / EMF – EN and FCC https://www.dakks.de/files/data/as/pdf/D-PL-12076-01-01.pdf	 
D-PL-12076-01-04	Telecommunication and EMC Canada https://www.dakks.de/files/data/as/pdf/D-PL-12076-01-04e.pdf https://www.dakks.de/as/ast/d/D-PL-12076-01-04e.pdf	 

2.4 Technical details

Technologies:	Conducted Sample	Radiated Sample
UHF Q1-6 470.2 to 526.0 MHz	1123000128	1123000123
UHF R1-6 520.0 to 576.0 MHz	1123000031	1123000023
UHF R4-9 552.0 to 607.0 MHz	1123000034	1123000033
UHF S1-7 606.2 to 662.0 MHz	1123000030	1123000029
UHF S4-7 630.0 to 662.0 MHz	1123000029	1123000029
UHF S7-10 662.0 to 693.0 MHz	1123000036	1123000031
UHF U1/5 823.2 to 864 MHz	1123000039	1123000039
UHF Y1-3 1785.2 to 1799.7 MHz	1123000059	1123000059
BT LE 2450 MHz	1342000139	1123000127

2.5 Transmitter and Antenna Operating Configurations

Collocation of one UHF band and BT LE is possible.

Simultaneous transmission conditions
UHF (Q/R/S/U/Y) + BT LE

3 Test standards/ procedures references

Test Standard	Version	Test Standard Description
RSS-102 Issue 5	2015-03	Radio Frequency Exposure Compliance of Radiocommunication Apparatus (All Frequency Bands)
RSS-102 Supplementary Procedures SPR-001	2011-01	SAR testing requirements with regard to bystanders for Lap Top Type Computers with antennas built-in on display screen (Laptop Mode / Tablet Mode)
RSS-102 Supplementary Procedures SPR-002	2022-10	SPR-002 — Supplementary Procedure for Assessing Compliance of Equipment Operating from 3 kHz to 10 MHz with RSS-102
Canada's Safety Code No. 6	2015-06	Limits of Human Exposure to Radiofrequency Electromagnetic Fields in the Frequency Range from 3 kHz to 300 GHz
IEEE Std. C95-3	2002	IEEE Recommended Practice for the Measurement of Potentially Hazardous Electromagnetic Fields – RF and Microwave
IEC/IEEE 62209-1528- 2020	2020-10- 19	Measurement procedure for the assessment of specific absorption rate of human exposure to radio frequency fields from hand-held and body-mounted wireless communication devices – Part 1528: Human models, instrumentation, and procedures (Frequency range of 4 MHz to 10 GHz)
FCC KDBs:		
KDB 865664D01v01	August 7, 2015	FCC OET SAR measurement requirements 100 MHz to 6 GHz
KDB 865664D02v01	October 23, 2015	RF Exposure Compliance Reporting and Documentation Considerations
KDB 447498D01v06	October 23, 2015	Mobile and Portable Devices RF Exposure Procedures and Equipment Authorization Policies
KDB 648474D04v01	October 23, 2015	SAR Evaluation Considerations for Wireless Handsets

3.1 RF exposure limits

RF Exposure levels according to IEEE Std. C95-1 (2005):

Human Exposure	Uncontrolled Environment General Population	Controlled Environment Occupational
Spatial Peak SAR* (Brain and Trunk)	1.60 W/kg	8.00 W/kg
Spatial Average SAR** (Whole Body)	0.08 W/kg	0.40 W/kg
Spatial Peak SAR*** (Hands/Feet/Ankle/Wrist)	4.00 W/kg	20.00 W/kg

Table 1: RF exposure limits

The limit applied in this test report is shown in bold letters

Notes:

- * The Spatial Peak value of the SAR averaged over any 1 gram of tissue (defined as a tissue volume in the shape of a cube) and over the appropriate averaging time
- ** The Spatial Average value of the SAR averaged over the whole body.
- *** The Spatial Peak value of the SAR averaged over any 10 grams of tissue (defined as a tissue volume in the shape of a cube) and over the appropriate averaging time.

Uncontrolled Environments are defined as locations where there is the exposure of individuals who have no knowledge or control of their exposure.

Controlled Environments are defined as locations where there is exposure that may be incurred by persons who are aware of the potential for exposure, (i.e. as a result of employment or occupation).

4 Reporting statements of conformity – decision rule

Only the measured values related to their corresponding limits will be used to decide whether the equipment under test meets the requirements of the test standards listed in chapter 3. The measurement uncertainty is mentioned in this test report, see chapter 9, but is not taken into account - neither to the limits nor to the measurement results. Measurement results with a smaller margin to the corresponding limits than the measurement uncertainty have a potential risk of more than 20% that the decision might be wrong."

measured value, measurement uncertainty, verdict

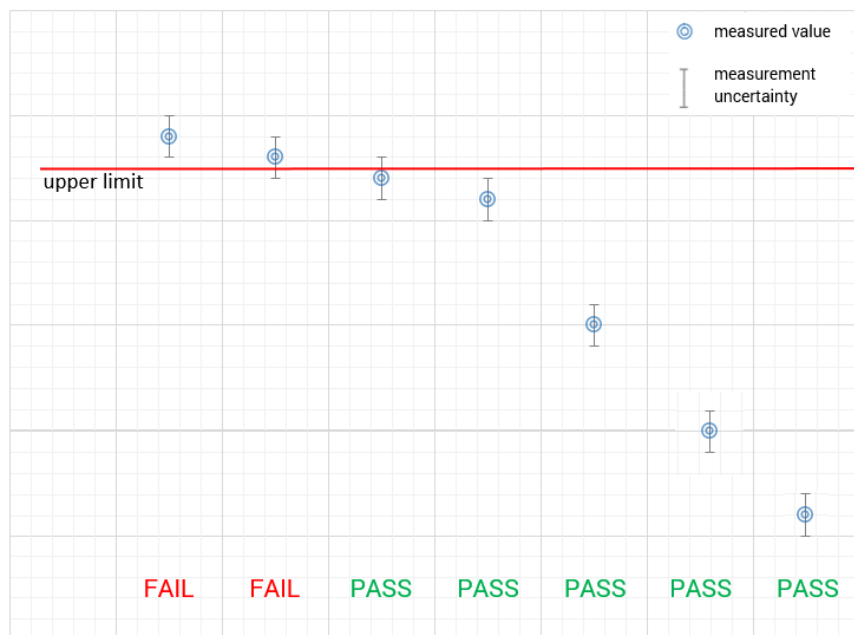

5 Summary of Measurement Results

<input checked="" type="checkbox"/>	No deviations from the technical specifications ascertained	
<input type="checkbox"/>	Deviations from the technical specifications ascertained	
Maximum SAR value (W/kg)		
	reported	limit
body worn 0 mm distance for 1g	0.144	1.6
collocated situations ΣSAR evaluation	0.250	1.6

6 Test Environment

Ambient temperature:	20 – 24 °C
Tissue Simulating liquid:	20 – 24 °C
Relative humidity content:	40 – 50 %
Air pressure:	not relevant for this kind of testing
Power supply:	230 V / 50 Hz

NOTE: For the SAR measurements the exact temperature values for each test are shown in the SAR result tables and are also at the bottom of each measurement plot.

7 Test Set-up

7.1 Measurement system

7.1.1 System Description

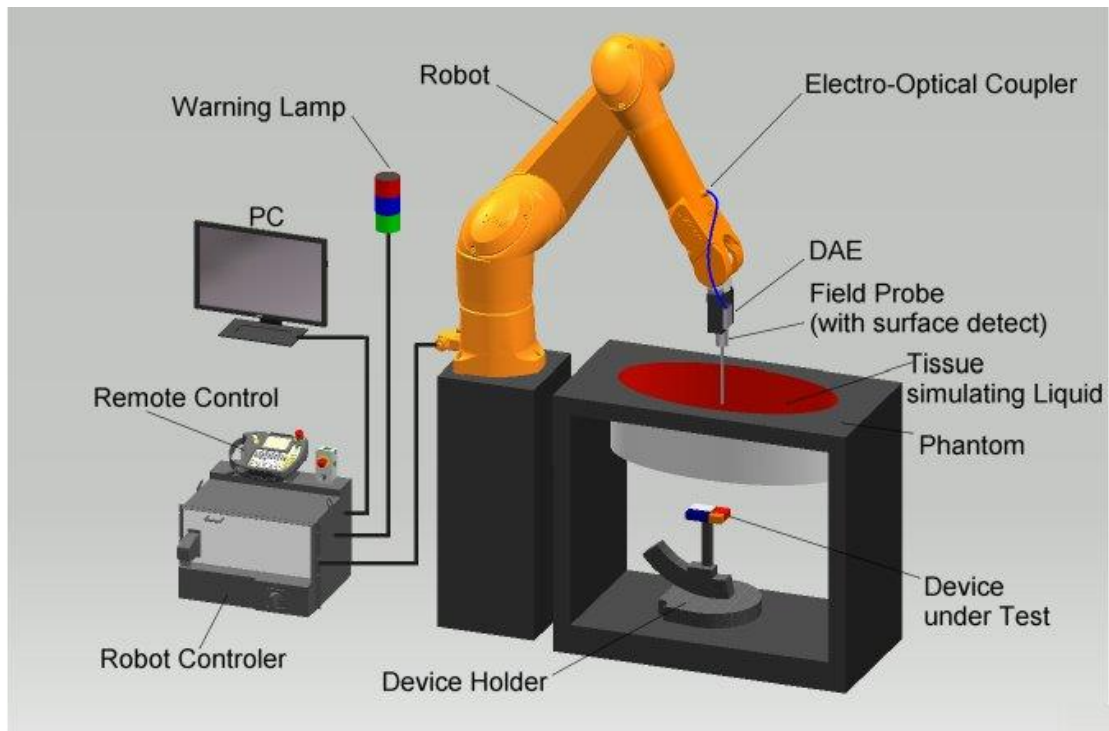

- The DASYS system for performing compliance tests consists of the following items:
- A standard high precision 6-axis robot (Stäubli RX/TX family) with controller and software. An arm extension for accommodating the data acquisition electronics (DAE).
- A dosimetric probe, i.e. an isotropic E-field probe optimized and calibrated for usage in tissue simulating liquid.
- A data acquisition electronic (DAE) which performs the signal amplification, signal multiplexing, AD-conversion, offset measurements, mechanical surface detection, collision detection, etc. The unit is battery powered with standard or rechargeable batteries. The signal is optically transmitted to the EOC.
- The Electro-Optical Coupler (EOC) performs the conversion from the optical into a digital electric signal of the DAE. The EOC is connected to the DASYS measurement server.
- The DASYS measurement server, which performs all real-time data evaluation for field measurements and surface detection, controls robot movements and handles safety operation. A computer operating Windows.
- DASYS software and SEMCAD data evaluation software.
- Remote control with teach panel and additional circuitry for robot safety such as warning lamps, etc.
- The generic twin phantom enabling the testing of left-hand and right-hand usage.
- The triple flat and eli phantom for the testing of handheld and body-mounted wireless devices.
- The device holder for handheld mobile phones and mounting device adaptor for laptops
- Tissue simulating liquid mixed according to the given recipes.
- System check dipoles allowing to validate the proper functioning of the system.

7.1.2 Test environment

The DASY measurement system is placed in a laboratory room within an environment which avoids influence on SAR measurements by ambient electromagnetic fields and any reflection from the environment. The pictures at the beginning of the photo documentation show a complete view of the test environment. The system allows the measurement of SAR values larger than 0.005 mW/g.

7.1.3 Probe description

Isotropic E-Field Probe EX3DV4 for Dosimetric Measurements	
Technical data according to manufacturer information	
Construction	Symmetrical design with triangular core Interleaved sensors Built-in shielding against static charges PEEK enclosure material (resistant to organic solvents, e.g., DGBE)
Calibration	ISO/IEC 17025 calibration service available.
Frequency	10 MHz to >6 GHz (dosimetry); Linearity: ± 0.2 dB (30 MHz to 6 GHz)
Directivity	± 0.3 dB in HSL (rotation around probe axis) ± 0.5 dB in tissue material (rotation normal to probe axis)
Dynamic range	10 μ W/g to > 100 mW/g; Linearity: ± 0.2 dB (noise: typically <1 μ W/g)
Dimensions	Overall length: 337 mm (Tip: 20mm) Tip length: 2.5 mm (Body: 12mm) Typical distance from probe tip to dipole centers: 1mm
Application	High precision dosimetric measurements in any exposure scenario (e.g., very strong gradient fields). Only probe which enables compliance testing for frequencies up to 6 GHz with precision of better 30%.

7.1.4 Phantom description

The used SAM Phantom meets the requirements specified in FCC KDB865664 D01 for Specific Absorption Rate (SAR) measurements.

The phantom consists of a fibreglass shell integrated in a wooden table. It allows left-hand and right-hand head as well as body-worn measurements with a maximum liquid depth of 18 cm in head position and 22 cm in planar position (body measurements). The thickness of the Phantom shell is 2 mm +/- 0.1 mm.

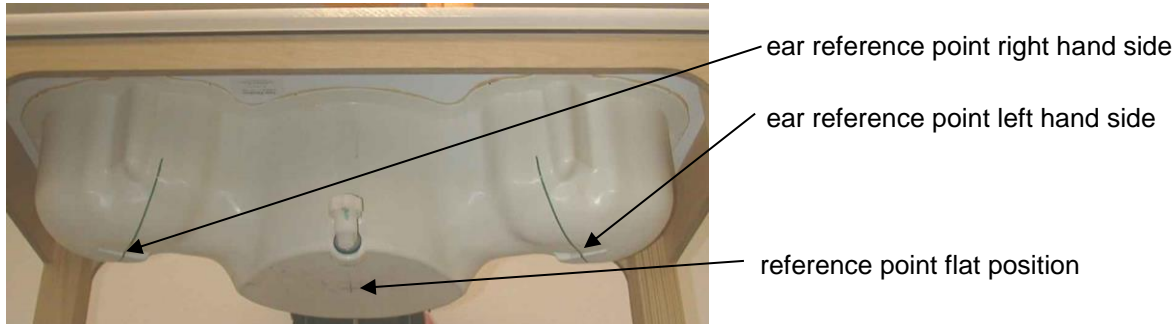

Triple Modular Phantom consists of three identical modules which can be installed and removed separately without emptying the liquid. It includes three reference points for phantom installation. Covers prevent evaporation of the liquid. Phantom material is resistant to DGBE based tissue simulating liquids.

The used ELI4 Phantom meets the requirements specified in KDB865664 D01 for Specific Absorption Rate (SAR) measurements. The phantom consists of a fibreglass shell integrated in a wooden table.



The ELI4 phantom is intended for compliance testing of handheld and body-mounted wireless devices in the frequency range of 30MHz to 6 GHz. ELI4 is fully compatible with the standard IEC 62209-2 and all known tissue simulating liquids.

7.1.5 Device holder description

The DASY device holder has two scales for device rotation (with respect to the body axis) and the device inclination (with respect to the line between the ear openings). The plane between the ear openings and the mouth tip has a rotation angle of 65°. The bottom plate contains three pair of bolts for locking the device holder. The device holder positions are adjusted to the standard measurement positions in the three sections. This device holder is used for standard mobile phones or PDA's only. If necessary an additional support of polystyrene material is used.



Larger DUT's (e.g. notebooks) cannot be tested using this device holder. Instead a support of bigger polystyrene cubes and thin polystyrene plates is used to position the DUT in all relevant positions to find and measure spots with maximum SAR values.

Therefore those devices are normally only tested at the flat part of the SAM.

7.1.6 Scanning procedure

- The DASY installation includes predefined files with recommended procedures for measurements and system check. They are read-only document files and destined as fully defined but unmeasured masks. All test positions (head or body-worn) are tested with the same configuration of test steps differing only in the grid definition for the different test positions.
- The „reference“ and „drift“ measurements are located at the beginning and end of the batch process. They measure the field drift at one single point in the liquid over the complete procedure. The indicated drift is mainly the variation of the DUT's output power and should vary max. +/- 5 %.
- The highest integrated SAR value is the main concern in compliance test applications. These values can mostly be found at the inner surface of the phantom and cannot be measured directly due to the sensor offset in the probe. To extrapolate the surface values, the measurement distances to the surface must be known accurately. A distance error of 0.5mm could produce SAR errors of 6% at 1800 MHz. Measurements can be performed in a fixed plane or by following an arbitrary surface.
- For an automatic and accurate detection of the phantom surface, the DASY system uses Mechanical Surface Detection:

Mechanical Surface Detection

Mechanical surface detection uses the probe collision detector built into the DAE. It is extremely accurate if the probe is normal to the surface (0.05 mm). For angled probes, the distance increases, because the detection is at the edge of the probe tip. It can be used in any liquid with any kind of probe. If the surface is strongly angled with respect to the probe, the probe slides along the surface and is deflected sideways. The second switch system in the DAE will detect this situation and the probe will move backward until the touch condition is cleared. However, there will be some remaining uncertainty in the final probe position. In the job description, the desired distance from the probe sensors to the phantom surface can be entered. The detection is always at touch, but the probe will move backward from the surface the indicated distance before starting the measurement.

Mother Scan in cDASY6/DASY8 Module SAR

While the DASY5 V5.2 SAR system uses the mechanical surface detection at each point of the Area Scan / Zoom Scan, the cDASY6/DASY8 Module SAR provides the possibility to do a Mother Scan in which a high resolution Area Scan is done in the phantom filled with liquid to a fixed level using a special teaching probe. This mother scan data is used to recreate the phantom inner surface in software, and all future area and/or zoom scans, and a surface detection check is no longer required.

- The „area scan“ measures the SAR above the DUT or verification dipole on a parallel plane to the surface. It is used to locate the approximate location of the peak SAR with 2D spline interpolation. The robot performs a stepped movement along one grid axis while the local electrical field strength is measured by the probe. The probe is touching the surface of the SAM during acquisition of measurement values. The scan uses different grid spacings for different frequency measurements. Standard grid spacing for head measurements in frequency ranges ≤ 2 GHz is 15 mm in x- and y- dimension. For higher frequencies a finer resolution is needed, thus for the grid spacing is reduced according the following table:

Area scan grid spacing for different frequency ranges	
Frequency range	Grid spacing
≤ 2 GHz	≤ 15 mm
2 – 4 GHz	≤ 12 mm
4 – 6 GHz	≤ 10 mm

Grid spacing and orientation have no influence on the SAR result. For special applications where the standard scan method does not find the peak SAR within the grid, e.g. mobile phones with flip cover, the grid can be adapted in orientation. Results of this coarse scan are shown in annex B.

- A „zoom scan“ measures the field in a volume around the 2D peak SAR value acquired in the previous „coarse“ scan. It uses a fine meshed grid where the robot moves the probe in steps along all the 3 axis (x, y and z-axis) starting at the bottom of the Phantom. The grid spacing for the cube measurement is varied according to the measured frequency range, the dimensions are given in the following table:

Zoom scan grid spacing and volume for different frequency ranges			
Frequency range	Grid spacing for x, y axis	Grid spacing for z axis	Minimum zoom scan volume
≤ 2 GHz	≤ 8 mm	≤ 5 mm	≥ 30 mm
2 – 3 GHz	≤ 5 mm*	≤ 5 mm	≥ 28 mm
3 – 4 GHz	≤ 5 mm*	≤ 4 mm	≥ 28 mm
4 – 5 GHz	≤ 4 mm*	≤ 3 mm	≥ 25 mm
5 – 6 GHz	≤ 4 mm*	≤ 2 mm	≥ 22 mm

* When zoom scan is required and the reported SAR from the area scan based 1-g SAR estimation procedures of KDB Publication 447498 is ≤ 1.4 W/kg, ≤ 8 mm, ≤ 7 mm and ≤ 5 mm zoom scan resolution may be applied, respectively, for 2 GHz to 3 GHz, 3 GHz to 4 GHz and 4 GHz to 6 GHz.

- DASY provides an auto-extending feature to expand the size of the measurement area of the zoom scan as long as the maximum is found too close to the edge of the measured range, which eliminates the need to re-measure cubes whose maximum is found on the boundary of the defined measurement cube.
- To meet the requirements of **IEC 62209-2 AMD1 from 2019** it is necessary to perform graded grid measurements to avoid measurement mistakes.

Below 3 GHz it defines:

Horizontal grid step ≤ 8 mm

Vertical grid step ≤ 5 mm for uniform spacing

For variable spacing in vertical direction the maximum distance between the two closest measured points to the phantom shell (M1 and M2) shall be ≤ 4 mm and the spacing between farther points shall increase by a factor ≤ 1.5 . Zoom Scan size ≤ 30 mm by 30 mm by 30 mm.

Above 3 GHz it defines:

Horizontal grid step $\leq (24/f [\text{GHz}])$ mm

Vertical grid step $\leq (10/(f [\text{GHz}] - 1))$ mm for uniform spacing

For variable spacing in vertical direction the maximum distance between the two closest measured points to the phantom shell (M1 and M2) shall be $\leq (12/f [\text{GHz}])$ mm and the spacing between farther points shall increase by a factor ≤ 1.5 . Zoom Scan size ≤ 22 mm by 22 mm by 22 mm.

If the zoom scan measured as defined above complies with both of the following criteria, or if the peak spatial-average SAR is below 0.1 W/kg, no additional measurements are needed:

- 1) the smallest horizontal distance from the local SAR peaks to all points 3 dB below the SAR peak shall be larger than the horizontal grid steps in both x and y directions (Δx , Δy). This shall be checked for the measured zoom scan plane conformal to the phantom at the distance z_{M1} . The minimum distance shall be recorded in the SAR test report;
- 2) the ratio of the SAR at the second measured point (M2) to the SAR at the closest measured point (M1) at the x-y location of the measured maximum SAR value shall be at least 30 %. This ratio (in %) shall be recorded in the SAR test report.

If one or both of the above criteria are not met, the zoom scan measurement shall be repeated using a finer resolution while keeping the other zoom scan parameters compatible with the basic requirements for zoom scans.

New horizontal and vertical grid steps shall be determined from the measured SAR distribution so that the above criteria are met. Compliance with the above two criteria shall be demonstrated for the new measured zoom scan. The size of the higher resolution zoom scan and all other parameters shall apply. The closest point to the phantom shell shall be 2 mm or less for graded grids and the grading factor shall be 1.5 or less. Uncertainties due to field distortion between the media boundary and the dielectric enclosure of the probe should also be minimized, which is achieved if the distance between the phantom surface and physical tip of the probe is larger than the probe tip diameter. Other methods may utilize correction procedures to compensate for boundary effects that enable high precision measurements closer than half the probe tip diameter. For all measurement points, the angle of the probe normal to the flat phantom surface shall be less than 5°. If this cannot be achieved, an additional uncertainty evaluation is required.

Orientation of the probe with respect to the line normal to the phantom surface, shown at two different locations:

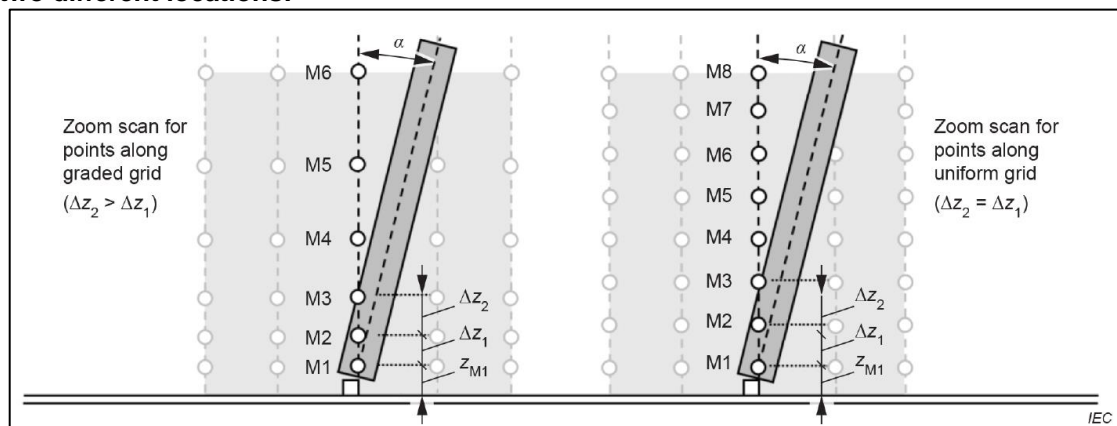

NOTE M1 to M8 are example measurement points used for extrapolation to the surface. The maximum of the angle α between the evaluation axis and the surface normal line is called the probe angle. The distance z_{M1} is from the phantom shell to the first measurement point M1, and its maximum value is 1.4mm fixed for the DASY system equipped with an EX-Probe. The distances $\Delta z_i (i = 1, 2, 3, \dots)$ are the distances from measurement points M_i to M_{i-1} . For uniform grids, Δz_i are equal. For graded grids, $\Delta z_{i+1} > \Delta z_i$. $R_z = \Delta z_{i+1}/\Delta z_i$ is a ratio with a maximum value (defined in the table below). The z direction corresponds to the vertical direction, the x direction is horizontal and the y direction is horizontal into the page.

NOTE 1: The evaluation of the zoom scan is typically done by the post-processor by interpolation and extrapolation and without reconstruction of the field. More focused induced SAR distributions (e.g., for more localized sources such as capacitively coupled sources) require a more dense grid such that the same integration and extrapolation algorithms can be used for the same assessment uncertainty.

NOTE 2: The minimum ratio of 30 % is derived from the plane wave penetration depth at 6 GHz.

Detailed parameters can be seen in the following table:

Table 8 – Zoom scan parameters

Parameter	DUT transmit frequency being tested	
	$f \leq 3$ GHz	3 GHz $< f \leq 6$ GHz
Maximum distance between the closest measured points and the phantom surface (z_{M1} in Figure 14 and Table 2, in mm)	5	$\delta \ln(2)/2^a$
Maximum angle between the probe axis and the flat phantom surface normal (α in Figure 14)	5°	5°
Maximum spacing between measured points in the x- and y-directions (Δx and Δy , in mm)	8	$24/f^{b,c}$
For uniform grids: Maximum spacing between measured points in the direction normal to the phantom shell (Δz_1 in Figure 14, in mm)	5	$10/(f - 1)$
For graded grids: Maximum spacing between the two closest measured points in the direction normal to the phantom shell (Δz_1 in Figure 14, in mm)	4	$12/f$
For graded grids: Maximum incremental increase in the spacing between measured points in the direction normal to the phantom shell ($R_z = \Delta z_2/\Delta z_1$ in Figure 14)	1,5	1,5
Minimum edge length of the zoom scan volume in the x- and y-directions (L_z in 7.2.5.3, in mm)	30	22
Minimum edge length of the zoom scan volume in the direction normal to the phantom shell (L_h in 7.2.5.3, in mm)	30	22
Tolerance in the probe angle	1°	1°

^a δ is the penetration depth for a plane-wave incident normally on a planar half-space.
^b This is the maximum spacing allowed, which may not work for all circumstances.
^c f is the frequency in GHz.

Table M.1 – Minimum probe requirements as a function of frequency and parameters of the tissue equivalent liquid

1	2	3	4	5	6	7	8
Frequency MHz	Relative permittivity	Conductivity S/m	Wavelength in the medium (λ) mm	Plane wave Skin Depth (δ) mm	Maximum Diameter mm	50 % Distance for M1 ($z_{50\%} = \delta \ln(2)/2$) mm	Min. distance for M1 (z_{M1}) mm
300	45,3	0,87	148,6	46,1	8,0	16,0	5,0
450	43,5	0,87	101,1	42,9	8,0	14,9	5,0
750	41,9	0,89	61,8	39,8	8,0	13,8	5,0
835	41,5	0,9	55,8	38,9	8,0	13,5	5,0
900	41,5	0,97	51,7	36,1	8,0	12,5	5,0
1 450	40,5	1,20	32,5	28,6	8,0	9,9	5,0
1 800	40,0	1,40	26,4	24,3	8,0	8,4	5,0
2 000	40,0	1,40	23,7	24,2	8,0	8,4	5,0
2 450	39,2	1,80	19,6	18,7	6,5	6,5	5,0
2 600	39,0	1,96	18,5	17,2	6,2	5,9	5,0
3 000	38,5	2,40	16,1	13,9	5,4	4,8	5,0
4 000	37,4	3,43	12,3	9,6	4,1	3,3	3,3
5 000	36,2	4,45	10,0	7,3	3,3	2,5	2,5
5 200	36,0	4,66	9,6	7,0	3,2	2,4	2,4
5 400	35,8	4,86	9,3	6,7	3,1	2,3	2,3
5 600	35,5	5,07	9,0	6,4	3,0	2,2	2,2
5 800	35,3	5,27	8,7	6,1	2,9	2,1	2,1
6 000	35,1	5,48	8,4	5,9	2,8	2,0	2,0

Further probe parameters can be seen in Annex M of IEC 62209-2.

7.1.7 Comparison of DASY 52 NEO and cDASY6/DASY8

CTC advanced actually uses both systems side by side and the main differences of the DASY52 NEO and cDASY6/DASY8 system are system operation, reporting tools and measurement speed. DASY 52 still uses the DASY measurement software which has further in-depth options to adapt measurements to sophisticated test setups. For the reporting of the measurement results the companion software SEMCAD X is used. cDASY6/DASY8 is a different measurement system that is especially aimed to speed up standardized compliant measurements with high repeatability and less freedom of usability. It makes it possible to handle and rate compliance tests for a standardized product like a mobile phone in one place and it provides its own backend for reporting. The higher measurement speed is bought for the cost of less flexibility in the measurement setup and adding further sophisticated maintenance as it is necessary to perform regular mother scans.

Feature comparison:		
	DASY 52 (NEO)	cDASY6/DASY8
Warning feature for Zoom Scan according IEC 62209-2 AMD1 (graded Grid conditions)*	yes**	yes
Graded Grids for Area and Zoom Scan supported	yes**	yes
Measurement software	DASY 52 NEO	cDASY6/DASY8
Reporting tool	SEMCAD X post processor	cDASY6/DASY8 integrated post processor
Collusion detection to set probe to surface distance	yes	yes
Mother scans	no	yes

*) A warning appears if the stricter zoom scan criteria as defined in IEC 62209-2 AMD1 are violated using the actual zoom scan settings. In these cases a re-measurement with graded grid is performed and the result plot is updated with the information about the graded grid. This approach guarantees that the difference between the positions with maximum SAR to any adjacent point both horizontally and vertically is below the defined thresholds and that the SAR evaluation is correct.

(respecting both the 3 dB and the 30% criteria from section 6.3.1 d) of IEC 62209-2 AMD1.)

**) features were added with version: DASY52 - 52.10.2(1504) to satisfy IEC 62209-2 AMD1.

7.1.8 Spatial Peak SAR Evaluation

Both DASY5 V5.2 and cDASY6/DASY8 Module SAR software include all numerical procedures necessary to evaluate the spatial peak SAR values. Based on the IEEE 1528 standard, a new algorithm has been implemented. The spatial-peak SAR can be computed over any required mass. The base for the evaluation is a "cube" measurement in a volume of 30mm³ below 3GHz or 22mm³ above 3GHz. The measured volume must include the 1 g and 10 g cubes with the highest averaged SAR values. For that purpose, the center of the measured volume is aligned to the interpolated peak SAR value of a previously performed area scan. If the 10g cube or both cubes are not entirely inside the measured volumes, the system issues a warning regarding the evaluated spatial peak values within the post-processing engine. This means that if the measured volume is shifted, higher values might be possible. To get the correct values a finer measurement grid for the area scan is used. In complicated field distributions, a large grid spacing for the area scan might miss some details and give an incorrectly interpolated peak location. Both DASY5 V5.2 and cDASY6/DASY8 Module SAR allow to automatically extend the grid to make sure that both cubes are inside the measured volume.

The entire evaluation of the spatial peak values is performed within the application in case of cDASY6/DASY8 Module SAR software or within Post-processing engine (SEMCAD X) for DASY5 V5.2. The system always gives the maximum values for the 1 g and 10 g cubes. The cDASY6/DASY8 software allow to automatically extend the grid to make sure that both cubes are inside the measured volume. The algorithm to find the cube with highest averaged SAR is divided into the following stages:

1. extraction of the measured data (grid and values) from the Zoom Scan
2. calculation of the SAR value at every measurement point based on all stored data (A/D values and measurement parameters)
3. generation of a high-resolution mesh within the measured volume
4. interpolation of all measured values from the measurement grid to the high-resolution grid
5. extrapolation of the entire 3-D field distribution to the phantom surface over the distance from sensor to surface
6. calculation of the averaged SAR within masses of 1 g and 10 g The significant parts are outlined in more detail within the following sections.

Interpolation, Extrapolation and Detection of Maxima

The probe is calibrated at the center of the dipole sensors which is located 1 to 2.7mm away from the probe tip. During measurements, the probe stops shortly above the phantom surface, depending on the probe and the surface detecting system. Both distances are included as parameters in the probe configuration file. The software always knows exactly how far away the measured point is from the surface. As the probe cannot directly measure at the surface, the values between the deepest measured point and the surface must be extrapolated.

The choice of the coordinate system defining the location of the measurement points has no influence on the uncertainty of the interpolation, Maxima Search and extrapolation routines. The interpolation, extrapolation and maximum search routines are all based on the modified Quadratic Shepard's method [Robert J. Renka, "Multivariate Interpolation Of Large Sets Of Scattered Data", University of North Texas ACM Transactions on Mathematical Software, vol. 14, no. 2, June 1988, pp. 139-148.].

Thereby, the interpolation scheme combines a least-square fitted function method and a weighted average method which are the two basic types of computational interpolation and approximation. The cDASY6/DASY8 routines construct a once-continuously differentiable function that interpolates the measurement values as follows:

- For each measurement point a trivariate (3-D) / bivariate (2-D) quadratic is computed. It interpolates the measurement values at the data point and forms a least-square fit to neighbouring measurement values.
- the spatial location of the quadratic with respect to the measurement values is attenuated by an inverse distance weighting. This is performed since the calculated quadratic will fit measurement values at nearby points more accurate than at points located further away.
- After the quadratics are calculated at all measurement points, the interpolating function is calculated as a weighted average of the quadratics.

There are two control parameters that govern the behavior of the interpolation method.

One specifies the number of measurement points to be used in computing the least-square fits for the local quadratics. These measurement points are the ones nearest the input point for which the quadratic is being computed.

The second parameter specifies the number of measurement points that will be used in calculating the weights for the quadratics to produce the final function. The input data points used there are the ones nearest the point at which the interpolation is desired. Appropriate defaults are chosen for each of the control parameters.

The trivariate quadratics that have been previously computed for the 3-D interpolation and whose input data are at the closest distance from the phantom surface, are used in order to extrapolate the fields to the surface of the phantom.

In order to determine all the field maxima in 2-D (Area Scan) and 3-D (Zoom Scan), the measurement grid is refined by a default factor of 10 (area) and 5 (zoom), respectively, and the interpolation function is used to evaluate all field values between corresponding measurement points. Subsequently, a linear search is applied to find all the candidate maxima. In a last step, non physical maxima are removed and only those maxima which are within 2 dB of the global maximum value are retained.

Important: To be processable by the interpolation/extrapolation scheme, the Area Scan requires at least 6 measurement points. The Zoom Scan requires at least 10 measurement points to allow the application of these algorithms.

In the Area Scan, the gradient of the interpolation function is evaluated to find all the extrema of the SAR distribution. The uncertainty on the locations of the extrema is less than 1/20 of the grid size. Only local maxima within 2 dB of the global maximum are searched and passed for the Zoom Scan measurement.

In the Zoom Scan, the interpolation function is used to extrapolate the Peak SAR from the lowest measurement points to the inner phantom surface (the extrapolation distance). The uncertainty increases with the extrapolation distance. To keep the uncertainty within 1% for the 1 g and 10 g cubes, the extrapolation distance should not be larger than 5 mm.

Averaging and Determination of spatial Peak SAR

Within DASYS V5.2 software, the interpolated data is used to average the SAR over the 1g and 10g cubes by spatially discretizing the entire measured volume. The resolution of this spatial grid is around 1mm and chosen such that the cube side length is a multiple of the resolution. The resulting volumes are defined as cubical volumes containing the appropriate tissue parameters that are centered at the location. The location is defined as the center of the incremental volume.

The spatial-peak SAR must be evaluated in cubical volumes containing a mass that is within 5% of the required mass. The cubical volume centered at each location, as defined above, should be expanded in all directions until the desired value for the mass is reached, with no surface boundaries of the averaging volume extending beyond the outermost surface of the considered region. In addition, the cubical volume should not consist of more than 10% of non-liquid volume. If these conditions are not satisfied, then the center of the averaging volume is moved to the next location.

Reference is kept of all locations used and those not used for averaging the SAR. All average SAR values are finally assigned to the centered location in each valid averaging volume. All locations included in an averaging volume are marked as used to indicate that they have been used at least once. If a location has been marked as used, but has never been the center of a cube, the highest averaged SAR value of all other cubical volumes which have used this location for averaging is assigned to this location. For the case of an unused location, a new averaging volume must be constructed which will have the unused location centered at one surface of the cube. The remaining five surfaces are expanded evenly in all directions until the required mass is enclosed, regardless of the amount of included air. Of the six possible cubes with one surface centered on the unused location, the smallest cube is used, which still contains the required mass.

If the final cube containing the highest averaged SAR touches the surface of the measured volume, an appropriate warning is issued within the Post-processing engine.

Within cDASY6/DASY8 Module SAR software, the measured grid is interpolated to a high resolution grid, where the resolution is around 1mm and chosen such that the cube volume is a multiple of the resolution. Points which are outside of the measured grid are masked out and set to zero. Then, the antiderivative of the interpolated grid is computed by using a Gaussian quadrature consecutively for all spatial dimensions.

The antiderivative is used to compute all cube averages of the volume with the same resolution as the interpolated grid. The maximum of these SAR averages is reported. If the cube containing the maximum averaged SAR touches the surface of the measured volume, an appropriate warning is issued within the Post-processing engine.

7.1.9 Data Storage and Evaluation

Data Storage

The DASY software stores the acquired data from the data acquisition electronics as raw data (in microvolt readings from the probe sensors), together with all necessary software parameters for the data evaluation (probe calibration data, liquid parameters and device frequency and modulation data) in measurement files with the extension ".DA4", ".DA5x". The software evaluates the desired unit and format for output each time the data is visualized or exported. This allows verification of the complete software setup even after the measurement and allows correction of incorrect parameter settings. For example, if a measurement has been performed with a wrong crest factor parameter in the device setup, the parameter can be corrected afterwards and the data can be re-evaluated.

The measured data can be visualized or exported in different units or formats, depending on the selected probe type ([V/m], [A/m], [°C], [mW/g], [mW/cm²], [dBrel], etc.). Some of these units are not available in certain situations or show meaningless results, e.g., a SAR output in a lossless media will always be zero. Raw data can also be exported to perform the evaluation with other software packages.

Data Evaluation by SEMCAD

The SEMCAD software automatically executes the following procedures to calculate the field units from the microvolt readings at the probe connector. The parameters used in the evaluation are stored in the configuration modules of the software:

Probe parameters:	- Sensitivity	Norm _i , a _{i0} , a _{i1} , a _{i2}
	- Conversion factor	ConvF _i
	- Diode compression point	Dcpi
Device parameters:	- Frequency	f
	- Crest factor	cf
Media parameters:	- Conductivity	σ
	- Density	ρ

These parameters must be set correctly in the software. They can be found in the component documents or they can be imported into the software from the configuration files issued for the DASY components. In the direct measuring mode of the multimeter option, the parameters of the actual system setup are used. In the scan visualization and export modes, the parameters stored in the corresponding document files are used.

The first step of the evaluation is a linearization of the filtered input signal to account for the compression characteristics of the detector diode. The compensation depends on the input signal, the diode type and the DC-transmission factor from the diode to the evaluation electronics.

If the exciting field is pulsed, the crest factor of the signal must be known to correctly compensate for peak power. The formula for each channel can be given as:

$$V_i = U_i + U_i^2 \cdot cf/dcp_i$$

with V_i = compensated signal of channel i (i = x, y, z)
 U_i = input signal of channel i (i = x, y, z)
 cf = crest factor of exciting field (DASY parameter)
 dcp_i = diode compression point (DASY parameter)

From the compensated input signals the primary field data for each channel can be evaluated:

E-field probes: $E_i = (V_i / Norm_i \cdot ConvF)^{1/2}$

H-field probes: $H_i = (V_i)^{1/2} \cdot (a_{i0} + a_{i1}f + a_{i2}f^2)/f$

with V_i = compensated signal of channel i (i = x, y, z)
 $Norm_i$ = sensor sensitivity of channel i (i = x, y, z)
[mV/(V/m)²] for E-field Probes
 $ConvF$ = sensitivity enhancement in solution
 a_{ij} = sensor sensitivity factors for H-field probes
 f = carrier frequency [GHz]
 E_i = electric field strength of channel i in V/m
 H_i = magnetic field strength of channel i in A/m

The RSS value of the field components gives the total field strength (Hermitian magnitude):

$$E_{tot} = (E_x^2 + E_y^2 + E_z^2)^{1/2}$$

The primary field data are used to calculate the derived field units.

$$SAR = (E_{tot}^2 \cdot \sigma) / (\rho \cdot 1000)$$

with SAR = local specific absorption rate in mW/g
 E_{tot} = total field strength in V/m
 σ = conductivity in [mho/m] or [Siemens/m]
 ρ = equivalent tissue density in g/cm³

Note that the density is normally set to 1 (or 1.06), to account for actual brain density rather than the density of the simulation liquid. The power flow density is calculated assuming the excitation field to be a free space field.

$$P_{pwe} = E_{tot}^2 / 3770 \quad \text{or} \quad P_{pwe} = H_{tot}^2 \cdot 37.7$$

with P_{pwe} = equivalent power density of a plane wave in mW/cm²
 E_{tot} = total electric field strength in V/m
 H_{tot} = total magnetic field strength in A/m

Data Evaluation in cDASY6/DASY8

cDASY6/DASY8 features basic evaluation capabilities comparable to the above described SEMCAD evaluation. The main difference is that cDASY6/DASY8 is a stand-alone all-in-one solution whilst SEMCAD is only used to add these features to the DASY5.2 (NEO) platform. The final results are fully comparable no matter if they were generated by DASY5.2(NEO) + SEMCAD or in cDASY6/DASY8 directly.

7.1.10 Tissue simulating liquids: dielectric properties

The following materials are used for producing the tissue-equivalent materials.

HBBL600-10000MHz Simulating Head Liquid, Manufactured by SPEAG:

Ingredients	(% by weight)
Water	50-65%
Mineral oil	10-30%
Emulsifiers	8-25%
Sodium salt	0-1.5%

Table 2: Head tissue dielectric properties

7.1.11 Tissue simulating liquids: parameters

Freq. (MHz)	Target head tissue		Measurement head tissue					Measurement date
	Permittivity	Conductivity [S/m]	Permittivity	Dev. %	Conductivity		Dev. %	
					ϵ''	[S/m]		
450	43.50	0.87	42.3	-2.7	31.48	0.79	-9.4	2023-04-27
470	43.39	0.87	42.2	-2.7	30.42	0.80	-8.7	
480	43.34	0.87	42.2	-2.6	29.89	0.80	-8.5	
500	43.23	0.87	42.1	-2.6	28.84	0.80	-8.2	
516	43.15	0.87	42.1	-2.5	28.16	0.81	-7.6	
537	43.04	0.88	42.0	-2.4	27.26	0.81	-7.0	
538	43.03	0.88	42.0	-2.4	27.22	0.81	-7.0	
550	42.97	0.88	42.0	-2.4	26.71	0.82	-6.8	
592	42.74	0.88	41.8	-2.2	25.20	0.83	-5.6	
600	42.70	0.88	41.8	-2.1	24.91	0.83	-5.5	
621	42.59	0.88	41.7	-2.0	24.29	0.84	-4.8	
630	42.54	0.88	41.7	-2.0	24.02	0.84	-4.6	
638	42.50	0.88	41.7	-2.0	23.78	0.84	-4.4	
664	42.36	0.88	41.6	-1.8	23.06	0.85	-3.7	
694	42.20	0.89	41.5	-1.7	22.29	0.86	-2.9	
700	42.17	0.89	41.5	-1.6	22.14	0.86	-2.8	
600	42.70	0.88	41.4	-3.1	26.14	0.87	-0.9	
621	42.59	0.88	41.3	-3.0	25.46	0.88	-0.2	
662	42.37	0.88	41.2	-2.8	24.19	0.89	0.8	
698	42.18	0.89	41.1	-2.6	23.18	0.90	1.5	
820	41.57	0.90	40.8	-1.8	20.57	0.94	4.5	
822	41.56	0.90	40.8	-1.8	20.54	0.94	4.5	
832	41.51	0.90	40.8	-1.7	20.36	0.94	4.8	
852	41.50	0.92	40.8	-1.8	20.02	0.95	3.3	
880	41.50	0.95	40.7	-1.9	19.59	0.96	1.1	
900	41.50	0.97	40.7	-2.0	19.29	0.97	-0.4	
1750	40.07	1.37	38.6	-3.7	14.09	1.37	0.0	2023-05-04
1785	40.02	1.39	38.6	-3.6	14.01	1.39	0.0	
1795	40.01	1.40	38.6	-3.6	13.98	1.40	-0.1	
1800	40.00	1.40	38.6	-3.6	13.97	1.40	-0.1	
2402	39.28	1.76	37.7	-3.9	13.07	1.75	-0.6	2023-05-05
2442	39.21	1.79	37.7	-3.9	13.01	1.77	-1.4	
2450	39.20	1.80	37.7	-3.9	13.00	1.77	-1.6	
2480	39.19	1.83	37.7	-3.9	12.96	1.79	-2.4	

Table 3: Parameter of the head tissue simulating liquid

Note: The dielectric properties have been measured using the contact probe method at 22°C.

NOTE:

When the liquid parameters deviation is $\geq \pm 5\%$ an extrapolation according IEC / IEEE 62209-1528 chapter 7.8.2 approach 3 is necessary. The DASY software is capable to perform the necessary corrections directly from the tissue and measurement data. The uncertainties in this document have been adjusted accordingly.

For detailed information see chapter 8.3.4 SAR correction for deviations of complex permittivity from targetson page 36.

7.1.12 Measurement uncertainty evaluation for SAR test

Relative DASY5 Uncertainty Budget for SAR Tests									
According to IEEE 1528/2013 and IEC62209/2011 for the 0.3 - 3GHz range									
Error Description	Uncertainty Value ± %	Probability Distribution	Divisor	c _i (1g)	c _i (10g)	Standard Uncertainty		v _i ² or v _{eff}	
						± %, (1g)	± %, (10g)		
Measurement System									
Probe calibration	± 6.0 %	Normal	1	1	1	± 6.0 %	± 6.0 %	∞	
Axial isotropy	± 4.7 %	Rectangular	√ 3	0.7	0.7	± 1.9 %	± 1.9 %	∞	
Hemispherical isotropy	± 9.6 %	Rectangular	√ 3	0.7	0.7	± 3.9 %	± 3.9 %	∞	
Boundary effects	± 1.0 %	Rectangular	√ 3	1	1	± 0.6 %	± 0.6 %	∞	
Probe linearity	± 4.7 %	Rectangular	√ 3	1	1	± 2.7 %	± 2.7 %	∞	
System detection limits	± 1.0 %	Rectangular	√ 3	1	1	± 0.6 %	± 0.6 %	∞	
Modulation Response	± 2.4 %	Rectangular	√ 3	1	1	± 1.4 %	± 1.4 %	∞	
Readout electronics	± 0.3 %	Normal	1	1	1	± 0.3 %	± 0.3 %	∞	
Response time	± 0.8 %	Rectangular	√ 3	1	1	± 0.5 %	± 0.5 %	∞	
Integration time	± 2.6 %	Rectangular	√ 3	1	1	± 1.5 %	± 1.5 %	∞	
RF ambient noise	± 3.0 %	Rectangular	√ 3	1	1	± 1.7 %	± 1.7 %	∞	
RF ambient reflections	± 3.0 %	Rectangular	√ 3	1	1	± 1.7 %	± 1.7 %	∞	
Probe positioner	± 0.4 %	Rectangular	√ 3	1	1	± 0.2 %	± 0.2 %	∞	
Probe positioning	± 2.9 %	Rectangular	√ 3	1	1	± 1.7 %	± 1.7 %	∞	
Max. SAR evaluation	± 2.0 %	Rectangular	√ 3	1	1	± 1.2 %	± 1.2 %	∞	
Test Sample Related									
Device positioning	± 2.9 %	Normal	1	1	1	± 2.9 %	± 2.9 %	145	
Device holder uncertainty	± 3.6 %	Normal	1	1	1	± 3.6 %	± 3.6 %	5	
Power drift	± 5.0 %	Rectangular	√ 3	1	1	± 2.9 %	± 2.9 %	∞	
Phantom and Set-up									
Phantom uncertainty	± 6.1 %	Rectangular	√ 3	1	1	± 3.5 %	± 3.5 %	∞	
SAR correction	± 1.9 %	Rectangular	√ 3	1	0.84	± 1.1 %	± 0.9 %	∞	
Liquid conductivity (meas.)	± 5.0 %	Rectangular	√ 3	0.78	0.71	± 2.3 %	± 2.0 %	∞	
Liquid permittivity (meas.)	± 5.0 %	Rectangular	√ 3	0.26	0.26	± 0.8 %	± 0.8 %	∞	
Temp. Unc. - Conductivity	± 3.4 %	Rectangular	√ 3	0.78	0.71	± 1.5 %	± 1.4 %	∞	
Temp. Unc. - Permittivity	± 0.4 %	Rectangular	√ 3	0.23	0.26	± 0.1 %	± 0.1 %	∞	
Combined Uncertainty						± 11.3 %	± 11.3 %	330	
Expanded Std. Uncertainty						± 22.7 %	± 22.5 %		

Table 4: Measurement uncertainties

Worst-Case uncertainty budget for DASY5 assessed according to IEEE 1528/2013 and IEC 62209-1/2011 standards. The budget is valid for the frequency range 300MHz -3 GHz and represents a worst-case analysis. For specific tests and configurations, the uncertainty could be considerable smaller.

NOTE:

With the features that have been added in version DASY52 - 52.10.2(1504) (or higher) the DASY5 System is fully compliant to IEC 62209-2 AMD1 and IEC / IEEE 62209-1528.

DASY5 Uncertainty Budget									
According to IEC 62209-2/2010 for the 300 MHz - 6 GHz range									
Source of uncertainty	Uncertainty Value		Probability Distribution	Divisor	c _i (1g)	c _i (10g)	Standard Uncertainty		v _i ² or v _{eff}
							± %, (1g)	± %, (10g)	
Measurement System									
Probe calibration	± 6.6 %		Normal	1	1	1	± 6.6 %	± 6.6 %	∞
Axial isotropy	± 4.7 %		Rectangular	√ 3	0.7	0.7	± 1.9 %	± 1.9 %	∞
Hemispherical isotropy	± 9.6 %		Rectangular	√ 3	0.7	0.7	± 3.9 %	± 3.9 %	∞
Boundary effects	± 2.0 %		Rectangular	√ 3	1	1	± 1.2 %	± 1.2 %	∞
Probe linearity	± 4.7 %		Rectangular	√ 3	1	1	± 2.7 %	± 2.7 %	∞
System detection limits	± 1.0 %		Rectangular	√ 3	1	1	± 0.6 %	± 0.6 %	∞
Modulation Response	± 2.4 %		Rectangular	√ 3	1	1	± 1.4 %	± 1.4 %	∞
Readout electronics	± 0.3 %		Normal	1	1	1	± 0.3 %	± 0.3 %	∞
Response time	± 0.8 %		Rectangular	√ 3	1	1	± 0.5 %	± 0.5 %	∞
Integration time	± 2.6 %		Rectangular	√ 3	1	1	± 1.5 %	± 1.5 %	∞
RF ambient noise	± 3.0 %		Rectangular	√ 3	1	1	± 1.7 %	± 1.7 %	∞
RF ambient reflections	± 3.0 %		Rectangular	√ 3	1	1	± 1.7 %	± 1.7 %	∞
Probe positioner	± 0.8 %		Rectangular	√ 3	1	1	± 0.5 %	± 0.5 %	∞
Probe positioning	± 6.7 %		Rectangular	√ 3	1	1	± 3.9 %	± 3.9 %	∞
Post-processing	± 4.0 %		Rectangular	√ 3	1	1	± 2.3 %	± 2.3 %	∞
Test Sample Related									
Device positioning	± 2.9 %		Normal	1	1	1	± 2.9 %	± 2.9 %	145
Device holder uncertainty	± 3.6 %		Normal	1	1	1	± 3.6 %	± 3.6 %	5
Power drift	± 5.0 %		Rectangular	√ 3	1	1	± 2.9 %	± 2.9 %	∞
Phantom and Set-up									
Phantom uncertainty	± 7.9 %		Rectangular	√ 3	1	1	± 4.6 %	± 4.6 %	∞
SAR correction	± 1.9 %		Rectangular	√ 3	1	0.84	± 1.1 %	± 0.9 %	∞
Liquid conductivity (meas.)	± 5.0 %		Rectangular	√ 3	0.78	0.71	± 2.3 %	± 2.0 %	∞
Liquid permittivity (meas.)	± 5.0 %		Rectangular	√ 3	0.26	0.26	± 0.8 %	± 0.8 %	∞
Temp. Unc. - Conductivity	± 3.4 %		Rectangular	√ 3	0.78	0.71	± 1.5 %	± 1.4 %	∞
Temp. Unc. - Permittivity	± 0.4 %		Rectangular	√ 3	0.23	0.26	± 0.1 %	± 0.1 %	∞
Combined Uncertainty							± 12.7 %	± 12.6 %	330
Expanded Std. Uncertainty							± 25.4 %	± 25.3 %	

Table 5: Measurement uncertainties.

Worst-Case uncertainty budget for DASY5 assessed according to IEC 62209-2/2010 standard. The budget is valid for the frequency range 300MHz - 6 GHz and represents a worst-case analysis. For specific tests and configurations, the uncertainty could be considerable smaller.

NOTE:

With the features that have been added in version DASY52 - 52.10.2(1504) (or higher) the DASY5 System is fully compliant to IEC 62209-2 AMD1 and IEC / IEEE 62209-1528.

7.1.13 Measurement uncertainty evaluation for System Check

Uncertainty of a System Performance Check with DASY5 System for the 0.3 - 3 GHz range									
Source of uncertainty	Uncertainty Value	Probability Distribution	Divisor	c_i	c_i	Standard Uncertainty		v_i^2 or v_{eff}	
				(1g)	(10g)	± %, (1g)	± %, (10g)		
Measurement System									
Probe calibration	± 6.0 %	Normal	1	1	1	± 6.0 %	± 6.0 %	∞	
Axial isotropy	± 4.7 %	Rectangular	√ 3	0.7	0.7	± 1.9 %	± 1.9 %	∞	
Hemispherical isotropy	± 0.0 %	Rectangular	√ 3	0.7	0.7	± 0.0 %	± 0.0 %	∞	
Boundary effects	± 1.0 %	Rectangular	√ 3	1	1	± 0.6 %	± 0.6 %	∞	
Probe linearity	± 4.7 %	Rectangular	√ 3	1	1	± 2.7 %	± 2.7 %	∞	
System detection limits	± 1.0 %	Rectangular	√ 3	1	1	± 0.6 %	± 0.6 %	∞	
Readout electronics	± 0.3 %	Normal	1	1	1	± 0.3 %	± 0.3 %	∞	
Response time	± 0.0 %	Rectangular	√ 3	1	1	± 0.0 %	± 0.0 %	∞	
Integration time	± 0.0 %	Rectangular	√ 3	1	1	± 0.0 %	± 0.0 %	∞	
RF ambient conditions	± 3.0 %	Rectangular	√ 3	1	1	± 1.7 %	± 1.7 %	∞	
Probe positioner	± 0.4 %	Rectangular	√ 3	1	1	± 0.2 %	± 0.2 %	∞	
Probe positioning	± 2.9 %	Rectangular	√ 3	1	1	± 1.7 %	± 1.7 %	∞	
Max. SAR evaluation	± 1.0 %	Rectangular	√ 3	1	1	± 0.6 %	± 0.6 %	∞	
Test Sample Related									
Dev. of experimental dipole	± 0.0 %	Rectangular	√ 3	1	1	± 0.0 %	± 0.0 %	∞	
Source to liquid distance	± 2.0 %	Rectangular	√ 3	1	1	± 1.2 %	± 1.2 %	∞	
Power drift	± 3.4 %	Rectangular	√ 3	1	1	± 2.0 %	± 2.0 %	∞	
Phantom and Set-up									
Phantom uncertainty	± 4.0 %	Rectangular	√ 3	1	1	± 2.3 %	± 2.3 %	∞	
SAR correction	± 1.9 %	Rectangular	√ 3	1	0.84	± 1.1 %	± 0.9 %	∞	
Liquid conductivity (meas.)	± 5.0 %	Normal	1	0.78	0.71	± 3.9 %	± 3.6 %	∞	
Liquid permittivity (meas.)	± 5.0 %	Normal	1	0.26	0.26	± 1.3 %	± 1.3 %	∞	
Temp. unc. - Conductivity	± 1.7 %	Rectangular	√ 3	0.78	0.71	± 0.8 %	± 0.7 %	∞	
Temp. unc. - Permittivity	± 0.3 %	Rectangular	√ 3	0.23	0.26	± 0.0 %	± 0.0 %	∞	
Combined Uncertainty						± 9.1 %	± 8.9 %	330	
Expanded Std. Uncertainty						± 18.2 %	± 17.9 %		

Table 6: Measurement uncertainties of the System Check with DASY5 (0.3-3GHz)

NOTE:

With the features that have been added in version DASY52 - 52.10.2(1504) (or higher) the DASY5 System is fully compliant to IEC 62209-2 AMD1 and IEC / IEEE 62209-1528.

7.1.14 System check

The system check is performed for verifying the accuracy of the complete measurement system and performance of the software. The system check is performed with tissue equivalent material according to IEEE 1528. The following table shows system check results for all frequency bands and tissue liquids used during the tests (plot(s) see annex A).

System performance check (1000 mW)									
System validation Kit	Probe	Frequency	Target SAR _{1g} /mW/g (+/-10%)	Target SAR _{10g} /mW/g (+/- 10%)	Measured SAR _{1g} / mW/g	SAR _{1g} dev.	Measured SAR _{10g} / mW/g	SAR _{10g} dev.	Measured date
D450V3 S/N: 1060	EX3DV4 S/N: 7635	450 MHz HSL	4.49	2.98	4.35	-3.1%	2.95	-1.0%	2023-04-27
D600V3 S/N: 1015	EX3DV4 S/N: 7635	600 MHz HSL	6.31	4.17	6.69	6.0%	4.44	6.5%	2023-04-28
D600V3 S/N: 1015	EX3DV4 S/N: 7635	600 MHz HSL	6.31	4.17	6.09	-3.5%	4.03	-3.4%	2023-05-02
D600V3 S/N: 1015	EX3DV4 S/N: 7635	600 MHz HSL	6.31	4.17	6.82	8.1%	4.50	7.9%	2023-05-03
D900V2 S/N: 102	EX3DV4 S/N: 7635	900 MHz HSL	10.80	6.95	10.70	-0.9%	6.99	0.6%	2023-05-03
D1750V2 S/N: 1093	EX3DV4 S/N: 7635	1750 MHz HSL	37.20	19.50	36.20	-2.7%	19.20	-1.5%	2023-05-04
D2450V2 S/N: 710	EX3DV4 S/N: 7635	2450 MHz HSL	51.80	24.10	56.30	8.7%	26.10	8.3%	2023-05-05

Table 7: Results system check

7.1.15 System check procedure

The system check is performed by using a validation dipole which is positioned parallel to the planar part of the SAM phantom at the reference point. The distance of the dipole to the SAM phantom is determined by a plexiglass spacer. The dipole is connected to the signal source consisting of signal generator and amplifier via a directional coupler, N-connector cable and adaption to SMA. It is fed with a power of 1000 mW for frequencies below 2 GHz or 100 mW for frequencies above 2 GHz. To adjust this power a power meter is used. The power sensor is connected to the cable before the system check to measure the power at this point and do adjustments at the signal generator. At the outputs of the directional coupler both return loss as well as forward power are controlled during the validation to make sure that emitted power at the dipole is kept constant. This can also be checked by the power drift measurement after the test (result on plot).

System check results have to be equal or near the values determined during dipole calibration (target SAR in table above) with the relevant liquids and test system.

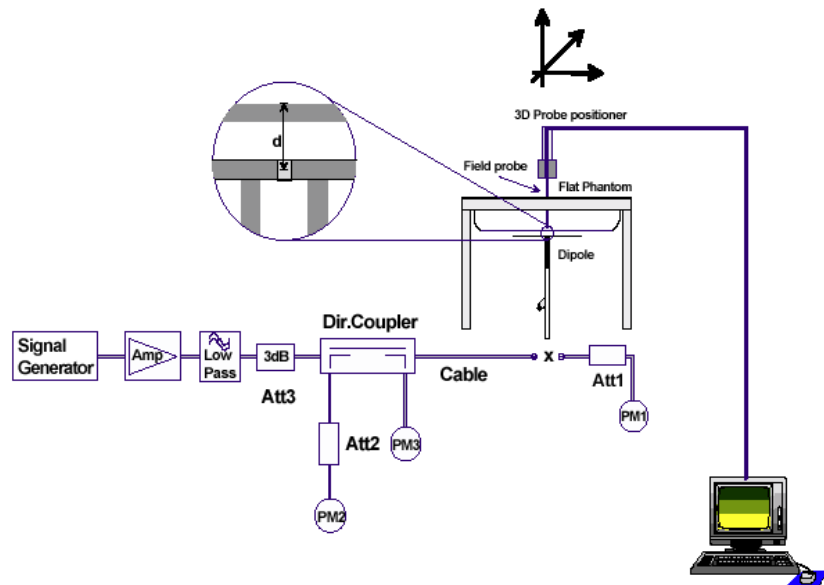

7.1.16 System validation

The system validation is performed in a similar way as a system check. It needs to be performed once a SAR measurement system has been established and allows an evaluation of the system accuracy with all components used together with the specified system. It has to be repeated at least once a year or when new system components are used (DAE, probe, phantom, dipole, liquid type).

In addition to the procedure used during system check a system validation also includes checks of probe isotropy, probe modulation factor and RF signal.

8 Detailed Test Results

8.1 Conducted power measurements UHF

UHF Q1-6 (1123000128)				
MHz	470.2	498.0	526.0	--
P _{avg} (dBm)	10.34	11.07	11.39	--
UHF R1-6 (1123000031)				
MHz	520.0	548.0	576.0	--
P _{avg} (dBm)	9.96	10.52	10.81	--
UHF R4-9 (1123000034)				
MHz	552.0	576.0	607.0	--
P _{avg} (dBm)	9.87	10.19	10.20	--
UHF S1-7 (1123000030)				
MHz	606.2	634.0	662.0	--
P _{avg} (dBm)	8.99	9.61	9.81	--
UHF S4-7 (1123000029)				
MHz	630.0	646.0	662.0	--
P _{avg} (dBm)	10.15	10.30	10.36	--
UHF S7-10 (1123000036)				
MHz	662.0	678.0	693.0	--
P _{avg} (dBm)	10.42	10.48	10.26	--
UHF U1/5 (1123000039)				
MHz	823.2	831.8	863.2	864.0
P _{avg} (dBm)	9.89.0	10.01	10.19	10.20
UHF Y1-3 (1123000059)				
MHz	1785.2	1792.5	1799.7	--
P _{avg} (dBm)	9.97	9.98	9.94	--

Table 8: Test results conducted average power measurement UHF

8.2 Conducted power measurements Bluetooth LE 2.4 GHz

Channel	Frequency (MHz)	Average power (dBm)	
		1 Msps	2 Msps
0	2402	4.19	4.21
19	2440	4.75	4.75
39	2480	4.35	4.48

Table 9: Test results conducted average power measurement BLUETOOTH LE 2.4 GHz

8.3 SAR test results

8.3.1 General description of test procedures

- The DUT is tested using a base station to set control test channels and maximum output power of the DUT.
- According to IEC/IEEE 62209-1528 the SAR test shall be performed at the channel producing the highest rated output power.
 - When the width of the transmit frequency band ($\Delta f = f_{high} - f_{low}$) exceeds 1 % of its centre frequency f_c , the channels at the lowest and highest frequencies of the transmit band shall also be tested.
 - When the width of the transmit frequency band exceeds 10 % of its centre frequency. The following formula shall be used to determine the number of channels, N_c , to be tested:

$$N_c = 2 \times \text{roundup} \left[\frac{(f_{high} - f_{low})}{f_c} \right] + 1$$

where

f_c is the centre frequency channel of the transmission band in Hz;

f_{high} is the highest frequency channel of the transmission band in Hz;

f_{low} is the lowest frequency channel of the transmission band in Hz;

N_c is the number of channels

- According to KDB 447498 D01 testing of other required channels within the operating mode of a frequency band is not required when the reported 1-g or 10-g SAR for the mid-band or highest output power channel is:
 - ≤ 0.8 W/kg or 2.0 W/kg, for 1-g or 10-g respectively, when the transmission band is ≤ 100 MHz
 - ≤ 0.6 W/kg or 1.5 W/kg, for 1-g or 10-g respectively, when the transmission band is between 100 MHz and 200 MHz
 - ≤ 0.4 W/kg or 1.0 W/kg, for 1-g or 10-g respectively, when the transmission band is ≥ 200 MHz

8.3.2 Results overview

measured / extrapolated SAR numbers SK 2250										
Freq. (MHz)	Position	cond. P _{max} (dBm)		SAR _{1g} (W/kg)		SAR _{10g} (W/kg)		power drift (dB)	liquid (°C)	dist. (mm)
		declared*	measured	meas.	extrap.	meas.	extrap.			
EW-DP SKP UHF Q1-6										
526.0	front	12.0	11.4	0.016	0.018	0.009	0.010	0.04	20.3	0
470.2	back	12.0	10.3	0.040	0.059	0.018	0.026	0.06	20.3	0
498.0	back	12.0	11.1	0.029	0.036	0.017	0.021	0.07	20.3	0
526.0	back	12.0	11.4	0.032	0.037	0.014	0.016	0.03	20.3	0
526.0	left	12.0	11.4	0.019	0.022	0.011	0.013	-0.02	20.3	0
526.0	right	12.0	11.4	0.031	0.035	0.016	0.019	-0.07	20.3	0
526.0	bottom	12.0	11.4	0.002	0.002	0.001	0.001	-0.16	20.3	0

Table 10: Test results SAR UHF Q1-6 470.2 to 526.0MHz

measured / extrapolated SAR numbers SK 2250										
Freq. (MHz)	Position	cond. P _{max} (dBm)		SAR _{1g} (W/kg)		SAR _{10g} (W/kg)		power drift (dB)	liquid (°C)	dist. (mm)
		declared*	measured	meas.	extrap.	meas.	extrap.			
EW-DP SKP UHF R1-6										
576.0	front	12.0	11.4	0.031	0.035	0.018	0.021	-0.04	20.1	0
576.0	back	12.0	11.4	0.037	0.043	0.023	0.027	0.03	20.1	0
520.0	left	12.0	10.3	0.022	0.032	0.011	0.016	0.03	20.1	0
548.0	left	12.0	11.1	0.032	0.039	0.017	0.021	0.03	20.1	0
576.0	left	12.0	11.4	0.050	0.058	0.027	0.030	-0.09	20.1	0
576.0	right	12.0	11.4	0.030	0.035	0.015	0.018	-0.01	20.1	0
576.0	bottom	12.0	11.4	0.021	0.024	0.007	0.008	0.10	20.1	0

Table 11: Test results SAR UHF R1-6 520.0 to 576.0MHz

measured / extrapolated SAR numbers SK 2250										
Freq. (MHz)	Position	cond. P _{max} (dBm)		SAR _{1g} (W/kg)		SAR _{10g} (W/kg)		power drift (dB)	liquid (°C)	dist. (mm)
		declared*	measured	meas.	extrap.	meas.	extrap.			
EW-DP SKP UHF R4-9										
607.0	front	11.5	10.2	0.040	0.053	0.024	0.032	-0.03	20.3	0
607.0	back	11.5	10.2	0.041	0.055	0.022	0.029	-0.09	20.3	0
607.0	left	11.5	10.2	0.038	0.051	0.024	0.032	0.01	20.3	0
552.0	right	11.5	9.9	0.040	0.058	0.019	0.028	0.03	20.3	0
576.0	right	11.5	10.2	0.059	0.080	0.027	0.037	0.03	20.3	0
607.0	right	11.5	10.2	0.048	0.065	0.024	0.032	0.04	20.3	0
607.0	bottom	11.5	10.2	0.020	0.027	0.009	0.013	-0.12	20.3	0

Table 12: Test results SAR UHF R4-9 552.0 to 607.0MHz

measured / extrapolated SAR numbers SK 2250										
Freq. (MHz)	Position	cond. P _{max} (dBm)		SAR _{1g} (W/kg)		SAR _{10g} (W/kg)		power drift (dB)	liquid (°C)	dist. (mm)
		declared*	measured	meas.	extrap.	meas.	extrap.			
EW-DP SKP UHF S1-7										
662.0	front	11.5	9.8	0.041	0.061	0.024	0.035	-0.07	20.1	0
606.2	back	11.5	9.8	0.050	0.074	0.024	0.035	0.03	20.1	0
634.0	back	11.5	9.8	0.051	0.075	0.029	0.043	-0.10	20.1	0
662.0	back	11.5	9.0	0.063	0.112	0.031	0.055	-0.05	20.1	0
662.0	left	11.5	9.6	0.056	0.087	0.029	0.045	-0.08	20.1	0
662.0	right	11.5	9.8	0.058	0.086	0.029	0.043	-0.05	20.1	0
662.0	bottom	11.5	9.8	0.062	0.091	0.015	0.022	0.01	20.1	0

Table 13: Test results SAR UHF S1-7 606.2 to 662.0MHz

measured / extrapolated SAR numbers SK 2250										
Freq. (MHz)	Position	cond. P _{max} (dBm)		SAR _{1g} (W/kg)		SAR _{10g} (W/kg)		power drift (dB)	liquid (°C)	dist. (mm)
		declared*	measured	meas.	extrap.	meas.	extrap.			
EW-DP SKP UHF S4-7										
662.0	front	11.5	9.8	0.043	0.064	0.024	0.036	-0.01	20.0	0
630.0	back	11.5	9.8	0.053	0.077	0.025	0.037	0.03	20.0	0
646.0	back	11.5	9.8	0.048	0.071	0.025	0.036	-0.10	20.0	0
662.0	back	11.5	9.0	0.065	0.115	0.030	0.053	0.00	20.0	0
662.0	left	11.5	9.6	0.057	0.088	0.028	0.043	-0.08	20.0	0
662.0	right	11.5	9.8	0.054	0.079	0.028	0.041	-0.05	20.0	0
662.0	bottom	11.5	9.8	0.028	0.041	0.005	0.007	0.01	20.0	0

Table 14: Test results SAR UHF S4-7 606.2 to 662.0MHz

measured / extrapolated SAR numbers SK 2250										
Freq. (MHz)	Position	cond. P _{max} (dBm)		SAR _{1g} (W/kg)		SAR _{10g} (W/kg)		power drift (dB)	liquid (°C)	dist. (mm)
		declared*	measured	meas.	extrap.	meas.	extrap.			
EW-DP SKP UHF S7-10										
662.0	front	12.0	10.5	0.036	0.051	0.021	0.030	-0.06	20.5	0
678.0	front	12.0	10.4	0.042	0.060	0.028	0.040	-0.07	20.5	0
693.0	front	12.0	10.5	0.021	0.030	0.014	0.020	0.08	20.5	0
678.0	back	12.0	10.3	0.039	0.058	0.023	0.035	0.02	20.5	0
678.0	left	12.0	10.5	0.038	0.054	0.027	0.039	-0.03	20.5	0
678.0	right	12.0	10.5	0.039	0.055	0.027	0.038	-0.08	20.5	0
678.0	bottom	12.0	10.5	0.029	0.041	0.005	0.007	-0.04	20.5	0

Table 15: Test results SAR UHF S7-10 662.0 to 693.8MHz

measured / extrapolated SAR numbers SK 2250										
Freq. (MHz)	Position	cond. P _{max} (dBm)		SAR _{1g} (W/kg)		SAR _{10g} (W/kg)		power drift (dB)	liquid (°C)	dist. (mm)
		declared*	measured	meas.	extrap.	meas.	extrap.			
EW-DP SKP UHF U1/5										
864.0	front	12.0	10.2	0.039	0.059	0.026	0.040	-0.04	20.5	0
864.0	back	12.0	10.2	0.017	0.026	0.008	0.013	0.27	20.5	0
823.2	left	12.0	10.0	0.041	0.065	0.023	0.037	-0.06	20.5	0
831.8	left	12.0	10.2	0.050	0.076	0.030	0.045	0.02	20.5	0
863.2	left	12.0	10.2	0.047	0.071	0.028	0.042	0.00	20.5	0
864.0	left	12.0	10.2	0.052	0.078	0.030	0.045	0.08	20.5	0
864.0	right	12.0	10.2	0.036	0.054	0.023	0.035	0.02	20.5	0
864.0	bottom	12.0	10.2	0.002	0.003	0.001	0.001	0.23	20.5	0

Table 16: Test results SAR UHF U1/5 823.2 to 864.8MHz

measured / extrapolated SAR numbers SK 2250										
Freq. (MHz)	Position	cond. P _{max} (dBm)		SAR _{1g} (W/kg)		SAR _{10g} (W/kg)		power drift (dB)	liquid (°C)	dist. (mm)
		declared*	measured	meas.	extrap.	meas.	extrap.			
EW-DP SKP UHF Y1-3										
1792.5	front	11.0	9.98	0.098	0.123	0.043	0.055	0.01	21.3	0
1792.5	back	11.0	9.98	0.046	0.058	0.020	0.026	-0.05	21.3	0
1785.2	left	11.0	9.97	0.104	0.132	0.046	0.058	0.12	21.3	0
1792.5	left	11.0	9.98	0.097	0.123	0.044	0.055	0.09	21.3	0
1799.7	left	11.0	9.94	0.113	0.144	0.051	0.064	0.11	21.3	0
1792.5	right	11.0	9.98	0.078	0.098	0.044	0.055	0.03	21.3	0
1792.5	bottom	11.0	9.98	0.006	0.008	0.003	0.004	0.02	21.3	0

Table 17: Test results SAR UHF Y1-3 1785.2 to 1799.8MHz

measured / extrapolated SAR numbers - Body worn - Bluetooth 2450 MHz												
Ch.	Freq. (MHz)	test cond.	Position	cond. P _{max} (dBm)		SAR _{1g} (W/kg)		SAR _{10g} (W/kg)		P _{drift} (dB)	liquid (°C)	dist. (mm)
				declared*	meas.	meas.	extrap.	meas.	extrap.			
19	2440	DH5	front	5.0	4.8	0.000	0.000	0.000	0.000	0.00	21.0	15
19	2440	DH5	back	5.0	4.8	0.005	0.005	0.003	0.003	0.00	21.0	15
19	2440	DH5	left	5.0	4.8	0.000	0.000	0.000	0.000	0.00	21.0	15
0	2402	DH5	right	5.0	4.2	0.019	0.023	0.007	0.008	0.14	21.0	15
19	2440	DH5	right	5.0	4.8	0.100	0.106	0.043	0.045	0.00	21.0	15
39	2480	DH5	right	5.0	4.4	0.054	0.063	0.022	0.026	0.02	21.0	15
19	2440	DH5	bottom	5.0	4.8	0.000	0.000	0.000	0.000	0.00	21.0	15

Table 18: Test results SAR BT LE 2450MHz

8.3.3 Multiple Transmitter Information

The following tables lists information which is relevant for the decision if a simultaneous transmit evaluation is necessary according to FCC KDB 447498D01 General RF Exposure Guidance v05.

SAR _{max} /W/kg		ΣSAR
UHF _{Max}	BT LE _{Max}	<1.6W/kg
0.144	0.106	0.250

Table 19: SAR_{max} ΣSAR evaluation.

Conclusion:

ΣSAR < 1.6 W/kg therefore simultaneous transmissions SAR measurement with the enlarged zoom scan measurement and volume scan post-processing procedures is **not** required.

8.3.4 SAR correction for deviations of complex permittivity from targets

The max reported SAR values are once more corrected wherever the deviation of the liquid parameters is larger than $\pm 5\%$.

Accordinging IEC / IEEE 62209-1528 chapter 7.8.2 SAR correction formula

there is a linear relationship between the percentage change in SAR (denoted ΔSAR) and the percentage change in the permittivity and conductivity from the target values (denoted $\Delta\epsilon$ and $\Delta\sigma$, respectively).

The relationship is given by:

$$\Delta\text{SAR} = c_{\epsilon}\Delta\epsilon + c_{\sigma}\Delta\sigma$$

where

$c_{\epsilon} = \partial (\Delta\text{SAR}) / \partial (\Delta\epsilon)$ is the coefficient representing the sensitivity of SAR to permittivity where SAR is normalized to output power;

$c_{\sigma} = \partial (\Delta\text{SAR}) / \partial (\Delta\sigma)$ is the coefficient representing the sensitivity of SAR to conductivity, where SAR is normalized to output power.

The values of c_{ϵ} and c_{σ} have a simple relationship with frequency that can be described using polynomial equations. For dipole antennas at frequencies from 4 MHz to 6 GHz, the **1 g averaged SAR** c_{ϵ} and c_{σ} are given by

$$c_{\epsilon} = -7.854 \times 10^{-4} \times f^3 + 9.402 \times 10^{-3} \times f^2 - 2.742 \times 10^{-2} \times f - 0.2026$$

$$c_{\sigma} = 9.804 \times 10^{-3} \times f^3 - 8.661 \times 10^{-2} \times f^2 + 2.981 \times 10^{-2} \times f + 0.7829$$

where f is the frequency in GHz. Above 6 GHz, the sensitivity is non-varying with frequency due to the small penetration depth; the values of $c_{\epsilon} = -0,198$ and $c_{\sigma} = 0$ shall be used.

For frequencies from 4 MHz to 6 GHz, the **10 g averaged SAR** c_{ϵ} and c_{σ} are given by:

$$c_{\epsilon} = 3.456 \times 10^{-3} \times f^3 - 3.531 \times 10^{-2} \times f^2 + 7.675 \times 10^{-2} \times f - 0.1860$$

$$c_{\sigma} = 4.479 \times 10^{-3} \times f^3 - 1.586 \times 10^{-2} \times f^2 - 0.1972 \times f + 0.7717$$

where f is the frequency in GHz. Above 6 GHz, the sensitivity is non-varying with frequency due to the small penetration depth; the values of $c_{\epsilon} = -0,250$ and $c_{\sigma} = 0$ shall be used.

NOTE:

The Tables in the uncertainties of this report are updated accordingly with the values from table 6 – Root-mean-squared error SAR correction formula as a function of the maximum change in permittivity or conductivity:

Max. change in ϵ or σ	RMS uncertainty for SAR _{1g} %	RMS uncertainty for SAR _{10g} %
$\pm 5\%$	1,2	0,97
$\pm 10\%$	1,9	1,6

NOTE:

The DASY software is capable of directly correcting the measured values according to the above-described procedure, fully compliant to IEC / IEEE 62209-1528, so that no further evaluation is necessary.

9 Test equipment and ancillaries used for tests

To simplify the identification of the test equipment and/or ancillaries which were used, the reporting of the relevant test cases only refer to the test item number as specified in the table below.

Equipment	Type	Manufacturer	Serial No.	Last Calibration	Frequency (months)
Dosimetric E-Field Probe	EX3DV4	Schmid & Partner Engineering AG	7635	January 18, 2023	12
450 MHz System Validation Dipole	D450V3	Schmid & Partner Engineering AG	1060	May 8, 2023	36
600 MHz System Validation Dipole	D600V3	Schmid & Partner Engineering AG	1015	May 18, 2022	36
900 MHz System Validation Dipole	D900V2	Schmid & Partner Engineering AG	102	January 16, 2023	36
1750 MHz System Validation Dipole	D1750V2	Schmid & Partner Engineering AG	1093	May 14, 2021	36
2450 MHz System Validation Dipole	D2450V2	Schmid & Partner Engineering AG	710	May 11, 2022	36
Data acquisition electronics	DAE3V1	Schmid & Partner Engineering AG	413	January 07, 2023	12
Software	DASY52 52.10.4.1527	Schmid & Partner Engineering AG	---	N/A	--
Phantom ELI 4.0	QD OVA 001 BB	Schmid & Partner Engineering AG	1046	N/A	--
Network Analyser 300 kHz to 6 GHz	8753ES	Agilent Technologies)*	US39174 436	December 14, 2021	24
Dielectric Probe Kit	85033D	Hewlett Packard	3423A060 60	January 04, 2021	36
Dielectric Assessment Kit (DAK)	DAK 200MHz – 20GHz Package	Schmid & Partner Engineering AG	1127	N/A	--
Signal Generator	SML03	Rohde & Schwarz	102519	December 06, 2021	24
RF Power Amplifier	ZHL-42	Mini circuits	N/A	N/A	--
Power Meter	NRP	Rohde & Schwarz	101367	December 06, 2022	12
Power Meter Sensor	NRP Z22	Rohde & Schwarz	100227	December 06, 2022	12
Power Meter Sensor	NRP Z22	Rohde & Schwarz	100234	December 06, 2022	12
Directional Coupler	778D	Hewlett Packard	19171	December 06, 2022	12

)* : Network analyzer probe calibration against air, distilled water and a shorting block performed before measuring liquid parameters.

10 Observations

No observations exceeding those reported with the single test cases have been made.

Annex A: System performance check

Date/Time: 27.04.2023 10:36:40

SystemPerformanceCheck-D450 HSL 2023-04-27

DUT: Dipole 450 MHz; Type: D450V3; Serial: 1060

Communication System: UID 0, CW (0); Communication System Band: D450 (450.0 MHz); Frequency: 450 MHz; Communication System PAR: 0 dB; PMF: 1

Medium parameters used: $f = 450$ MHz; $\sigma = 0.788$ S/m; $\epsilon_r = 42.307$; $\rho = 1000$ kg/m³

Phantom section: Flat Section

Measurement Standard: DASYS

DASY5 Configuration:

- Probe: EX3DV4 - SN7635; ConvF(11.6, 11.6, 11.6) @ 450 MHz; Calibrated: 18.01.2023
- Sensor-Surface: 1.4mm (Mechanical Surface Detection), $z = 1.0, 31.0$
- Electronics: DAE3 Sn413; Calibrated: 17.01.2023
- Phantom: ELI 4.0; Type: QDOVA001BB; Serial: 1046
- DASY52 52.10.4(1527); SEMCAD X 14.6.14(7483)

HSL750/d=15mm, Pin=1000 mW, dist=1.4mm/Area Scan (51x51x1): Interpolated

grid: $dx=1.500$ mm, $dy=1.500$ mm

Maximum value of SAR (interpolated) = 0.583 W/kg

HSL750/d=15mm, Pin=1000 mW, dist=1.4mm/Zoom Scan (7x7x7)/Cube 0:

Measurement grid: $dx=5$ mm, $dy=5$ mm, $dz=5$ mm

Reference Value = 29.04 V/m; Power Drift = -0.17 dB

Peak SAR (extrapolated) = 0.672 W/kg

SAR(1 g) = 0.435 W/kg; SAR(10 g) = 0.295 W/kg

Smallest distance from peaks to all points 3 dB below: Larger than measurement grid

Ratio of SAR at M2 to SAR at M1 = 65.3%

Maximum value of SAR (measured) = 0.578 W/kg

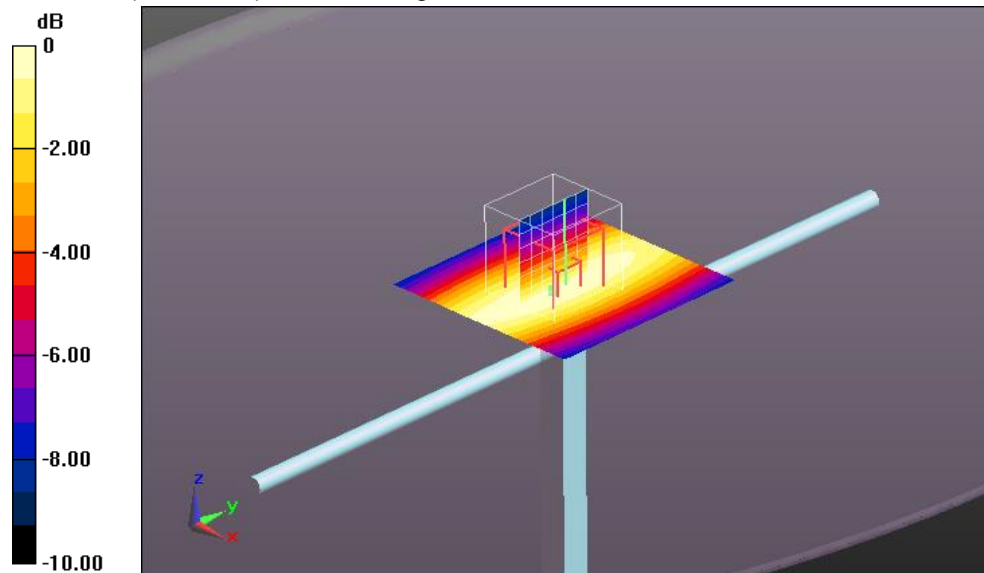

0 dB = 0.578 W/kg = -2.38 dBW/kg

Additional information:

ambient temperature: 22.2°C; liquid temperature: 20.3°C

SystemPerformanceCheck-D600 HSL 2023-04-28

DUT: D600V3 - SN1015; Type: D600V3; Serial: SN1015

Communication System: UID 0, CW (0); Communication System Band: FullSpan (0.0 - 6000.0 MHz);

Frequency: 600 MHz; Communication System PAR: 0 dB; PMF: 1

Medium parameters used: $f = 600$ MHz; $\sigma = 0.832$ S/m; $\epsilon_r = 41.784$; $\rho = 1000$ kg/m³

Phantom section: Flat Section

Measurement Standard: DASY5

DASY5 Configuration:

- Probe: EX3DV4 - SN7635; ConvF(10.75, 10.75, 10.75) @ 600 MHz; Calibrated: 18.01.2023
- Sensor-Surface: 1.4mm (Mechanical Surface Detection), $z = 1.0, 31.0$
- Electronics: DAE3 Sn413; Calibrated: 17.01.2023
- Phantom: ELI 4.0; Type: QDOVA001BB; Serial: 1046
- DASY52 52.10.4(1527); SEMCAD X 14.6.14(7483)

HSL750/d=15mm, Pin=1000 mW, dist=1.4mm/Area Scan (51x51x1): Interpolated
grid: $dx=1.500$ mm, $dy=1.500$ mm

Maximum value of SAR (interpolated) = 0.882 W/kg

HSL750/d=15mm, Pin=1000 mW, dist=1.4mm/Zoom Scan (7x7x7)/Cube 0:

Measurement grid: $dx=5$ mm, $dy=5$ mm, $dz=5$ mm

Reference Value = 33.44 V/m; Power Drift = -0.01 dB

Peak SAR (extrapolated) = 1.07 W/kg

SAR(1 g) = 0.669 W/kg; SAR(10 g) = 0.444 W/kg

Smallest distance from peaks to all points 3 dB below: Larger than measurement grid

Ratio of SAR at M2 to SAR at M1 = 63.1%

Maximum value of SAR (measured) = 0.917 W/kg

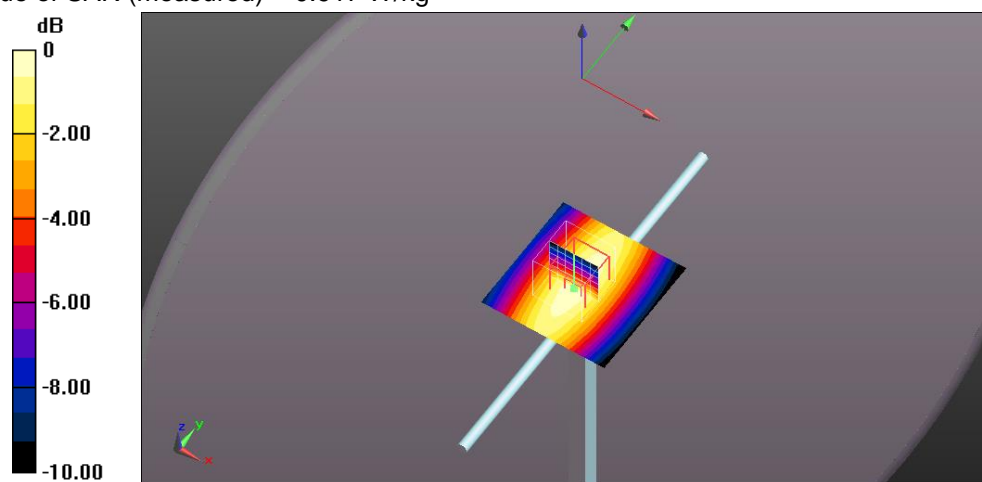

0 dB = 0.917 W/kg = -0.38 dBW/kg

Additional information:

ambient temperature: 22.0°C; liquid temperature: 20.1°C

SystemPerformanceCheck-D600 HSL 2023-05-02

DUT: D600V3 - SN1015; Type: D600V3; Serial: SN1015

Communication System: UID 0, CW (0); Communication System Band: FullSpan (0.0 - 6000.0 MHz);

Frequency: 600 MHz; Communication System PAR: 0 dB; PMF: 1

Medium parameters used: $f = 600$ MHz; $\sigma = 0.872$ S/m; $\epsilon_r = 41.395$; $\rho = 1000$ kg/m³

Phantom section: Flat Section

Measurement Standard: DASYS5

DASY5 Configuration:

- Probe: EX3DV4 - SN7635; ConvF(10.75, 10.75, 10.75) @ 600 MHz; Calibrated: 18.01.2023
- Sensor-Surface: 1.4mm (Mechanical Surface Detection), $z = 1.0, 31.0$
- Electronics: DAE3 Sn413; Calibrated: 17.01.2023
- Phantom: ELI 4.0; Type: QDOVA001BB; Serial: 1046
- DASY52 52.10.4(1527); SEMCAD X 14.6.14(7483)

HSL750/d=15mm, Pin=1000 mW, dist=1.4mm/Area Scan (51x51x1): Interpolated

grid: $dx=1.500$ mm, $dy=1.500$ mm

Maximum value of SAR (interpolated) = 0.867 W/kg

HSL750/d=15mm, Pin=1000 mW, dist=1.4mm/Zoom Scan (7x7x7)/Cube 0:

Measurement grid: $dx=5$ mm, $dy=5$ mm, $dz=5$ mm

Reference Value = 32.49 V/m; Power Drift = -0.13 dB

Peak SAR (extrapolated) = 0.974 W/kg

SAR(1 g) = 0.609 W/kg; SAR(10 g) = 0.403 W/kg

Smallest distance from peaks to all points 3 dB below = 22 mm

Ratio of SAR at M2 to SAR at M1 = 63.2%

Maximum value of SAR (measured) = 0.827 W/kg

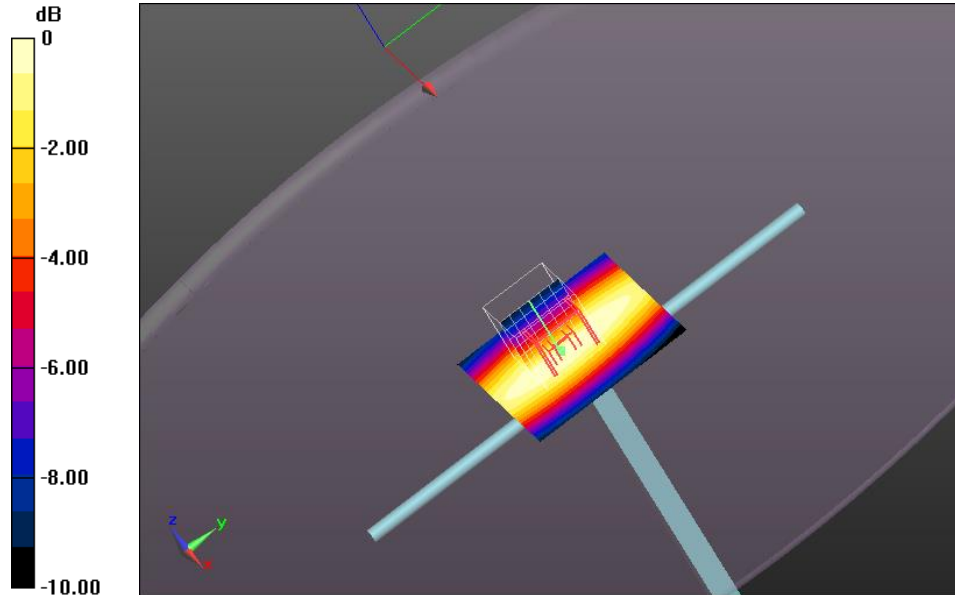

0 dB = 0.827 W/kg = -0.82 dBW/kg

Additional information:

ambient temperature: 22.1°C; liquid temperature: 20.0°C

SystemPerformanceCheck-D600 HSL 2023-05-03

DUT: D600V3 - SN1015; Type: D600V3; Serial: SN1015

Communication System: UID 0, CW (0); Communication System Band: FullSpan (0.0 - 6000.0 MHz);

Frequency: 600 MHz; Communication System PAR: 0 dB; PMF: 1

Medium parameters used: $f = 600$ MHz; $\sigma = 0.872$ S/m; $\epsilon_r = 41.395$; $\rho = 1000$ kg/m³

Phantom section: Flat Section

Measurement Standard: DASYS

DASY5 Configuration:

- Probe: EX3DV4 - SN7635; ConvF(10.75, 10.75, 10.75) @ 600 MHz; Calibrated: 18.01.2023
- Sensor-Surface: 1.4mm (Mechanical Surface Detection), $z = 1.0, 31.0$
- Electronics: DAE3 Sn413; Calibrated: 17.01.2023
- Phantom: ELI 4.0; Type: QDOVA001BB; Serial: 1046
- DASY52 52.10.4(1527); SEMCAD X 14.6.14(7483)

HSL750/d=15mm, Pin=1000 mW, dist=1.4mm/Area Scan (51x51x1): Interpolated

grid: $dx=1.500$ mm, $dy=1.500$ mm

Maximum value of SAR (interpolated) = 0.938 W/kg

HSL750/d=15mm, Pin=1000 mW, dist=1.4mm/Zoom Scan (7x8x7)/Cube 0:

Measurement grid: $dx=5$ mm, $dy=5$ mm, $dz=5$ mm

Reference Value = 34.40 V/m; Power Drift = -0.13 dB

Peak SAR (extrapolated) = 1.09 W/kg

SAR(1 g) = 0.682 W/kg; SAR(10 g) = 0.450 W/kg

Smallest distance from peaks to all points 3 dB below: Larger than measurement grid

Ratio of SAR at M2 to SAR at M1 = 62.9%

Maximum value of SAR (measured) = 0.936 W/kg

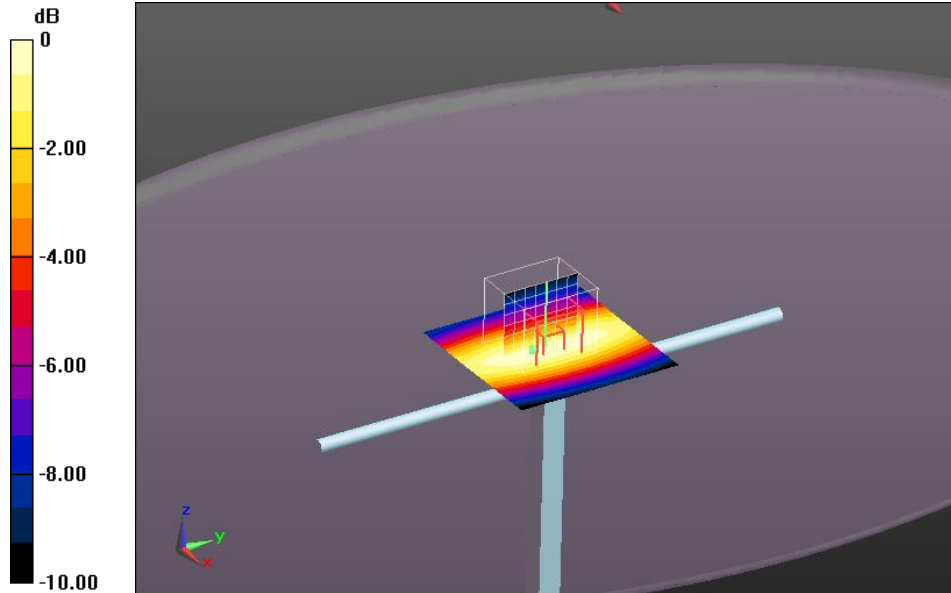

0 dB = 0.936 W/kg = -0.29 dBW/kg

Additional information:

ambient temperature: 22.3°C; liquid temperature: 20.5°C

SystemPerformanceCheck-D900-HSL 2022-05-03

DUT: D900MHz; Type: D900V2; Serial: 102

Communication System: UID 0, CW (0); Communication System Band: D900 (900.0 MHz); Frequency: 900 MHz; Communication System PAR: 0 dB; PMF: 1

Medium parameters used: $f = 900$ MHz; $\sigma = 0.966$ S/m; $\epsilon_r = 40.686$; $\rho = 1000$ kg/m³

Phantom section: Flat Section

Measurement Standard: DASYS

DASY5 Configuration:

- Probe: EX3DV4 - SN7635; ConvF(9.84, 9.81, 9.97) @ 900 MHz; Calibrated: 18.01.2023
- Sensor-Surface: 3mm (Mechanical Surface Detection), Sensor-Surface: 1.4mm (Mechanical Surface Detection), $z = 1.0, 31.0$
- Electronics: DAE3 Sn413; Calibrated: 17.01.2023
- Phantom: ELI 4.0; Type: QDOVA001BB; Serial: 1046
- DASY52 52.10.4(1527); SEMCAD X 14.6.14(7483)

HSL/d=15mm, Pin=100 mW, dist=1.4mm/Area Scan (41x41x1): Interpolated grid:

$dx=1.500$ mm, $dy=1.500$ mm

Maximum value of SAR (interpolated) = 1.35 W/kg

HSL/d=15mm, Pin=100 mW, dist=1.4mm/Zoom Scan (7x7x7)/Cube 0:

Measurement grid: $dx=5$ mm, $dy=5$ mm, $dz=5$ mm

Reference Value = 38.44 V/m; Power Drift = -0.09 dB

Peak SAR (extrapolated) = 1.56 W/kg

SAR(1 g) = 1.07 W/kg; SAR(10 g) = 0.699 W/kg

Smallest distance from peaks to all points 3 dB below = 19.2 mm

Ratio of SAR at M2 to SAR at M1 = 68.3%

Maximum value of SAR (measured) = 1.41 W/kg

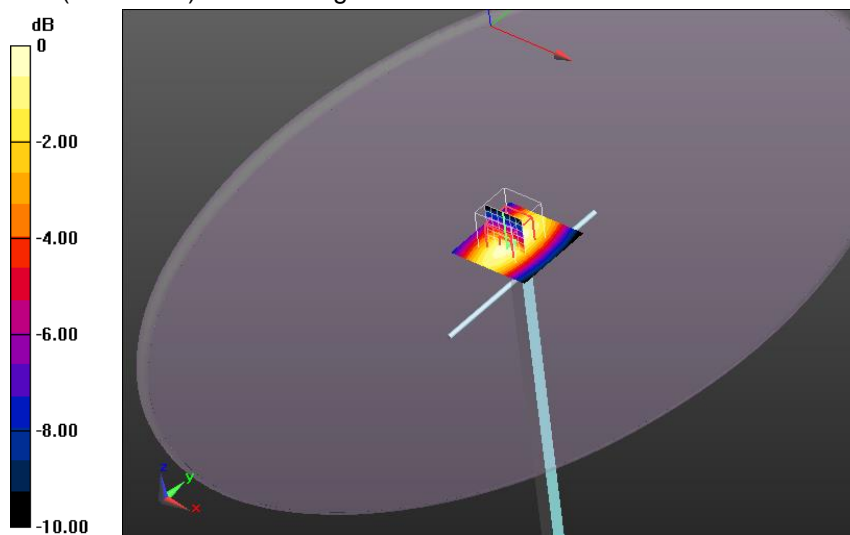

0 dB = 1.41 W/kg = 1.49 dBW/kg

Additional information:

ambient temperature: 22.3°C; liquid temperature: 20.5°C

SystemPerformanceCheck-D1750 HSL 2023-05-04

DUT: D1750; Type: D1750V2; Serial: 1093

Communication System: UID 0, CW (0); Communication System Band: D1750 (1750.0 MHz); Frequency: 1750 MHz; Communication System PAR: 0 dB; PMF: 1

Medium parameters used: $f = 1750$ MHz; $\sigma = 1.372$ S/m; $\epsilon_r = 38.593$; $\rho = 1000$ kg/m³

Phantom section: Flat Section

Measurement Standard: DASY5

DASY5 Configuration:

- Probe: EX3DV4 - SN7635; ConvF(8.83, 8.6, 9.03) @ 1750 MHz; Calibrated: 18.01.2023
- Sensor-Surface: 1.4mm (Mechanical Surface Detection), $z = 1.0, 31.0$
- Electronics: DAE3 Sn413; Calibrated: 17.01.2023
- Phantom: ELI 4.0; Type: QDOVA001BB; Serial: 1046
- DASY52 52.10.4(1527); SEMCAD X 14.6.14(7483)

HSL1750/d=10mm, Pin=100 mW, dist=1.4mm/Area Scan (41x41x1): Interpolated grid: $dx=1.500$ mm, $dy=1.500$ mm

Maximum value of SAR (interpolated) = 5.61 W/kg

HSL1750/d=10mm, Pin=100 mW, dist=1.4mm/Zoom Scan (6x6x7)/Cube 0:

Measurement grid: $dx=6$ mm, $dy=6$ mm, $dz=5$ mm

Reference Value = 66.27 V/m; Power Drift = -0.00 dB

Peak SAR (extrapolated) = 6.52 W/kg

SAR(1 g) = 3.62 W/kg; SAR(10 g) = 1.92 W/kg

Smallest distance from peaks to all points 3 dB below = 10.7 mm

Ratio of SAR at M2 to SAR at M1 = 57%

Maximum value of SAR (measured) = 5.25 W/kg

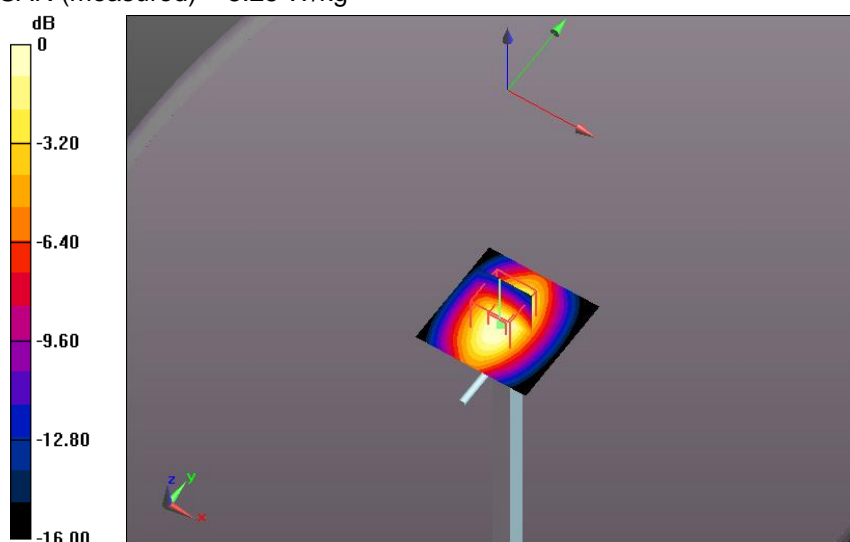

0 dB = 5.25 W/kg = 7.20 dBW/kg

Additional information:

ambient temperature: 22.5°C; liquid temperature: 21.3°C

SystemPerformanceCheck-D2450 HSL 2023-05-05

DUT: D2450; Type: D2450V2; Serial: 710

Communication System: UID 0, CW (0); Communication System Band: D2450 (2450.0 MHz); Frequency: 2450 MHz; Communication System PAR: 0 dB; PMF: 1

Medium parameters used (interpolated): $f = 2450$ MHz; $\sigma = 1.772$ S/m; $\epsilon_r = 37.681$; $\rho = 1000$ kg/m³

Phantom section: Flat Section

Measurement Standard: DASY5

DASY5 Configuration:

- Probe: EX3DV4 - SN7635; ConvF(7.72, 7.53, 7.77) @ 2450 MHz; Calibrated: 18.01.2023
- Sensor-Surface: 3mm (Mechanical Surface Detection), Sensor-Surface: 1.4mm (Mechanical Surface Detection), $z = 1.0, 26.0$
- Electronics: DAE3 Sn413; Calibrated: 17.01.2023
- Phantom: ELI 4.0; Type: QDOVA001BB; Serial: 1046
- DASY52 52.10.4(1527); SEMCAD X 14.6.14(7483)

HSL/d=10mm, Pin=100 mW, dist=1.4mm/Area Scan (51x51x1): Interpolated grid:

$dx=1.200$ mm, $dy=1.200$ mm

Maximum value of SAR (interpolated) = 9.41 W/kg

HSL/d=10mm, Pin=100 mW, dist=1.4mm/Zoom Scan (7x7x7)/Cube 0:

Measurement grid: $dx=5$ mm, $dy=5$ mm, $dz=5$ mm

Reference Value = 75.62 V/m; Power Drift = -0.02 dB

Peak SAR (extrapolated) = 11.8 W/kg

SAR(1 g) = 5.63 W/kg; SAR(10 g) = 2.61 W/kg

Smallest distance from peaks to all points 3 dB below = 9 mm

Ratio of SAR at M2 to SAR at M1 = 47.5%

Maximum value of SAR (measured) = 9.55 W/kg

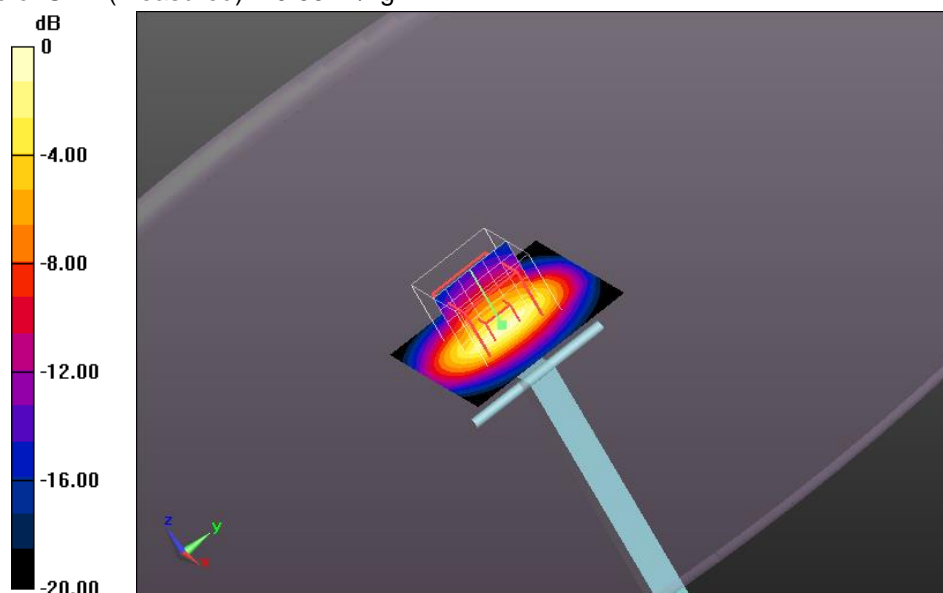

0 dB = 9.55 W/kg = 9.80 dBW/kg

Additional information:

ambient temperature: 22.3°C; liquid temperature: 21.0°C

Annex B: DASY measurement results

SAR plots for the **highest measured SAR** in each exposure configuration, wireless mode and frequency band combination according to FCC KDB 865664 D02

Date/Time: 27.04.2023 14:49:15

UHF Q1-6

DUT: Sennheiser; Type: EW-DP SKP (Q1-6); Serial: 1123000123

Communication System: UID 0, FM (0); Communication System Band: FM-510; Frequency: 470.2 MHz;

Communication System PAR: 0 dB; PMF: 1.12202e-005

Medium parameters used (interpolated): $f = 470.2$ MHz; $\sigma = 0.794$ S/m; $\epsilon_r = 42.234$; $\rho = 1000$ kg/m³

Phantom section: Flat Section

Measurement Standard: DASY5

DASY5 Configuration:

- Probe: EX3DV4 - SN7635; ConvF(11.6, 11.6, 11.6) @ 470.2 MHz; Calibrated: 18.01.2023
- Sensor-Surface: 1.4mm (Mechanical Surface Detection (Locations From Previous Scan Used)), Sensor-Surface: 1.4mm (Mechanical Surface Detection), $z = 1.0, 26.0$
- Electronics: DAE3 Sn413; Calibrated: 17.01.2023
- Phantom: ELI 4.0; Type: QDOVA001BB; Serial: 1046
- DASY52 52.10.4(1527); SEMCAD X 14.6.14(7483)

EW-DP SKP/Back position - 470.2 MHz/Area Scan (71x261x1): Interpolated grid:
dx=1.500 mm, dy=1.500 mm

Maximum value of SAR (interpolated) = 0.0797 W/kg

EW-DP SKP/Back position - 470.2 MHz/Zoom Scan (7x7x7)/Cube 0: Measurement grid: dx=6mm, dy=6mm, dz=5mm

Reference Value = 9.942 V/m; Power Drift = 0.04 dB

Peak SAR (extrapolated) = 0.151 W/kg

SAR(1 g) = 0.040 W/kg; SAR(10 g) = 0.018 W/kg

Smallest distance from peaks to all points 3 dB below: Larger than measurement grid

Ratio of SAR at M2 to SAR at M1 = 25.7%

Maximum value of SAR (measured) = 0.0767 W/kg

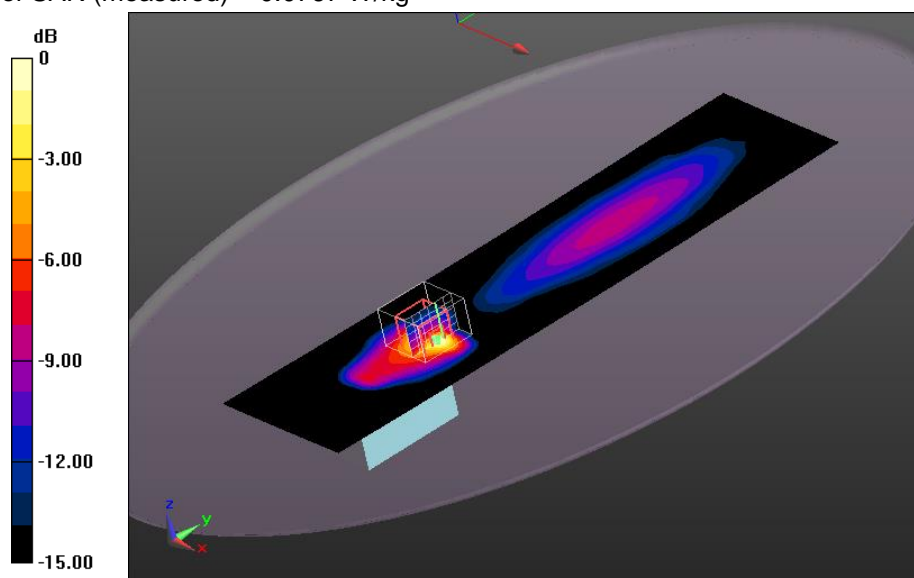

0 dB = 0.0767 W/kg = -11.15 dBW/kg

Additional information:

position or distance of DUT to SAM: 0 mm

ambient temperature: 22.2°C; liquid temperature: 20.3°C

UHF R1-6

DUT: Sennheiser; Type: EW-DP SKP (R1-6); Serial: 1123000023

Communication System: UID 0, UHF (0); Communication System Band: UHF; Frequency: 576 MHz;

Communication System PAR: 0 dB; PMF: 1.12202e-005

Medium parameters used (interpolated): $f = 576$ MHz; $\sigma = 0.825$ S/m; $\epsilon_r = 41.865$; $\rho = 1000$ kg/m³

Phantom section: Flat Section

Measurement Standard: DASY5

DASY5 Configuration:

- Probe: EX3DV4 - SN7635; ConvF(10.75, 10.75, 10.75) @ 576 MHz; Calibrated: 18.01.2023
- Sensor-Surface: 1.4mm (Mechanical Surface Detection (Locations From Previous Scan Used)), Sensor-Surface: 1.4mm (Mechanical Surface Detection), $z = 1.0, 26.0$
- Electronics: DAE3 Sn413; Calibrated: 17.01.2023
- Phantom: ELI 4.0; Type: QDOVA001BB; Serial: 1046
- DASY52 52.10.4(1527); SEMCAD X 14.6.14(7483)

EW-DP SKP/Left position - 576 MHz/Area Scan (71x261x1): Interpolated grid:

$dx=1.500$ mm, $dy=1.500$ mm

Maximum value of SAR (interpolated) = 0.126 W/kg

EW-DP SKP/Left position - 576 MHz/Zoom Scan (7x7x7)/Cube 0: Measurement grid:

$dx=6$ mm, $dy=6$ mm, $dz=5$ mm

Reference Value = 10.46 V/m; Power Drift = -0.09 dB

Peak SAR (extrapolated) = 0.159 W/kg

SAR(1 g) = 0.050 W/kg; SAR(10 g) = 0.027 W/kg

Smallest distance from peaks to all points 3 dB below = 6.8 mm

Ratio of SAR at M2 to SAR at M1 = 31.5%

Maximum value of SAR (measured) = 0.0967 W/kg

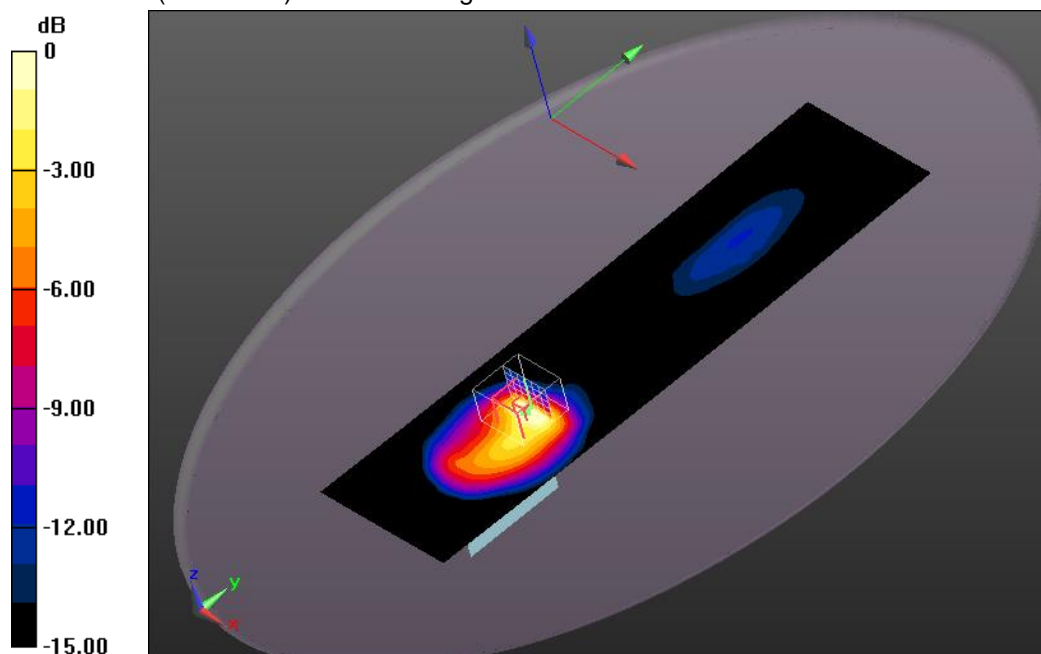

0 dB = 0.0967 W/kg = -10.15 dBW/kg

Additional information:

position or distance of DUT to SAM: 0 mm

ambient temperature: 22.0°C; liquid temperature: 20.1°C

UHF R4-9

DUT: Sennheiser; Type: EW-DP SKP (R4-9); Serial: 1123000033

Communication System: UID 0, UHF (0); Communication System Band: UHF; Frequency: 576 MHz;

Communication System PAR: 0 dB; PMF: 1.12202e-005

Medium parameters used (interpolated): $f = 576$ MHz; $\sigma = 0.825$ S/m; $\epsilon_r = 41.865$; $\rho = 1000$ kg/m³

Phantom section: Flat Section

Measurement Standard: DASY5

DASY5 Configuration:

- Probe: EX3DV4 - SN7635; ConvF(10.75, 10.75, 10.75) @ 576 MHz; Calibrated: 18.01.2023
- Sensor-Surface: 1.4mm (Mechanical Surface Detection (Locations From Previous Scan Used)), Sensor-Surface: 1.4mm (Mechanical Surface Detection), $z = 1.0, 26.0$
- Electronics: DAE3 Sn413; Calibrated: 17.01.2023
- Phantom: ELI 4.0; Type: QDOVA001BB; Serial: 1046
- DASY52 52.10.4(1527); SEMCAD X 14.6.14(7483)

EW-DP SKP/Right position - 576 MHz/Area Scan (71x261x1): Interpolated grid:

$dx=1.500$ mm, $dy=1.500$ mm

Maximum value of SAR (interpolated) = 0.0904 W/kg

EW-DP SKP/Right position - 576 MHz/Zoom Scan (6x6x7)/Cube 0: Measurement

grid: $dx=6$ mm, $dy=6$ mm, $dz=5$ mm

Reference Value = 10.42 V/m; Power Drift = -0.01 dB

Peak SAR (extrapolated) = 0.220 W/kg

SAR(1 g) = 0.059 W/kg; SAR(10 g) = 0.027 W/kg

Smallest distance from peaks to all points 3 dB below = 6.3 mm

Ratio of SAR at M2 to SAR at M1 = 30.8%

Maximum value of SAR (measured) = 0.122 W/kg

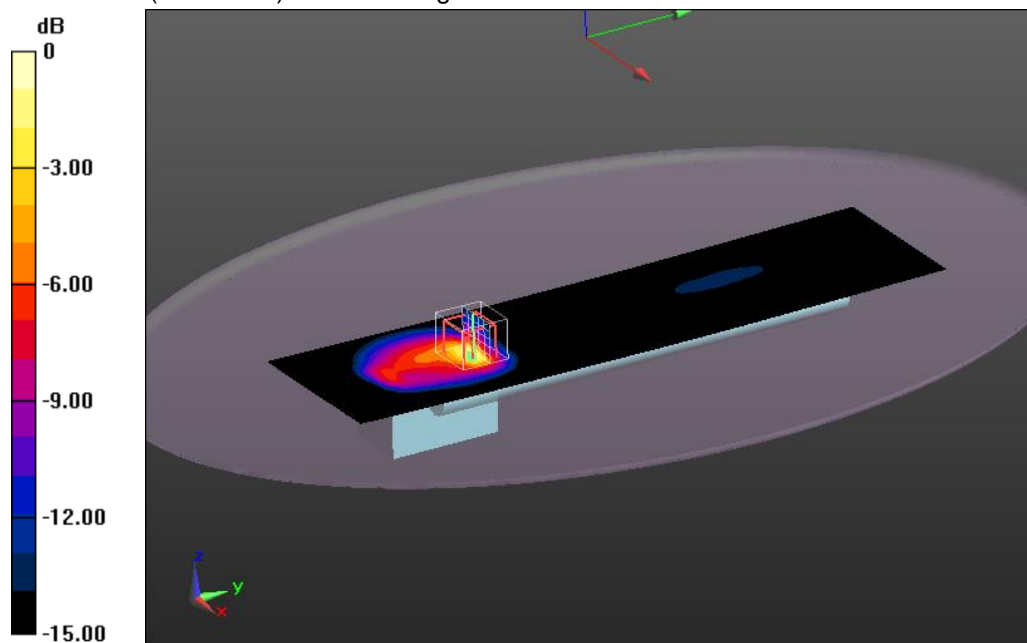

0 dB = 0.122 W/kg = -9.14 dBW/kg

Additional information:

position or distance of DUT to SAM: 0 mm

ambient temperature: 22.0°C; liquid temperature: 20.1°C

UHF S1-7

DUT: Sennheiser; Type: EW-DP SKP (S1-7); Serial: 1123000029

Communication System: UID 0, UHF (0); Communication System Band: UHF; Frequency: 662 MHz;

Communication System PAR: 0 dB; PMF: 1.12202e-005

Medium parameters used (interpolated): $f = 662$ MHz; $\sigma = 0.851$ S/m; $\epsilon_r = 41.59$; $\rho = 1000$ kg/m³

Phantom section: Flat Section

Measurement Standard: DASYS5

DASY5 Configuration:

- Probe: EX3DV4 - SN7635; ConvF(10.75, 10.75, 10.75) @ 662 MHz; Calibrated: 18.01.2023
- Sensor-Surface: 1.4mm (Mechanical Surface Detection (Locations From Previous Scan Used)), Sensor-Surface: 1.4mm (Mechanical Surface Detection), $z = 1.0, 26.0$
- Electronics: DAE3 Sn413; Calibrated: 17.01.2023
- Phantom: ELI 4.0; Type: QDOVA001BB; Serial: 1046
- DASY52 52.10.4(1527); SEMCAD X 14.6.14(7483)

EW-DP SKP/Back position - 662MHz/Area Scan (71x261x1): Interpolated grid:

$dx=1.500$ mm, $dy=1.500$ mm

Maximum value of SAR (interpolated) = 0.154 W/kg

EW-DP SKP/Back position - 662MHz/Zoom Scan (6x6x7)/Cube 0: Measurement

grid: $dx=6$ mm, $dy=6$ mm, $dz=5$ mm

Reference Value = 11.50 V/m; Power Drift = -0.05 dB

Peak SAR (extrapolated) = 0.216 W/kg

SAR(1 g) = 0.063 W/kg; SAR(10 g) = 0.031 W/kg

Smallest distance from peaks to all points 3 dB below = 3.6 mm

Ratio of SAR at M2 to SAR at M1 = 39.2%

Maximum value of SAR (measured) = 0.109 W/kg

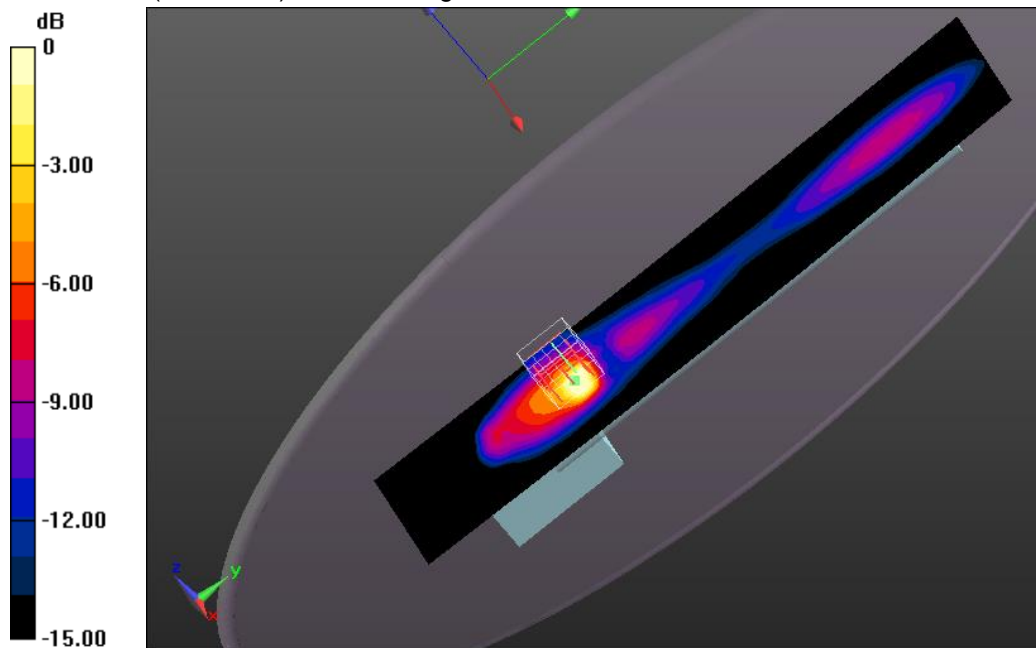

0 dB = 0.109 W/kg = -9.63 dBW/kg

Additional information:

position or distance of DUT to SAM: 0 mm

ambient temperature: 22.0°C; liquid temperature: 20.1°C

UHF S4-7

DUT: Sennheiser; Type: EW-DP SKP (S4-7); Serial: 1123000029

Communication System: UID 0, UHF (0); Communication System Band: UHF; Frequency: 662 MHz;

Communication System PAR: 0 dB; PMF: 1.12202e-005

Medium parameters used (interpolated): $f = 662$ MHz; $\sigma = 0.851$ S/m; $\epsilon_r = 41.59$; $\rho = 1000$ kg/m³

Phantom section: Flat Section

Measurement Standard: DASY5

DASY5 Configuration:

- Probe: EX3DV4 - SN7635; ConvF(10.75, 10.75, 10.75) @ 662 MHz; Calibrated: 18.01.2023
- Sensor-Surface: 1.4mm (Mechanical Surface Detection (Locations From Previous Scan Used)), Sensor-Surface: 1.4mm (Mechanical Surface Detection), $z = 1.0, 26.0$
- Electronics: DAE3 Sn413; Calibrated: 17.01.2023
- Phantom: ELI 4.0; Type: QDOVA001BB; Serial: 1046
- DASY52 52.10.4(1527); SEMCAD X 14.6.14(7483)

EW-DP SKP/Back position - 662MHz/Area Scan (71x261x1): Interpolated grid:

$dx=1.500$ mm, $dy=1.500$ mm

Maximum value of SAR (interpolated) = 0.132 W/kg

EW-DP SKP/Back position - 662MHz/Zoom Scan (6x7x7)/Cube 0: Measurement

grid: $dx=6$ mm, $dy=6$ mm, $dz=5$ mm

Reference Value = 11.13 V/m; Power Drift = 0.00 dB

Peak SAR (extrapolated) = 0.237 W/kg

SAR(1 g) = 0.065 W/kg; SAR(10 g) = 0.030 W/kg

Smallest distance from peaks to all points 3 dB below = 3.6 mm

Ratio of SAR at M2 to SAR at M1 = 37.3%

Maximum value of SAR (measured) = 0.112 W/kg

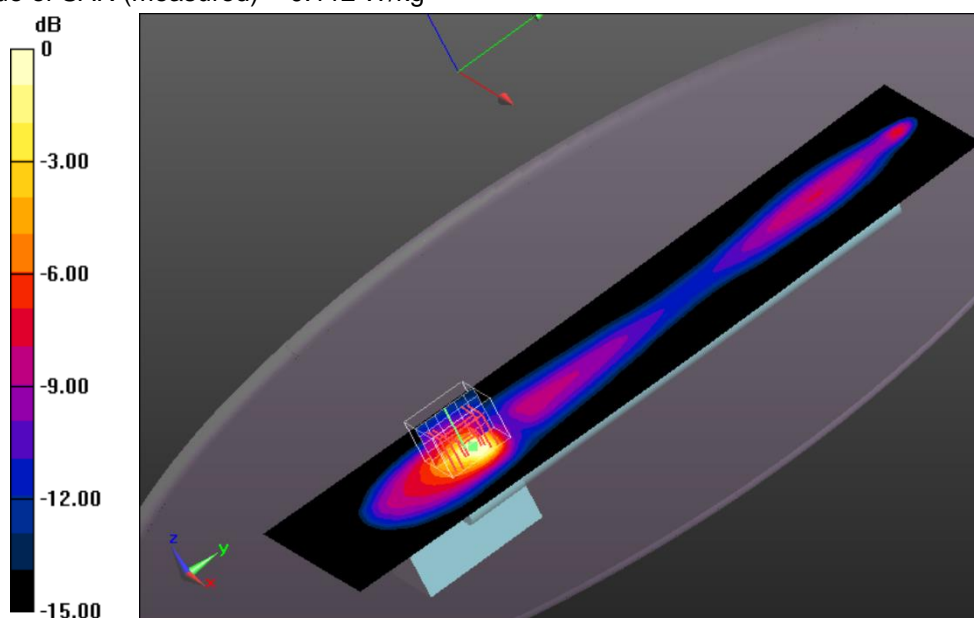

0 dB = 0.112 W/kg = -9.51 dBW/kg

Additional information:

position or distance of DUT to SAM: 0 mm

ambient temperature: 22.1°C; liquid temperature: 20.0°C

UHF S7-10

DUT: Sennheiser; Type: EW-DP SKP (S7-10); Serial: 1123000031

Communication System: UID 0, UHF (0); Communication System Band: UHF; Frequency: 678 MHz;

Communication System PAR: 0 dB; PMF: 1.12202e-005

Medium parameters used (interpolated): $f = 678$ MHz; $\sigma = 0.894$ S/m; $\epsilon_r = 41.132$; $\rho = 1000$ kg/m³

Phantom section: Flat Section

Measurement Standard: DASYS

DASY5 Configuration:

- Probe: EX3DV4 - SN7635; ConvF(10.75, 10.75, 10.75) @ 678 MHz; Calibrated: 18.01.2023

- Sensor-Surface: 1.4mm (Mechanical Surface Detection), $z = 1.0, 26.0$

- Electronics: DAE3 Sn413; Calibrated: 17.01.2023

- Phantom: ELI 4.0; Type: QDOVA001BB; Serial: 1046

- DASY52 52.10.4(1527); SEMCAD X 14.6.14(7483)

EW-DP SKP/Front position - 678MHz/Area Scan (71x261x1): Interpolated grid:

$dx=1.500$ mm, $dy=1.500$ mm

Maximum value of SAR (interpolated) = 0.0680 W/kg

EW-DP SKP/Front position - 678MHz/Zoom Scan (7x7x7)/Cube 0: Measurement

grid: $dx=6$ mm, $dy=6$ mm, $dz=5$ mm

Reference Value = 6.795 V/m; Power Drift = -0.07 dB

Peak SAR (extrapolated) = 0.0700 W/kg

SAR(1 g) = 0.042 W/kg; SAR(10 g) = 0.028 W/kg

Smallest distance from peaks to all points 3 dB below: Larger than measurement grid

Ratio of SAR at M2 to SAR at M1 = 57.7%

Maximum value of SAR (measured) = 0.0580 W/kg

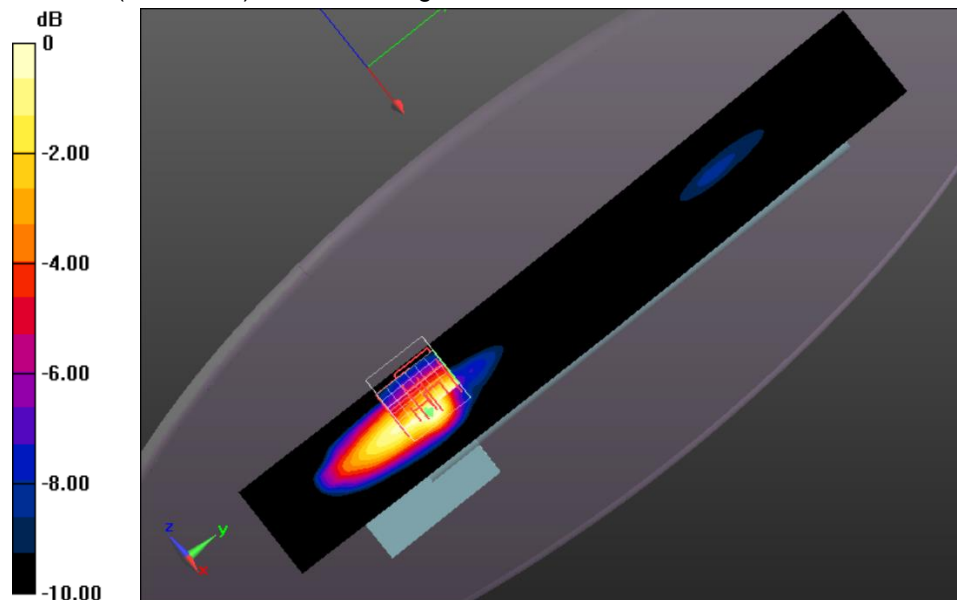

0 dB = 0.0580 W/kg = -12.37 dBW/kg

Additional information:

position or distance of DUT to SAM: 0 mm

ambient temperature: 22.3°C; liquid temperature: 20.5°C

UHF U1/5

DUT: Sennheiser; Type: EW-DP SKP (U1/5); Serial: 1123000039

Communication System: UID 0, UHF (0); Communication System Band: UHF; Frequency: 864 MHz;

Communication System PAR: 0 dB; PMF: 1.12202e-005

Medium parameters used (interpolated): $f = 864$ MHz; $\sigma = 0.953$ S/m; $\epsilon_r = 40.74$; $\rho = 1000$ kg/m³

Phantom section: Flat Section

Measurement Standard: DASYS5

DASY5 Configuration:

- Probe: EX3DV4 - SN7635; ConvF(10.23, 10.04, 10.26) @ 864 MHz; Calibrated: 18.01.2023
- Sensor-Surface: 1.4mm (Mechanical Surface Detection (Locations From Previous Scan Used)), Sensor-Surface: 1.4mm (Mechanical Surface Detection), $z = 1.0, 26.0$
- Electronics: DAE3 Sn413; Calibrated: 17.01.2023
- Phantom: ELI 4.0; Type: QDOVA001BB; Serial: 1046
- DASY52 52.10.4(1527); SEMCAD X 14.6.14(7483)

EW-DP SKP/Left position -864MHz/Area Scan (71x261x1): Interpolated grid: $dx=1.500$ mm, $dy=1.500$ mm

Maximum value of SAR (interpolated) = 0.0751 W/kg

EW-DP SKP/Left position -864MHz/Zoom Scan (6x6x7)/Cube 0: Measurement grid: $dx=6$ mm, $dy=6$ mm, $dz=5$ mm

Reference Value = 8.726 V/m; Power Drift = 0.08 dB

Peak SAR (extrapolated) = 0.0910 W/kg

SAR(1 g) = 0.052 W/kg; SAR(10 g) = 0.030 W/kg

Smallest distance from peaks to all points 3 dB below: Larger than measurement grid

Ratio of SAR at M2 to SAR at M1 = 57.4%

Maximum value of SAR (measured) = 0.0761 W/kg

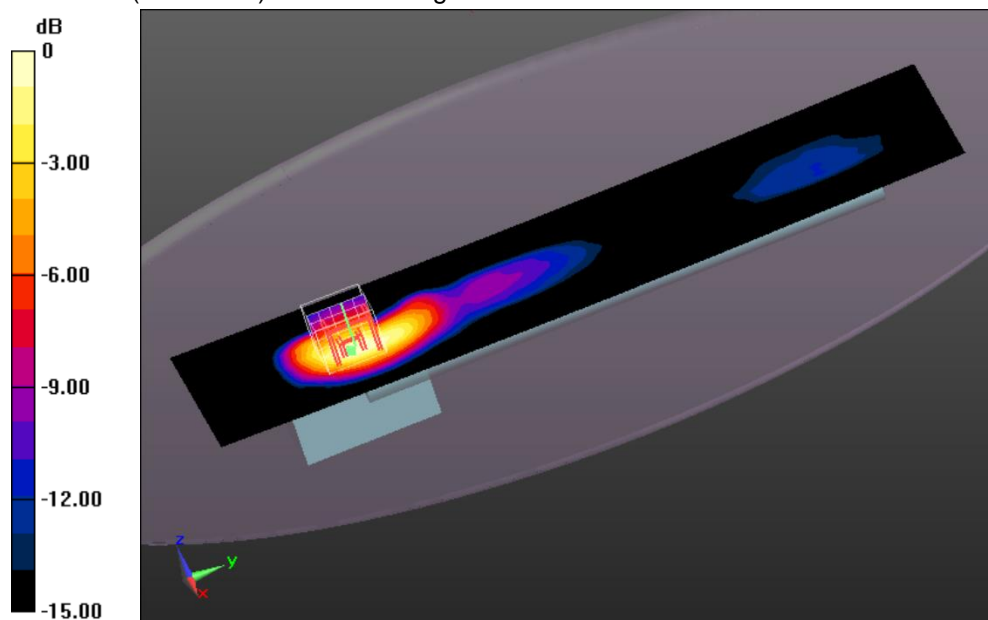

0 dB = 0.0761 W/kg = -11.19 dBW/kg

Additional information:

position or distance of DUT to SAM: 0 mm

ambient temperature: 22.3°C; liquid temperature: 20.5°C

UHF Y1-3

DUT: Sennheiser; Type: EW-DP SKP (Y1-3); Serial: 1123000059

Communication System: UID 0, UHF (0); Communication System Band: UHF; Frequency: 1799.7 MHz;

Communication System PAR: 0 dB; PMF: 1.12202e-005

Medium parameters used: $f = 1800$ MHz; $\sigma = 1.399$ S/m; $\epsilon_r = 38.553$; $\rho = 1000$ kg/m³

Phantom section: Flat Section

Measurement Standard: DASYS5

DASY5 Configuration:

- Probe: EX3DV4 - SN7635; ConvF(8.83, 8.6, 9.03) @ 1799.7 MHz; Calibrated: 18.01.2023
- Sensor-Surface: 1.4mm (Mechanical Surface Detection (Locations From Previous Scan Used)), Sensor-Surface: 1.4mm (Mechanical Surface Detection), $z = 1.0, 31.0$
- Electronics: DAE3 Sn413; Calibrated: 17.01.2023
- Phantom: ELI 4.0; Type: QDOVA001BB; Serial: 1046
- DASY52 52.10.4(1527); SEMCAD X 14.6.14(7483)

EW-DP SKP/Left position - 1799.7MHz/Area Scan (71x261x1): Interpolated grid:

$dx=1.500$ mm, $dy=1.500$ mm

Maximum value of SAR (interpolated) = 0.248 W/kg

EW-DP SKP/Left position - 1799.7MHz/Zoom Scan (7x7x7)/Cube 0: Measurement

grid: $dx=6$ mm, $dy=6$ mm, $dz=5$ mm

Reference Value = 9.507 V/m; Power Drift = 0.11 dB

Peak SAR (extrapolated) = 0.245 W/kg

SAR(1 g) = 0.113 W/kg; SAR(10 g) = 0.051 W/kg

Smallest distance from peaks to all points 3 dB below = 8 mm

Ratio of SAR at M2 to SAR at M1 = 51.6%

Maximum value of SAR (measured) = 0.180 W/kg

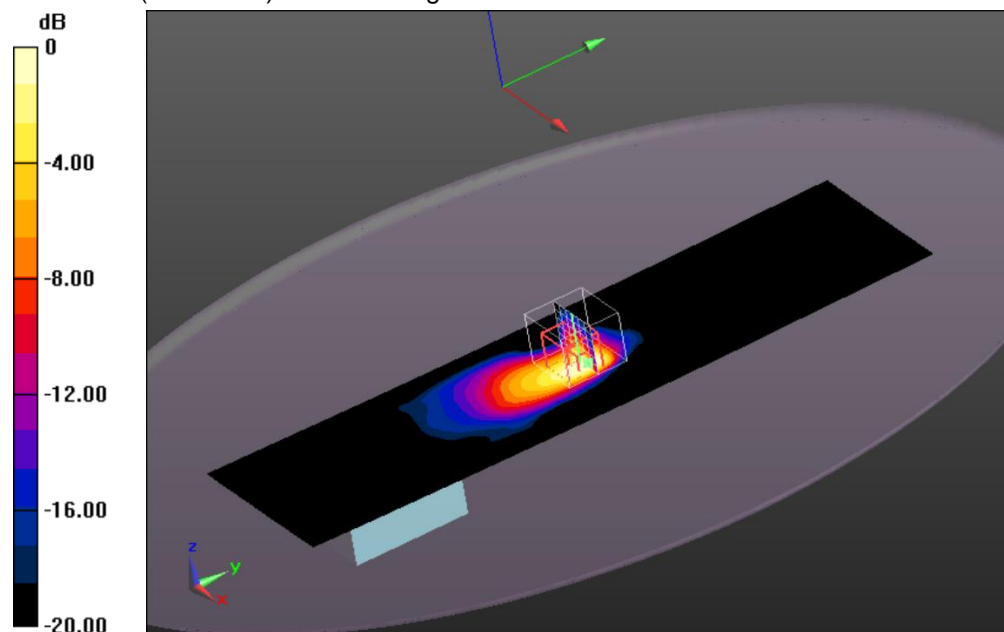

0 dB = 0.180 W/kg = -7.45 dBW/kg

Additional information:

position or distance of DUT to SAM: 0 mm

ambient temperature: 22.5°C; liquid temperature: 21.3°C

BT LE 2450**DUT: Sennheiser; Type: EW-DP SKP (Q1-6); Serial: 1123000127**Communication System: UID 0, Bluetooth LE (0); Communication System Band: BT LE; Frequency: 2440 MHz;
Communication System PAR: 1.67 dB; PMF: 1.21199Medium parameters used (interpolated): $f = 2440$ MHz; $\sigma = 1.767$ S/m; $\epsilon_r = 37.692$; $\rho = 1000$ kg/m³

Phantom section: Flat Section

Measurement Standard: DASYS5

DASY5 Configuration:

- Probe: EX3DV4 - SN7635; ConvF(7.72, 7.53, 7.77) @ 2440 MHz; Calibrated: 18.01.2023
- Sensor-Surface: 1.4mm (Mechanical Surface Detection), $z = 1.0, 31.0$
- Electronics: DAE3 Sn413; Calibrated: 17.01.2023
- Phantom: ELI 4.0; Type: QDOVA001BB; Serial: 1046
- DASY52 52.10.4(1527); SEMCAD X 14.6.14(7483)

EW-DP SKP/Right position - 2440MHz/Area Scan (71x261x1): Interpolated grid:
 $dx=1.500$ mm, $dy=1.500$ mm

Maximum value of SAR (interpolated) = 0.189 W/kg

EW-DP SKP/Right position - 2440MHz/Zoom Scan (6x6x7)/Cube 0: Measurement
grid: $dx=6$ mm, $dy=6$ mm, $dz=5$ mm

Reference Value = 5.1 V/m; Power Drift = 0.00 dB

Peak SAR (extrapolated) = 0.419 W/kg

SAR(1 g) = 0.100 W/kg; SAR(10 g) = 0.043 W/kg

Smallest distance from peaks to all points 3 dB below = 5 mm

Ratio of SAR at M2 to SAR at M1 = 31.2%

Maximum value of SAR (measured) = 0.207 W/kg

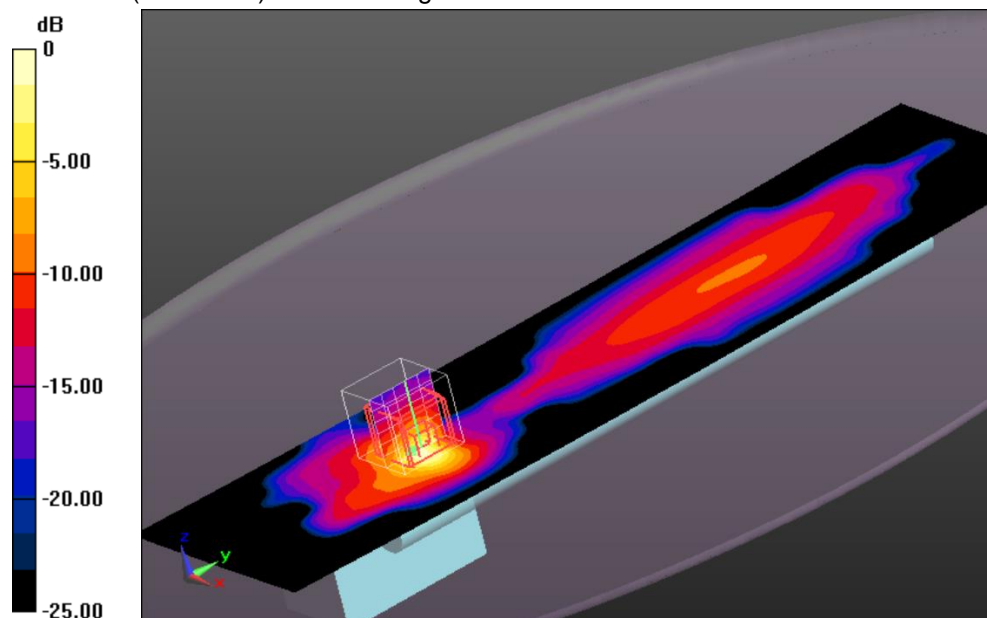

0 dB = 0.207 W/kg = -6.84 dBW/kg

Additional information:

position or distance of DUT to SAM: 0 mm

ambient temperature: 22.3°C; liquid temperature: 21.0°C

Annex B.1: Liquid depth

Photo 1: Liquid depth 600-6000 MHz head tissue simulating liquid

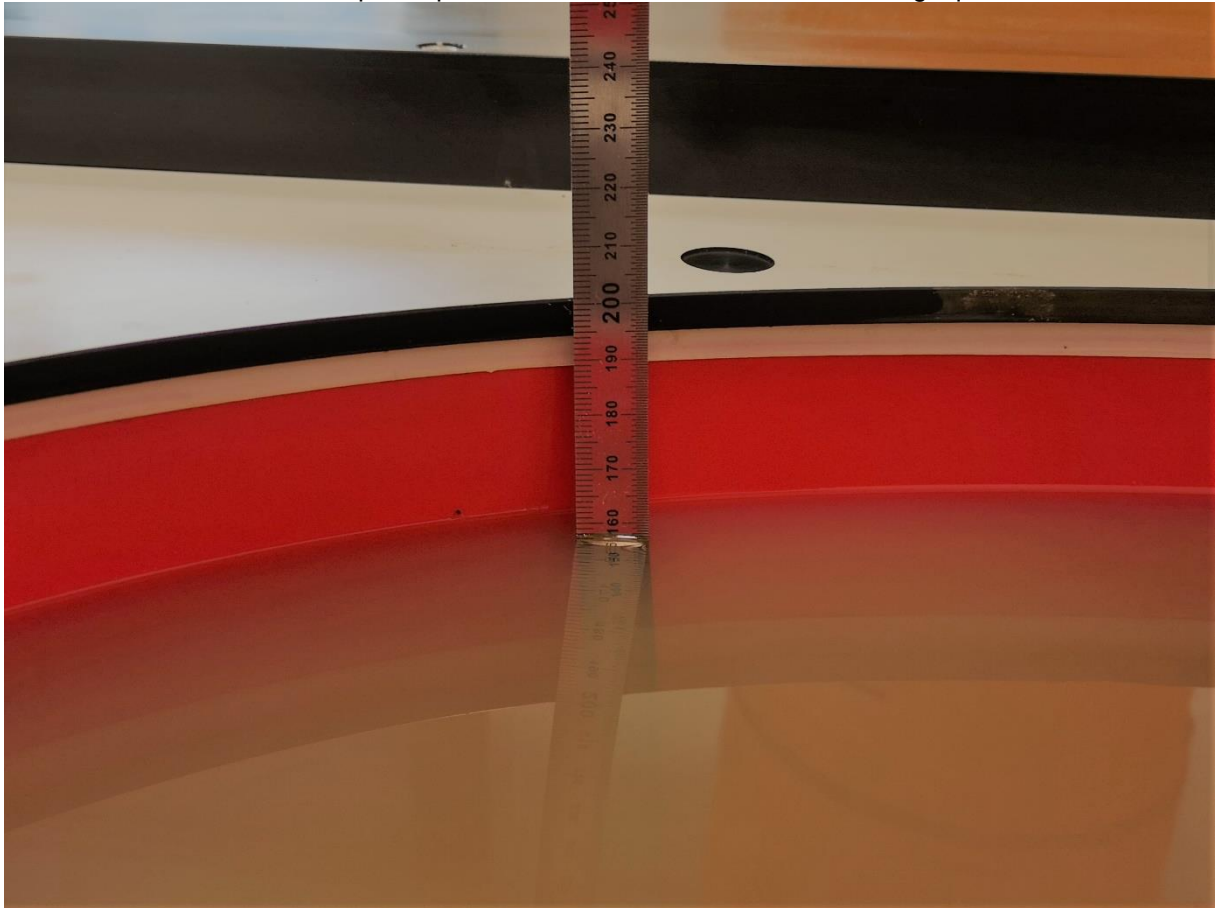

Annex C: Photo documentation

Photo documentation is described in the additional document:

Appendix to test report no. 1-1910/21-01-17 Photo documentation

Annex D: Calibration parameters

Calibration parameters are described in the additional document:

Appendix to test report no. 1-1910/21-01-17 Calibration data, Phantom certificate and detail information of the DASY System

Annex E: RSS-102 Annex A1

ISED RF documents are described in the additional document:

Appendix to test report no. 1-1910/21-01-17 RF Technical Brief Cover Sheet acc. To RSS-102 Annex A1.

Annex F: Document History

Version	Applied Changes	Date of Release
	Initial Release	2023-05-16

Annex G: Further Information

Glossary

DTS	-	Distributed Transmission System
DUT	-	Device under Test
EUT	-	Equipment under Test
FCC	-	Federal Communication Commission
FCC ID	-	Company Identifier at FCC
HW	-	Hardware
Inv. No.	-	Inventory number
ISED	-	Innovation, Science and Economic Development Canada
N/A	-	not applicable
PCE	-	Personal Consumption Expenditure
OET	-	Office of Engineering and Technology
SAR	-	Specific Absorption Rate
S/N	-	Serial Number
SW	-	Software