



## TEST REPORT

Test report no.: 1-2868/21-01-16-C

BNetzA-CAB-02/21-102

### Testing laboratory

**CTC advanced GmbH**

Untertuerkheimer Strasse 6 – 10

66117 Saarbruecken / Germany

Phone: + 49 681 5 98 - 0

Fax: + 49 681 5 98 - 9075

Internet: <https://www.ctcadvanced.com>

e-mail: [mail@ctcadvanced.com](mailto:mail@ctcadvanced.com)

**Accredited Testing Laboratory:**

The testing laboratory (area of testing) is accredited according to DIN EN ISO/IEC 17025 (2018-03) by the Deutsche Akkreditierungsstelle GmbH (DAkkS)

The accreditation is valid for the scope of testing procedures as stated in the accreditation certificate starting with the registration number: D-PL-12076-01.

### Applicant

**Sennheiser electronic GmbH & Co. KG**

Am Labor 1

30900 Wedemark / GERMANY

Phone: +49 5130 600-0

Contact: Ouajdi Ochi

e-mail: [Ouajdi.Ochi@sennheiser.com](mailto:Ouajdi.Ochi@sennheiser.com)

### Manufacturer

**Sennheiser electronic GmbH & Co. KG**

Am Labor 1

30900 Wedemark / GERMANY

### Test standard/s

FCC - Title 47 CFR Part 74      FCC - Title 47 of the Code of Federal Regulations; Chapter I; Part 74 - Experimental radio, auxiliary, special broadcast and other program distributional services

RSS - 123 Issue 4              Licensed Wireless Microphones

For further applied test standards please refer to section 3 of this test report.

### Test Item

**Test item description:**              **Handheld Transmitter**

**Model No.:**                              **EW-DX SKM**

**FCC ID:**                                  **DMOSKMSEWDX9M**

**IC:**                                         **2099A-SKMEWDX**

**Frequency:**                              941.7MHz – 951.8MHz / 953.05MHz – 956.05MHz / 956.65MHz – 959.65MHz

**Technology tested:**                    proprietary

**Antenna:**                                 internal PCB antenna

**Power supply:**                         2.50 V to 4.35 V DC by battery Li-Ion BA 70 or 2x AA type 1.50 V DC

**Temperature range:**                    -10°C to +50°C

This test report is electronically signed and valid without handwritten signature. For verification of the electronic signatures, the public keys can be requested at the testing laboratory.

### Test report authorized:

Christoph Schneider  
Lab Manager  
Radio Communications

### Test performed:

p.o.  
Tobias Wittenmeier  
Testing Manager  
Radio Communications

**1 Table of contents**

1 Table of contents .....2

2 General information .....3

    2.1 Notes and disclaimer .....3

    2.2 Application details .....3

    2.3 Test laboratories sub-contracted .....3

3 Test standard/s, references and accreditations .....4

4 Reporting statements of conformity – decision rule .....5

5 Test environment .....6

6 Test item.....6

    6.1 General description .....6

    6.2 Additional information .....7

7 Description of the test setup.....8

    7.1 Shielded fully anechoic chamber.....9

    7.2 Conducted measurements normal and extreme conditions.....10

8 Sequence of testing .....11

    8.1 Sequence of testing radiated spurious 30 MHz to 12.75 GHz .....11

9 Measurement uncertainty .....12

10 Summary of measurement results.....13

11 Additional comments .....14

12 Measurement results.....15

    12.1 Transmitter output power .....15

    12.2 Occupied bandwidth .....25

    12.3 Transmitter frequency stability .....34

    12.4 Transmitter unwanted emissions (radiated) .....38

    12.5 Necessary bandwidth (BN) for digital systems.....48

13 Observations .....55

14 Glossary .....56

15 Document history .....57

16 Accreditation Certificate – D-PL-12076-01-04 .....57

17 Accreditation Certificate – D-PL-12076-01-05 .....58

## 2 General information

### 2.1 Notes and disclaimer

The test results of this test report relate exclusively to the test item specified in this test report. CTC advanced GmbH does not assume responsibility for any conclusions and generalizations drawn from the test results with regard to other specimens or samples of the type of the equipment represented by the test item.

The test report may only be reproduced or published in full. Reproduction or publication of extracts from the report requires the prior written approval of CTC advanced GmbH.

The testing service provided by CTC advanced GmbH has been rendered under the current "General Terms and Conditions for CTC advanced GmbH".

CTC advanced GmbH will not be liable for any loss or damage resulting from false, inaccurate, inappropriate or incomplete product information provided by the customer.

Under no circumstances does the CTC advanced GmbH test report include any endorsement or warranty regarding the functionality, quality or performance of any other product or service provided.

Under no circumstances does the CTC advanced GmbH test report include or imply any product or service warranties from CTC advanced GmbH, including, without limitation, any implied warranties of merchantability, fitness for purpose, or non-infringement, all of which are expressly disclaimed by CTC advanced GmbH.

All rights and remedies regarding vendor's products and services for which CTC advanced GmbH has prepared this test report shall be provided by the party offering such products or services and not by CTC advanced GmbH. In no case this test report can be considered as a Letter of Approval.

This test report is electronically signed and valid without handwritten signature. For verification of the electronic signatures, the public keys can be requested at the testing laboratory.

**This test report replaces the test report with the number 1-2868/21-01-16-B and dated 2022-10-10**

### 2.2 Application details

Date of receipt of order: 2022-02-22

Date of receipt of test item: 2022-07-11

Start of test:\* 2022-07-11

End of test:\* 2022-08-03

Person(s) present during the test: -/-

\*Date of each measurement, if not shown in the plot, can be requested. Dates are stored in the measurement software.





### 2.3 Test laboratories sub-contracted

None

### 3 Test standard/s, references and accreditations

Test standard	Date	Description
FCC - Title 47 CFR Part 74		FCC - Title 47 of the Code of Federal Regulations; Chapter I; Part 74 - Experimental radio, auxiliary, special broadcast and other program distributional services
RSS - 123 Issue 4	August 2019	Licensed Wireless Microphones
ETSI EN 300 422-1 V1.4.2	2011-08	Electromagnetic compatibility and Radio spectrum Matters (ERM); Wireless microphones in the 25 MHz to 3 GHz frequency range; Part 1: Technical characteristics and methods of measurement

Guidance	Version	Description
ANSI C63.10-2013	-/-	American National Standard of Procedures for Compliance Testing of Unlicensed Wireless Devices

Accreditation	Description	
D-PL-12076-01-04	Telecommunication and EMC Canada <a href="https://www.dakks.de/as/ast/d/D-PL-12076-01-04e.pdf">https://www.dakks.de/as/ast/d/D-PL-12076-01-04e.pdf</a>	  Deutsche Akkreditierungsstelle D-PL-12076-01-04
D-PL-12076-01-05	Telecommunication FCC requirements <a href="https://www.dakks.de/as/ast/d/D-PL-12076-01-05e.pdf">https://www.dakks.de/as/ast/d/D-PL-12076-01-05e.pdf</a>	  Deutsche Akkreditierungsstelle D-PL-12076-01-05

ISED Testing Laboratory Recognized Listing Number: DE0001  
FCC designation number: DE0002

#### 4 Reporting statements of conformity – decision rule

Only the measured values related to their corresponding limits will be used to decide whether the equipment under test meets the requirements of the test standards listed in chapter 3.

The measurement uncertainty is mentioned in this test report, see chapter 9, but is not taken into account - neither to the limits nor to the measurement results. Measurement results with a smaller margin to the corresponding limits than the measurement uncertainty have a potential risk of more than 5% that the decision might be wrong."

measured value, measurement uncertainty, verdict

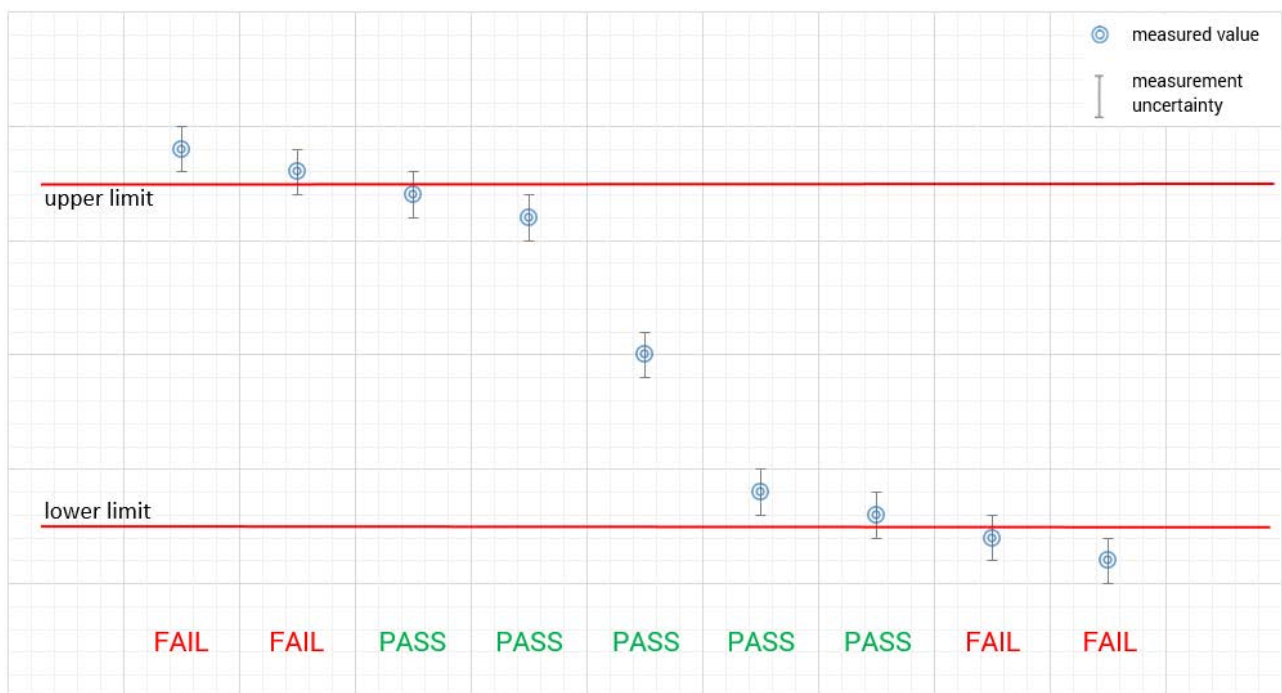

## 5 Test environment

Temperature	:	$T_{nom}$ +20 °C during room temperature tests $T_{max}$ +50 °C during high temperature tests $T_{min}$ -10 °C during low temperature tests
Relative humidity content	:	55 %
Barometric pressure	:	1021 hpa
Power supply	:	$V_{nom}$ 3.80 V DC by battery Li-Ion BA 70 or 2x AA type 1.50 V DC $V_{max}$ 4.35 V $V_{min}$ 2.50 V

## 6 Test item

### 6.1 General description

Test item description	:	Handheld Transmitter
Model No.	:	EW-DX SKM
Brand name	:	SENNHEISER
Serie	:	Evolution Wireless Digital
HMN	:	-/-
PMN	:	EW-DX SKM
HVIN	:	EW-DX SKM9M
FVIN	:	0.7.0
S/N serial number	:	1082000017
Hardware status	:	583750_07
Software status	:	-/-
Firmware status	:	0.7.0
Frequency band	:	941.7MHz – 951.8MHz / 953.05MHz – 956.05MHz / 956.65MHz – 959.65MHz
Type of radio transmission	:	modulated carrier
Use of frequency spectrum	:	
Type of modulation	:	PI/4 DQPSK
Number of channels	:	Tuning step size: 25 kHz
Antenna	:	internal PCB antenna
Power ratings	:	2.50 V to 4.35 V DC by battery Li-Ion BA 70 or 2x AA type 1.50 V DC
Operating temperature range	:	-10°C to +50°C

## 6.2 Additional information

The content of the following annexes is defined in the QA. It may be that not all of the listed annexes are necessary for this report, thus some values in between may be missing.

Test setup and EUT photos are included in test report:

- 1-2868/21-01-16\_AnnexA
- 1-2868/21-01-16\_AnnexB
- 1-2868/21-01-01\_AnnexD

## 7 Description of the test setup

Typically, the calibrations of the test apparatus are commissioned to and performed by an accredited calibration laboratory. The calibration intervals are determined in accordance with the DIN EN ISO/IEC 17025. In addition to the external calibrations, the laboratory executes comparison measurements with other calibrated test systems or effective verifications. Weekly chamber inspections and range calibrations are performed. Where possible, RF generating and signaling equipment as well as measuring receivers and analyzers are connected to an external high-precision 10 MHz reference (GPS-based or rubidium frequency standard).

In order to simplify the identification of the equipment used at some special tests, some items of test equipment and ancillaries can be provided with an identifier or number in the equipment list below (Lab/Item).

Each block diagram listed can contain several test setup configurations. All devices belonging to a test setup are identified with the same letter syntax. For example: Column Setup and all devices with an A.

### **Agenda:** Kind of Calibration

k	calibration / calibrated	EK	limited calibration
ne	not required (k, ev, izw, zw not required)	zw	cyclical maintenance (external cyclical maintenance)
ev	periodic self verification	izw	internal cyclical maintenance
Ve	long-term stability recognized	g	blocked for accredited testing
vlk!	Attention: extended calibration interval		
NK!	Attention: not calibrated	*)	next calibration ordered / currently in progress



## 7.1 Shielded fully anechoic chamber

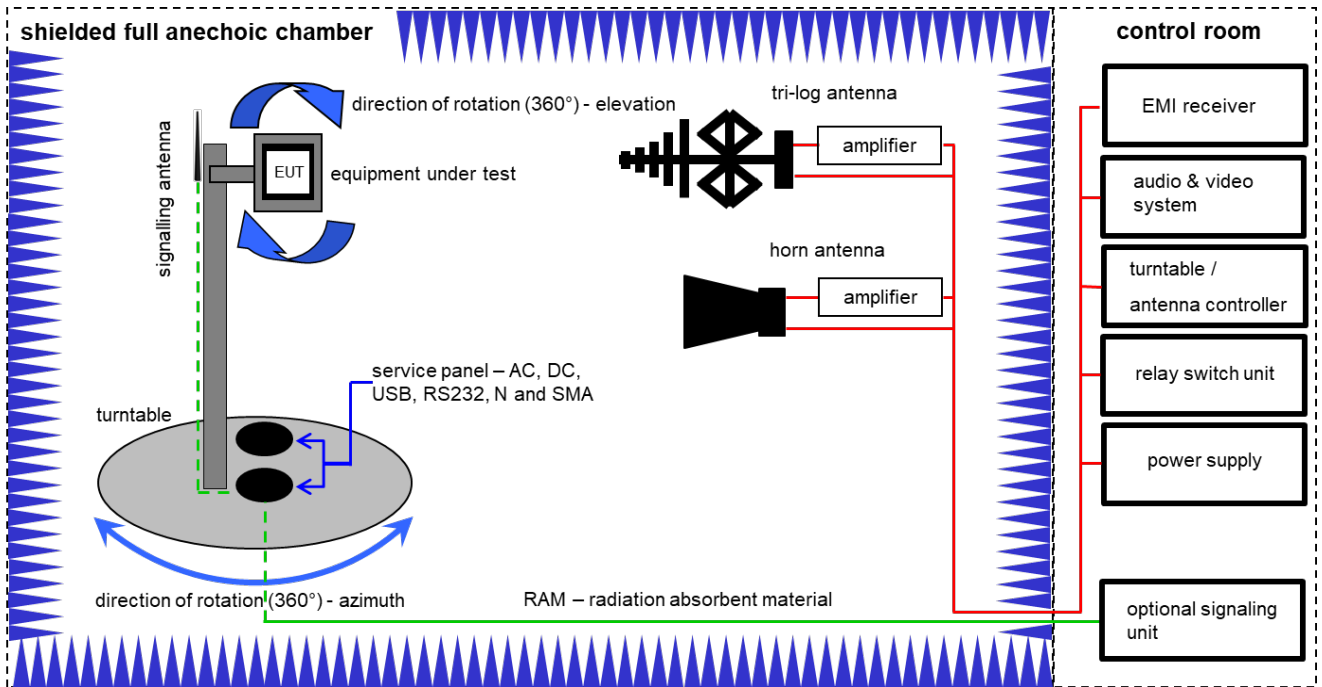

Measurement distance: tri-log antenna and horn antenna 3 meter

$$OP = AV + D - G + CA$$

(OP-radiated output power; AV-analyzer value; D-free field attenuation of measurement distance; G-antenna gain+amplifier gain; CA-loss signal path)

Example calculation:

$$OP [dBm] = -65.0 [dBm] + 50 [dB] - 20 [dBi] + 5 [dB] = -30 [dBm] (1 \mu W)$$

No.	Setup	Equipment	Type	Manufacturer	Serial No.	INV. No.	Kind of Calibration	Last Calibration	Next Calibration
1	A, B	Anechoic chamber	FAC 3/5m	MWB / TDK	87400/02	300000996	ev	-/-	-/-
2	A, B	Switch / Control Unit	3488A	HP	*	300000199	ne	-/-	-/-
3	B	Double-Ridged Waveguide Horn Antenna 1-18.0GHz	3115	EMCO	8812-3089	300000307	vKI!	11.02.2022	29.02.2024
4	A, B	EMI Test Receiver 20Hz- 26,5GHz	ESU26	R&S	100037	300003555	k	09.12.2021	31.12.2022
5	B	Highpass Filter	WHK1.1/15G-10SS	Wainwright	3	300003255	ev	-/-	-/-
6	A	TRILOG Broadband Test-Antenna 30 MHz - 3 GHz	VULB9163	Schwarzbeck Mess-Elektronik	318	300003696	vKI!	30.09.2021	29.09.2023
7	B	Broadband Amplifier 0.5-18 GHz	CBLU5184540	CERNEX	22049	300004481	ev	-/-	-/-
8	A, B	4U RF Switch Platform	L4491A	Agilent Technologies	MY50000037	300004509	ne	-/-	-/-
9	A, B	PC	ExOne	F+W		300004703	ne	-/-	-/-

## 7.2 Conducted measurements normal and extreme conditions

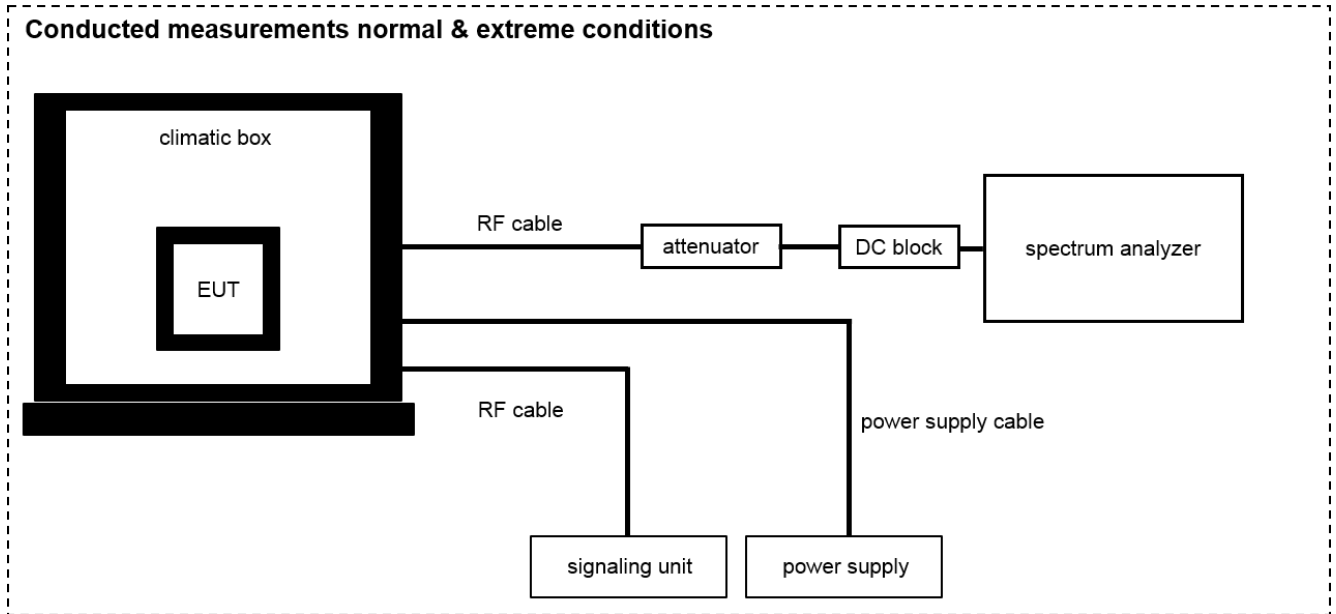

OP = AV + CA  
(OP-output power; AV-analyzer value; CA-loss signal path)

Example calculation:

OP [dBm] = 6.0 [dBm] + 11.7 [dB] = 17.7 [dBm] (58.88 mW)

**Equipment table:**

No.	Setup	Equipment	Type	Manufacturer	Serial No.	INV. No.	Kind of Calibration	Last Calibration	Next Calibration
1	B	Temperature Test Chamber	VT 4002	Heraeus Voetsch	521/83761	300002326	ev	12.05.2020	11.05.2022
2	A	Signal analyzer	FSW26	Rohde&Schwarz	101455	300004528	k	14.12.2021	31.12.2022
3	A	Power Supply	HMP2020	Rohde & Schwarz	102219	300006192	k	08.04.2021	07.04.2023

## 8 Sequence of testing

### 8.1 Sequence of testing radiated spurious 30 MHz to 12.75 GHz

#### Setup

- The equipment is set up to simulate normal operation mode as described in the user manual or defined by the manufacturer.
- If the EUT is a tabletop system, a 2-axis positioner with 1.5 m height is used.
- If the EUT is a floor standing device, it is placed directly on the turn table.
- Auxiliary equipment and cables are positioned to simulate normal operation conditions as described in ANSI C 63.4.
- The AC power port of the EUT (if available) is connected to a power outlet below the turntable.
- Measurement distance is 3 m (see ANSI C 63.4) – see test details.
- EUT is set into operation.

#### Premeasurement

- The turntable rotates from 0° to 315° using 45° steps.
- The antenna is polarized vertical and horizontal.
- The antenna height is 1.5 m.
- At each turntable position and antenna polarization the analyzer sweeps with positive peak detector to find the maximum of all emissions.

#### Final measurement

- The final measurement is performed for at least six highest peaks according to the requirements of the ANSI C63.4.
- Based on antenna and turntable positions at which the peak values are measured the software maximizes the peaks by rotating the turntable from 0° to 360°. This measurement is repeated for different EUT-table positions (0° to 150° in 30°-steps) and for both antenna polarizations.
- The final measurement is done in the position (turntable, EUT-table and antenna polarization) causing the highest emissions with Peak and RMS detector (as described in ANSI C 63.4).
- Final levels, frequency, measuring time, bandwidth, turntable position, EUT-table position, antenna polarization, correction factor, margin to the limit and limit are recorded. A plot with the graph of the premeasurement with marked maximum final results and the limit is stored.

## 9 Measurement uncertainty

Measurement uncertainty	
Test case	Uncertainty
Transmitter output power	$\pm 3$ dB
Occupied bandwidth	$\pm 3$ kHz to 10 kHz (depends on the used RBW)
Transmitter frequency stability	$\pm 1$ Hz to 1 kHz (depends on the used RBW)
Transmitter unwanted emissions (radiated or conducted)	Radiated: $\pm 3$ dB Conducted: $\pm 0.5$ dB
Modulation characteristics	-/-
Necessary bandwidth (BN) for analogue systems	$\pm 1$ kHz (depends on the used RBW)
Frequency modulation	$\pm 3$ kHz (depends on the used RBW)
Spurious emissions conducted below 30 MHz (AC conducted)	$\pm 2.6$ dB

## 10 Summary of measurement results

<input checked="" type="checkbox"/>	No deviations from the technical specifications were ascertained
<input type="checkbox"/>	There were deviations from the technical specifications ascertained
<input type="checkbox"/>	This test report is only a partial test report. The content and verdict of the performed test cases are listed below.

TC Identifier	Description	Verdict	Date	Remark
RF-Testing	FCC Part 74 RSS - 210, Issue 9 RSS-Gen Issue 4	See table!	2022-10-17	-/-

Test specification clause	Test case	Temperature conditions	Voltage conditions	C	NC	NA	NP	Remark
FCC Part 74.861 (e)(1)(ii) FCC Part 2.1046 RSS-210 – G.3.1 RSS-Gen – 6.12	Transmitter output power	Nominal	Nominal	<input checked="" type="checkbox"/>	<input type="checkbox"/>	<input type="checkbox"/>	<input type="checkbox"/>	-/-
FCC Part 74.861 (e)(5) FCC Part 2.1049 RSS-210 – G.3.2 RSS-Gen – 6.6	Occupied bandwidth	Nominal	Nominal	<input checked="" type="checkbox"/>	<input type="checkbox"/>	<input type="checkbox"/>	<input type="checkbox"/>	-/-
FCC Part 74.861 (e)(4) FCC Part 2.1055 RSS-210 – G.3.3 RSS-Gen – 6.11	Transmitter frequency stability	Nominal	Nominal	<input checked="" type="checkbox"/>	<input type="checkbox"/>	<input type="checkbox"/>	<input type="checkbox"/>	-/-
		Extreme	Extreme	<input checked="" type="checkbox"/>	<input type="checkbox"/>	<input type="checkbox"/>	<input type="checkbox"/>	
FCC Part 74.861 (e)(6) FCC Part 74.861 (e)(7) RSS-210 – G.3.4 ETSI EN 300 422-1 v1.4.2 (2011-08)	Transmitter unwanted emissions (radiated or conducted)	Nominal	Nominal	<input checked="" type="checkbox"/>	<input type="checkbox"/>	<input type="checkbox"/>	<input type="checkbox"/>	-/-
FCC Part 2.1047	Modulation characteristics	Nominal	Nominal	-/-				Digital modulation
FCC Part 74.861 (e)(7) ETSI EN 300 422-1 v1.4.2 (2011-08)	Necessary bandwidth (BN) for analogue systems	Nominal	Nominal	<input checked="" type="checkbox"/>	<input type="checkbox"/>	<input type="checkbox"/>	<input type="checkbox"/>	-/-
FCC Part 74.861 (e)(3) RSS-210 – G.3.5.2	Frequency modulation	Nominal	Nominal	<input type="checkbox"/>	<input type="checkbox"/>	<input checked="" type="checkbox"/>	<input type="checkbox"/>	Digital modulation
FCC Part 74.861 (e)(7) RSS-210 – G.3.4	Receiver spurious emissions	Nominal	Nominal	<input type="checkbox"/>	<input type="checkbox"/>	<input checked="" type="checkbox"/>	<input type="checkbox"/>	No receiver integrated!
FCC Part 15.107(a) FCC Part 15.207	Conducted emissions < 30 MHz	Nominal	Nominal	<input type="checkbox"/>	<input type="checkbox"/>	<input checked="" type="checkbox"/>	<input type="checkbox"/>	-/-

**Note:** C = Compliant; NC = Not compliant; NA = Not applicable; NP = Not performed

## 11 Additional comments

Reference documents: None

Special test descriptions: None

Configuration descriptions: None

Test mode:  No test mode available.  
Test signal is applied to the transmitter.

Special software is used.  
EUT is transmitting pseudo random data by itself

Antennas and transmit operating modes:  **Operating mode 1 (single antenna)**

- *Equipment with 1 antenna,*
- *Equipment with 2 diversity antennas operating in switched diversity mode by which at any moment in time only 1 antenna is used,*
- *Smart antenna system with 2 or more transmit/receive chains, but operating in a mode where only 1 transmit/receive chain is used)*

**Operating mode 2 (multiple antennas, no beamforming)**

- *Equipment operating in this mode contains a smart antenna system using two or more transmit/receive chains simultaneously but without beamforming.*

**Operating mode 3 (multiple antennas, with beamforming)**

- *Equipment operating in this mode contains a smart antenna system using two or more transmit/receive chains simultaneously with beamforming. In addition to the antenna assembly gain (G), the beamforming gain (Y) may have to be taken into account when performing the measurements.*

## 12 Measurement results

### 12.1 Transmitter output power

**Measurement:**

Measurement parameter	
Detector:	Peak (worst case) / Average (RMS)
Sweep time:	Auto / 20s
Resolution bandwidth:	> emission bandwidth
Video bandwidth:	> resolution bandwidth
Span:	> 2 times emissions bandwidth
Trace mode:	Max. hold
EUT configuration:	Peak: Unmodulated carrier RMS: Modulate the transmitter with a 2.5 kHz tone at a level 16 dB higher than that required to produce a frequency deviation of $\pm 75$ kHz, or to produce 50% of the manufacturer's rated deviation, whichever is less.
Test setup:	See sub clause 7.2 – A
Measurement uncertainty:	See sub clause 9

**Limits:**

FCC (conducted)	
941.500 MHz – 944.000 MHz 944.000 MHz – 952.000 MHz 952.850 MHz – 956.250 MHz 956.450 MHz – 959.850 MHz	1 W (average) / 30 dBm (average)
IC (conducted)	
941.500 MHz – 952.000 MHz 953.000 MHz – 959.850 MHz	1 W (average) / 30 dBm (average)

**Result normal mode:**

Transmitter output power conducted / dBm							
Frequencies / MHz	941.7	946.75	951.8	953.05	956.05	956.65	959.65
Peak	13.14	13.12	13.00	13.07	13.09	13.05	13.06
Average	9.37	9.37	9.33	9.33	9.34	9.32	9.27

**Result LD mode:**

Transmitter output power conducted / dBm							
Frequencies / MHz	941.7	946.75	951.8	953.05	956.05	956.65	959.65
Peak	13.02	13.09	13.02	12.91	13.04	12.90	12.96
Average	9.34	9.34	9.33	9.32	9.34	9.32	9.30



**Plots output power conducted, normal mode:**

**Plot 1: 941.7 MHz**

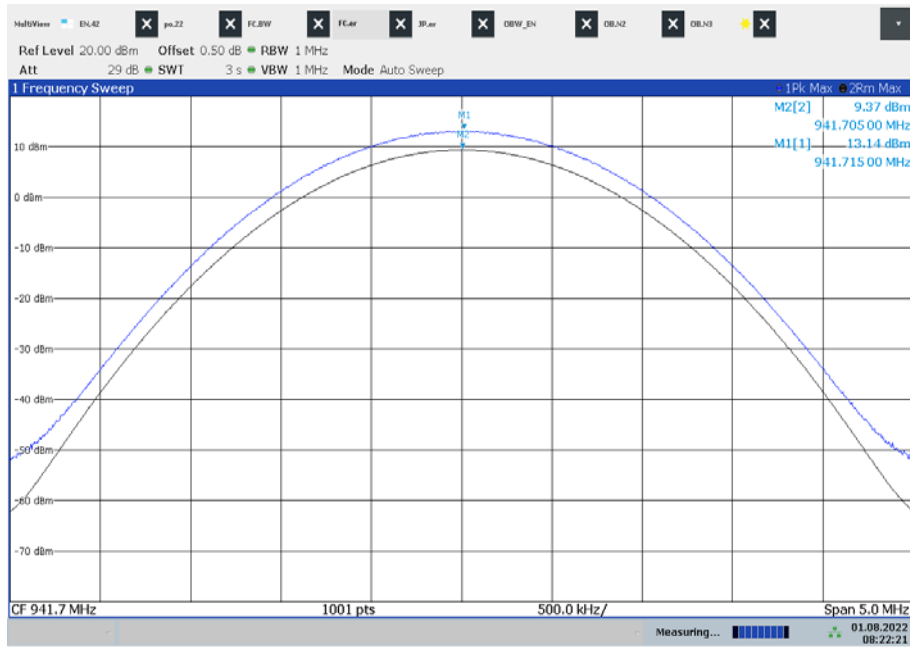

08:22:22 01.08.2022

**Plot 2: 946.75 MHz**

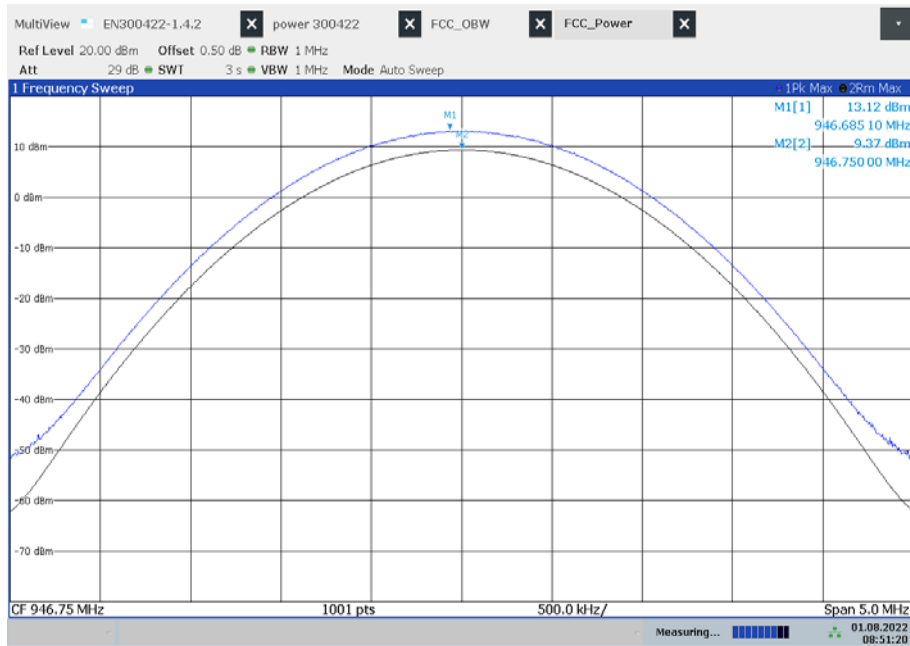

08:51:20 01.08.2022

**Plot 3: 951.8 MHz**

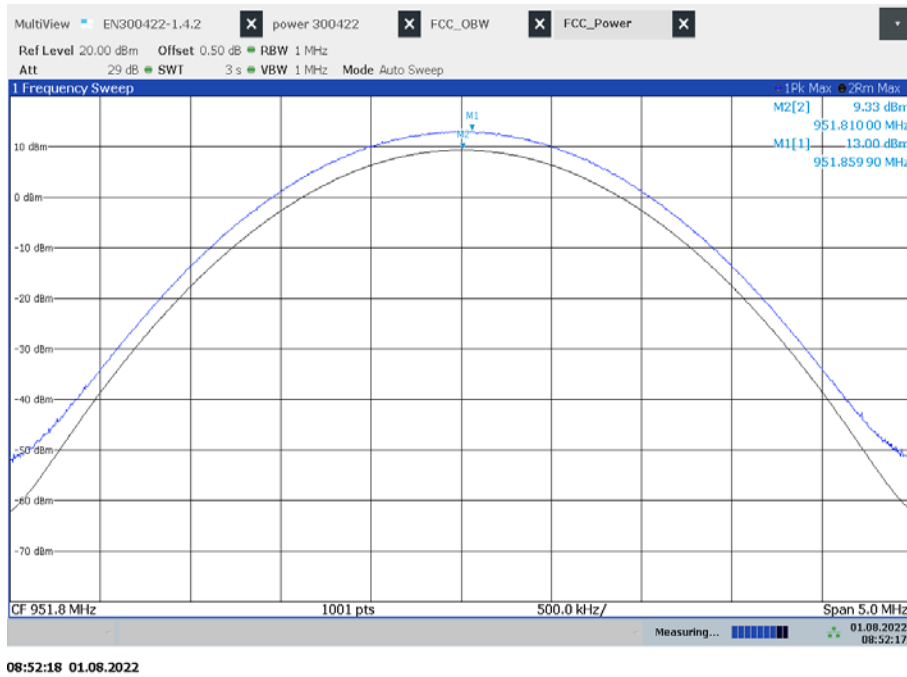

**Plot 4: 953.05 MHz**

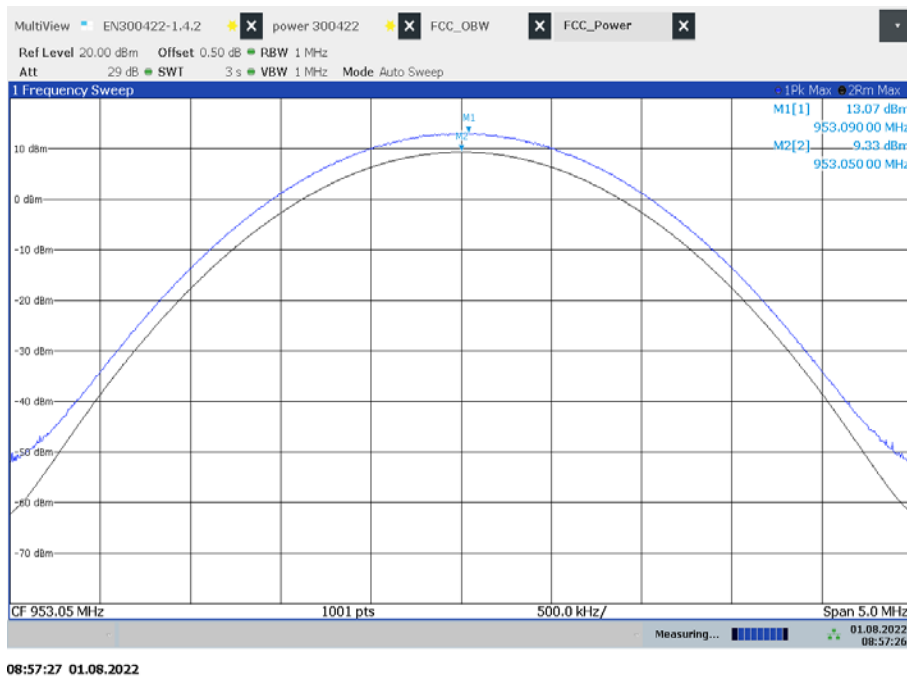

**Plot 5: 956.05 MHz**



**Plot 6: 956.65 MHz**

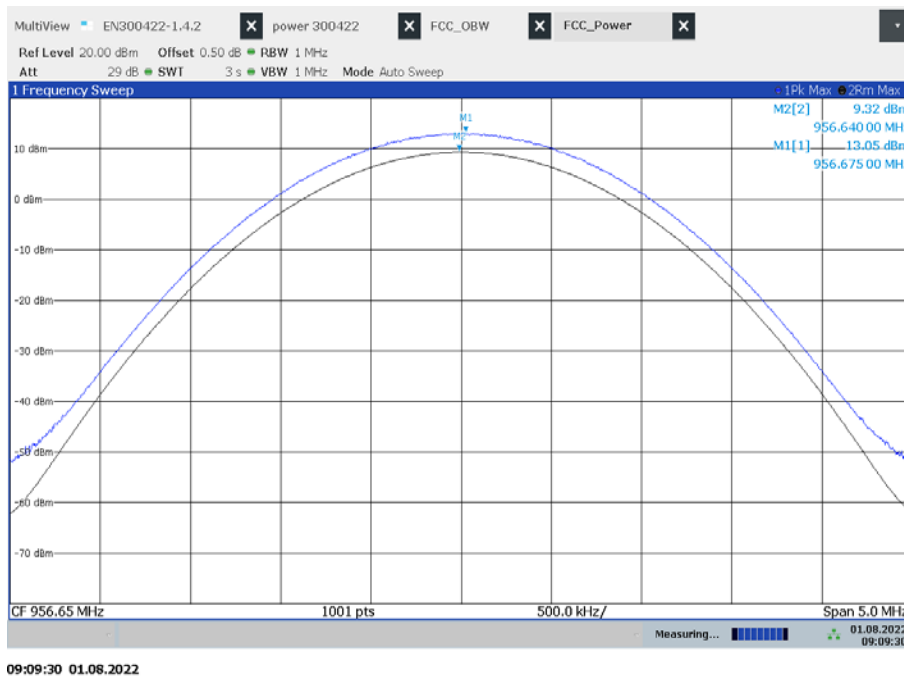

**Plot 7: 959.65 MHz**

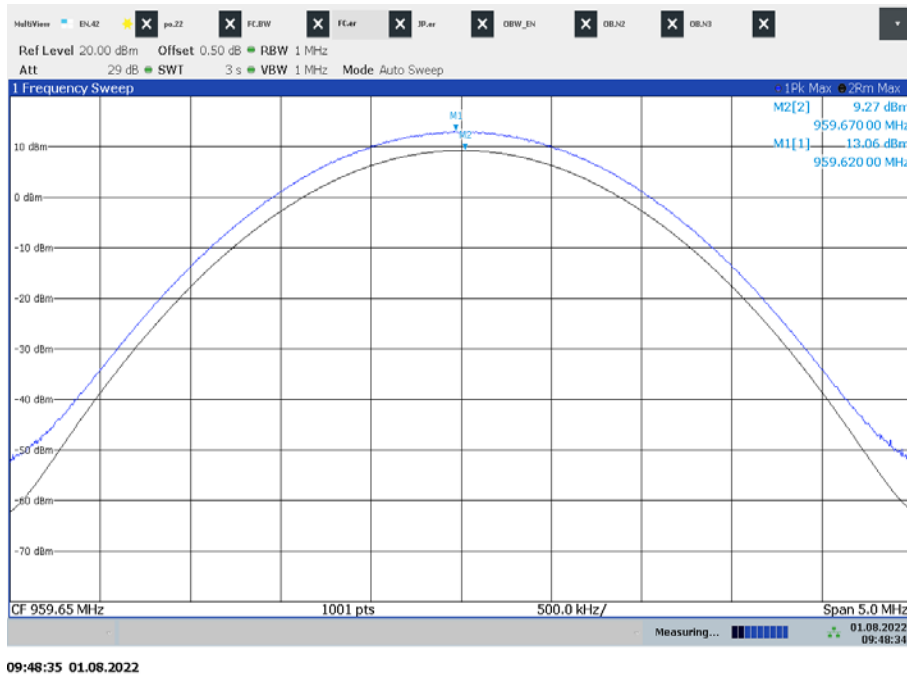

**Plots output power conducted, LD mode:**

**Plot 1: 941.7 MHz**

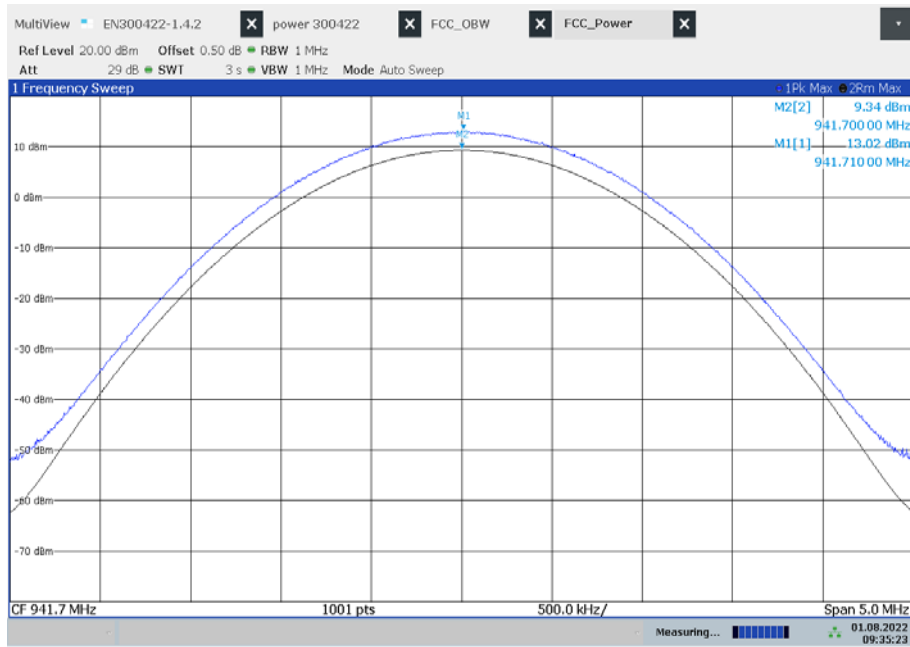

09:35:24 01.08.2022

**Plot 2: 946.75 MHz**

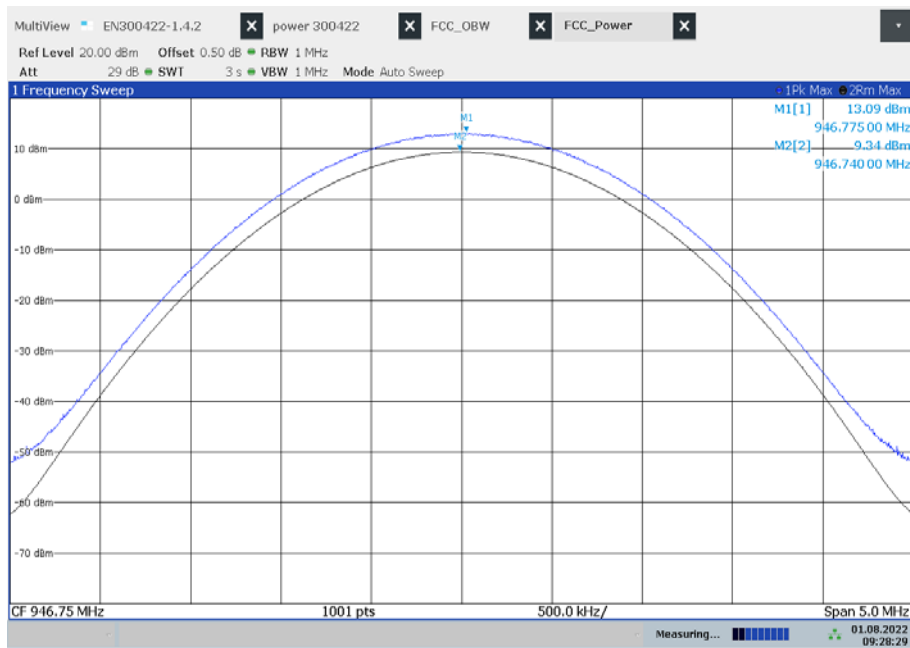

09:28:30 01.08.2022

**Plot 3: 951.8 MHz**

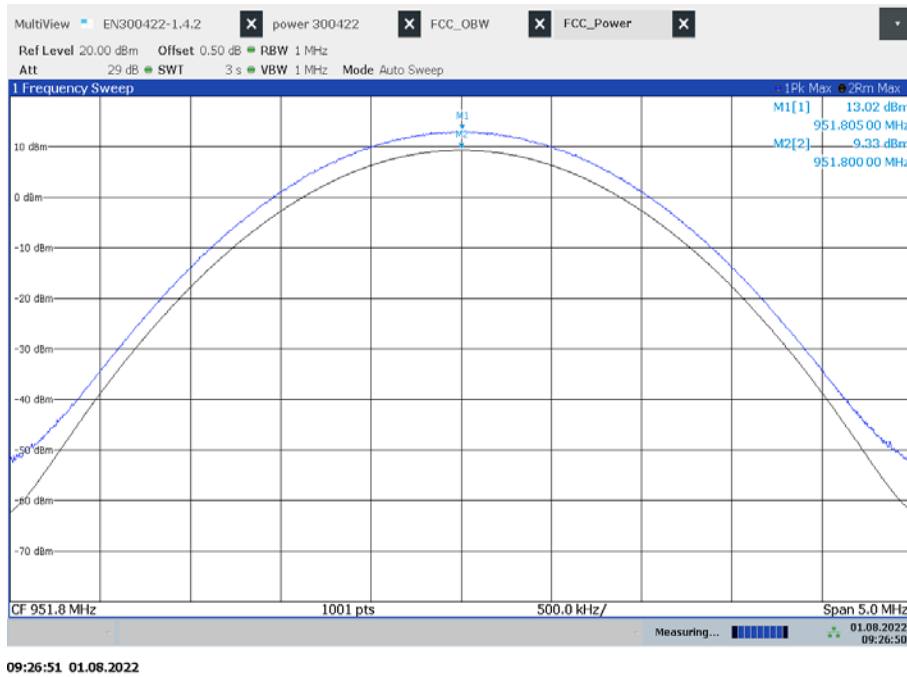

**Plot 4: 953.05 MHz**

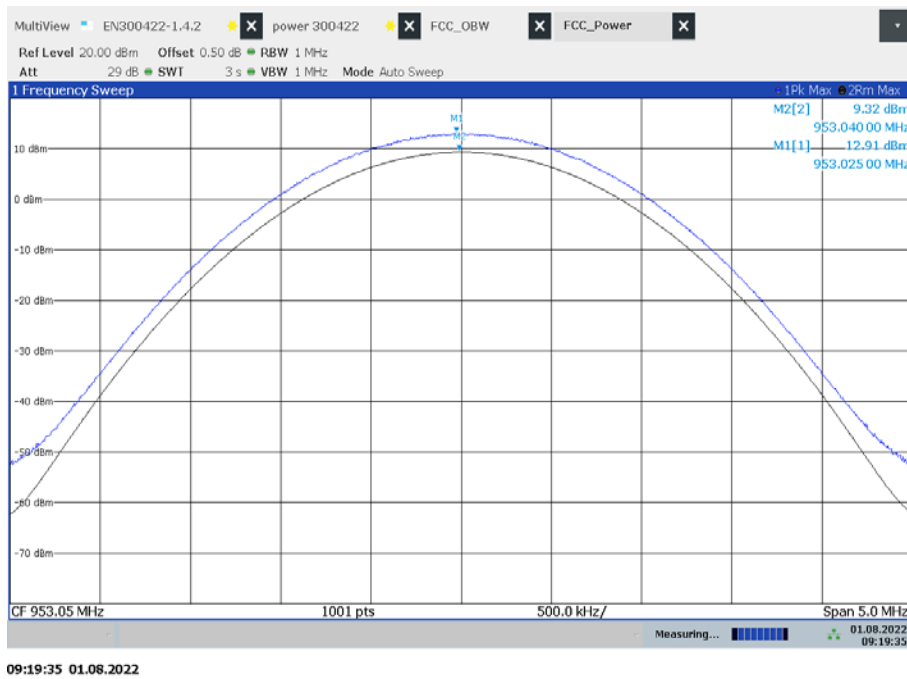

**Plot 5: 956.05 MHz**

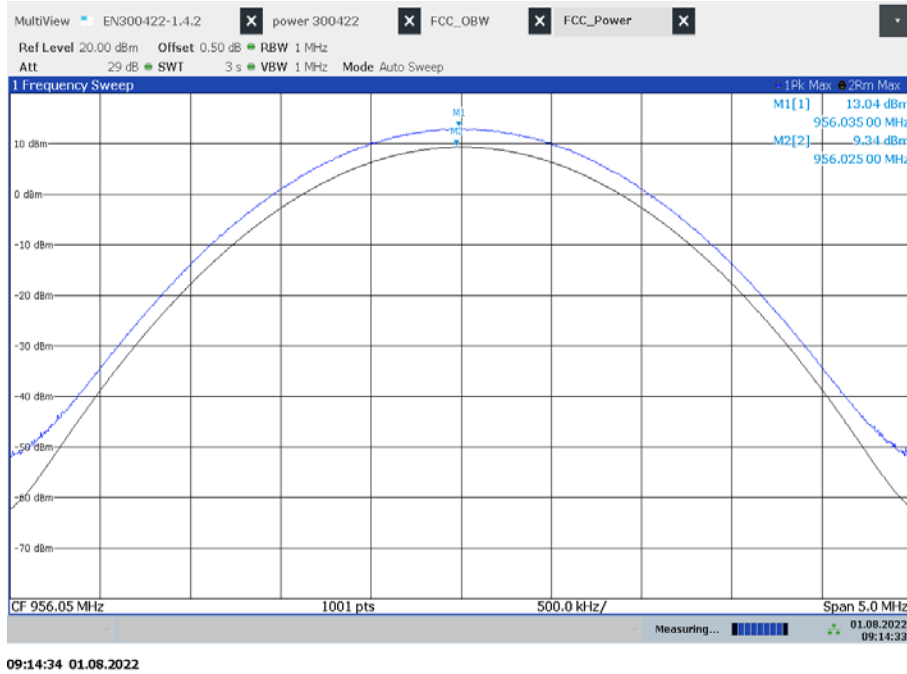

**Plot 6: 956.65 MHz**

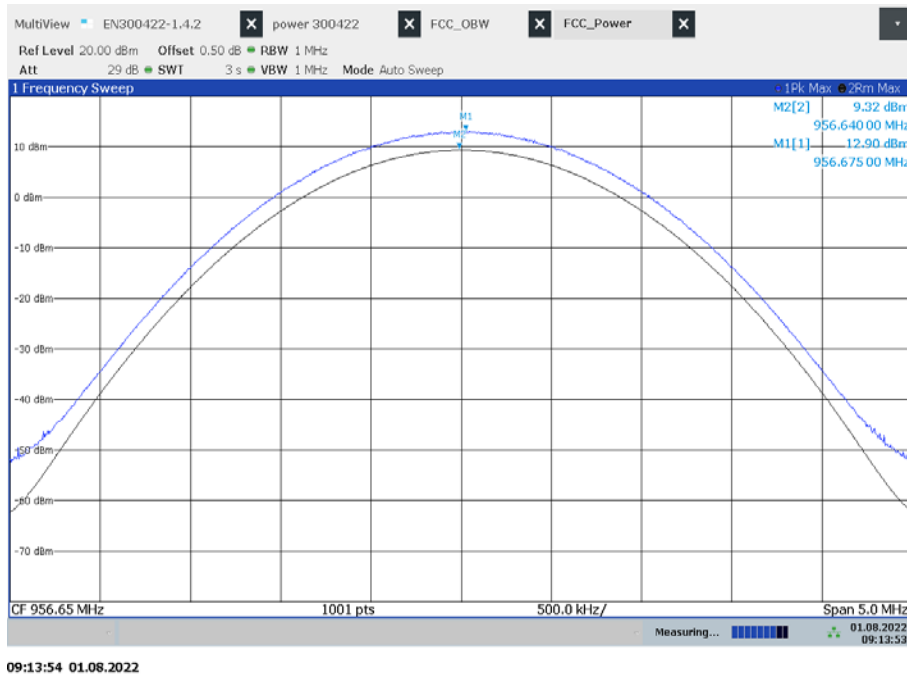

**Plot 7: 959.65 MHz**

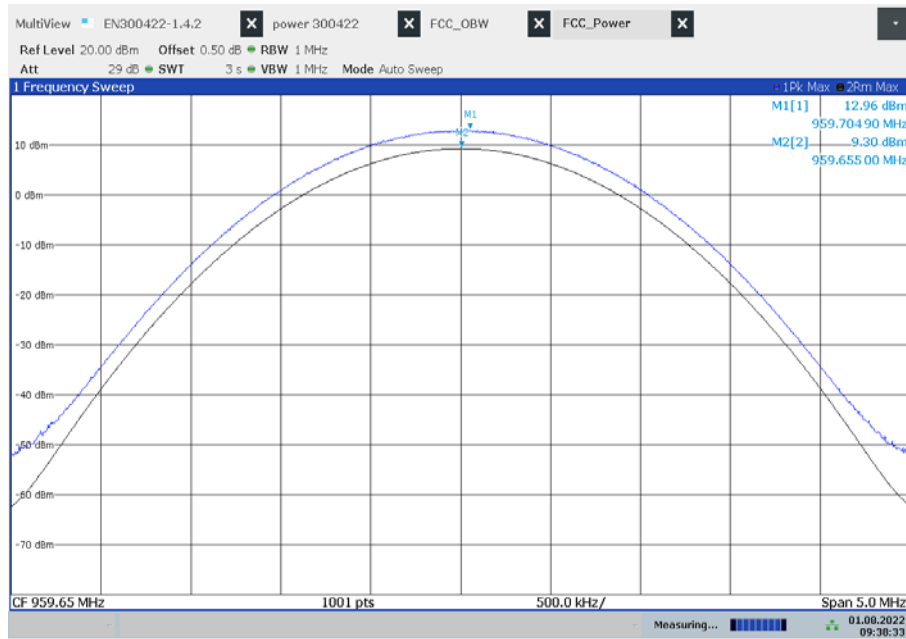



## 12.2 Occupied bandwidth

### Measurement:

Measurement parameter	
Detector:	Peak
Sweep time:	Auto
Resolution bandwidth:	1 % to 5 % of the occupied bandwidth
Video bandwidth:	3 x resolution bandwidth
Span:	2 x emission bandwidth
Trace mode:	Max. hold
Analyzer function:	99% power occupied bandwidth function
EUT:	Modulated signal with max. frequency deviation
Test setup:	See sub clause 7.2 - A
Measurement uncertainty:	See sub clause 9

### Limits:

FCC & IC	
941.500 MHz – 952.000 MHz 953.000 MHz – 959.850 MHz	200 kHz

### Result:

Normal mode	
Centre frequency (fc)	OBW
941.700 MHz	172.120 kHz
946.750 MHz	170.948 kHz
951.800 MHz	170.776 kHz
953.050 MHz	171.814 kHz
956.050 MHz	169.497 kHz
956.650 MHz	171.524 kHz
959.650 MHz	171.026 kHz

LD-mode	
Centre frequency (fc)	OBW
941.700 MHz	142.439 kHz
946.750 MHz	141.881 kHz
951.800 MHz	141.913 kHz
953.050 MHz	143.124 kHz
956.050 MHz	142.152 kHz
956.650 MHz	142.884 kHz
959.650 MHz	142.367 kHz

**Plots normal mode:**

**Plot 1: 941.7 MHz**

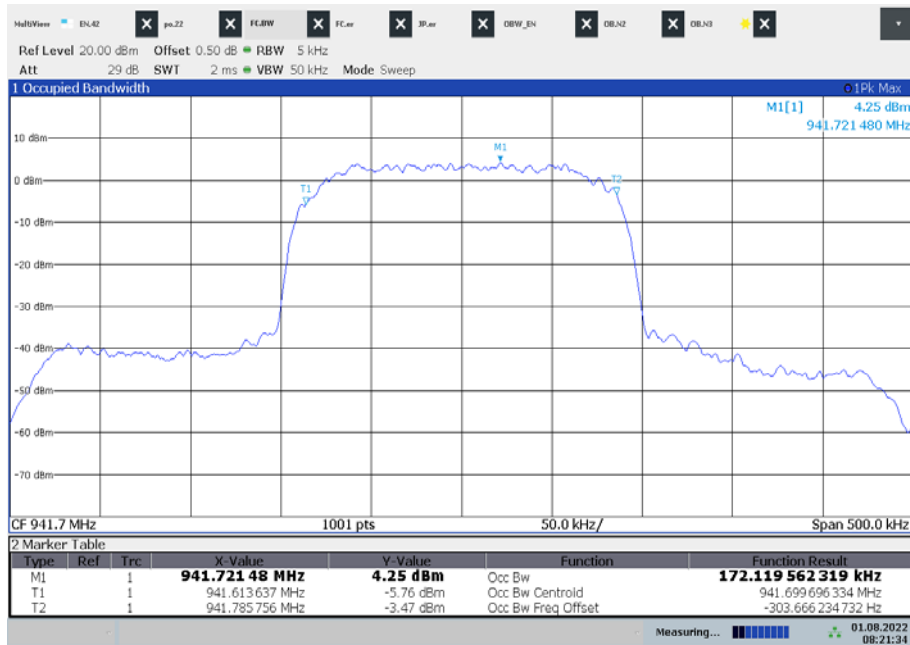

08:21:35 01.08.2022

**Plot 2: 946.75 MHz**

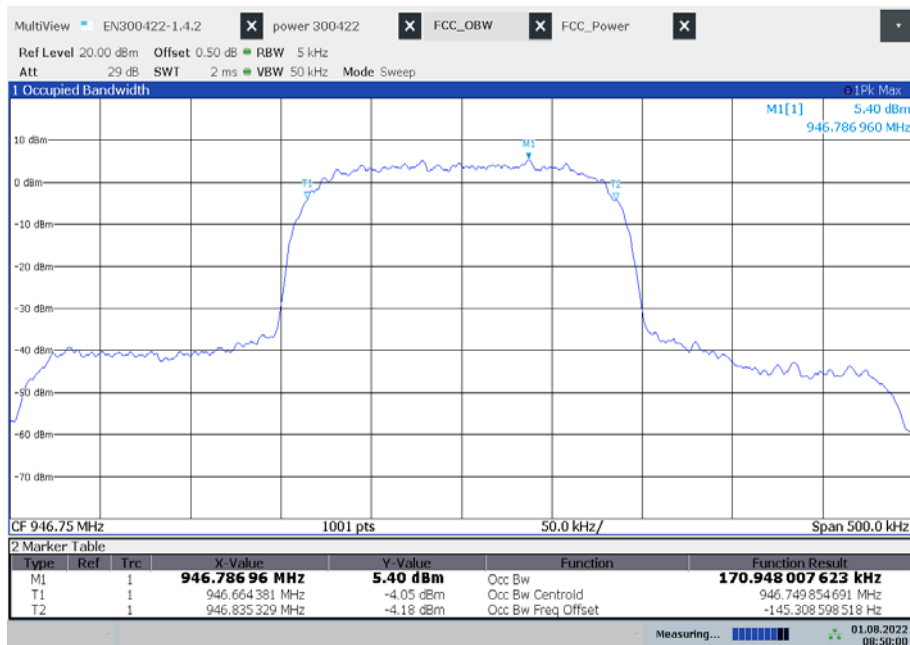

08:50:01 01.08.2022

Plot 3: 951.8 MHz

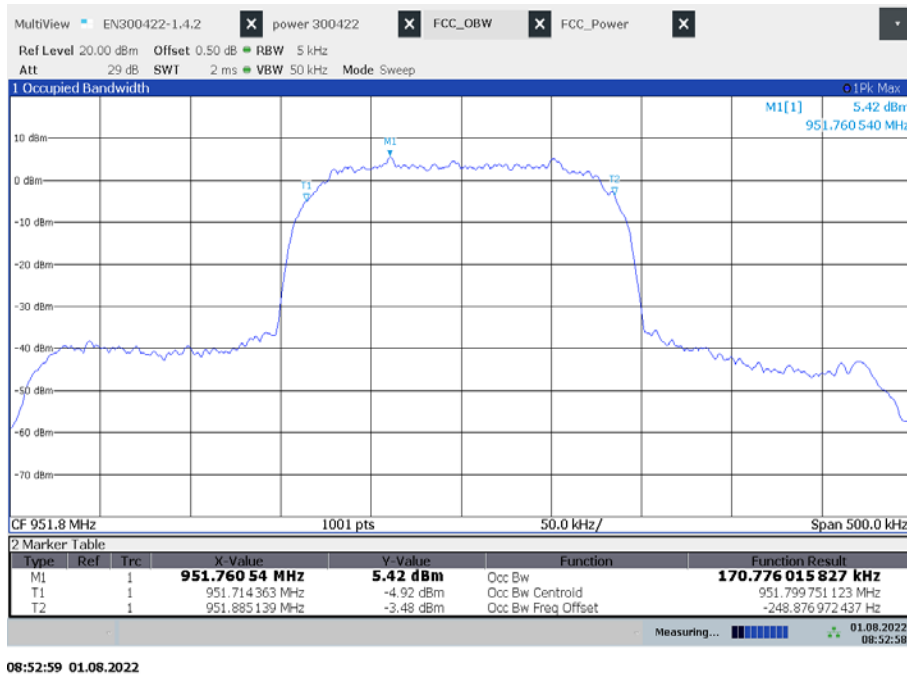

Plot 4: 953.05 MHz

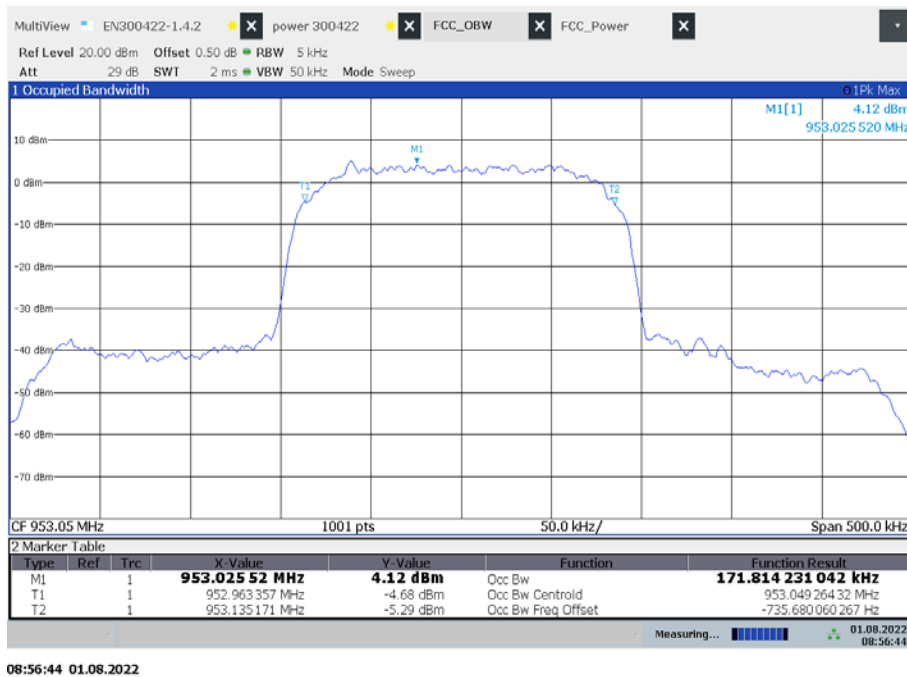

Plot 5: 956.05 MHz

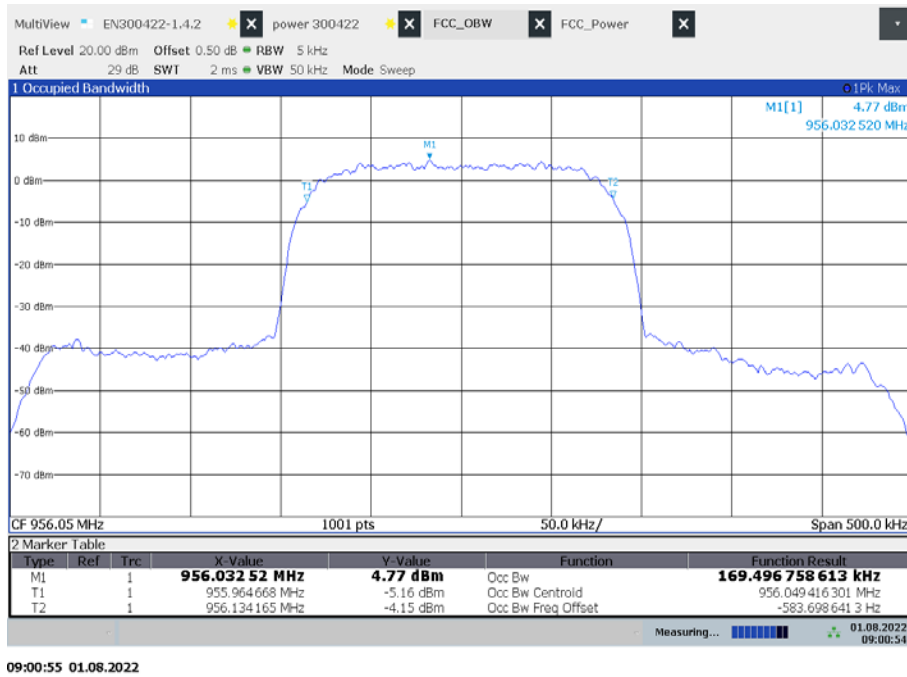

Plot 6: 956.65 MHz

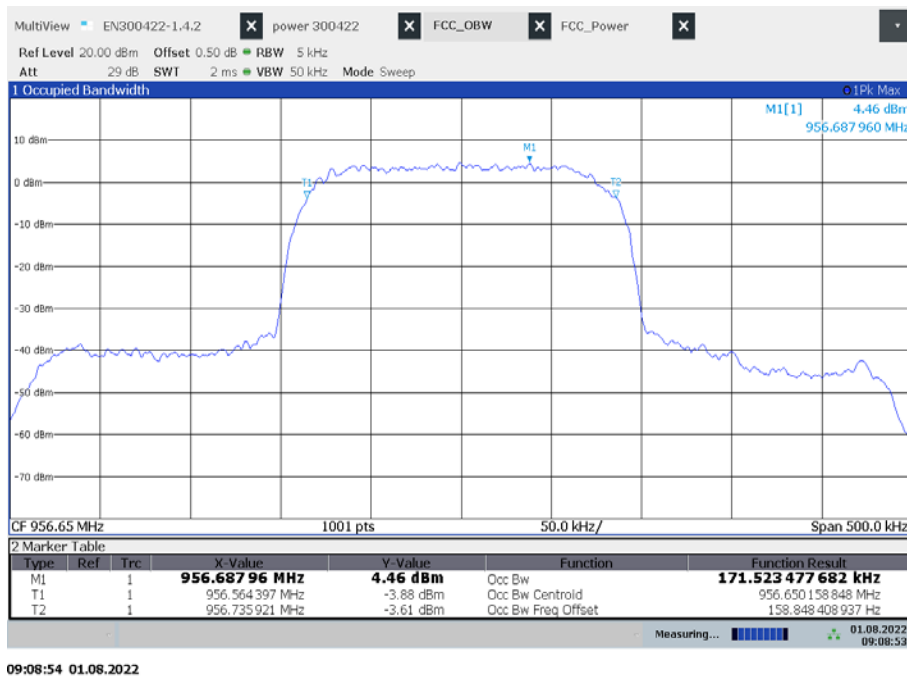

**Plot 7: 959.65 MHz**

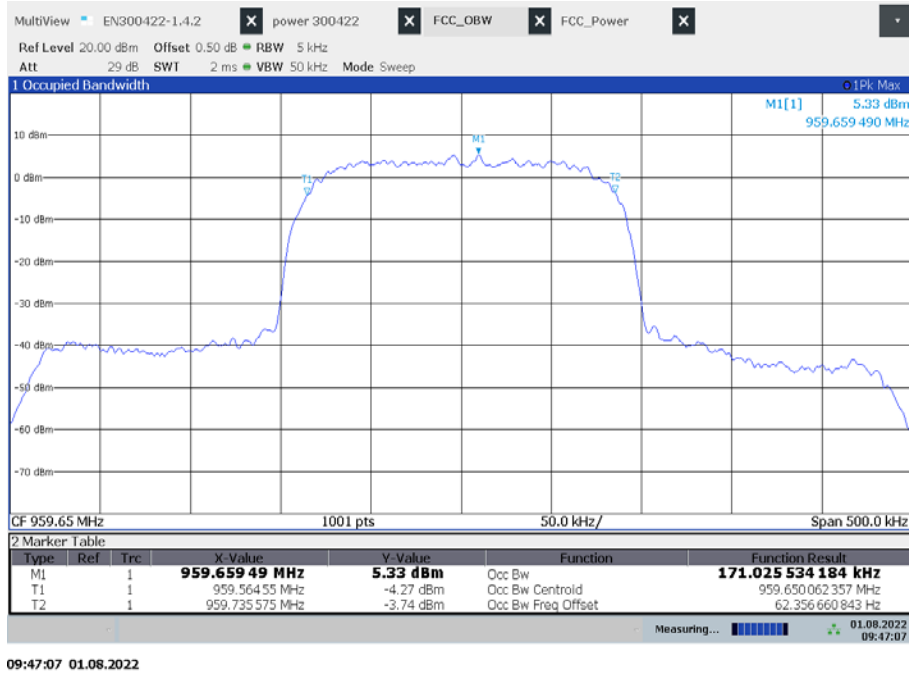

**Plots LD mode:**

**Plot 1: 941.7 MHz**

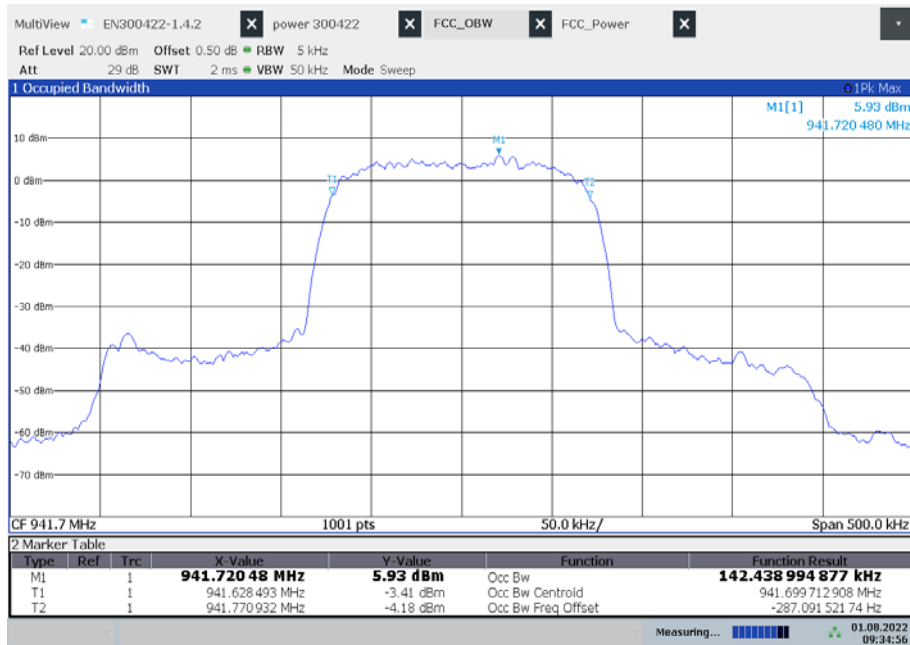

09:34:56 01.08.2022

**Plot 2: 946.75 MHz**

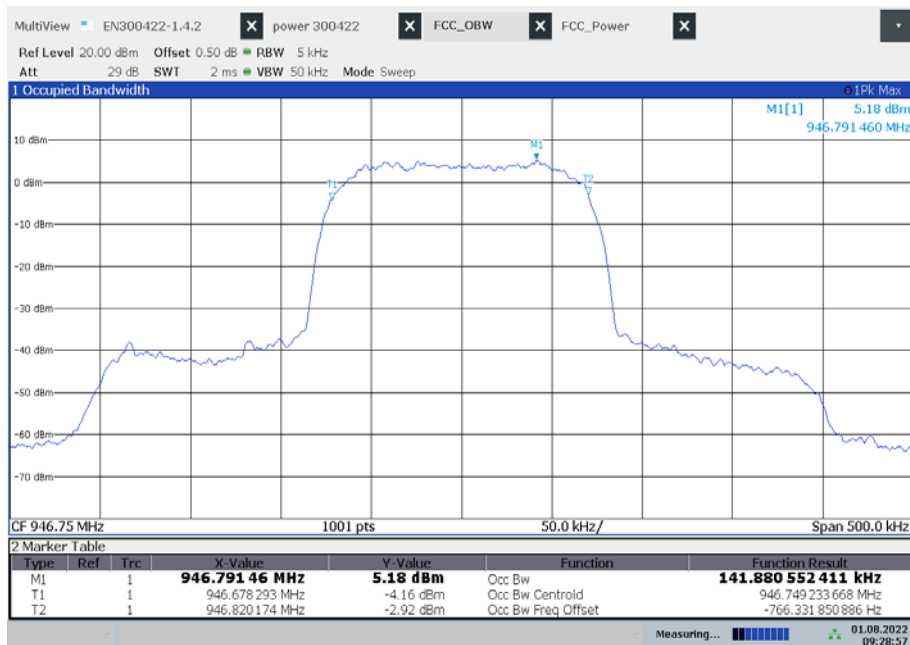

09:28:57 01.08.2022

Plot 3: 951.8 MHz

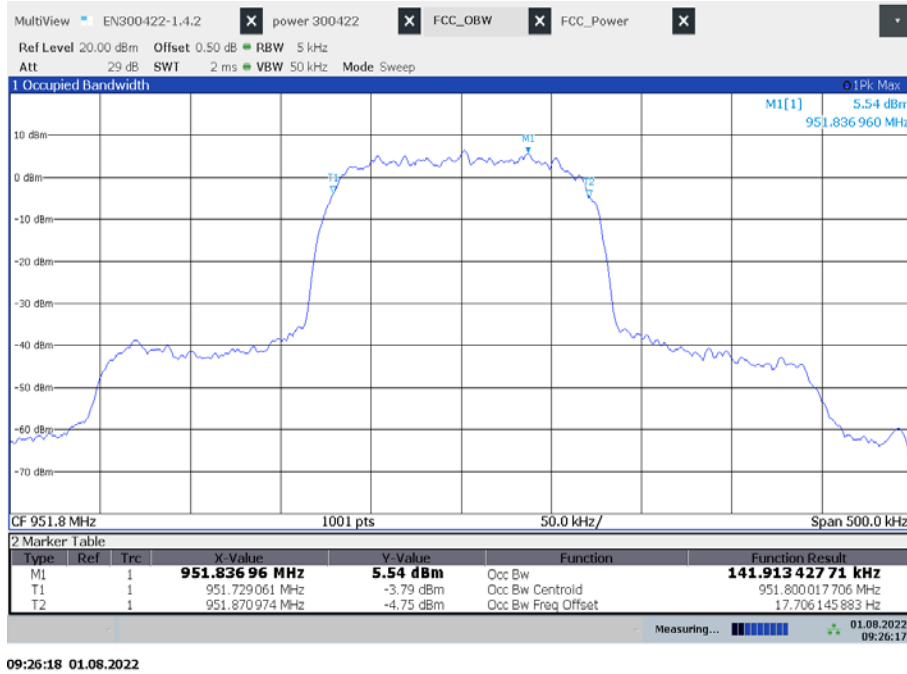

Plot 4: 953.05 MHz

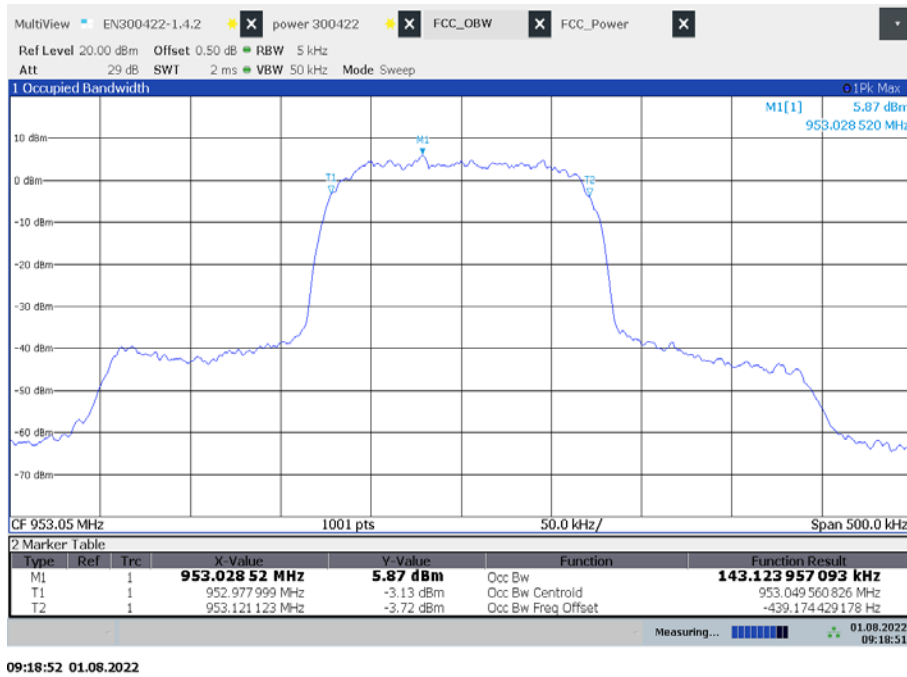

Plot 5: 956.05 MHz

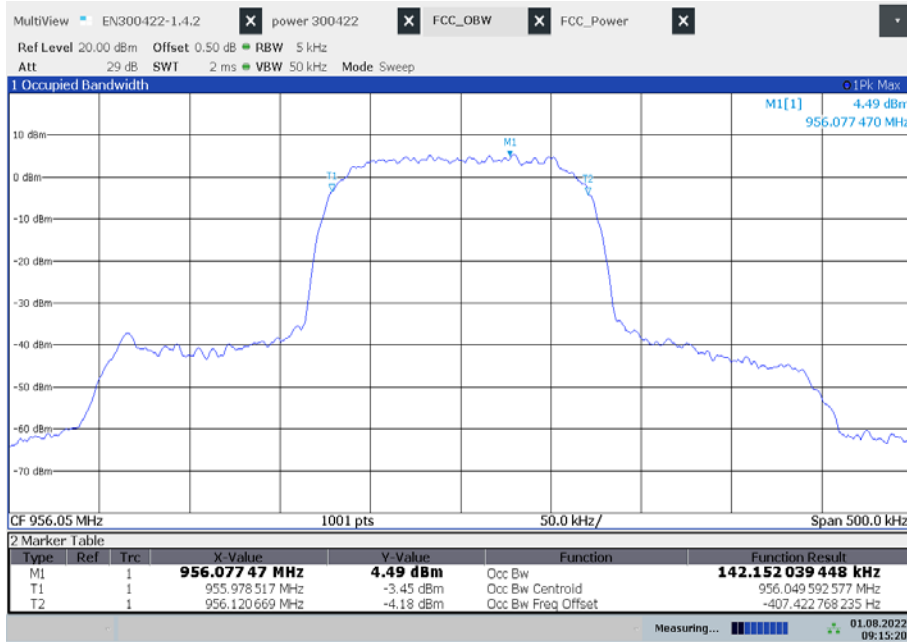

09:15:21 01.08.2022

Plot 6: 956.65 MHz

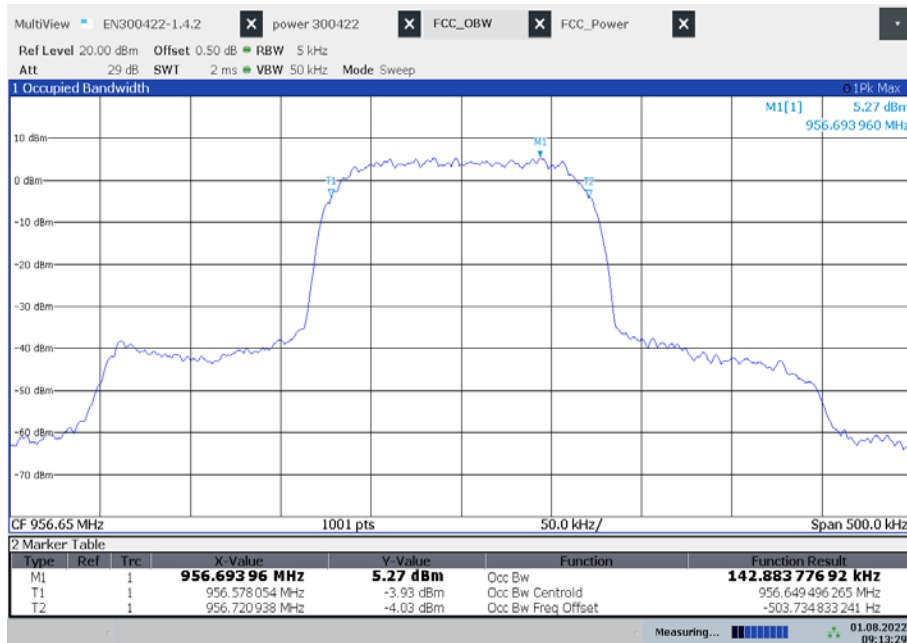

09:13:29 01.08.2022



**Plot 7: 959.65 MHz**

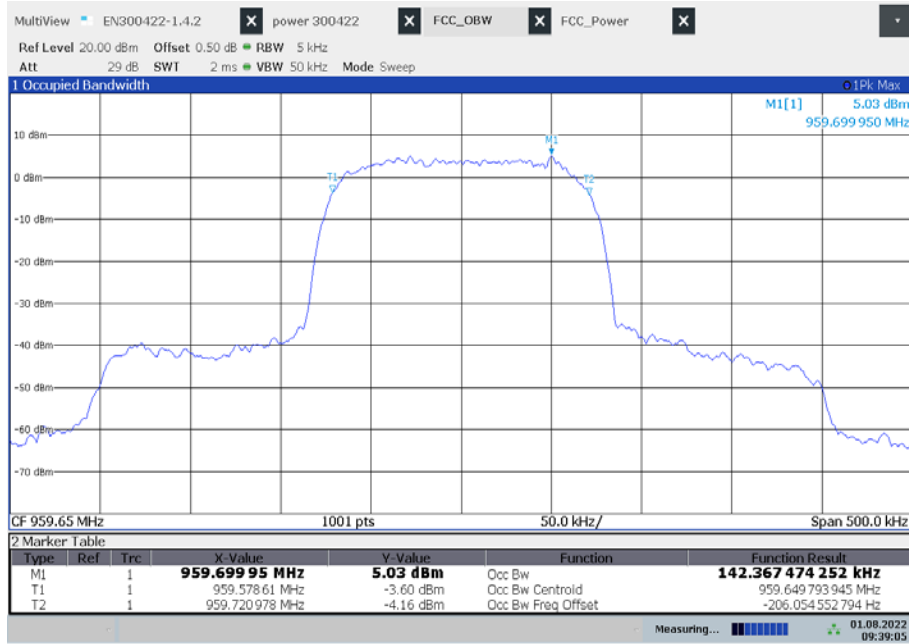

09:39:05 01.08.2022

## 12.3 Transmitter frequency stability

### Measurement:

Measurement parameter	
Detector:	Peak
Sweep time:	Auto
Resolution bandwidth:	1 Hz / 10 Hz / 100 Hz
Video bandwidth:	3 x resolution bandwidth
Span:	wide enough to follow the frequency drift
Trace mode:	clear/write/view
EUT:	CW signal or MC with measurement method description
Test setup:	See sub clause 7.2 - B
Measurement uncertainty:	See sub clause 9

### Limits:

FCC	
941.500 MHz – 944.000 MHz	± 50 ppm
944.000 MHz – 952.000 MHz	
952.850 MHz – 956.250 MHz	
956.450 MHz – 959.850 MHz	
IC	
941.500 MHz – 952.000 MHz	± 20 ppm
953.000 MHz – 959.850 MHz	

### Results: 941.700 MHz

Temperature / Voltage	Frequency (MHz)	Deviation (kHz / ppm)
-30 °C / V <sub>nom</sub>	941.700132	0.132 / 0.140
-20 °C / V <sub>nom</sub>	941.700034	0.034 / 0.036
-10 °C / V <sub>nom</sub>	941.699968	-0.032 / 0.034
0 °C / V <sub>nom</sub>	941.700121	0.121 / 0.128
+10 °C / V <sub>nom</sub>	941.700221	0.221 / 0.235
+20 °C / V <sub>nom</sub>	941.700299	0.299 / 0.318
+30 °C / V <sub>nom</sub>	941.700383	0.383 / 0.407
+40 °C / V <sub>nom</sub>	941.700530	0.530 / 0.563
+50 °C / V <sub>nom</sub>	941.700552	0.552 / 0.586
+20 °C / V <sub>nom</sub> - 15%	941.700292	0.292 / 0.310
+20 °C / V <sub>nom</sub>	941.700299	0.299 / 0.318
+20 °C / V <sub>nom</sub> + 15%	941.700258	0.258 / 0.274

**Results:** 946.750 MHz

Temperature / Voltage	Frequency (MHz)	Deviation (kHz / ppm)
-30 °C / V <sub>nom</sub>	946.750082	0.082 / 0.087
-20 °C / V <sub>nom</sub>	946.749935	-0.065 / 0.069
-10 °C / V <sub>nom</sub>	946.750022	0.022 / 0.023
0 °C / V <sub>nom</sub>	946.750158	0.158 / 0.167
+10 °C / V <sub>nom</sub>	946.750200	0.200 / 0.211
+20 °C / V <sub>nom</sub>	946.750264	0.264 / 0.279
+30 °C / V <sub>nom</sub>	946.750320	0.320 / 0.338
+40 °C / V <sub>nom</sub>	946.750461	0.461 / 0.487
+50 °C / V <sub>nom</sub>	946.750602	0.602 / 0.636
+20 °C / V <sub>nom</sub> - 15%	946.750256	0.256 / 0.270
+20 °C / V <sub>nom</sub>	946.750264	0.264 / 0.279
+20 °C / V <sub>nom</sub> + 15%	946.750349	0.349 / 0.369

**Results:** 951.800 MHz

Temperature / Voltage	Frequency (MHz)	Deviation (kHz / ppm)
-30 °C / V <sub>nom</sub>	951.800123	0.123 / 0.129
-20 °C / V <sub>nom</sub>	951.799799	-0.201 / 0.211
-10 °C / V <sub>nom</sub>	951.800015	0.015 / 0.016
0 °C / V <sub>nom</sub>	951.800003	0.003 / 0.003
+10 °C / V <sub>nom</sub>	951.800239	0.239 / 0.251
+20 °C / V <sub>nom</sub>	951.800244	0.244 / 0.256
+30 °C / V <sub>nom</sub>	951.800402	0.402 / 0.422
+40 °C / V <sub>nom</sub>	951.800424	0.424 / 0.445
+50 °C / V <sub>nom</sub>	951.800574	0.574 / 0.603
+20 °C / V <sub>nom</sub> - 15%	951.800251	0.251 / 0.264
+20 °C / V <sub>nom</sub>	951.800244	0.244 / 0.256
+20 °C / V <sub>nom</sub> + 15%	951.800284	0.284 / 0.298

**Results:** 953.050 MHz

Temperature / Voltage	Frequency (MHz)	Deviation (kHz / ppm)
-30 °C / V <sub>nom</sub>	953.049919	-0.081 / 0.085
-20 °C / V <sub>nom</sub>	953.049914	-0.086 / 0.090
-10 °C / V <sub>nom</sub>	953.049986	-0.014 / 0.015
0 °C / V <sub>nom</sub>	953.050112	0.112 / 0.118
+10 °C / V <sub>nom</sub>	953.050264	0.264 / 0.277
+20 °C / V <sub>nom</sub>	953.050232	0.232 / 0.243
+30 °C / V <sub>nom</sub>	953.050341	0.341 / 0.358
+40 °C / V <sub>nom</sub>	953.050382	0.382 / 0.401
+50 °C / V <sub>nom</sub>	953.050641	0.641 / 0.673
+20 °C / V <sub>nom</sub> - 15%	953.050263	0.263 / 0.276
+20 °C / V <sub>nom</sub>	953.050232	0.232 / 0.243
+20 °C / V <sub>nom</sub> + 15%	953.050380	0.380 / 0.399

**Results:** 956.050 MHz

Temperature / Voltage	Frequency (MHz)	Deviation (kHz / ppm)
-30 °C / V <sub>nom</sub>	956.050009	0.009 / 0.009
-20 °C / V <sub>nom</sub>	956.049962	-0.038 / 0.040
-10 °C / V <sub>nom</sub>	956.050016	0.016 / 0.017
0 °C / V <sub>nom</sub>	956.050181	0.181 / 0.189
+10 °C / V <sub>nom</sub>	956.050295	0.295 / 0.309
+20 °C / V <sub>nom</sub>	956.050385	0.385 / 0.403
+30 °C / V <sub>nom</sub>	956.050308	0.308 / 0.322
+40 °C / V <sub>nom</sub>	956.050553	0.553 / 0.578
+50 °C / V <sub>nom</sub>	956.050509	0.509 / 0.532
+20 °C / V <sub>nom</sub> - 15%	956.050249	0.249 / 0.260
+20 °C / V <sub>nom</sub>	956.050385	0.385 / 0.403
+20 °C / V <sub>nom</sub> + 15%	956.050299	0.299 / 0.313

**Results:** 956.650 MHz

Temperature / Voltage	Frequency (MHz)	Deviation (kHz / ppm)
-30 °C / V <sub>nom</sub>	956.650021	0.021 / 0.022
-20 °C / V <sub>nom</sub>	956.649800	-0.200 / 0.209
-10 °C / V <sub>nom</sub>	956.650041	0.041 / 0.043
0 °C / V <sub>nom</sub>	956.650246	0.246 / 0.257
+10 °C / V <sub>nom</sub>	956.650311	0.311 / 0.325
+20 °C / V <sub>nom</sub>	956.650400	0.400 / 0.418
+30 °C / V <sub>nom</sub>	956.650338	0.338 / 0.353
+40 °C / V <sub>nom</sub>	956.650450	0.450 / 0.470
+50 °C / V <sub>nom</sub>	956.650535	0.535 / 0.559
+20 °C / V <sub>nom</sub> - 15%	956.650309	0.309 / 0.323
+20 °C / V <sub>nom</sub>	956.650400	0.400 / 0.418
+20 °C / V <sub>nom</sub> + 15%	956.650232	0.232 / 0.243

**Results:** 959.650 MHz

Temperature / Voltage	Frequency (MHz)	Deviation (kHz / ppm)
-30 °C / V <sub>nom</sub>	959.649922	-0.078 / 0.081
-20 °C / V <sub>nom</sub>	959.649750	-0.250 / 0.261
-10 °C / V <sub>nom</sub>	959.649901	-0.099 / 0.103
0 °C / V <sub>nom</sub>	959.650058	0.058 / 0.060
+10 °C / V <sub>nom</sub>	959.649935	-0.065 / 0.068
+20 °C / V <sub>nom</sub>	959.650146	0.146 / 0.152
+30 °C / V <sub>nom</sub>	959.650316	0.316 / 0.329
+40 °C / V <sub>nom</sub>	959.650438	0.438 / 0.456
+50 °C / V <sub>nom</sub>	959.650603	0.603 / 0.628
+20 °C / V <sub>nom</sub> - 15%	959.649993	-0.007 / -0.007
+20 °C / V <sub>nom</sub>	959.650146	0.146 / 0.152
+20 °C / V <sub>nom</sub> + 15%	959.650097	0.097 / 0.101

## 12.4 Transmitter unwanted emissions (radiated)

### Measurement:

Measurement parameter							
Detector:	Peak (prescan) / RMS						
Sweep time:	Auto						
Resolution bandwidth:	<table border="0"> <tr> <td>25 MHz to 30 MHz</td> <td>9 kHz to 10 kHz</td> </tr> <tr> <td>30 MHz to 1 000 MHz</td> <td>100 kHz</td> </tr> <tr> <td>&gt; 1 000 MHz</td> <td>1 MHz</td> </tr> </table>	25 MHz to 30 MHz	9 kHz to 10 kHz	30 MHz to 1 000 MHz	100 kHz	> 1 000 MHz	1 MHz
25 MHz to 30 MHz	9 kHz to 10 kHz						
30 MHz to 1 000 MHz	100 kHz						
> 1 000 MHz	1 MHz						
Video bandwidth:	3 * RBW						
Span:	100 MHz steps!						
Trace-Mode:	Max. hold						
EUT:	MC with max frequency deviation						
Used equipment:	See chapter 7.1- A / B						
Measurement uncertainty:	See chapter 9						

### Limits:

Max. spurious level FCC & IC (according to ETSI EN 300 422-1 v1.4.2 (2011-08))			
State	47 MHz to 74 MHz 87.5 MHz to 118 MHz 174 MHz to 230 MHz 470 MHz to 862 MHz	Other frequencies ≤ 1000 MHz	All frequencies > 1000 MHz
Operating	4.0 nW	250 nW	1.00 µW
Standby	2.0 nW	2.0 nW	20.0 nW
FCC & IC			
The mean power of emissions shall be attenuated below the mean output power of the transmitter in accordance with the following schedule:			
On any frequency removed from the operating frequency by more than 50 percent up to and including 100 percent of the authorized bandwidth: at least			25 dB
On any frequency removed from the operating frequency by more than 100 percent up to and including 250 percent of the authorized bandwidth			35 dB
On any frequency removed from the operating frequency by more than 250 percent of the authorized bandwidth: at least			43 + 10log <sub>10</sub> (mean output power in watts) dB

**Results:**

normal mode:

carrier frequency	unwanted emission frequency (MHz)	Limit	level (dB) / (dBm) or remark
941.700 MHz			all detected emissions are more than 10 dB below the limit.*
946.750 MHz			
951.800 MHz			
953.050 MHz			
956.050 MHz			
956.650 MHz			
959.650 MHz			

LD mode:

carrier frequency	unwanted emission frequency (MHz)	Limit	level (dB) / (dBm) or remark
941.700 MHz			all detected emissions are more than 10 dB below the limit.*
946.750 MHz			
951.800 MHz			
953.050 MHz			
956.050 MHz			
956.650 MHz			
959.650 MHz			

\*) peaks @ 800 MHz not caused by EUT.

**Plots:** radiated

**normal mode:**

**Plot 1:** 941.70 MHz, 25 MHz – 12.75 GHz

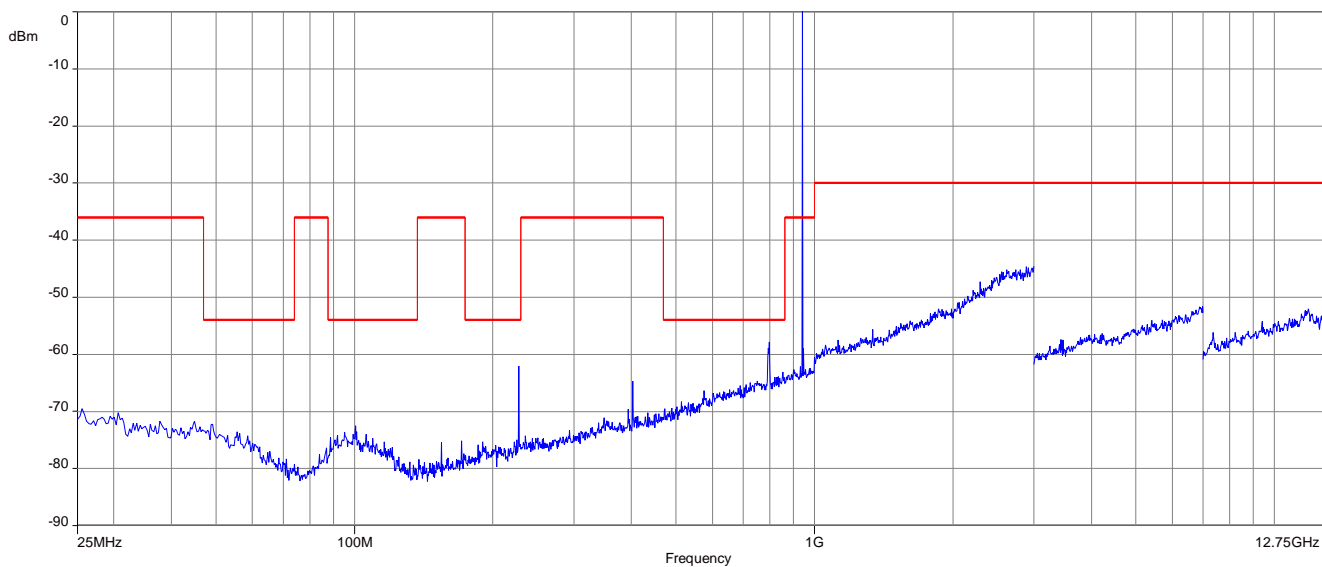

**Plot 2:** 946.75 MHz, 25 MHz – 12.75 GHz

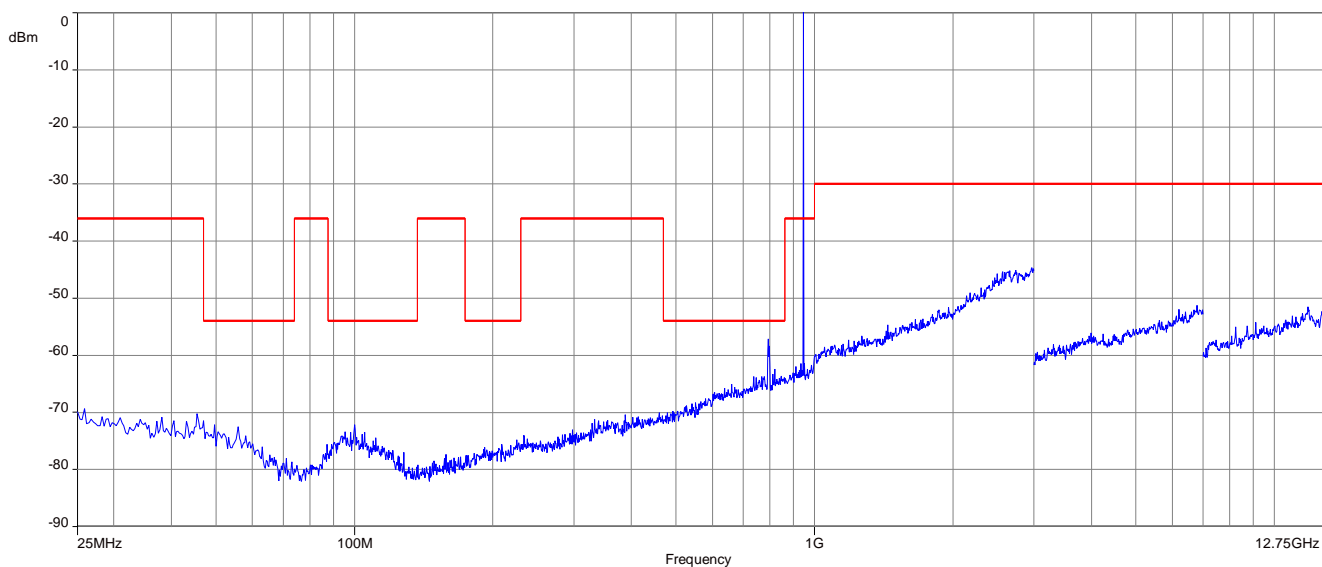



**Plot 3:** 951.80 MHz, 25 MHz – 12.75 GHz

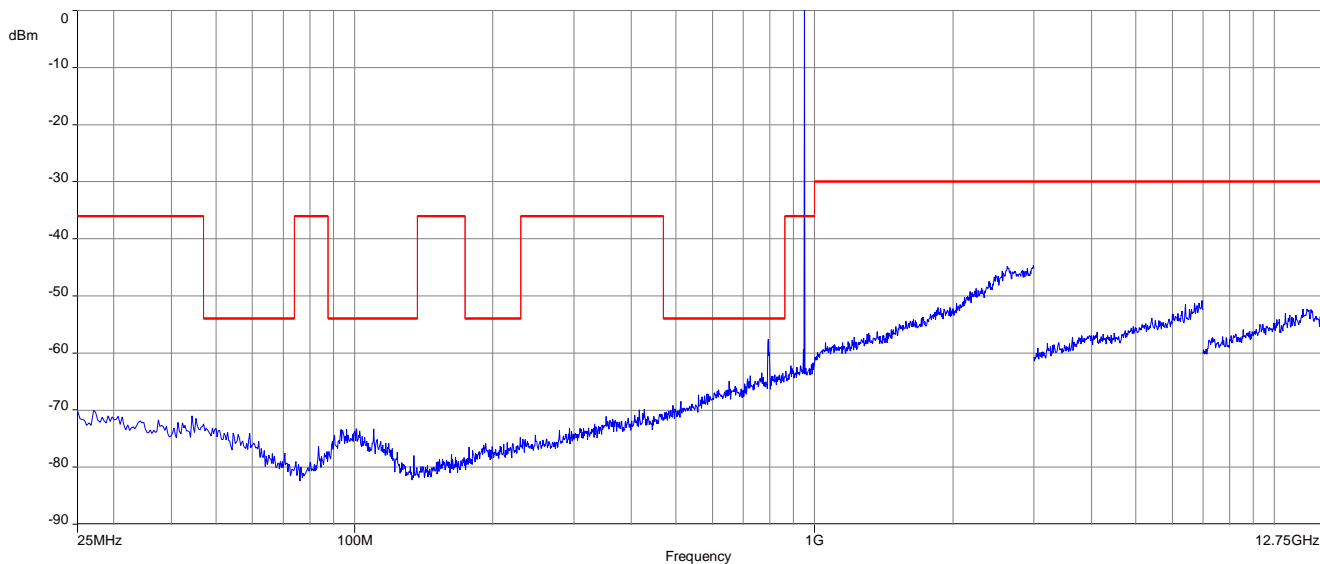

**Plot 4:** 953.05 MHz, 25 MHz – 12.75 GHz

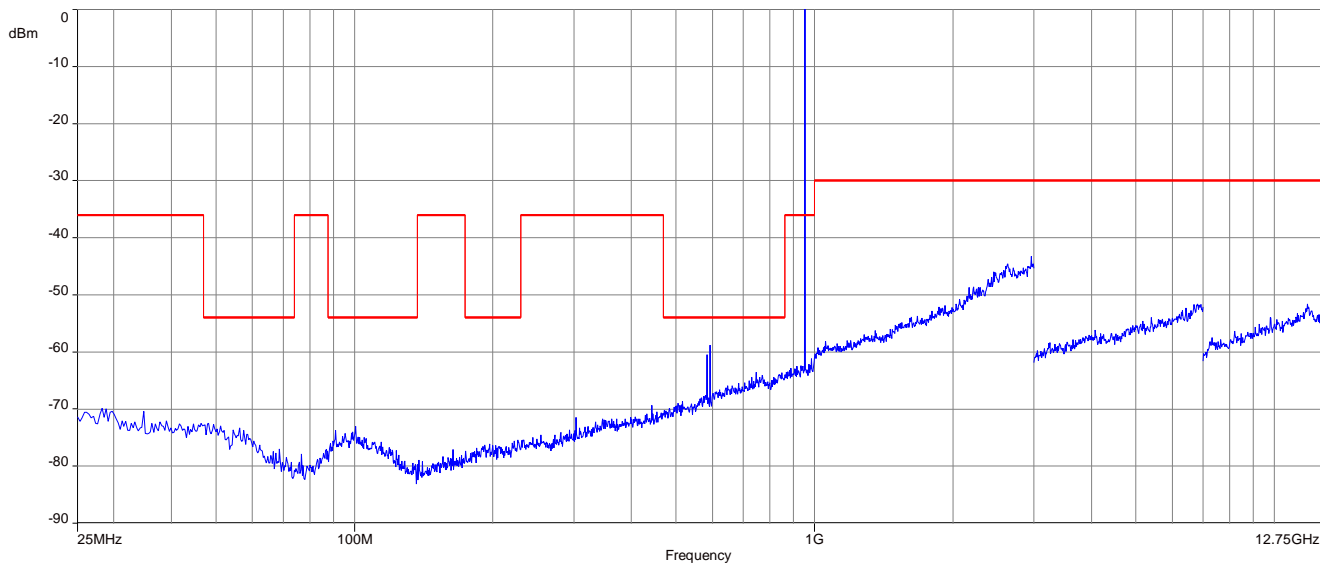

**Plot 5:** 956.05 MHz, 25 MHz – 12.75 GHz

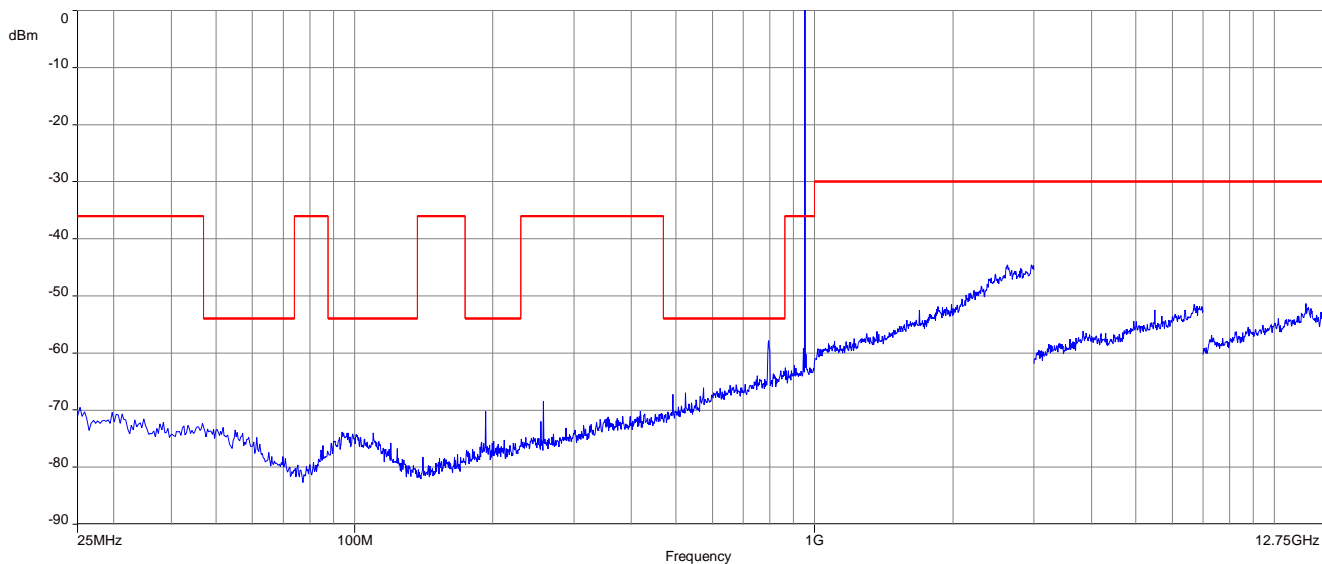

**Plot 6:** 956.65 MHz, 25 MHz – 12.75 GHz

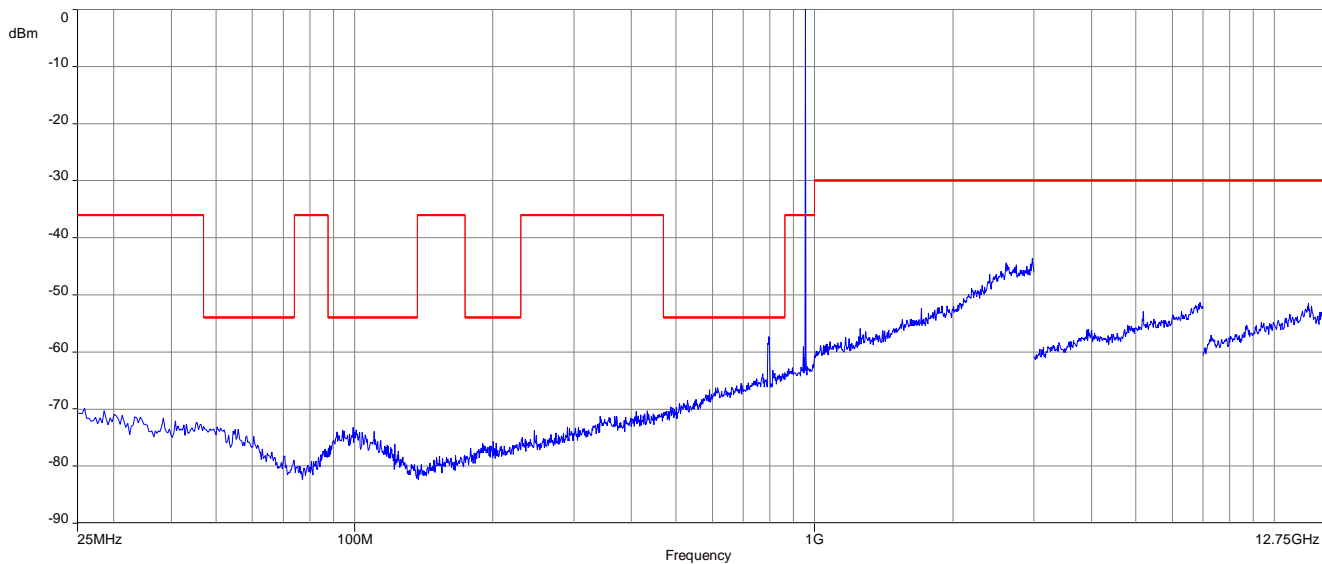

**Plot 7:** 959.65 MHz, 25 MHz – 12.75 GHz

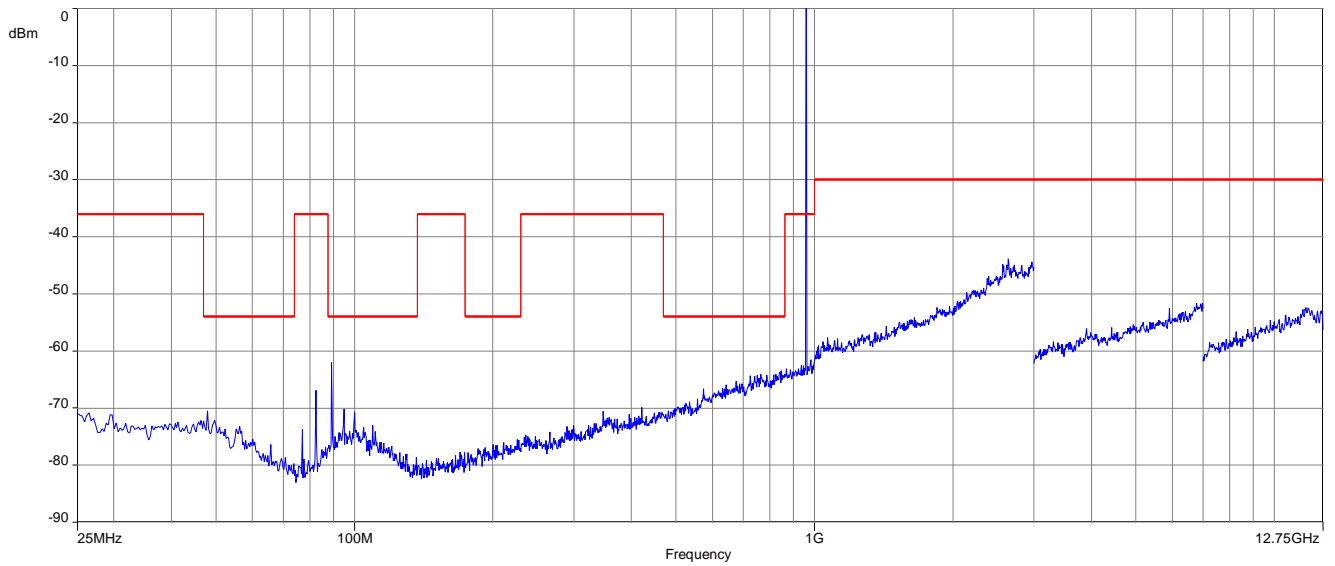

**LD mode:**

**Plot 1:** 941.70 MHz, 25 MHz – 12.75 GHz

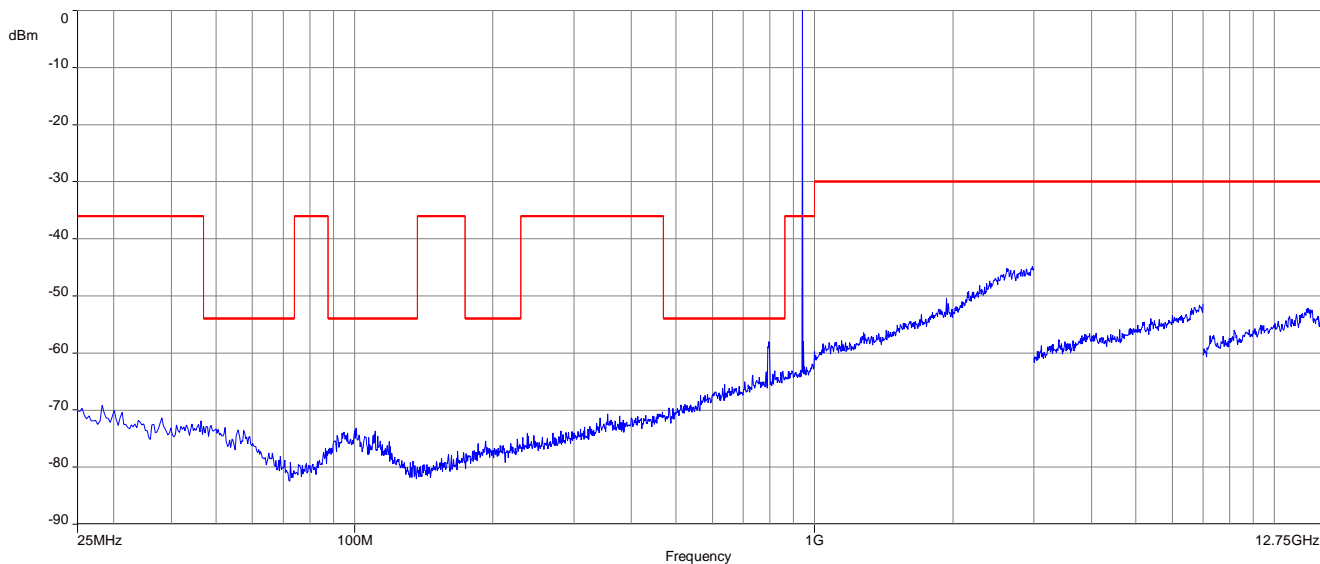

**Plot 2:** 946.75 MHz, 25 MHz – 12.75 GHz

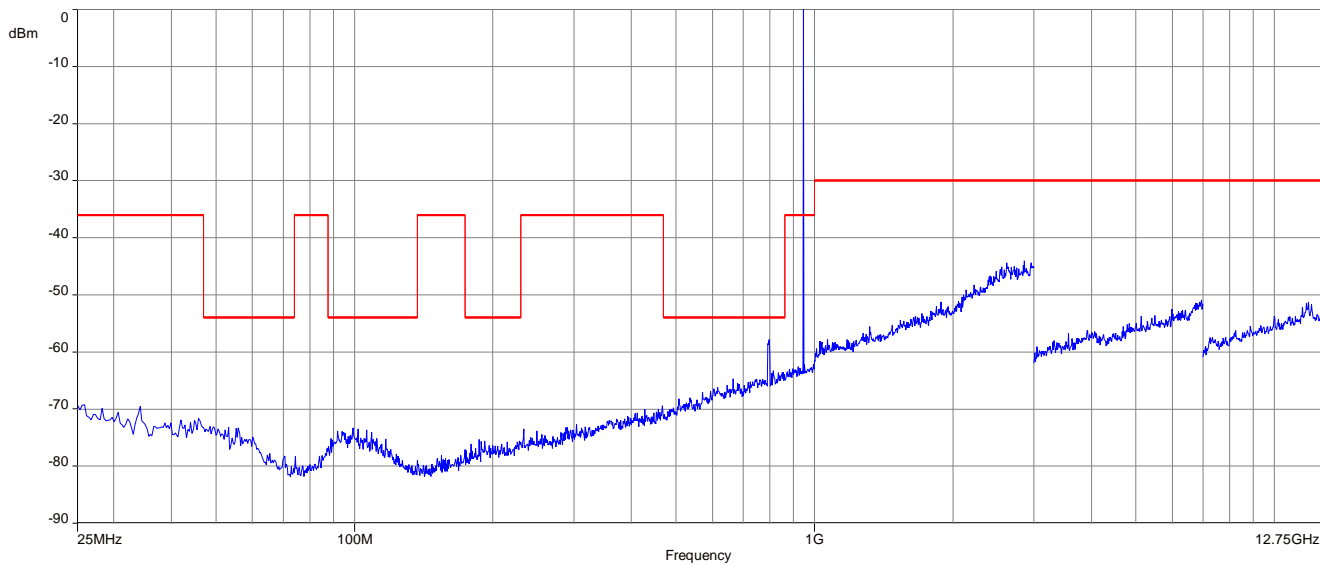

**Plot 3:** 951.80 MHz, 25 MHz – 12.75 GHz

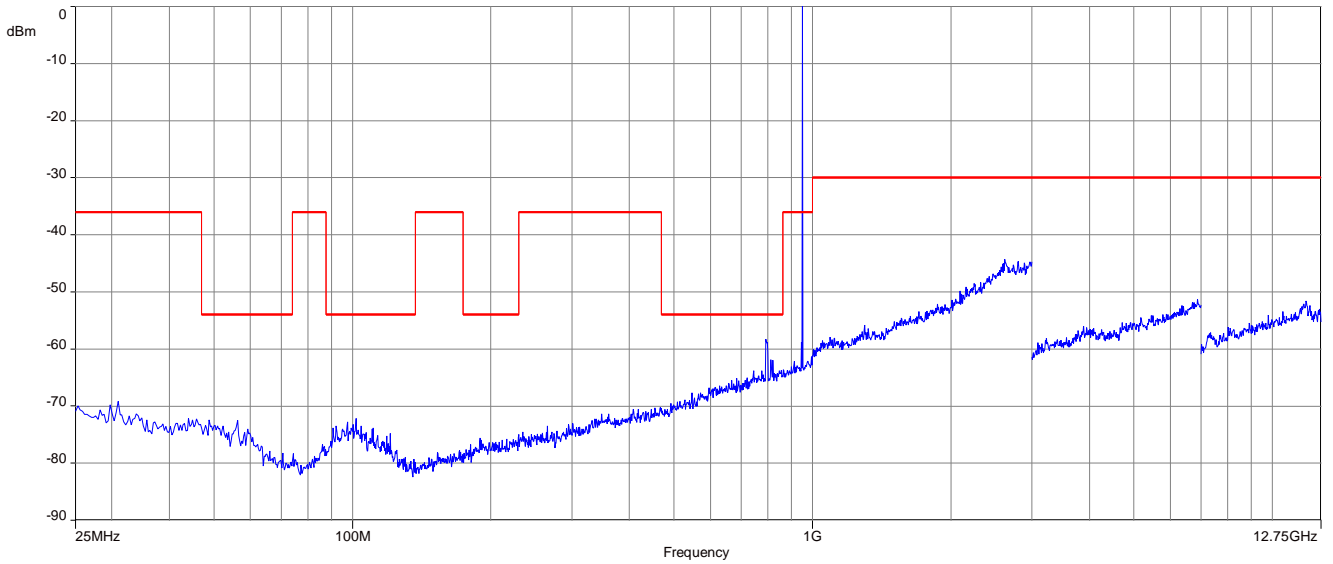

**Plot 4:** 953.05 MHz, 25 MHz – 12.75 GHz

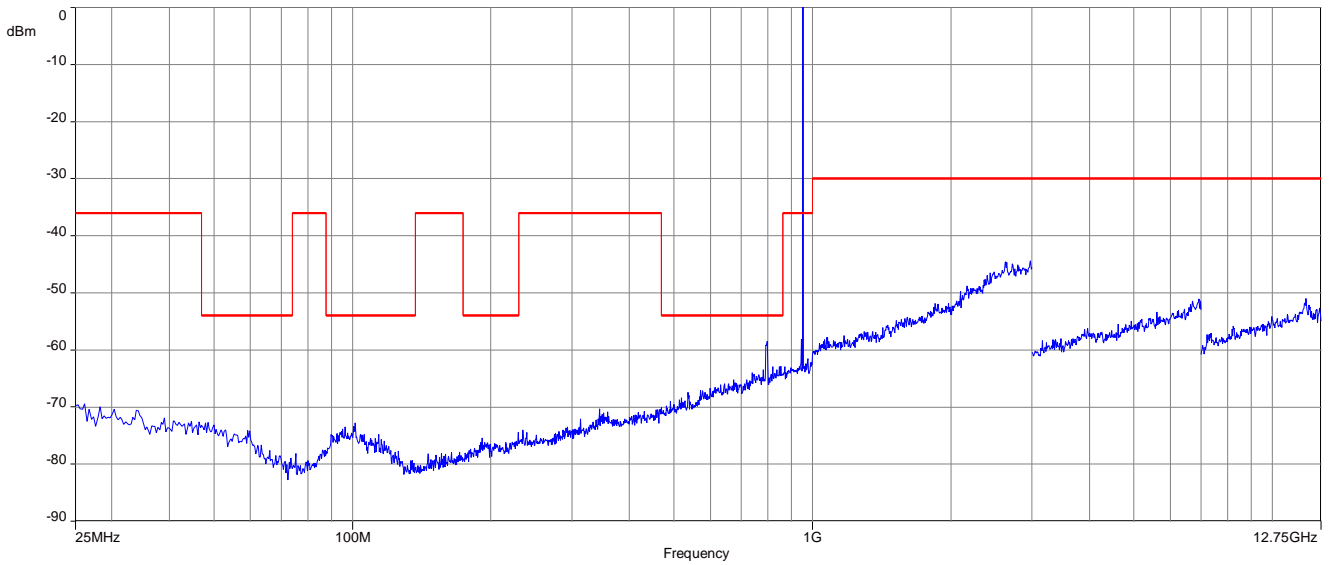

**Plot 5:** 956.05 MHz, 25 MHz – 12.75 GHz

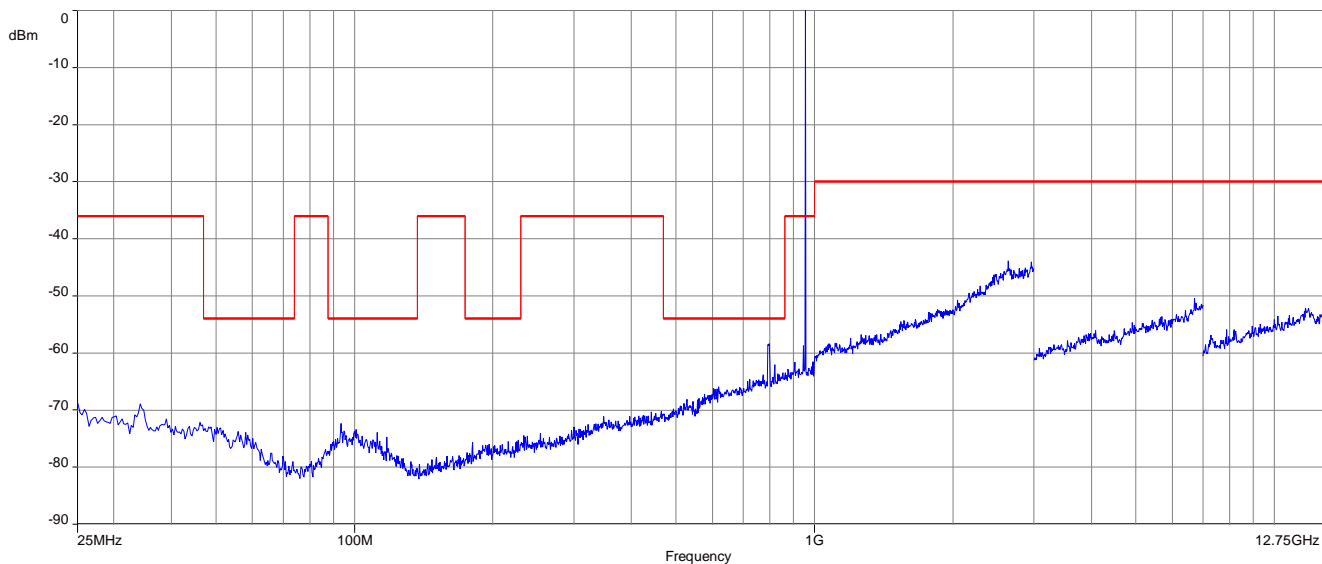

**Plot 6:** 956.65 MHz, 25 MHz – 12.75 GHz

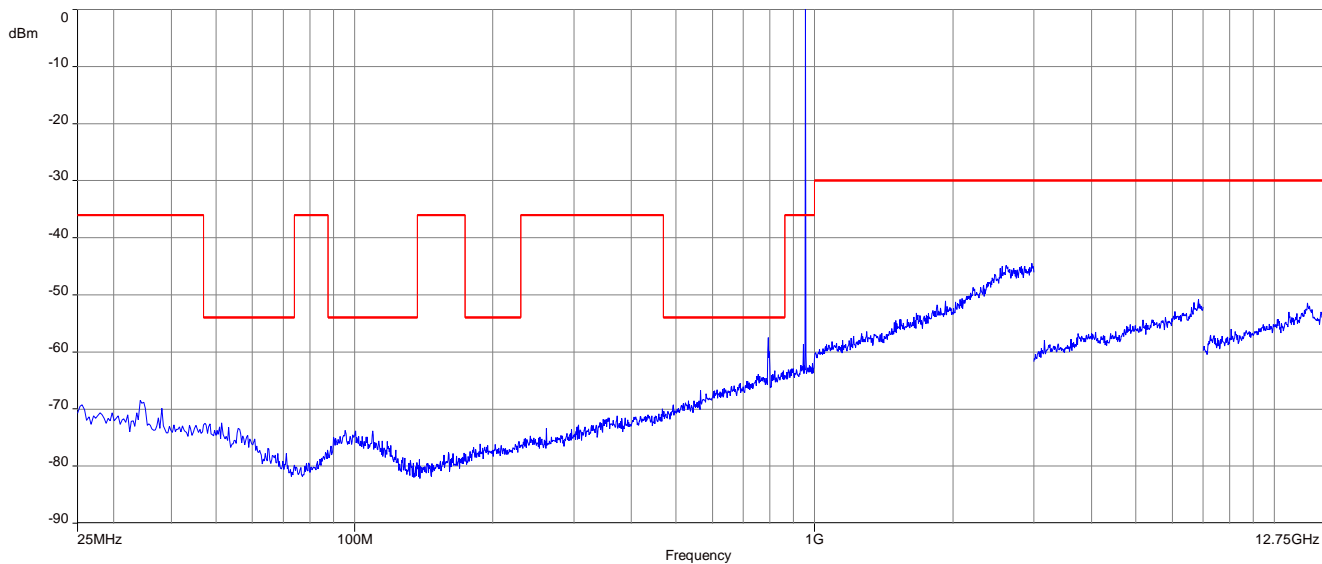

**Plot 7:** 959.65 MHz, 25 MHz – 12.75 GHz

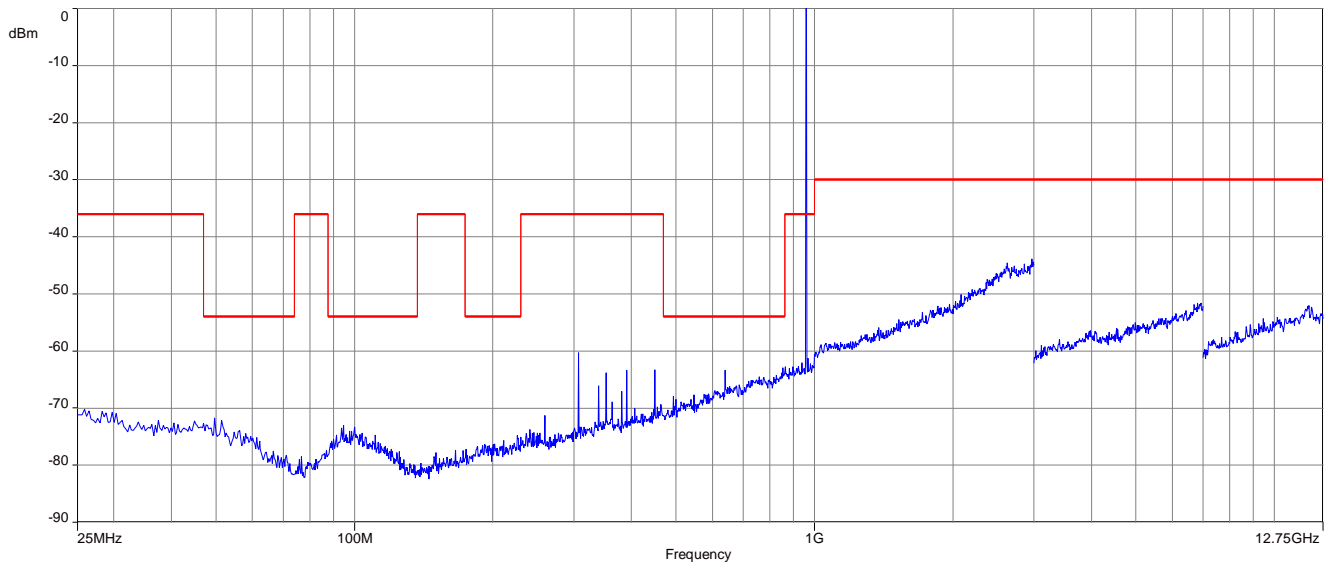

## 12.5 Necessary bandwidth (BN) for digital systems

### Measurement:

Measurement parameter	
Detector:	Peak / Average (-90 dBc point only)
Sweep time:	Auto
Resolution bandwidth:	1 kHz
Video bandwidth:	1 kHz
Span:	$f_c - 1 \text{ MHz}$ to $f_c + 1 \text{ MHz}$ (2 MHz)
Trace mode:	Max hold/view
EUT:	CW and MC
Test setup:	See sub clause 7.2 - A
Measurement uncertainty:	See sub clause 9

**Limits:** according to ETSI EN 300 422-1 v1.4.2

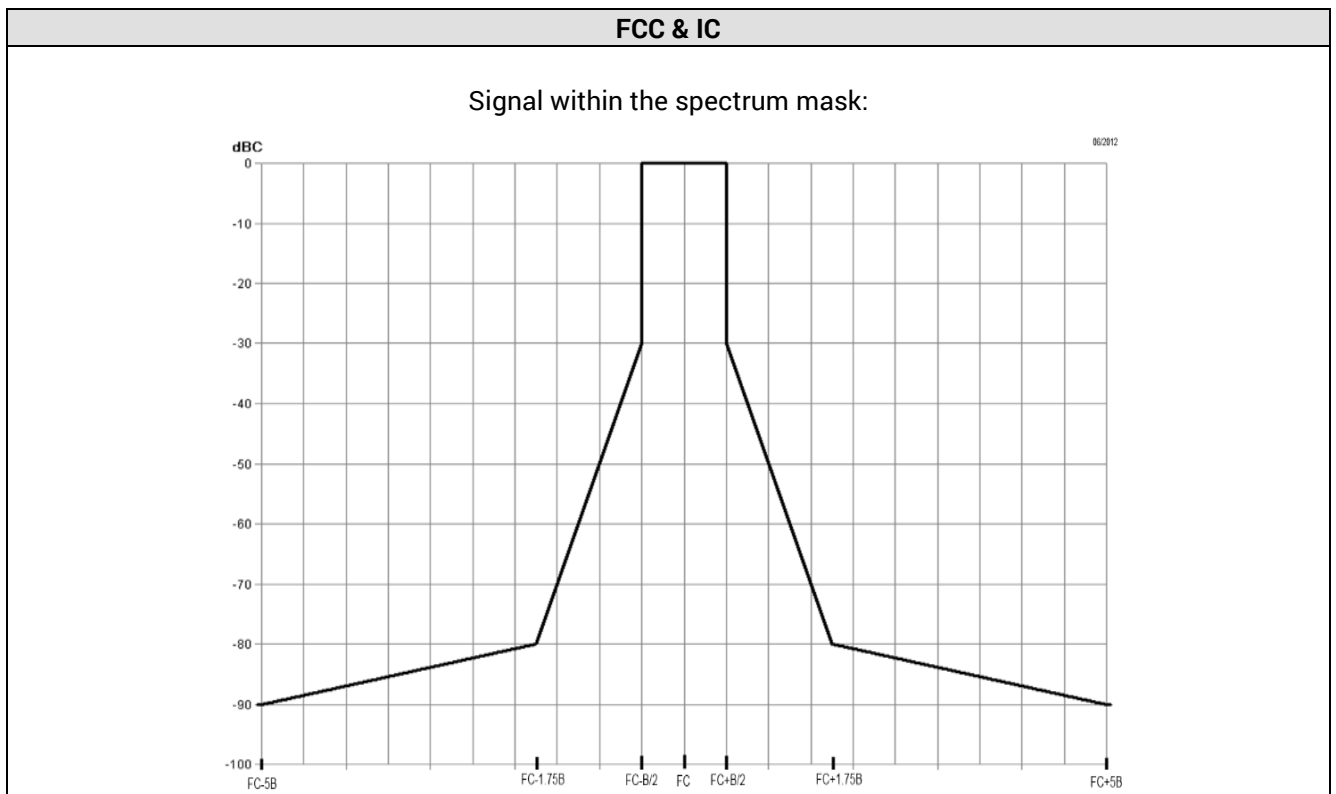

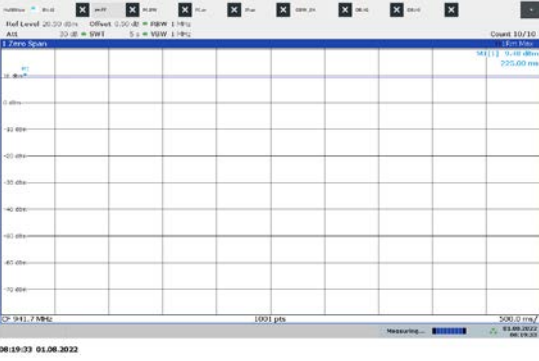
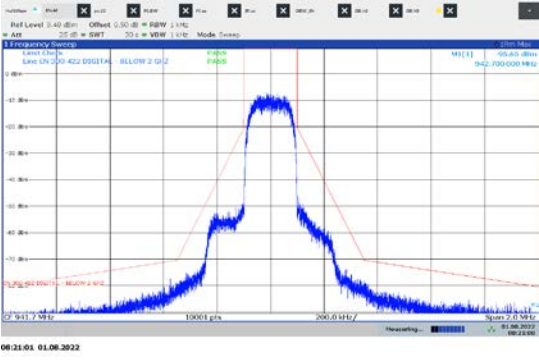
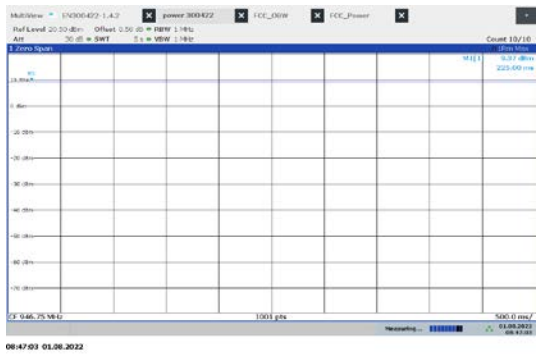
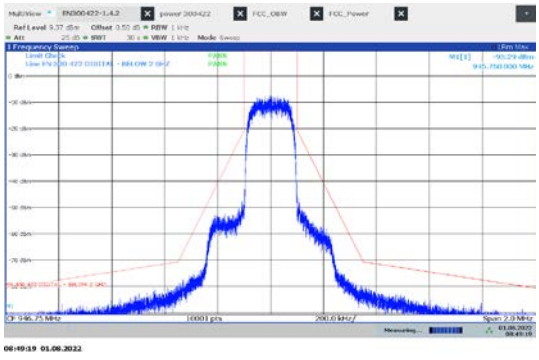
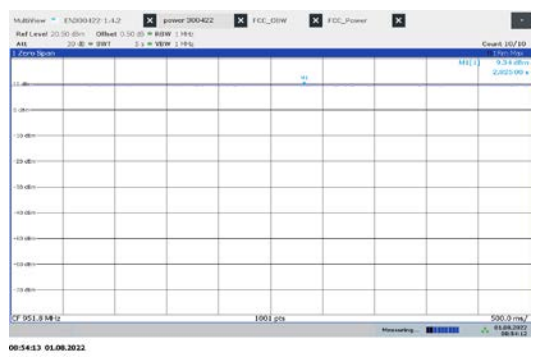
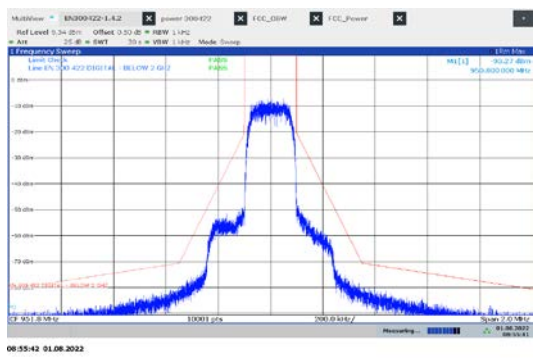

**Plots normal mode:**

Frequency	Carrier power	Modulated carrier
941.70 MHz	 <p>Carrier power plot for 941.70 MHz. The y-axis represents power in dBm, ranging from -100 to 20. The x-axis represents frequency in MHz, ranging from 941.6 to 941.8. The plot shows a flat line at approximately -100 dBm across the entire frequency range. The plot title is 'Carrier power' and the frequency is '941.70 MHz'.</p>	 <p>Modulated carrier plot for 941.70 MHz. The y-axis represents power in dBm, ranging from -100 to 20. The x-axis represents frequency in MHz, ranging from 941.6 to 941.8. The plot shows a signal with a peak at approximately -10 dBm. The plot title is 'Modulated carrier' and the frequency is '941.70 MHz'.</p>
946.75 MHz	 <p>Carrier power plot for 946.75 MHz. The y-axis represents power in dBm, ranging from -100 to 20. The x-axis represents frequency in MHz, ranging from 946.7 to 946.8. The plot shows a flat line at approximately -100 dBm across the entire frequency range. The plot title is 'Carrier power' and the frequency is '946.75 MHz'.</p>	 <p>Modulated carrier plot for 946.75 MHz. The y-axis represents power in dBm, ranging from -100 to 20. The x-axis represents frequency in MHz, ranging from 946.7 to 946.8. The plot shows a signal with a peak at approximately -10 dBm. The plot title is 'Modulated carrier' and the frequency is '946.75 MHz'.</p>
951.80 MHz	 <p>Carrier power plot for 951.80 MHz. The y-axis represents power in dBm, ranging from -100 to 20. The x-axis represents frequency in MHz, ranging from 951.7 to 951.9. The plot shows a flat line at approximately -100 dBm across the entire frequency range. The plot title is 'Carrier power' and the frequency is '951.80 MHz'.</p>	 <p>Modulated carrier plot for 951.80 MHz. The y-axis represents power in dBm, ranging from -100 to 20. The x-axis represents frequency in MHz, ranging from 951.7 to 951.9. The plot shows a signal with a peak at approximately -10 dBm. The plot title is 'Modulated carrier' and the frequency is '951.80 MHz'.</p>

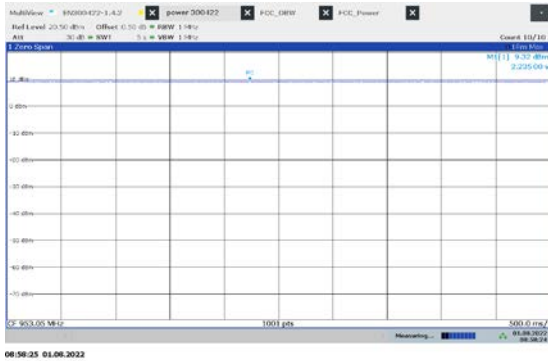
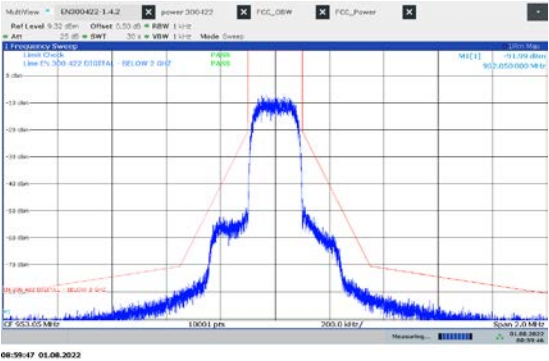
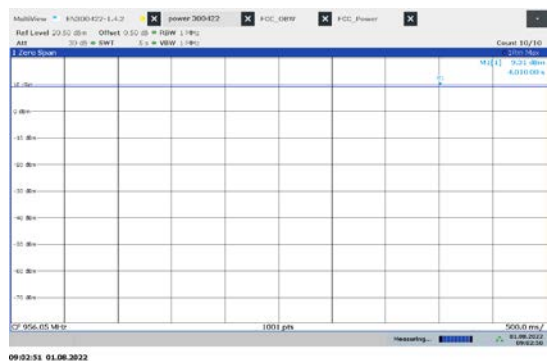
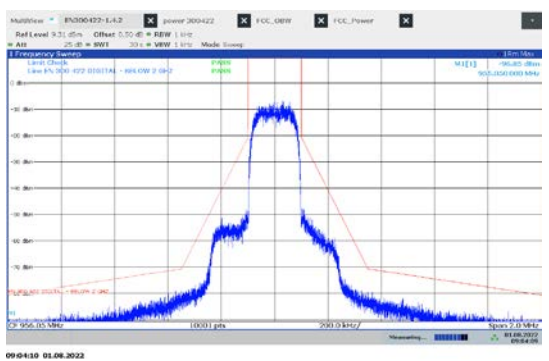
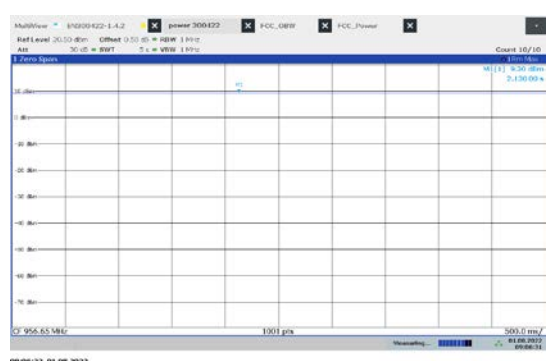
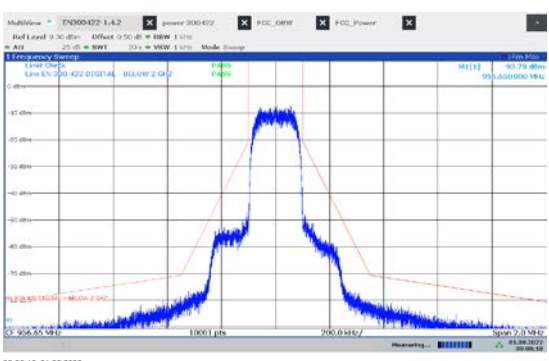
Frequency	Carrier power	Modulated carrier
953.05 MHz	 <p>Carrier power spectrum for 953.05 MHz. The plot shows a flat line at approximately -100 dBm across the 1000 pts span. The y-axis ranges from -100 dBm to 20 dBm. The x-axis is centered at 953.05 MHz.</p>	 <p>Modulated carrier spectrum for 953.05 MHz. The plot shows a peak at approximately -10 dBm with a bandwidth of 200.0 kHz. The y-axis ranges from -100 dBm to 0 dBm. The x-axis is centered at 953.05 MHz.</p>
956.05 MHz	 <p>Carrier power spectrum for 956.05 MHz. The plot shows a flat line at approximately -100 dBm across the 1000 pts span. The y-axis ranges from -100 dBm to 20 dBm. The x-axis is centered at 956.05 MHz.</p>	 <p>Modulated carrier spectrum for 956.05 MHz. The plot shows a peak at approximately -10 dBm with a bandwidth of 200.0 kHz. The y-axis ranges from -100 dBm to 0 dBm. The x-axis is centered at 956.05 MHz.</p>
956.65 MHz	 <p>Carrier power spectrum for 956.65 MHz. The plot shows a flat line at approximately -100 dBm across the 1000 pts span. The y-axis ranges from -100 dBm to 20 dBm. The x-axis is centered at 956.65 MHz.</p>	 <p>Modulated carrier spectrum for 956.65 MHz. The plot shows a peak at approximately -10 dBm with a bandwidth of 200.0 kHz. The y-axis ranges from -100 dBm to 0 dBm. The x-axis is centered at 956.65 MHz.</p>

959.65 MHz

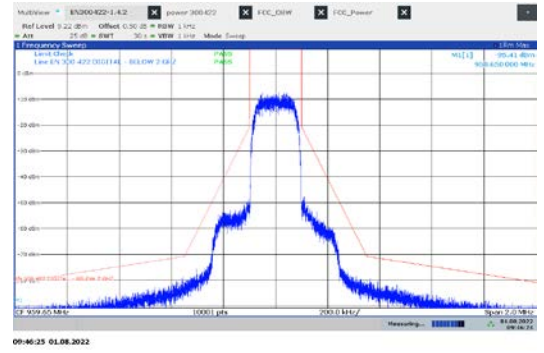
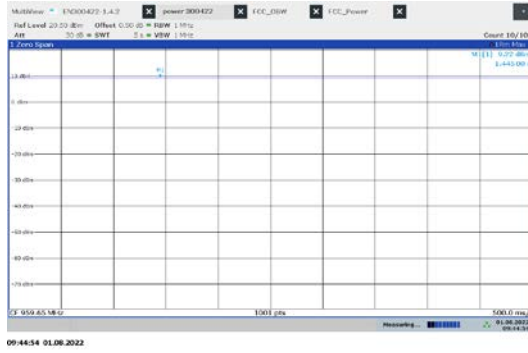

**Plots LD mode:**

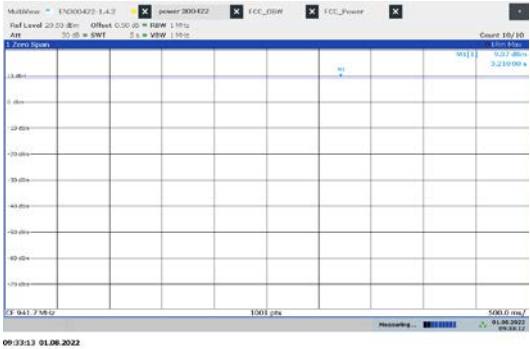
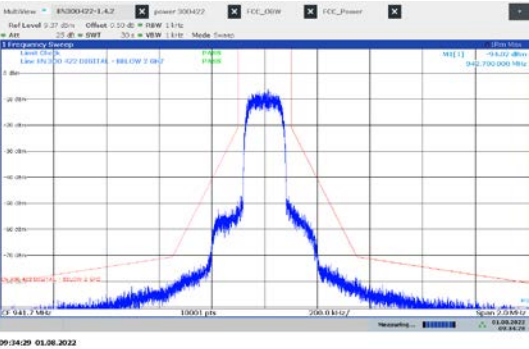
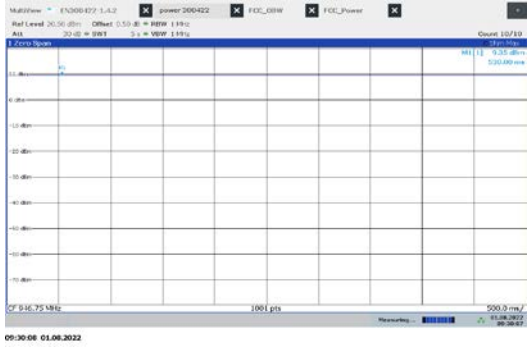
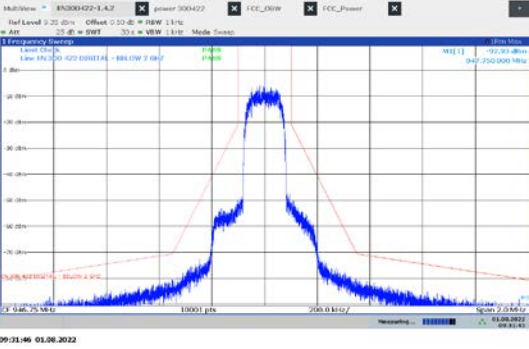
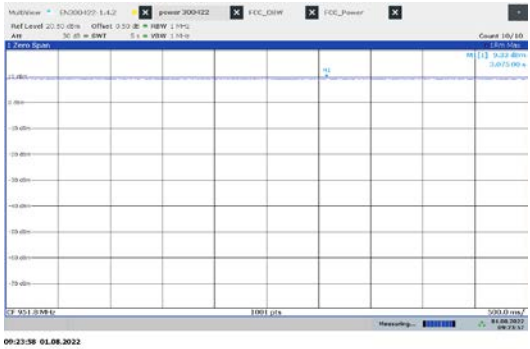
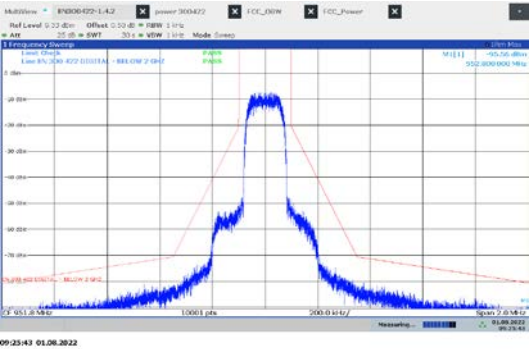
Frequency	Carrier power	Modulated carrier
941.70 MHz	 <p>Carrier power plot for 941.70 MHz. The y-axis ranges from -110 dBm to -3 dBm. The plot shows a flat line at approximately -110 dBm across the entire frequency span. The x-axis is labeled '1000 pts'.</p>	 <p>Modulated carrier plot for 941.70 MHz. The y-axis ranges from -110 dBm to 0 dBm. The plot shows a sharp peak at approximately -30 dBm. The x-axis is labeled '1000 pts'.</p>
946.75 MHz	 <p>Carrier power plot for 946.75 MHz. The y-axis ranges from -110 dBm to 15 dBm. The plot shows a flat line at approximately -110 dBm across the entire frequency span. The x-axis is labeled '1000 pts'.</p>	 <p>Modulated carrier plot for 946.75 MHz. The y-axis ranges from -110 dBm to 0 dBm. The plot shows a sharp peak at approximately -30 dBm. The x-axis is labeled '1000 pts'.</p>
951.80 MHz	 <p>Carrier power plot for 951.80 MHz. The y-axis ranges from -110 dBm to -3 dBm. The plot shows a flat line at approximately -110 dBm across the entire frequency span. The x-axis is labeled '1000 pts'.</p>	 <p>Modulated carrier plot for 951.80 MHz. The y-axis ranges from -110 dBm to 0 dBm. The plot shows a sharp peak at approximately -30 dBm. The x-axis is labeled '1000 pts'.</p>

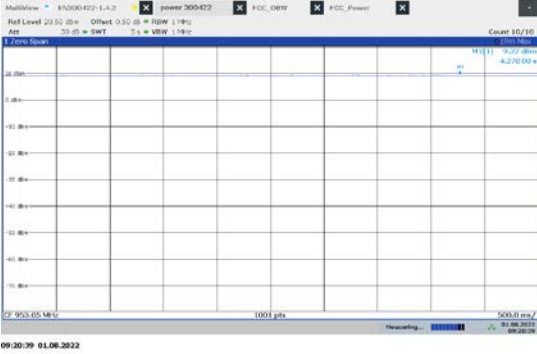
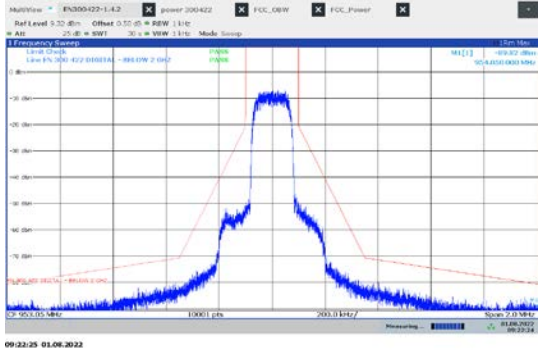
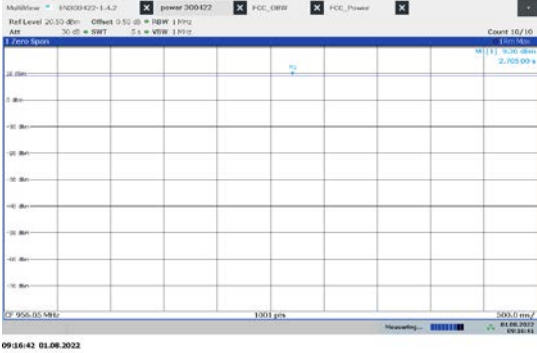
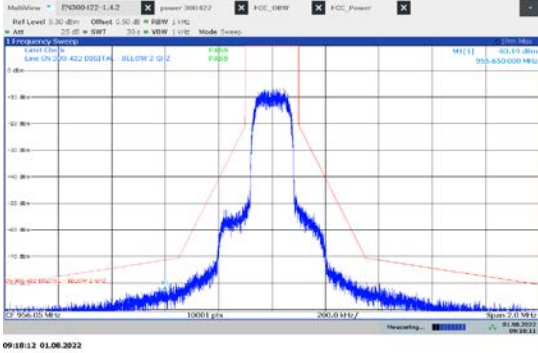
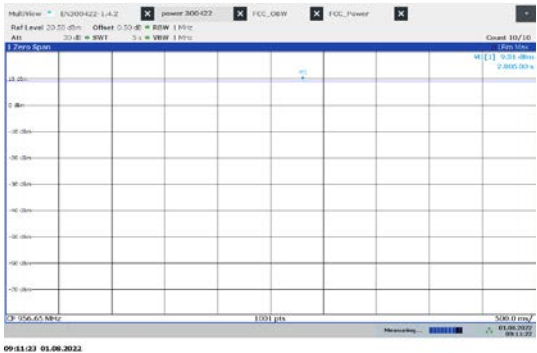
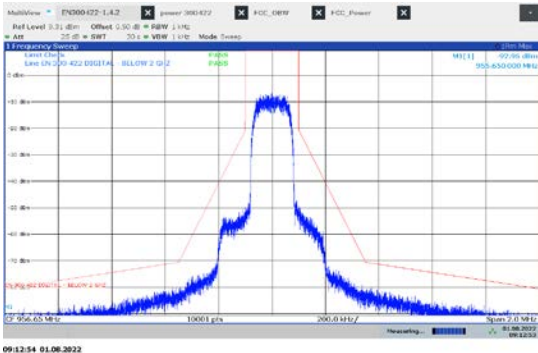
Frequency	Carrier power	Modulated carrier
953.05 MHz		
956.05 MHz		
956.65 MHz		

959.65 MHz

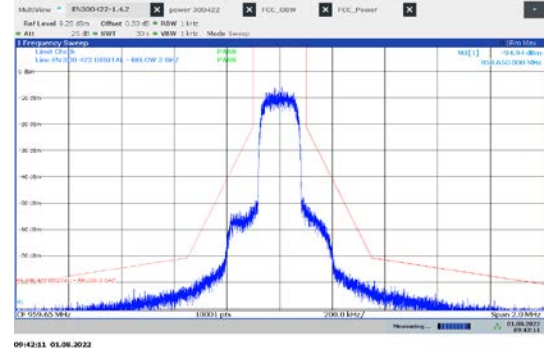
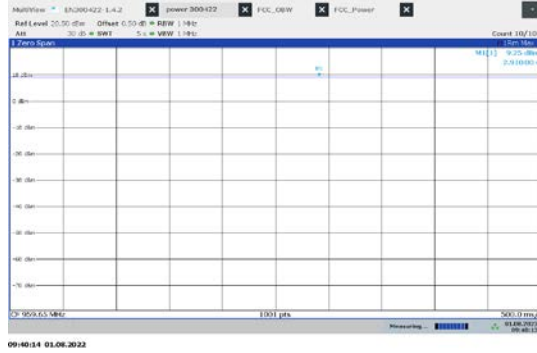

## 13 Observations

No observations except those reported with the single test cases have been made.

## 14 Glossary

<b>EUT</b>	Equipment under test
<b>DUT</b>	Device under test
<b>UUT</b>	Unit under test
<b>GUE</b>	GNSS User Equipment
<b>ETSI</b>	European Telecommunications Standards Institute
<b>EN</b>	European Standard
<b>FCC</b>	Federal Communications Commission
<b>FCC ID</b>	Company Identifier at FCC
<b>IC</b>	Industry Canada
<b>PMN</b>	Product marketing name
<b>HMN</b>	Host marketing name
<b>HVIN</b>	Hardware version identification number
<b>FVIN</b>	Firmware version identification number
<b>EMC</b>	Electromagnetic Compatibility
<b>HW</b>	Hardware
<b>SW</b>	Software
<b>Inv. No.</b>	Inventory number
<b>S/N or SN</b>	Serial number
<b>C</b>	Compliant
<b>NC</b>	Not compliant
<b>NA</b>	Not applicable
<b>NP</b>	Not performed
<b>PP</b>	Positive peak
<b>QP</b>	Quasi peak
<b>AVG</b>	Average
<b>OC</b>	Operating channel
<b>OCW</b>	Operating channel bandwidth
<b>OBW</b>	Occupied bandwidth
<b>OOB</b>	Out of band
<b>DFS</b>	Dynamic frequency selection
<b>CAC</b>	Channel availability check
<b>OP</b>	Occupancy period
<b>NOP</b>	Non occupancy period
<b>DC</b>	Duty cycle
<b>PER</b>	Packet error rate
<b>CW</b>	Clean wave
<b>MC</b>	Modulated carrier
<b>WLAN</b>	Wireless local area network
<b>RLAN</b>	Radio local area network
<b>DSSS</b>	Dynamic sequence spread spectrum
<b>OFDM</b>	Orthogonal frequency division multiplexing
<b>FHSS</b>	Frequency hopping spread spectrum
<b>GNSS</b>	Global Navigation Satellite System
<b>C/N<sub>0</sub></b>	Carrier to noise-density ratio, expressed in dB-Hz



## 15 Document history

Version	Applied changes	Date of release
-/-	Initial release	2022-08-11
A	Annex info update	2022-09-07
B	Updated IC information	2022-10-10
C	Updated HVIN information	2022-10-17

## 16 Accreditation Certificate – D-PL-12076-01-04

first page	last page
 <p>The first page of the accreditation certificate includes the DAKKS logo (Deutsche Akkreditierungsstelle), the company name Deutsche Akkreditierungsstelle GmbH, and accreditation details for CTC advanced GmbH. It states that the laboratory is competent under the terms of DIN EN ISO/IEC 17025:2018 for testing in the fields of Telecommunication (TC) and Electromagnetic Compatibility (EMC) for Canadian Standards. The registration number is D-PL-12076-01-04. A signature of the Head of Division is present, dated 09.06.2020.</p>	 <p>The last page of the accreditation certificate lists the office addresses: Berlin (Spittelmarkt 10), Frankfurt am Main (Europa-Allee 52), and Braunschweig (Bundesallee 100). It includes a disclaimer regarding the publication of extracts and the accreditation's validity. It also mentions the accreditation was granted pursuant to the Act on the Accreditation Body (AkkStelleG) of 31 July 2009 and provides websites for more information: www.european-accreditation.org, www.ilac.org, and www.iaf.eu.</p>

**Note: The current certificate annex is published on the websites (link see below).**

<https://www.dakks.de/files/data/as/pdf/D-PL-12076-01-04e.pdf>

OR

[https://ctcadvanced.com/app/uploads/2020/06/D-PL-12076-01-04\\_Canada\\_TCEMC.pdf](https://ctcadvanced.com/app/uploads/2020/06/D-PL-12076-01-04_Canada_TCEMC.pdf)

17 Accreditation Certificate – D-PL-12076-01-05

first page	last page
 <p>Deutsche Akkreditierungsstelle GmbH</p> <p>Entrusted according to Section 8 subsection 1 AkkStelleG in connection with Section 1 subsection 1 AkkStelleGBV Signatory to the Multilateral Agreements of EA, ILAC and IAF for Mutual Recognition</p> <p><b>Accreditation</b> </p> <p>The Deutsche Akkreditierungsstelle GmbH attests that the testing laboratory <b>CTC advanced GmbH</b> Untertürkheimer Straße 6-10, 66117 Saarbrücken is competent under the terms of DIN EN ISO/IEC 17025:2018 to carry out tests in the following fields: <b>Telecommunication (FCC Requirements)</b></p> <p>The accreditation certificate shall only apply in connection with the notice of accreditation of 09.06.2020 with the accreditation number D-PL-12076-01. It comprises the cover sheet, the reverse side of the cover sheet and the following annex with a total of 05 pages. Registration number of the certificate: <b>D-PL-12076-01-05</b></p> <p>Frankfurt am Main, 09.06.2020  by <b>Dipl.-Ing. (FH) Ralf Egner</b> Head of Division</p> <p><small>The certificate together with its annex reflects the status at the time of the date of issue. The current status of the scope of accreditation can be found in the database of accredited bodies of Deutsche Akkreditierungsstelle GmbH. <a href="https://www.dakks.de/en/content/accredited-bodies-dakks">https://www.dakks.de/en/content/accredited-bodies-dakks</a> 09.06.2020/0001</small></p>	<p>Deutsche Akkreditierungsstelle GmbH</p> <p>Office Berlin Spittelmarkt 10 10117 Berlin</p> <p>Office Frankfurt am Main Europa-Allee 52 60527 Frankfurt am Main</p> <p>Office Braunschweig Bundesallee 100 38116 Braunschweig</p> <p>The publication of extracts of the accreditation certificate is subject to the prior written approval by Deutsche Akkreditierungsstelle GmbH (DAkKS). Exempted is the unchanged form of separate disseminations of the cover sheet by the conformity assessment body mentioned overleaf.</p> <p>No impression shall be made that the accreditation also extends to fields beyond the scope of accreditation attested by DAkKS.</p> <p>The accreditation was granted pursuant to the Act on the Accreditation Body (AkkStelleG) of 31 July 2009 (Federal Law Gazette I p. 2625) and the Regulation (EC) No 765/2008 of the European Parliament and of the Council of 9 July 2008 setting out the requirements for accreditation and market surveillance relating to the marketing of products (Official Journal of the European Union L 218 of 9 July 2008, p. 30). DAkKS is a signatory to the Multilateral Agreements for Mutual Recognition of the European co-operation for Accreditation (EA), International Accreditation Forum (IAF) and International Laboratory Accreditation Cooperation (ILAC). The signatories to these agreements recognise each other's accreditations.</p> <p>The up-to-date state of membership can be retrieved from the following websites: EA: <a href="http://www.european-accreditation.org">www.european-accreditation.org</a> ILAC: <a href="http://www.ilac.org">www.ilac.org</a> IAF: <a href="http://www.iaf.nu">www.iaf.nu</a></p>

Note: The current certificate annex is published on the websites (link see below).

<https://www.dakks.de/files/data/as/pdf/D-PL-12076-01-05e.pdf>

or

[https://ctcadvanced.com/app/uploads/2020/06/D-PL-12076-01-05\\_TCB\\_USA.pdf](https://ctcadvanced.com/app/uploads/2020/06/D-PL-12076-01-05_TCB_USA.pdf)

##### END OF TEST REPORT #####