



# TEST REPORT

Test Report No.: 1-2868/21-03-02

BNetzA-CAB-02/21-102

## Testing Laboratory

### CTC advanced GmbH

Untertuerkheimer Strasse 6 – 10  
 66117 Saarbruecken/Germany  
 Phone: + 49 681 5 98 - 0  
 Fax: + 49 681 5 98 - 9075  
 Internet: <https://www.ctcadvanced.com>  
 e-mail: [mail@ctcadvanced.com](mailto:mail@ctcadvanced.com)

### Accredited Test Laboratory:

The testing laboratory (area of testing) is accredited according to DIN EN ISO/IEC 17025 (2018-03) by the Deutsche Akkreditierungsstelle GmbH (DAkkS). The accreditation is valid for the scope of testing procedures as stated in the accreditation certificate starting with the registration number: D-PL-12076-01.

## Applicant

### Sennheiser electronic GmbH & Co. KG

Am Labor 1  
 30900 Wedemark/GERMANY

Phone: +49 5130 600-0

Contact: Ouajdi Ochi  
 e-mail: [Ouajdi.Ochi@sennheiser.com](mailto:Ouajdi.Ochi@sennheiser.com)  
 Phone: +49 5130 600 1482  
 Fax: +49 5130 600 76 1465

## Manufacturer

### Sennheiser electronic GmbH & Co. KG

Am Labor 1  
 30900 Wedemark/GERMANY

## Test Standards

IEEE 1528-2013 Recommended Practice for Determining the Peak Spatial-Average Specific Absorption Rate (SAR) in the Human Head from Wireless Communications Devices: Measurement Techniques  
 RSS-102 Issue 5 Radio Frequency Exposure Compliance of Radiocommunication Apparatus (All Frequency Bands)

For further applied test standards please refer to section 3 of this test report.

## Test Item

Kind of test item:	Handheld Transmitter
Device type:	portable device
Model name:	<b>EW-DX SKM</b>
Series:	Evolution Wireless Digital
S/N serial number:	1122000099 / 1122000054
FCC-ID:	DMOSKMSEWD
ISED Number:	2099A-SKMSEWD
Product Marketing Name (PMN):	EW-DX SKM
Hardware Version Identification No. (HVIN):	EW-DX SKM
HVIN:	0.7.0
Hardware status:	583750_07
Firmware version:	0.7.0
Software status:	-/-
Frequency:	see technical details
Antenna:	integrated antenna
Battery option:	2 x 1.5V rechargeable batteries
Test sample status:	identical prototype
Exposure category:	general population / uncontrolled environment

This test report is electronically signed and valid without handwritten signature. For verification of the electronic signatures, the public keys can be requested at the testing laboratory.

## Test Report authorised:

Alexander Hnatovskiy  
 Lab Manager  
 Radio Communications

## Test performed:

p.p.  
 Marco Scigliano  
 Testing Manager  
 Radio Communications

<b>1</b>	<b>Table of contents</b>	<b>2</b>
1	Table of contents .....	2
2	General information .....	3
2.1	Notes and disclaimer .....	3
2.2	Application details .....	3
2.3	Statement of compliance .....	3
2.4	Technical details .....	4
3	Test standards/ procedures references .....	5
3.1	RF exposure limits .....	6
4	Reporting statements of conformity – decision rule .....	7
5	Summary of Measurement Results .....	8
6	Test Environment .....	8
7	Test Set-up .....	9
7.1	Measurement system .....	9
7.1.1	System Description .....	9
7.1.2	Test environment .....	10
7.1.3	Probe description .....	10
7.1.4	Phantom description .....	11
7.1.5	Device holder description .....	12
7.1.6	Scanning procedure .....	13
7.1.7	Comparison of DASY 52 NEO and cDASY6/DASY8 .....	17
7.1.8	Spatial Peak SAR Evaluation .....	18
7.1.9	Data Storage and Evaluation .....	21
7.1.10	Tissue simulating liquids: dielectric properties .....	23
7.1.11	Tissue simulating liquids: parameters .....	23
7.1.12	Measurement uncertainty evaluation for SAR test .....	24
7.1.13	Measurement uncertainty evaluation for System Check .....	26
7.1.14	System check .....	28
7.1.15	System check procedure .....	28
7.1.16	System validation .....	29
8	Detailed Test Results .....	30
8.1	Conducted power measurements .....	30
8.1.1	Conducted average power measurements Bluetooth LE 2.4 GHz .....	30
8.2	SAR test results .....	30
8.2.1	General description of test procedures .....	30
8.2.2	Results overview .....	31
8.2.3	Multiple Transmitter Information .....	31
9	Test equipment and ancillaries used for tests .....	32
10	Observations .....	32
Annex A:	System performance check .....	33
Annex B:	DASY measurement results .....	36
Annex B.1:	Liquid depth .....	39
Annex C:	Photo documentation .....	40
Annex D:	Calibration parameters .....	40
Annex E:	RSS-102 Annex A1 .....	40
Annex F:	Document History .....	41
Annex G:	Further Information .....	41

## 2 General information

### 2.1 Notes and disclaimer

The test results of this test report relate exclusively to the test item specified in this test report. CTC advanced GmbH does not assume responsibility for any conclusions and generalisations drawn from the test results with regard to other specimens or samples of the type of the equipment represented by the test item. The test report may only be reproduced or published in full. Reproduction or publication of extracts from the report requires the prior written approval of CTC advanced GmbH.

This test report is electronically signed and valid without handwriting signature. For verification of the electronic signatures, the public keys can be requested at the testing laboratory.

The testing service provided by CTC advanced GmbH has been rendered under the current "General Terms and Conditions for CTC advanced GmbH".

CTC advanced GmbH will not be liable for any loss or damage resulting from false, inaccurate, inappropriate or incomplete product information provided by the customer.

Under no circumstances does the CTC advanced GmbH test report include any endorsement or warranty regarding the functionality, quality or performance of any other product or service provided.

Under no circumstances does the CTC advanced GmbH test report include or imply any product or service warranties from CTC advanced GmbH, including, without limitation, any implied warranties of merchantability, fitness for purpose, or non-infringement, all of which are expressly disclaimed by CTC advanced GmbH.

All rights and remedies regarding vendor's products and services for which CTC advanced GmbH has prepared this test report shall be provided by the party offering such products or services and not by CTC advanced GmbH. In no case this test report can be considered as a Letter of Approval.





### 2.2 Application details

Date of receipt of order:	2022-04-05
Date of receipt of test item:	2022-04-25
Start of test:	2022-04-29
End of test:	2022-05-06

### 2.3 Statement of compliance

The SAR values found for the EW-DX SKM Handheld Transmitter are below the maximum recommended levels of 1.6 W/Kg as averaged over any 1 g tissue according to the FCC rule §2.1093, the ANSI/IEEE C 95.1:1992, the NCRP Report Number 86 for uncontrolled environment, according to the Health Canada's Safety Code 6 and the Industry Canada Radio Standards Specification RSS-102 for General Population/Uncontrolled exposure.

For body worn operation, this device has been tested and meets FCC RF exposure guidelines when used with any accessory that contains no metal and that positions the handset without any distance from the body. Use of other accessories may not ensure compliance with FCC RF exposure guidelines.

Accreditation	Description	
D-PL-12076-01-01	SAR / EMF – EN and FCC <a href="https://www.dakks.de/files/data/as/pdf/D-PL-12076-01-01.pdf">https://www.dakks.de/files/data/as/pdf/D-PL-12076-01-01.pdf</a>	  Deutsche Akkreditierungsstelle D-PL-12076-01-01
D-PL-12076-01-04	Telecommunication and EMC Canada <a href="https://www.dakks.de/files/data/as/pdf/D-PL-12076-01-04e.pdf">https://www.dakks.de/files/data/as/pdf/D-PL-12076-01-04e.pdf</a> <a href="https://www.dakks.de/as/ast/d/D-PL-12076-01-04e.pdf">https://www.dakks.de/as/ast/d/D-PL-12076-01-04e.pdf</a>	  Deutsche Akkreditierungsstelle D-PL-12076-01-04

## 2.4 Technical details

RF Type	Transceiver
Operating frequency range	470.2 – 550 MHz 520 – 607.8 MHz
Number of channels	BLE <sup>1</sup> : 2402 MHz – 2480 MHz BLE: 40 channels UHF: tuning step size (25 kHz < 1 GHz, 100 kHz > 1 GHz)
Channel spacing	BLE: 2 MHz UHF: typ. 600 kHz (LD Mode 300 kHz)
Output Power	BLE: max. 10 dBm EIRP
Bandwidth	BLE: 2 MHz UHF: typ. 200 kHz

BLE<sup>1</sup> - Bluetooth low energy

### 3 Test standards/ procedures references

Test Standard	Version	Test Standard Description
IEEE 1528-2013	2013-06	Recommended Practice for Determining the Peak Spatial-Average Specific Absorption Rate (SAR) in the Human Head from Wireless Communications Devices: Measurement Techniques
RSS-102 Issue 5	2015-03	Radio Frequency Exposure Compliance of Radiocommunication Apparatus (All Frequency Bands)
Canada's Safety Code No. 6	2015-06	Limits of Human Exposure to Radiofrequency Electromagnetic Fields in the Frequency Range from 3 kHz to 300 GHz
IEEE Std. C95-3	2002	IEEE Recommended Practice for the Measurement of Potentially Hazardous Electromagnetic Fields – RF and Microwave
IEEE Std. C95-1	2005	IEEE Standard for Safety Levels with Respect to Human Exposure to Radio Frequency Electromagnetic Fields, 3 kHz to 300 GHz.
IEC 62209-2	2010	Human exposure to radio frequency fields from hand-held and body-mounted wireless communication devices. Human models, instrumentation, and procedures. Procedure to determine the specific absorption rate (SAR) for wireless communication devices used in close proximity to the human body (frequency range of 30 MHz to 6 GHz)
IEC 62209-2: 2010/AMD1:2019	2019	Amendment 1 - Human exposure to radio frequency fields from hand-held and body-mounted wireless communication devices Human models, instrumentation, and procedures - Part 2: Procedure to determine the specific absorption rate (SAR) for wireless communication devices used in close proximity to the human body (frequency range of 30 MHz to 6 GHz)
IEC/IEEE 62209-1528-2020	2020-10-19	Measurement procedure for the assessment of specific absorption rate of human exposure to radio frequency fields from hand-held and body-mounted wireless communication devices – Part 1528: Human models, instrumentation, and procedures (Frequency range of 4 MHz to 10 GHz)
IEC 62209-2:2010/AMD1:2019	2019-05-17	Amendment 1 - Human exposure to radio frequency fields from hand-held and body-mounted wireless communication devices - Human models, instrumentation, and procedures - Part 2: Procedure to determine the specific absorption rate (SAR) for wireless communication devices used in close proximity to the human body (frequency range of 30 MHz to 6 GHz)
FCC KDBs:		
KDB 865664D01v01	August 7, 2015	FCC OET SAR measurement requirements 100 MHz to 6 GHz
KDB 865664D02v01	October 23, 2015	RF Exposure Compliance Reporting and Documentation Considerations
KDB 447498D01v06	October 23, 2015	Mobile and Portable Devices RF Exposure Procedures and Equipment Authorization Policies
KDB 648474D04v01	October 23, 2015	SAR Evaluation Considerations for Wireless Handsets

### 3.1 RF exposure limits

Human Exposure	Uncontrolled Environment General Population	Controlled Environment Occupational
Spatial Peak SAR* (Brain and Trunk)	<b>1.60 mW/g</b>	8.00 mW/g
Spatial Average SAR** (Whole Body)	0.08 mW/g	0.40 mW/g
Spatial Peak SAR*** (Hands/Feet/Ankle/Wrist)	<b>4.00 mW/g</b>	20.00 mW/g

Table 1: RF exposure limits

The limit applied in this test report is shown in bold letters

Notes:

- \* The Spatial Peak value of the SAR averaged over any 1 gram of tissue (defined as a tissue volume in the shape of a cube) and over the appropriate averaging time
- \*\* The Spatial Average value of the SAR averaged over the whole body.
- \*\*\* The Spatial Peak value of the SAR averaged over any 10 grams of tissue (defined as a tissue volume in the shape of a cube) and over the appropriate averaging time.

Uncontrolled Environments are defined as locations where there is the exposure of individuals who have no knowledge or control of their exposure.

Controlled Environments are defined as locations where there is exposure that may be incurred by persons who are aware of the potential for exposure, (i.e. as a result of employment or occupation).

#### 4 Reporting statements of conformity – decision rule

Only the measured values related to their corresponding limits will be used to decide whether the equipment under test meets the requirements of the test standards listed in chapter 3. The measurement uncertainty is mentioned in this test report, see chapter 9, but is not taken into account - neither to the limits nor to the measurement results. Measurement results with a smaller margin to the corresponding limits than the measurement uncertainty have a potential risk of more than 20% that the decision might be wrong."

measured value, measurement uncertainty, verdict

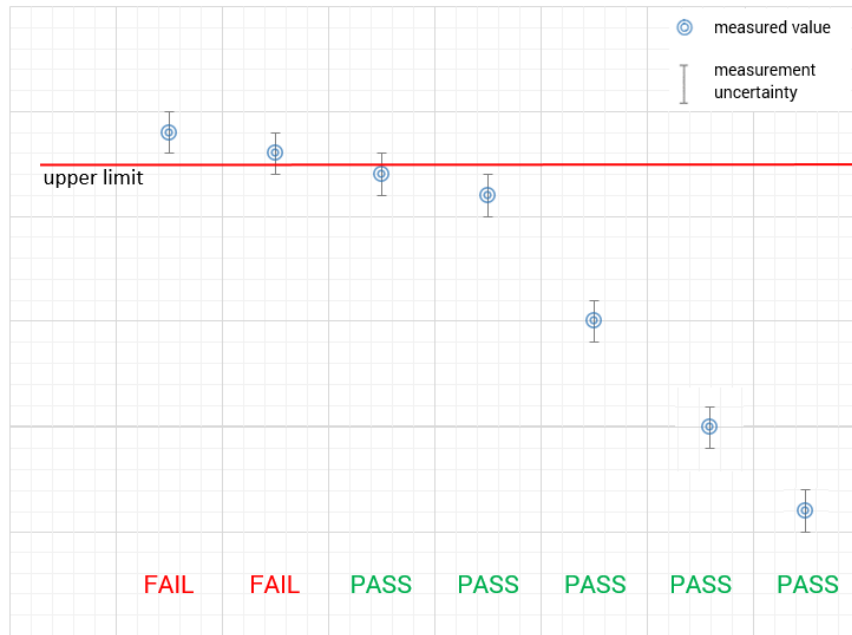

## 5 Summary of Measurement Results

<input checked="" type="checkbox"/>	<b>No deviations from the technical specifications ascertained</b>	
<input type="checkbox"/>	Deviations from the technical specifications ascertained	
<b>Maximum SAR value (W/kg)</b>		
	<b>reported</b>	<b>limit</b>
<b>body worn 0 mm distance for 1g</b>	<b>0.065</b>	<b>1.6</b>
<b>collocated situations <math>\Sigma</math>SAR<sub>1g</sub> evaluation</b>	<b>0.098</b>	<b>1.6</b>
<b>limb worn 0 mm distance for 10g</b>	<b>0.030</b>	<b>4.0</b>
<b>collocated situations <math>\Sigma</math>SAR<sub>10g</sub> evaluation</b>	<b>0.047</b>	<b>4.0</b>

## 6 Test Environment

Ambient temperature:	20 – 24 °C
Tissue Simulating liquid:	20 – 24 °C
Relative humidity content:	40 – 50 %
Air pressure:	not relevant for this kind of testing
Power supply:	230 V / 50 Hz

NOTE: For the SAR measurements the exact temperature values for each test are shown in the SAR result tables and are also at the bottom of each measurement plot.



## 7 Test Set-up

### 7.1 Measurement system

#### 7.1.1 System Description

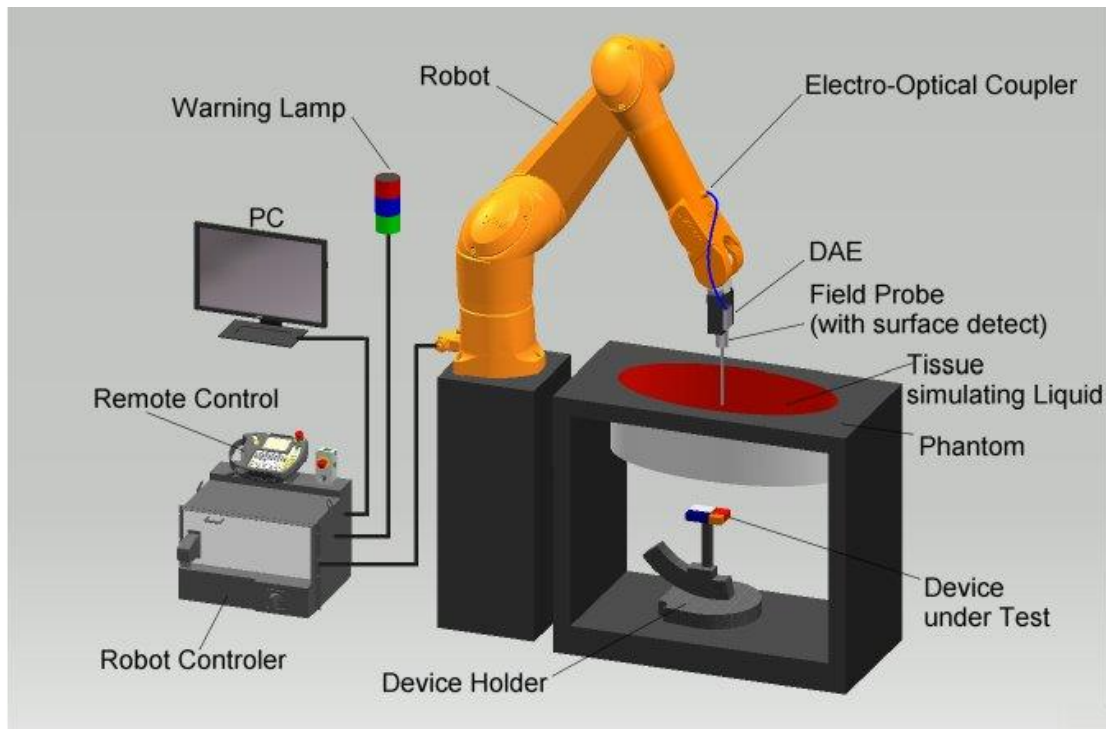

- The DAS system for performing compliance tests consists of the following items:
- A standard high precision 6-axis robot (Stäubli RX/TX family) with controller and software. An arm extension for accommodating the data acquisition electronics (DAE).
- A dosimetric probe, i.e. an isotropic E-field probe optimized and calibrated for usage in tissue simulating liquid.
- A data acquisition electronic (DAE) which performs the signal amplification, signal multiplexing, AD-conversion, offset measurements, mechanical surface detection, collision detection, etc. The unit is battery powered with standard or rechargeable batteries. The signal is optically transmitted to the EOC.
- The Electro-Optical Coupler (EOC) performs the conversion from the optical into a digital electric signal of the DAE. The EOC is connected to the DAS measurement server.
- The DAS measurement server, which performs all real-time data evaluation for field measurements and surface detection, controls robot movements and handles safety operation. A computer operating Windows.
- DAS software and SEMCAD data evaluation software.
- Remote control with teach panel and additional circuitry for robot safety such as warning lamps, etc.
- The generic twin phantom enabling the testing of left-hand and right-hand usage.
- The triple flat and eli phantom for the testing of handheld and body-mounted wireless devices.
- The device holder for handheld mobile phones and mounting device adaptor for laptops
- Tissue simulating liquid mixed according to the given recipes.
- System check dipoles allowing to validate the proper functioning of the system.

## 7.1.2 Test environment

The DASY measurement system is placed in a laboratory room within an environment which avoids influence on SAR measurements by ambient electromagnetic fields and any reflection from the environment. The pictures at the beginning of the photo documentation show a complete view of the test environment. The system allows the measurement of SAR values larger than 0.005 mW/g.

## 7.1.3 Probe description

<b>Isotropic E-Field Probe EX3DV4 for Dosimetric Measurements</b>	
Technical data according to manufacturer information	
Construction	Symmetrical design with triangular core Interleaved sensors Built-in shielding against static charges PEEK enclosure material (resistant to organic solvents, e.g., DGBE)
Calibration	ISO/IEC 17025 calibration service available.
Frequency	10 MHz to >6 GHz (dosimetry); Linearity: $\pm 0.2$ dB (30 MHz to 6 GHz)
Directivity	$\pm 0.3$ dB in HSL (rotation around probe axis) $\pm 0.5$ dB in tissue material (rotation normal to probe axis)
Dynamic range	10 $\mu$ W/g to > 100 mW/g; Linearity: $\pm 0.2$ dB (noise: typically <1 $\mu$ W/g)
Dimensions	Overall length: 337 mm (Tip: 20mm) Tip length: 2.5 mm (Body: 12mm) Typical distance from probe tip to dipole centers: 1mm
Application	High precision dosimetric measurements in any exposure scenario (e.g., very strong gradient fields). Only probe which enables compliance testing for frequencies up to 6 GHz with precision of better 30%.

### 7.1.4 Phantom description

The used SAM Phantom meets the requirements specified in FCC KDB865664 D01 for Specific Absorption Rate (SAR) measurements.

The phantom consists of a fibreglass shell integrated in a wooden table. It allows left-hand and right-hand head as well as body-worn measurements with a maximum liquid depth of 18 cm in head position and 22 cm in planar position (body measurements). The thickness of the Phantom shell is 2 mm +/- 0.1 mm.

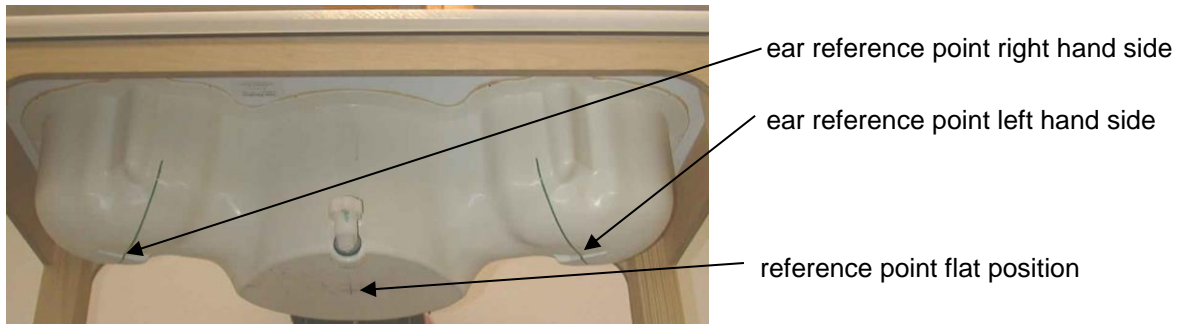

Triple Modular Phantom consists of three identical modules which can be installed and removed separately without emptying the liquid. It includes three reference points for phantom installation. Covers prevent evaporation of the liquid. Phantom material is resistant to DGBE based tissue simulating liquids.

### 7.1.5 Device holder description

The DASY device holder has two scales for device rotation (with respect to the body axis) and the device inclination (with respect to the line between the ear openings). The plane between the ear openings and the mouth tip has a rotation angle of 65°. The bottom plate contains three pair of bolts for locking the device holder. The device holder positions are adjusted to the standard PDA measurement positions in the three sections. This device holder is used for standard mobile phones or PDA's only. If necessary an additional support of polystyrene material is used.



Larger DUT's (e.g. notebooks) cannot be tested using this device holder. Instead a support of bigger polystyrene cubes and thin polystyrene plates is used to position the DUT in all relevant positions to find and measure spots with maximum SAR values.

Therefore those devices are normally only tested at the flat part of the SAM.

## 7.1.6 Scanning procedure

- The DASY installation includes predefined files with recommended procedures for measurements and system check. They are read-only document files and destined as fully defined but unmeasured masks. All test positions (head or body-worn) are tested with the same configuration of test steps differing only in the grid definition for the different test positions.
- The „reference“ and „drift“ measurements are located at the beginning and end of the batch process. They measure the field drift at one single point in the liquid over the complete procedure. The indicated drift is mainly the variation of the DUT's output power and should vary max. +/- 5 %.
- The highest integrated SAR value is the main concern in compliance test applications. These values can mostly be found at the inner surface of the phantom and cannot be measured directly due to the sensor offset in the probe. To extrapolate the surface values, the measurement distances to the surface must be known accurately. A distance error of 0.5mm could produce SAR errors of 6% at 1800 MHz. Measurements can be performed in a fixed plane or by following an arbitrary surface.
- For an automatic and accurate detection of the phantom surface, the DASY system uses Mechanical Surface Detection:

### Mechanical Surface Detection

Mechanical surface detection uses the probe collision detector built into the DAE. It is extremely accurate if the probe is normal to the surface (0.05 mm). For angled probes, the distance increases, because the detection is at the edge of the probe tip. It can be used in any liquid with any kind of probe. If the surface is strongly angled with respect to the probe, the probe slides along the surface and is deflected sideways. The second switch system in the DAE will detect this situation and the probe will move backward until the touch condition is cleared. However, there will be some remaining uncertainty in the final probe position. In the job description, the desired distance from the probe sensors to the phantom surface can be entered. The detection is always at touch, but the probe will move backward from the surface the indicated distance before starting the measurement.

### Mother Scan in cDASY6/DASY8 Module SAR

While the DASY5 V5.2 SAR system uses the mechanical surface detection at each point of the Area Scan / Zoom Scan, the cDASY6/DASY8 Module SAR provides the possibility to do a Mother Scan in which a high resolution Area Scan is done in the phantom filled with liquid to a fixed level using a special teaching probe. This mother scan data is used to recreate the phantom inner surface in software, and all future area and/or zoom scans, and a surface detection check is no longer required.

- The „area scan“ measures the SAR above the DUT or verification dipole on a parallel plane to the surface. It is used to locate the approximate location of the peak SAR with 2D spline interpolation. The robot performs a stepped movement along one grid axis while the local electrical field strength is measured by the probe. The probe is touching the surface of the SAM during acquisition of measurement values. The scan uses different grid spacings for different frequency measurements. Standard grid spacing for head measurements in frequency ranges  $\leq 2$ GHz is 15 mm in x- and y- dimension. For higher frequencies a finer resolution is needed, thus for the grid spacing is reduced according the following table:

Area scan grid spacing for different frequency ranges	
Frequency range	Grid spacing
$\leq 2$ GHz	$\leq 15$ mm
2 – 4 GHz	$\leq 12$ mm
4 – 6 GHz	$\leq 10$ mm

Grid spacing and orientation have no influence on the SAR result. For special applications where the standard scan method does not find the peak SAR within the grid, e.g. mobile phones with flip cover, the grid can be adapted in orientation. Results of this coarse scan are shown in annex B.

- A „zoom scan“ measures the field in a volume around the 2D peak SAR value acquired in the previous „coarse“ scan. It uses a fine meshed grid where the robot moves the probe in steps along all the 3 axis (x, y and z-axis) starting at the bottom of the Phantom. The grid spacing for the cube measurement is varied according to the measured frequency range, the dimensions are given in the following table:

<b>Zoom scan grid spacing and volume for different frequency ranges</b>			
Frequency range	Grid spacing for x, y axis	Grid spacing for z axis	Minimum zoom scan volume
≤ 2 GHz	≤ 8 mm	≤ 5 mm	≥ 30 mm
2 – 3 GHz	≤ 5 mm*	≤ 5 mm	≥ 28 mm
3 – 4 GHz	≤ 5 mm*	≤ 4 mm	≥ 28 mm
4 – 5 GHz	≤ 4 mm*	≤ 3 mm	≥ 25 mm
5 – 6 GHz	≤ 4 mm*	≤ 2 mm	≥ 22 mm

\* When zoom scan is required and the reported SAR from the area scan based 1-g SAR estimation procedures of KDB Publication 447498 is  $\leq 1.4$  W/kg,  $\leq 8$  mm,  $\leq 7$  mm and  $\leq 5$  mm zoom scan resolution may be applied, respectively, for 2 GHz to 3 GHz, 3 GHz to 4 GHz and 4 GHz to 6 GHz.

- DASY provides an auto-extending feature to expand the size of the measurement area of the zoom scan as long as the maximum is found too close to the edge of the measured range, which eliminates the need to re-measure cubes whose maximum is found on the boundary of the defined measurement cube.
- To meet the requirements of **IEC 62209-2 AMD1 from 2019** it is necessary to perform graded grid measurements to avoid measurement mistakes.

#### **Below 3 GHz it defines:**

Horizontal grid step  $\leq 8$ mm

Vertical grid step  $\leq 5$ mm for uniform spacing

For variable spacing in vertical direction the maximum distance between the two closest measured points to the phantom shell (M1 and M2) shall be  $\leq 4$  mm and the spacing between farther points shall increase by a factor  $\leq 1.5$ . Zoom Scan size  $\leq 30$  mm by 30 mm by 30 mm.

#### **Above 3 GHz it defines:**

Horizontal grid step  $\leq (24/f[\text{GHz}])$  mm

Vertical grid step  $\leq (10/(f[\text{GHz}] - 1))$  mm for uniform spacing

For variable spacing in vertical direction the maximum distance between the two closest measured points to the phantom shell (M1 and M2) shall be  $\leq (12/f[\text{GHz}])$  mm and the spacing between farther points shall increase by a factor  $\leq 1.5$ . Zoom Scan size  $\leq 22$  mm by 22 mm by 22 mm.

If the zoom scan measured as defined above complies with both of the following criteria, or if the peak spatial-average SAR is below 0.1 W/kg, no additional measurements are needed:

- 1) the smallest horizontal distance from the local SAR peaks to all points 3 dB below the SAR peak shall be larger than the horizontal grid steps in both x and y directions ( $\Delta x, \Delta y$ ). This shall be checked for the measured zoom scan plane conformal to the phantom at the distance  $z_{M1}$ . The minimum distance shall be recorded in the SAR test report;
- 2) the ratio of the SAR at the second measured point (M2) to the SAR at the closest measured point (M1) at the x-y location of the measured maximum SAR value shall be at least 30 %. This ratio (in %) shall be recorded in the SAR test report.

If one or both of the above criteria are not met, the zoom scan measurement shall be repeated using a finer resolution while keeping the other zoom scan parameters compatible with the basic requirements for zoom scans.

New horizontal and vertical grid steps shall be determined from the measured SAR distribution so that the above criteria are met. Compliance with the above two criteria shall be demonstrated for the new measured zoom scan. The size of the higher resolution zoom scan and all other parameters shall apply. The closest point to the phantom shell shall be 2 mm or less for graded grids and the grading factor shall be 1.5 or less. Uncertainties due to field distortion between the media boundary and the dielectric enclosure of the probe should also be minimized, which is achieved if the distance between the phantom surface and physical tip of the probe is larger than the probe tip diameter. Other methods may utilize correction procedures to compensate for boundary effects that enable high precision measurements closer than half the probe tip diameter. For all measurement points, the angle of the probe normal to the flat phantom surface shall be less than 5°. If this cannot be achieved, an additional uncertainty evaluation is required.

**Orientation of the probe with respect to the line normal to the phantom surface, shown at two different locations:**

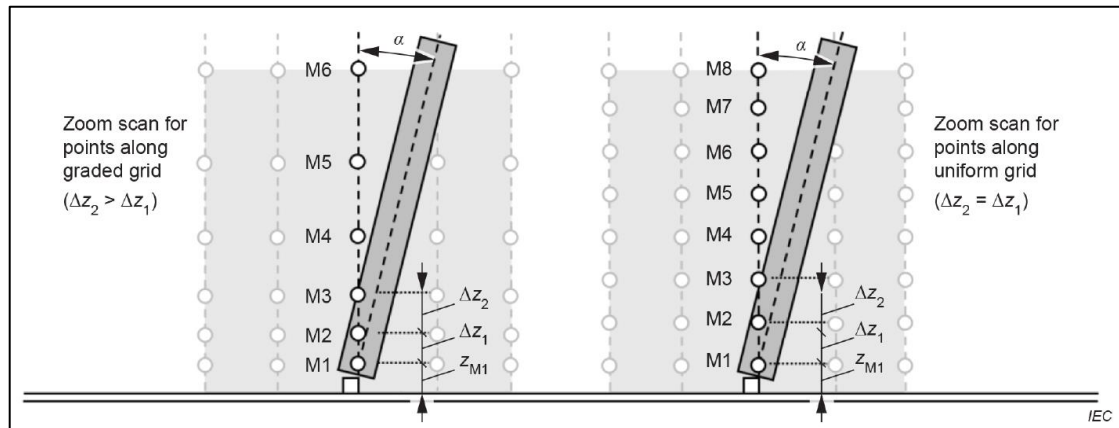

NOTE M1 to M8 are example measurement points used for extrapolation to the surface. The maximum of the angle  $\alpha$  between the evaluation axis and the surface normal line is called the probe angle. The distance  $z_{M1}$  is from the phantom shell to the first measurement point M1, and its maximum value is 1.4mm fixed for the DASY system equipped with an EX-Probe. The distances  $\Delta z_i (i = 1, 2, 3, \dots)$  are the distances from measurement points  $M_i$  to  $M_{i-1}$ . For uniform grids,  $\Delta z_i$  are equal. For graded grids,  $\Delta z_{i+1} > \Delta z_i$ .  $R_z = \Delta z_{i+1}/\Delta z_i$  is a ratio with a maximum value (defined in the table below). The z direction corresponds to the vertical direction, the x direction is horizontal and the y direction is horizontal into the page.

NOTE 1: The evaluation of the zoom scan is typically done by the post-processor by interpolation and extrapolation and without reconstruction of the field. More focused induced SAR distributions (e.g., for more localized sources such as capacitively coupled sources) require a more dense grid such that the same integration and extrapolation algorithms can be used for the same assessment uncertainty.

NOTE 2: The minimum ratio of 30 % is derived from the plane wave penetration depth at 6 GHz.



Detailed parameters can be seen in the following table:

**Table 8 – Zoom scan parameters**

Parameter	DUT transmit frequency being tested	
	$f \leq 3$ GHz	$3$ GHz $< f \leq 6$ GHz
Maximum distance between the closest measured points and the phantom surface ( $z_{M1}$ in Figure 14 and Table 2, in mm)	5	$\delta \ln(2)/2$ <sup>a</sup>
Maximum angle between the probe axis and the flat phantom surface normal ( $\alpha$ in Figure 14)	5°	5°
Maximum spacing between measured points in the x- and y-directions ( $\Delta x$ and $\Delta y$ , in mm)	8	$24/f$ <sup>b,c</sup>
For uniform grids: Maximum spacing between measured points in the direction normal to the phantom shell ( $\Delta z_1$ in Figure 14, in mm)	5	$10/(f - 1)$
For graded grids: Maximum spacing between the two closest measured points in the direction normal to the phantom shell ( $\Delta z_1$ in Figure 14, in mm)	4	$12/f$
For graded grids: Maximum incremental increase in the spacing between measured points in the direction normal to the phantom shell ( $R_z = \Delta z_2/\Delta z_1$ in Figure 14)	1,5	1,5
Minimum edge length of the zoom scan volume in the x- and y-directions ( $L_z$ in 7.2.5.3, in mm)	30	22
Minimum edge length of the zoom scan volume in the direction normal to the phantom shell ( $L_h$ in 7.2.5.3, in mm)	30	22
Tolerance in the probe angle	1°	1°

<sup>a</sup>  $\delta$  is the penetration depth for a plane-wave incident normally on a planar half-space.  
<sup>b</sup> This is the maximum spacing allowed, which may not work for all circumstances.  
<sup>c</sup>  $f$  is the frequency in GHz.

**Table M.1 – Minimum probe requirements as a function of frequency and parameters of the tissue equivalent liquid**

1	2	3	4	5	6	7	8
Frequency MHz	Relative permittivity	Conductivity S/m	Wavelength in the medium ( $\lambda$ ) mm	Plane wave Skin Depth ( $\delta$ ) mm	Maximum Diameter mm	50 % Distance for M1 ( $z_{50\%} = \delta \ln(2)/2$ ) mm	Min. distance for M1 ( $z_{M1}$ ) mm
300	45,3	0,87	148,6	46,1	8,0	16,0	5,0
450	43,5	0,87	101,1	42,9	8,0	14,9	5,0
750	41,9	0,89	61,8	39,8	8,0	13,8	5,0
835	41,5	0,9	55,8	38,9	8,0	13,5	5,0
900	41,5	0,97	51,7	36,1	8,0	12,5	5,0
1 450	40,5	1,20	32,5	28,6	8,0	9,9	5,0
1 800	40,0	1,40	26,4	24,3	8,0	8,4	5,0
2 000	40,0	1,40	23,7	24,2	8,0	8,4	5,0
2 450	39,2	1,80	19,6	18,7	6,5	6,5	5,0
2 600	39,0	1,96	18,5	17,2	6,2	5,9	5,0
3 000	38,5	2,40	16,1	13,9	5,4	4,8	5,0
4 000	37,4	3,43	12,3	9,6	4,1	3,3	3,3
5 000	36,2	4,45	10,0	7,3	3,3	2,5	2,5
5 200	36,0	4,66	9,6	7,0	3,2	2,4	2,4
5 400	35,8	4,86	9,3	6,7	3,1	2,3	2,3
5 600	35,5	5,07	9,0	6,4	3,0	2,2	2,2
5 800	35,3	5,27	8,7	6,1	2,9	2,1	2,1
6 000	35,1	5,48	8,4	5,9	2,8	2,0	2,0

Further probe parameters can be seen in Annex M of IEC 62209-2.



### 7.1.7 Comparison of DASY 52 NEO and cDASY6/DASY8

CTC advanced actually uses both systems side by side and the main differences of the DASY52 NEO and cDASY6/DASY8 system are system operation, reporting tools and measurement speed. DASY 52 still uses the DASY measurement software which has further in-depth options to adapt measurements to sophisticated test setups. For the reporting of the measurement results the companion software SEMCAD X is used. cDASY6/DASY8 is a different measurement system that is especially aimed to speed up standardized compliant measurements with high repeatability and less freedom of usability. It makes it possible to handle and rate compliance tests for a standardized product like a mobile phone in one place and it provides its own backend for reporting. The higher measurement speed is bought for the cost of less flexibility in the measurement setup and adding further sophisticated maintenance as it is necessary to perform regular mother scans.

<b>Feature comparison:</b>		
	DASY 52 (NEO)	cDASY6/DASY8
Warning feature for Zoom Scan according IEC 62209-2 AMD1 (graded Grid conditions)*	yes**	yes
Graded Grids for Area and Zoom Scan supported	yes**	yes
Measurement software	DASY 52 NEO	cDASY6/DASY8
Reporting tool	SEMCAD X post processor	cDASY6/DASY8 integrated post processor
Collusion detection to set probe to surface distance	yes	yes
Mother scans	no	yes

\*) A warning appears if the stricter zoom scan criteria as defined in IEC 62209-2 AMD1 are violated using the actual zoom scan settings. In these cases a re-measurement with graded grid is performed and the result plot is updated with the information about the graded grid. This approach guarantees that the difference between the positions with maximum SAR to any adjacent point both horizontally and vertically is below the defined thresholds and that the SAR evaluation is correct.

(respecting both the 3 dB and the 30% criteria from section 6.3.1 d) of IEC 62209-2 AMD1.)

\*\*\*) features were added with version: DASY52 - 52.10.2(1504) to satisfy IEC 62209-2 AMD1.

## 7.1.8 Spatial Peak SAR Evaluation

Both DASY5 V5.2 and cDASY6/DASY8 Module SAR software include all numerical procedures necessary to evaluate the spatial peak SAR values. Based on the IEEE 1528 standard, a new algorithm has been implemented. The spatial-peak SAR can be computed over any required mass. The base for the evaluation is a "cube" measurement in a volume of 30mm<sup>3</sup> below 3GHz or 22mm<sup>3</sup> above 3GHz. The measured volume must include the 1 g and 10 g cubes with the highest averaged SAR values. For that purpose, the center of the measured volume is aligned to the interpolated peak SAR value of a previously performed area scan. If the 10g cube or both cubes are not entirely inside the measured volumes, the system issues a warning regarding the evaluated spatial peak values within the post-processing engine. This means that if the measured volume is shifted, higher values might be possible. To get the correct values a finer measurement grid for the area scan is used. In complicated field distributions, a large grid spacing for the area scan might miss some details and give an incorrectly interpolated peak location. Both DASY5 V5.2 and cDASY6/DASY8 Module SAR allow to automatically extend the grid to make sure that both cubes are inside the measured volume.

The entire evaluation of the spatial peak values is performed within the application in case of cDASY6/DASY8 Module SAR software or within Post-processing engine (SEMCAD X) for DASY5 V5.2. The system always gives the maximum values for the 1 g and 10 g cubes. The cDASY6/DASY8 software allow to automatically extend the grid to make sure that both cubes are inside the measured volume. The algorithm to find the cube with highest averaged SAR is divided into the following stages:

1. extraction of the measured data (grid and values) from the Zoom Scan
2. calculation of the SAR value at every measurement point based on all stored data (A/D values and measurement parameters)
3. generation of a high-resolution mesh within the measured volume
4. interpolation of all measured values from the measurement grid to the high-resolution grid
5. extrapolation of the entire 3-D field distribution to the phantom surface over the distance from sensor to surface
6. calculation of the averaged SAR within masses of 1 g and 10 g The significant parts are outlined in more detail within the following sections.

### Interpolation, Extrapolation and Detection of Maxima

The probe is calibrated at the center of the dipole sensors which is located 1 to 2.7mm away from the probe tip. During measurements, the probe stops shortly above the phantom surface, depending on the probe and the surface detecting system. Both distances are included as parameters in the probe configuration file. The software always knows exactly how far away the measured point is from the surface. As the probe cannot directly measure at the surface, the values between the deepest measured point and the surface must be extrapolated.

The choice of the coordinate system defining the location of the measurement points has no influence on the uncertainty of the interpolation, Maxima Search and extrapolation routines. The interpolation, extrapolation and maximum search routines are all based on the modified Quadratic Shepard's method [Robert J. Renka, "Multivariate Interpolation Of Large Sets Of Scattered Data", University of North Texas ACM Transactions on Mathematical Software, vol. 14, no. 2, June 1988, pp. 139-148.].

Thereby, the interpolation scheme combines a least-square fitted function method and a weighted average method which are the two basic types of computational interpolation and approximation. The cDASY6/DASY8 routines construct a once-continuously differentiable function that interpolates the measurement values as follows:

- For each measurement point a trivariate (3-D) / bivariate (2-D) quadratic is computed. It interpolates the measurement values at the data point and forms a least-square fit to neighbouring measurement values.
- the spatial location of the quadratic with respect to the measurement values is attenuated by an inverse distance weighting. This is performed since the calculated quadratic will fit measurement values at nearby points more accurate than at points located further away.
- After the quadratics are calculated at all measurement points, the interpolating function is calculated as a weighted average of the quadratics.

There are two control parameters that govern the behavior of the interpolation method.

One specifies the number of measurement points to be used in computing the least-square fits for the local quadratics. These measurement points are the ones nearest the input point for which the quadratic is being computed.

The second parameter specifies the number of measurement points that will be used in calculating the weights for the quadratics to produce the final function. The input data points used there are the ones nearest the point at which the interpolation is desired. Appropriate defaults are chosen for each of the control parameters.

The trivariate quadratics that have been previously computed for the 3-D interpolation and whose input data are at the closest distance from the phantom surface, are used in order to extrapolate the fields to the surface of the phantom.

In order to determine all the field maxima in 2-D (Area Scan) and 3-D (Zoom Scan), the measurement grid is refined by a default factor of 10 (area) and 5 (zoom), respectively, and the interpolation function is used to evaluate all field values between corresponding measurement points. Subsequently, a linear search is applied to find all the candidate maxima. In a last step, non physical maxima are removed and only those maxima which are within 2 dB of the global maximum value are retained.

**Important:** To be processable by the interpolation/extrapolation scheme, the Area Scan requires at least 6 measurement points. The Zoom Scan requires at least 10 measurement points to allow the application of these algorithms.

In the Area Scan, the gradient of the interpolation function is evaluated to find all the extrema of the SAR distribution. The uncertainty on the locations of the extrema is less than 1/20 of the grid size. Only local maxima within 2 dB of the global maximum are searched and passed for the Zoom Scan measurement.

In the Zoom Scan, the interpolation function is used to extrapolate the Peak SAR from the lowest measurement points to the inner phantom surface (the extrapolation distance). The uncertainty increases with the extrapolation distance. To keep the uncertainty within 1% for the 1 g and 10 g cubes, the extrapolation distance should not be larger than 5 mm.

## Averaging and Determination of spatial Peak SAR

Within DASY5 V5.2 software, the interpolated data is used to average the SAR over the 1g and 10g cubes by spatially discretizing the entire measured volume. The resolution of this spatial grid is around 1mm and chosen such that the cube side length is a multiple of the resolution. The resulting volumes are defined as cubical volumes containing the appropriate tissue parameters that are centered at the location. The location is defined as the center of the incremental volume.

The spatial-peak SAR must be evaluated in cubical volumes containing a mass that is within 5% of the required mass. The cubical volume centered at each location, as defined above, should be expanded in all directions until the desired value for the mass is reached, with no surface boundaries of the averaging volume extending beyond the outermost surface of the considered region. In addition, the cubical volume should not consist of more than 10% of non-liquid volume. If these conditions are not satisfied, then the center of the averaging volume is moved to the next location.

Reference is kept of all locations used and those not used for averaging the SAR. All average SAR values are finally assigned to the centered location in each valid averaging volume. All locations included in an averaging volume are marked as used to indicate that they have been used at least once. If a location has been marked as used, but has never been the center of a cube, the highest averaged SAR value of all other cubical volumes which have used this location for averaging is assigned to this location. For the case of an unused location, a new averaging volume must be constructed which will have the unused location centered at one surface of the cube. The remaining five surfaces are expanded evenly in all directions until the required mass is enclosed, regardless of the amount of included air. Of the six possible cubes with one surface centered on the unused location, the smallest cube is used, which still contains the required mass.

If the final cube containing the highest averaged SAR touches the surface of the measured volume, an appropriate warning is issued within the Post-processing engine.

Within cDASY6/DASY8 Module SAR software, the measured grid is interpolated to a high resolution grid, where the resolution is around 1mm and chosen such that the cube volume is a multiple of the resolution. Points which are outside of the measured grid are masked out and set to zero. Then, the antiderivative of the interpolated grid is computed by using a Gaussian quadrature consecutively for all spatial dimensions.

The antiderivative is used to compute all cube averages of the volume with the same resolution as the interpolated grid. The maximum of these SAR averages is reported. If the cube containing the maximum averaged SAR touches the surface of the measured volume, an appropriate warning is issued within the Post-processing engine.

## 7.1.9 Data Storage and Evaluation

### Data Storage

The DASY software stores the acquired data from the data acquisition electronics as raw data (in microvolt readings from the probe sensors), together with all necessary software parameters for the data evaluation (probe calibration data, liquid parameters and device frequency and modulation data) in measurement files with the extension ".DA4", ".DA5x". The software evaluates the desired unit and format for output each time the data is visualized or exported. This allows verification of the complete software setup even after the measurement and allows correction of incorrect parameter settings. For example, if a measurement has been performed with a wrong crest factor parameter in the device setup, the parameter can be corrected afterwards and the data can be re-evaluated.

The measured data can be visualized or exported in different units or formats, depending on the selected probe type ([V/m], [A/m], [°C], [mW/g], [mW/cm<sup>2</sup>], [dBrel], etc.). Some of these units are not available in certain situations or show meaningless results, e.g., a SAR output in a lossless media will always be zero. Raw data can also be exported to perform the evaluation with other software packages.

### Data Evaluation by SEMCAD

The SEMCAD software automatically executes the following procedures to calculate the field units from the microvolt readings at the probe connector. The parameters used in the evaluation are stored in the configuration modules of the software:

Probe parameters:	- Sensitivity	Norm <sub>i</sub> , a <sub>i0</sub> , a <sub>i1</sub> , a <sub>i2</sub>
	- Conversion factor	ConvF <sub>i</sub>
	- Diode compression point	Dcpi
Device parameters:	- Frequency	f
	- Crest factor	cf
Media parameters:	- Conductivity	$\sigma$
	- Density	$\rho$

These parameters must be set correctly in the software. They can be found in the component documents or they can be imported into the software from the configuration files issued for the DASY components. In the direct measuring mode of the multimeter option, the parameters of the actual system setup are used. In the scan visualization and export modes, the parameters stored in the corresponding document files are used.

The first step of the evaluation is a linearization of the filtered input signal to account for the compression characteristics of the detector diode. The compensation depends on the input signal, the diode type and the DC-transmission factor from the diode to the evaluation electronics.

If the exciting field is pulsed, the crest factor of the signal must be known to correctly compensate for peak power. The formula for each channel can be given as:

$$V_i = U_i + U_i^2 \cdot cf/dcp_i$$

with  $V_i$  = compensated signal of channel i (i = x, y, z)  
 $U_i$  = input signal of channel i (i = x, y, z)  
 cf = crest factor of exciting field (DASY parameter)  
 dcp<sub>i</sub> = diode compression point (DASY parameter)

From the compensated input signals the primary field data for each channel can be evaluated:

E-field probes:  $E_i = (V_i / Norm_i \cdot ConvF)^{1/2}$

H-field probes:  $H_i = (V_i)^{1/2} \cdot (a_{i0} + a_{i1}f + a_{i2}f^2)/f$

with  $V_i$  = compensated signal of channel i (i = x, y, z)  
 $Norm_i$  = sensor sensitivity of channel i (i = x, y, z)  
 [mV/(V/m)<sup>2</sup>] for E-field Probes  
 $ConvF$  = sensitivity enhancement in solution  
 $a_{ij}$  = sensor sensitivity factors for H-field probes  
 f = carrier frequency [GHz]  
 $E_i$  = electric field strength of channel i in V/m  
 $H_i$  = magnetic field strength of channel i in A/m

The RSS value of the field components gives the total field strength (Hermitian magnitude):

$$E_{tot} = (E_x^2 + E_y^2 + E_z^2)^{1/2}$$

The primary field data are used to calculate the derived field units.

$$SAR = (E_{tot}^2 \cdot \sigma) / (\rho \cdot 1000)$$

with SAR = local specific absorption rate in mW/g  
 $E_{tot}$  = total field strength in V/m  
 $\sigma$  = conductivity in [mho/m] or [Siemens/m]  
 $\rho$  = equivalent tissue density in g/cm<sup>3</sup>

Note that the density is normally set to 1 (or 1.06), to account for actual brain density rather than the density of the simulation liquid. The power flow density is calculated assuming the excitation field to be a free space field.

$$P_{pwe} = E_{tot}^2 / 3770 \quad \text{or} \quad P_{pwe} = H_{tot}^2 \cdot 37.7$$

with  $P_{pwe}$  = equivalent power density of a plane wave in mW/cm<sup>2</sup>  
 $E_{tot}$  = total electric field strength in V/m  
 $H_{tot}$  = total magnetic field strength in A/m

#### Data Evaluation in cDASY6/DASY8

cDASY6/DASY8 features basic evaluation capabilities comparable to the above described SEMCAD evaluation. The main difference is that cDASY6/DASY8 is a stand-alone all-in-one solution whilst SEMCAD is only used to add these features to the DASY5.2 (NEO) platform. The final results are fully comparable no matter if they were generated by DASY5.2(NEO) + SEMCAD or in cDASY6/DASY8 directly.

### 7.1.10 Tissue simulating liquids: dielectric properties

The following materials are used for producing the tissue-equivalent materials.

**HBBL600-10000MHz Simulating Head Liquid**, Manufactured by SPEAG:

Ingredients	(% by weight)
Water	50-65%
Mineral oil	10-30%
Emulsifiers	8-25%
Sodium salt	0-1.5%

Table 2: Head tissue dielectric properties

### 7.1.11 Tissue simulating liquids: parameters

Liquid HSL	Freq. (MHz)	Target head tissue		Measurement head tissue					Measurement date
		Permittivity	Conductivity [S/m]	Permittivity	Dev. %	Conductivity		Dev. %	
						$\epsilon''$	[S/m]		
450	450	43.50	0.87	45.5	4.6%	31.27	0.78	-10.0%	2022-04-29
	470	43.40	0.87	45.1	3.9%	30.64	0.80	-8.1%	
	510	43.19	0.87	44.2	2.3%	29.42	0.83	-4.6%	
	520	43.14	0.88	44.0	2.0%	29.16	0.84	-3.7%	
	550	42.98	0.88	43.4	1.0%	28.36	0.87	-1.2%	
600	564	42.91	0.88	43.1	0.4%	28.06	0.88	0.2%	2022-05-02
	600	42.72	0.88	42.4	-0.8%	27.31	0.91	3.4%	
	608	42.68	0.88	42.2	-1.1%	27.17	0.92	4.1%	
2450	2402	39.28	1.76	39.0	-0.8	13.48	1.80	2.5	2022-05-06
	2412	39.27	1.77	38.9	-0.8	13.48	1.81	2.4	
	2437	39.22	1.79	38.9	-0.8	13.47	1.83	2.1	
	2442	39.21	1.79	38.9	-0.8	13.47	1.83	2.1	
	2450	39.20	1.80	38.9	-0.8	13.47	1.84	2.0	
	2462	39.20	1.81	38.9	-0.8	13.48	1.85	1.8	
	2472	39.19	1.82	38.9	-0.9	13.48	1.85	1.7	
	2480	39.19	1.83	38.8	-0.9	13.48	1.86	1.5	

Table 3: Parameter of the head tissue simulating liquid

Note: The dielectric properties have been measured using the contact probe method at 22°C.

### 7.1.12 Measurement uncertainty evaluation for SAR test

DASY5 Uncertainty Budget										
According to IEC 62209-2/2010 for the 300 MHz - 6 GHz range										
Source of uncertainty	Uncertainty Value		Probability Distribution	Divisor	c <sub>i</sub> (1g)	c <sub>i</sub> (10g)	Standard Uncertainty		v <sub>i</sub> <sup>2</sup> or v <sub>eff</sub>	
							± %, (1g)	± %, (10g)		
<b>Measurement System</b>										
Probe calibration	± 6.6 %		Normal	1	1	1	± 6.6 %	± 6.6 %	± 6.6 %	∞
Axial isotropy	± 4.7 %		Rectangular	√ 3	0.7	0.7	± 1.9 %	± 1.9 %	± 1.9 %	∞
Hemispherical isotropy	± 9.6 %		Rectangular	√ 3	0.7	0.7	± 3.9 %	± 3.9 %	± 3.9 %	∞
Boundary effects	± 2.0 %		Rectangular	√ 3	1	1	± 1.2 %	± 1.2 %	± 1.2 %	∞
Probe linearity	± 4.7 %		Rectangular	√ 3	1	1	± 2.7 %	± 2.7 %	± 2.7 %	∞
System detection limits	± 1.0 %		Rectangular	√ 3	1	1	± 0.6 %	± 0.6 %	± 0.6 %	∞
Modulation Response	± 2.4 %		Rectangular	√ 3	1	1	± 1.4 %	± 1.4 %	± 1.4 %	∞
Readout electronics	± 0.3 %		Normal	1	1	1	± 0.3 %	± 0.3 %	± 0.3 %	∞
Response time	± 0.8 %		Rectangular	√ 3	1	1	± 0.5 %	± 0.5 %	± 0.5 %	∞
Integration time	± 2.6 %		Rectangular	√ 3	1	1	± 1.5 %	± 1.5 %	± 1.5 %	∞
RF ambient noise	± 3.0 %		Rectangular	√ 3	1	1	± 1.7 %	± 1.7 %	± 1.7 %	∞
RF ambient reflections	± 3.0 %		Rectangular	√ 3	1	1	± 1.7 %	± 1.7 %	± 1.7 %	∞
Probe positioner	± 0.8 %		Rectangular	√ 3	1	1	± 0.5 %	± 0.5 %	± 0.5 %	∞
Probe positioning	± 6.7 %		Rectangular	√ 3	1	1	± 3.9 %	± 3.9 %	± 3.9 %	∞
Post-processing	± 4.0 %		Rectangular	√ 3	1	1	± 2.3 %	± 2.3 %	± 2.3 %	∞
<b>Test Sample Related</b>										
Device positioning	± 2.9 %		Normal	1	1	1	± 2.9 %	± 2.9 %	± 2.9 %	145
Device holder uncertainty	± 3.6 %		Normal	1	1	1	± 3.6 %	± 3.6 %	± 3.6 %	5
Power drift	± 5.0 %		Rectangular	√ 3	1	1	± 2.9 %	± 2.9 %	± 2.9 %	∞
<b>Phantom and Set-up</b>										
Phantom uncertainty	± 7.9 %		Rectangular	√ 3	1	1	± 4.6 %	± 4.6 %	± 4.6 %	∞
SAR correction	± 1.9 %		Rectangular	√ 3	1	0.84	± 1.1 %	± 0.9 %	± 0.9 %	∞
Liquid conductivity (meas.)	± 5.0 %		Rectangular	√ 3	0.78	0.71	± 2.3 %	± 2.0 %	± 2.0 %	∞
Liquid permittivity (meas.)	± 5.0 %		Rectangular	√ 3	0.26	0.26	± 0.8 %	± 0.8 %	± 0.8 %	∞
Temp. Unc. - Conductivity	± 3.4 %		Rectangular	√ 3	0.78	0.71	± 1.5 %	± 1.4 %	± 1.4 %	∞
Temp. Unc. - Permittivity	± 0.4 %		Rectangular	√ 3	0.23	0.26	± 0.1 %	± 0.1 %	± 0.1 %	∞
<b>Combined Uncertainty</b>							± 12.7 %	± 12.6 %	± 12.6 %	330
<b>Expanded Std. Uncertainty</b>							± 25.4 %	± 25.3 %	± 25.3 %	

Table 4: Measurement uncertainties.

Worst-Case uncertainty budget for DASY5 assessed according to IEC 62209-2/2010 standard. The budget is valid for the frequency range 300MHz - 6 GHz and represents a worst-case analysis. For specific tests and configurations, the uncertainty could be considerable smaller.



DASY8 Uncertainty Budget									
According to IEC/IEEE 62209-1528 (Frequency band: 300 MHz - 3 GHz range)									
Symbol	Error Description	Uncertainty Value		Probability Distribution	Divisor	c <sub>i</sub>	c <sub>i</sub>	Standard Uncertainty	
						(1g)	(10g)	± %, (1g)	± %, (10g)
<b>Measurement System Errors</b>									
CF	Probe Calibration Repeat.	± 12.0	%	Normal	2	1	1	± 6.0 %	± 6.0 %
CFdrift	Probe Calibration Drift	± 1.7	%	Rectangular	√ 3	1	1	± 1.0 %	± 1.0 %
LIN	Probe linearity	± 4.7	%	Rectangular	√ 3	1	1	± 2.7 %	± 2.7 %
BBS	Broadband Signal	± 3.0	%	Rectangular	√ 3	1	1	± 1.7 %	± 1.7 %
ISO	Probe Isotropy (axial)	± 7.6	%	Rectangular	√ 3	1	1	± 4.4 %	± 4.4 %
DAE	Data Acquisition	± 0.3	%	Normal	1	1	1	± 0.3 %	± 0.3 %
AMB	RF Ambient	± 1.8	%	Normal	1	1	1	± 1.8 %	± 1.8 %
Δ <sub>sys</sub>	Probe Positioning	± 0.006	mm	Normal	1	0.14	0.14	± 0.1 %	± 0.1 %
DAT	Data Processing	± 1.2	%	Normal	1	1	1	± 1.2 %	± 1.2 %
<b>Phantom and Device Errors</b>									
LIQ(σ)	Conductivity (meas.) <sup>DAK</sup>	± 2.5	%	Normal	1	0.78	0.71	± 2.0 %	± 1.8 %
LIQ(Tσ)	Conductivity (temp.) <sup>BB</sup>	± 3.3	%	Rectangular	√ 3	0.78	0.71	± 1.5 %	± 1.4 %
EPS	Phantom Permittivity	± 14.0	%	Rectangular	√ 3	0	0	± 0.0 %	± 0.0 %
DIS	Distance DUT - TSL	± 2.0	%	Normal	1	2	2	± 4.0 %	± 4.0 %
D <sub>xyz</sub>	Device Positioning	± 1.0	%	Normal	1	1	1	± 1.0 %	± 1.0 %
H	Device Holder	± 3.6	%	Normal	1	1	1	± 3.6 %	± 3.6 %
MOD	DUT Modulation <sup>m</sup>	± 2.4	%	Rectangular	√ 3	1	1	± 1.4 %	± 1.4 %
TAS	Time-average SAR	± 1.7	%	Rectangular	√ 3	1	1	± 1.0 %	± 1.0 %
RF <sub>drift</sub>	DUT drift	± 2.5	%	Normal	1	1	1	± 2.5 %	± 2.5 %
VAL	Val Antenna Unc. <sup>val</sup>	± 0.0	%	Normal	1	1	1	± 0.0 %	± 0.0 %
RF <sub>in</sub>	Unc. Input Power <sup>val</sup>	± 0.0	%	Normal	1	1	1	± 0.0 %	± 0.0 %
<b>Correction to the SAR results</b>									
C(ε, σ)	Deviation to Target	± 1.9	%	Normal	1	1	0.84	± 1.9 %	± 1.6 %
C(R)	SAR scaling <sup>p</sup>	± 0.0	%	Rectangular	√ 3	1	1	± 0.0 %	± 0.0 %
<b>u(ΔSAR)</b>	<b>Combined Uncertainty</b>							± 11.0 %	± 10.9 %
<b>U</b>	<b>Expanded Uncertainty</b>							± 21.9 %	± 21.7 %

Table

5: Measurement uncertainties

Worst-Case uncertainty budget for DASY8 assessed according to IEC/IEEE 62209-1528 [4]. The budget is valid for the frequency range 300MHz - 3 GHz and represents a worst-case analysis. For specific tests and configurations, the uncertainty could be considerable smaller. All listed error components have *veff* equal to ∞.

**Footnote details:**

<sup>m</sup> SMC calibration is a new method for determining the total deviation from linearity. The uncertainty is ≤ 2.4% for psSAR ≤ 2 W/kg, ≤ 4.8% for psSAR1g/10g ≤ 4 W/kg and ≤ 9.6% for psSAR1g/10g ≤ 10 W/kg (see modulation calibration parameter uncertainty in the probe calibration certificate);

<sup>BB</sup> if SPEAG's broad-band liquids (BBL) are used that have low temperature coefficients;

<sup>DAK</sup> if SPEAG's high precision dielectric probe kit (DAK) is applied;

<sup>p</sup> if power scaling is used, error item "SAR Scaling" must be adjusted accordingly;

<sup>val</sup> only applies in case of validation measurements.

### 7.1.13 Measurement uncertainty evaluation for System Check

Uncertainty of a System Performance Check with DASY5 System for the 0.3 - 3 GHz range									
Source of uncertainty	Uncertainty Value	Probability Distribution	Divisor	c <sub>i</sub>	c <sub>i</sub>	Standard Uncertainty		v <sub>i</sub> <sup>2</sup> or v <sub>eff</sub>	
				(1g)	(10g)	± %, (1g)	± %, (10g)		
<b>Measurement System</b>									
Probe calibration	± 6.0 %	Normal	1	1	1	± 6.0 %	± 6.0 %	∞	
Axial isotropy	± 4.7 %	Rectangular	√ 3	0.7	0.7	± 1.9 %	± 1.9 %	∞	
Hemispherical isotropy	± 0.0 %	Rectangular	√ 3	0.7	0.7	± 0.0 %	± 0.0 %	∞	
Boundary effects	± 1.0 %	Rectangular	√ 3	1	1	± 0.6 %	± 0.6 %	∞	
Probe linearity	± 4.7 %	Rectangular	√ 3	1	1	± 2.7 %	± 2.7 %	∞	
System detection limits	± 1.0 %	Rectangular	√ 3	1	1	± 0.6 %	± 0.6 %	∞	
Readout electronics	± 0.3 %	Normal	1	1	1	± 0.3 %	± 0.3 %	∞	
Response time	± 0.0 %	Rectangular	√ 3	1	1	± 0.0 %	± 0.0 %	∞	
Integration time	± 0.0 %	Rectangular	√ 3	1	1	± 0.0 %	± 0.0 %	∞	
RF ambient conditions	± 3.0 %	Rectangular	√ 3	1	1	± 1.7 %	± 1.7 %	∞	
Probe positioner	± 0.4 %	Rectangular	√ 3	1	1	± 0.2 %	± 0.2 %	∞	
Probe positioning	± 2.9 %	Rectangular	√ 3	1	1	± 1.7 %	± 1.7 %	∞	
Max. SAR evaluation	± 1.0 %	Rectangular	√ 3	1	1	± 0.6 %	± 0.6 %	∞	
<b>Test Sample Related</b>									
Dev. of experimental dipole	± 0.0 %	Rectangular	√ 3	1	1	± 0.0 %	± 0.0 %	∞	
Source to liquid distance	± 2.0 %	Rectangular	√ 3	1	1	± 1.2 %	± 1.2 %	∞	
Power drift	± 3.4 %	Rectangular	√ 3	1	1	± 2.0 %	± 2.0 %	∞	
<b>Phantom and Set-up</b>									
Phantom uncertainty	± 4.0 %	Rectangular	√ 3	1	1	± 2.3 %	± 2.3 %	∞	
SAR correction	± 1.9 %	Rectangular	√ 3	1	0.84	± 1.1 %	± 0.9 %	∞	
Liquid conductivity (meas.)	± 5.0 %	Normal	1	0.78	0.71	± 3.9 %	± 3.6 %	∞	
Liquid permittivity (meas.)	± 5.0 %	Normal	1	0.26	0.26	± 1.3 %	± 1.3 %	∞	
Temp. unc. - Conductivity	± 1.7 %	Rectangular	√ 3	0.78	0.71	± 0.8 %	± 0.7 %	∞	
Temp. unc. - Permittivity	± 0.3 %	Rectangular	√ 3	0.23	0.26	± 0.0 %	± 0.0 %	∞	
<b>Combined Uncertainty</b>						± 9.1 %	± 8.9 %	330	
<b>Expanded Std. Uncertainty</b>						± 18.2 %	± 17.9 %		

Table 6: Measurement uncertainties of the System Check with DASY5 (0.3-3GHz)

Repeatability Budget for System Check (Frequency band: 300MHz - 6GHz range) with DASY8 System									
Symbol	Error Description	Uncertainty Value	Probability Distribution	Divisor	c <sub>i</sub>	c <sub>i</sub>	Standard Uncertainty		
					(1g)	(10g)	± %, (1g)	± %, (10g)	
<b>Measurement System Errors</b>									
CF	Probe Calibration Repeat.	± 3.6 %	Normal	2	2	1	± 5.1 %	± 2.5 %	
CFdrift	Probe Calibration Drift	± 1.7 %	Rectangular	√ 3	1	1	± 1.0 %	± 1.0 %	
LIN	Probe linearity	± 4.7 %	Rectangular	√ 3	0	0	± 0.0 %	± 0.0 %	
BBS	Broadband Signal	± 0.0 %	Rectangular	√ 3	0	0	± 0.0 %	± 0.0 %	
ISO	Probe Isotropy (axial)	± 4.7 %	Rectangular	√ 3	0	0	± 0.0 %	± 0.0 %	
DAE	Data Acquisition	± 0.3 %	Normal	1	0	0	± 0.0 %	± 0.0 %	
AMB	RF Ambient	± 0.6 %	Normal	1	0	0	± 0.0 %	± 0.0 %	
$\Delta_{sys}$	Probe Positioning	± 0.2 %	Normal	1	0.33	0.33	± 0.1 %	± 0.1 %	
DAT	Data Processing	± 0.0 %	Normal	1	1	1	± 0.0 %	± 0.0 %	
<b>Phantom and Device Errors</b>									
LIQ( $\sigma$ )	Conductivity (meas.) <sup>DAK</sup>	± 2.5 %	Normal	1	0.78	0.71	± 2.0 %	± 1.8 %	
LIQ( $T\sigma$ )	Conductivity (temp.) <sup>BB</sup>	± 3.4 %	Rectangular	√ 3	0.78	0.71	± 1.5 %	± 1.4 %	
EPS	Phantom Permittivity	± 14.0 %	Rectangular	√ 3	0	0	± 0.0 %	± 0.0 %	
DIS	Distance Phantom - DUT	± 1.0 %	Normal	1	2	2	± 2.0 %	± 2.0 %	
MOD	DUT Modulation <sup>m</sup>	± 0.0 %	Rectangular	√ 3	1	1	± 0.0 %	± 0.0 %	
TAS	Time-average SAR	± 0.0 %	Rectangular	√ 3	1	1	± 0.0 %	± 0.0 %	
VAL	Validation antenna	± 0.0 %	Normal	1	1	1	± 0.0 %	± 0.0 %	
P <sub>in</sub>	Accepted power	± 1.2 %	Normal	1	1	1	± 1.2 %	± 1.2 %	
<b>Correction to the SAR results</b>									
C( $\epsilon, \sigma$ )	Deviation to Target	± 1.9 %	Normal	1	1	0.84	± 1.9 %	± 1.6 %	
<b>u(<math>\Delta</math>SAR)</b>	<b>Combined Uncertainty</b>						± 6.5 %	± 4.5 %	
<b>U</b>	<b>Expanded Uncertainty</b>						± 13.0 %	± 9.1 %	

Table 7: Repeatability of the system check (300MHz - 6 GHz).

All listed error components have  $v_{eff}$  equal to  $\infty$ .

**Footnote details:**

<sup>BB</sup> if SPEAG's broad-band liquids (BBL) are used that have low temperature coefficients;

<sup>DAK</sup> if SPEAG's high precision dielectric probe kit (DAK) is applied.

Note: Worst case probe calibration uncertainty has been applied for all probes used during the measurements.

### 7.1.14 System check

The system check is performed for verifying the accuracy of the complete measurement system and performance of the software. The system check is performed with tissue equivalent material according to IEEE 1528. The following table shows system check results for all frequency bands and tissue liquids used during the tests (plot(s) see annex A).

System performance check (1000 mW)									
System validation Kit	Probe	Frequency	Target SAR <sub>1g</sub> /mW/g (+/- 10%)	Target SAR <sub>10g</sub> /mW/g (+/- 10%)	Measured SAR <sub>1g</sub> / mW/g	SAR <sub>1g</sub> dev.	Measured SAR <sub>10g</sub> / mW/g	SAR <sub>10g</sub> dev.	Measured date
D450V3 S/N: 1060	EX3DV4 S/N: 7635	450 MHz HSL	4.45	2.99	4.10	-7.9%	2.80	-6.4%	2022-04-29
D600V3 S/N: 1015	EX3DV4 S/N: 7635	600 MHz HSL	6.31	4.17	6.83	8.2%	4.49	7.7%	2022-05-02
D2450V2 S/N: 710	EX3DV4 S/N: 7566	2450 MHz HSL	51.80	24.10	54.30	4.8%	24.90	3.3%	2022-05-06

Table 8: Results system check

### 7.1.15 System check procedure

The system check is performed by using a validation dipole which is positioned parallel to the planar part of the SAM phantom at the reference point. The distance of the dipole to the SAM phantom is determined by a plexiglass spacer. The dipole is connected to the signal source consisting of signal generator and amplifier via a directional coupler, N-connector cable and adaption to SMA. It is fed with a power of 1000 mW for frequencies below 2 GHz or 100 mW for frequencies above 2 GHz. To adjust this power a power meter is used. The power sensor is connected to the cable before the system check to measure the power at this point and do adjustments at the signal generator. At the outputs of the directional coupler both return loss as well as forward power are controlled during the validation to make sure that emitted power at the dipole is kept constant. This can also be checked by the power drift measurement after the test (result on plot).

System check results have to be equal or near the values determined during dipole calibration (target SAR in table above) with the relevant liquids and test system.

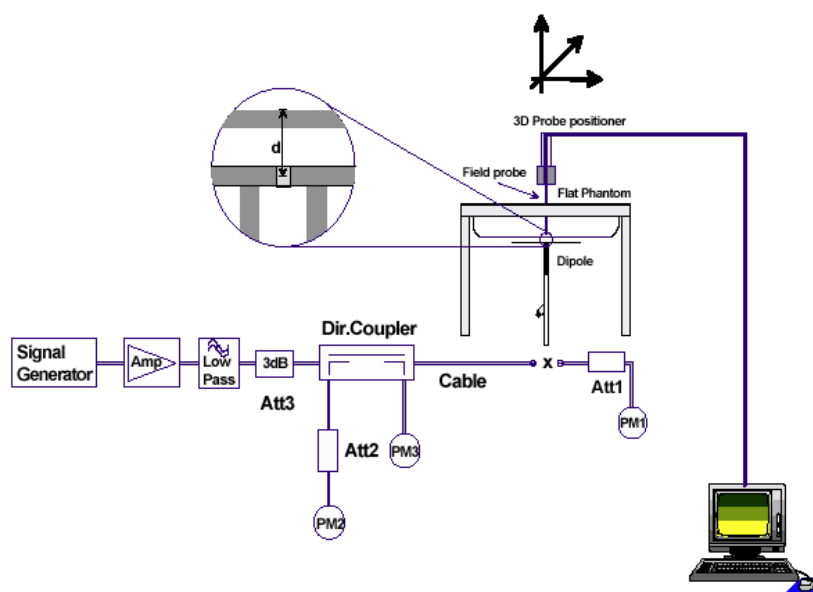

### 7.1.16 System validation

The system validation is performed in a similar way as a system check. It needs to be performed once a SAR measurement system has been established and allows an evaluation of the system accuracy with all components used together with the specified system. It has to be repeated at least once a year or when new system components are used (DAE, probe, phantom, dipole, liquid type).

In addition to the procedure used during system check a system validation also includes checks of probe isotropy, probe modulation factor and RF signal.

## 8 Detailed Test Results

### 8.1 Conducted power measurements

	normal mode			ld mode		
MHz	470.2	510.0	550.0	470.2	510.0	550.0
P <sub>avg</sub> (dBm)	8.71	9.27	9.03	8.84	9.32	9.08
	normal mode			ld mode		
MHz	520.0	564.0	607.8	520.0	564.0	607.8
P <sub>avg</sub> (dBm)	8.8	8.89	8.48	8.69	8.91	8.45

Table 9: Test results conducted average power measurement UHF

#### 8.1.1 Conducted average power measurements Bluetooth LE 2.4 GHz

Channel	Frequency (MHz)	Average power (dBm)
		GFSK
0	2402	3.2
19	2440	3.1
39	2480	3.0

Table 10: Test results conducted average power measurement BLUETOOTH LE 2.4 GHz

## 8.2 SAR test results

### 8.2.1 General description of test procedures

- The DUT was tested using a CBT communication tester in BT-test mode to adjust maximum output power, test channels and operating mode.  
(GFSK - DH5 - STATIC PBRS - 76% duty cycle)
- According to IEEE 1528 the SAR test shall be performed at middle channel. Testing of top and bottom channel is optional.
- According to KDB 447498 D01 testing of other required channels within the operating mode of a frequency band is not required when the reported 1-g or 10-g SAR for the mid-band or highest output power channel is:
  - $\leq 0.8$  W/kg or 2.0 W/kg, for 1-g or 10-g respectively, when the transmission band is  $\leq 100$  MHz
  - $\leq 0.6$  W/kg or 1.5 W/kg, for 1-g or 10-g respectively, when the transmission band is between 100 MHz and 200 MHz
  - $\leq 0.4$  W/kg or 1.0 W/kg, for 1-g or 10-g respectively, when the transmission band is  $\geq 200$  MHz
- IEEE 1528 requires the middle channel to be tested first. This generally applies to wireless devices that are designed to operate in technologies with tight tolerances for maximum output power variations across channels in the band. When the maximum output power variation across the required test channels is  $> \frac{1}{2}$  dB, instead of the middle channel, the highest output power channel must be used.

## 8.2.2 Results overview

measured / extrapolated SAR numbers SKM											
Freq. (MHz)	mode	Position	cond. P <sub>max</sub> (dBm)		SAR <sub>1g</sub> (W/kg)		SAR <sub>10g</sub> (W/kg)		power drift (dB)	liquid (°C)	dist. (mm)
			declared*	measured	meas.	extrap.	meas.	extrap.			
EW-DX SKM (Q1-9) 470.2-550.0 MHz											
510.0	ld	front	10.7	9.3	0.032	0.044	0.015	0.021	-0.04	21.7	0
510.0	ld	left	10.7	9.3	0.035	0.048	0.017	0.024	-0.13	21.7	0
510.0	ld	back	10.7	9.3	0.034	0.046	0.018	0.025	0.09	21.7	0
470.2	ld	right	10.7	8.8	<b>0.043</b>	<b>0.065</b>	<b>0.020</b>	<b>0.030</b>	-0.06	21.7	0
510.0	ld	right	10.7	9.3	0.038	0.052	0.018	0.024	-0.07	21.7	0
550.0	ld	right	10.7	9.1	0.031	0.045	0.017	0.025	0.06	21.7	0
510.0	normal	front (wc)	10.7	9.3	0.031	0.043	0.015	0.021	0.03	21.7	0
EW-DX SKM (R1-9) 520-607.8 MHz											
564.0	ld	front	10.7	9.3	0.041	0.056	0.021	0.029	-0.18	21.5	0
564.0	ld	left	10.7	9.3	0.037	0.051	0.021	0.028	-0.16	21.5	0
564.0	ld	back	10.7	9.3	0.032	0.044	0.018	0.025	-0.14	21.5	0
564.0	ld	right	10.7	9.3	0.035	0.048	0.019	0.026	-0.11	21.5	0
520.0	normal	front (wc)	10.7	8.8	0.037	0.057	0.018	0.028	-0.16	21.5	0
510.0	normal	front (wc)	10.7	9.3	<b>0.042</b>	<b>0.058</b>	<b>0.021</b>	<b>0.029</b>	-0.16	21.5	0
607.8	normal	front (wc)	10.7	9.1	0.017	0.025	0.009	0.013	-0.13	21.5	0
EW-DX SKM BT LE											
2440	1Mbps	front	4.0	3.1	0.004	0.005	0.004	0.005	-0.04	21.6	0
2440	1Mbps	left	4.0	3.1	0.031	0.038	0.014	0.017	0.19	21.6	0
2402	1Mbps	back	4.0	3.2	0.025	0.030	0.012	0.014	-0.09	21.6	0
2440	1Mbps	back	4.0	3.1	<b>0.042</b>	<b>0.052</b>	<b>0.018</b>	<b>0.022</b>	-0.02	21.6	0
2480	1Mbps	back	4.0	3.0	0.028	0.036	0.013	0.017	0.19	21.6	0
2440	1Mbps	right	4.0	3.1	0.004	0.005	0.003	0.004	0.14	21.6	0

Table 11: Test results SAR (see max. SAR plot in Annex B: DASy measurement results page 36)

\* - maximum possible output power declared by manufacturer.

## 8.2.3 Multiple Transmitter Information

The following tables list information which is relevant for the decision if a simultaneous transmit evaluation is necessary according to FCC KDB 447498D01 General RF Exposure Guidance v05.

Position	SAR <sub>max1g</sub> /W/kg		ΣSAR <sub>1g</sub> <1.6W/kg
	470MHz	BT LE	
front	0.058	0.005	0.063
left	0.051	0.038	0.089
back	0.046	0.052	<b>0.098</b>
right	0.065	0.005	0.070
Position	SAR <sub>max10g</sub> /W/kg		ΣSAR <sub>10g</sub> <4W/kg
	470MHz	BT LE	
front	0.029	0.005	0.034
left	0.028	0.017	0.045
back	0.025	0.022	<b>0.047</b>
right	0.030	0.004	0.034

Table 12: SAR<sub>max</sub> ΣSAR evaluation.

### Conclusion:

ΣSAR < 1.6 W/kg, therefore simultaneous transmissions SAR measurement with the enlarged zoom scan measurement and volume scan post-processing procedures is **not** required.

## 9 Test equipment and ancillaries used for tests

To simplify the identification of the test equipment and/or ancillaries which were used, the reporting of the relevant test cases only refer to the test item number as specified in the table below.

Equipment	Type	Manufacturer	Serial No.	Last Calibration	Frequency (months)
Dosimetric E-Field Probe	EX3DV4	Schmid & Partner Engineering AG	7566	August 16, 2021	12
Dosimetric E-Field Probe	EX3DV4	Schmid & Partner Engineering AG	7635	January 14, 2022	12
450 MHz System Validation Dipole	D450V3	Schmid & Partner Engineering AG	1060	January 15, 2020	36
600 MHz System Validation Dipole	D600V3	Schmid & Partner Engineering AG	1015	May 18, 2022	36
2450 MHz System Validation Dipole	D2450V2	Schmid & Partner Engineering AG	710	May 11, 2022	36
Data acquisition electronics	DAE3V1	Schmid & Partner Engineering AG	413	January 07, 2022	12
Data acquisition electronics	DAE4	Schmid & Partner Engineering AG	1387	August 06, 2021	12
Software	DASY52 52.10.4.1527	Schmid & Partner Engineering AG	---	N/A	--
Software	DASY8 V16.0.0.65	Schmid & Partner Engineering AG	---	N/A	--
SAM Twin Phantom V5.0	QD 000 P40 C	Schmid & Partner Engineering AG	1977 1043	N/A	--
Bluetooth Tester	CMW270	Rohde & Schwarz	102550	September 17, 2021	24
Network Analyser 300 kHz to 6 GHz	8753ES	Agilent Technologies)*	US39174 436	December 14, 2021	24
Dielectric Assessment Kit (DAK)	DAK 200MHz – 20GHz Package	Schmid & Partner Engineering AG	1127	N/A	--
Signal Generator	SML03	Rohde & Schwarz	102519	December 06, 2021	12
RF Power Amplifier	BLMA 0760-6 (6 Watt)	BONN Elektronik	1510273	N/A	--
Power Meter	NRP	Rohde & Schwarz	101367	December 07, 2021	12
Power Meter Sensor	NRP Z22	Rohde & Schwarz	100227	December 06, 2021	12
Power Meter Sensor	NRP Z22	Rohde & Schwarz	100234	December 06, 2021	12
Directional Coupler	778D	Hewlett Packard	19171	December 06, 2021	12

)\* : Network analyzer probe calibration against air, distilled water and a shorting block performed before measuring liquid parameters.

## 10 Observations

No observations exceeding those reported with the single test cases have been made.



## Annex A: System performance check

Date/Time: 29.04.2022 09:13:20

### SystemPerformanceCheck HSL 2022-04-29

**DUT: Dipole 450 MHz; Type: D450V2; Serial: 1060**

Communication System: UID 0, CW (0); Communication System Band: D450 (450.0 MHz); Frequency: 450 MHz; Communication System PAR: 0 dB; PMF: 1

Medium parameters used:  $f = 450$  MHz;  $\sigma = 0.783$  S/m;  $\epsilon_r = 45.515$ ;  $\rho = 1000$  kg/m<sup>3</sup>

Phantom section: Flat Section

Measurement Standard: DASY5

DASY5 Configuration:

- Probe: EX3DV4 - SN7635; ConvF(11.76, 11.76, 11.76) @ 450 MHz; Calibrated: 14.01.2022
- Sensor-Surface: 3mm (Mechanical Surface Detection), Sensor-Surface: 1.4mm (Mechanical Surface Detection),  $z = 1.0, 31.0$
- Electronics: DAE3 Sn413; Calibrated: 07.01.2022
- Phantom: SAM; Type: SAM; Serial: 1043
- DASY52 52.10.4(1527); SEMCAD X 14.6.14(7483)

**Dipole 450MHz/d=15mm, Pin=100mW/Area Scan (41x81x1):** Interpolated grid:

$dx=1.500$  mm,  $dy=1.500$  mm

Maximum value of SAR (interpolated) = 0.465 W/kg

**Dipole 450MHz/d=15mm, Pin=100mW/Zoom Scan (6x6x7)/Cube 0:** Measurement

grid:  $dx=6$ mm,  $dy=6$ mm,  $dz=5$ mm

Reference Value = 24.28 V/m; Power Drift = -0.01 dB

Peak SAR (extrapolated) = 0.625 W/kg

**SAR(1 g) = 0.410 W/kg; SAR(10 g) = 0.280 W/kg**

Smallest distance from peaks to all points 3 dB below: Larger than measurement grid

Ratio of SAR at M2 to SAR at M1 = 66%

Maximum value of SAR (measured) = 0.540 W/kg

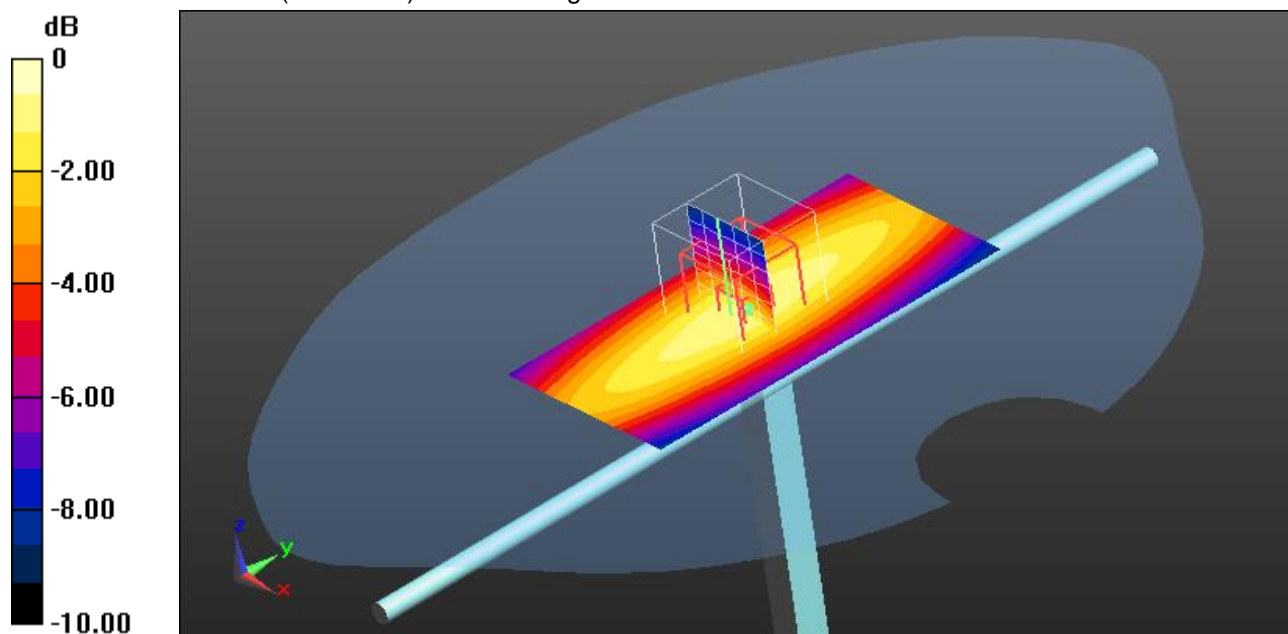

0 dB = 0.540 W/kg = -2.68 dBW/kg

#### Additional information:

ambient temperature: 22.9°C; liquid temperature: 21.7°C

## SystemPerformanceCheck HSL 2022-05-02

**DUT: Dipole 600 MHz; Type: D600V3; Serial: 1015**

Communication System: UID 0, CW (0); Communication System Band: D600 (600.0 MHz); Frequency: 600 MHz; Communication System PAR: 0 dB; PMF: 1

Medium parameters used:  $f = 600$  MHz;  $\sigma = 0.912$  S/m;  $\epsilon_r = 42.392$ ;  $\rho = 1000$  kg/m<sup>3</sup>

Phantom section: Flat Section

Measurement Standard: DASY5

DASY5 Configuration:

- Probe: EX3DV4 - SN7635; ConvF(11.03, 11.03, 11.03) @ 600 MHz; Calibrated: 14.01.2022
- Sensor-Surface: 3mm (Mechanical Surface Detection), Sensor-Surface: 1.4mm (Mechanical Surface Detection),  $z = 1.0, 31.0$
- Electronics: DAE3 Sn413; Calibrated: 07.01.2022
- Phantom: SAM; Type: SAM; Serial: 1043
- DASY52 52.10.4(1527); SEMCAD X 14.6.14(7483)

**Dipole 600MHz/d=15mm, Pin=100mW/Area Scan (41x81x1):** Interpolated grid:

$dx=1.500$  mm,  $dy=1.500$  mm

Maximum value of SAR (interpolated) = 0.783 W/kg

**Dipole 600MHz/d=15mm, Pin=100mW/Zoom Scan (6x6x7)/Cube 0:** Measurement

grid:  $dx=6$ mm,  $dy=6$ mm,  $dz=5$ mm

Reference Value = 29.55 V/m; Power Drift = -0.08 dB

Peak SAR (extrapolated) = 1.09 W/kg

**SAR(1 g) = 0.683 W/kg; SAR(10 g) = 0.449 W/kg**

Smallest distance from peaks to all points 3 dB below: Larger than measurement grid

Ratio of SAR at M2 to SAR at M1 = 62.9%

Maximum value of SAR (measured) = 0.924 W/kg

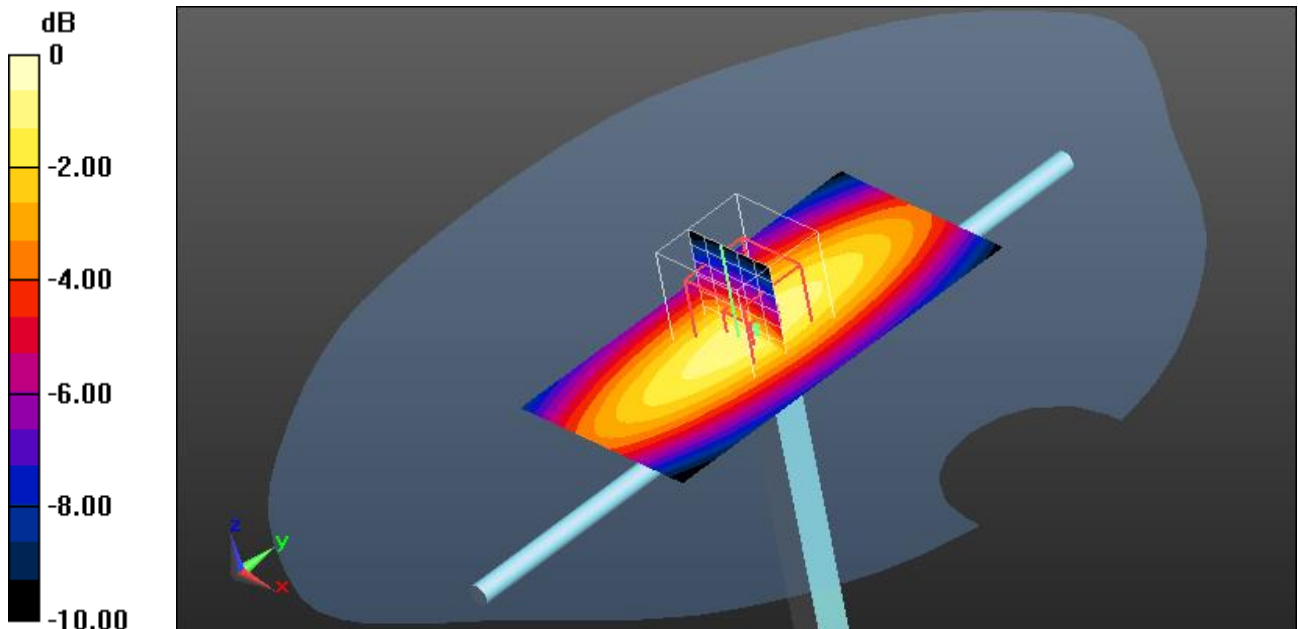

0 dB = 0.924 W/kg = -0.34 dBW/kg

### Additional information:

ambient temperature: 22.9°C; liquid temperature: 21.7°C

## SystemPerformanceCheck-D2450 HSL 2022-05-06

DUT: Dipole; Type: D2450V2; Serial: SN710

Communication System: CW; Communication System Frequency: 2450.0 MHz

Medium parameters used:  $f = 2450.0$  MHz,  $\sigma = 1.84$  S/m;  $\epsilon_r = 38.9$ ;  $\rho = 1000$  kg/m<sup>3</sup>

Phantom Section: Flat

Measurement Standard: DASY 8

DASY Configuration:

- Probe: EX3DV4 - SN7566; ConvF(7.54, 7.54, 7.54); Calibrated: 2021-08-16

- Sensor-Surface: 1.4 mm

- DAE: DAE4 Sn1387; Calibrated: 2021-08-06

- Phantom: Twin-SAM V8.0 (30deg probe tilt); Serial: 1977;

- Software: DASY8 Module SAR V16.0.0.65

### HBBL-600-10000/2450.0MHz/Area Scan (10.0 x 10.0 x 1.0) :

Grid Extents [mm]: 40.0 x 80.0

Maximum value of SAR (interpolated) - SAR(1 g) = 5.39 W/kg; SAR(10 g) = 2.54 W/kg

### HBBL-600-10000/2450.0MHz/Zoom Scan (5.0 x 5.0 x 1.5) :

Grid Extents [mm]: 30.0 x 30.0 x 30.0

Power Drift = -0.05 dB

**SAR(1 g) = 5.43 W/kg; SAR(10 g) = 2.49 W/kg**

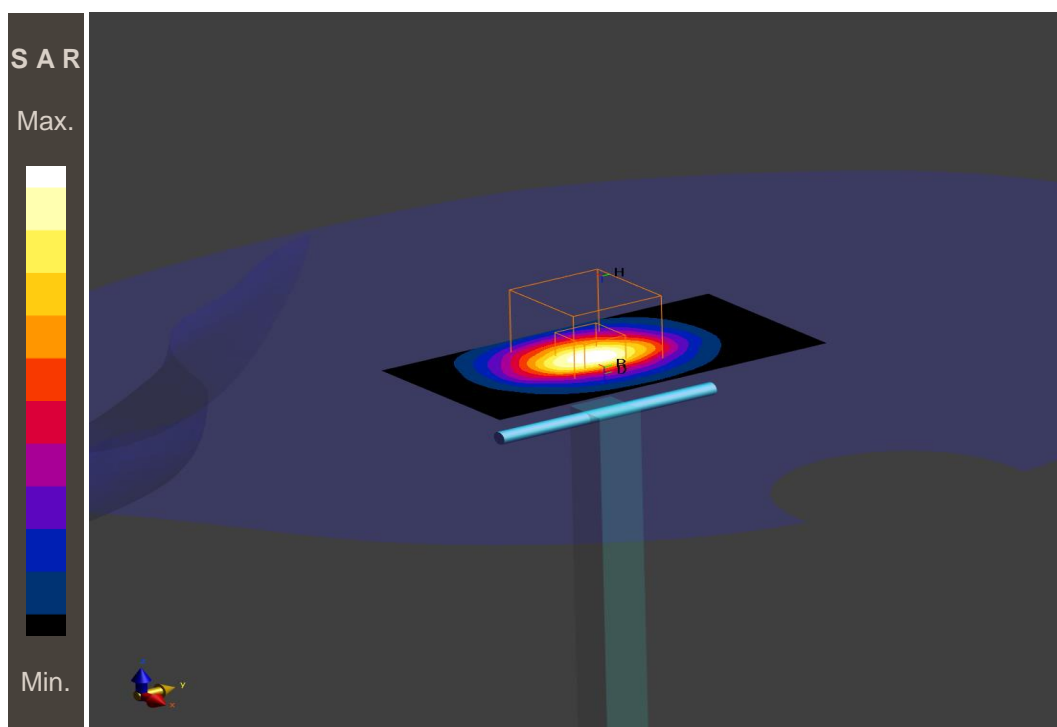

### Additional information:

ambient temperature: 21.4°C; liquid temperature: 21.6°C;

## Annex B: DASY measurement results

SAR plots for the **highest measured SAR** in each exposure configuration, wireless mode and frequency band combination according to FCC KDB 865664 D02

Date/Time: 29.04.2022 11:50:19

### FCC\_SKM

**DUT: Sennheiser; Type: EW-DX SKM (Q1-9); Serial: 1122000099**

Communication System: UID 0, FM (0); Communication System Band: FM-514; Frequency: 470.2 MHz;

Communication System PAR: 0 dB; PMF: 1.12202e-005

Medium parameters used (interpolated):  $f = 470.2$  MHz;  $\sigma = 0.8$  S/m;  $\epsilon_r = 45.067$ ;  $\rho = 1000$  kg/m<sup>3</sup>

Phantom section: Flat Section

Measurement Standard: DASY5

DASY5 Configuration:

- Probe: EX3DV4 - SN7635; ConvF(11.76, 11.76, 11.76) @ 470.2 MHz; Calibrated: 14.01.2022
- Sensor-Surface: 3mm (Mechanical Surface Detection (Locations From Previous Scan Used)), Sensor-Surface: 1.4mm (Mechanical Surface Detection),  $z = -9.0, 26.0$
- Electronics: DAE3 Sn413; Calibrated: 07.01.2022
- Phantom: SAM; Type: SAM; Serial: 1043
- DASY52 52.10.4(1527); SEMCAD X 14.6.14(7483)

**EW-DX SKM/Right position - 470.2 MHz/Area Scan (61x161x1):** Interpolated grid:

$dx=1.500$  mm,  $dy=1.500$  mm

Maximum value of SAR (interpolated) = 0.0649 W/kg

**EW-DX SKM/Right position - 470.2 MHz/Zoom Scan (6x6x7)/Cube 0:** Measurement

grid:  $dx=6$ mm,  $dy=6$ mm,  $dz=5$ mm

Reference Value = 8.668 V/m; Power Drift = -0.07 dB

Peak SAR (extrapolated) = 0.147 W/kg

**SAR(1 g) = 0.043 W/kg; SAR(10 g) = 0.020 W/kg**

Smallest distance from peaks to all points 3 dB below: Larger than measurement grid

Ratio of SAR at M2 to SAR at M1 = 28.2%

Maximum value of SAR (measured) = 0.0912 W/kg

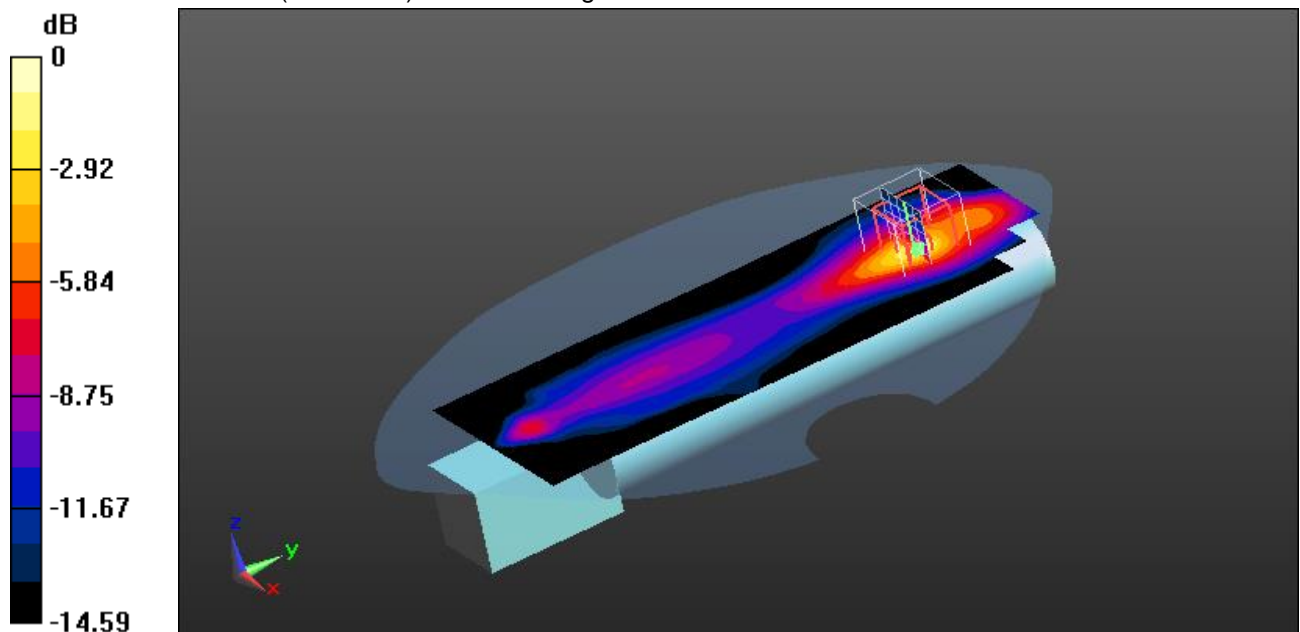

0 dB = 0.0912 W/kg = -10.40 dBW/kg

#### Additional information:

position or distance of DUT to SAM: 0 mm

ambient temperature: 22.9°C; liquid temperature: 21.7°C

## FCC\_SKM\_600MHz

**DUT: Sennheiser; Type: EW-DX SKM (R1-9); Serial: 1122000054**

Communication System: UID 0, FM (0); Communication System Band: FM-600; Frequency: 564 MHz;

Communication System PAR: 0 dB; PMF: 1.12202e-005

Medium parameters used (interpolated):  $f = 564$  MHz;  $\sigma = 0.88$  S/m;  $\epsilon_r = 43.086$ ;  $\rho = 1000$  kg/m<sup>3</sup>

Phantom section: Flat Section

Measurement Standard: DASY5

DASY5 Configuration:

- Probe: EX3DV4 - SN7635; ConvF(11.03, 11.03, 11.03) @ 564 MHz; Calibrated: 14.01.2022
- Sensor-Surface: 3mm (Mechanical Surface Detection (Locations From Previous Scan Used)), Sensor-Surface: 1.4mm (Mechanical Surface Detection),  $z = -9.0, 26.0$
- Electronics: DAE3 Sn413; Calibrated: 07.01.2022
- Phantom: SAM; Type: SAM; Serial: 1043
- DASY52 52.10.4(1527); SEMCAD X 14.6.14(7483)

### EW-DX SKM/Front position - normal mode - middle/Area Scan (61x161x1):

Interpolated grid:  $dx=1.500$  mm,  $dy=1.500$  mm

Maximum value of SAR (interpolated) = 0.0652 W/kg

### EW-DX SKM/Front position - normal mode - middle/Zoom Scan (6x6x7)/Cube

**0:** Measurement grid:  $dx=6$ mm,  $dy=6$ mm,  $dz=5$ mm

Reference Value = 8.363 V/m; Power Drift = -0.16 dB

Peak SAR (extrapolated) = 0.119 W/kg

**SAR(1 g) = 0.042 W/kg; SAR(10 g) = 0.021 W/kg**

Smallest distance from peaks to all points 3 dB below: Larger than measurement grid

Ratio of SAR at M2 to SAR at M1 = 63.3%

Maximum value of SAR (measured) = 0.0769 W/kg

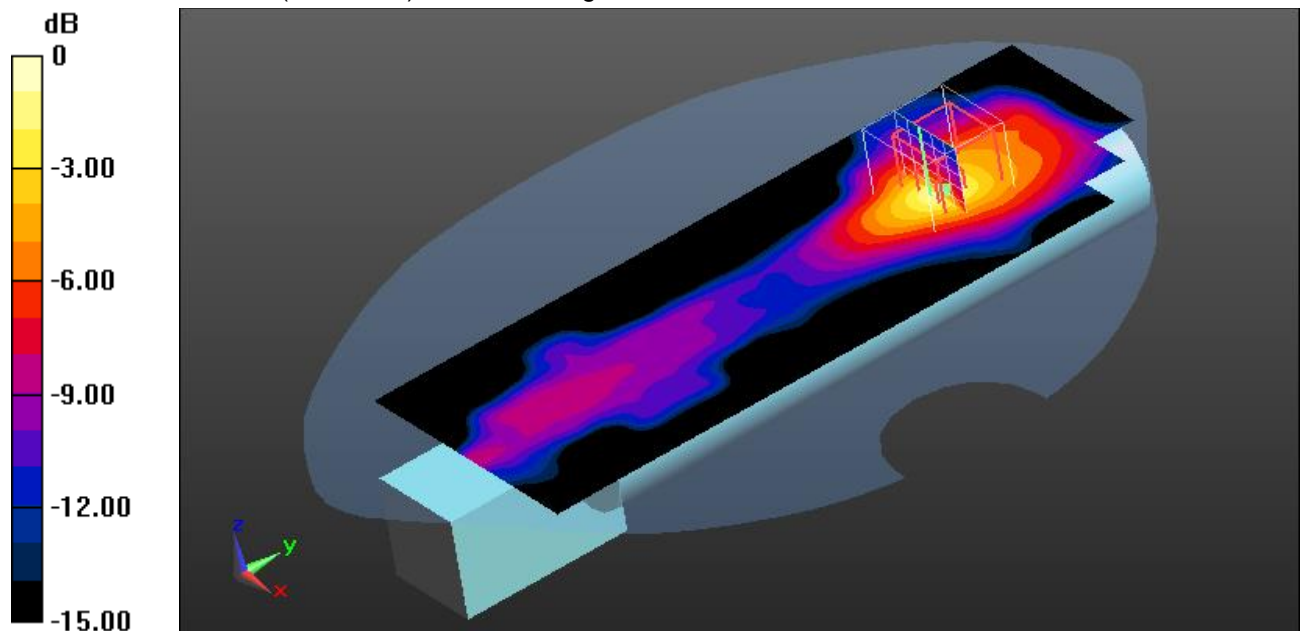

0 dB = 0.0769 W/kg = -11.14 dBW/kg

#### Additional information:

position or distance of DUT to SAM: 0 mm

ambient temperature: 22.7°C; liquid temperature: 21.5°C

**IEC\_ IEEE 62209-1528 - BT LE 2450****DUT: Sennheiser; Type: EW-DX SKM; Serial: 1122000099**

Communication System: Bluetooth Low Energy; Communication System Band: ISM 2.4 GHz Band;

Communication System Frequency: 2440.0 MHz

Medium parameters used:  $f = 2440.0$  MHz,  $\sigma = 1.83$  S/m;  $\epsilon_r = 38.9$ ;  $\rho = 1000$  kg/m<sup>3</sup>

Phantom Section: Flat

Measurement Standard: DASy 8

DASy Configuration:

- Probe: EX3DV4 - SN7566; ConvF(7.54, 7.54, 7.54); Calibrated: 2021-08-16

- Sensor-Surface: 1.4mm

- DAE: DAE4 Sn1387; Calibrated: 2021-08-06

- Phantom: Twin-SAM V8.0 (30deg probe tilt); Serial: 1977;

- Software: DASy8 Module SAR V16.0.0.65

**HBBL-600-10000/BACK, 0 mm - Channel middle/Area Scan (10.0 x 10.0 x 1.0) :**

Grid Extents [mm]: 60.0 x 60.0

Maximum value of SAR (interpolated) - SAR(1 g) = 0.042 W/kg; SAR(10 g) = 0.018 W/kg

**HBBL-600-10000/BACK, 0 mm - Channel middle/Zoom Scan (5.0 x 5.0 x 1.5) :**

Grid Extents [mm]: 30.0 x 30.0 x 30.0

Graded Grid: Ratio 1.5 - Distance Sensor to Surface 1.4 mm

Power Drift = -0.02 dB

**SAR(1 g) = 0.042 W/kg; SAR(10 g) = 0.018 W/kg**

Additional Info for IEC 62209-2 AMD1:

TDist 3dB Peak [mm]: &gt; 15.0

M1/M2%: 73.3

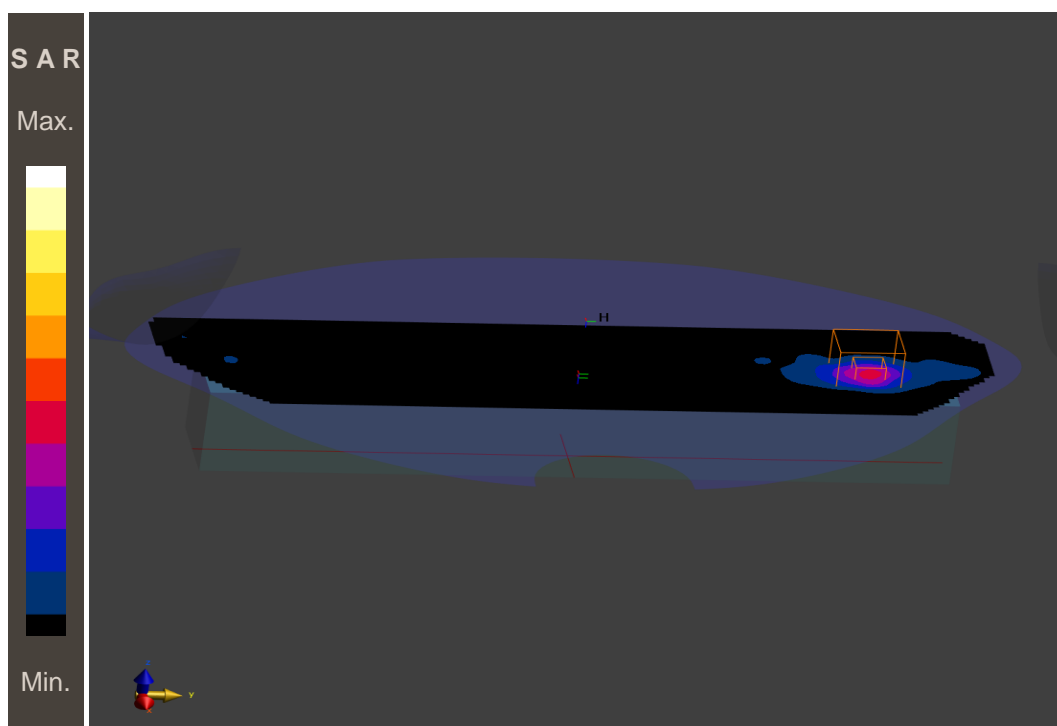
**Additional information:**

position or distance of DUT to SAM: 0 mm

ambient temperature: 22.5°C; liquid temperature: 21.6°C;

## Annex B.1: Liquid depth

Photo 1: Liquid depth HBBL600-10000MHz Simulating Head Liquid

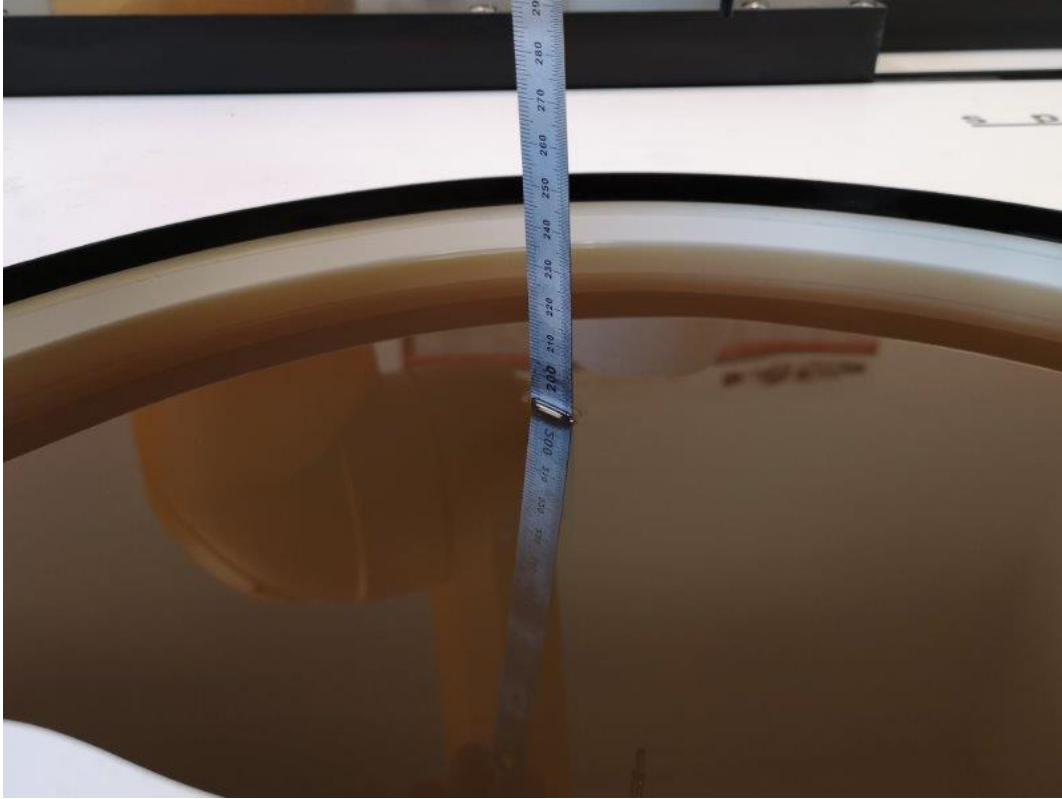



## **Annex C: Photo documentation**

Photo documentation is described in the additional document:

### **Appendix to test report no. 1-2868/21-03-02 Photo documentation**

## **Annex D: Calibration parameters**

Calibration parameters are described in the additional document:

### **Appendix to test report no. 1-2868/21-03-02 Calibration data, Phantom certificate and detail information of the DASY System**

## **Annex E: RSS-102 Annex A1**

ISED RF documents are described in the additional document:

### **Appendix to test report no. 1-2868/21-03-02\_ISED RF RF Technical Brief Cover Sheet acc. To RSS-102 Annex A1.**



## Annex F: Document History

Version	Applied Changes	Date of Release
	Initial Release	2022-07-07

## Annex G: Further Information

### Glossary

DTS	-	Distributed Transmission System
DUT	-	Device under Test
EUT	-	Equipment under Test
FCC	-	Federal Communication Commission
FCC ID	-	Company Identifier at FCC
HW	-	Hardware
Inv. No.	-	Inventory number
ISED	-	Innovation, Science and Economic Development Canada
N/A	-	not applicable
OET	-	Office of Engineering and Technology
SAR	-	Specific Absorption Rate
S/N	-	Serial Number
SW	-	Software
UNII	-	Unlicensed National Information Infrastructure