

TEST REPORT

Test report no.: 1-2867/21-01-16-C

BNetzA-CAB-02/21-102

Testing laboratory

CTC advanced GmbH

Untertuerkheimer Strasse 6 – 10

66117 Saarbruecken / Germany

Phone: + 49 681 5 98 - 0

Fax: + 49 681 5 98 - 9075

Internet: <https://www.ctcadvanced.com>

e-mail: mail@ctcadvanced.com

Accredited Testing Laboratory:

The testing laboratory (area of testing) is accredited according to DIN EN ISO/IEC 17025 (2018-03) by the Deutsche Akkreditierungsstelle GmbH (DAkkS)

The accreditation is valid for the scope of testing procedures as stated in the accreditation certificate starting with the registration number: D-PL-12076-01.

Applicant

Sennheiser electronic GmbH & Co. KG

Am Labor 1

30900 Wedemark / GERMANY

Phone: +49 5130 600-0

Contact: Ouajdi Ochi

e-mail: Ouajdi.Ochi@sennheiser.com

Manufacturer

Sennheiser electronic GmbH & Co. KG

Am Labor 1

30900 Wedemark / GERMANY

Test standard/s

FCC - Title 47 CFR Part 74 FCC - Title 47 of the Code of Federal Regulations; Chapter I; Part 74 - Experimental radio, auxiliary, special broadcast and other program distributional services

RSS - 123 Issue 4 Licensed Wireless Microphones

For further applied test standards please refer to section 3 of this test report.

Test Item

Test item description: **Bodypack Transmitter**
Model No.: **EW-DX SK9M**
FCC ID: **DMOSKEWDX9M**
IC: **2099A-SKEWDX**
Frequency: 941.7MHz – 951.8MHz / 953.05MHz - 956.05MHz / 956.65MHz -959.65MHz
Technology tested: proprietary
Antenna: internal monopole
Power supply: 2.50 V to 4.35 V DC by battery Li-Ion BA 70 or 2x AA type 1.50 V DC
Temperature range: -10°C to +50°C

This test report is electronically signed and valid without handwritten signature. For verification of the electronic signatures, the public keys can be requested at the testing laboratory.

Test report authorized:



Christoph Schneider
Lab Manager
Radio Communications

Test performed:

p.o.

Tobias Wittenmeier
Testing Manager
Radio Communications

1 Table of contents

1	Table of contents	2
2	General information	3
2.1	Notes and disclaimer	3
2.2	Application details	3
2.3	Test laboratories sub-contracted	3
3	Test standard/s, references and accreditations	4
4	Reporting statements of conformity – decision rule	5
5	Test environment	6
6	Test item.....	6
6.1	General description	6
6.2	Additional information	7
7	Description of the test setup.....	8
7.1	Shielded fully anechoic chamber.....	9
7.2	Conducted measurements normal and extreme conditions.....	10
8	Sequence of testing	11
8.1	Sequence of testing radiated spurious 30 MHz to 12.75 GHz	11
9	Measurement uncertainty	12
10	Summary of measurement results.....	13
11	Additional comments	14
12	Measurement results.....	15
12.1	Transmitter output power	15
12.2	Occupied bandwidth	25
12.3	Transmitter frequency stability	34
12.4	Transmitter unwanted emissions (radiated)	38
12.5	Necessary bandwidth (BN) for digital systems.....	48
13	Observations	55
14	Glossary	56
15	Document history	57
16	Accreditation Certificate – D-PL-12076-01-04	57
17	Accreditation Certificate – D-PL-12076-01-05	58

2 General information

2.1 Notes and disclaimer

The test results of this test report relate exclusively to the test item specified in this test report. CTC advanced GmbH does not assume responsibility for any conclusions and generalizations drawn from the test results with regard to other specimens or samples of the type of the equipment represented by the test item.

The test report may only be reproduced or published in full. Reproduction or publication of extracts from the report requires the prior written approval of CTC advanced GmbH.

The testing service provided by CTC advanced GmbH has been rendered under the current "General Terms and Conditions for CTC advanced GmbH".

CTC advanced GmbH will not be liable for any loss or damage resulting from false, inaccurate, inappropriate or incomplete product information provided by the customer.

Under no circumstances does the CTC advanced GmbH test report include any endorsement or warranty regarding the functionality, quality or performance of any other product or service provided.

Under no circumstances does the CTC advanced GmbH test report include or imply any product or service warranties from CTC advanced GmbH, including, without limitation, any implied warranties of merchantability, fitness for purpose, or non-infringement, all of which are expressly disclaimed by CTC advanced GmbH.

All rights and remedies regarding vendor's products and services for which CTC advanced GmbH has prepared this test report shall be provided by the party offering such products or services and not by CTC advanced GmbH. In no case this test report can be considered as a Letter of Approval.

This test report is electronically signed and valid without handwritten signature. For verification of the electronic signatures, the public keys can be requested at the testing laboratory.

This test report replaces the test report with the number 1-2867/21-01-16-B and dated 2022-10-10

2.2 Application details

Date of receipt of order: 2022-02-22

Date of receipt of test item: 2022-07-11

Start of test:* 2022-07-11

End of test:* 2022-08-01

Person(s) present during the test: -/-

*Date of each measurement, if not shown in the plot, can be requested. Dates are stored in the measurement software.

2.3 Test laboratories sub-contracted

None

3 Test standard/s, references and accreditations

Test standard	Date	Description
FCC - Title 47 CFR Part 74		FCC - Title 47 of the Code of Federal Regulations; Chapter I; Part 74 - Experimental radio, auxiliary, special broadcast and other program distributional services
RSS - 123 Issue 4	August 2019	Licensed Wireless Microphones
ETSI EN 300 422-1 V1.4.2	2011-08	Electromagnetic compatibility and Radio spectrum Matters (ERM); Wireless microphones in the 25 MHz to 3 GHz frequency range; Part 1: Technical characteristics and methods of measurement

Guidance	Version	Description
ANSI C63.10-2013	-/-	American National Standard of Procedures for Compliance Testing of Unlicensed Wireless Devices

Accreditation	Description	
D-PL-12076-01-04	Telecommunication and EMC Canada https://www.dakks.de/as/ast/d/D-PL-12076-01-04e.pdf	 
D-PL-12076-01-05	Telecommunication FCC requirements https://www.dakks.de/as/ast/d/D-PL-12076-01-05e.pdf	 

ISED Testing Laboratory Recognized Listing Number: DE0001
FCC designation number: DE0002

4 Reporting statements of conformity – decision rule

Only the measured values related to their corresponding limits will be used to decide whether the equipment under test meets the requirements of the test standards listed in chapter 3.

The measurement uncertainty is mentioned in this test report, see chapter 9, but is not taken into account - neither to the limits nor to the measurement results. Measurement results with a smaller margin to the corresponding limits than the measurement uncertainty have a potential risk of more than 5% that the decision might be wrong."

measured value, measurement uncertainty, verdict

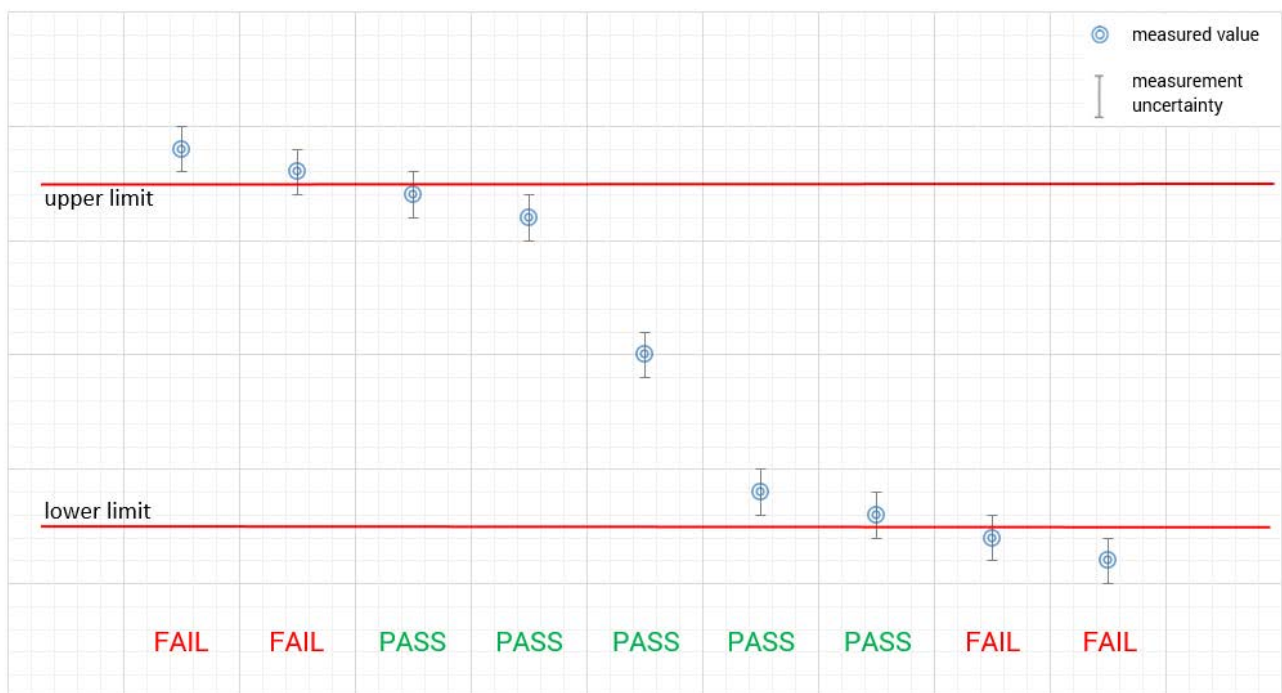

5 Test environment

Temperature	:	T_{nom} +20 °C during room temperature tests T_{max} +50 °C during high temperature tests T_{min} -10 °C during low temperature tests
Relative humidity content	:	55 %
Barometric pressure	:	1021 hpa
Power supply	:	V_{nom} 3.80 V DC by battery Li-Ion BA 70 or 2x AA type 1.50 V DC V_{max} 4.35 V V_{min} 2.50 V

6 Test item

6.1 General description

Test item description	:	Bodypack Transmitter
Model No.	:	EW-DX SK
Brand name	:	SENNHEISER
Serie	:	Evolution Wireless Digital
HMN	:	-/-
PMN	:	EW-DX SK
HVIN	:	EW-DX SK9M
FVIN	:	0.7.0
S/N serial number	:	Rad. 941.500 MHz – 959.850 MHz: 1082000015 Cond. 941.500 MHz – 959.850 MHz: 1082000013
Hardware status	:	592160_03
Software status	:	-/-
Firmware status	:	0.7.0
Frequency band	:	941.7MHz – 951.8MHz / 953.05MHz - 956.05MHz / 956.65MHz - 959.65MHz
Type of radio transmission	:	modulated carrier
Use of frequency spectrum	:	
Type of modulation	:	PI/4 DQPSK
Number of channels	:	Tuning step size: 25 kHz
Antenna	:	internal monopole
Power ratings	:	2.50 V to 4.35 V DC by battery Li-Ion BA 70 or 2x AA type 1.50 V DC
Operating temperature range	:	-10°C to +50°C

6.2 Additional information

The content of the following annexes is defined in the QA. It may be that not all of the listed annexes are necessary for this report, thus some values in between may be missing.

Test setup and EUT photos are included in test report:

- 1-2867/21-01-16_AnnexA
- 1-2867/21-01-16_AnnexB
- 1-2867/21-01-01_AnnexD

7 Description of the test setup

Typically, the calibrations of the test apparatus are commissioned to and performed by an accredited calibration laboratory. The calibration intervals are determined in accordance with the DIN EN ISO/IEC 17025. In addition to the external calibrations, the laboratory executes comparison measurements with other calibrated test systems or effective verifications. Weekly chamber inspections and range calibrations are performed. Where possible, RF generating and signaling equipment as well as measuring receivers and analyzers are connected to an external high-precision 10 MHz reference (GPS-based or rubidium frequency standard).

In order to simplify the identification of the equipment used at some special tests, some items of test equipment and ancillaries can be provided with an identifier or number in the equipment list below (Lab/Item).

Each block diagram listed can contain several test setup configurations. All devices belonging to a test setup are identified with the same letter syntax. For example: Column Setup and all devices with an A.

Agenda: Kind of Calibration

k	calibration / calibrated	EK	limited calibration
ne	not required (k, ev, izw, zw not required)	zw	cyclical maintenance (external cyclical maintenance)
ev	periodic self verification	izw	internal cyclical maintenance
Ve	long-term stability recognized	g	blocked for accredited testing
vlk!	Attention: extended calibration interval		
NK!	Attention: not calibrated	*)	next calibration ordered / currently in progress

7.1 Shielded fully anechoic chamber

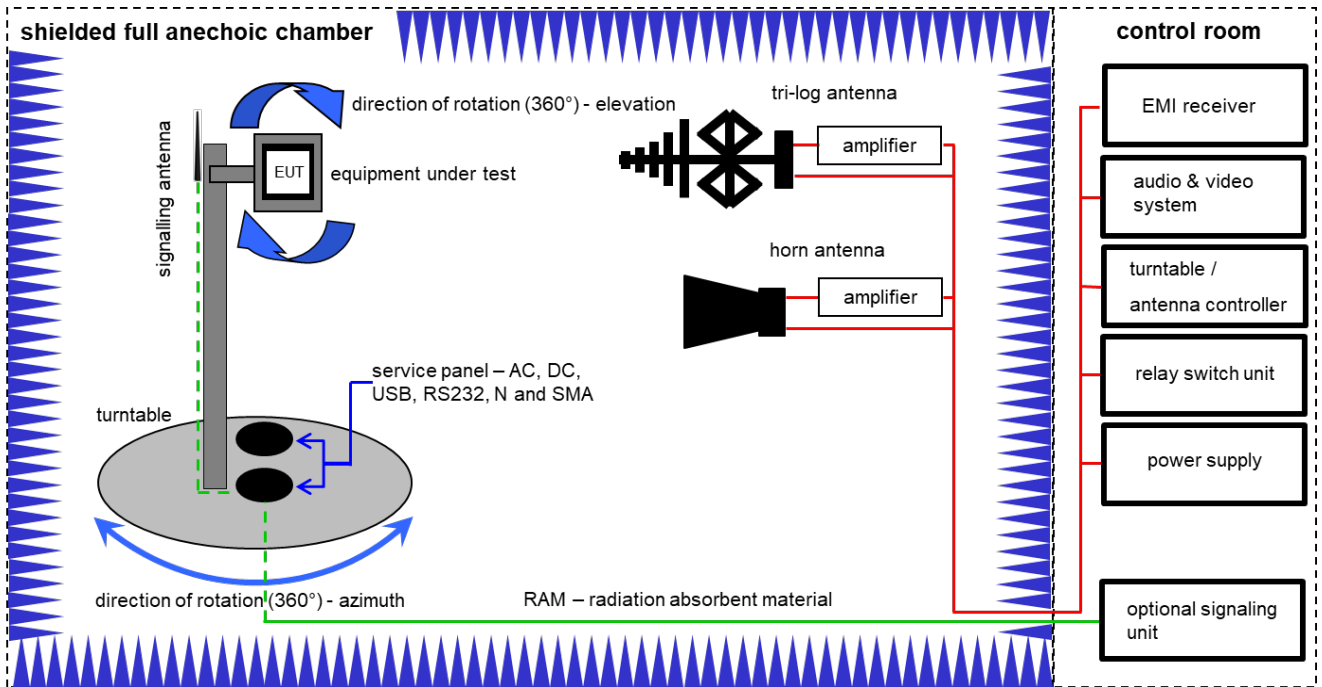

Measurement distance: tri-log antenna and horn antenna 3 meter

$$OP = AV + D - G + CA$$

(OP-radiated output power; AV-analyzer value; D-free field attenuation of measurement distance; G-antenna gain+amplifier gain; CA-loss signal path)

Example calculation:

$$OP [dBm] = -65.0 [dBm] + 50 [dB] - 20 [dBi] + 5 [dB] = -30 [dBm] (1 \mu W)$$

No.	Setup	Equipment	Type	Manufacturer	Serial No.	INV. No.	Kind of Calibration	Last Calibration	Next Calibration
1	A, B	Anechoic chamber	FAC 3/5m	MWB / TDK	87400/02	300000996	ev	-/-	-/-
2	A, B	Switch / Control Unit	3488A	HP	*	300000199	ne	-/-	-/-
3	B	Double-Ridged Waveguide Horn Antenna 1-18.0GHz	3115	EMCO	8812-3089	300000307	vKI!	11.02.2022	29.02.2024
4	A, B	EMI Test Receiver 20Hz- 26,5GHz	ESU26	R&S	100037	300003555	k	09.12.2021	31.12.2022
5	B	Highpass Filter	WHK1.1/15G-10SS	Wainwright	3	300003255	ev	-/-	-/-
6	A	TRILOG Broadband Test-Antenna 30 MHz - 3 GHz	VULB9163	Schwarzbeck Mess - Elektronik	318	300003696	vKI!	30.09.2021	29.09.2023
7	B	Broadband Amplifier 0.5-18 GHz	CBLU5184540	CERNEX	22049	300004481	ev	-/-	-/-
8	A, B	4U RF Switch Platform	L4491A	Agilent Technologies	MY50000037	300004509	ne	-/-	-/-
9	A, B	PC	ExOne	F+W		300004703	ne	-/-	-/-

7.2 Conducted measurements normal and extreme conditions

Conducted measurements normal & extreme conditions

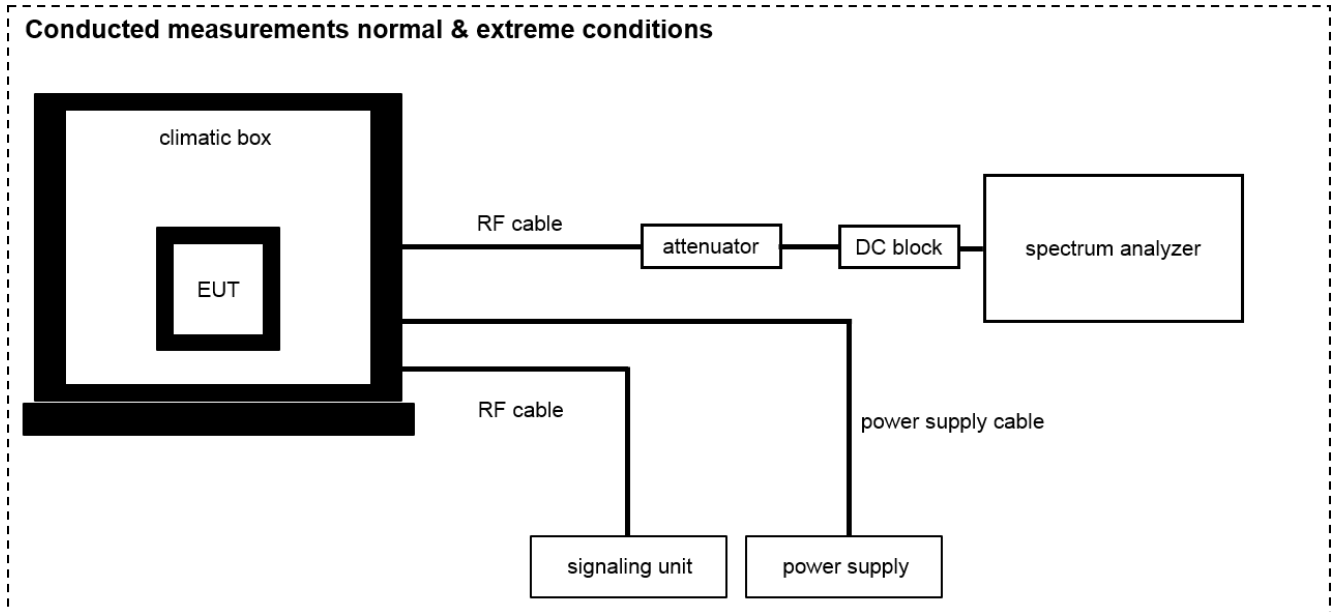

$OP = AV + CA$
(OP-output power; AV-analyzer value; CA-loss signal path)

Example calculation:

$OP [dBm] = 6.0 [dBm] + 11.7 [dB] = 17.7 [dBm] (58.88 \text{ mW})$

Equipment table:

No.	Setup	Equipment	Type	Manufacturer	Serial No.	INV. No.	Kind of Calibration	Last Calibration	Next Calibration
1	B	Temperature Test Chamber	VT 4002	Heraeus Voetsch	521/83761	300002326	ev	12.05.2020	11.05.2022
2	A	Signal analyzer	FSW26	Rohde&Schwarz	101455	300004528	k	14.12.2021	31.12.2022
3	A	Power Supply	HMP2020	Rohde & Schwarz	102219	300006192	k	08.04.2021	07.04.2023

8 Sequence of testing

8.1 Sequence of testing radiated spurious 30 MHz to 12.75 GHz

Setup

- The equipment is set up to simulate normal operation mode as described in the user manual or defined by the manufacturer.
- If the EUT is a tabletop system, a 2-axis positioner with 1.5 m height is used.
- If the EUT is a floor standing device, it is placed directly on the turn table.
- Auxiliary equipment and cables are positioned to simulate normal operation conditions as described in ANSI C 63.4.
- The AC power port of the EUT (if available) is connected to a power outlet below the turntable.
- Measurement distance is 3 m (see ANSI C 63.4) – see test details.
- EUT is set into operation.

Premeasurement

- The turntable rotates from 0° to 315° using 45° steps.
- The antenna is polarized vertical and horizontal.
- The antenna height is 1.5 m.
- At each turntable position and antenna polarization the analyzer sweeps with positive peak detector to find the maximum of all emissions.

Final measurement

- The final measurement is performed for at least six highest peaks according to the requirements of the ANSI C63.4.
- Based on antenna and turntable positions at which the peak values are measured the software maximizes the peaks by rotating the turntable from 0° to 360°. This measurement is repeated for different EUT-table positions (0° to 150° in 30°-steps) and for both antenna polarizations.
- The final measurement is done in the position (turntable, EUT-table and antenna polarization) causing the highest emissions with Peak and RMS detector (as described in ANSI C 63.4).
- Final levels, frequency, measuring time, bandwidth, turntable position, EUT-table position, antenna polarization, correction factor, margin to the limit and limit are recorded. A plot with the graph of the premeasurement with marked maximum final results and the limit is stored.

9 Measurement uncertainty

Measurement uncertainty	
Test case	Uncertainty
Transmitter output power	± 3 dB
Occupied bandwidth	± 3 kHz to 10 kHz (depends on the used RBW)
Transmitter frequency stability	± 1 Hz to 1 kHz (depends on the used RBW)
Transmitter unwanted emissions (radiated or conducted)	Radiated: ± 3 dB Conducted: ± 0.5 dB
Modulation characteristics	-/-
Necessary bandwidth (BN) for analogue systems	± 1 kHz (depends on the used RBW)
Frequency modulation	± 3 kHz (depends on the used RBW)
Spurious emissions conducted below 30 MHz (AC conducted)	± 2.6 dB

10 Summary of measurement results

<input checked="" type="checkbox"/>	No deviations from the technical specifications were ascertained
<input type="checkbox"/>	There were deviations from the technical specifications ascertained
<input type="checkbox"/>	This test report is only a partial test report. The content and verdict of the performed test cases are listed below.

TC Identifier	Description	Verdict	Date	Remark
RF-Testing	FCC Part 74 RSS - 210, Issue 9 RSS-Gen Issue 4	See table!	2022-10-17	-/-

Test specification clause	Test case	Temperature conditions	Voltage conditions	C	NC	NA	NP	Remark
FCC Part 74.861 (e)(1)(ii) FCC Part 2.1046 RSS-210 – G.3.1 RSS-Gen – 6.12	Transmitter output power	Nominal	Nominal	<input checked="" type="checkbox"/>	<input type="checkbox"/>	<input type="checkbox"/>	<input type="checkbox"/>	-/-
FCC Part 74.861 (e)(5) FCC Part 2.1049 RSS-210 – G.3.2 RSS-Gen – 6.6	Occupied bandwidth	Nominal	Nominal	<input checked="" type="checkbox"/>	<input type="checkbox"/>	<input type="checkbox"/>	<input type="checkbox"/>	-/-
FCC Part 74.861 (e)(4) FCC Part 2.1055 RSS-210 – G.3.3 RSS-Gen – 6.11	Transmitter frequency stability	Nominal	Nominal	<input checked="" type="checkbox"/>	<input type="checkbox"/>	<input type="checkbox"/>	<input type="checkbox"/>	-/-
		Extreme	Extreme	<input checked="" type="checkbox"/>	<input type="checkbox"/>	<input type="checkbox"/>	<input type="checkbox"/>	
FCC Part 74.861 (e)(6) FCC Part 74.861 (e)(7) RSS-210 – G.3.4 ETSI EN 300 422-1 v1.4.2 (2011-08)	Transmitter unwanted emissions (radiated or conducted)	Nominal	Nominal	<input checked="" type="checkbox"/>	<input type="checkbox"/>	<input type="checkbox"/>	<input type="checkbox"/>	-/-
FCC Part 2.1047	Modulation characteristics	Nominal	Nominal	-/-				Digital modulation
FCC Part 74.861 (e)(7) ETSI EN 300 422-1 v1.4.2 (2011-08)	Necessary bandwidth (BN) for analogue systems	Nominal	Nominal	<input checked="" type="checkbox"/>	<input type="checkbox"/>	<input type="checkbox"/>	<input type="checkbox"/>	-/-
FCC Part 74.861 (e)(3) RSS-210 – G.3.5.2	Frequency modulation	Nominal	Nominal	<input type="checkbox"/>	<input type="checkbox"/>	<input checked="" type="checkbox"/>	<input type="checkbox"/>	Digital modulation
FCC Part 74.861 (e)(7) RSS-210 – G.3.4	Receiver spurious emissions	Nominal	Nominal	<input type="checkbox"/>	<input type="checkbox"/>	<input checked="" type="checkbox"/>	<input type="checkbox"/>	No receiver integrated!
FCC Part 15.107(a) FCC Part 15.207	Conducted emissions < 30 MHz	Nominal	Nominal	<input type="checkbox"/>	<input type="checkbox"/>	<input checked="" type="checkbox"/>	<input type="checkbox"/>	-/-

Note: C = Compliant; NC = Not compliant; NA = Not applicable; NP = Not performed

11 Additional comments

Reference documents: None

Special test descriptions: None

Configuration descriptions: None

Test mode: No test mode available.
Test signal is applied to the transmitter.

Special software is used.
EUT is transmitting pseudo random data by itself

Antennas and transmit operating modes: **Operating mode 1 (single antenna)**

- *Equipment with 1 antenna,*
- *Equipment with 2 diversity antennas operating in switched diversity mode by which at any moment in time only 1 antenna is used,*
- *Smart antenna system with 2 or more transmit/receive chains, but operating in a mode where only 1 transmit/receive chain is used)*

Operating mode 2 (multiple antennas, no beamforming)

- *Equipment operating in this mode contains a smart antenna system using two or more transmit/receive chains simultaneously but without beamforming.*

Operating mode 3 (multiple antennas, with beamforming)

- *Equipment operating in this mode contains a smart antenna system using two or more transmit/receive chains simultaneously with beamforming. In addition to the antenna assembly gain (G), the beamforming gain (Y) may have to be taken into account when performing the measurements.*

12 Measurement results

12.1 Transmitter output power

Measurement:

Measurement parameter	
Detector:	Peak (worst case) / Average (RMS)
Sweep time:	Auto / 20s
Resolution bandwidth:	> emission bandwidth
Video bandwidth:	> resolution bandwidth
Span:	> 2 times emissions bandwidth
Trace mode:	Max. hold
EUT configuration:	Peak: Unmodulated carrier RMS: Modulate the transmitter with a 2.5 kHz tone at a level 16 dB higher than that required to produce a frequency deviation of ± 75 kHz, or to produce 50% of the manufacturer's rated deviation, whichever is less.
Test setup:	See sub clause 7.2 – A
Measurement uncertainty:	See sub clause 9

Limits:

FCC (conducted)	
941.500 MHz – 944.000 MHz 944.000 MHz – 952.000 MHz 952.850 MHz – 956.250 MHz 956.450 MHz – 959.850 MHz	1 W (average) / 30 dBm (average)
IC (conducted)	
941.500 MHz – 952.000 MHz 953.000 MHz – 959.850 MHz	1 W (average) / 30 dBm (average)

Result normal mode:

Transmitter output power conducted / dBm							
Frequencies / MHz	941.7	946.75	951.8	953.05	956.05	956.65	959.65
Peak	13.71	13.70	13.59	13.63	13.56	13.62	13.61
Average	9.96	9.89	9.83	9.81	9.93	9.89	9.84

Result LD mode:

Transmitter output power conducted / dBm							
Frequencies / MHz	941.7	946.75	951.8	953.05	956.05	956.65	959.65
Peak	13.73	13.64	13.64	13.60	13.69	13.64	13.65
Average	9.94	9.89	9.84	9.83	9.91	9.90	9.87

Plots output power conducted, normal mode:

Plot 1: 941.7 MHz

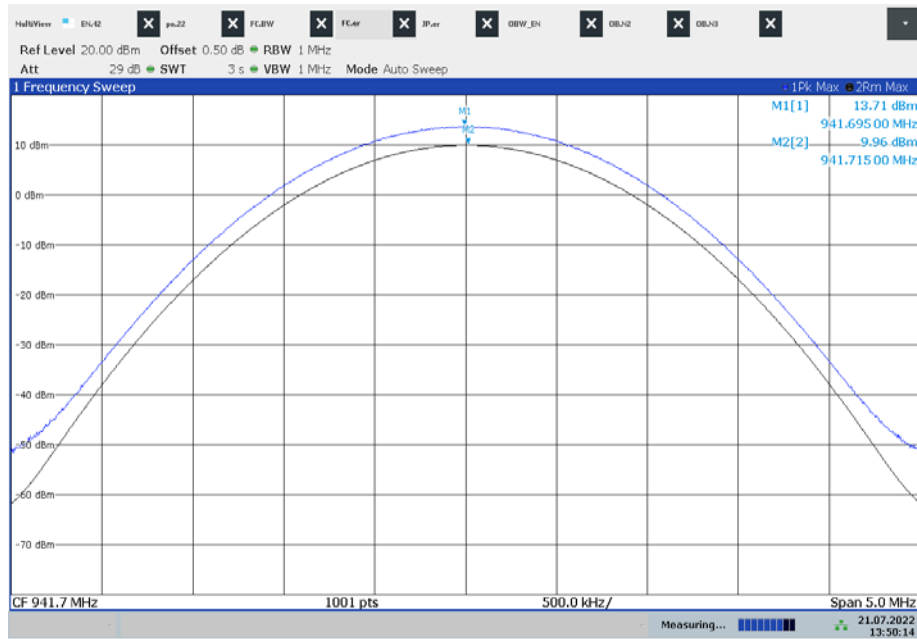

13:50:14 21.07.2022

Plot 2: 946.75 MHz

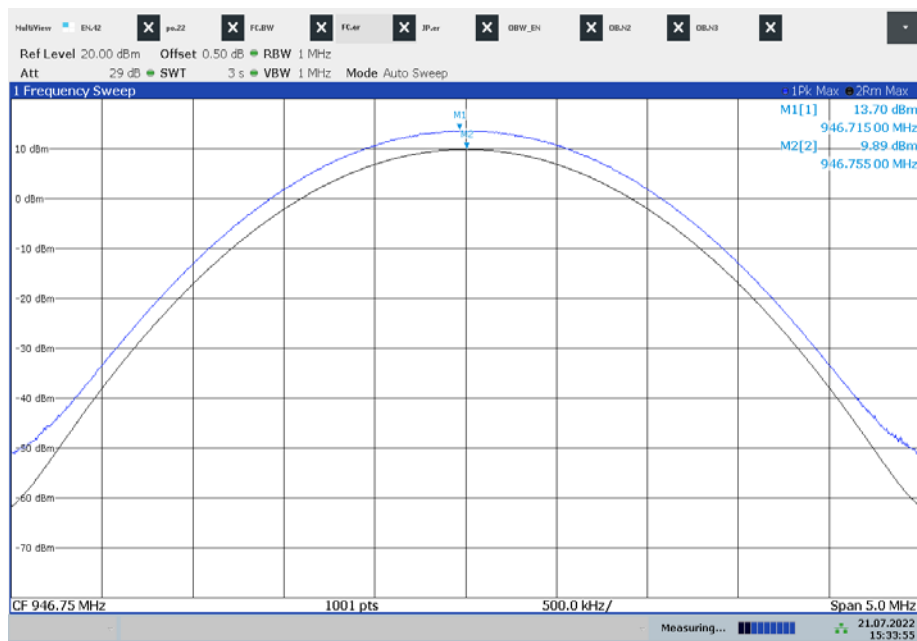

15:33:55 21.07.2022

Plot 3: 951.8 MHz

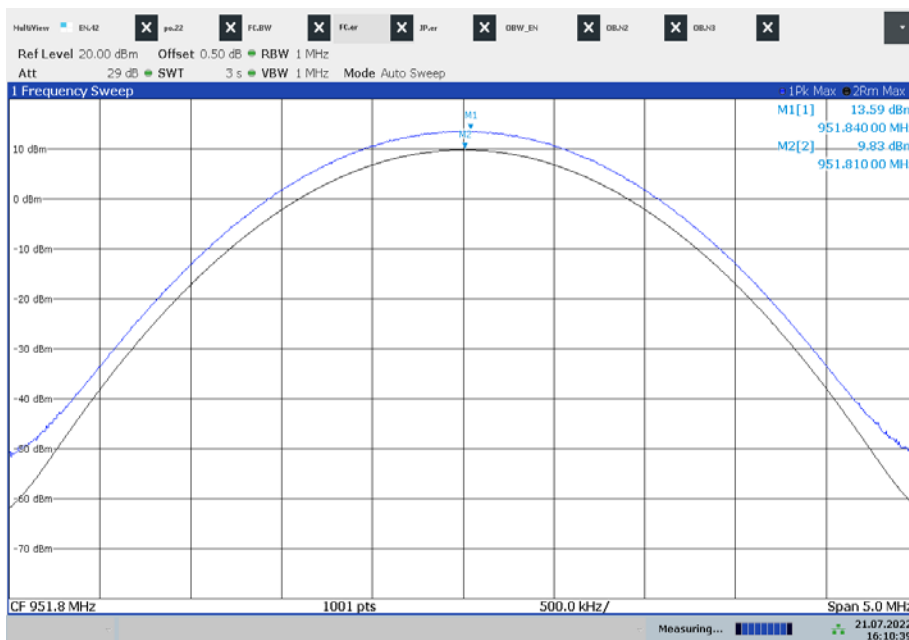

16:10:40 21.07.2022

Plot 4: 953.05 MHz

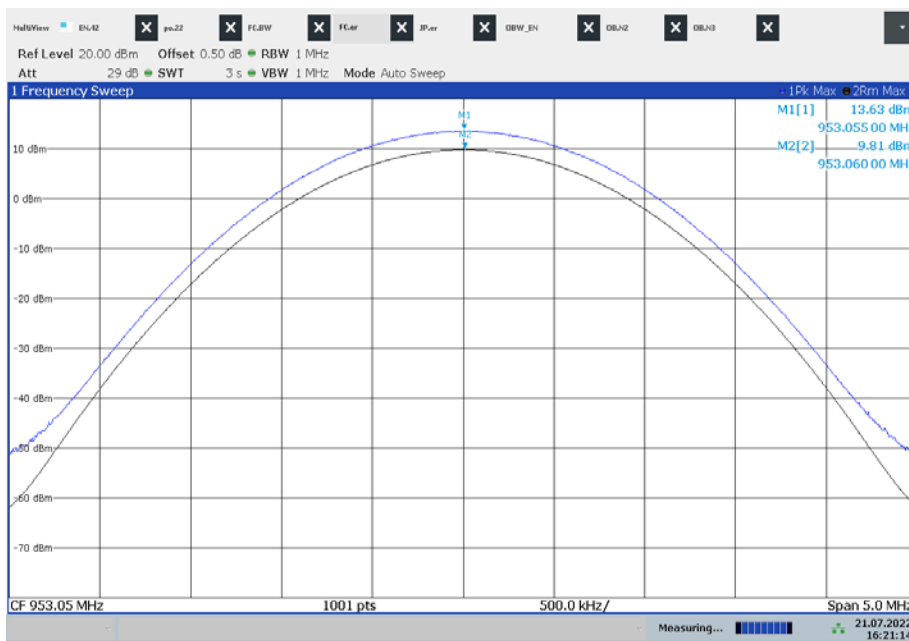

16:21:14 21.07.2022

Plot 5: 956.05 MHz

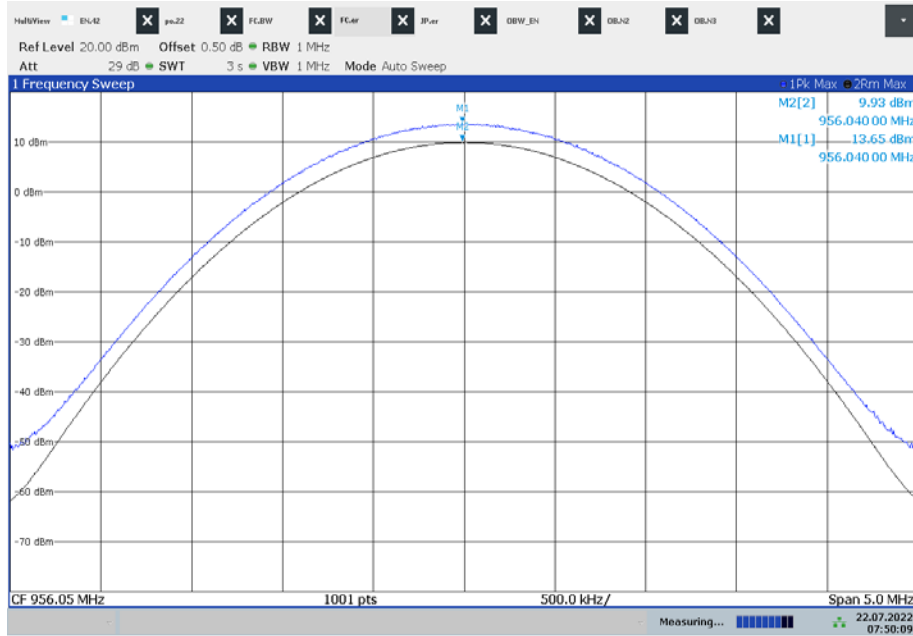

07:50:09 22.07.2022

Plot 6: 956.65 MHz

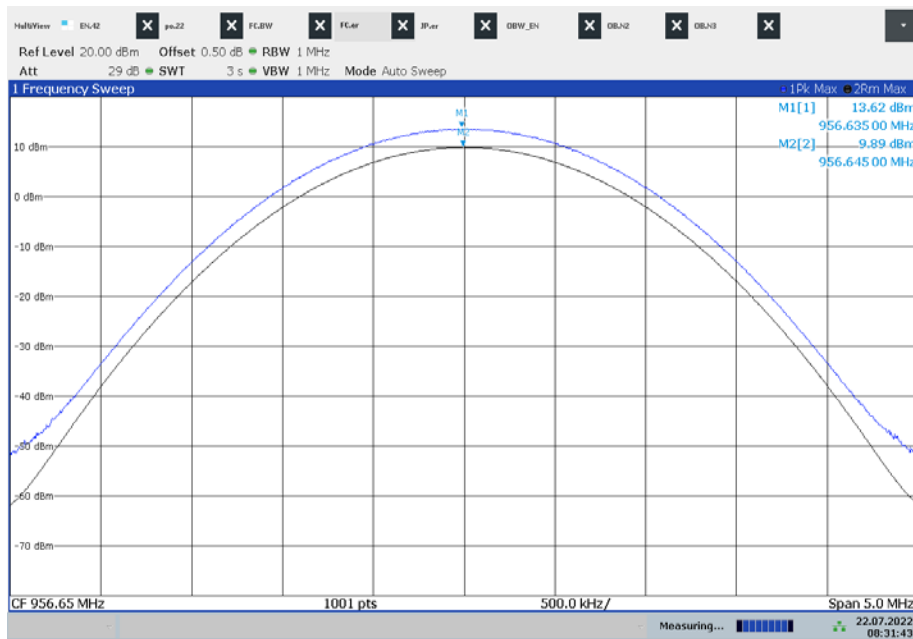

08:31:44 22.07.2022

Plot 7: 959.65 MHz

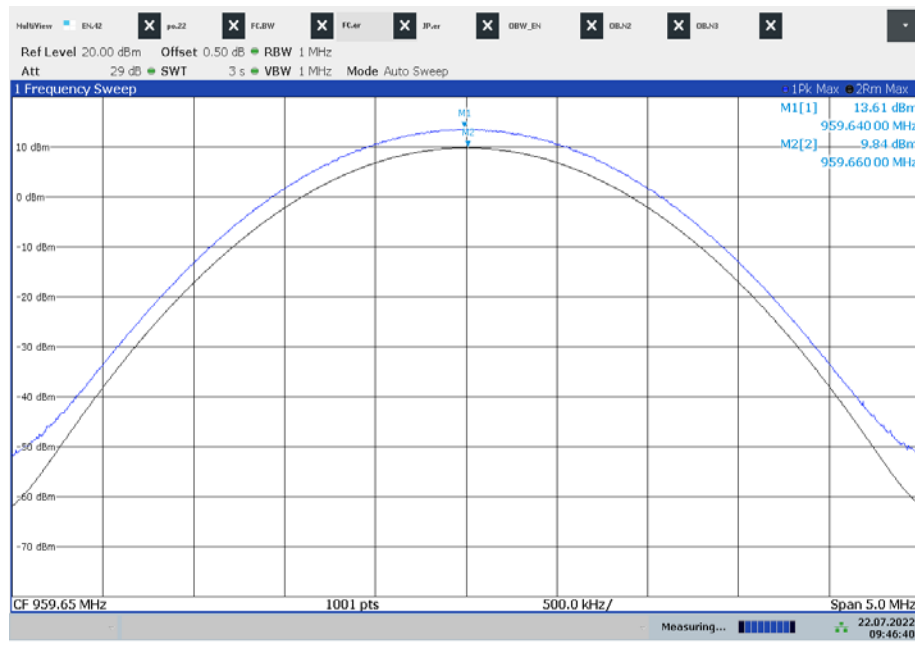

09:46:41 22.07.2022

Plots output power conducted, LD mode:

Plot 1: 941.7 MHz

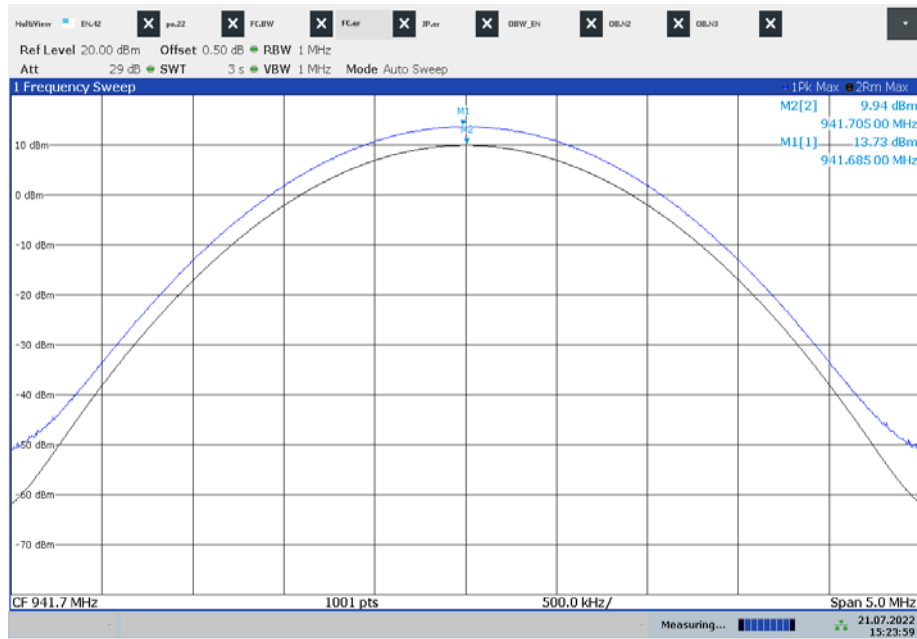

15:23:59 21.07.2022

Plot 2: 946.75 MHz

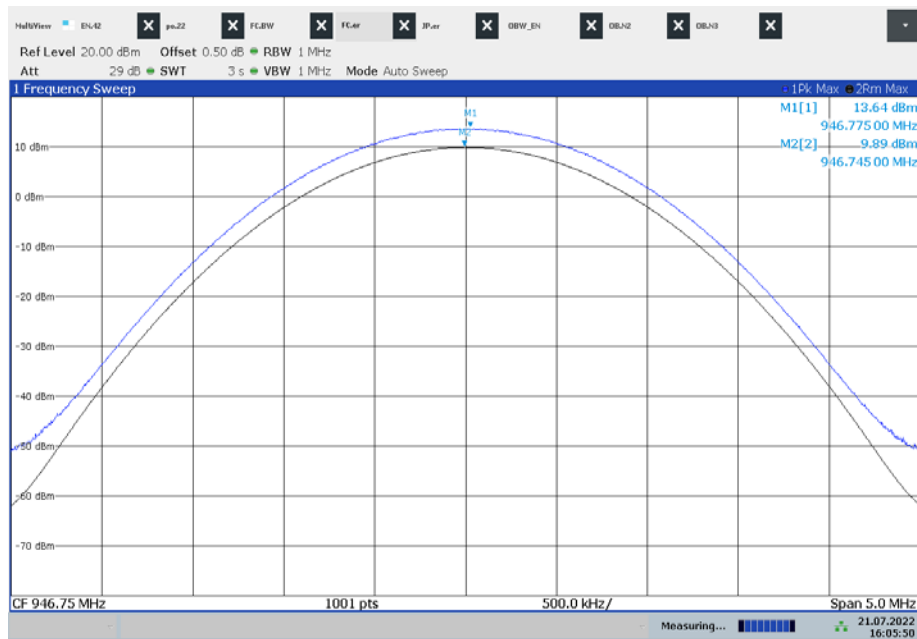

16:05:51 21.07.2022

Plot 3: 951.8 MHz

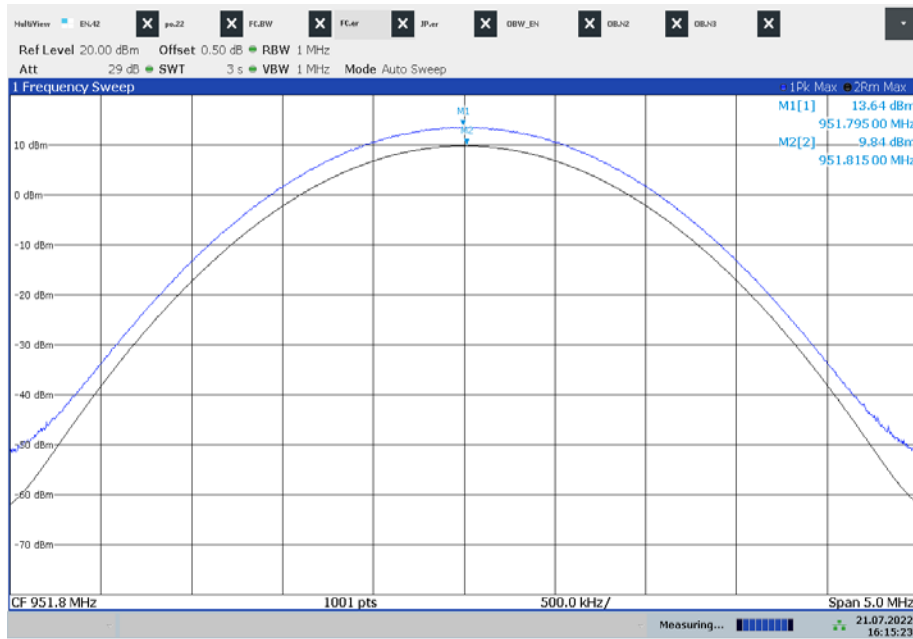

16:15:24 21.07.2022

Plot 4: 953.05 MHz

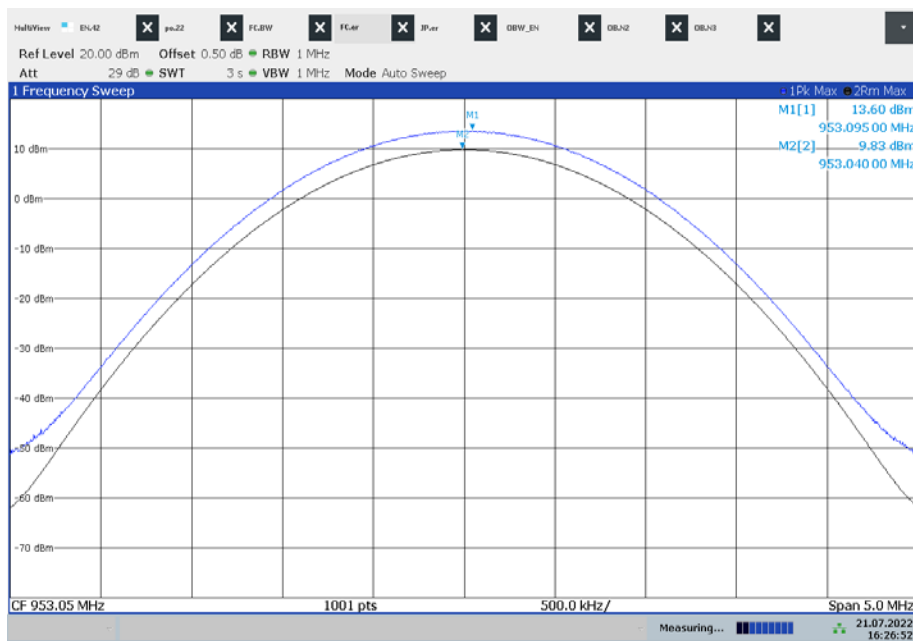

16:26:52 21.07.2022

Plot 5: 956.05 MHz

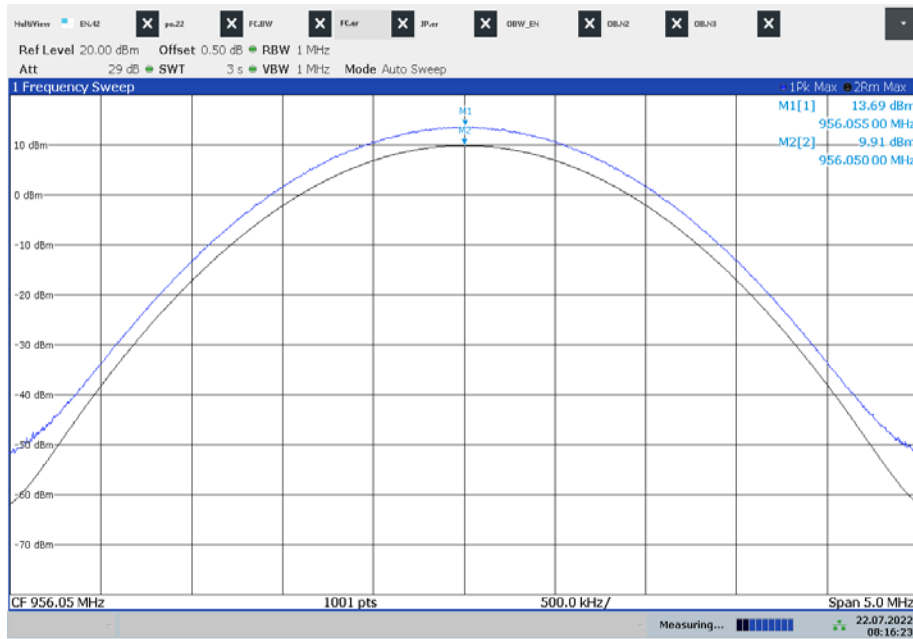

Plot 6: 956.65 MHz

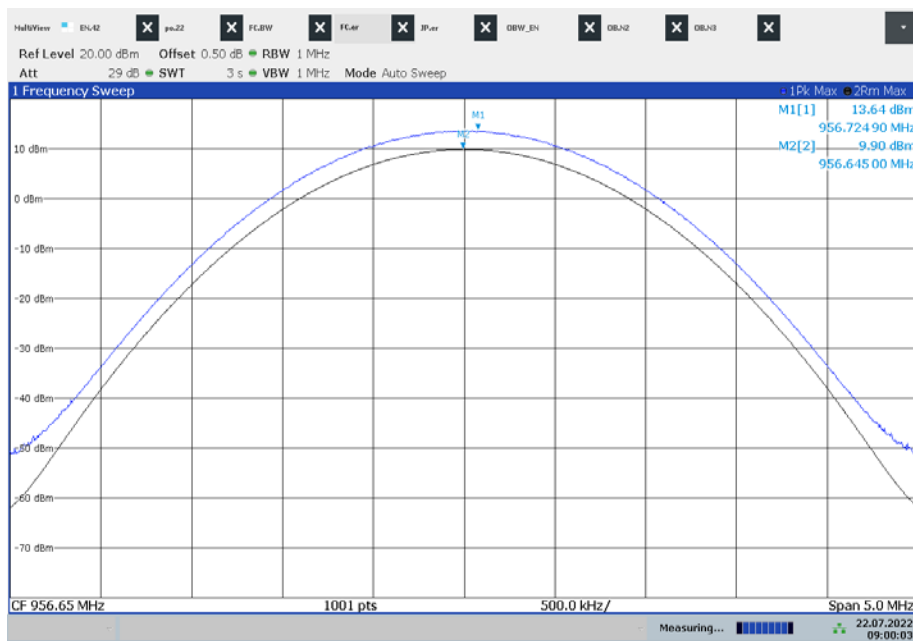

Plot 7: 959.65 MHz

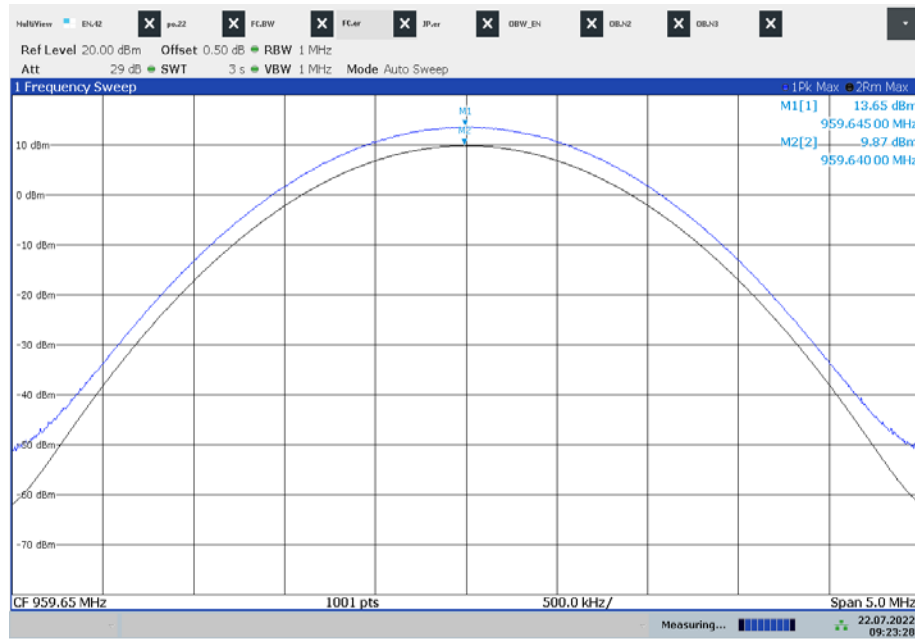

12.2 Occupied bandwidth

Measurement:

Measurement parameter	
Detector:	Peak
Sweep time:	Auto
Resolution bandwidth:	1 % to 5 % of the occupied bandwidth
Video bandwidth:	3 x resolution bandwidth
Span:	2 x emission bandwidth
Trace mode:	Max. hold
Analyzer function:	99% power occupied bandwidth function
EUT:	Modulated signal with max. frequency deviation
Test setup:	See sub clause 7.2 - A
Measurement uncertainty:	See sub clause 9

Limits:

FCC & IC	
941.500 MHz – 952.000 MHz 953.000 MHz – 959.850 MHz	200 kHz

Result:

Normal mode	
Centre frequency (fc)	OBW
941.700 MHz	171.218 kHz
946.750 MHz	170.623 kHz
951.800 MHz	170.463 kHz
953.050 MHz	170.930 kHz
956.050 MHz	170.644 kHz
956.650 MHz	170.047 kHz
959.650 MHz	171.309 kHz

LD-mode	
Centre frequency (fc)	OBW
941.700 MHz	141.940 kHz
946.750 MHz	142.463 kHz
951.800 MHz	143.161 kHz
953.050 MHz	142.338 kHz
956.050 MHz	142.598 kHz
956.650 MHz	142.482 kHz
959.650 MHz	141.407 kHz

Plots normal mode:

Plot 1: 941.7 MHz

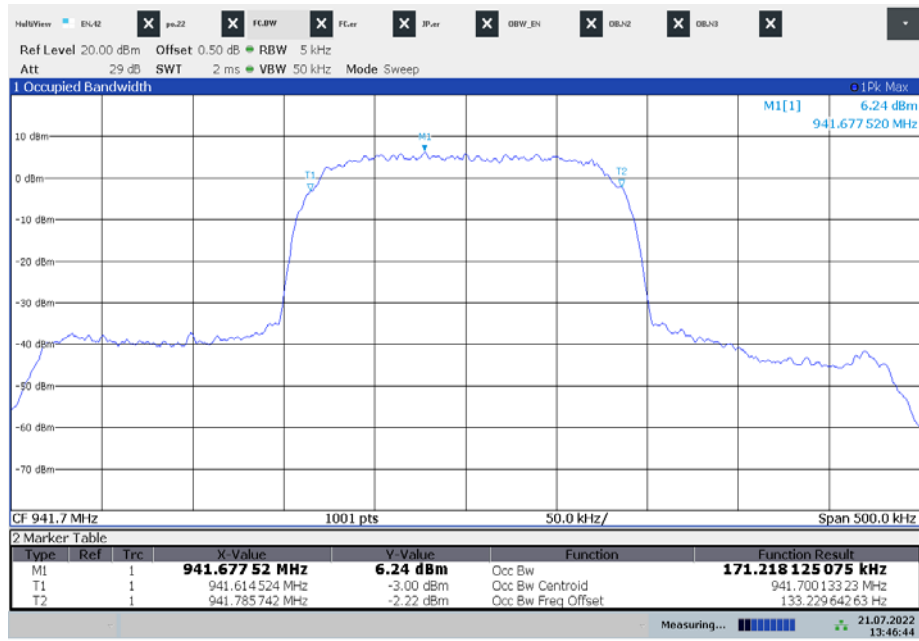

13:46:45 21.07.2022

Plot 2: 946.75 MHz

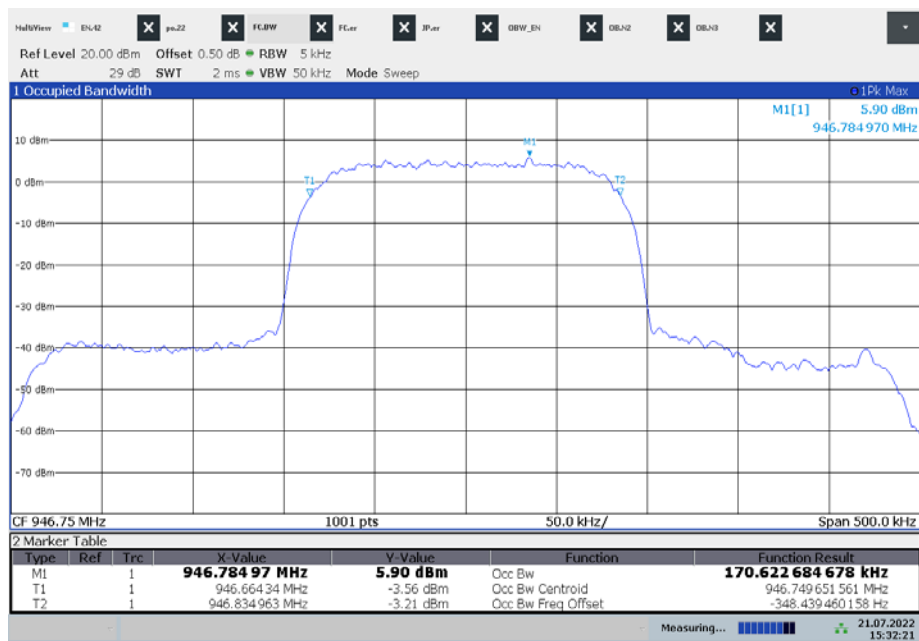

15:32:22 21.07.2022

Plot 3: 951.8 MHz

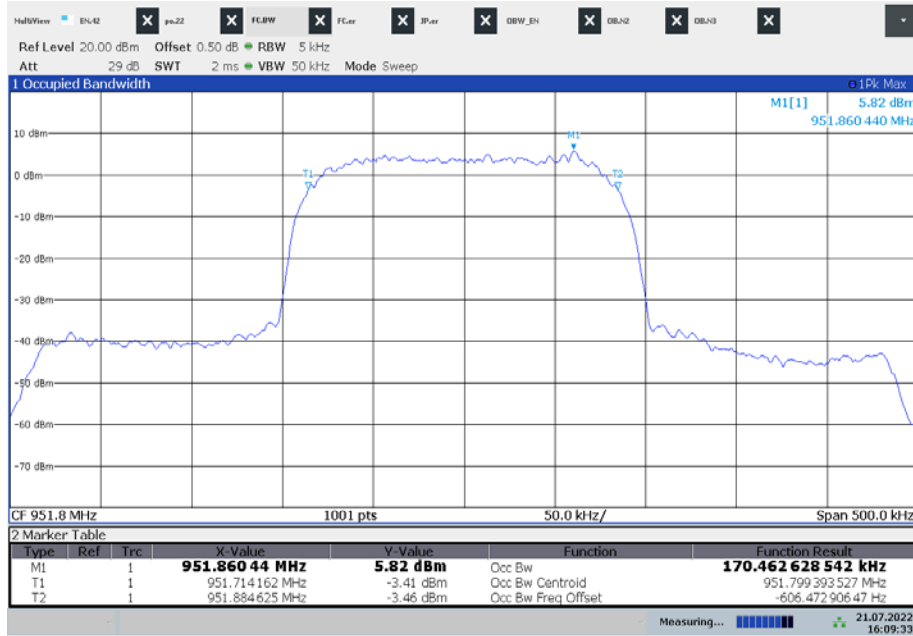

16:09:34 21.07.2022

Plot 4: 953.05 MHz

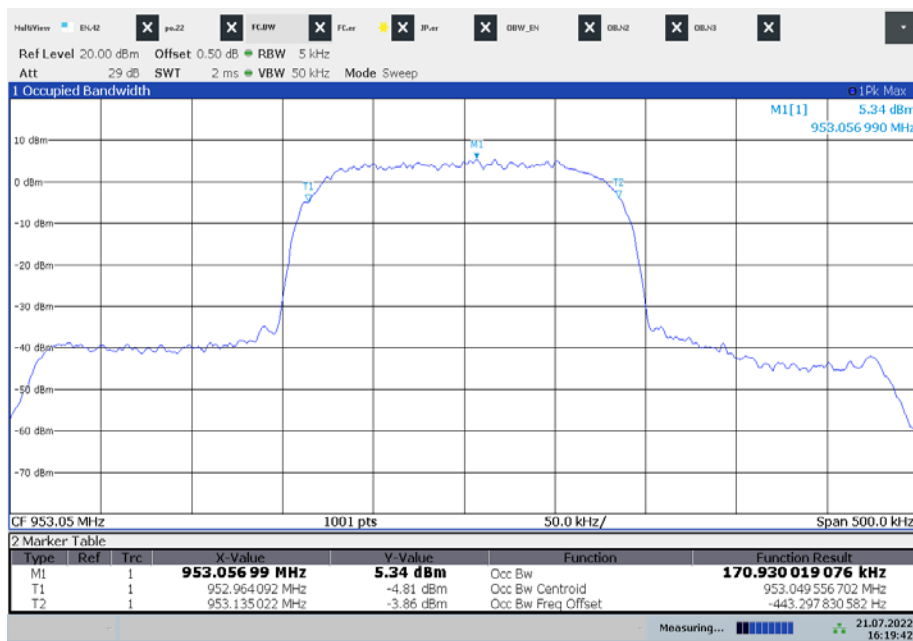

16:19:42 21.07.2022

Plot 5: 956.05 MHz

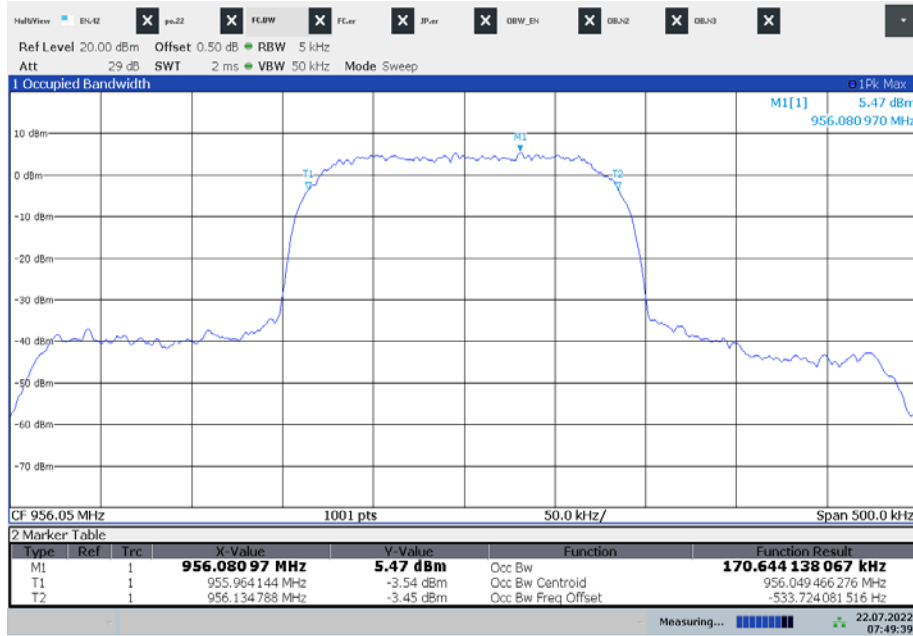

07:49:40 22.07.2022

Plot 6: 956.65 MHz

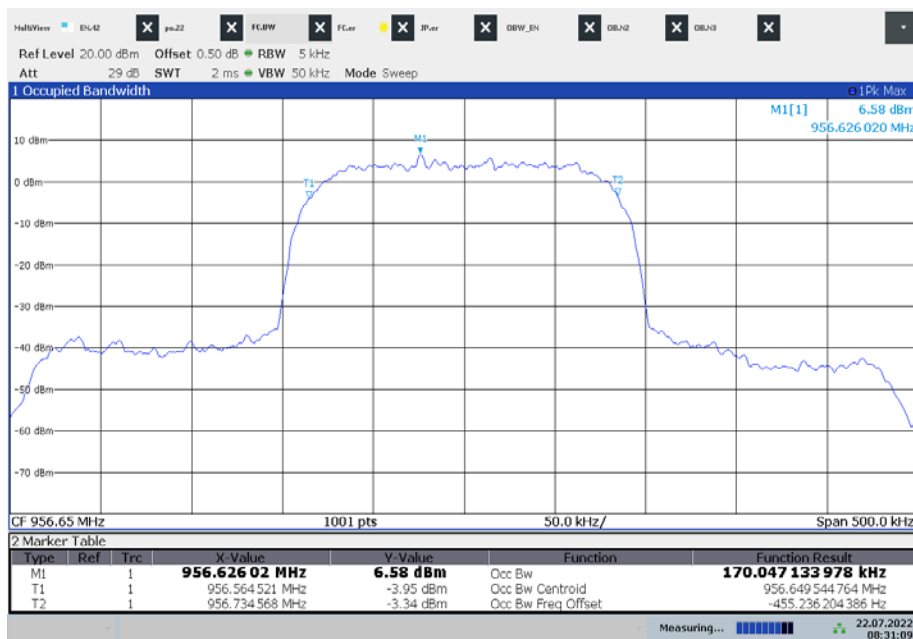

08:31:09 22.07.2022

Plot 7: 959.65 MHz

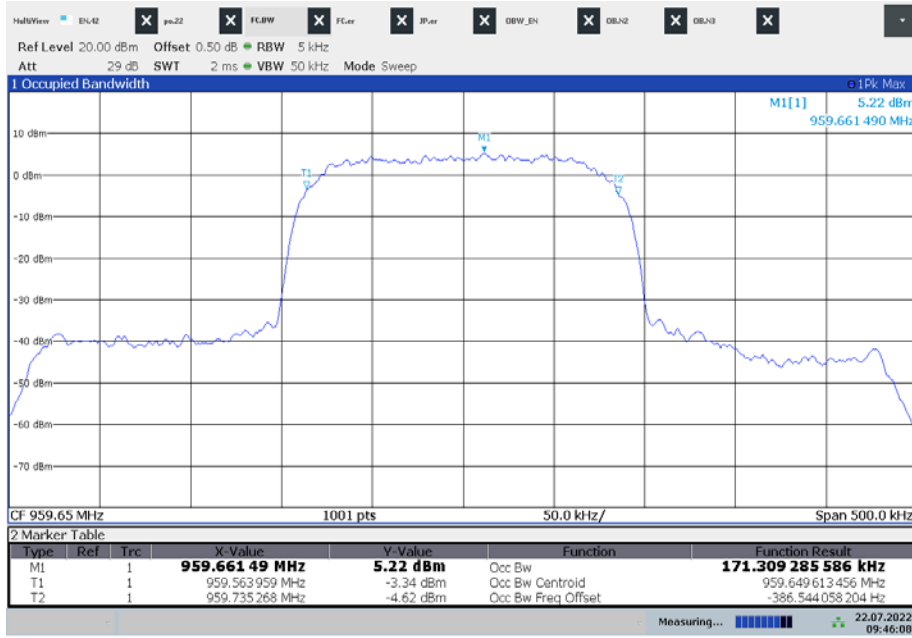

09:46:08 22.07.2022

Plots LD mode:

Plot 1: 941.7 MHz

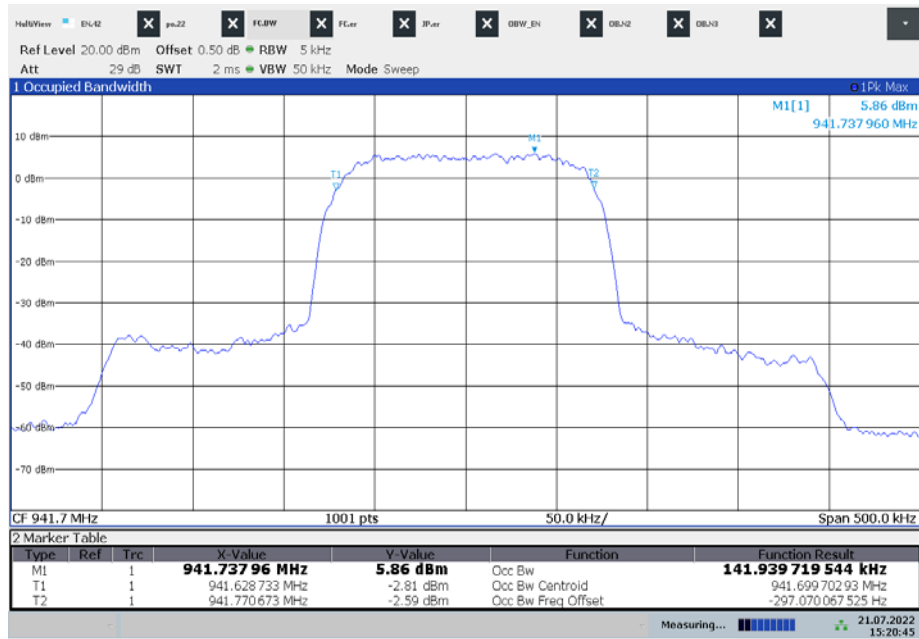

15:20:46 21.07.2022

Plot 2: 946.75 MHz



16:04:04 21.07.2022

Plot 3: 951.8 MHz

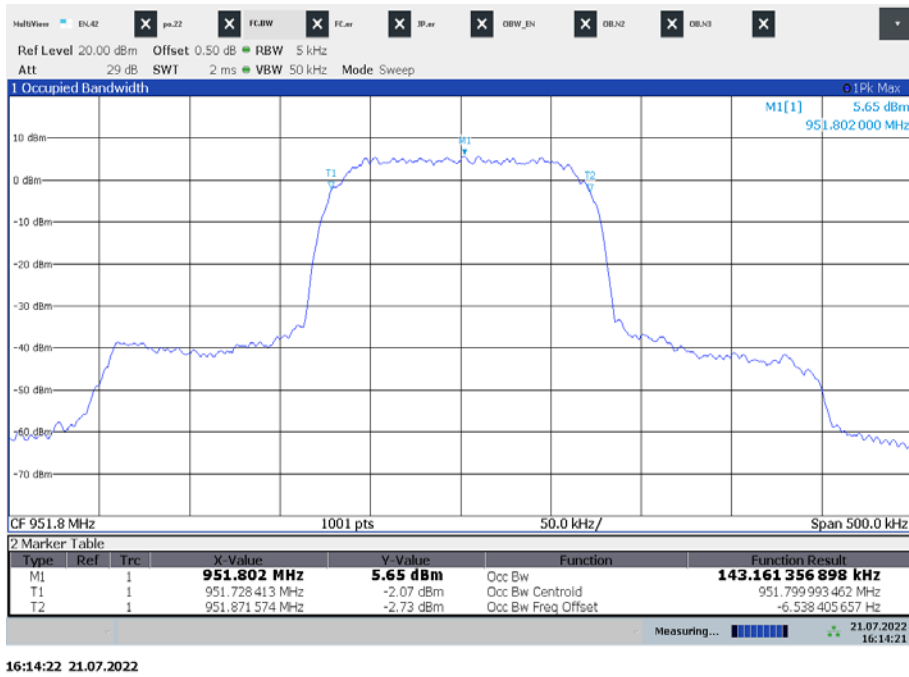

Plot 4: 953.05 MHz

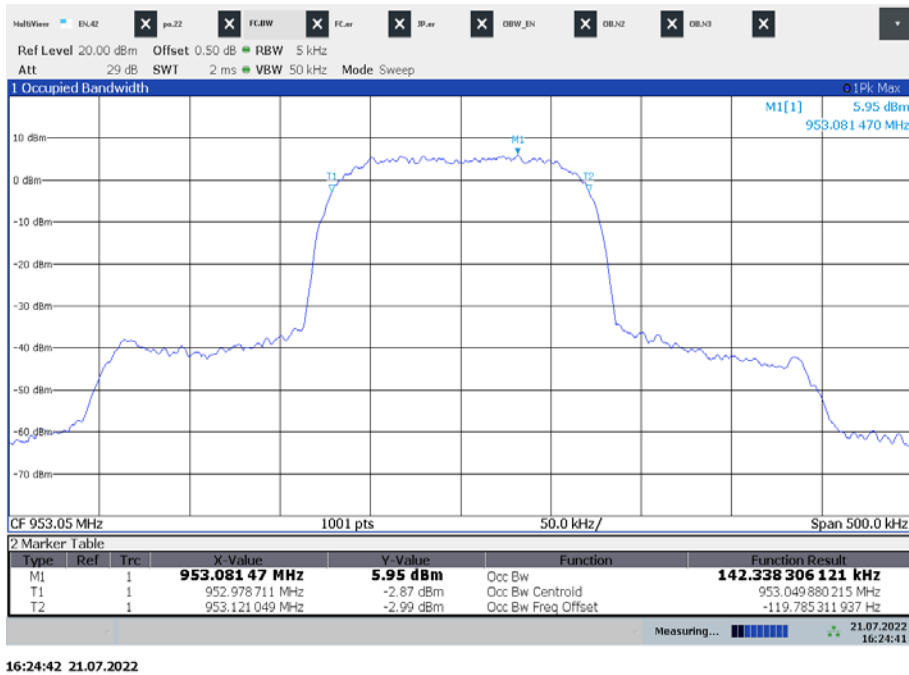

Plot 5: 956.05 MHz

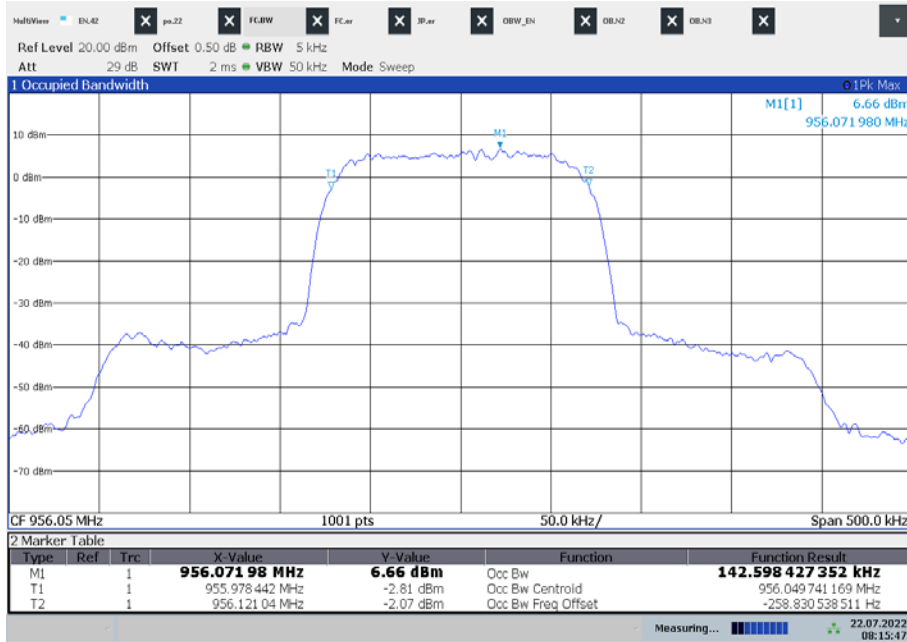

08:15:48 22.07.2022

Plot 6: 956.65 MHz

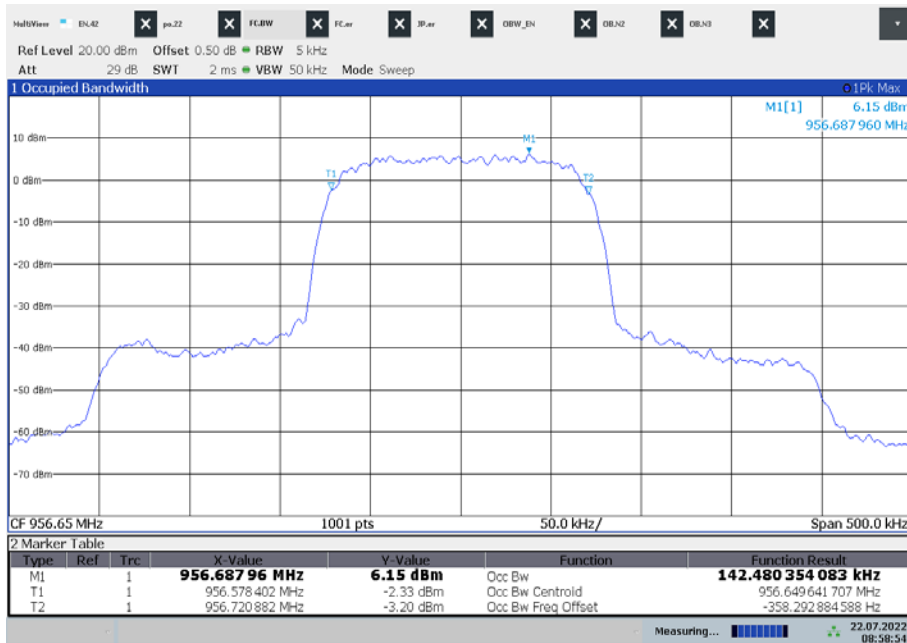

08:58:54 22.07.2022

Plot 7: 959.65 MHz

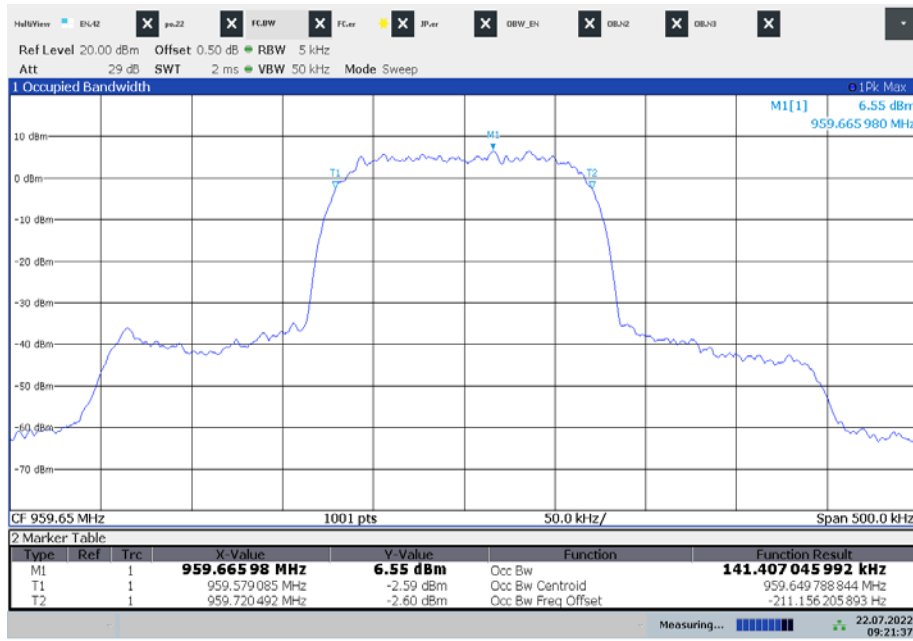

09:21:37 22.07.2022

12.3 Transmitter frequency stability

Measurement:

Measurement parameter	
Detector:	Peak
Sweep time:	Auto
Resolution bandwidth:	1 Hz / 10 Hz / 100 Hz
Video bandwidth:	3 x resolution bandwidth
Span:	wide enough to follow the frequency drift
Trace mode:	clear/write/view
EUT:	CW signal or MC with measurement method description
Test setup:	See sub clause 7.2 - B
Measurement uncertainty:	See sub clause 9

Limits:

FCC	
941.500 MHz – 944.000 MHz	± 50 ppm
944.000 MHz – 952.000 MHz	
952.850 MHz – 956.250 MHz	
956.450 MHz – 959.850 MHz	
IC	
941.500 MHz – 952.000 MHz	± 20 ppm
953.000 MHz – 959.850 MHz	

Results: 941.700 MHz

Temperature / Voltage	Frequency (MHz)	Deviation (kHz / ppm)
-30 °C / V _{nom}	941.699853	-0.147 / 0.156
-20 °C / V _{nom}	941.699978	-0.022 / 0.023
-10 °C / V _{nom}	941.700253	0.253 / 0.269
0 °C / V _{nom}	941.700596	0.596 / 0.633
+10 °C / V _{nom}	941.700442	0.442 / 0.470
+20 °C / V _{nom}	941.700509	0.509 / 0.540
+30 °C / V _{nom}	941.700414	0.414 / 0.439
+40 °C / V _{nom}	941.700434	0.434 / 0.461
+50 °C / V _{nom}	941.700483	0.483 / 0.513
+20 °C / V _{nom} - 15%	941.700514	0.514 / 0.546
+20 °C / V _{nom}	941.700509	0.509 / 0.540
+20 °C / V _{nom} + 15%	941.700503	0.503 / 0.534

Results: 946.750 MHz

Temperature / Voltage	Frequency (MHz)	Deviation (kHz / ppm)
-30 °C / V _{nom}	946.750098	0.098 / 0.103
-20 °C / V _{nom}	946.750049	0.049 / 0.052
-10 °C / V _{nom}	946.750328	0.328 / 0.346
0 °C / V _{nom}	946.750578	0.578 / 0.611
+10 °C / V _{nom}	946.750544	0.544 / 0.574
+20 °C / V _{nom}	946.750517	0.517 / 0.546
+30 °C / V _{nom}	946.750431	0.431 / 0.455
+40 °C / V _{nom}	946.750435	0.435 / 0.459
+50 °C / V _{nom}	946.750541	0.541 / 0.571
+20 °C / V _{nom} - 15%	946.750491	0.491 / 0.519
+20 °C / V _{nom}	946.750517	0.517 / 0.546
+20 °C / V _{nom} + 15%	946.750484	0.484 / 0.511

Results: 951.800 MHz

Temperature / Voltage	Frequency (MHz)	Deviation (kHz / ppm)
-30 °C / V _{nom}	951.800088	0.088 / 0.092
-20 °C / V _{nom}	951.799957	-0.043 / 0.046
-10 °C / V _{nom}	951.800353	0.353 / 0.370
0 °C / V _{nom}	951.800452	0.452 / 0.474
+10 °C / V _{nom}	951.800479	0.479 / 0.503
+20 °C / V _{nom}	951.800457	0.457 / 0.480
+30 °C / V _{nom}	951.800404	0.404 / 0.425
+40 °C / V _{nom}	951.800445	0.445 / 0.468
+50 °C / V _{nom}	951.800471	0.471 / 0.494
+20 °C / V _{nom} - 15%	951.800550	0.550 / 0.578
+20 °C / V _{nom}	951.800457	0.457 / 0.480
+20 °C / V _{nom} + 15%	951.800492	0.492 / 0.517

Results: 953.050 MHz

Temperature / Voltage	Frequency (MHz)	Deviation (kHz / ppm)
-30 °C / V _{nom}	953.050101	0.101 / 0.106
-20 °C / V _{nom}	953.050002	0.002 / 0.002
-10 °C / V _{nom}	953.050329	0.329 / 0.345
0 °C / V _{nom}	953.050533	0.533 / 0.560
+10 °C / V _{nom}	953.050542	0.542 / 0.569
+20 °C / V _{nom}	953.050507	0.507 / 0.532
+30 °C / V _{nom}	953.050448	0.448 / 0.470
+40 °C / V _{nom}	953.050449	0.449 / 0.472
+50 °C / V _{nom}	953.050533	0.533 / 0.559
+20 °C / V _{nom} - 15%	953.050453	0.453 / 0.475
+20 °C / V _{nom}	953.050507	0.507 / 0.532
+20 °C / V _{nom} + 15%	953.050393	0.393 / 0.413

Results: 956.050 MHz

Temperature / Voltage	Frequency (MHz)	Deviation (kHz / ppm)
-30 °C / V _{nom}	956.050076	0.076 / 0.079
-20 °C / V _{nom}	956.049954	-0.046 / 0.048
-10 °C / V _{nom}	956.050322	0.322 / 0.337
0 °C / V _{nom}	956.050503	0.503 / 0.526
+10 °C / V _{nom}	956.050580	0.580 / 0.606
+20 °C / V _{nom}	956.050453	0.453 / 0.474
+30 °C / V _{nom}	956.050358	0.358 / 0.375
+40 °C / V _{nom}	956.050441	0.441 / 0.461
+50 °C / V _{nom}	956.050416	0.416 / 0.435
+20 °C / V _{nom} - 15%	956.050399	0.399 / 0.418
+20 °C / V _{nom}	956.050453	0.453 / 0.474
+20 °C / V _{nom} + 15%	956.050504	0.504 / 0.528

Results: 956.650 MHz

Temperature / Voltage	Frequency (MHz)	Deviation (kHz / ppm)
-30 °C / V _{nom}	956.650069	0.069 / 0.072
-20 °C / V _{nom}	956.649994	-0.006 / 0.006
-10 °C / V _{nom}	956.650399	0.399 / 0.417
0 °C / V _{nom}	956.650499	0.499 / 0.521
+10 °C / V _{nom}	956.650548	0.548 / 0.573
+20 °C / V _{nom}	956.650577	0.577 / 0.603
+30 °C / V _{nom}	956.650442	0.442 / 0.462
+40 °C / V _{nom}	956.650445	0.445 / 0.466
+50 °C / V _{nom}	956.650409	0.409 / 0.428
+20 °C / V _{nom} - 15%	956.650455	0.455 / 0.475
+20 °C / V _{nom}	956.650577	0.577 / 0.603
+20 °C / V _{nom} + 15%	956.650565	0.565 / 0.590

Results: 959.650 MHz

Temperature / Voltage	Frequency (MHz)	Deviation (kHz / ppm)
-30 °C / V _{nom}	959.649784	-0.216 / 0.225
-20 °C / V _{nom}	959.649892	-0.108 / 0.112
-10 °C / V _{nom}	959.650271	0.271 / 0.282
0 °C / V _{nom}	959.650438	0.438 / 0.456
+10 °C / V _{nom}	959.650479	0.479 / 0.499
+20 °C / V _{nom}	959.650490	0.490 / 0.511
+30 °C / V _{nom}	959.650317	0.317 / 0.331
+40 °C / V _{nom}	959.650456	0.456 / 0.475
+50 °C / V _{nom}	959.650499	0.499 / 0.520
+20 °C / V _{nom} - 15%	959.650229	0.229 / 0.239
+20 °C / V _{nom}	959.650490	0.490 / 0.511
+20 °C / V _{nom} + 15%	959.650259	0.259 / 0.270

12.4 Transmitter unwanted emissions (radiated)

Measurement:

Measurement parameter							
Detector:	Peak (prescan) / RMS						
Sweep time:	Auto						
Resolution bandwidth:	<table border="0"> <tr> <td>25 MHz to 30 MHz</td> <td>9 kHz to 10 kHz</td> </tr> <tr> <td>30 MHz to 1 000 MHz</td> <td>100 kHz</td> </tr> <tr> <td>> 1 000 MHz</td> <td>1 MHz</td> </tr> </table>	25 MHz to 30 MHz	9 kHz to 10 kHz	30 MHz to 1 000 MHz	100 kHz	> 1 000 MHz	1 MHz
25 MHz to 30 MHz	9 kHz to 10 kHz						
30 MHz to 1 000 MHz	100 kHz						
> 1 000 MHz	1 MHz						
Video bandwidth:	3 * RBW						
Span:	100 MHz steps!						
Trace-Mode:	Max. hold						
EUT:	MC with max frequency deviation						
Used equipment:	See chapter 7.1- A / B						
Measurement uncertainty:	See chapter 9						

Limits:

Max. spurious level FCC & IC (according to ETSI EN 300 422-1 v1.4.2 (2011-08))			
State	47 MHz to 74 MHz 87.5 MHz to 118 MHz 174 MHz to 230 MHz 470 MHz to 862 MHz	Other frequencies ≤ 1000 MHz	All frequencies > 1000 MHz
Operating	4.0 nW	250 nW	1.00 µW
Standby	2.0 nW	2.0 nW	20.0 nW
FCC & IC			
The mean power of emissions shall be attenuated below the mean output power of the transmitter in accordance with the following schedule:			
On any frequency removed from the operating frequency by more than 50 percent up to and including 100 percent of the authorized bandwidth: at least			25 dB
On any frequency removed from the operating frequency by more than 100 percent up to and including 250 percent of the authorized bandwidth			35 dB
On any frequency removed from the operating frequency by more than 250 percent of the authorized bandwidth: at least			43 + 10log ₁₀ (mean output power in watts) dB

Results:

normal mode:

carrier frequency	unwanted emission frequency (MHz)	Limit	level (dB) / (dBm) or remark
941.700 MHz	all detected emissions are more than 10 dB below the limit.*		
946.750 MHz			
951.800 MHz			
953.050 MHz			
956.050 MHz			
956.650 MHz			
959.650 MHz			

LD mode:

carrier frequency	unwanted emission frequency (MHz)	Limit	level (dB) / (dBm) or remark
941.700 MHz	all detected emissions are more than 10 dB below the limit.*		
946.750 MHz			
951.800 MHz			
953.050 MHz			
956.050 MHz			
956.650 MHz			
959.650 MHz			

^{*)} peaks @ 800 MHz not caused by EUT.

Plots: radiated

normal mode:

Plot 1: 941.70 MHz, 25 MHz – 12.75 GHz

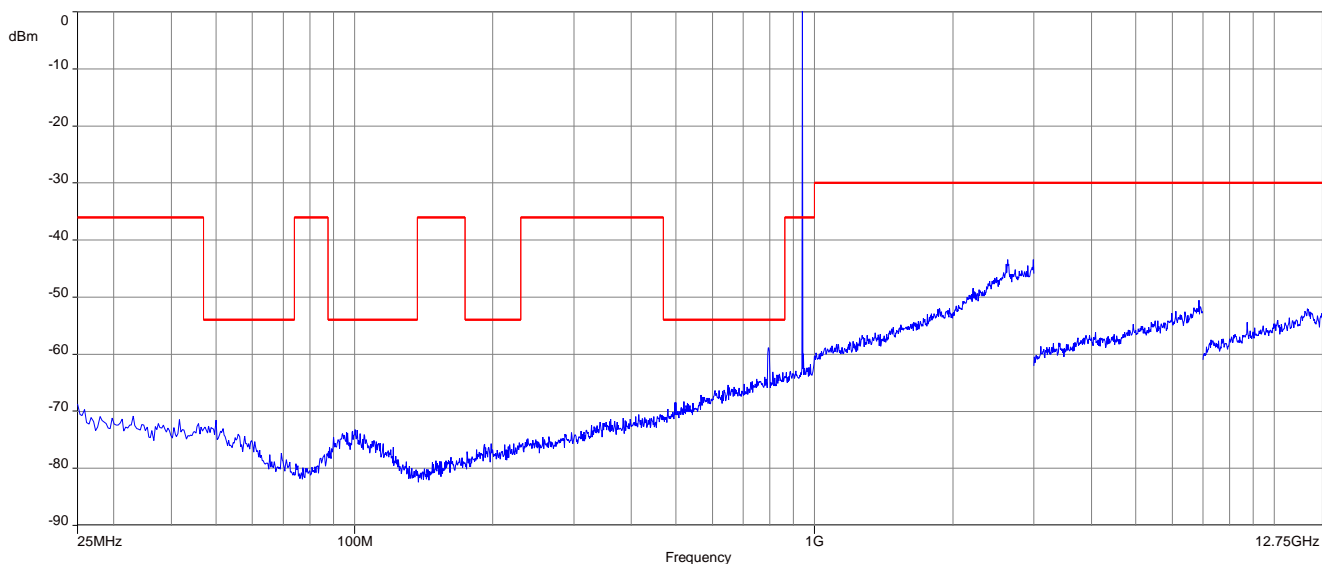

Plot 2: 946.75 MHz, 25 MHz – 12.75 GHz

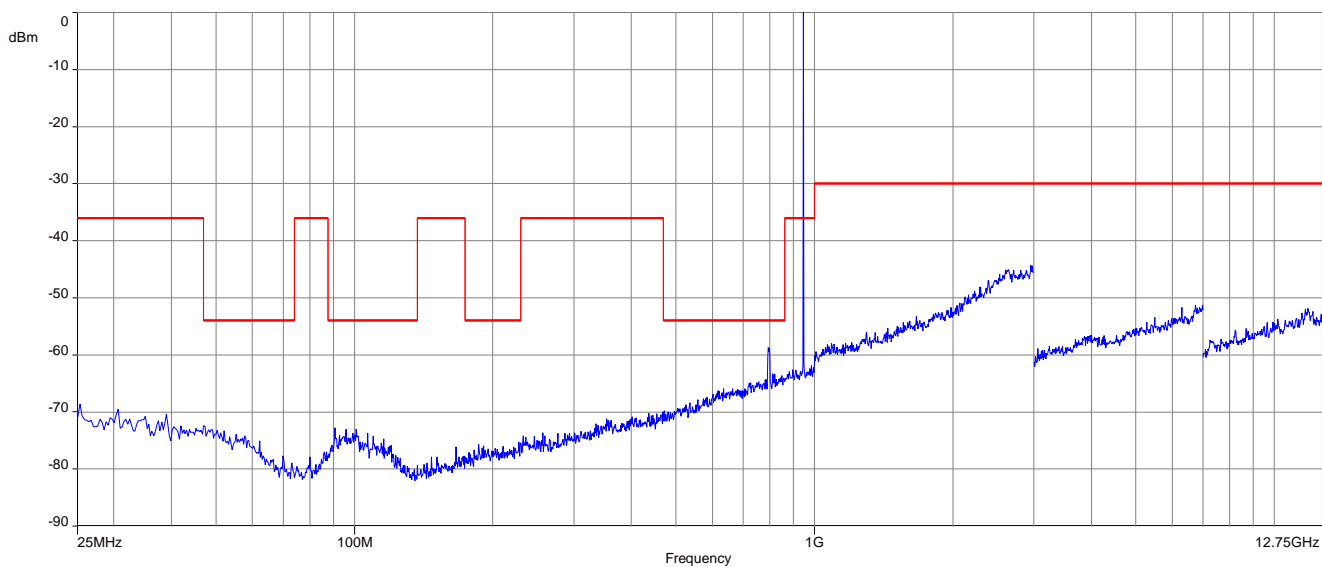

Plot 3: 951.80 MHz, 25 MHz – 12.75 GHz

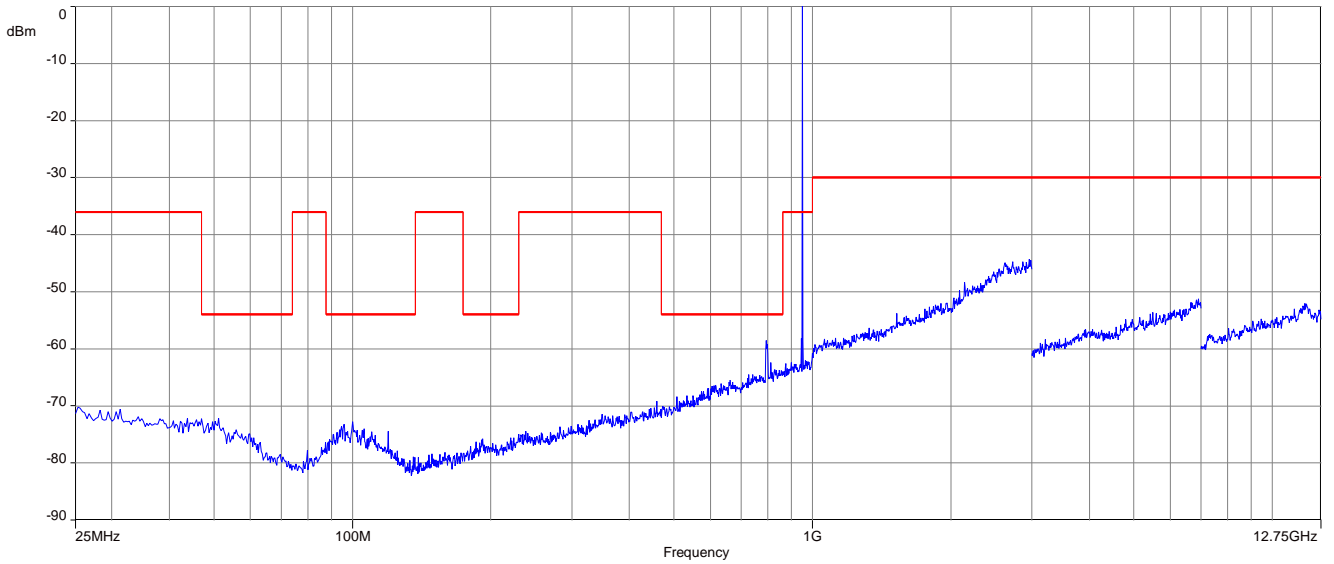

Plot 4: 953.05 MHz, 25 MHz – 12.75 GHz

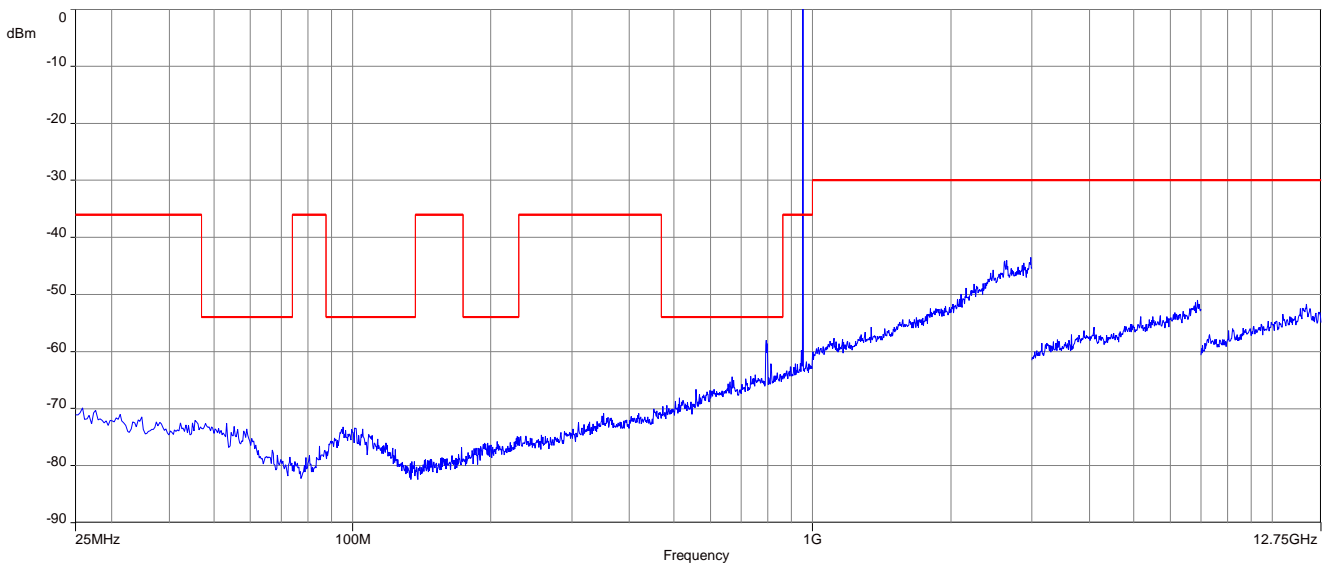

Plot 5: 956.05 MHz, 25 MHz – 12.75 GHz

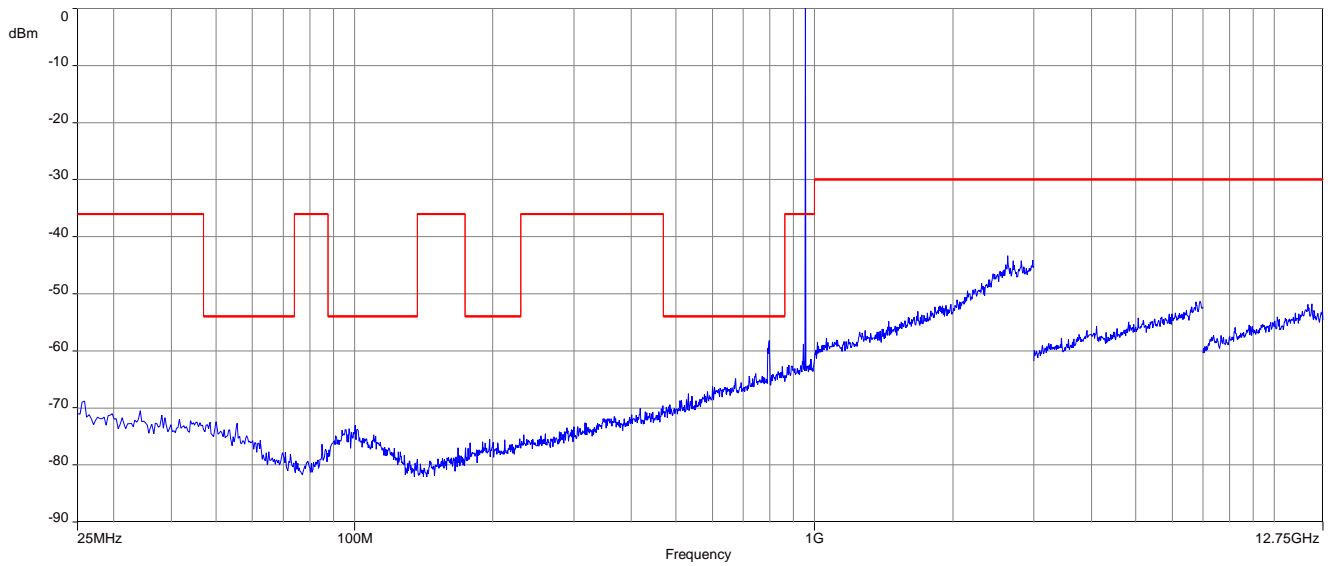

Plot 6: 956.65 MHz, 25 MHz – 12.75 GHz

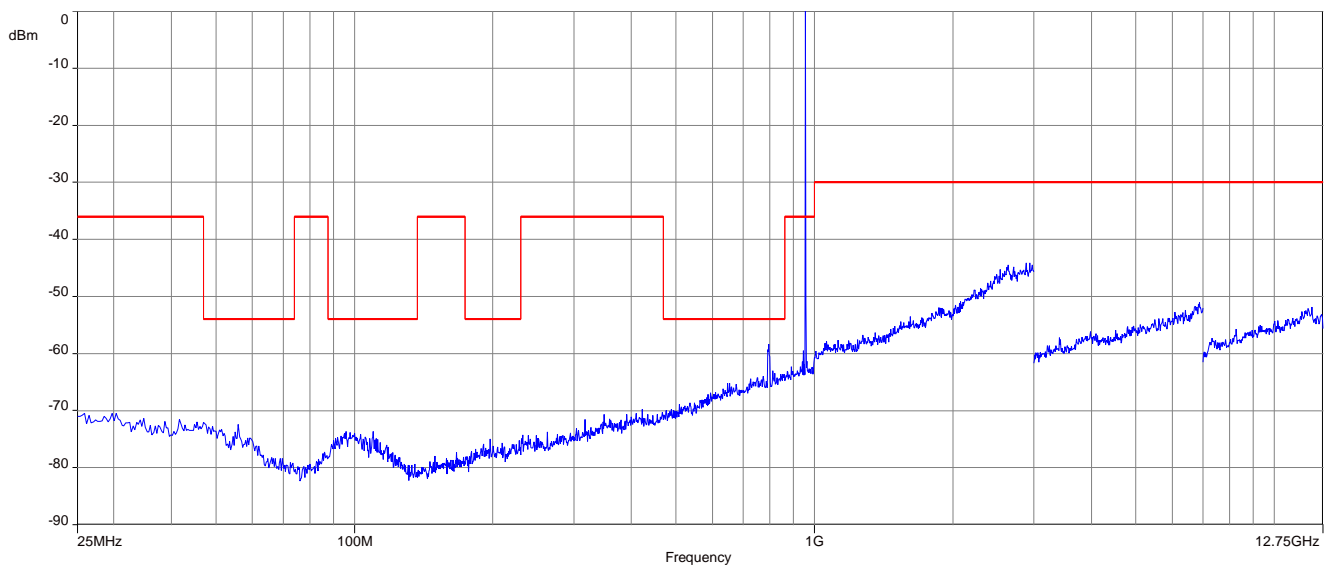

Plot 7: 959.65 MHz, 25 MHz – 12.75 GHz

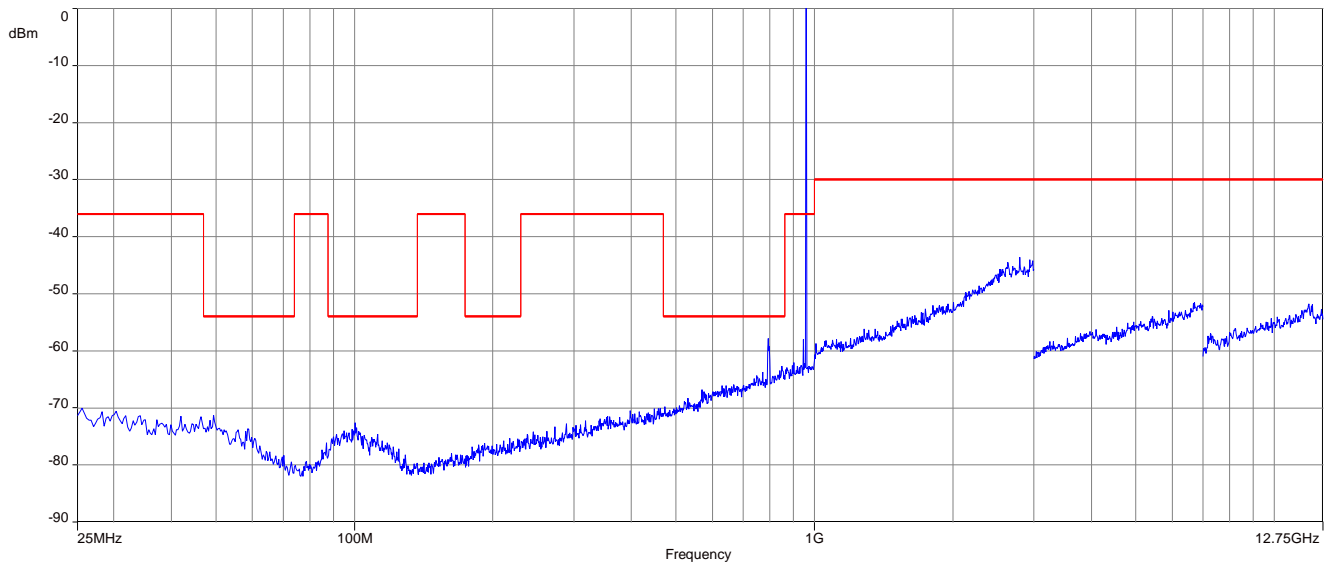

LD mode:

Plot 1: 941.70 MHz, 25 MHz – 12.75 GHz

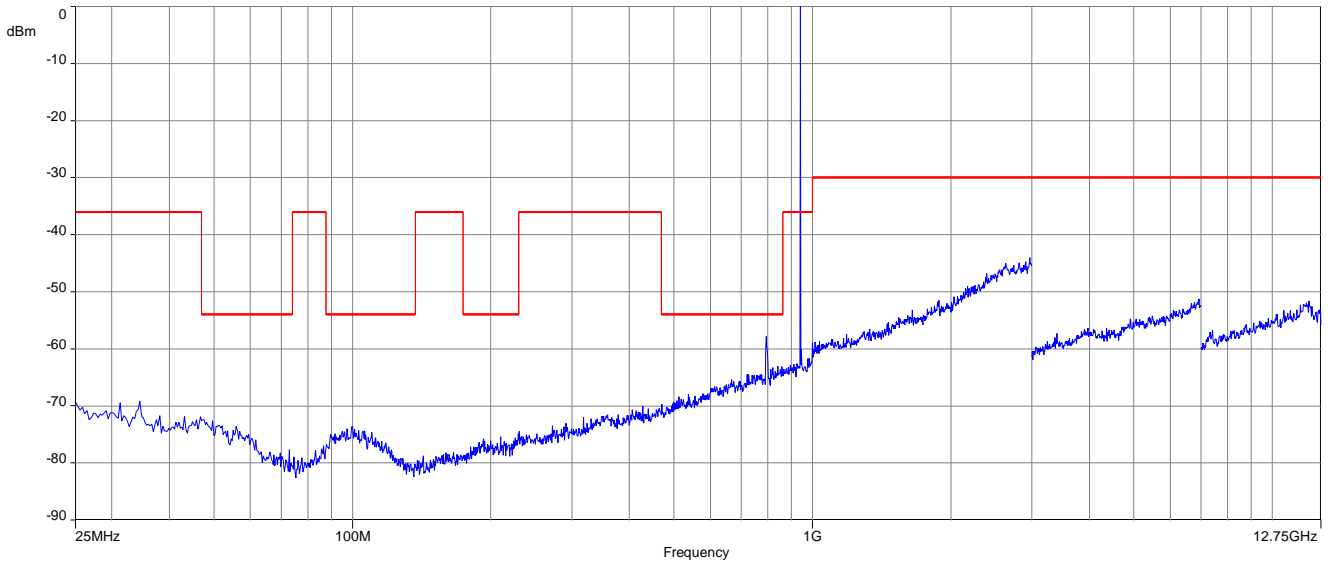

Plot 2: 946.75 MHz, 25 MHz – 12.75 GHz

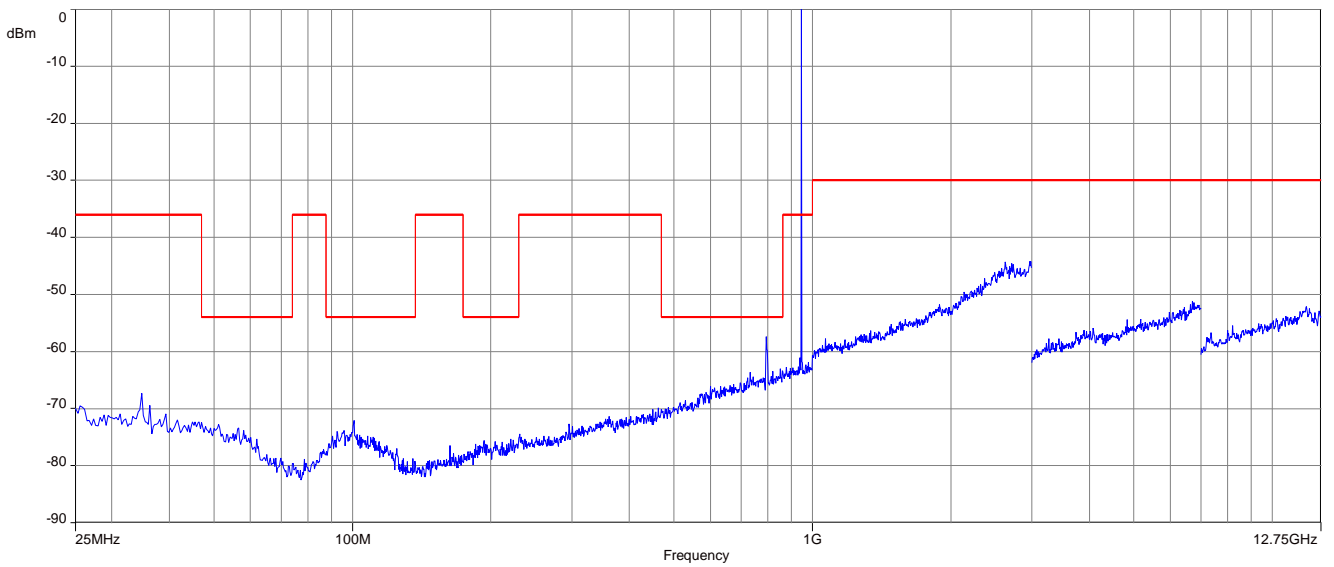

Plot 3: 951.80 MHz, 25 MHz – 12.75 GHz

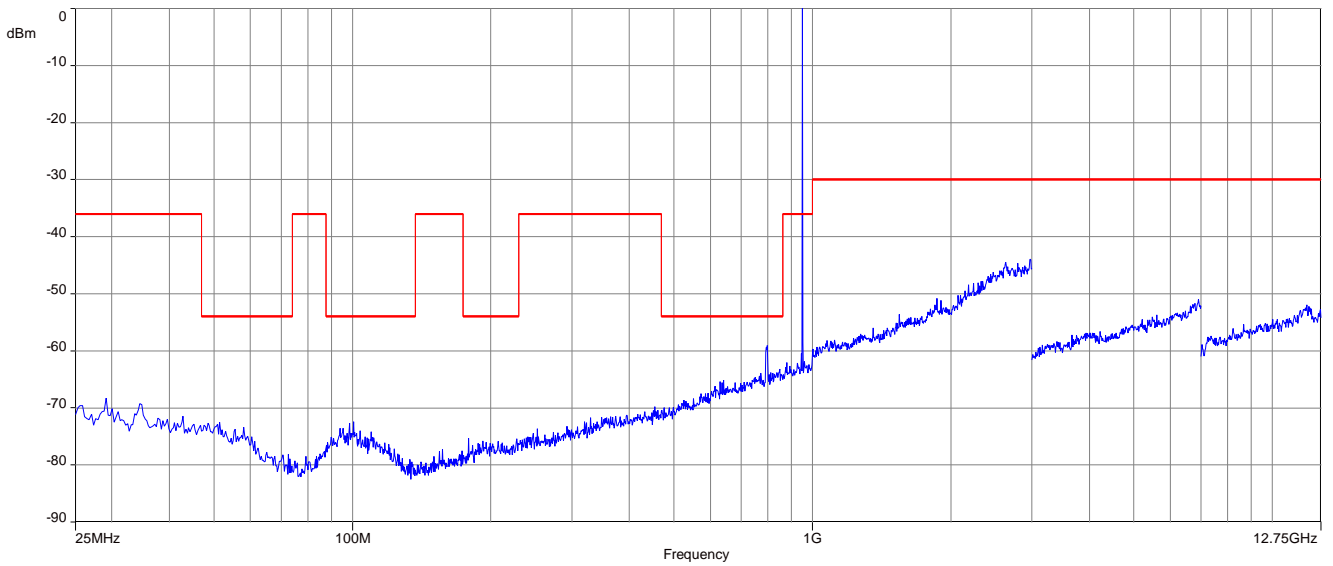

Plot 4: 953.05 MHz, 25 MHz – 12.75 GHz

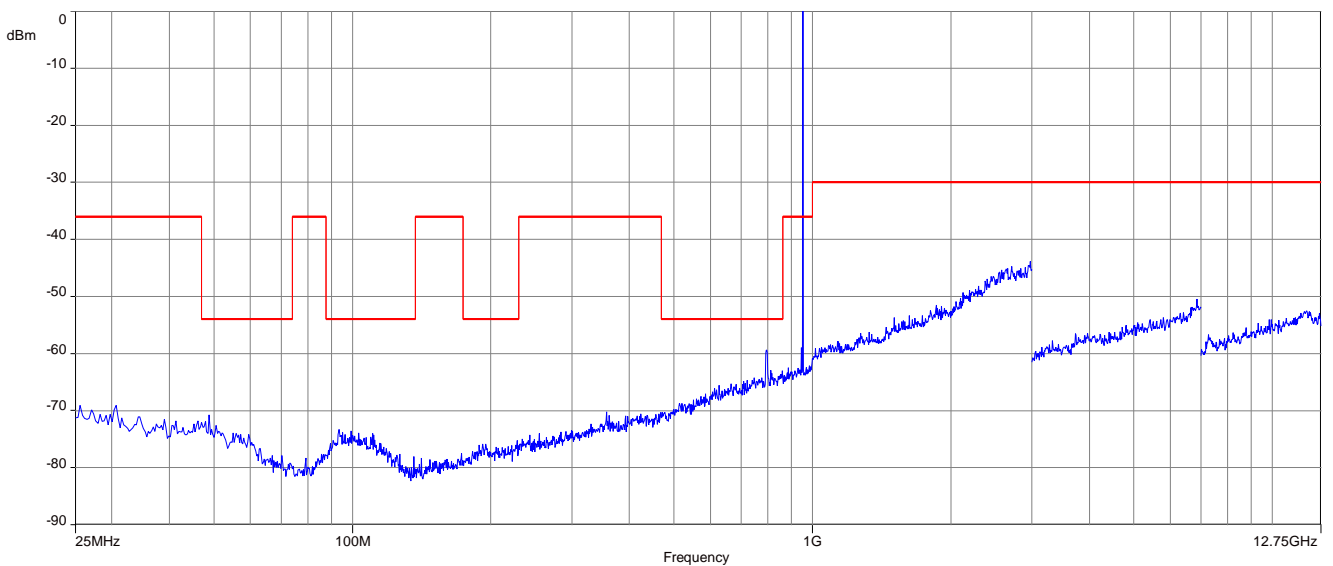

Plot 5: 956.05 MHz, 25 MHz – 12.75 GHz

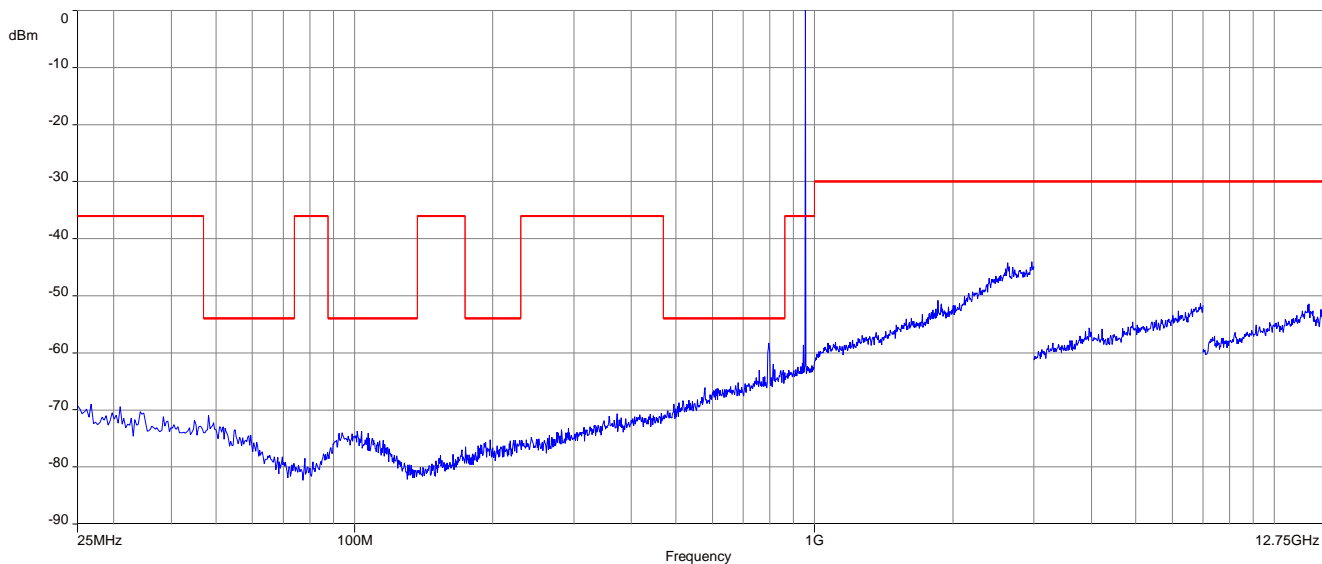

Plot 6: 956.65 MHz, 25 MHz – 12.75 GHz

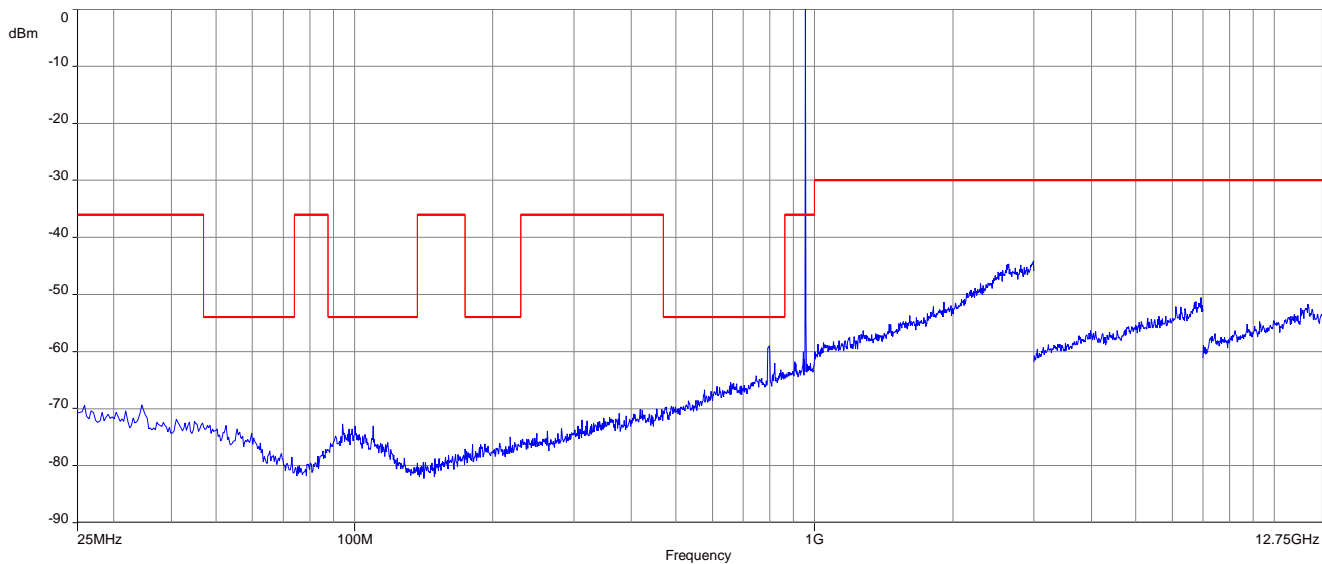

Plot 7: 959.65 MHz, 25 MHz – 12.75 GHz

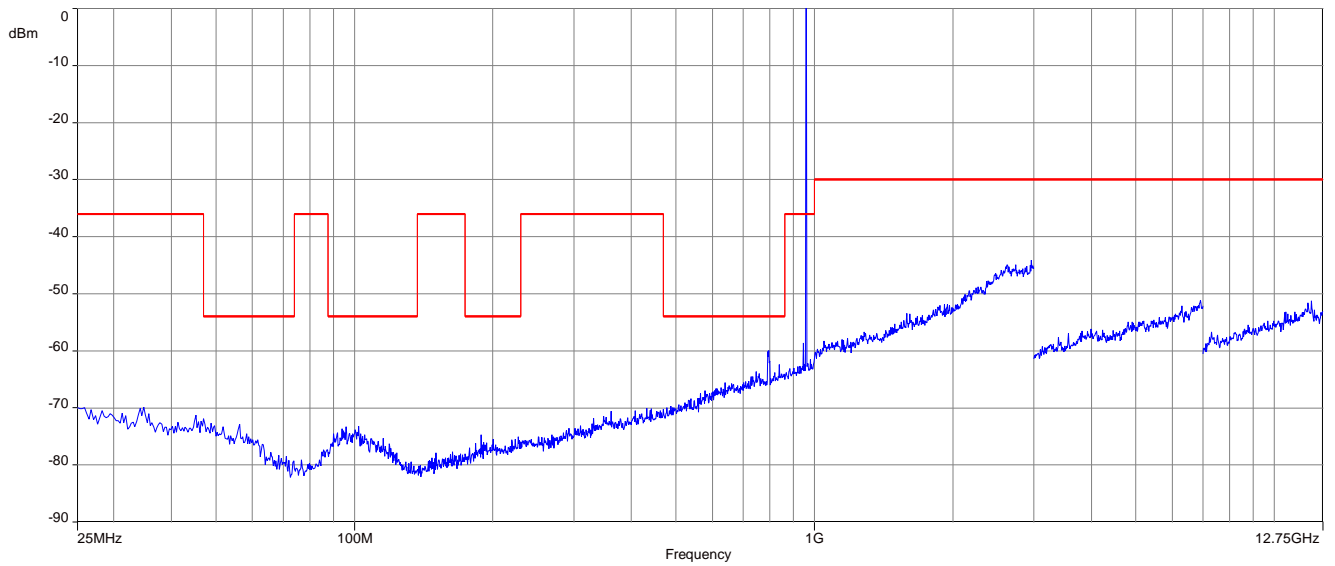

12.5 Necessary bandwidth (BN) for digital systems

Measurement:

Measurement parameter	
Detector:	Peak / Average (-90 dBc point only)
Sweep time:	Auto
Resolution bandwidth:	1 kHz
Video bandwidth:	1 kHz
Span:	$f_c - 1 \text{ MHz}$ to $f_c + 1 \text{ MHz}$ (2 MHz)
Trace mode:	Max hold/view
EUT:	CW and MC
Test setup:	See sub clause 7.2 - A
Measurement uncertainty:	See sub clause 9

Limits: according to ETSI EN 300 422-1 v1.4.2

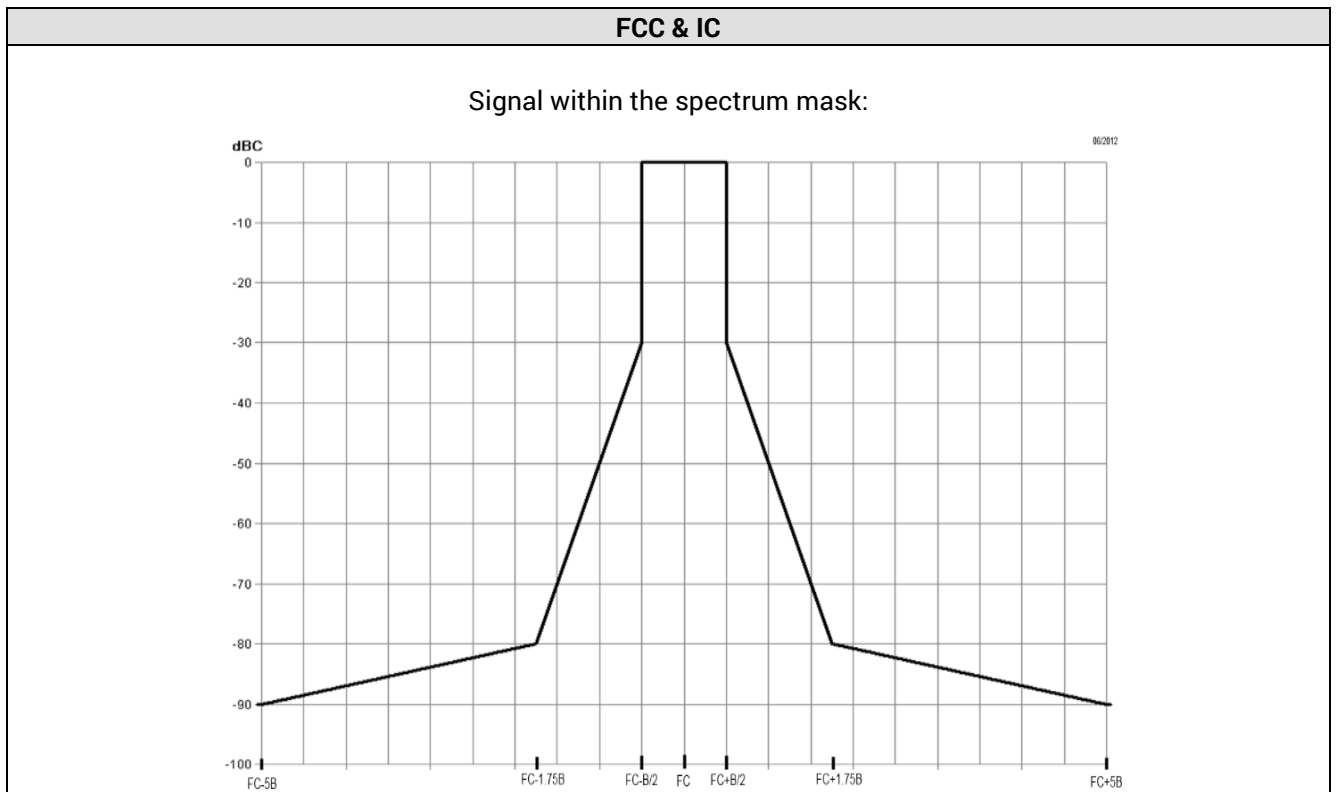

Plots normal mode:

Frequency	Carrier power	Modulated carrier
941.70 MHz	<p>Carrier power plot for 941.70 MHz. The plot shows a flat line at approximately -100 dBm across the entire span. The y-axis ranges from -100 dBm to 0 dBm. The x-axis is labeled 'Zero Span' and '1000 pts'. The plot title is 'CF 941.7 MHz' and the timestamp is '13:43:15 21.07.2022'.</p>	<p>Modulated carrier plot for 941.70 MHz. The plot shows a signal with a peak at approximately -10 dBm. The y-axis ranges from -100 dBm to 0 dBm. The x-axis is labeled '1000 pts' and '200.0 kHz'. The plot title is 'CF 941.7 MHz' and the timestamp is '13:45:38 21.07.2022'.</p>
946.75 MHz	<p>Carrier power plot for 946.75 MHz. The plot shows a flat line at approximately -100 dBm across the entire span. The y-axis ranges from -100 dBm to 0 dBm. The x-axis is labeled 'Zero Span' and '1000 pts'. The plot title is 'CF 946.75 MHz' and the timestamp is '15:26:52 21.07.2022'.</p>	<p>Modulated carrier plot for 946.75 MHz. The plot shows a signal with a peak at approximately -10 dBm. The y-axis ranges from -100 dBm to 0 dBm. The x-axis is labeled '1000 pts' and '200.0 kHz'. The plot title is 'CF 946.75 MHz' and the timestamp is '15:31:47 21.07.2022'.</p>
951.80 MHz	<p>Carrier power plot for 951.80 MHz. The plot shows a flat line at approximately -100 dBm across the entire span. The y-axis ranges from -100 dBm to 0 dBm. The x-axis is labeled 'Zero Span' and '1000 pts'. The plot title is 'CF 951.8 MHz' and the timestamp is '16:07:45 21.07.2022'.</p>	<p>Modulated carrier plot for 951.80 MHz. The plot shows a signal with a peak at approximately -10 dBm. The y-axis ranges from -100 dBm to 0 dBm. The x-axis is labeled '1000 pts' and '200.0 kHz'. The plot title is 'CF 951.8 MHz' and the timestamp is '16:09:09 21.07.2022'.</p>

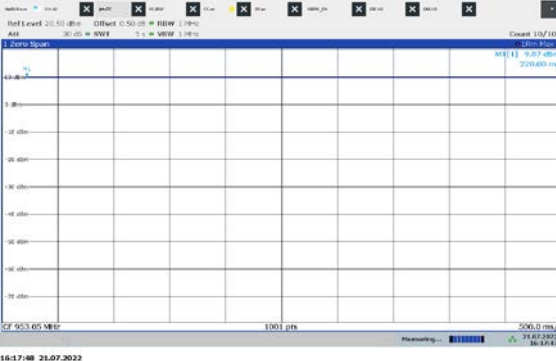
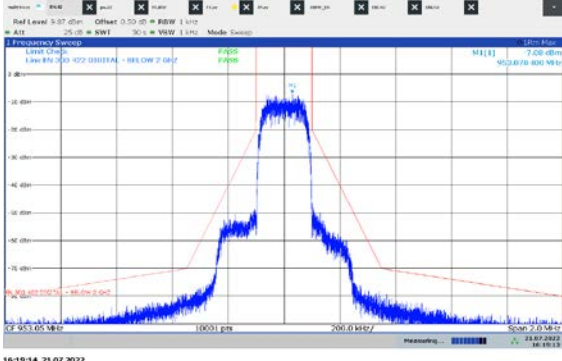
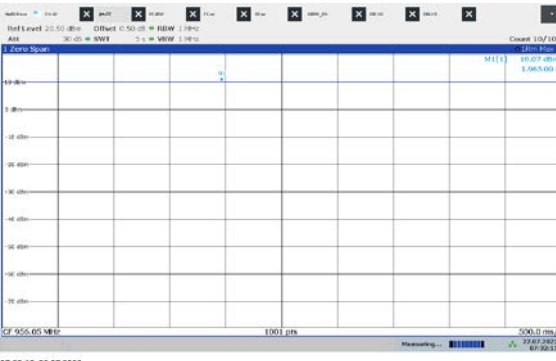
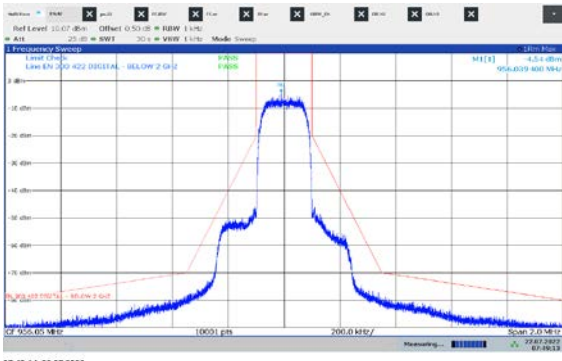
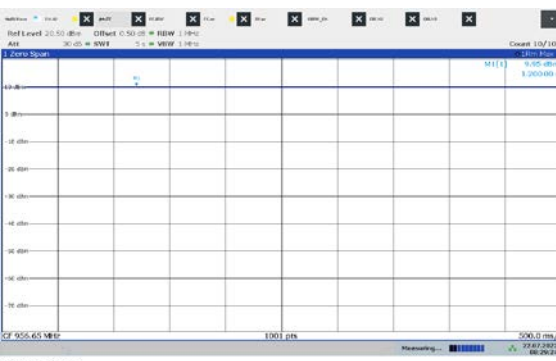
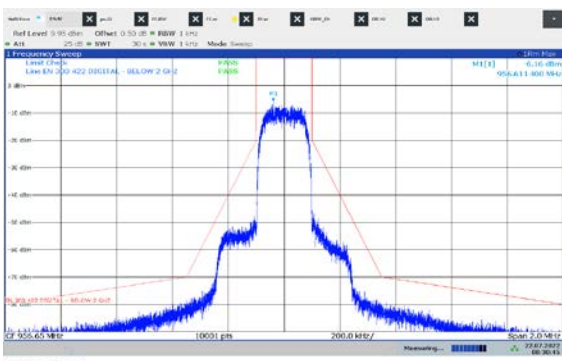
Frequency	Carrier power	Modulated carrier
953.05 MHz	 <p>Carrier power spectrum for 953.05 MHz. The plot shows a flat noise floor at approximately -100 dBm across the entire frequency range. The y-axis ranges from -100 dBm to 0 dBm, and the x-axis ranges from 952.5 MHz to 953.5 MHz. The measurement was taken at 16:17:48 on 21.07.2022.</p>	 <p>Modulated carrier spectrum for 953.05 MHz. The plot shows a signal peak at approximately -7.08 dBm. The y-axis ranges from -100 dBm to 0 dBm, and the x-axis ranges from 952.5 MHz to 953.5 MHz. The measurement was taken at 16:19:14 on 21.07.2022.</p>
956.05 MHz	 <p>Carrier power spectrum for 956.05 MHz. The plot shows a flat noise floor at approximately -100 dBm across the entire frequency range. The y-axis ranges from -100 dBm to 0 dBm, and the x-axis ranges from 955.5 MHz to 956.5 MHz. The measurement was taken at 07:32:13 on 22.07.2022.</p>	 <p>Modulated carrier spectrum for 956.05 MHz. The plot shows a signal peak at approximately -6.5 dBm. The y-axis ranges from -100 dBm to 0 dBm, and the x-axis ranges from 955.5 MHz to 956.5 MHz. The measurement was taken at 07:49:14 on 22.07.2022.</p>
956.65 MHz	 <p>Carrier power spectrum for 956.65 MHz. The plot shows a flat noise floor at approximately -100 dBm across the entire frequency range. The y-axis ranges from -100 dBm to 0 dBm, and the x-axis ranges from 956.1 MHz to 957.1 MHz. The measurement was taken at 08:30:25 on 22.07.2022.</p>	 <p>Modulated carrier spectrum for 956.65 MHz. The plot shows a signal peak at approximately -6.16 dBm. The y-axis ranges from -100 dBm to 0 dBm, and the x-axis ranges from 956.1 MHz to 957.1 MHz. The measurement was taken at 08:30:46 on 22.07.2022.</p>

959.65 MHz

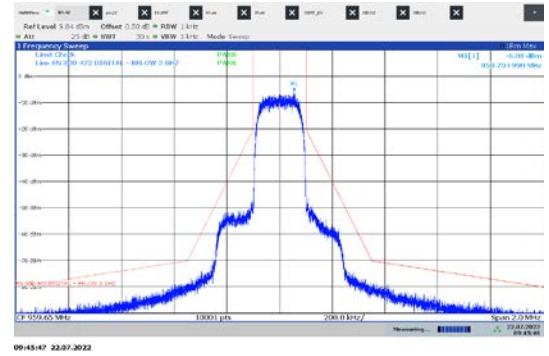
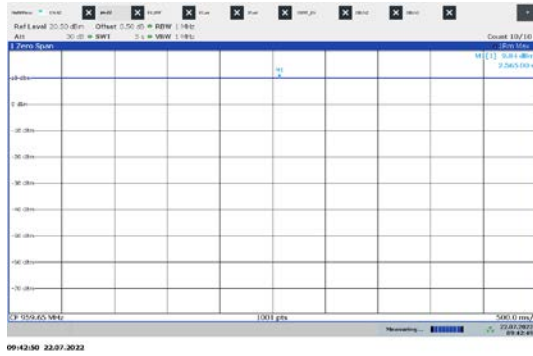

Plots LD mode:

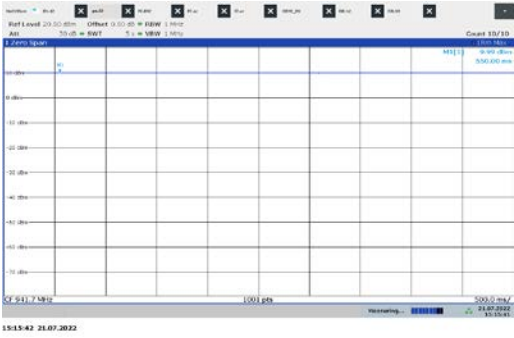
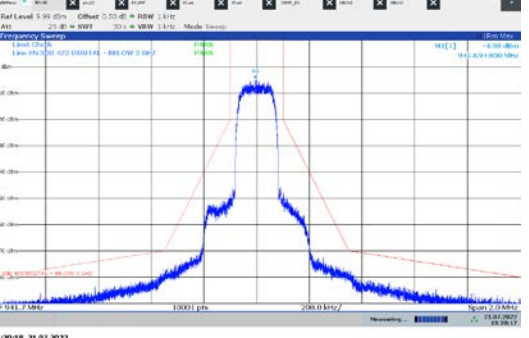
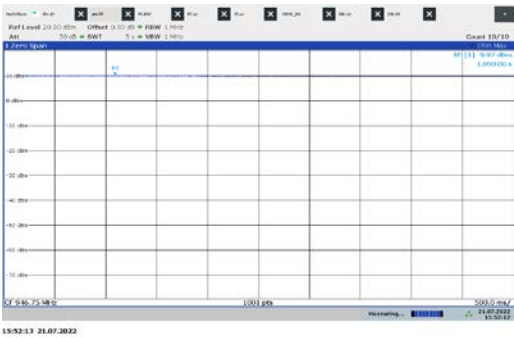
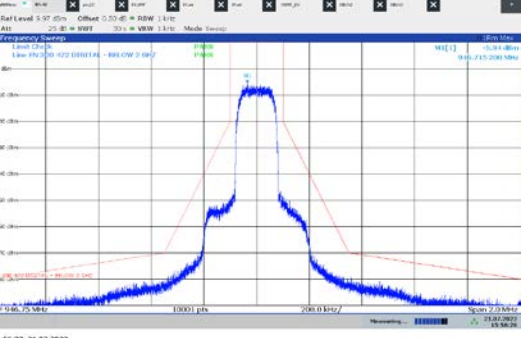
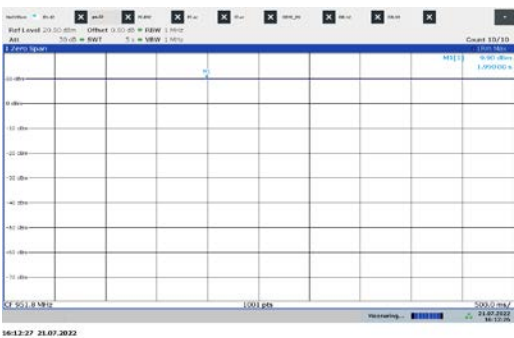
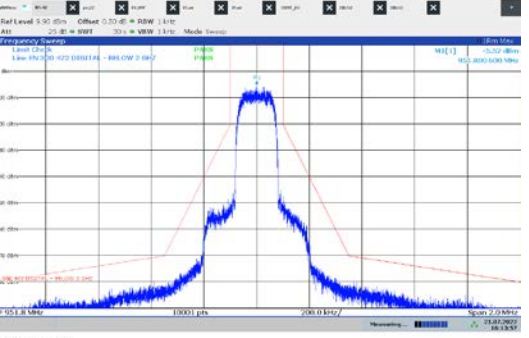
Frequency	Carrier power	Modulated carrier
941.70 MHz		
946.75 MHz		
951.80 MHz		

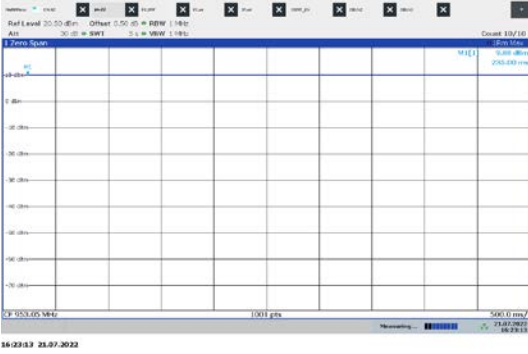
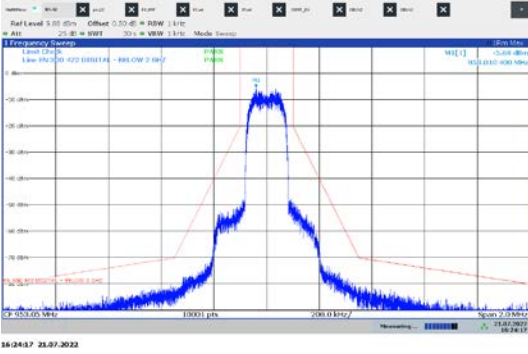
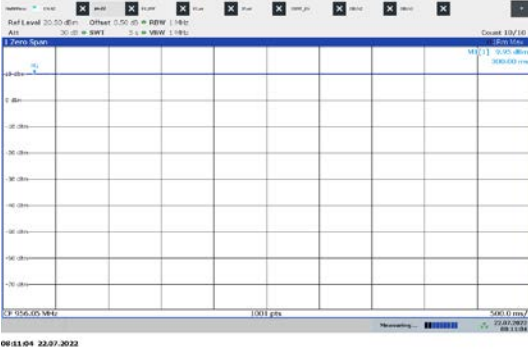
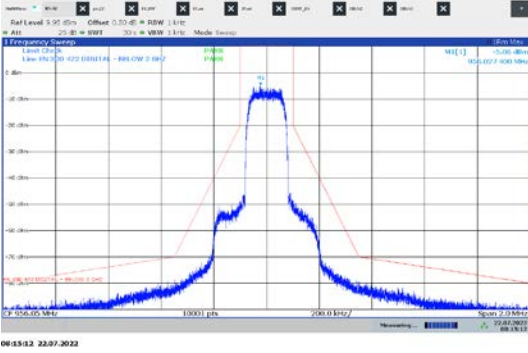
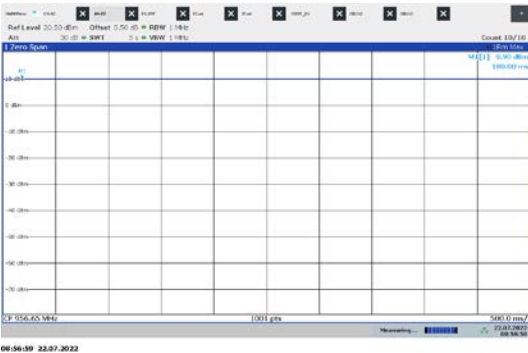
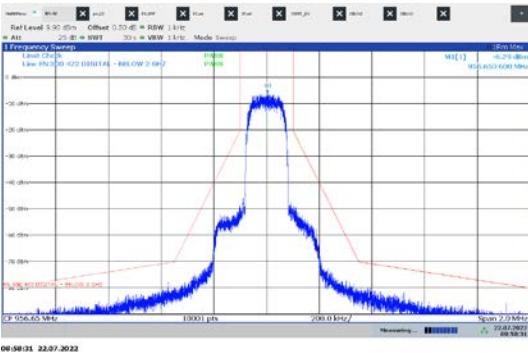
Frequency	Carrier power	Modulated carrier
953.05 MHz	 <p>Carrier power spectrum plot for 953.05 MHz. The plot shows a flat line at approximately -140 dBm across the frequency range. The y-axis is labeled from -140 dBm to 0 dBm. The x-axis is labeled from 953.05 MHz to 953.05 MHz. The plot title is '1 Zero Span'.</p>	 <p>Modulated carrier spectrum plot for 953.05 MHz. The plot shows a sharp peak at approximately -10 dBm. The y-axis is labeled from -140 dBm to 0 dBm. The x-axis is labeled from 953.05 MHz to 953.05 MHz. The plot title is '1 Frequency Sweep'.</p>
956.05 MHz	 <p>Carrier power spectrum plot for 956.05 MHz. The plot shows a flat line at approximately -140 dBm across the frequency range. The y-axis is labeled from -140 dBm to 0 dBm. The x-axis is labeled from 956.05 MHz to 956.05 MHz. The plot title is '1 Zero Span'.</p>	 <p>Modulated carrier spectrum plot for 956.05 MHz. The plot shows a sharp peak at approximately -10 dBm. The y-axis is labeled from -140 dBm to 0 dBm. The x-axis is labeled from 956.05 MHz to 956.05 MHz. The plot title is '1 Frequency Sweep'.</p>
956.65 MHz	 <p>Carrier power spectrum plot for 956.65 MHz. The plot shows a flat line at approximately -140 dBm across the frequency range. The y-axis is labeled from -140 dBm to 0 dBm. The x-axis is labeled from 956.65 MHz to 956.65 MHz. The plot title is '1 Zero Span'.</p>	 <p>Modulated carrier spectrum plot for 956.65 MHz. The plot shows a sharp peak at approximately -10 dBm. The y-axis is labeled from -140 dBm to 0 dBm. The x-axis is labeled from 956.65 MHz to 956.65 MHz. The plot title is '1 Frequency Sweep'.</p>

959.65 MHz

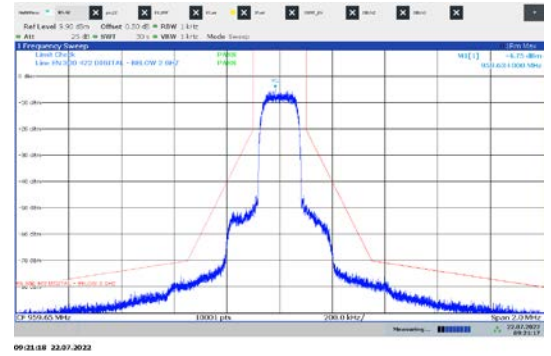
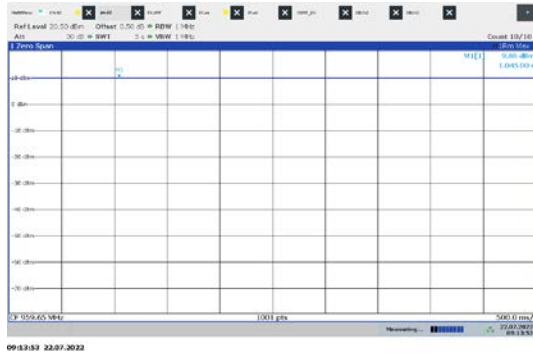

13 Observations

No observations except those reported with the single test cases have been made.

14 Glossary

EUT	Equipment under test
DUT	Device under test
UUT	Unit under test
GUE	GNSS User Equipment
ETSI	European Telecommunications Standards Institute
EN	European Standard
FCC	Federal Communications Commission
FCC ID	Company Identifier at FCC
IC	Industry Canada
PMN	Product marketing name
HMN	Host marketing name
HVIN	Hardware version identification number
FVIN	Firmware version identification number
EMC	Electromagnetic Compatibility
HW	Hardware
SW	Software
Inv. No.	Inventory number
S/N or SN	Serial number
C	Compliant
NC	Not compliant
NA	Not applicable
NP	Not performed
PP	Positive peak
QP	Quasi peak
AVG	Average
OC	Operating channel
OCW	Operating channel bandwidth
OBW	Occupied bandwidth
OOB	Out of band
DFS	Dynamic frequency selection
CAC	Channel availability check
OP	Occupancy period
NOP	Non occupancy period
DC	Duty cycle
PER	Packet error rate
CW	Clean wave
MC	Modulated carrier
WLAN	Wireless local area network
RLAN	Radio local area network
DSSS	Dynamic sequence spread spectrum
OFDM	Orthogonal frequency division multiplexing
FHSS	Frequency hopping spread spectrum
GNSS	Global Navigation Satellite System
C/N₀	Carrier to noise-density ratio, expressed in dB-Hz

15 Document history

Version	Applied changes	Date of release
-/-	Initial release	2022-08-22
A	Annex info update	2022-09-07
B	Updated IC information	2022-10-10
C	Updated HVIN	2022-10-17

16 Accreditation Certificate – D-PL-12076-01-04

first page	last page
 <p>DAKKS Deutsche Akkreditierungsstelle</p> <p>Deutsche Akkreditierungsstelle GmbH</p> <p>Entrusted according to Section 8 subsection 1 AkkStelleG in connection with Section 1 subsection 1 AkkStelleGBV Signatory to the Multilateral Agreements of EA, ILAC and IAF for Mutual Recognition</p> <p>Accreditation</p> <p>The Deutsche Akkreditierungsstelle GmbH attests that the testing laboratory</p> <p>CTC advanced GmbH Untertürkheimer Straße 6-10, 66117 Saarbrücken</p> <p>is competent under the terms of DIN EN ISO/IEC 17025:2018 to carry out tests in the following fields:</p> <p>Telecommunication (TC) and Electromagnetic Compatibility (EMC) for Canadian Standards</p> <p>The accreditation certificate shall only apply in connection with the notice of accreditation of 09.06.2020 with the accreditation number D-PL-12076-01. It comprises the cover sheet, the reverse side of the cover sheet and the following annex with a total of 07 pages.</p> <p>Registration number of the certificate: D-PL-12076-01-04</p> <p>Frankfurt am Main, 09.06.2020</p> <p>by order of: Ing. (FH) Andreas Egner Head of Division</p> <p><small>The certificate together with its annex reflects the status at the time of the date of issue. The current status of the scope of accreditation can be found in the database of accredited bodies of Deutsche Akkreditierungsstelle GmbH. https://www.dakks.de/en/content/accredited-bodies-dakks See notes on next page.</small></p>	 <p>Deutsche Akkreditierungsstelle GmbH</p> <p>Office Berlin Spittelmarkt 10 10117 Berlin</p> <p>Office Frankfurt am Main Europa-Allee 52 60327 Frankfurt am Main</p> <p>Office Braunschweig Bundesallee 100 38116 Braunschweig</p> <p>The publication of extracts of the accreditation certificate is subject to the prior written approval by Deutsche Akkreditierungsstelle GmbH (DAKKS). Exempted is the unchanged form of separate disseminations of the cover sheet by the conformity assessment body mentioned overleaf.</p> <p>No impression shall be made that the accreditation also extends to fields beyond the scope of accreditation attested by DAKKS.</p> <p>The accreditation was granted pursuant to the Act on the Accreditation Body (AkkStelleG) of 31 July 2009 (Federal Law Gazette I p. 2625) and the Regulation (EC) No 765/2008 of the European Parliament and of the Council of 9 July 2008 setting out the requirements for accreditation and market surveillance relating to the marketing of products (Official Journal of the European Union L 218 of 9 July 2008, p. 30). DAKKS is a signatory to the Multilateral Agreements for Mutual Recognition of the European co-operation for Accreditation (EA), International Accreditation Forum (IAF) and International Laboratory Accreditation Cooperation (ILAC). The signatories to these agreements recognise each other's accreditations.</p> <p>The up-to-date state of membership can be retrieved from the following websites: EA: www.european-accreditation.org ILAC: www.ilac.org IAF: www.iaf.nu</p>

Note: The current certificate annex is published on the websites (link see below).

<https://www.dakks.de/files/data/as/pdf/D-PL-12076-01-04e.pdf>

OR

https://ctcadvanced.com/app/uploads/2020/06/D-PL-12076-01-04_Canada_TCEMC.pdf

17 Accreditation Certificate – D-PL-12076-01-05

first page	last page			
 <p>Deutsche Akkreditierungsstelle GmbH</p> <p>Entrusted according to Section 8 subsection 1 AkkStelleG in connection with Section 1 subsection 1 AkkStelleGBV Signatory to the Multilateral Agreements of EA, ILAC and IAF for Mutual Recognition</p> <p>Accreditation </p> <p>The Deutsche Akkreditierungsstelle GmbH attests that the testing laboratory CTC advanced GmbH Untertürkheimer Straße 6-10, 66117 Saarbrücken is competent under the terms of DIN EN ISO/IEC 17025:2018 to carry out tests in the following fields: Telecommunication (FCC Requirements)</p> <p>The accreditation certificate shall only apply in connection with the notice of accreditation of 09.06.2020 with the accreditation number D-PL-12076-01. It comprises the cover sheet, the reverse side of the cover sheet and the following annex with a total of 05 pages.</p> <p>Registration number of the certificate: D-PL-12076-01-05</p> <p>Frankfurt am Main, 09.06.2020 by  Dipl.-Ing. (FH) Ralf Egner Head of Division</p> <p><small>The certificate together with its annex reflects the status at the time of the date of issue. The current status of the scope of accreditation can be found in the database of accredited bodies of Deutsche Akkreditierungsstelle GmbH. https://www.dakks.de/en/content/accredited-bodies-dakks Inventarisiert</small></p>	<p>Deutsche Akkreditierungsstelle GmbH</p> <table border="0"> <tr> <td>Office Berlin Spittelmarkt 10 10117 Berlin</td> <td>Office Frankfurt am Main Europa-Allee 52 60327 Frankfurt am Main</td> <td>Office Braunschweig Bundesallee 100 38116 Braunschweig</td> </tr> </table> <p>The publication of extracts of the accreditation certificate is subject to the prior written approval by Deutsche Akkreditierungsstelle GmbH (DAkKS). Exempted is the unchanged form of separate disseminations of the cover sheet by the conformity assessment body mentioned overleaf.</p> <p>No impression shall be made that the accreditation also extends to fields beyond the scope of accreditation attested by DAkKS.</p> <p>The accreditation was granted pursuant to the Act on the Accreditation Body (AkkStelleG) of 31 July 2009 (Federal Law Gazette I p. 2625) and the Regulation (EC) No 765/2008 of the European Parliament and of the Council of 9 July 2008 setting out the requirements for accreditation and market surveillance relating to the marketing of products (Official Journal of the European Union L 218 of 9 July 2008, p. 30). DAkKS is a signatory to the Multilateral Agreements for Mutual Recognition of the European co-operation for Accreditation (EA), International Accreditation Forum (IAF) and International Laboratory Accreditation Cooperation (ILAC). The signatories to these agreements recognise each other's accreditations.</p> <p>The up-to-date state of membership can be retrieved from the following websites: EA: www.european-accreditation.org ILAC: www.ilac.org IAF: www.iaf.nu</p>	Office Berlin Spittelmarkt 10 10117 Berlin	Office Frankfurt am Main Europa-Allee 52 60327 Frankfurt am Main	Office Braunschweig Bundesallee 100 38116 Braunschweig
Office Berlin Spittelmarkt 10 10117 Berlin	Office Frankfurt am Main Europa-Allee 52 60327 Frankfurt am Main	Office Braunschweig Bundesallee 100 38116 Braunschweig		

Note: The current certificate annex is published on the websites (link see below).

<https://www.dakks.de/files/data/as/pdf/D-PL-12076-01-05e.pdf>

or

https://ctcadvanced.com/app/uploads/2020/06/D-PL-12076-01-05_TCB_USA.pdf

END OF TEST REPORT