

TEST REPORT



Test report no.: 1-5191/17-01-11-B

BNetzA-CAB-02/21-102

Testing laboratory

CTC advanced GmbH

Untertuerkheimer Strasse 6 – 10
66117 Saarbruecken / Germany
Phone: + 49 681 5 98 - 0
Fax: + 49 681 5 98 - 9075
Internet: <http://www.ctcadvanced.com>
e-mail: mail@ctcadvanced.com

Accredited Testing Laboratory:

The testing laboratory (area of testing) is accredited according to DIN EN ISO/IEC 17025 (2005) by the Deutsche Akkreditierungsstelle GmbH (DAkkS) The accreditation is valid for the scope of testing procedures as stated in the accreditation certificate with the registration number: D-PL-12076-01-03

Applicant

Sennheiser electronic GmbH & Co. KG

Am Labor 1
30900 Wedemark / GERMANY
Phone: +49 5130 600-0
Contact: Marcus Kasten
e-mail: Marcus.Kasten@sennheiser.com
Phone: +49 5130 600-1229

Manufacturer

Sennheiser electronic GmbH & Co. KG

Am Labor 1
30900 Wedemark / GERMANY

Test standard/s

FCC – Title 47 CFR Part 15	FCC – Title 47 of the Code of Federal Regulations; Chapter I; Part 15 – Radio frequency devices
RSS – 247 Issue 2	Digital Transmission Systems (DTSs), Frequency Hopping Systems (FHSs) and Licence – Exempt Local Area Network (LE-LAN) Devices
RSS – Gen Issue 5	General Requirements for Compliance of Radio Apparatus

For further applied test standards please refer to section 3 of this test report.

Test Item

Kind of test item:	XS Wireless Digital
Model name:	TX XLR; TX 35; TX 63
FCC ID:	DMOPTX
IC:	2099A-PTX
Frequency:	DTS band 2400 MHz to 2483.5 MHz
Technology tested:	Proprietary
Antenna:	2 integrated ceramic antennas
Power supply:	3.7 V DC by Li-Ion battery
Temperature range:	-10°C to +55°C



This test report is electronically signed and valid without handwritten signature. For verification of the electronic signatures, the public keys can be requested at the testing laboratory.

Test report authorized:

Marco Bertolino
Lab Manager
Radio Communications & EMC

Test performed:

Mihail Dorongovskij
Lab Manager
Radio Communications & EMC

1 Table of contents

1	Table of contents	2
2	General information	3
2.1	Notes and disclaimer	3
2.2	Application details	3
2.3	Test laboratories sub-contracted	3
3	Test standard/s and references	4
4	Test environment	5
5	Test item	5
5.1	General description	5
5.2	Additional information	5
6	Sequence of testing	6
6.1	Sequence of testing radiated spurious 9 kHz to 30 MHz	6
6.2	Sequence of testing radiated spurious 30 MHz to 1 GHz	7
6.3	Sequence of testing radiated spurious 1 GHz to 18 GHz	8
6.4	Sequence of testing radiated spurious above 18 GHz	9
7	Description of the test setup	10
7.1	Shielded semi anechoic chamber	11
7.2	Shielded fully anechoic chamber	12
7.3	Radiated measurements > 18 GHz	13
7.4	Conducted measurements	14
7.5	AC conducted	15
7.6	Shielded fully anechoic chamber	16
8	Measurement uncertainty	17
9	Summary of measurement results	18
10	Additional comments	19
11	Measurement results	20
11.1	System gain	20
11.2	Duty cycle	21
11.3	Power spectral density	22
11.4	DTS bandwidth – 6 dB bandwidth	23
11.5	Occupied bandwidth – 99% emission bandwidth	24
11.6	Maximum output power	25
11.7	Detailed spurious emissions @ the band edge - conducted	26
11.8	Band edge compliance conducted	27
11.9	TX spurious emissions conducted	29
11.10	Spurious emissions radiated below 30 MHz	30
11.11	Spurious emissions radiated 30 MHz to 1 GHz	33
11.12	Spurious emissions radiated above 1 GHz	39
11.13	Spurious emissions conducted below 30 MHz (AC conducted)	46
Annex A	Glossary	49
Annex B	Document history	50
Annex C	Accreditation Certificate	50

2 General information

2.1 Notes and disclaimer

The test results of this test report relate exclusively to the test item specified in this test report. CTC advanced GmbH does not assume responsibility for any conclusions and generalizations drawn from the test results with regard to other specimens or samples of the type of the equipment represented by the test item.

The test report may only be reproduced or published in full. Reproduction or publication of extracts from the report requires the prior written approval of CTC advanced GmbH.

The testing service provided by CTC advanced GmbH has been rendered under the current "General Terms and Conditions for CTC advanced GmbH".

CTC advanced GmbH will not be liable for any loss or damage resulting from false, inaccurate, inappropriate or incomplete product information provided by the customer.

Under no circumstances does the CTC advanced GmbH test report include any endorsement or warranty regarding the functionality, quality or performance of any other product or service provided.

Under no circumstances does the CTC advanced GmbH test report include or imply any product or service warranties from CTC advanced GmbH, including, without limitation, any implied warranties of merchantability, fitness for purpose, or non-infringement, all of which are expressly disclaimed by CTC advanced GmbH.

All rights and remedies regarding vendor's products and services for which CTC advanced GmbH has prepared this test report shall be provided by the party offering such products or services and not by CTC advanced GmbH. In no case this test report can be considered as a Letter of Approval.

This test report is electronically signed and valid without handwritten signature. For verification of the electronic signatures, the public keys can be requested at the testing laboratory.

This test report replaces the test report with the number 1-5191/17-01-11-A and dated 2018-11-09

2.2 Application details

Date of receipt of order:	2018-07-12
Date of receipt of test item:	2018-07-30
Start of test:	2018-07-30
End of test:	2018-08-01
Person(s) present during the test:	Mr. Carsten Bischoff

2.3 Test laboratories sub-contracted

None

3 Test standard/s and references

Test standard	Date	Description
FCC – Title 47 CFR Part 15	-/-	FCC – Title 47 of the Code of Federal Regulations; Chapter I; Part 15 – Radio frequency devices
RSS – 247 Issue 2	February 2017	Digital Transmission Systems (DTSs), Frequency Hopping Systems (FHSs) and Licence – Exempt Local Area Network (LE-LAN) Devices
RSS – Gen Issue 5	April 2018	General Requirements for Compliance of Radio Apparatus

Guidance	Version	Description
DTS: KDB 558074 D01	v04	Guidance for Performing Compliance Measurements on Digital Transmission Systems (DTS) Operating Under §15.247
ANSI C63.4-2014	-/-	American national standard for methods of measurement of radio-noise emissions from low-voltage electrical and electronic equipment in the range of 9 kHz to 40 GHz
ANSI C63.10-2013	-/-	American national standard of procedures for compliance testing of unlicensed wireless devices

4 Test environment

Temperature	:	T_{nom} T_{max} T_{min}	+22 °C during room temperature tests No tests under extreme environmental conditions required. No tests under extreme environmental conditions required.
Relative humidity content	:		53 %
Barometric pressure	:		1021 hpa
Power supply	:	V_{nom} V_{max} V_{min}	3.7 V DC by Li-Ion battery No tests under extreme environmental conditions required. No tests under extreme environmental conditions required.

5 Test item

5.1 General description

Kind of test item	:	XS Wireless Digital
Type identification	:	TX XLR; TX 35; TX 63
HMN	:	-/-
PMN	:	XS Wireless Digital
HVIN	:	TX XLR TX 35 TX 63
FVIN	:	
S/N serial number	:	Radiated unit: S/N: 1288000126 PCB number: KG001015024430579094T15G800010015 Conducted unit: S/N: 1288000127 PCB number: KG001015024430579094T15G800010008
Hardware status	:	576212 audio transmitter
Software status	:	0.0.29
Firmware status	:	0.0.29
Frequency band	:	DTS band 2400 MHz to 2483.5 MHz
Type of radio transmission	:	TDMA + adaptive frequency selection
Use of frequency spectrum	:	
Type of modulation	:	GFSK
Number of channels	:	40
Antenna	:	2 integrated ceramic antennas
Power supply	:	3.7 V DC by Li-Ion battery
Temperature range	:	-10°C to +55°C

5.2 Additional information

The content of the following annexes is defined in the QA. It may be that not all of the listed annexes are necessary for this report, thus some values in between may be missing.

Test setup and EUT photos are included in test report:

- 1-5191/17-01-01_AnnexA
- 1-5191/17-01-01_AnnexB
- 1-5191/17-01-01_AnnexD

6 Sequence of testing

6.1 Sequence of testing radiated spurious 9 kHz to 30 MHz

Setup

- The equipment is set up to simulate normal operation mode as described in the user manual or defined by the manufacturer.
- If the EUT is a tabletop system, it is placed on a table with 0.8 m height.
- If the EUT is a floor standing device, it is placed directly on the turn table.
- Auxiliary equipment and cables are positioned to simulate normal operation conditions as described in ANSI C 63.4.
- The AC power port of the EUT (if available) is connected to a power outlet below the turntable.
- Measurement distance is 3 m (see ANSI C 63.4) – see test details.
- EUT is set into operation.

Premeasurement*

- The turntable rotates from 0° to 315° using 45° steps.
- The antenna height is 1 m.
- At each turntable position the analyzer sweeps with positive-peak detector to find the maximum of all emissions.

Final measurement

- Identified emissions during the pre-measurement are maximized by the software by rotating the turntable from 0° to 360°.
- Loop antenna is rotated about its vertical axis for maximum response at each azimuth about the EUT. (For certain applications, the loop antenna plane may also need to be positioned horizontally at the specified distance from the EUT)
- The final measurement is done in the position (turntable and elevation) causing the highest emissions with quasi-peak (as described in ANSI C 63.4).
- Final levels, frequency, measuring time, bandwidth, turntable position, correction factor, margin to the limit and limit will be recorded. A plot with the graph of the premeasurement and the limit is stored.

*)Note: The sequence will be repeated three times with different EUT orientations.

6.2 Sequence of testing radiated spurious 30 MHz to 1 GHz

Setup

- The equipment is set up to simulate normal operation mode as described in the user manual or defined by the manufacturer.
- If the EUT is a tabletop system, a table with 0.8 m height is used, which is placed on the ground plane.
- If the EUT is a floor standing device, it is placed on the ground plane with insulation between both.
- Auxiliary equipment and cables are positioned to simulate normal operation conditions as described in ANSI C 63.4.
- The AC power port of the EUT (if available) is connected to a power outlet below the turntable.
- Measurement distance is 10 m or 3 m (see ANSI C 63.4) – see test details.
- EUT is set into operation.

Premeasurement

- The turntable rotates from 0° to 315° using 45° steps.
- The antenna is polarized vertical and horizontal.
- The antenna height changes from 1 m to 3 m.
- At each turntable position, antenna polarization and height the analyzer sweeps three times in peak to find the maximum of all emissions.

Final measurement

- The final measurement is performed for at least six highest peaks according to the requirements of the ANSI C63.4.
- Based on antenna and turntable positions at which the peak values are measured the software maximize the peaks by changing turntable position $\pm 45^\circ$ and antenna height between 1 and 4 m.
- The final measurement is done with quasi-peak detector (as described in ANSI C 63.4).
- Final levels, frequency, measuring time, bandwidth, antenna height, antenna polarization, turntable angle, correction factor, margin to the limit and limit are recorded. A plot with the graph of the premeasurement with marked maximum final results and the limit is stored.

6.3 Sequence of testing radiated spurious 1 GHz to 18 GHz

Setup

- The equipment is set up to simulate normal operation mode as described in the user manual or defined by the manufacturer.
- If the EUT is a tabletop system, a 2-axis positioner with 1.5 m height is used.
- If the EUT is a floor standing device, it is placed directly on the turn table.
- Auxiliary equipment and cables are positioned to simulate normal operation conditions as described in ANSI C 63.4.
- The AC power port of the EUT (if available) is connected to a power outlet below the turntable.
- Measurement distance is 3 m (see ANSI C 63.4) – see test details.
- EUT is set into operation.

Premeasurement

- The turntable rotates from 0° to 315° using 45° steps.
- The antenna is polarized vertical and horizontal.
- The antenna height is 1.5 m.
- At each turntable position and antenna polarization the analyzer sweeps with positive peak detector to find the maximum of all emissions.

Final measurement

- The final measurement is performed for at least six highest peaks according to the requirements of the ANSI C63.4.
- Based on antenna and turntable positions at which the peak values are measured the software maximizes the peaks by rotating the turntable from 0° to 360°. This measurement is repeated for different EUT-table positions (0° to 150° in 30°-steps) and for both antenna polarizations.
- The final measurement is done in the position (turntable, EUT-table and antenna polarization) causing the highest emissions with Peak and RMS detector (as described in ANSI C 63.4).
- Final levels, frequency, measuring time, bandwidth, turntable position, EUT-table position, antenna polarization, correction factor, margin to the limit and limit are recorded. A plot with the graph of the premeasurement with marked maximum final results and the limit is stored.

6.4 Sequence of testing radiated spurious above 18 GHz

Setup

- The equipment is set up to simulate normal operation mode as described in the user manual or defined by the manufacturer.
- Auxiliary equipment and cables are positioned to simulate normal operation conditions as described in ANSI C 63.4.
- The AC power port of the EUT (if available) is connected to a power outlet.
- The measurement distance is as appropriate (e.g. 0.5 m).
- The EUT is set into operation.

Premeasurement

- The test antenna is handheld and moved carefully over the EUT to cover the EUT's whole sphere and different polarizations of the antenna.

Final measurement

- The final measurement is performed at the position and antenna orientation causing the highest emissions with Peak and RMS detector (as described in ANSI C 63.4).
- Final levels, frequency, measuring time, bandwidth, correction factor, margin to the limit and limit are recorded. A plot with the graph of the premeasurement and the limit is stored.

7 Description of the test setup

Typically, the calibrations of the test apparatus are commissioned to and performed by an accredited calibration laboratory. The calibration intervals are determined in accordance with the DIN EN ISO/IEC 17025. In addition to the external calibrations, the laboratory executes comparison measurements with other calibrated test systems or effective verifications. Weekly chamber inspections and range calibrations are performed. Where possible, RF generating and signaling equipment as well as measuring receivers and analyzers are connected to an external high-precision 10 MHz reference (GPS-based or rubidium frequency standard).

In order to simplify the identification of the equipment used at some special tests, some items of test equipment and ancillaries can be provided with an identifier or number in the equipment list below (Lab/Item).

Agenda: Kind of Calibration

k	calibration / calibrated	EK	limited calibration
ne	not required (k, ev, izw, zw not required)	zw	cyclical maintenance (external cyclical maintenance)
ev	periodic self verification	izw	internal cyclical maintenance
Ve	long-term stability recognized	g	blocked for accredited testing
v/k!	Attention: extended calibration interval		
NK!	Attention: not calibrated	*)	next calibration ordered / currently in progress

7.1 Shielded semi anechoic chamber

The radiated measurements are performed in vertical and horizontal plane in the frequency range from 30 MHz to 1 GHz in semi-anechoic chambers. The EUT is positioned on a non-conductive support with a height of 0.80 m above a conductive ground plane that covers the whole chamber. The receiving antennas are conform to specifications ANSI C63. These antennas can be moved over the height range between 1.0 m and 4.0 m in order to search for maximum field strength emitted from EUT. The measurement distances between EUT and receiving antennas are indicated in the test setups for the various frequency ranges. For each measurement, the EUT is rotated in all three axes until the maximum field strength is received. The wanted and unwanted emissions are received by spectrum analyzers where the detector modes and resolution bandwidths over various frequency ranges are set according to requirement ANSI C63.

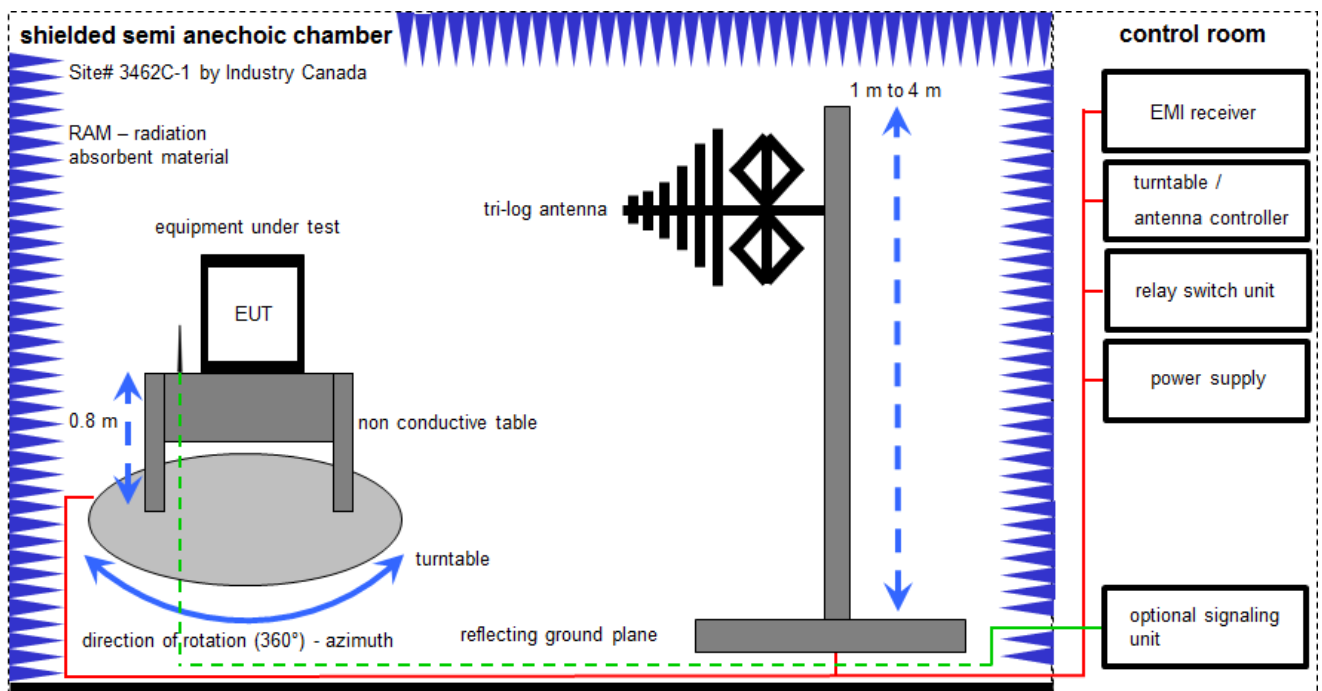

Measurement distance: tri-log antenna 10 meter
EMC32 software version: 10.30.0

FS = UR + CL + AF
(FS-field strength; UR-voltage at the receiver; CL-loss of the cable; AF-antenna factor)

Example calculation:

FS [dB μ V/m] = 12.35 [dB μ V/m] + 1.90 [dB] + 16.80 [dB/m] = 31.05 [dB μ V/m] (35.69 μ V/m)

Equipment table:

No.	Lab / Item	Equipment	Type	Manufacturer	Serial No.	INV. No.	Kind of Calibration	Last Calibration	Next Calibration
1	A	Switch-Unit	3488A	HP	2719A14505	300000368	ev	-/-	-/-
2	A	Meßkabine 1	HF-Absorberhalle	MWB AG 300023	-/-	300000551	ne	-/-	-/-
3	A	EMI Test Receiver	ESCI 3	R&S	100083	300003312	k	15.12.2017	14.12.2018
4	A	Antenna Tower	Model 2175	ETS-Lindgren	64762	300003745	izw	-/-	-/-
5	A	Positioning Controller	Model 2090	ETS-Lindgren	64672	300003746	izw	-/-	-/-
6	A	Turntable Interface-Box	Model 105637	ETS-Lindgren	44583	300003747	izw	-/-	-/-
7	A	TRILOG Broadband Test-Antenna 30 MHz - 3 GHz	VULB9163	Schwarzbeck Mess - Elektronik	371	300003854	vIKI!	24.11.2017	23.11.2020

7.2 Shielded fully anechoic chamber

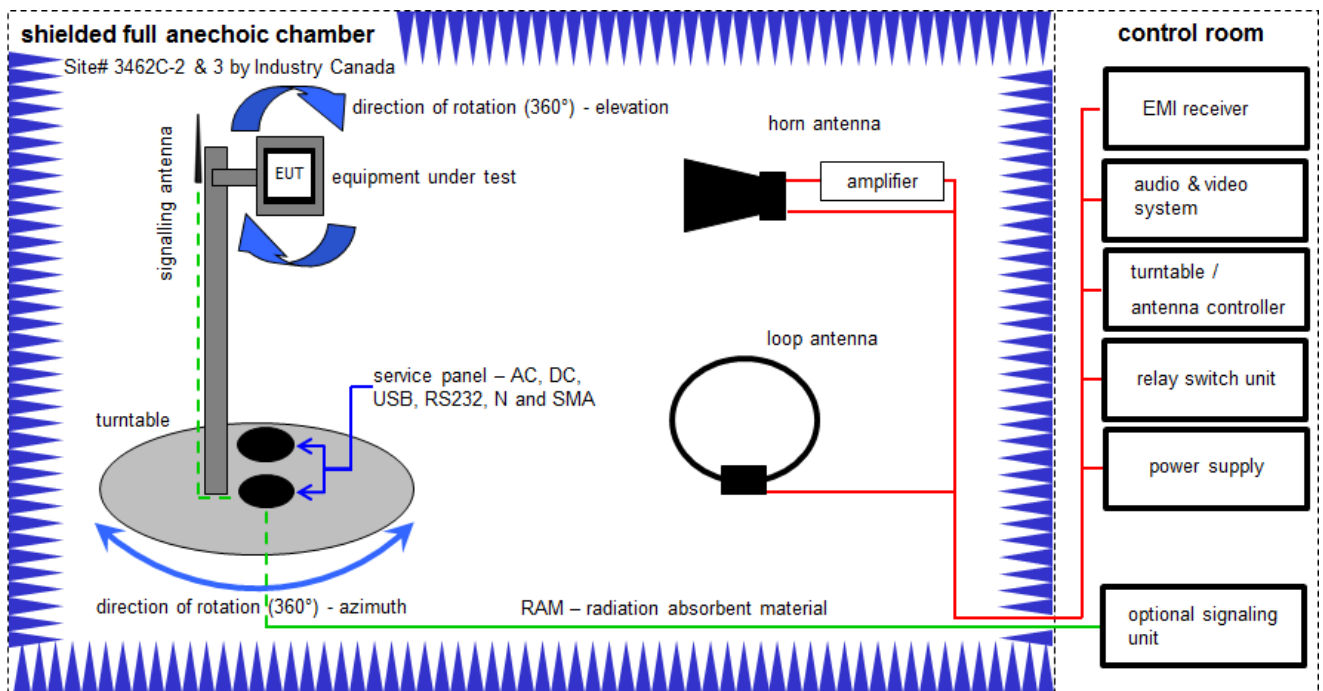

Measurement distance: horn antenna 3 meter; loop antenna 3 meter
EMC32 software version: 10.30.0

FS = UR + CA + AF
(FS-field strength; UR-voltage at the receiver; CA-loss of the signal path; AF-antenna factor)

Example calculation:

FS [dBµV/m] = 40.0 [dBµV/m] + (-35.8) [dB] + 32.9 [dB/m] = 37.1 [dBµV/m] (71.61 µV/m)

Equipment table:

No.	Lab / Item	Equipment	Type	Manufacturer	Serial No.	INV. No.	Kind of Calibration	Last Calibration	Next Calibration
1	B	Active Loop Antenna 9 kHz to 30 MHz	6502	EMCO	2210	300001015	k	07.07.2017	06.07.2019
2	A, B	Anechoic chamber	FAC 3/5m	MWB / TDK	87400/02	300000996	ev	-/-	-/-
3	A	Double-Ridged Waveguide Horn Antenna 1-18.0GHz	3115	EMCO	9107-3697	300001605	vIKII	14.02.2017	13.02.2019
4	A, B	Switch / Control Unit	3488A	HP	*	300000199	ne	-/-	-/-
5	A	Band Reject filter	WRCG2400/2483- 2375/2505-50/10SS	Wainwright	11	300003351	ev	-/-	-/-
6	A, B	EMI Test Receiver 20Hz- 26,5GHz	ESU26	R&S	100037	300003555	k	20.12.2017	19.12.2018
7	A	Highpass Filter	WHK1.1/15G-10SS	Wainwright	3	300003255	ev	-/-	-/-
8	A	Highpass Filter	WHKX7.0/18G-8SS	Wainwright	19	300003790	ne	-/-	-/-
9	A	Broadband Amplifier 0.5-18 GHz	CBLU5184540	CERNEX	22049	300004481	ev	-/-	-/-
10	A, B	4U RF Switch Platform	L4491A	Agilent Technologies	MY50000037	300004509	ne	-/-	-/-
11	A, B	NEXIO EMV- Software	BAT EMC V3.16.0.49	EMCO	-/-	300004682	ne	-/-	-/-
12	A, B	PC	ExOne	F+W	-/-	300004703	ne	-/-	-/-

7.3 Radiated measurements > 18 GHz

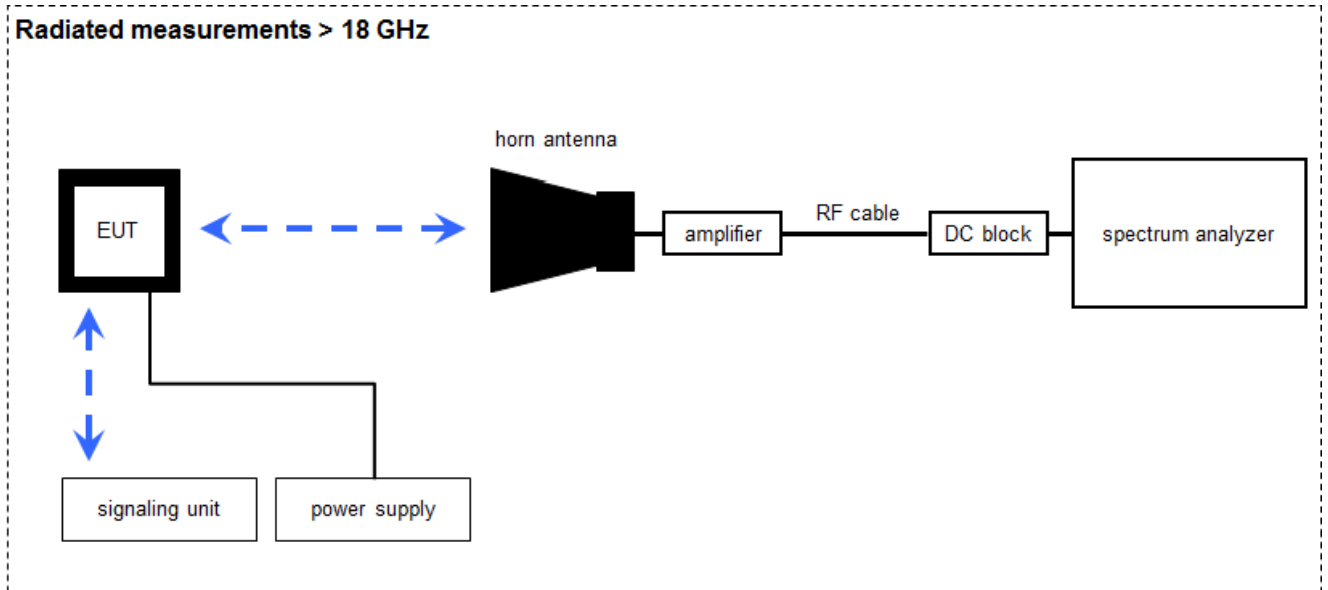

Measurement distance: horn antenna 50 cm

$$FS = UR + CA + AF$$

(FS-field strength; UR-voltage at the receiver; CA-loss signal path & distance correction; AF-antenna factor)

Example calculation:

$$FS [dB\mu V/m] = 40.0 [dB\mu V/m] + (-60.1) [dB] + 36.74 [dB/m] = 16.64 [dB\mu V/m] (6.79 \mu V/m)$$

Equipment table:

No.	Lab / Item	Equipment	Type	Manufacturer	Serial No.	INV. No.	Kind of Calibration	Last Calibration	Next Calibration
1	A	Amplifier 2-40 GHz	JS32-02004000-57-5P	MITEQ	1777200	300004541	ev	-/-	-/-
2	A	RF-Cable	ST18/SMAM/SMAM/48	Huber & Suhner	Batch no. 600918	400001182	ev	-/-	-/-
3	A	RF-Cable	ST18/SMAM/SMAM/48	Huber & Suhner	Batch no. 127377	400001183	ev	-/-	-/-
4	A	DC-Blocker 0.1-40 GHz	8141A	Inmet	-/-	400001185	ev	-/-	-/-
5	A	Std. Gain Horn Antenna 18.0-26.5 GHz	638	Narda	-/-	300000486	k	13.12.2017	12.12.2019
6	A	Signal Analyzer 40 GHz	FSV40	R&S	101042	300004517	k	16.01.2018	15.01.2019

7.4 Conducted measurements

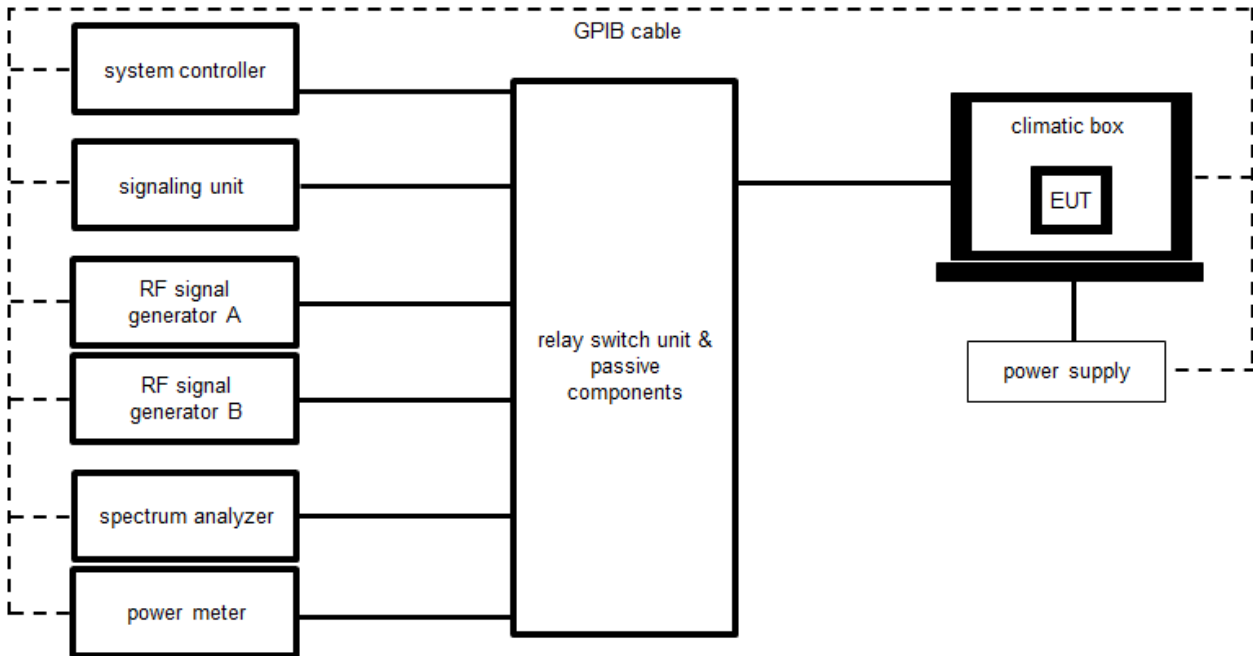

OP = AV + CA
(OP-output power; AV-analyzer value; CA-loss signal path)

Example calculation:

$$OP \text{ [dBm]} = 6.0 \text{ [dBm]} + 11.7 \text{ [dB]} = 17.7 \text{ [dBm]} \text{ (58.88 mW)}$$

Equipment table:

No.	Lab / Item	Equipment	Type	Manufacturer	Serial No.	INV. No.	Kind of Calibration	Last Calibration	Next Calibration
1	A	USB/GPIB interface	82357B	Agilent Technologies	MY52103346	300004390	ne	-/-	-/-
2	A	PC	Exone	F+W		300004179	ne	-/-	-/-
3	A	Spectrum Analyzer	FSV30	Rohde & Schwarz	103809	300005359	k	04.04.2017	03.04.2019
4	A	Relay Switch Matrix	RSM-1	CTC	1	400001355	ev	07.02.2018	06.02.2019
5	A	RF-Cable	ST18/SMAm/SMAm/48	Huber & Suhner	Batch no. 699866	400001189	k	-/-	-/-
6	A	RF-Cable	ST18/SMAm/SMAm/48	Huber & Suhner	Batch no. 14844	400001190	k	-/-	-/-

7.5 AC conducted

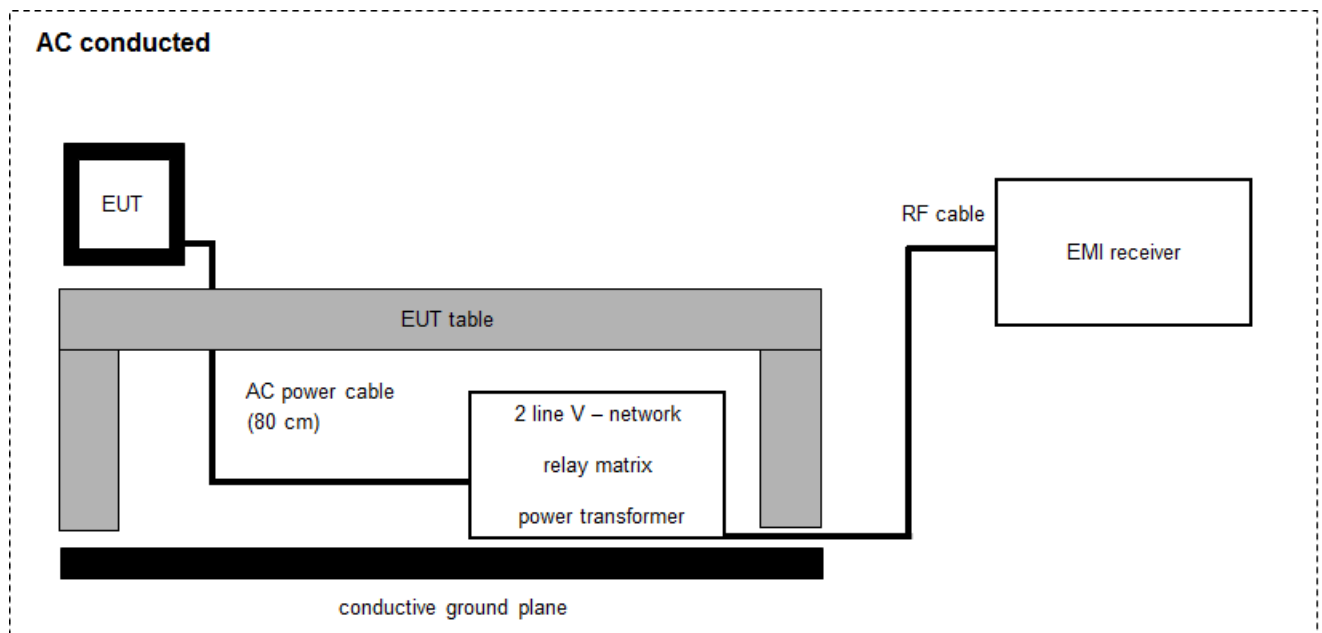

$$FS = UR + CF + VC$$

(FS-field strength; UR-voltage at the receiver; CR-loss of the cable and filter; VC-correction factor of the ISN)

Example calculation:

$$FS [dB\mu V/m] = 37.62 [dB\mu V/m] + 9.90 [dB] + 0.23 [dB] = 47.75 [dB\mu V/m] \quad (244.06 \mu V/m)$$

Equipment table:

No.	Lab / Item	Equipment	Type	Manufacturer	Serial No.	INV. No.	Kind of Calibration	Last Calibration	Next Calibration
1	A	Two-line V-Network (LISN) 9 kHz to 30 MHz	ESH3-Z5	R&S	892475/017	300002209	k	13.12.2017	12.12.2019
2	A	RF-Filter-section	85420E	HP	3427A00162	300002214	k	-/-	-/-
3	A	AC-Spannungsquelle variabel	MV2616-V	EM-Test	0397-12	300003259	k	26.01.2018	26.01.2020
4	A	Hochpass 150 kHz	EZ-25	R&S	100010	300003798	ev	-/-	-/-
5	A	MXE EMI Receiver 20 Hz to 26,5 GHz	N9038A	Agilent Technologies	MY51210197	300004405	k	18.12.2017	17.12.2018

7.6 Shielded fully anechoic chamber

OTA – over the air performance

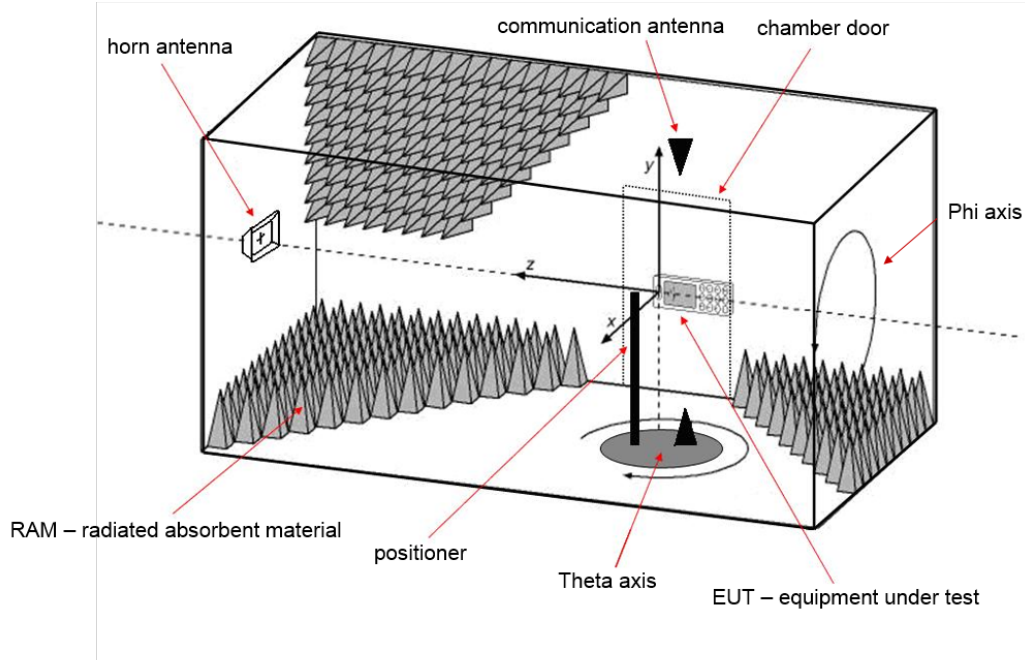

EM Quest software version: 1.0.7.0

$$OP = AV + D - G + CA$$

(OP-radiated output power; AV-analyzer value; D-free field attenuation of measurement distance; G-antenna gain+amplifier gain; CA-loss signal path)

Example calculation:

$$OP \text{ [dBm]} = -40.0 \text{ [dBm]} + 49.9 \text{ [dB]} - 12.4 \text{ [dBi]} + 9 \text{ [dB]} = 6.5 \text{ [dBm]} (4.47 \text{ mW})$$

Equipment table:

No.	Lab / Item	Equipment	Type	Manufacturer	Serial No.	INV. No.	Kind of Calibration	Last Calibration	Next Calibration
1	A	Splitter	15542	Mini Circuits	15542	400000086	ev	-/-	-/-
2	A	Splitter	42000	Anaren	4730	400000085	ev	-/-	-/-
3	A	Switch Unit	TS-RSP	R&S	100155	300003281	ev	-/-	-/-
4	A	CTIA-Chamber	CTIA-Chamber AMS 8500	ETS-Lindgren Finland	-/-	300003327	ne	-/-	-/-
5	A	CTIA-Chamber – Positioning Equipment	CTIA-Chamber – Positioning Equipment	EMCO/2	-/-	300003328	ne	-/-	-/-
6	A	CTIA-Chamber – Software	CTIA-Chamber – Software	EMCO/2	-/-	300003328	ne	-/-	-/-
7	A	CTIA-Chamber – Antenna	3164-04	EMCO/2	00041915	300003328	ne	-/-	-/-
8	A	Spectrum Analyzer 9kHz – 30 GHz	FSP30	R&S	100623	300003464	vKI!	01.02.2017	31.01.2019
9	A	Hygro-Thermometer	5-45 C, 20-100 rF	Thies Clima	-/-	400000089	ev	-/-	-/-

8 Measurement uncertainty

Measurement uncertainty	
Test case	Uncertainty
Antenna gain	± 3 dB
Spectrum bandwidth	± 21.5 kHz absolute; ± 15.0 kHz relative
Maximum output power	± 1 dB
Detailed conducted spurious emissions @ the band edge	± 1 dB
Band edge compliance radiated	± 3 dB
Band edge compliance conducted	± 1.5 dB
Spurious emissions conducted	± 3 dB
Spurious emissions radiated below 30 MHz	± 3 dB
Spurious emissions radiated 30 MHz to 1 GHz	± 3 dB
Spurious emissions radiated 1 GHz to 12.75 GHz	± 3.7 dB
Spurious emissions radiated above 12.75 GHz	± 4.5 dB
Spurious emissions conducted below 30 MHz (AC conducted)	± 2.6 dB

9 Summary of measurement results

<input checked="" type="checkbox"/>	No deviations from the technical specifications were ascertained
<input type="checkbox"/>	There were deviations from the technical specifications ascertained
<input type="checkbox"/>	This test report is only a partial test report. The content and verdict of the performed test cases are listed below.

TC Identifier	Description	Verdict	Date	Remark
RF-Testing	CFR Part 15 RSS – 247, Issue 2	See table!	2018-11-16	-/-

Test specification clause	Test case	Guideline	Temperature conditions	Power source voltages	Mode	C	NC	NA	NP	Remark
§15.247(b)(4) RSS – 247 / 5.4 (4)	System gain	-/-	Nominal	Nominal	GFSK	<input checked="" type="checkbox"/>	<input type="checkbox"/>	<input type="checkbox"/>	<input type="checkbox"/>	-/-
§15.247(c) RSS – 247 / 5.2 (b)	Power spectral density	KDB 558074 DTS clause: 10.6	Nominal	Nominal	GFSK	<input checked="" type="checkbox"/>	<input type="checkbox"/>	<input type="checkbox"/>	<input type="checkbox"/>	-/-
§15.247(a)(2) RSS – 247 / 5.2 (a)	DTS bandwidth – 6 dB bandwidth	KDB 558074 DTS clause: 8.1	Nominal	Nominal	GFSK	<input checked="" type="checkbox"/>	<input type="checkbox"/>	<input type="checkbox"/>	<input type="checkbox"/>	-/-
RSS Gen clause 4.6.1	Occupied bandwidth	-/-	Nominal	Nominal	GFSK	<input checked="" type="checkbox"/>	<input type="checkbox"/>	<input type="checkbox"/>	<input type="checkbox"/>	-/-
§15.247(b)(3) RSS – 247 / 5.4 (4)	Maximum output power	KDB 558074 DTS clause: 9.1.1	Nominal	Nominal	GFSK	<input checked="" type="checkbox"/>	<input type="checkbox"/>	<input type="checkbox"/>	<input type="checkbox"/>	-/-
§15.247(d) RSS – 247 / 5.5	Detailed spurious emissions @ the band edge – conducted	-/-	Nominal	Nominal	GFSK	<input checked="" type="checkbox"/>	<input type="checkbox"/>	<input type="checkbox"/>	<input type="checkbox"/>	-/-
§15.205 RSS – 247 / 5.5 RSS – Gen	Band edge compliance cond. & rad.	KDB 558074 DTS clause: 13.3.2 and clause 12.2.2	Nominal	Nominal	GFSK	<input checked="" type="checkbox"/>	<input type="checkbox"/>	<input type="checkbox"/>	<input type="checkbox"/>	-/-
§15.247(d) RSS – 247 / 5.5	TX spurious emissions conducted	KDB 558074 DTS clause: 11.1 & 11.2 11.3	Nominal	Nominal	GFSK	<input checked="" type="checkbox"/>	<input type="checkbox"/>	<input type="checkbox"/>	<input type="checkbox"/>	-/-
§15.209(a) RSS – Gen	Spurious emissions radiated below 30 MHz	-/-	Nominal	Nominal	GFSK	<input checked="" type="checkbox"/>	<input type="checkbox"/>	<input type="checkbox"/>	<input type="checkbox"/>	-/-
15.247(d) RSS – 247 / 5.5 §15.109 RSS – Gen	Spurious emissions radiated 30 MHz to 1 GHz	-/-	Nominal	Nominal	GFSK RX mode	<input checked="" type="checkbox"/>	<input type="checkbox"/>	<input type="checkbox"/>	<input type="checkbox"/>	-/-
§15.247(d) RSS – 247 / 5.5 §15.109 RSS – Gen	Spurious emissions radiated above 1 GHz	-/-	Nominal	Nominal	GFSK RX mode	<input checked="" type="checkbox"/>	<input type="checkbox"/>	<input type="checkbox"/>	<input type="checkbox"/>	-/-
§15.107(a) §15.207	Conducted emissions below 30 MHz (AC conducted)	-/-	Nominal	Nominal	GFSK	<input checked="" type="checkbox"/>	<input type="checkbox"/>	<input type="checkbox"/>	<input type="checkbox"/>	-/-

Note: C = Compliant; NC = Not compliant; NA = Not applicable; NP = Not performed

10 Additional comments

- Reference documents: 1-5191_17-01-11_log1_conducted.pdf
- Customer_Questionnaire_1-5191_17-01_Transmitter
- Gate_Presentation_Janus_3
- Special test descriptions: Diversity 2 antenna system:
 During a transmission, only one antenna can be active. Both antenna paths are symmetrical except for a conducted switch. Both paths show the same RF behavior.
 All measurements have been performed with antenna 1 active. In chapters 11.10, 11.11 and 10.12 also one reference measurement was performed with antenna 2 active.
- Configuration descriptions: Lowest channel 0: 2403 MHz
 Middle channel 20: 2443 MHz
 Highest channel 39: 2481 MHz
- Test mode: Special software is used.
 EUT is transmitting pseudo random data by itself
- Antennas and transmit operating modes: Operating mode 1 (single antenna)
- *Equipment with 1 antenna,*
 - *Equipment with 2 diversity antennas operating in switched diversity mode by which at any moment in time only 1 antenna is used,*
 - *Smart antenna system with 2 or more transmit/receive chains, but operating in a mode where only 1 transmit/receive chain is used)*
- Operating mode 2 (multiple antennas, no beamforming)
- *Equipment operating in this mode contains a smart antenna system using two or more transmit/receive chains simultaneously but without beamforming.*
- Operating mode 3 (multiple antennas, with beamforming)
- *Equipment operating in this mode contains a smart antenna system using two or more transmit/receive chains simultaneously with beamforming.
 In addition to the antenna assembly gain (G), the beamforming gain (Y) may have to be taken into account when performing the measurements.*

11 Measurement results

11.1 System gain

Measurement:

The antenna gain of the complete system is calculated by the difference of radiated power in EIRP and the conducted power of the EUT.

Measurement parameters (radiated)	
Detector	Peak
Sweep time	Auto
Resolution bandwidth	3 MHz
Video bandwidth	3 MHz
Span	5 MHz
Trace mode	Max hold
Test setup	See sub clause 7.6 A
Measurement uncertainty	See sub clause 8

Measurement parameters (conducted)	
External result file	1-5191_17-01-11_log1_conducted.pdf Common2G4 Peak Output Power conducted 3MHz_3MHz
Test setup	See sub clause 7.4 A
Measurement uncertainty	See sub clause 8

Limits:

FCC	IC
6 dBi / > 6 dBi output power and power density reduction required	

Results:

T _{nom}	V _{nom}	2403 MHz	2443 MHz	2481 MHz
Conducted power [dBm] Measured with GFSK modulation		8.3	8.4	7.1
Radiated power [dBm] Measured with GFSK modulation		8.3	6.3	7.9
Gain [dBi] Calculated		0.0	-2.1	0.8

11.2 Duty cycle

Measurement parameters	
Detector	Peak
Sweep time	Auto
Resolution bandwidth	3 MHz
Video bandwidth	3 MHz
Span	Zero span
Test setup	See sub clause 7.4 A
Measurement uncertainty	See sub clause 8

Limits:

FCC	IC
-/-	

Plot:

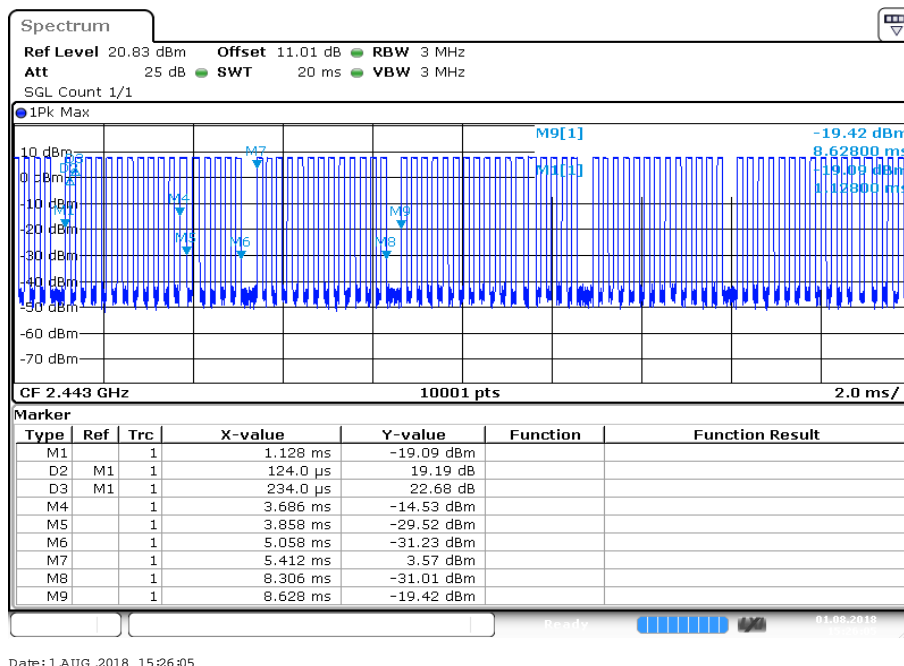

The TX time between M1 and M9 is 3.816 ms.
The idle time between M1 and M9 is 3.876 ms.
This results in a duty cycle of 48.97%

11.3 Power spectral density

Description:

Measurement of the power spectral density of a digital modulated system.

Measurement parameters	
External result file	1-5191_17-01-11_log1_conducted.pdf FCC Part 15.247 Peak Power Spectral Density DTS
Test setup	See sub clause 7.4 A
Measurement uncertainty	See sub clause 8

Limits:

FCC	IC
Power spectral density	
For digitally modulated systems the transmitter power spectral density conducted from the transmitter to the antenna shall not be greater than 8 dBm in any 3 kHz band during any time interval of continuous transmission or over 1.0 second if the transmission exceeds 1.0-second duration.	

Results:

	Frequency		
	2403 MHz	2443 MHz	2481 MHz
Power spectral density [dBm / 3kHz]	-6.0	-5.7	-7.5

11.4 DTS bandwidth – 6 dB bandwidth

Description:

Measurement of the 6 dB bandwidth of the modulated signal.

Measurement parameters	
According to DTS clause: 8.1	
External result file	1-5191_17-01-11_log1_conducted.pdf FCC Part 15.247 Bandwidth 6dB DTS
Test setup	See sub clause 7.4 A
Measurement uncertainty	See sub clause 8

Limits:

FCC	IC
DTS bandwidth – 6 dB bandwidth	
Systems using digital modulation techniques may operate in the 2400–2483.5 MHz band. The minimum 6 dB bandwidth shall be at least 500 kHz.	

Results:

	Frequency		
	2403 MHz	2443 MHz	2481 MHz
6 dB bandwidth [kHz]	865	854	854

11.5 Occupied bandwidth – 99% emission bandwidth

Description:

Measurement of the 99% bandwidth of the modulated signal acc. RSS-GEN.

Measurement parameters	
External result file	1-5191_17-01-11_log1_conducted.pdf FCC Part 15.247 Bandwidth 99PCT
Test setup	See sub clause 7.4 A
Measurement uncertainty	See sub clause 8

Usage:

-/	IC
Occupied bandwidth – 99% emission bandwidth	
OBW is necessary for emission designator	

Results:

	Frequency		
	2403 MHz	2443 MHz	2481 MHz
99% bandwidth [kHz]	1359	1354	1357

11.6 Maximum output power

Description:

Measurement of the maximum output power conducted. EUT in single channel mode.

Measurement parameters	
External result file	1-5191_17-01-11_log1_conducted.pdf FCC Part 15.247 Maximum Peak Conducted Output Power DTS
Test setup	See sub clause 7.4 A
Measurement uncertainty	See sub clause 8

Limits:

FCC	IC
Maximum output power	
Conducted: 1.0 W – antenna gain max. 6 dBi	

Results:

	Frequency		
	2403 MHz	2443 MHz	2481 MHz
Maximum output power conducted [dBm]	8.7	8.5	7.3

11.7 Detailed spurious emissions @ the band edge – conducted

Description:

Measurement of the conducted band edge compliance. EUT is measured at the lower and upper band edge in single channel.

Measurement parameters	
External result file	1-5191_17-01-11_log1_conducted.pdf FCC Part 15.247 TX Spurious Conducted
Test setup	See sub clause 7.4 A
Measurement uncertainty	See sub clause 8

Limits:

FCC	IC
In any 100 kHz bandwidth outside the frequency band in which the spread spectrum or digitally modulated intentional radiator is operating, the radio frequency power that is produced by the intentional radiator shall be at least 20 dB below that in the 100 kHz bandwidth within the band that contains the highest level of the desired power, based on either an RF conducted or a radiated measurement. Attenuation below the general limits specified in Section 15.209(a) is not required.	

Results:

Scenario	Spurious band edge conducted [dB]
Lower band edge	> 20 dB
Upper band edge	> 20 dB

11.8 Band edge compliance conducted

Description:

Measurement of the radiated band edge compliance with a conducted test setup.

Measurement parameters	
According to DTS clause: 13.3.2 and clause 12.2.2	
External result file	1-5191_17-01-11_log1_conducted.pdf FCC Part 15.247 Restricted Band Edge Conducted Peak DTS
Test setup	See sub clause 7.4 A
Measurement uncertainty	See sub clause 8

Limits:

FCC	IC
-41.26 dBm	

Results:

	band edge compliance / dBm (gain calculation)
Max. lower band edge power conducted	-57.1
Antenna gain / dBi	0.0
Max. lower band edge power radiated	-57.1
Max. upper band edge power conducted	-52.7
Antenna gain / dBi	0.8
Max. upper band edge power radiated	-51.9

11.9 TX spurious emissions conducted

Description:

Measurement of the conducted spurious emissions in transmit mode. The EUT is set to single channel mode and the transmit frequencies are 2403 MHz, 2443 MHz and 2481 MHz.

Measurement parameters	
External result file	1-5191_17-01-11_log1_conducted.pdf FCC Part 15.247 TX Spurious Conducted
Test setup	See sub clause 7.4 A
Measurement uncertainty	See sub clause 8

Limits:

FCC	IC
TX spurious emissions conducted	
<p>In any 100 kHz bandwidth outside the frequency band in which the spread spectrum or digitally modulated intentional radiator is operating, the radio frequency power that is produced by the intentional radiator shall be at least 20 dB below that in the 100 kHz bandwidth within the band that contains the highest level of the desired power, based on either an RF conducted or a radiated measurement. Attenuation below the general limits specified in Section 15.209(a) is not required</p>	

Results:

TX spurious emissions conducted					
f [MHz]		amplitude of emission [dBm]	limit max. allowed emission power	actual attenuation below frequency of operation [dB]	results
2403		7.6	30 dBm		Operating frequency
All detected emissions are compliant with the -20 dBc limit!			-20 dBc		compliant
2443		7.9	30 dBm		Operating frequency
All detected emissions are compliant with the -20 dBc limit!			-20 dBc		compliant
2481		6.6	30 dBm		Operating frequency
All detected emissions are compliant with the -20 dBc limit!			-20 dBc		compliant

11.10 Spurious emissions radiated below 30 MHz

Description:

Measurement of the radiated spurious emissions in transmit mode below 30 MHz. The EUT is set to single channel mode and the transmit frequencies are 2403 MHz, 2443 MHz and 2481 MHz. The limits are recalculated to a measurement distance of 3 m according the ANSI C63.10.

Measurement parameters	
Detector	Peak / Quasi peak
Sweep time	Auto
Resolution bandwidth	F < 150 kHz: 200 Hz F > 150 kHz: 9 kHz
Video bandwidth	F < 150 kHz: 1 kHz F > 150 kHz: 30 kHz
Span	9 kHz to 30 MHz
Trace mode	Max hold
Test setup	See sub clause 7.2 B
Measurement uncertainty	See sub clause 8

Limits:

FCC		IC
TX spurious emissions radiated below 30 MHz		
Frequency (MHz)	Field strength (dBµV/m)	Measurement distance
0.009 – 0.490	2400/F(kHz)	300
0.490 – 1.705	24000/F(kHz)	30
1.705 – 30.0	30	30

Results:

TX spurious emissions radiated below 30 MHz [dBµV/m]		
F [MHz]	Detector	Level [dBµV/m]
All detected emissions are more than 20 dB below the limit.		

Plots:

Plot 1: 9 kHz to 30 MHz, 2403 MHz, transmit mode, Antenna 1

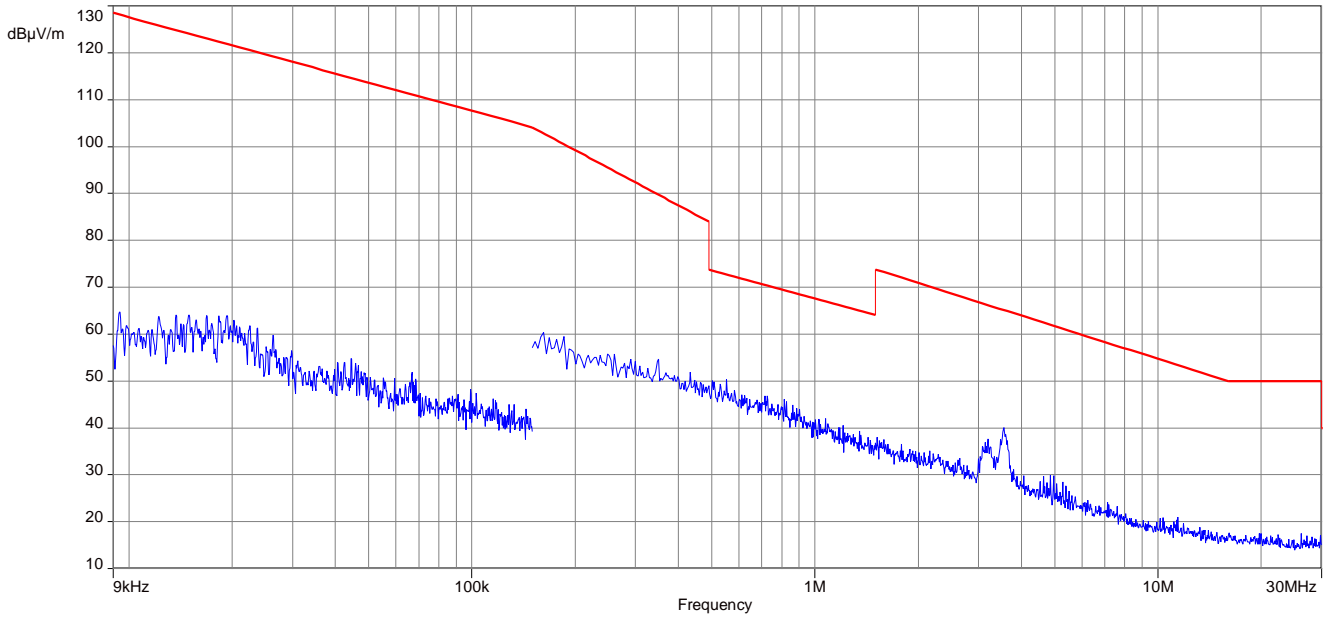

Plot 2: 9 kHz to 30 MHz, 2443 MHz, transmit mode, Antenna 1

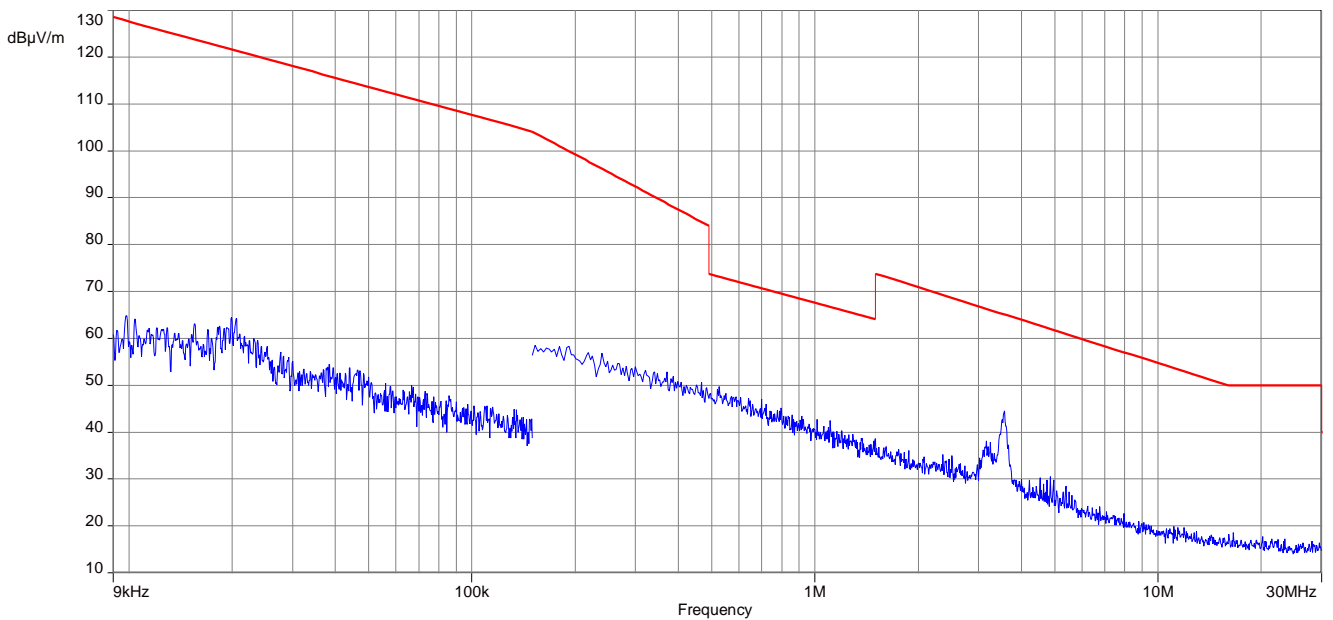

Plot 3: 9 kHz to 30 MHz, 2481 MHz, transmit mode, Antenna 1

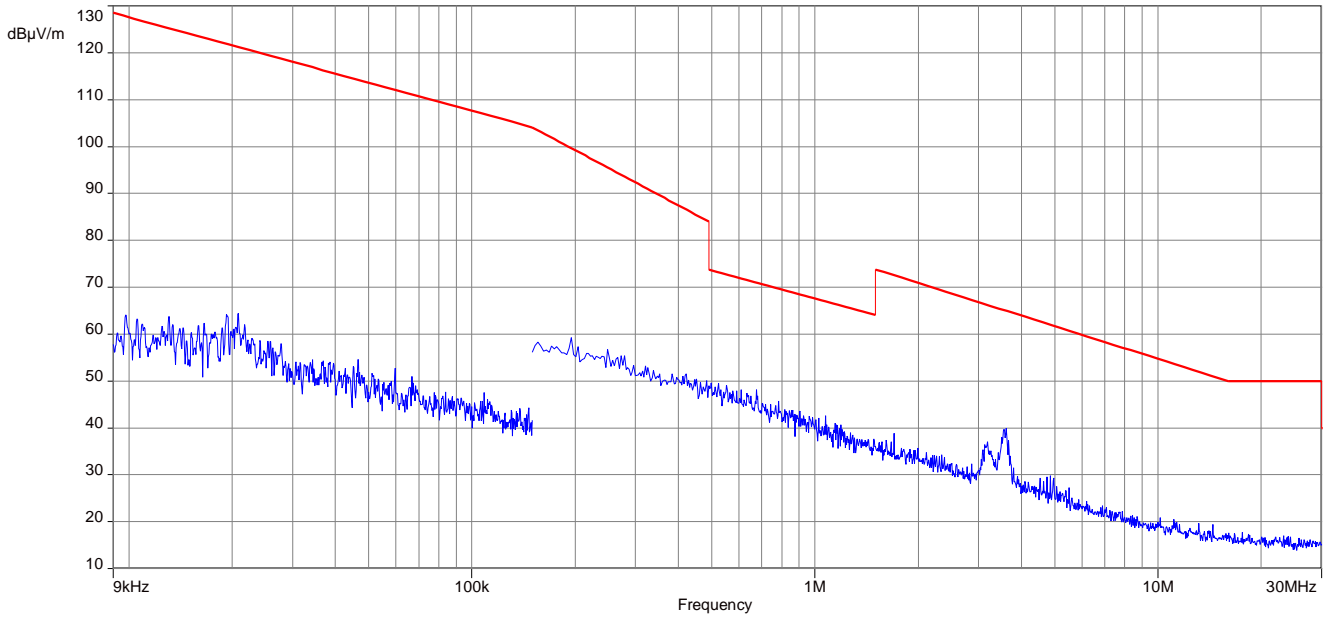

Plot 4: 9 kHz to 30 MHz, 2403 MHz, transmit mode, Antenna 2

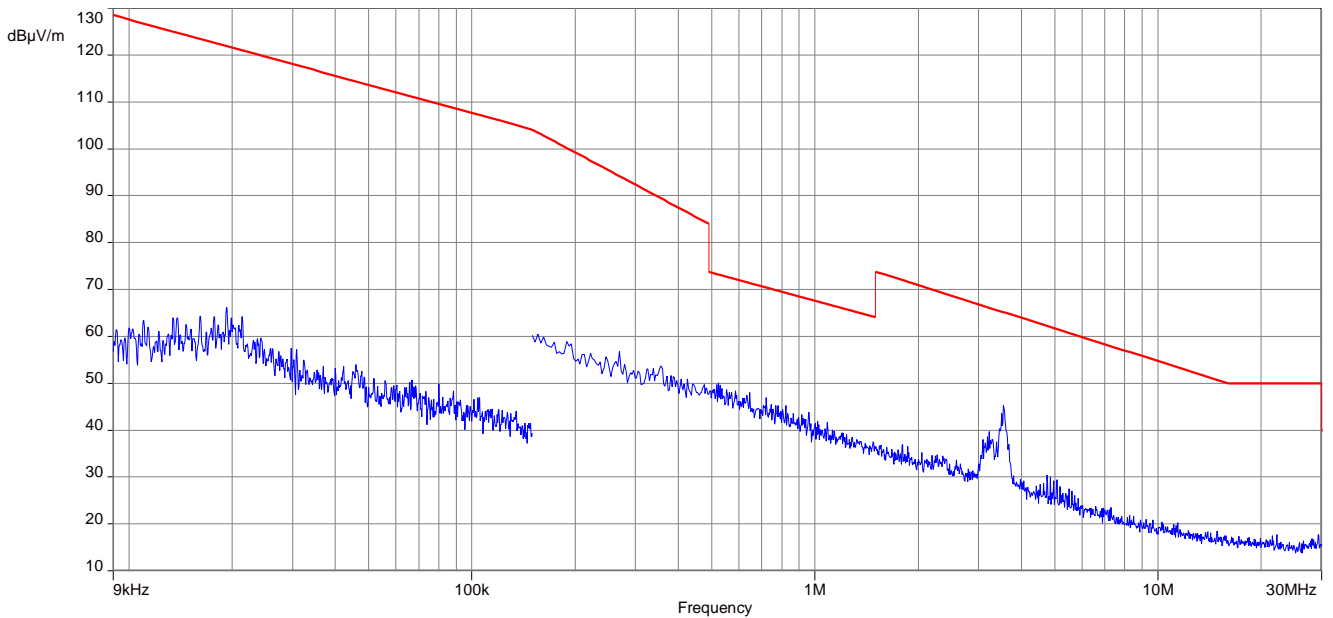

11.11 Spurious emissions radiated 30 MHz to 1 GHz

Description:

Measurement of the radiated spurious emissions in transmit mode. The EUT is set to single channel mode and the transmit frequencies are 2403 MHz, 2443 MHz and 2481 MHz.

Measurement parameters	
Detector	Peak / Quasi Peak
Sweep time	Auto
Resolution bandwidth	120 kHz
Video bandwidth	3 x RBW
Span	30 MHz to 1 GHz
Trace mode	Max hold
Measured modulation	GFSK
Test setup	See sub clause 7.1 A
Measurement uncertainty	See sub clause 8

Limits:

FCC		IC
TX spurious emissions radiated		
In any 100 kHz bandwidth outside the frequency band in which the spread spectrum or digitally modulated intentional radiator is operating, the radio frequency power that is produced by the intentional radiator shall be at least 20 dB below that in the 100 kHz bandwidth within the band that contains the highest level of the desired power, based on either an RF conducted or a radiated measurement. Attenuation below the general limits specified in Section 15.209(a) is not required. In addition, radiated emissions which fall in the restricted bands, as defined in §15.205(a), must also comply with the radiated emission limits specified in §15.209(a) (see §15.205(c)).		
§15.209		
Frequency (MHz)	Field strength (dBµV/m)	Measurement distance
30 – 88	30.0	10
88 – 216	33.5	10
216 – 960	36.0	10
Above 960	54.0	3

Plots: Transmit mode

Plot 1: 30 MHz to 1 GHz, TX mode, 2403 MHz, vertical & horizontal polarization, Antenna 1

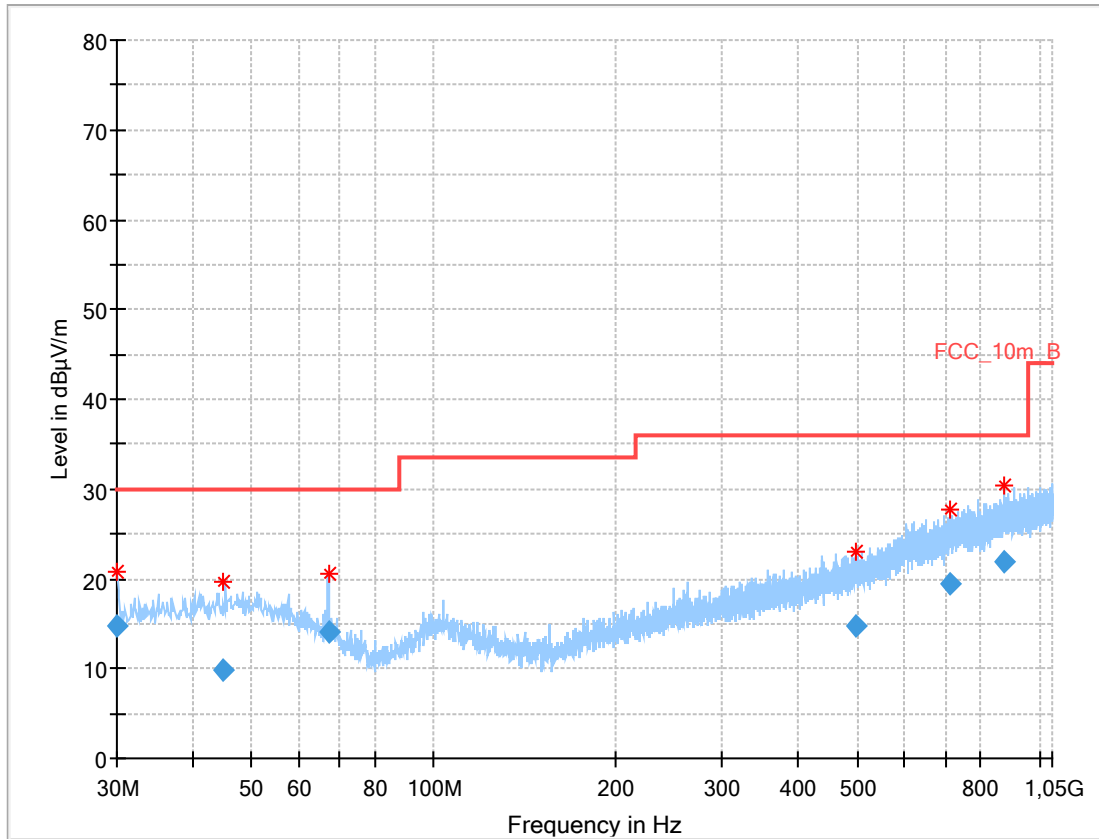

Final results:

Frequency (MHz)	QuasiPeak (dBµV/m)	Limit (dBµV/m)	Margin (dB)	Meas. Time (ms)	Bandwidth (kHz)	Height (cm)	Pol	Azimuth (deg)	Corr. (dB)
30.002	14.71	30.0	15.29	1000	120	101.0	V	0.0	12.1
44.841	9.77	30.0	20.23	1000	120	101.0	V	90.0	13.9
67.113	14.15	30.0	15.85	1000	120	101.0	V	270.0	10.6
497.337	14.68	36.0	21.32	1000	120	170.0	V	0.0	18.7
712.553	19.40	36.0	16.60	1000	120	170.0	V	0.0	22.1
875.061	21.79	36.0	14.21	1000	120	170.0	H	90.0	24.2

Plot 2: 30 MHz to 1 GHz, TX mode, 2443 MHz, vertical & horizontal polarization, Antenna 1

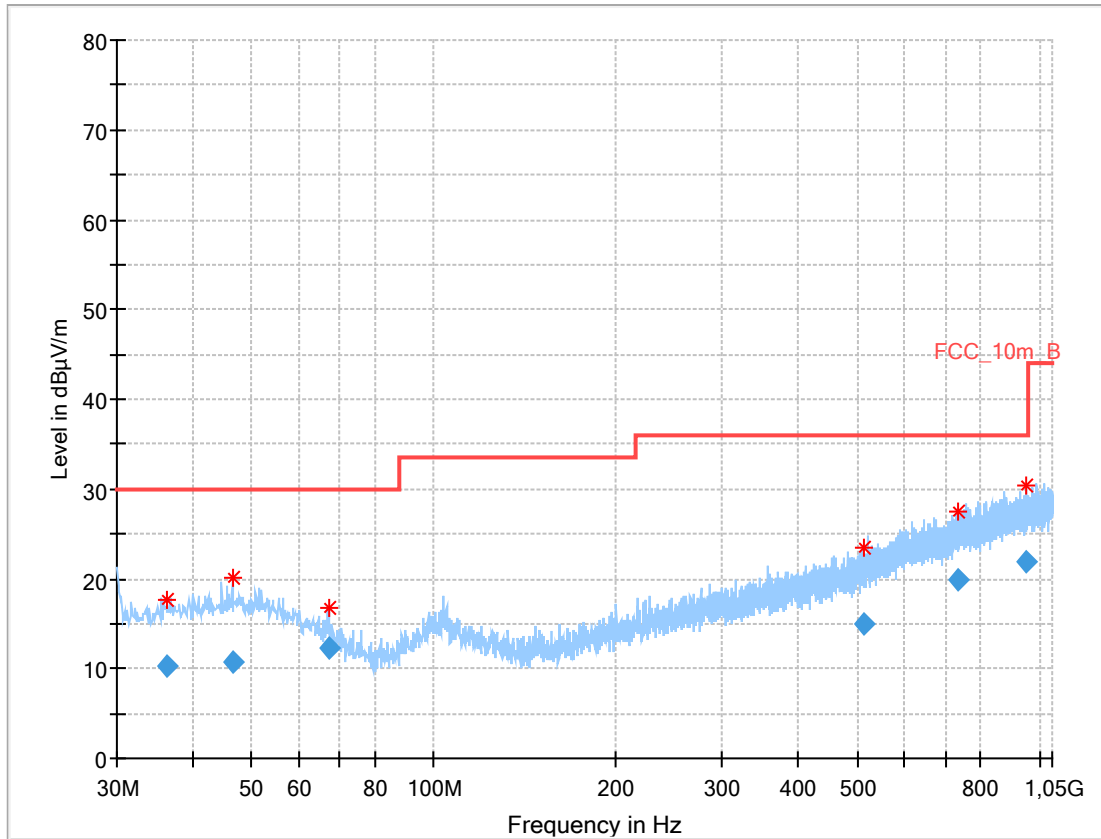

Final results:

Frequency (MHz)	QuasiPeak (dBµV/m)	Limit (dBµV/m)	Margin (dB)	Meas. Time (ms)	Bandwidth (kHz)	Height (cm)	Pol	Azimuth (deg)	Corr. (dB)
36.291	10.24	30.0	19.76	1000	120	101.0	H	90.0	13.1
46.618	10.78	30.0	19.22	1000	120	100.0	H	90.0	14.0
67.284	12.23	30.0	17.77	1000	120	101.0	V	90.0	10.6
514.995	15.05	36.0	20.95	1000	120	101.0	H	270.0	18.9
734.296	19.83	36.0	16.17	1000	120	170.0	H	270.0	22.6
948.908	21.93	36.0	14.07	1000	120	170.0	V	0.0	24.8

Plot 3: 30 MHz to 1 GHz, TX mode, 2481 MHz, vertical & horizontal polarization, Antenna 1

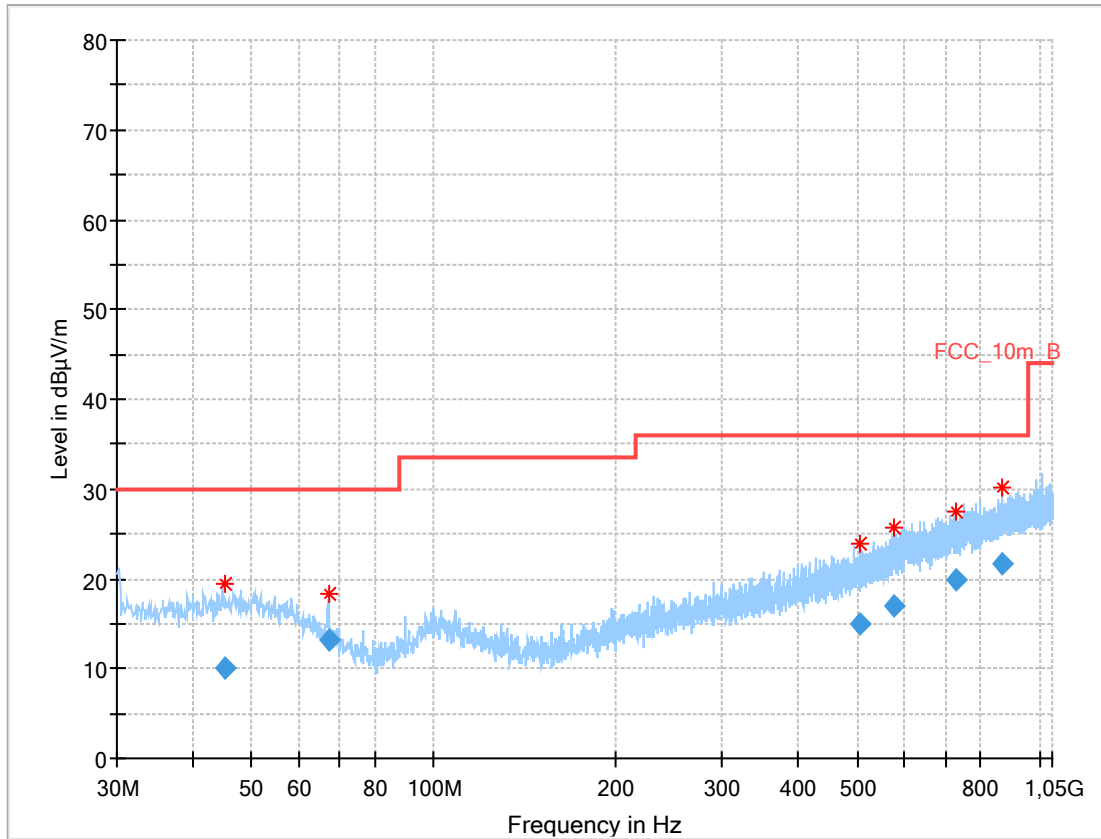

Final results:

Frequency (MHz)	QuasiPeak (dBµV/m)	Limit (dBµV/m)	Margin (dB)	Meas. Time (ms)	Bandwidth (kHz)	Height (cm)	Pol	Azimuth (deg)	Corr. (dB)
45.225	10.10	30.0	19.90	1000	120	101.0	V	90.0	13.9
67.155	13.15	30.0	16.85	1000	120	100.0	V	90.0	10.6
505.049	15.06	36.0	20.94	1000	120	170.0	H	90.0	18.8
573.643	16.90	36.0	19.10	1000	120	101.0	V	270.0	20.2
730.726	19.92	36.0	16.08	1000	120	100.0	H	0.0	22.5
869.706	21.77	36.0	14.23	1000	120	170.0	V	180.0	24.2

Plot 4: 30 MHz to 1 GHz, TX mode, 2403 MHz, vertical & horizontal polarization, Antenna 2

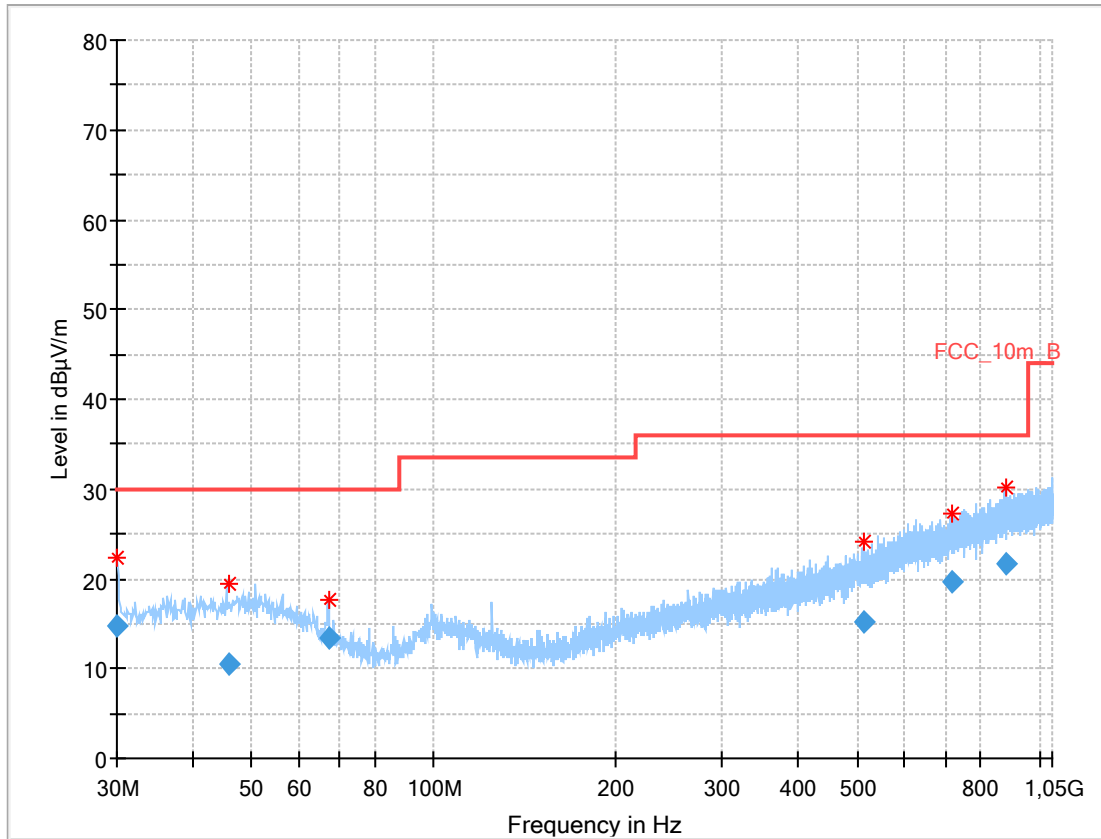

Final results:

Frequency (MHz)	QuasiPeak (dBµV/m)	Limit (dBµV/m)	Margin (dB)	Meas. Time (ms)	Bandwidth (kHz)	Height (cm)	Pol	Azimuth (deg)	Corr. (dB)
30.046	14.67	30.0	15.33	1000	120	105.0	V	180.0	12.1
45.974	10.59	30.0	19.41	1000	120	170.0	V	0.0	13.9
67.022	13.46	30.0	16.54	1000	120	101.0	V	90.0	10.6
512.438	15.17	36.0	20.83	1000	120	170.0	H	90.0	18.9
719.587	19.67	36.0	16.33	1000	120	170.0	H	0.0	22.2
883.412	21.76	36.0	14.24	1000	120	170.0	V	90.0	24.4

Plots: Receiver mode

Plot 1: 30 MHz to 1 GHz, RX / idle – mode, vertical & horizontal polarization, Antenna 1

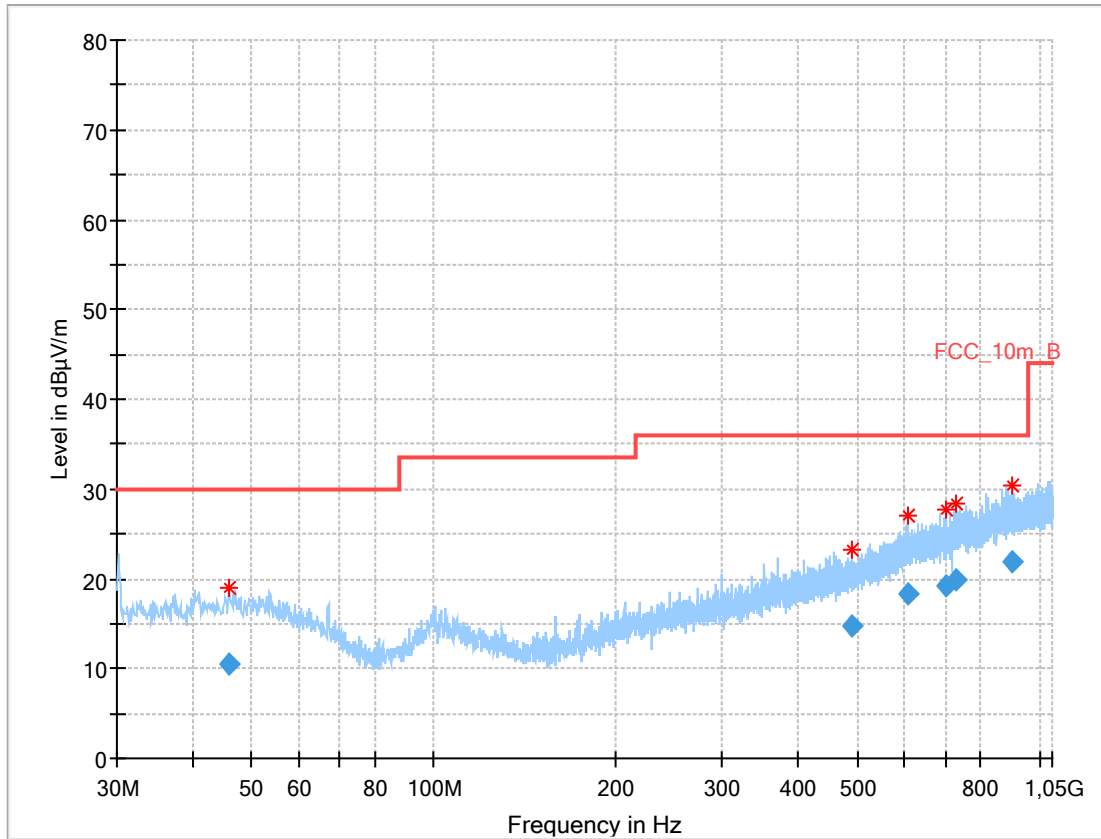

Final results:

Frequency (MHz)	QuasiPeak (dBµV/m)	Limit (dBµV/m)	Margin (dB)	Meas. Time (ms)	Bandwidth (kHz)	Height (cm)	Pol	Azimuth (deg)	Corr. (dB)
45.966	10.56	30.0	19.44	1000	120	100.0	H	270.0	13.9
491.806	14.69	36.0	21.31	1000	120	170.0	H	0.0	18.6
605.217	18.37	36.0	17.63	1000	120	170.0	V	270.0	21.0
700.417	19.14	36.0	16.86	1000	120	170.0	V	90.0	21.8
729.918	19.86	36.0	16.14	1000	120	170.0	H	0.0	22.5
904.734	21.83	36.0	14.17	1000	120	170.0	H	180.0	24.6

11.12 Spurious emissions radiated above 1 GHz

Description:

Measurement of the radiated spurious emissions in transmit mode. The EUT is set to single channel mode and the transmit frequencies are 2403 MHz, 2443 MHz and 2481 MHz.

Measurement parameters	
Detector	Peak / RMS
Sweep time	Auto
Resolution bandwidth	1 MHz
Video bandwidth	3 x RBW
Span	1 GHz to 26 GHz
Trace mode	Max hold
Measured modulation	GFSK
Test setup	See sub clause 7.2 A (1 GHz – 18 GHz) See sub clause 7.3 A (18 GHz – 26 GHz)
Measurement uncertainty	See sub clause 8

Limits:

FCC	IC	
TX spurious emissions radiated		
In any 100 kHz bandwidth outside the frequency band in which the spread spectrum or digitally modulated intentional radiator is operating, the radio frequency power that is produced by the intentional radiator shall be at least 20 dB below that in the 100 kHz bandwidth within the band that contains the highest level of the desired power, based on either an RF conducted or a radiated measurement. Attenuation below the general limits specified in Section 15.209(a) is not required. In addition, radiated emissions which fall in the restricted bands, as defined in §15.205(a), must also comply with the radiated emission limits specified in §15.209(a) (see §15.205(c)).		
§15.209		
Frequency (MHz)	Field strength (dBµV/m)	Measurement distance
Above 960	54.0 (Average)	3
Above 960	74.0 (Peak)	3

Results: Transmitter mode, Antenna 1

TX spurious emissions radiated [dBµV/m]								
2403 MHz			2443 MHz			2481 MHz		
F [MHz]	Detector	Level [dBµV/m]	F [MHz]	Detector	Level [dBµV/m]	F [MHz]	Detector	Level [dBµV/m]
4805	Peak	50.3	4885	Peak	50.4	4961	Peak	50.4
	AVG	39.3		AVG	40.7		AVG	40.6
	Peak			Peak			Peak	
	AVG			AVG			AVG	
	Peak			Peak			Peak	
	AVG			AVG			AVG	

Results: Transmitter mode, Antenna 2

TX spurious emissions radiated [dBµV/m]								
2403 MHz			2443 MHz			2481 MHz		
F [MHz]	Detector	Level [dBµV/m]	F [MHz]	Detector	Level [dBµV/m]	F [MHz]	Detector	Level [dBµV/m]
4805	Peak	50.3		Peak			Peak	
	AVG	40.4		AVG			AVG	
	Peak			Peak			Peak	
	AVG			AVG			AVG	
	Peak			Peak			Peak	
	AVG			AVG			AVG	

Results: Receiver mode, Antenna 1

RX spurious emissions radiated [dBµV/m]		
F [MHz]	Detector	Level [dBµV/m]
All detected emissions are more than 20 dB below the limit.		
	Peak	
	AVG	

Note: The limit was recalculated with 20 dB / decade (Part 15.31) for all radiated spurious emissions 30 MHz to 1 GHz from 3 meter limit to a 10 meter distance. (40dB/decade for emissions < 30MHz)

Plots: Transmitter mode

Plot 1: 1 GHz to 18 GHz, TX mode, 2403 MHz, vertical & horizontal polarization, Antenna 1

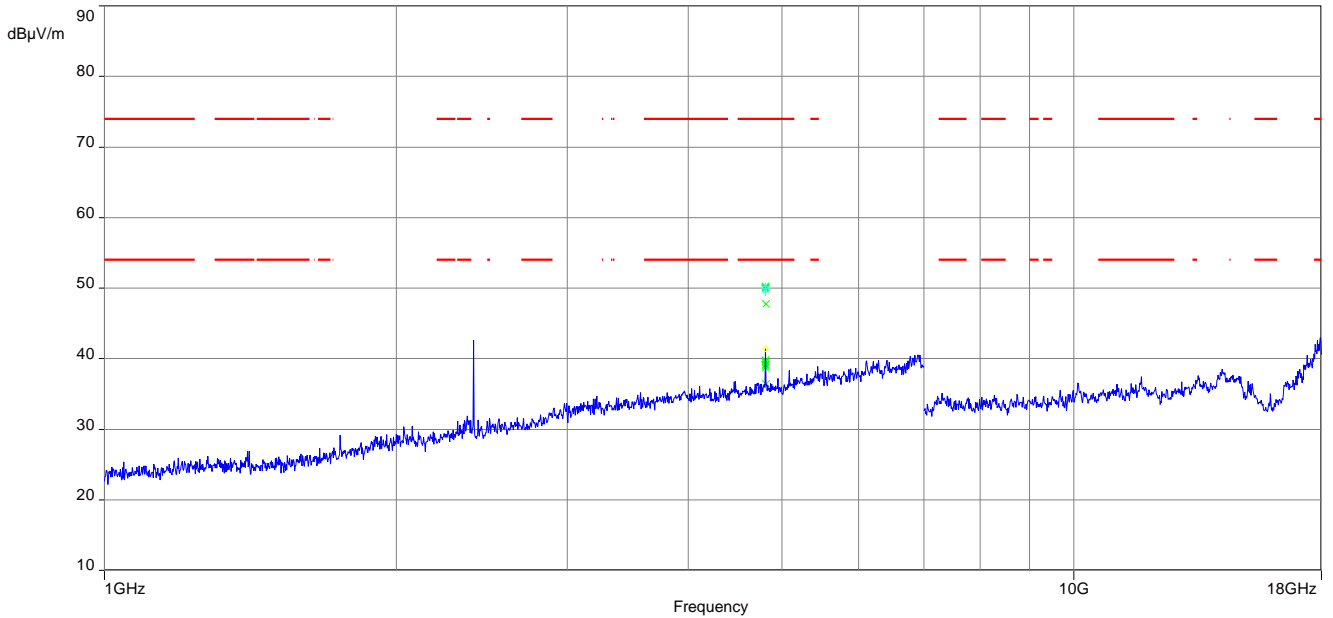

The carrier signal is notched with a 2.4 GHz band rejection filter.

Plot 2: 18 GHz to 26 GHz, TX mode, 2403 MHz, vertical & horizontal polarization, Antenna 1

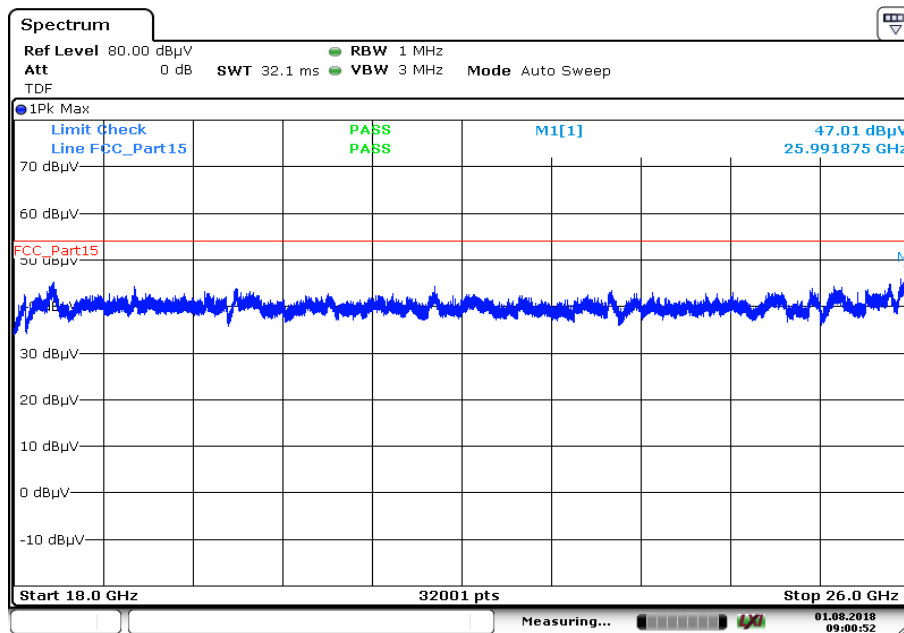

Date: 1.AUG.2018 09:00:52

Plot 3: 1 GHz to 18 GHz, TX mode, 2443 MHz, vertical & horizontal polarization, Antenna 1

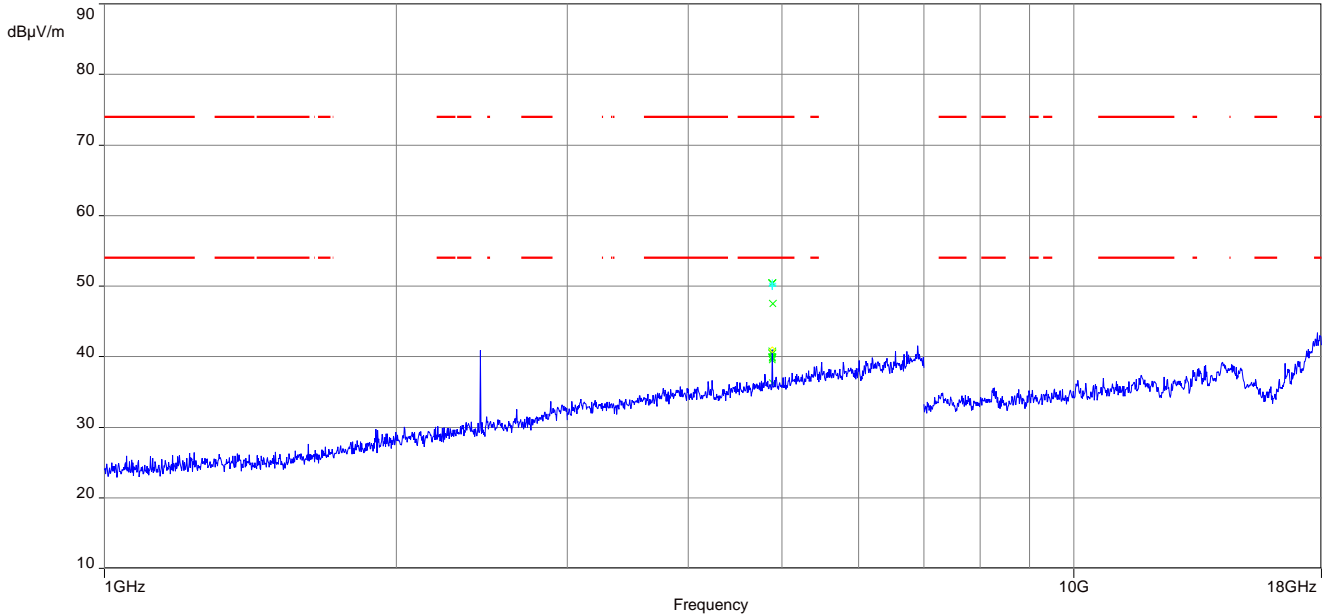

The carrier signal is notched with a 2.4 GHz band rejection filter.

Plot 4: 18 GHz to 26 GHz, TX mode, 2443 MHz, vertical & horizontal polarization, Antenna 1

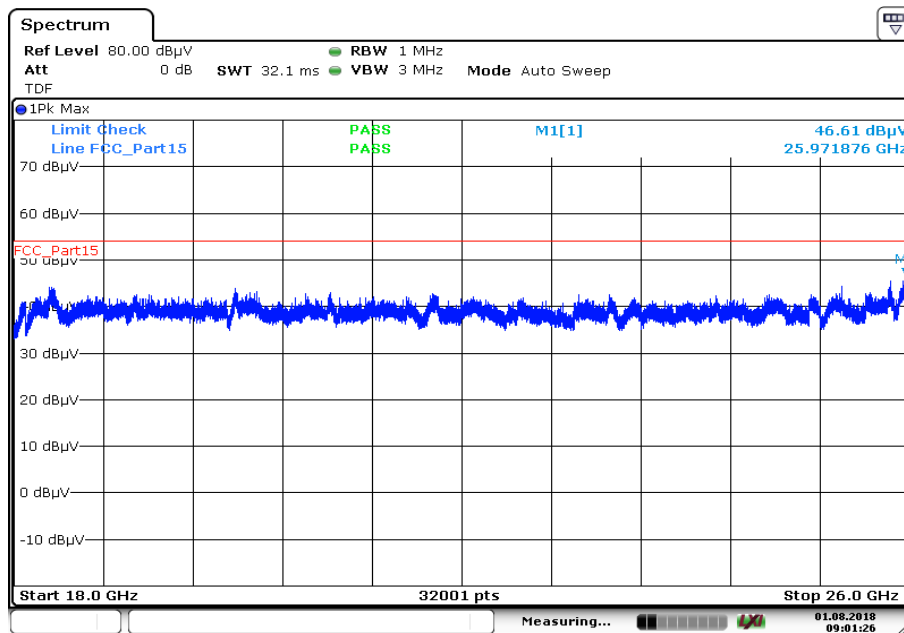

Date: 1.AUG.2018 09:01:26

Plot 5: 1 GHz to 18 GHz, TX mode, 2481 MHz, vertical & horizontal polarization, Antenna 1

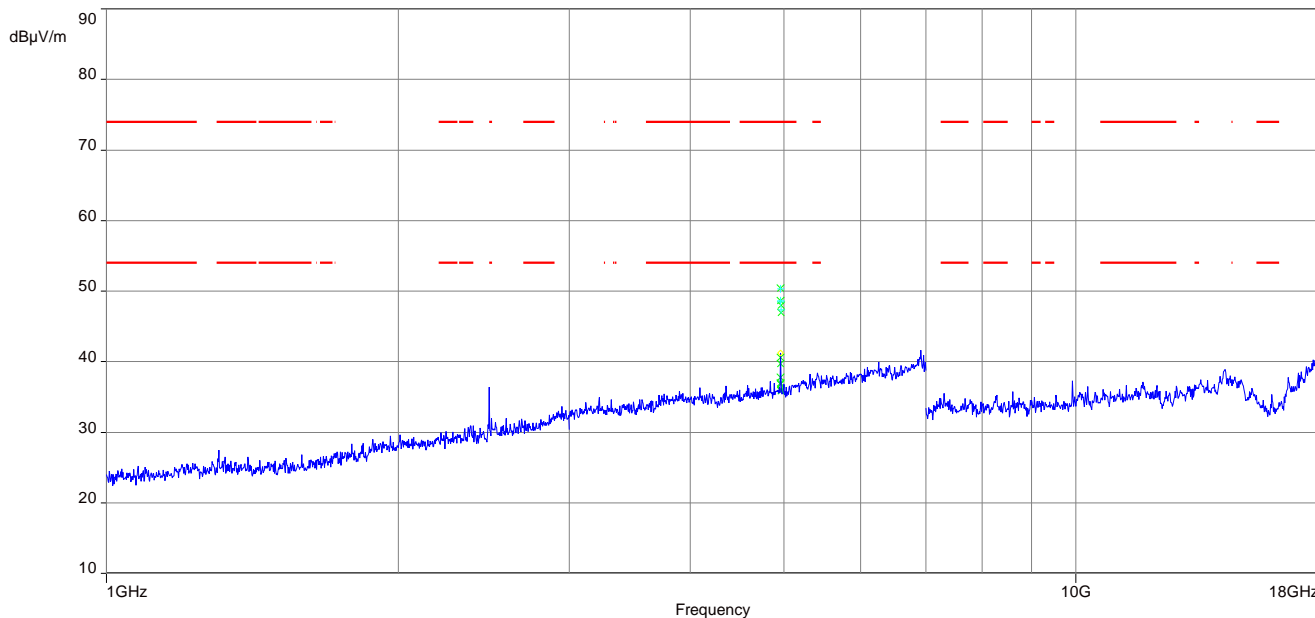

The carrier signal is notched with a 2.4 GHz band rejection filter.

Plot 6: 18 GHz to 26 GHz, TX mode, 2481 MHz, vertical & horizontal polarization, Antenna 1

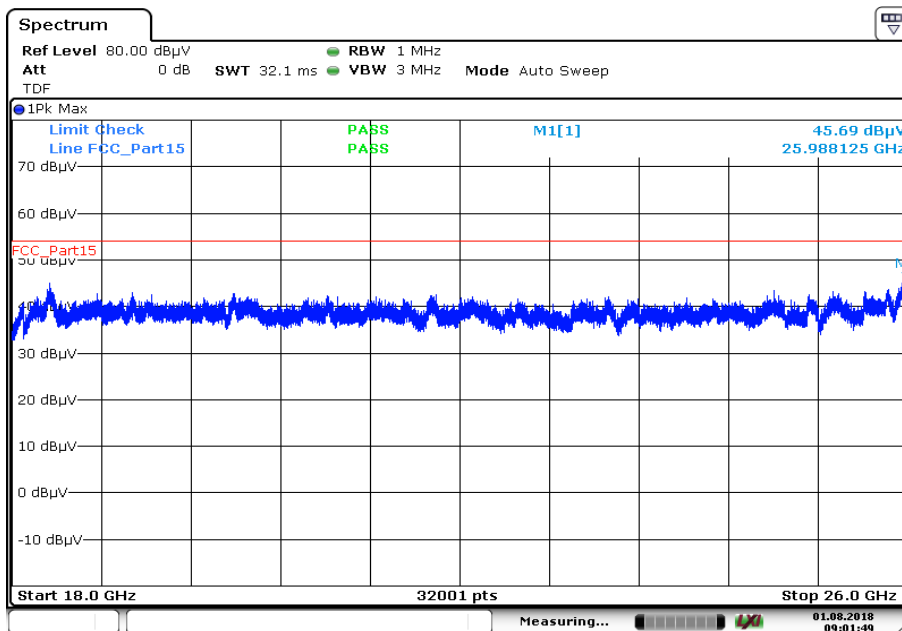

Date: 1.AUG.2018 09:01:49

Plot 7: 1 GHz to 18 GHz, TX mode, 2403 MHz, vertical & horizontal polarization, Antenna 2

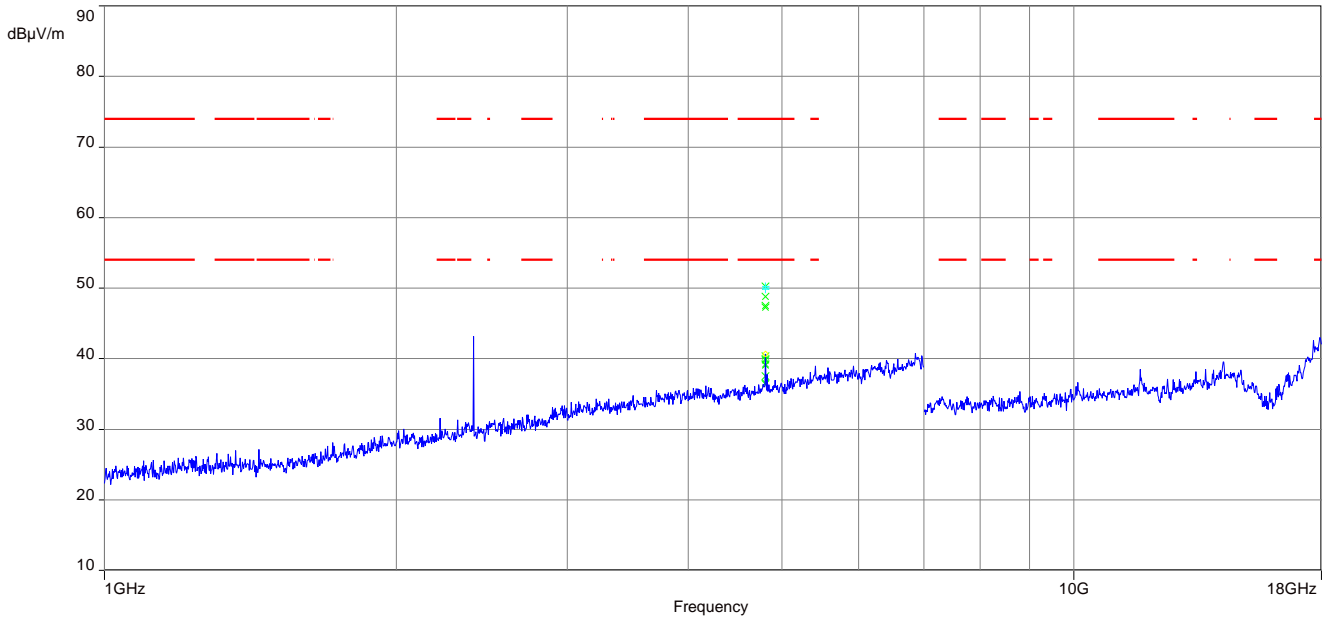

The carrier signal is notched with a 2.4 GHz band rejection filter.

Plot 8: 18 GHz to 26 GHz, TX mode, 2403 MHz, vertical & horizontal polarization, Antenna 2

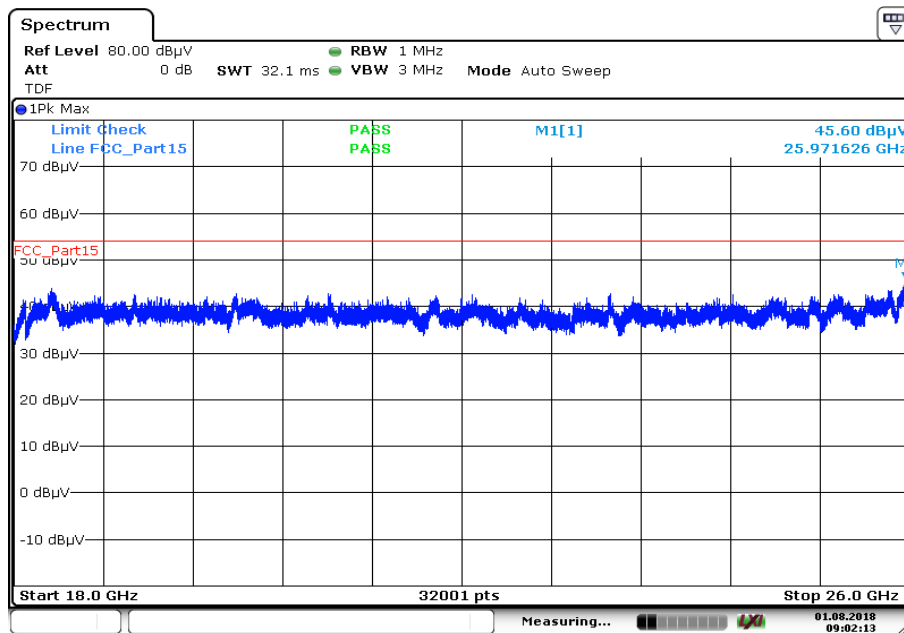

Plots: Receiver mode, Antenna 1

Plot 1: 1 GHz to 18 GHz, RX / idle – mode, vertical & horizontal polarization

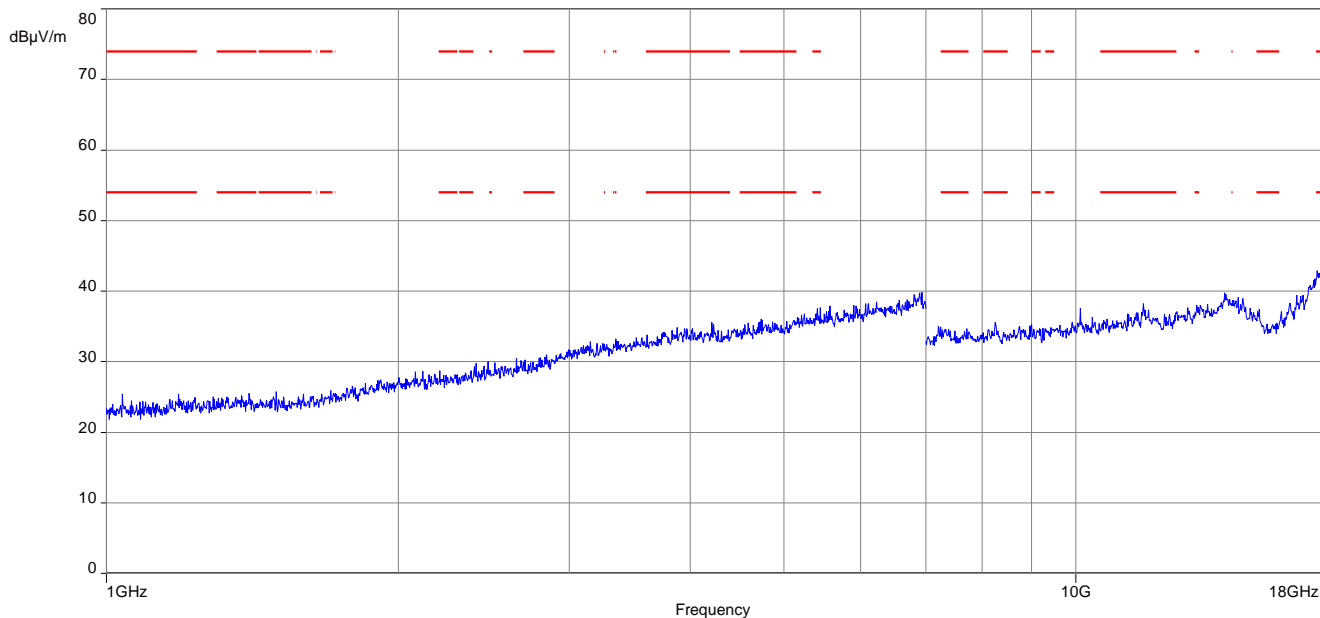

Plot 2: 18 GHz to 26 GHz, RX / idle – mode, vertical & horizontal polarization

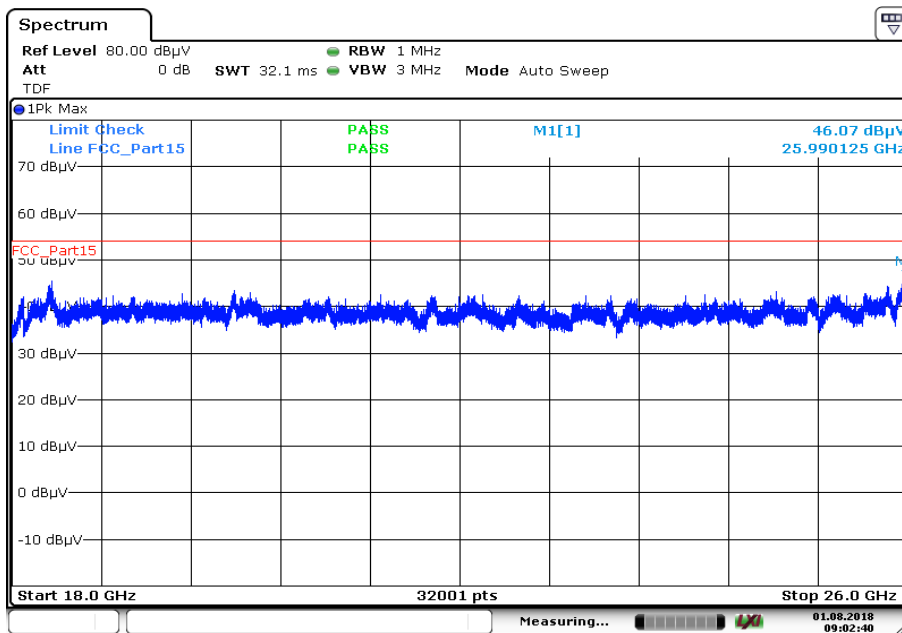

Date: 1.AUG.2018 09:02:40

11.13 Spurious emissions conducted below 30 MHz (AC conducted)

Description:

Measurement of the conducted spurious emissions in transmit mode below 30 MHz. The EUT is set to single channel mode and the transmit frequency is 2443 MHz. This measurement is representative for all channels and modes. If critical peaks are found frequency 2403 MHz and 2481 MHz will be measured too. The measurement is performed in the mode with the highest output power. Both power lines, phase and neutral line, are measured. Found peaks are remeasured with average and quasi peak detection to show compliance to the limits.

Measurement parameters	
Detector	Peak – Quasi peak / average
Sweep time	Auto
Resolution bandwidth	F < 150 kHz: 200 Hz F > 150 kHz: 9 kHz
Video bandwidth	F < 150 kHz: 1 kHz F > 150 kHz: 100 kHz
Span:	9 kHz to 30 MHz
Trace mode:	Max hold
Test setup	See sub clause 7.5. A
Measurement uncertainty	See sub clause 8

Limits:

FCC		IC	
TX spurious emissions conducted < 30 MHz			
Frequency (MHz)	Quasi-peak (dBµV/m)	Average (dBµV/m)	
0.15 – 0.5	66 to 56*	56 to 46*	
0.5 – 5	56	46	
5 – 30.0	60	50	

*Decreases with the logarithm of the frequency

Results:

Spurious emissions conducted < 30 MHz [dBµV/m]		
F [MHz]	Detector	Level [dBµV/m]
No emissions detected		

Plots:

Plot 1: 150 kHz to 30 MHz, phase line

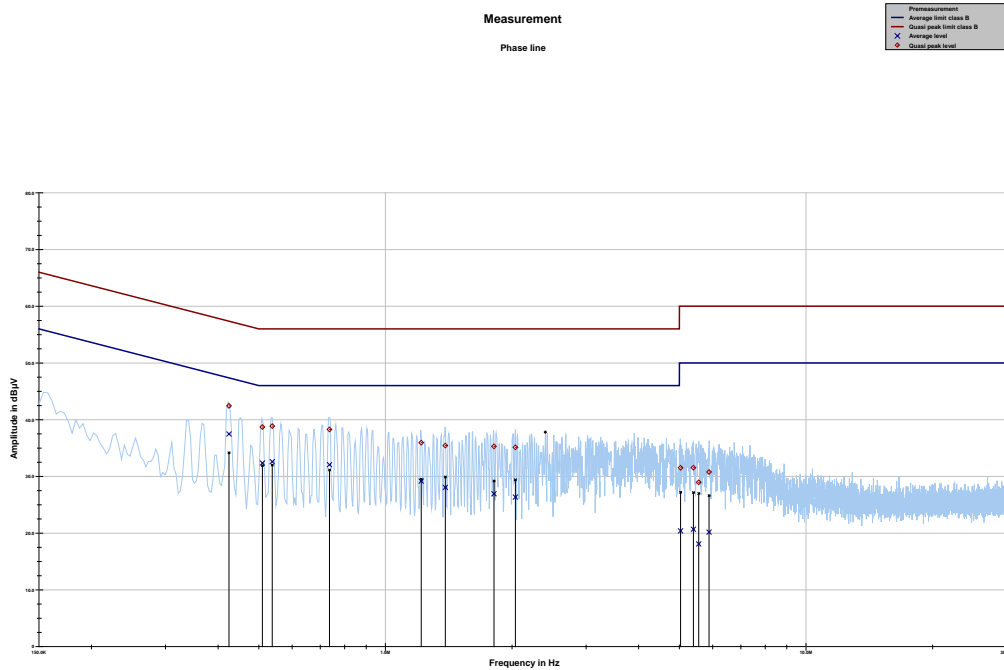

Project ID: 1-5191/17-01-11

Final results:

Frequency	Quasi peak level	Margin quasi peak	Limit QP	Average level	Margin average	Limit AV
MHz	dBµV	dB	dBµV	dBµV	dB	dBµV
0.424598	42.42	14.93	57.358	37.47	10.68	48.154
0.509748	38.70	17.30	56.000	32.36	13.64	46.000
0.538254	38.87	17.13	56.000	32.59	13.41	46.000
0.735965	38.28	17.72	56.000	32.06	13.94	46.000
1.216648	35.94	20.06	56.000	29.16	16.84	46.000
1.387765	35.44	20.56	56.000	28.06	17.94	46.000
1.811503	35.29	20.71	56.000	26.93	19.07	46.000
2.037562	35.13	20.87	56.000	26.34	19.66	46.000
5.032488	31.51	28.49	60.000	20.40	29.60	50.000
5.397163	31.54	28.46	60.000	20.69	29.31	50.000
5.557696	28.95	31.05	60.000	18.09	31.91	50.000
5.880004	30.78	29.22	60.000	20.17	29.83	50.000

Plot 2: 150 kHz to 30 MHz, neutral line

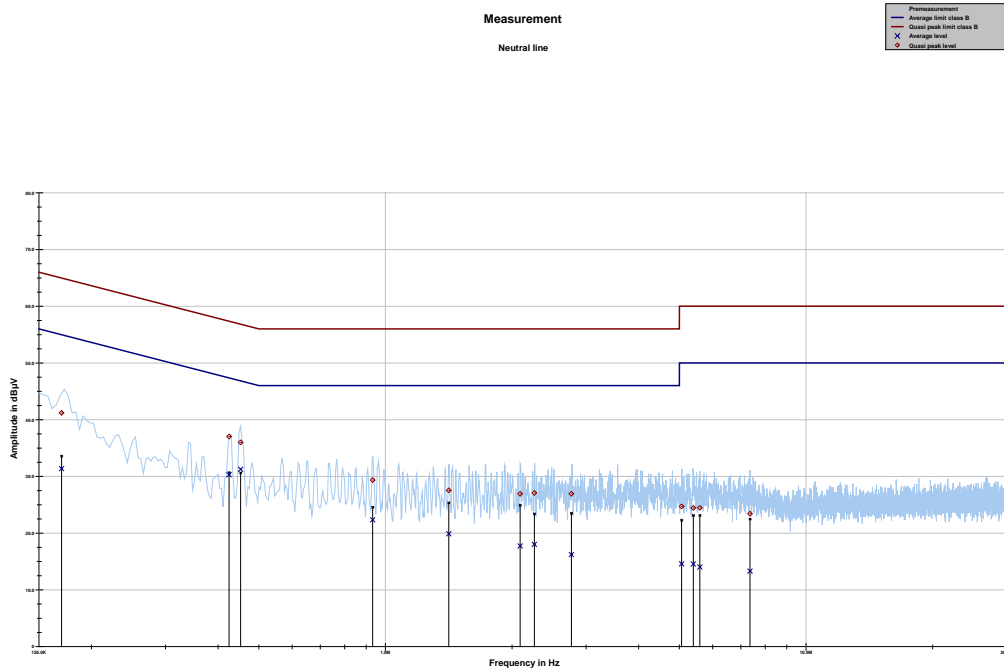

Final results:

Frequency	Quasi peak level	Margin quasi peak	Limit QP	Average level	Margin average	Limit AV
MHz	dBµV	dB	dBµV	dBµV	dB	dBµV
0.169782	41.20	23.77	64.971	31.37	24.06	55.435
0.424741	37.03	20.32	57.355	30.30	17.85	48.150
0.452448	35.99	20.84	56.830	31.26	16.10	47.359
0.932431	29.35	26.65	56.000	22.34	23.66	46.000
1.414382	27.54	28.46	56.000	19.88	26.12	46.000
2.090974	26.93	29.07	56.000	17.73	28.27	46.000
2.260081	27.08	28.92	56.000	18.02	27.98	46.000
2.768012	26.94	29.06	56.000	16.20	29.80	46.000
5.061212	24.71	35.29	60.000	14.59	35.41	50.000
5.396317	24.44	35.56	60.000	14.55	35.45	50.000
5.591484	24.45	35.55	60.000	14.02	35.98	50.000
7.357985	23.41	36.59	60.000	13.30	36.70	50.000

Annex A Glossary

EUT	Equipment under test
DUT	Device under test
UUT	Unit under test
GUE	GNSS User Equipment
ETSI	European Telecommunications Standards Institute
EN	European Standard
FCC	Federal Communications Commission
FCC ID	Company Identifier at FCC
IC	Industry Canada
PMN	Product marketing name
HMN	Host marketing name
HVIN	Hardware version identification number
FVIN	Firmware version identification number
EMC	Electromagnetic Compatibility
HW	Hardware
SW	Software
Inv. No.	Inventory number
S/N or SN	Serial number
C	Compliant
NC	Not compliant
NA	Not applicable
NP	Not performed
PP	Positive peak
QP	Quasi peak
AVG	Average
OC	Operating channel
OCW	Operating channel bandwidth
OBW	Occupied bandwidth
OOB	Out of band
DFS	Dynamic frequency selection
CAC	Channel availability check
OP	Occupancy period
NOP	Non occupancy period
DC	Duty cycle
PER	Packet error rate
CW	Clean wave
MC	Modulated carrier
WLAN	Wireless local area network
RLAN	Radio local area network
DSSS	Dynamic sequence spread spectrum
OFDM	Orthogonal frequency division multiplexing
FHSS	Frequency hopping spread spectrum
GNSS	Global Navigation Satellite System
C/N₀	Carrier to noise-density ratio, expressed in dB-Hz

Annex B Document history

Version	Applied changes	Date of release
-/-	Initial release	2018-09-24
-A	PMN changed	2018-11-09
-B	HVIN, FVIN changed	2018-11-16

Annex C Accreditation Certificate

first page	last page
<p>The first page of the accreditation certificate includes the DAKKS logo, the name 'Deutsche Akkreditierungsstelle GmbH', and accreditation details for CTC advanced GmbH. It states that the laboratory is competent under DIN EN ISO/IEC 17025:2005 for telecommunication tests. A signature is present at the bottom right.</p>	<p>The last page of the certificate lists three office locations: Berlin, Frankfurt am Main, and Braunschweig. It contains additional text regarding the publication of extracts, the scope of accreditation, and the legal basis for the accreditation.</p>

Note: The current certificate annex is published on the website (link see below) of the Accreditation Body DAKKS or may be received by CTC advanced GmbH on request

<https://www.dakks.de/as/ast/d/D-PL-12076-01-03e.pdf>

END OF TEST REPORT