

## FCC Test Report

**Report No.:** RF200618C02

**FCC ID:** DMOHD250BT

**Model No.:** HD 250BT

**Received Date:** Jun. 18, 2020

**Test Date:** Jul. 09 ~ Aug. 13, 2020

**Issued Date:** Aug. 14, 2020

**Applicant:** Sennheiser electronic GmbH & Co. KG

**Address:** Am Labor 1, D-30900 Wedemark, Germany

**Issued By:** Bureau Veritas Consumer Products Services (H.K.) Ltd., Taoyuan Branch  
Lin Kou Laboratories

**Lab Address:** No. 47-2, 14th Ling, Chia Pau Vil., Lin Kou Dist., New Taipei City, Taiwan

**Test Location:** No.19, Hwa Ya 2nd Rd., Wen Hwa Vil., Kwei Shan Dist., Taoyuan City  
33383, Taiwan

**FCC Registration /  
Designation Number:** 788550 / TW0003



This report is for your exclusive use. Any copying or replication of this report to or for any other person or entity, or use of our name or trademark, is permitted only with our prior written permission. This report sets forth our findings solely with respect to the test samples identified herein. The results set forth in this report are not indicative or representative of the quality or characteristics of the lot from which a test sample was taken or any similar or identical product unless specifically and expressly noted. Our report includes all of the tests requested by you and the results thereof based upon the information that you provided to us. You have 60 days from date of issuance of this report to notify us of any material error or omission caused by our negligence, provided, however, that such notice shall be in writing and shall specifically address the issue you wish to raise. A failure to raise such issue within the prescribed time shall constitute your unqualified acceptance of the completeness of this report, the tests conducted and the correctness of the report contents. Unless specific mention, the uncertainty of measurement has been explicitly taken into account to declare the compliance or non-compliance to the specification.

## Table of Contents

<b>Release Control Record</b> .....	<b>4</b>
<b>1 Certificate of Conformity</b> .....	<b>5</b>
<b>2 Summary of Test Results</b> .....	<b>6</b>
2.1 Measurement Uncertainty .....	6
2.2 Modification Record .....	6
<b>3 General Information</b> .....	<b>7</b>
3.1 General Description of EUT .....	7
3.2 Description of Test Modes .....	8
3.2.1 Test Mode Applicability and Tested Channel Detail .....	9
3.3 Description of Support Units .....	10
3.3.1 Configuration of System under Test .....	11
3.4 General Description of Applied Standards and References .....	12
<b>4 Test Types and Results</b> .....	<b>13</b>
4.1 Radiated Emission and Bandedge Measurement .....	13
4.1.1 Limits of Radiated Emission and Bandedge Measurement .....	13
4.1.2 Test Instruments .....	14
4.1.3 Test Procedures .....	15
4.1.4 Deviation from Test Standard .....	15
4.1.5 Test Set Up .....	16
4.1.6 EUT Operating Conditions .....	17
4.1.7 Test Results .....	18
4.2 Conducted Emission Measurement .....	28
4.2.1 Limits of Conducted Emission Measurement .....	28
4.2.2 Test Instruments .....	28
4.2.3 Test Procedures .....	29
4.2.4 Deviation from Test Standard .....	29
4.2.5 Test Setup .....	29
4.2.6 EUT Operating Condition .....	29
4.2.7 Test Results .....	30
4.3 Number of Hopping Frequency Used .....	34
4.3.1 Limits of Hopping Frequency Used Measurement .....	34
4.3.2 Test Setup .....	34
4.3.3 Test Instruments .....	34
4.3.4 Test Procedure .....	34
4.3.5 Deviation from Test Standard .....	34
4.3.6 Test Results .....	35
4.4 Dwell Time on Each Channel .....	36
4.4.1 Limits of Dwell Time on Each Channel Measurement .....	36
4.4.2 Test Setup .....	36
4.4.3 Test Instruments .....	36
4.4.4 Test Procedures .....	36
4.4.5 Deviation from Test Standard .....	36
4.4.6 Test Results .....	37
4.5 Channel Bandwidth .....	39
4.5.1 Limits of Channel Bandwidth Measurement .....	39
4.5.2 Test Setup .....	39
4.5.3 Test Instruments .....	39
4.5.4 Test Procedure .....	39
4.5.5 Deviation from Test Standard .....	39
4.5.6 EUT Operating Condition .....	39
4.5.7 Test Results .....	40
4.6 Occupied Bandwidth Measurement .....	41
4.6.1 Test Setup .....	41

4.6.2	Test Instruments .....	41
4.6.3	Test Procedure .....	41
4.6.4	Deviation from Test Standard .....	41
4.6.5	EUT Operating Conditions .....	41
4.6.6	Test Results .....	42
4.7	Hopping Channel Separation .....	43
4.7.1	Limits of Hopping Channel Separation Measurement .....	43
4.7.2	Test Setup .....	43
4.7.3	Test Instruments .....	43
4.7.4	Test Procedure .....	43
4.7.5	Deviation from Test Standard .....	43
4.7.6	Test Results .....	44
4.8	Maximum Output Power .....	45
4.8.1	Limits of Maximum Output Power Measurement .....	45
4.8.2	Test Setup .....	45
4.8.3	Test Instruments .....	45
4.8.4	Test Procedure .....	45
4.8.5	Deviation from Test Standard .....	45
4.8.6	EUT Operating Condition .....	45
4.8.7	Test Results .....	46
4.9	Conducted Out of Band Emission Measurement .....	47
4.9.1	Limits Of Conducted Out of Band Emission Measurement .....	47
4.9.2	Test Instruments .....	47
4.9.3	Test Procedure .....	47
4.9.4	Deviation from Test Standard .....	47
4.9.5	EUT Operating Condition .....	47
4.9.6	Test Results .....	47
<b>5</b>	<b>Photographs of the Test Configuration .....</b>	<b>52</b>
<b>6</b>	<b>Construction Photos of EUT .....</b>	<b>53</b>
	<b>Appendix – Information of the Testing Laboratories .....</b>	<b>54</b>

### Release Control Record

Issue No.	Description	Date Issued
RF200618C02	Original Release	Aug. 14, 2020

## 1 Certificate of Conformity

**Product Name:** HD 250BT Wireless

**Brand Name:** SENNHEISER

**Model No.:** HD 250BT

**Sample Status:** Engineering Sample

**Applicant:** Sennheiser electronic GmbH & Co. KG

**Test Date:** Jul. 09 ~ Aug. 13, 2020

**Standards:** 47 CFR FCC Part 15, Subpart C (Section 15.247)  
ANSI C63.10:2013

The above equipment has been tested by **Bureau Veritas Consumer Products Services (H.K.) Ltd., Taoyuan Branch**, and found compliance with the requirement of the above standards. The test record, data evaluation & Equipment Under Test (EUT) configurations represented herein are true and accurate accounts of the measurements of the sample's RF characteristics under the conditions specified in this report.

**Prepared by :** Gina Liu, **Date:** Aug. 14, 2020  
Gina Liu / Specialist

**Approved by :** Dylan Chiou, **Date:** Aug. 14, 2020  
Dylan Chiou / Senior Project Engineer

## 2 Summary of Test Results

47 CFR FCC Part 15, Subpart C (Section 15.247)			
FCC Clause	Test Item	Result	Remarks
15.207	AC Power Conducted Emission	Pass	Meet the requirement of limit. Minimum passing margin is -6.17 dB at 0.4628 MHz.
15.247(a)(1)(iii)	Number of Hopping Frequency Used	Pass	Meet the requirement of limit.
15.247(a)(1)(iii)	Dwell Time on Each Channel	Pass	Meet the requirement of limit.
15.247(a)(1)	1. Hopping Channel Separation 2. Spectrum Bandwidth of a Frequency Hopping Sequence Spread Spectrum System	Pass	Meet the requirement of limit.
15.247(a)(1)	Maximum Peak Output Power	Pass	Meet the requirement of limit.
---	Occupied Bandwidth Measurement	Pass	Reference only
15.205 & 209	Radiated Emissions	Pass	Meet the requirement of limit. Minimum passing margin is -7.1 dB at 2483.50 MHz.
15.247(d)	Band Edge Measurement	Pass	Meet the requirement of limit.
15.247(d)	Antenna Port Emission	Pass	Meet the requirement of limit.
15.203	Antenna Requirement	Pass	No antenna connector is used.

### Note:

1. If the Frequency Hopping System operating in 2400-2483.5 MHz band and the output power less than 125 mW. The hopping channel carrier frequencies separated by a minimum of 25 kHz or two-thirds of the 20 dB bandwidth of hopping channel whichever is greater.
2. Determining compliance based on the results of the compliance measurement, not taking into account measurement instrumentation uncertainty.

### 2.1 Measurement Uncertainty

Where relevant, the following measurement uncertainty levels have been estimated for tests performed on the EUT as specified in CISPR 16-4-2:

Measurement	Frequency	Expanded Uncertainty (k=2) (±)
Conducted Emissions at mains ports	150 kHz ~ 30 MHz	2.79 dB
Radiated Emissions up to 1 GHz	9 kHz ~ 30 MHz	3.04 dB
	30 MHz ~ 200 MHz	2.93 dB
	200 MHz ~ 1000 MHz	2.95 dB
Radiated Emissions above 1 GHz	1 GHz ~ 18 GHz	2.26 dB
	18 GHz ~ 40 GHz	1.94 dB

### 2.2 Modification Record

There were no modifications required for compliance.

### 3 General Information

#### 3.1 General Description of EUT

<b>Test Item Description</b>	On-ear headphones
<b>Product Name</b>	HD 250BT Wireless
<b>Brand Name</b>	SENNHEISER
<b>Model No.</b>	HD 250BT
<b>Status of EUT</b>	Engineering Sample
<b>Power Rating</b>	5Vdc, 120 mA (from Type-C USB interface) 3.7Vdc, 190mAh (from battery)
<b>Operating Temperature range</b>	0°C - +40°C
<b>Modulation Type</b>	GFSK, $\pi/4$ -DQPSK, 8DPSK
<b>Transmission Technology</b>	FHSS
<b>Technology</b>	Bluetooth
<b>Operating Frequency</b>	2402 ~ 2480 MHz (for Frequency Band: 2400-2483.5MHz)
<b>Number of Channel</b>	79
<b>Channel Spacing</b>	1MHz
<b>Channel Bandwidth</b>	79MHz
<b>Data Transfer Rate</b>	1Mbps (BDR) & 2Mbps/3Mbps (EDR)
<b>Antenna Type</b>	PCB antenna
<b>Antenna Gain</b>	1.43 dBi
<b>Maximum Output Power</b>	2.443 mW
<b>HW Version</b>	V3.0
<b>SW Version</b>	V2.4.3
<b>Cable Supplied</b>	0.5m shielded USB cable without core

Note:

1. The above Antenna information is declared by manufacturer and for more detailed features description, please refer to the manufacturer's specifications, the laboratory shall not be held responsible.
2. The above EUT information is declared by manufacturer and for more detailed features description, please refers to the manufacturer's specifications or User's Manual.

### 3.2 Description of Test Modes

79 channels are provided to this EUT:

Channel	Freq. (MHz)	Channel	Freq. (MHz)	Channel	Freq. (MHz)	Channel	Freq. (MHz)
0	2402	20	2422	40	2442	60	2462
1	2403	21	2423	41	2443	61	2463
2	2404	22	2424	42	2444	62	2464
3	2405	23	2425	43	2445	63	2465
4	2406	24	2426	44	2446	64	2466
5	2407	25	2427	45	2447	65	2467
6	2408	26	2428	46	2448	66	2468
7	2409	27	2429	47	2449	67	2469
8	2410	28	2430	48	2450	68	2470
9	2411	29	2431	49	2451	69	2471
10	2412	30	2432	50	2452	70	2472
11	2413	31	2433	51	2453	71	2473
12	2414	32	2434	52	2454	72	2474
13	2415	33	2435	53	2455	73	2475
14	2416	34	2436	54	2456	74	2476
15	2417	35	2437	55	2457	75	2477
16	2418	36	2438	56	2458	76	2478
17	2419	37	2439	57	2459	77	2479
18	2420	38	2440	58	2460	78	2480
19	2421	39	2441	59	2461		



### 3.2.1 Test Mode Applicability and Tested Channel Detail

EUT Configure Mode	Applicable To				Description
	RE $\geq$ 1G	RE $<$ 1G	PLC	APCM	
A	√	√	√	√	EUT charging Notebook (Cable 1)
B	-	√	√	-	EUT charging adapter (Cable 2)

Where **RE $\geq$ 1G**: Radiated Emission above 1 GHz      **RE $<$ 1G**: Radiated Emission below 1 GHz  
**PLC**: Power Line Conducted Emission      **APCM**: Antenna Port Conducted Measurement

**Note:**

1. For Radiated emission test, pre-tested GFSK,  $\pi/4$ -DQPSK, 8DPSK modulation type and found GFSK was the worse, therefore chosen for the final test and presented in the test report.
2. The EUT had been pre-tested on the positioned of each 3 axis. The worst case was found when positioned on **X-plane**.
3. "-" means no effect.

**Radiated Emission Test (Above 1 GHz):**

- Pre-Scan has been conducted to determine the worst-case mode from all possible combinations between available modulations, data rates and antenna ports (if EUT with antenna diversity architecture).
- Following channel(s) was (were) selected for the final test as listed below.

EUT Configure Mode	Available Channel	Tested Channel	Modulation Technology	Modulation Type	Packet Type
A	0 to 78	0, 39, 78	FHSS	GFSK	DH5
	0 to 78	0, 39, 78	FHSS	8DPSK	3DH5

**Radiated Emission Test (Below 1 GHz):**

- Pre-Scan has been conducted to determine the worst-case mode from all possible combinations between available modulations, data rates and antenna ports (if EUT with antenna diversity architecture).
- Following channel(s) was (were) selected for the final test as listed below.

EUT Configure Mode	Available Channel	Tested Channel	Modulation Technology	Modulation Type	Packet Type
A, B	0 to 78	78	FHSS	GFSK	DH5

**Power Line Conducted Emission Test:**

- Pre-Scan has been conducted to determine the worst-case mode from all possible combinations between available modulations, data rates and antenna ports (if EUT with antenna diversity architecture).
- Following channel(s) was (were) selected for the final test as listed below.

EUT Configure Mode	Available Channel	Tested Channel	Modulation Technology	Modulation Type	Packet Type
A, B	0 to 78	78	FHSS	GFSK	DH5

**Antenna Port Conducted Measurement:**

- This item includes all test value of each mode, but only includes spectrum plot of worst value of each mode.
- Pre-Scan has been conducted to determine the worst-case mode from all possible combinations between available modulations, data rates and antenna ports (if EUT with antenna diversity architecture).
- Following channel(s) was (were) selected for the final test as listed below.

EUT Configure Mode	Available Channel	Tested Channel	Modulation Technology	Modulation Type	Packet Type
A	0 to 78	0, 39, 78	FHSS	GFSK	DH5
	0 to 78	0, 39, 78	FHSS	8DPSK	3DH5

**Test Condition:**

Applicable To	Environmental Conditions	Input Power	Tested by
RE≥1G	23 deg. C, 65 % RH	120 Vac, 60 Hz	Adair Peng
RE<1G	23 deg. C, 65 % RH	120 Vac, 60 Hz	Adair Peng
PLC	23 deg. C, 67 % RH	120 Vac, 60 Hz	Adair Peng
APCM	25 deg. C, 65 % RH	120 Vac, 60 Hz	Ivan Tseng

**3.3 Description of Support Units**

The EUT has been tested as an independent unit together with other necessary accessories or support units. The following support units or accessories were used to form a representative test configuration during the tests.

No.	Product	Brand	Model No.	Serial No.	FCC ID
A.	Bluetooth Tester	R&S	CBT	100980	N/A
B.	Notebook	ASUS	X571G	L1N0CX017583018	PD99560NG
C.	Adapter	LITEON	PA-1050-39	N/A	N/A

No.	Descriptions	Qty.	Length (m)	Shielding (Yes/No)	Cores (Qty.)	Remarks
1.	USB Cable	1	1.0	Y	0	Provided by Lab
2.	USB Cable	1	0.5	Y	0	Accessory of EUT

Note:

1. All power cords of the above support units are non-shielded (1.8m).
2. Item A acted as communication partners to transfer data.
3. Item 2 USB Cable only for charging.

### 3.3.1 Configuration of System under Test

#### Mode A

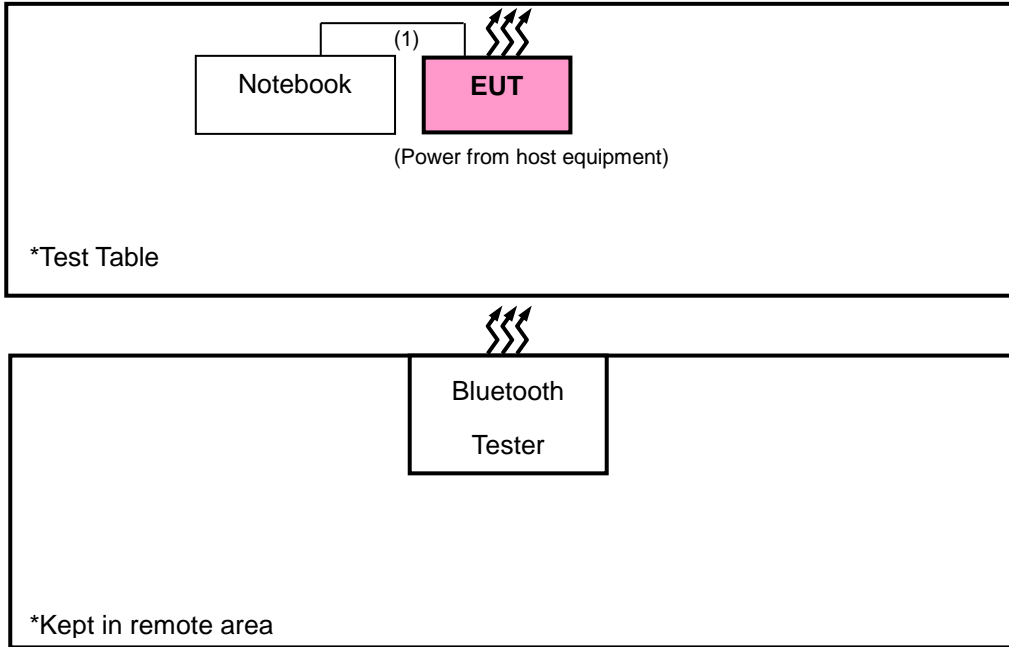

#### Mode B

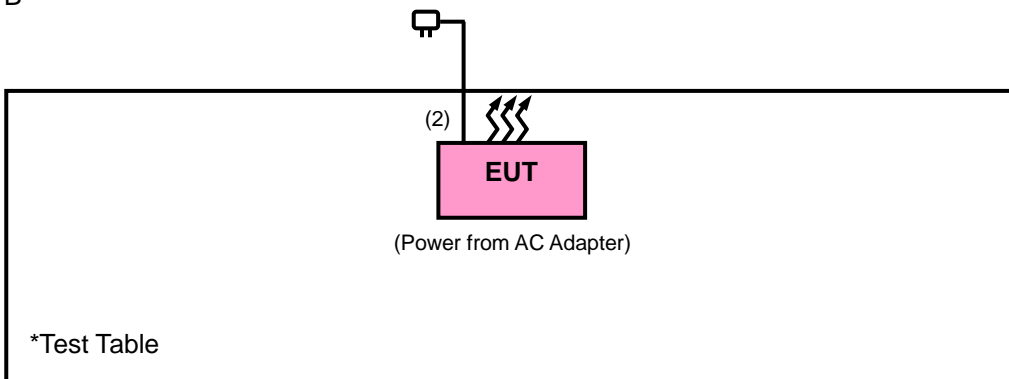

### **3.4 General Description of Applied Standards and References**

The EUT is a RF Product. According to the specifications of the manufacturer, it must comply with the requirements of the following standards and references:

#### **Test Standard:**

**FCC Part 15, Subpart C (15.247)**

ANSI C63.10-2013

All test items have been performed and recorded as per the above standards.

#### **References Test Guidance:**

**KDB 558074 D01 15.247 Meas Guidance v05r02**

All test items have been performed as a reference to the above KDB test guidance.

## 4 Test Types and Results

### 4.1 Radiated Emission and Bandedge Measurement

#### 4.1.1 Limits of Radiated Emission and Bandedge Measurement

Radiated emissions which fall in the restricted bands must comply with the radiated emission limits specified as below table. Other emissions shall be at least 20 dB below the highest level of the desired power:

Frequencies (MHz)	Field Strength (microvolts/meter)	Measurement Distance (meters)
0.009 ~ 0.490	2400/F (kHz)	300
0.490 ~ 1.705	24000/F (kHz)	30
1.705 ~ 30.0	30	30
30 ~ 88	100	3
88 ~ 216	150	3
216 ~ 960	200	3
Above 960	500	3

**Note:**

- The lower limit shall apply at the transition frequencies.
- Emission level (dBuV/m) = 20 log Emission level (uV/m).
- For frequencies above 1000 MHz, the field strength limits are based on average detector, however, the peak field strength of any emission shall not exceed the maximum permitted average limits, specified above by more than 20 dB under any condition of modulation.

## 4.1.2 Test Instruments

Description & Manufacturer	Model No.	Serial No.	Date of Calibration	Due Date of Calibration
Test Receiver ROHDE & SCHWARZ	ESR3	102579	Jul. 07, 2020	Jul. 06, 2021
Spectrum Analyzer ROHDE & SCHWARZ	FSP40	100269	Jun. 09, 2020	Jun. 08, 2021
Spectrum Analyzer ROHDE & SCHWARZ	FSV40	100980	Apr. 20, 2020	Apr. 19, 2021
BILOG Antenna SCHWARZBECK	VULB9168	9168-171	Nov. 11, 2019	Nov. 10, 2020
HORN Antenna SCHWARZBECK	9120D	209	Nov. 24, 2019	Nov. 23, 2020
HORN Antenna SCHWARZBECK	BBHA 9170	BBHA9170241	Nov. 24, 2019	Nov. 23, 2020
Preamplifier Agilent (Below 1GHz)	8447D	2944A10738	Aug. 20, 2019	Aug. 19, 2020
Preamplifier Agilent (Above 1GHz)	8449B	3008A02465	Mar. 23, 2020	Mar. 22, 2021
RF Coaxial Cable WOKEN With 5dB PAD	8D-FB	Cable-CH3-01	Aug. 20, 2019	Aug. 19, 2020
RF signal cable HUBER+SUHNER	SUCOFLEX 104	Cable-CH3-03 (223653/4)	Aug. 20, 2019	Aug. 19, 2020
RF signal cable HUBER+SUHNER& EMCI	SUCOFLEX 104&EMC104-SM- SM-8000	Cable-CH3-03 (309224+170907)	Aug. 20, 2019	Aug. 19, 2020
Software BV ADT	ADT_Radiated_ V7.6.15.9.5	NA	NA	NA
Antenna Tower inn-co GmbH	MA 4000	013303	NA	NA
Antenna Tower Controller BV ADT	AT100	AT93021702	NA	NA
Turn Table BV ADT	TT100	TT93021702	NA	NA
Turn Table Controller BV ADT	SC100	SC93021702	NA	NA
Boresight Antenna Fixture	FBA-01	FBA-SIP01	NA	NA
High Speed Peak Power Meter	ML2495A	1012010	Sep. 04, 2019	Sep. 03, 2020
Power Sensor	MA2411B	1315050	Sep. 04, 2019	Sep. 03, 2020
Bluetooth Tester R&S	CBT	100980	Jul. 14, 2019	Jul. 13, 2021

- Note: 1. The calibration interval of the above test instruments is 12 / 24 months and the calibrations are traceable to NML/ROC and NIST/USA.
2. The test was performed in HwaYa Chamber 3.

#### 4.1.3 Test Procedures

##### **For Radiated Emission below 30 MHz**

- a. The EUT was placed on the top of a rotating table 0.8 meters above the ground at a 3 meter chamber room. The table was rotated 360 degrees to determine the position of the highest radiation.
- b. The EUT was set 3 meters away from the interference-receiving antenna, which was mounted on the top of a variable-height antenna tower.
- c. Parallel, perpendicular, and ground-parallel orientations of the antenna are set to make the measurement.
- d. For each suspected emission, the EUT was arranged to its worst case and the rotatable table was turned from 0 degrees to 360 degrees to find the maximum reading.
- e. The test-receiver system was set to Quasi-Peak Detect Function and Specified Bandwidth with Maximum Hold Mode.

##### **Note:**

1. The resolution bandwidth and video bandwidth of test receiver/spectrum analyzer is 9 kHz at frequency below 30 MHz.

##### **For Radiated Emission above 30 MHz**

- a. The EUT was placed on the top of a rotating table 0.8 meters (for 30 MHz ~ 1 GHz) / 1.5 meters (for above 1 GHz) above the ground at 3 meter chamber room for test. The table was rotated 360 degrees to determine the position of the highest radiation.
- b. The EUT was set 3 meters away from the interference-receiving antenna, which was mounted on the top of a variable-height antenna tower.
- c. The height of antenna is varied from one meter to four meters above the ground to determine the maximum value of the field strength. Both horizontal and vertical polarizations of the antenna are set to make the measurement.
- d. For each suspected emission, the EUT was arranged to its worst case and then the antenna was tuned to heights from 1 meter to 4 meters and the rotatable table was turned from 0 degrees to 360 degrees to find the maximum reading.
- e. The test-receiver system was set to quasi-peak detect function and specified bandwidth with maximum hold mode when the test frequency is below 1 GHz.
- f. The test-receiver system was set to peak and average detected function and specified bandwidth with maximum hold mode when the test frequency is above 1 GHz. If the peak reading value also meets average limit, measurement with the average detector is unnecessary.

##### **Note:**

1. The resolution bandwidth and video bandwidth of test receiver/spectrum analyzer is 120 kHz for Quasi-peak detection (QP) or Peak detection (PK) at frequency below 1 GHz.
2. The resolution bandwidth of test receiver/spectrum analyzer is 1 MHz and the video bandwidth is 3 MHz for Peak detection (PK) at frequency above 1 GHz.
3. The resolution bandwidth of test receiver/spectrum analyzer is 1 MHz and the video bandwidth is  $\geq 1/T$  (Duty cycle < 98 %) or 10 Hz (Duty cycle  $\geq$  98 %) for Average detection (AV) at frequency above 1 GHz. (RBW = 1 MHz, VBW = 1 kHz)
4. All modes of operation were investigated and the worst-case emissions are reported.

#### 4.1.4 Deviation from Test Standard

No deviation.

4.1.5 Test Set Up

<Radiated Emission below 30 MHz>

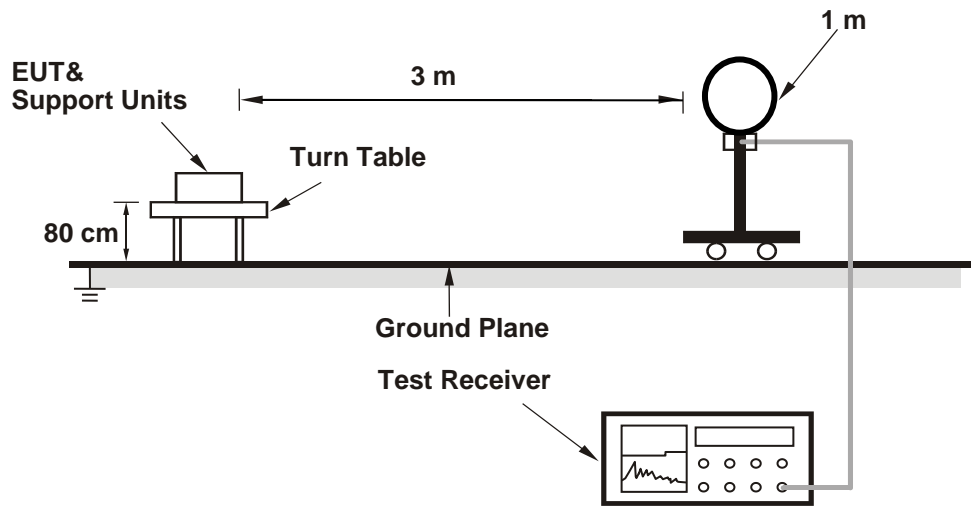

<Radiated Emission 30 MHz to 1 GHz>

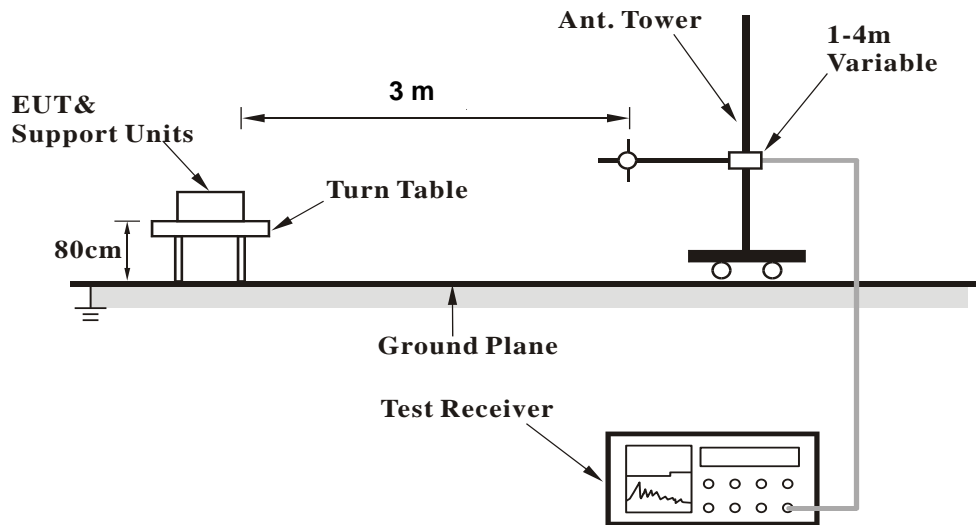



**<Radiated Emission above 1 GHz>**

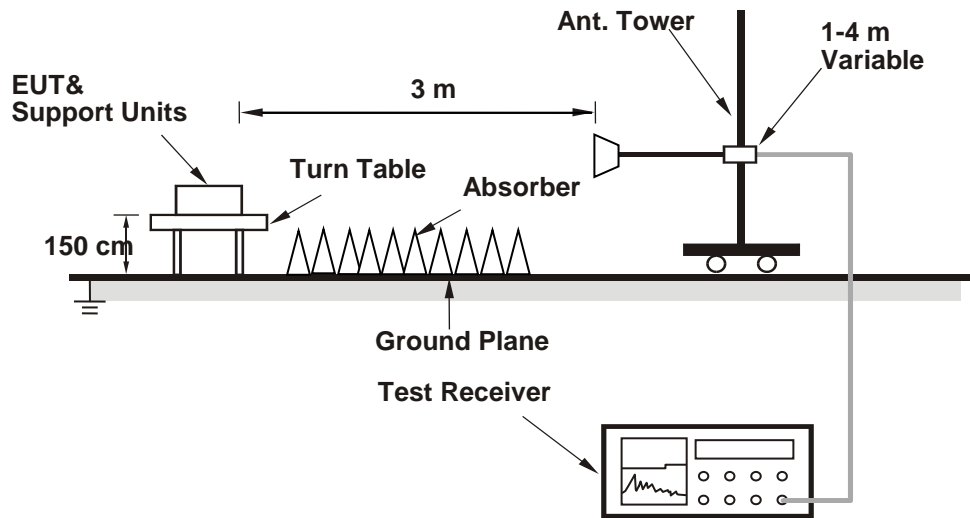

For the actual test configuration, please refer to the attached file (Test Setup Photo).

**4.1.6 EUT Operating Conditions**

Set the EUT under transmission condition continuously at specific channel frequency.

#### 4.1.7 Test Results

#### Above 1 GHz Data:

#### BT\_GFSK

<b>CHANNEL</b>	TX Channel 0	<b>DETECTOR FUNCTION</b>	Peak (PK)
<b>FREQUENCY RANGE</b>	1GHz ~ 25GHz		Average (AV)
<b>INPUT POWER</b>	120 Vac, 60 Hz	<b>ENVIRONMENTAL CONDITIONS</b>	23 °C, 65% RH

#### ANTENNA POLARITY & TEST DISTANCE: HORIZONTAL AT 3 M

NO.	FREQ. (MHz)	EMISSION LEVEL (dBuV/m)	LIMIT (dBuV/m)	MARGIN (dB)	ANTENNA HEIGHT (m)	TABLE ANGLE (Degree)	RAW VALUE (dBuV)	CORRECTION FACTOR (dB/m)
1	2390.00	59.0 PK	74.0	-15.0	1.19 H	146	26.7	32.3
2	2390.00	46.5 AV	54.0	-7.5	1.19 H	146	14.2	32.3
3	*2402.00	100.3 PK			1.19 H	146	68.0	32.3
4	*2402.00	99.5 AV			1.19 H	146	67.2	32.3
5	4804.00	48.5 PK	74.0	-25.5	1.35 H	112	45.4	3.1
6	4804.00	39.6 AV	54.0	-14.4	1.35 H	112	36.5	3.1

#### ANTENNA POLARITY & TEST DISTANCE: VERTICAL AT 3 M

NO.	FREQ. (MHz)	EMISSION LEVEL (dBuV/m)	LIMIT (dBuV/m)	MARGIN (dB)	ANTENNA HEIGHT (m)	TABLE ANGLE (Degree)	RAW VALUE (dBuV)	CORRECTION FACTOR (dB/m)
1	2390.00	59.1 PK	74.0	-14.9	1.79 V	167	26.8	32.3
2	2390.00	46.6 AV	54.0	-7.4	1.79 V	167	14.3	32.3
3	*2402.00	101.5 PK			1.79 V	167	69.2	32.3
4	*2402.00	99.6 AV			1.79 V	167	67.3	32.3
5	4804.00	48.3 PK	74.0	-25.7	1.49 V	327	45.2	3.1
6	4804.00	37.5 AV	54.0	-16.5	1.49 V	327	34.4	3.1

#### REMARKS:

1. Emission Level(dBuV/m) = Raw Value(dBuV) + Correction Factor(dB/m)
2. Correction Factor(dB/m) = Antenna Factor(dB/m) + Cable Factor(dB) – Pre-Amplifier Factor(dB)
3. Margin value = Emission Level – Limit value
4. The other emission levels were very low against the limit.
5. " \* ": Fundamental frequency.

<b>CHANNEL</b>	TX Channel 39	<b>DETECTOR FUNCTION</b>	Peak (PK)
<b>FREQUENCY RANGE</b>	1GHz ~ 25GHz		Average (AV)
<b>INPUT POWER</b>	120 Vac, 60 Hz	<b>ENVIRONMENTAL CONDITIONS</b>	23 °C, 65% RH

**ANTENNA POLARITY & TEST DISTANCE: HORIZONTAL AT 3 M**

NO.	FREQ. (MHz)	EMISSION LEVEL (dBuV/m)	LIMIT (dBuV/m)	MARGIN (dB)	ANTENNA HEIGHT (m)	TABLE ANGLE (Degree)	RAW VALUE (dBuV)	CORRECTION FACTOR (dB/m)
1	*2441.00	101.2 PK			1.11 H	143	68.9	32.3
2	*2441.00	100.3 AV			1.11 H	143	68.0	32.3
3	4882.00	48.2 PK	74.0	-25.8	1.33 H	107	45.3	2.9
4	4882.00	39.6 AV	54.0	-14.4	1.33 H	107	36.7	2.9

**ANTENNA POLARITY & TEST DISTANCE: VERTICAL AT 3 M**

NO.	FREQ. (MHz)	EMISSION LEVEL (dBuV/m)	LIMIT (dBuV/m)	MARGIN (dB)	ANTENNA HEIGHT (m)	TABLE ANGLE (Degree)	RAW VALUE (dBuV)	CORRECTION FACTOR (dB/m)
1	*2441.00	101.7 PK			1.48 V	172	69.4	32.3
2	*2441.00	100.9 AV			1.48 V	172	68.6	32.3
3	4882.00	47.8 PK	74.0	-26.2	1.00 V	271	44.9	2.9
4	4882.00	37.9 AV	54.0	-16.1	1.00 V	271	35.0	2.9

**REMARKS:**

1. Emission Level(dBuV/m) = Raw Value(dBuV) + Correction Factor(dB/m)
2. Correction Factor(dB/m) = Antenna Factor(dB/m) + Cable Factor(dB) – Pre-Amplifier Factor(dB)
3. Margin value = Emission Level – Limit value
4. The other emission levels were very low against the limit.
5. " \* ": Fundamental frequency.

<b>CHANNEL</b>	TX Channel 78	<b>DETECTOR FUNCTION</b>	Peak (PK)
<b>FREQUENCY RANGE</b>	1GHz ~ 25GHz		Average (AV)
<b>INPUT POWER</b>	120 Vac, 60 Hz	<b>ENVIRONMENTAL CONDITIONS</b>	23 °C, 65% RH

**ANTENNA POLARITY & TEST DISTANCE: HORIZONTAL AT 3 M**

NO.	FREQ. (MHz)	EMISSION LEVEL (dBuV/m)	LIMIT (dBuV/m)	MARGIN (dB)	ANTENNA HEIGHT (m)	TABLE ANGLE (Degree)	RAW VALUE (dBuV)	CORRECTION FACTOR (dB/m)
1	*2480.00	100.8 PK			1.23 H	147	68.4	32.4
2	*2480.00	99.9 AV			1.23 H	147	67.5	32.4
3	2483.50	60.0 PK	74.0	-14.0	1.23 H	147	27.6	32.4
4	2483.50	46.8 AV	54.0	-7.2	1.23 H	147	14.4	32.4
5	4960.00	47.4 PK	74.0	-26.6	1.29 H	117	44.1	3.3
6	4960.00	37.8 AV	54.0	-16.2	1.29 H	117	34.5	3.3

**ANTENNA POLARITY & TEST DISTANCE: VERTICAL AT 3 M**

NO.	FREQ. (MHz)	EMISSION LEVEL (dBuV/m)	LIMIT (dBuV/m)	MARGIN (dB)	ANTENNA HEIGHT (m)	TABLE ANGLE (Degree)	RAW VALUE (dBuV)	CORRECTION FACTOR (dB/m)
1	*2480.00	101.1 PK			1.39 V	172	68.7	32.4
2	*2480.00	100.3 AV			1.39 V	172	67.9	32.4
3	2483.50	60.4 PK	74.0	-13.6	1.39 V	172	28.0	32.4
<b>4</b>	<b>2483.50</b>	<b>46.9 AV</b>	<b>54.0</b>	<b>-7.1</b>	<b>1.39 V</b>	<b>172</b>	<b>14.5</b>	<b>32.4</b>
5	4960.00	47.0 PK	74.0	-27.0	1.16 V	264	43.7	3.3
6	4960.00	36.3 AV	54.0	-17.7	1.16 V	264	33.0	3.3

**REMARKS:**

1. Emission Level(dBuV/m) = Raw Value(dBuV) + Correction Factor(dB/m)
2. Correction Factor(dB/m) = Antenna Factor(dB/m) + Cable Factor(dB) – Pre-Amplifier Factor(dB)
3. Margin value = Emission Level – Limit value
4. The other emission levels were very low against the limit.
5. " \* ": Fundamental frequency.

**BT\_8DPSK**

<b>CHANNEL</b>	TX Channel 0	<b>DETECTOR FUNCTION</b>	Peak (PK)
<b>FREQUENCY RANGE</b>	1GHz ~ 25GHz		Average (AV)
<b>INPUT POWER</b>	120 Vac, 60 Hz	<b>ENVIORNMENTAL CONDITIONS</b>	23 °C, 65% RH

**ANTENNA POLARITY & TEST DISTANCE: HORIZONTAL AT 3 M**

NO.	FREQ. (MHz)	EMISSION LEVEL (dBuV/m)	LIMIT (dBuV/m)	MARGIN (dB)	ANTENNA HEIGHT (m)	TABLE ANGLE (Degree)	RAW VALUE (dBuV)	CORRECTION FACTOR (dB/m)
1	2390.00	59.3 PK	74.0	-14.7	1.14 H	145	27.0	32.3
2	2390.00	46.4 AV	54.0	-7.6	1.14 H	145	14.1	32.3
3	*2402.00	101.3 PK			1.14 H	145	69.0	32.3
4	*2402.00	100.0 AV			1.14 H	145	67.7	32.3
5	4804.00	47.1 PK	74.0	-26.9	1.51 H	120	44.0	3.1
6	4804.00	38.6 AV	54.0	-15.4	1.51 H	120	35.5	3.1

**ANTENNA POLARITY & TEST DISTANCE: VERTICAL AT 3 M**

NO.	FREQ. (MHz)	EMISSION LEVEL (dBuV/m)	LIMIT (dBuV/m)	MARGIN (dB)	ANTENNA HEIGHT (m)	TABLE ANGLE (Degree)	RAW VALUE (dBuV)	CORRECTION FACTOR (dB/m)
1	2390.00	59.5 PK	74.0	-14.5	1.59 V	172	27.2	32.3
2	2390.00	46.5 AV	54.0	-7.5	1.59 V	172	14.2	32.3
3	*2402.00	101.9 PK			1.59 V	172	69.6	32.3
4	*2402.00	100.3 AV			1.59 V	172	68.0	32.3
5	4804.00	46.8 PK	74.0	-27.2	2.32 V	323	43.7	3.1
6	4804.00	38.0 AV	54.0	-16.0	2.32 V	323	34.9	3.1

**REMARKS:**

1. Emission Level(dBuV/m) = Raw Value(dBuV) + Correction Factor(dB/m)
2. Correction Factor(dB/m) = Antenna Factor(dB/m) + Cable Factor(dB) – Pre-Amplifier Factor(dB)
3. Margin value = Emission Level – Limit value
4. The other emission levels were very low against the limit.
5. " \* ": Fundamental frequency.

<b>CHANNEL</b>	TX Channel 39	<b>DETECTOR FUNCTION</b>	Peak (PK)
<b>FREQUENCY RANGE</b>	1GHz ~ 25GHz		Average (AV)
<b>INPUT POWER</b>	120 Vac, 60 Hz	<b>ENVIRONMENTAL CONDITIONS</b>	23 °C, 65% RH

**ANTENNA POLARITY & TEST DISTANCE: HORIZONTAL AT 3 M**

NO.	FREQ. (MHz)	EMISSION LEVEL (dBuV/m)	LIMIT (dBuV/m)	MARGIN (dB)	ANTENNA HEIGHT (m)	TABLE ANGLE (Degree)	RAW VALUE (dBuV)	CORRECTION FACTOR (dB/m)
1	*2441.00	100.2 PK			1.17 H	150	67.9	32.3
2	*2441.00	99.6 AV			1.17 H	150	67.3	32.3
3	4882.00	47.9 PK	74.0	-26.1	1.45 H	110	45.0	2.9
4	4882.00	39.9 AV	54.0	-14.1	1.45 H	110	37.0	2.9

**ANTENNA POLARITY & TEST DISTANCE: VERTICAL AT 3 M**

NO.	FREQ. (MHz)	EMISSION LEVEL (dBuV/m)	LIMIT (dBuV/m)	MARGIN (dB)	ANTENNA HEIGHT (m)	TABLE ANGLE (Degree)	RAW VALUE (dBuV)	CORRECTION FACTOR (dB/m)
1	*2441.00	100.5 PK			1.51 V	172	68.2	32.3
2	*2441.00	100.1 AV			1.51 V	172	67.8	32.3
3	4882.00	47.7 PK	74.0	-26.3	1.00 V	261	44.8	2.9
4	4882.00	39.2 AV	54.0	-14.8	1.00 V	261	36.3	2.9

**REMARKS:**

1. Emission Level(dBuV/m) = Raw Value(dBuV) + Correction Factor(dB/m)
2. Correction Factor(dB/m) = Antenna Factor(dB/m) + Cable Factor(dB) – Pre-Amplifier Factor(dB)
3. Margin value = Emission Level – Limit value
4. The other emission levels were very low against the limit.
5. " \* ": Fundamental frequency.

<b>CHANNEL</b>	TX Channel 78	<b>DETECTOR FUNCTION</b>	Peak (PK)
<b>FREQUENCY RANGE</b>	1GHz ~ 25GHz		Average (AV)
<b>INPUT POWER</b>	120 Vac, 60 Hz	<b>ENVIRONMENTAL CONDITIONS</b>	23 °C, 65% RH

**ANTENNA POLARITY & TEST DISTANCE: HORIZONTAL AT 3 M**

NO.	FREQ. (MHz)	EMISSION LEVEL (dBuV/m)	LIMIT (dBuV/m)	MARGIN (dB)	ANTENNA HEIGHT (m)	TABLE ANGLE (Degree)	RAW VALUE (dBuV)	CORRECTION FACTOR (dB/m)
1	*2480.00	100.5 PK			1.09 H	148	68.1	32.4
2	*2480.00	99.9 AV			1.09 H	148	67.5	32.4
3	2483.50	59.0 PK	74.0	-15.0	1.09 H	148	26.6	32.4
4	2483.50	46.8 AV	54.0	-7.2	1.09 H	148	14.4	32.4
5	4960.00	48.6 PK	74.0	-25.4	1.08 H	109	45.3	3.3
6	4960.00	38.3 AV	54.0	-15.7	1.08 H	109	35.0	3.3

**ANTENNA POLARITY & TEST DISTANCE: VERTICAL AT 3 M**

NO.	FREQ. (MHz)	EMISSION LEVEL (dBuV/m)	LIMIT (dBuV/m)	MARGIN (dB)	ANTENNA HEIGHT (m)	TABLE ANGLE (Degree)	RAW VALUE (dBuV)	CORRECTION FACTOR (dB/m)
1	*2480.00	101.1 PK			1.88 V	167	68.7	32.4
2	*2480.00	100.3 AV			1.88 V	167	67.9	32.4
3	2483.50	59.2 PK	74.0	-14.8	1.88 V	167	26.8	32.4
<b>4</b>	<b>2483.50</b>	<b>46.9 AV</b>	<b>54.0</b>	<b>-7.1</b>	<b>1.88 V</b>	<b>167</b>	<b>14.5</b>	<b>32.4</b>
5	4960.00	48.3 PK	74.0	-25.7	1.02 V	260	45.0	3.3
6	4960.00	37.9 AV	54.0	-16.1	1.02 V	260	34.6	3.3

**REMARKS:**

1. Emission Level(dBuV/m) = Raw Value(dBuV) + Correction Factor(dB/m)
2. Correction Factor(dB/m) = Antenna Factor(dB/m) + Cable Factor(dB) – Pre-Amplifier Factor(dB)
3. Margin value = Emission Level – Limit value
4. The other emission levels were very low against the limit.
5. " \* ": Fundamental frequency.

### 30 MHz ~ 1 GHz Worst-Case Data:

#### Mode A

<b>CHANNEL</b>	TX Channel 78	<b>DETECTOR FUNCTION</b>	Quasi-Peak (QP)
<b>FREQUENCY RANGE</b>	30MHz ~ 1GHz		
<b>INPUT POWER</b>	120 Vac, 60 Hz	<b>ENVIRONMENTAL CONDITIONS</b>	23 °C, 65% RH

#### ANTENNA POLARITY & TEST DISTANCE: HORIZONTAL AT 3 M

NO.	FREQ. (MHz)	EMISSION LEVEL (dBuV/m)	LIMIT (dBuV/m)	MARGIN (dB)	ANTENNA HEIGHT (m)	TABLE ANGLE (Degree)	RAW VALUE (dBuV)	CORRECTION FACTOR (dB/m)
1	125.59	29.1 QP	43.5	-14.4	1.99 H	4	39.5	-10.4
2	164.96	31.4 QP	43.5	-12.1	1.49 H	268	40.1	-8.7
3	186.04	28.6 QP	43.5	-14.9	1.49 H	109	39.2	-10.6
4	381.45	29.0 QP	46.0	-17.0	1.00 H	12	34.0	-5.0
5	482.67	29.5 QP	46.0	-16.5	1.49 H	299	31.4	-1.9
6	613.41	33.0 QP	46.0	-13.0	1.49 H	117	31.7	1.3

#### REMARKS:

1. Emission Level(dBuV/m) = Raw Value(dBuV) + Correction Factor(dB/m)
2. Correction Factor(dB/m) = Antenna Factor(dB/m) + Cable Factor(dB) – Pre-Amplifier Factor(dB)
3. Margin value = Emission Level – Limit value
4. The other emission levels were very low against the limit of frequency range 30MHz~1000MHz.
5. The emission levels were very low against the limit of frequency range 9kHz~30MHz: the amplitude of spurious emissions attenuated more than 20 dB below the permissible value is not required to be report.

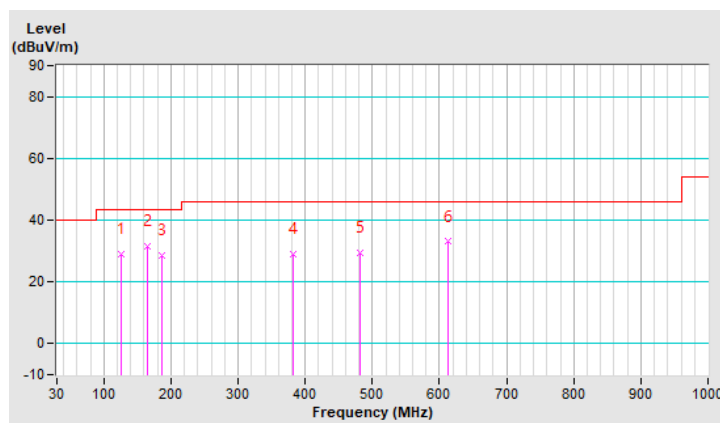



<b>CHANNEL</b>	TX Channel 78	<b>DETECTOR FUNCTION</b>	Quasi-Peak (QP)
<b>FREQUENCY RANGE</b>	30MHz ~ 1GHz		
<b>INPUT POWER</b>	120 Vac, 60 Hz	<b>ENVIRONMENTAL CONDITIONS</b>	23 °C, 65% RH

**ANTENNA POLARITY & TEST DISTANCE: VERTICAL AT 3 M**

NO.	FREQ. (MHz)	EMISSION LEVEL (dBuV/m)	LIMIT (dBuV/m)	MARGIN (dB)	ANTENNA HEIGHT (m)	TABLE ANGLE (Degree)	RAW VALUE (dBuV)	CORRECTION FACTOR (dB/m)
1	31.41	31.6 QP	40.0	-8.4	1.51 V	154	42.3	-10.7
2	72.17	27.9 QP	40.0	-12.1	1.01 V	50	39.2	-11.3
3	127.00	31.8 QP	43.5	-11.7	1.01 V	272	42.2	-10.4
4	186.04	30.1 QP	43.5	-13.4	1.01 V	39	40.7	-10.6
5	204.32	29.9 QP	43.5	-13.6	1.01 V	75	41.5	-11.6
6	589.51	33.6 QP	46.0	-12.4	1.01 V	16	32.8	0.8

**REMARKS:**

1. Emission Level(dBuV/m) = Raw Value(dBuV) + Correction Factor(dB/m)
2. Correction Factor(dB/m) = Antenna Factor(dB/m) + Cable Factor(dB) – Pre-Amplifier Factor(dB)
3. Margin value = Emission Level – Limit value
4. The other emission levels were very low against the limit of frequency range 30MHz~1000MHz.
5. The emission levels were very low against the limit of frequency range 9kHz~30MHz: the amplitude of spurious emissions attenuated more than 20 dB below the permissible value is not required to be report.

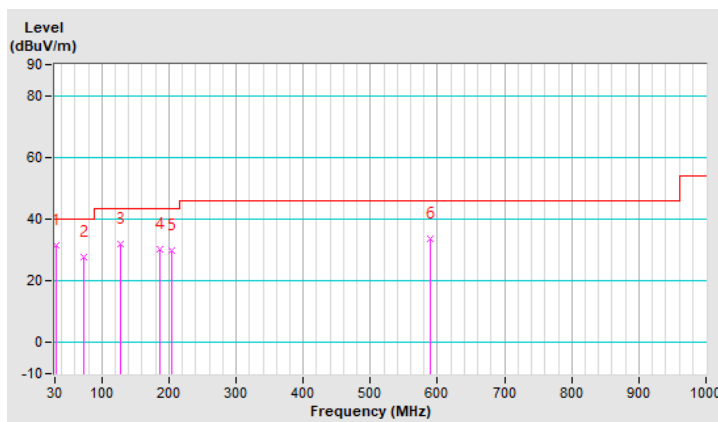

**Mode B**

<b>CHANNEL</b>	TX Channel 78	<b>DETECTOR FUNCTION</b>	Quasi-Peak (QP)
<b>FREQUENCY RANGE</b>	30MHz ~ 1GHz		
<b>INPUT POWER</b>	120 Vac, 60 Hz	<b>ENVIRONMENTAL CONDITIONS</b>	23 °C, 65% RH

**ANTENNA POLARITY & TEST DISTANCE: HORIZONTAL AT 3 M**

NO.	FREQ. (MHz)	EMISSION LEVEL (dBuV/m)	LIMIT (dBuV/m)	MARGIN (dB)	ANTENNA HEIGHT (m)	TABLE ANGLE (Degree)	RAW VALUE (dBuV)	CORRECTION FACTOR (dB/m)
1	30.00	28.4 QP	40.0	-11.6	1.00 H	304	38.8	-10.4
2	66.55	27.2 QP	40.0	-12.8	1.51 H	337	37.2	-10.0
3	82.01	21.5 QP	40.0	-18.5	2.00 H	259	35.1	-13.6
4	107.32	20.9 QP	43.5	-22.6	2.00 H	82	33.0	-12.1
5	171.99	21.2 QP	43.5	-22.3	1.00 H	264	30.3	-9.1
6	540.30	30.4 QP	46.0	-15.6	1.00 H	206	31.1	-0.7

**REMARKS:**

1. Emission Level(dBuV/m) = Raw Value(dBuV) + Correction Factor(dB/m)
2. Correction Factor(dB/m) = Antenna Factor(dB/m) + Cable Factor(dB) – Pre-Amplifier Factor(dB)
3. Margin value = Emission Level – Limit value
4. The other emission levels were very low against the limit of frequency range 30MHz~1000MHz.
5. The emission levels were very low against the limit of frequency range 9kHz~30MHz: the amplitude of spurious emissions attenuated more than 20 dB below the permissible value to be report.

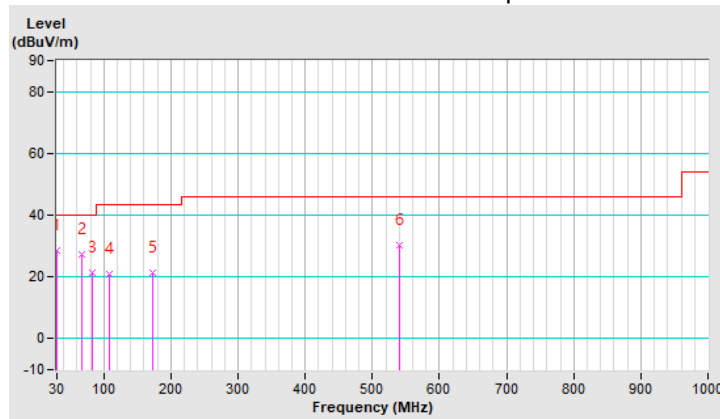

<b>CHANNEL</b>	TX Channel 78	<b>DETECTOR FUNCTION</b>	Quasi-Peak (QP)
<b>FREQUENCY RANGE</b>	30MHz ~ 1GHz		
<b>INPUT POWER</b>	120 Vac, 60 Hz	<b>ENVIRONMENTAL CONDITIONS</b>	23 °C, 65% RH

**ANTENNA POLARITY & TEST DISTANCE: VERTICAL AT 3 M**

NO.	FREQ. (MHz)	EMISSION LEVEL (dBuV/m)	LIMIT (dBuV/m)	MARGIN (dB)	ANTENNA HEIGHT (m)	TABLE ANGLE (Degree)	RAW VALUE (dBuV)	CORRECTION FACTOR (dB/m)
1	30.00	29.0 QP	40.0	-11.0	1.00 V	196	39.4	-10.4
2	66.55	27.4 QP	40.0	-12.6	1.99 V	348	37.4	-10.0
3	107.32	27.6 QP	43.5	-15.9	1.00 V	162	39.7	-12.1
4	134.03	29.2 QP	43.5	-14.3	1.49 V	57	38.7	-9.5
5	486.88	27.4 QP	46.0	-18.6	1.99 V	1	29.2	-1.8
6	673.86	30.9 QP	46.0	-15.1	1.49 V	17	29.2	1.7

**REMARKS:**

1. Emission Level(dBuV/m) = Raw Value(dBuV) + Correction Factor(dB/m)
2. Correction Factor(dB/m) = Antenna Factor(dB/m) + Cable Factor(dB) – Pre-Amplifier Factor(dB)
3. Margin value = Emission Level – Limit value
4. The other emission levels were very low against the limit of frequency range 30MHz~1000MHz.
5. The emission levels were very low against the limit of frequency range 9kHz~30MHz: the amplitude of spurious emissions attenuated more than 20 dB below the permissible value to be report.

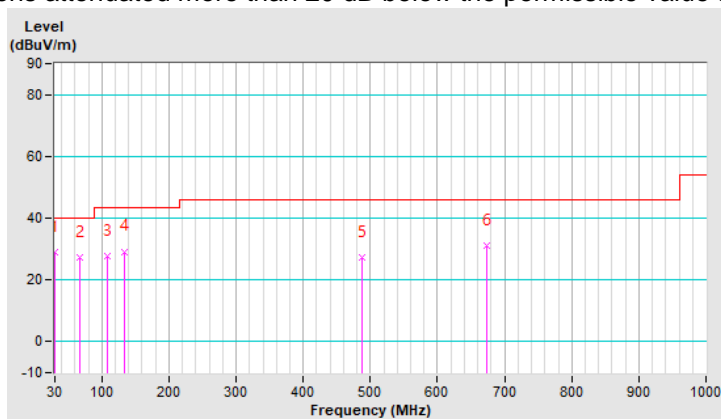

## 4.2 Conducted Emission Measurement

### 4.2.1 Limits of Conducted Emission Measurement

Frequency (MHz)	Conducted Limit (dBuV)	
	Quasi-Peak	Average
0.15 - 0.5	66 - 56	56 - 46
0.50 - 5.0	56	46
5.0 - 30.0	60	50

- Note: 1. The lower limit shall apply at the transition frequencies.  
 2. The limit decreases in line with the logarithm of the frequency in the range of 0.15 to 0.50 MHz.

### 4.2.2 Test Instruments

Description & Manufacturer	Model No.	Serial No.	Date of Calibration	Due Date of Calibration
Test Receiver ROHDE & SCHWARZ	ESCI	100613	Dec. 11, 2019	Dec. 10, 2020
RF signal cable Woken	5D-FB	Cable-cond1-01	Sep. 05, 2019	Sep. 04, 2020
LISN ROHDE & SCHWARZ (EUT)	ENV216	101826	Feb. 20, 2020	Feb. 19, 2021
LISN ROHDE & SCHWARZ (Peripheral)	ESH3-Z5	100311	Aug. 22, 2019	Aug. 21, 2020
Software ADT	BV ADT_Cond_ V7.3.7.4	NA	NA	NA

- Note: 1. The calibration interval of the above test instruments is 12 months and the calibrations are traceable to NML/ROC and NIST/USA.  
 2. The test was performed in HwaYa Shielded Room 1.  
 3. The VCCI Site Registration No. is C-12040.

#### 4.2.3 Test Procedures

- The EUT was placed 0.4 meters from the conducting wall of the shielded room with EUT being connected to the power mains through a line impedance stabilization network (LISN). Other support units were connected to the power mains through another LISN. The two LISNs provide 50 ohm/ 50 uH of coupling impedance for the measuring instrument.
- Both lines of the power mains connected to the EUT were checked for maximum conducted interference.
- The frequency range from 150 kHz to 30 MHz was searched. Emission levels under (Limit – 20 dB) was not recorded.

**Note:** The resolution bandwidth and video bandwidth of test receiver is 9 kHz for quasi-peak detection (QP) and average detection (AV) at frequency 0.15 MHz - 30 MHz.

#### 4.2.4 Deviation from Test Standard

No deviation.

#### 4.2.5 Test Setup

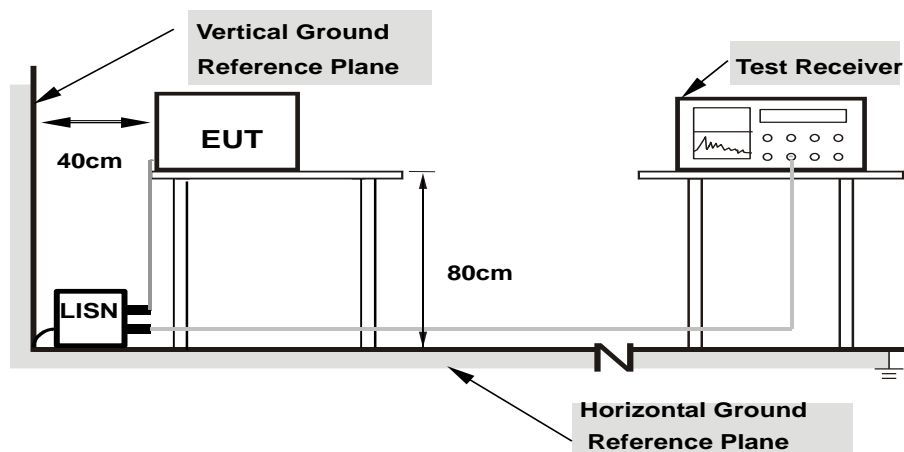

- Note:**
- Support units were connected to second LISN.
  - Both of LISNs (AMN) are 80 cm from EUT and at least 80 from other units and other metal planes

For the actual test configuration, please refer to the attached file (Test Setup Photo).

#### 4.2.6 EUT Operating Condition

Set the EUT under transmission condition continuously at specific channel frequency.

#### 4.2.7 Test Results

#### CONDUCTED WORST-CASE DATA : GFSK

Frequency Range	150kHz ~ 30MHz	Detector Function & Resolution Bandwidth	Quasi-Peak (QP) / Average (AV), 9kHz
Input Power	120Vac, 60Hz	Environmental Conditions	23°C, 67%RH
Tested by	Adair Peng	Test Date	2020/7/9
Test Mode	Mode A		

Phase Of Power : Line (L)										
No	Frequency (MHz)	Correction Factor (dB)	Reading Value (dBuV)		Emission Level (dBuV)		Limit (dBuV)		Margin (dB)	
			Q.P.	AV.	Q.P.	AV.	Q.P.	AV.	Q.P.	AV.
1	0.39633	9.65	31.91	21.20	41.56	30.85	57.93	47.93	-16.37	-17.08
2	0.49408	9.65	31.39	19.70	41.04	29.35	56.10	46.10	-15.06	-16.75
3	0.73814	9.67	35.47	19.52	45.14	29.19	56.00	46.00	-10.86	-16.81
4	1.12750	9.69	30.94	17.27	40.63	26.96	56.00	46.00	-15.37	-19.04
5	1.22134	9.69	32.77	20.89	42.46	30.58	56.00	46.00	-13.54	-15.42
6	15.66879	9.90	31.23	20.43	41.13	30.33	60.00	50.00	-18.87	-19.67

#### Remarks:

1. Q.P. and AV. are abbreviations of quasi-peak and average individually.
2. The emission levels of other frequencies were very low against the limit.
3. Margin value = Emission level – Limit value
4. Correction factor = Insertion loss + Cable loss
5. Emission Level = Correction Factor + Reading Value

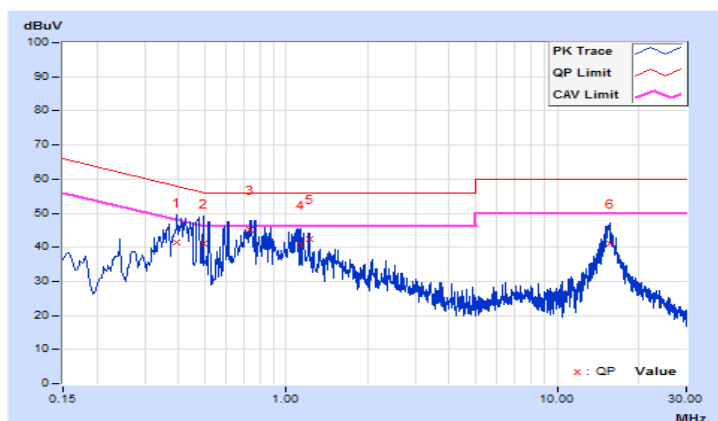

Frequency Range	150kHz ~ 30MHz	Detector Function & Resolution Bandwidth	Quasi-Peak (QP) / Average (AV), 9kHz
Input Power	120Vac, 60Hz	Environmental Conditions	23°C, 67%RH
Tested by	Adair Peng	Test Date	2020/7/9
Test Mode	Mode A		

Phase Of Power : Neutral (N)										
No	Frequency (MHz)	Correction Factor (dB)	Reading Value (dBuV)		Emission Level (dBuV)		Limit (dBuV)		Margin (dB)	
			Q.P.	AV.	Q.P.	AV.	Q.P.	AV.	Q.P.	AV.
1	0.37678	9.67	35.57	22.12	45.24	31.79	58.35	48.35	-13.11	-16.56
2	0.48235	9.67	36.94	25.42	46.61	35.09	56.30	46.30	-9.69	-11.21
3	0.61138	9.68	36.97	26.26	46.65	35.94	56.00	46.00	-9.35	-10.06
4	0.75585	9.69	35.26	18.06	44.95	27.75	56.00	46.00	-11.05	-18.25
5	1.21352	9.71	33.83	20.96	43.54	30.67	56.00	46.00	-12.46	-15.33
6	15.53976	9.99	30.34	19.91	40.33	29.90	60.00	50.00	-19.67	-20.10

Remarks:

1. Q.P. and AV. are abbreviations of quasi-peak and average individually.
2. The emission levels of other frequencies were very low against the limit.
3. Margin value = Emission level – Limit value
4. Correction factor = Insertion loss + Cable loss
5. Emission Level = Correction Factor + Reading Value

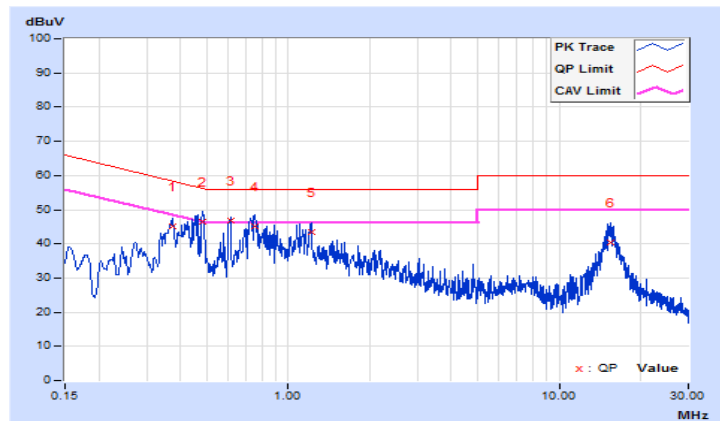

Frequency Range	150kHz ~ 30MHz	Detector Function & Resolution Bandwidth	Quasi-Peak (QP) / Average (AV), 9kHz
Input Power	120Vac, 60Hz	Environmental Conditions	23°C, 67%RH
Tested by	Adair Peng	Test Date	2020/7/9
Test Mode	Mode B		

Phase Of Power : Line (L)										
No	Frequency (MHz)	Correction Factor (dB)	Reading Value (dBuV)		Emission Level (dBuV)		Limit (dBuV)		Margin (dB)	
			Q.P.	AV.	Q.P.	AV.	Q.P.	AV.	Q.P.	AV.
1	0.15782	9.63	29.24	16.62	38.87	26.25	65.58	55.58	-26.71	-29.33
2	0.18519	9.62	28.37	14.25	37.99	23.87	64.25	54.25	-26.26	-30.38
3	0.46280	9.65	29.32	26.66	38.97	36.31	56.64	46.64	-17.67	-10.33
4	1.06885	9.68	14.15	7.51	23.83	17.19	56.00	46.00	-32.17	-28.81
5	5.53016	9.81	12.70	6.49	22.51	16.30	60.00	50.00	-37.49	-33.70
6	21.71756	9.91	13.02	5.16	22.93	15.07	60.00	50.00	-37.07	-34.93

Remarks:

1. Q.P. and AV. are abbreviations of quasi-peak and average individually.
2. The emission levels of other frequencies were very low against the limit.
3. Margin value = Emission level – Limit value
4. Correction factor = Insertion loss + Cable loss
5. Emission Level = Correction Factor + Reading Value

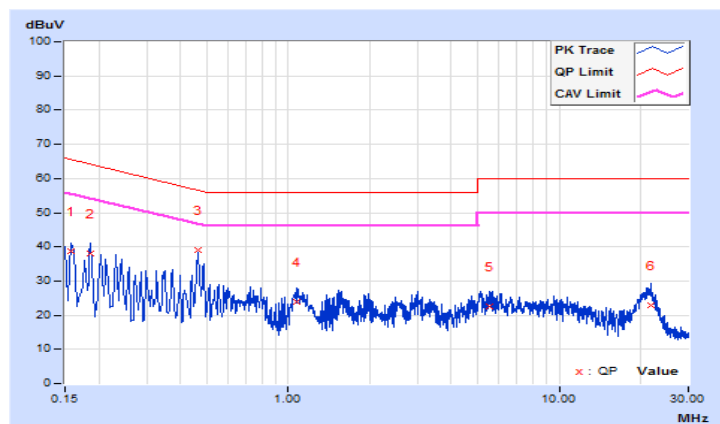



Frequency Range	150kHz ~ 30MHz	Detector Function & Resolution Bandwidth	Quasi-Peak (QP) / Average (AV), 9kHz
Input Power	120Vac, 60Hz	Environmental Conditions	23°C, 67%RH
Tested by	Adair Peng	Test Date	2020/7/9
Test Mode	Mode B		

Phase Of Power : Neutral (N)										
No	Frequency (MHz)	Correction Factor (dB)	Reading Value (dBuV)		Emission Level (dBuV)		Limit (dBuV)		Margin (dB)	
			Q.P.	AV.	Q.P.	AV.	Q.P.	AV.	Q.P.	AV.
1	0.15391	9.66	28.45	15.88	38.11	25.54	65.79	55.79	-27.68	-30.25
<b>2</b>	<b>0.46280</b>	<b>9.67</b>	<b>30.87</b>	<b>30.80</b>	<b>40.54</b>	<b>40.47</b>	<b>56.64</b>	<b>46.64</b>	<b>-16.10</b>	<b>-6.17</b>
3	0.77169	9.69	17.57	13.23	27.26	22.92	56.00	46.00	-28.74	-23.08
4	1.10795	9.71	16.85	12.82	26.56	22.53	56.00	46.00	-29.44	-23.47
5	4.67387	9.83	16.74	6.71	26.57	16.54	56.00	46.00	-29.43	-29.46
6	20.86518	10.03	10.45	3.51	20.48	13.54	60.00	50.00	-39.52	-36.46

Remarks:

1. Q.P. and AV. are abbreviations of quasi-peak and average individually.
2. The emission levels of other frequencies were very low against the limit.
3. Margin value = Emission level – Limit value
4. Correction factor = Insertion loss + Cable loss
5. Emission Level = Correction Factor + Reading Value

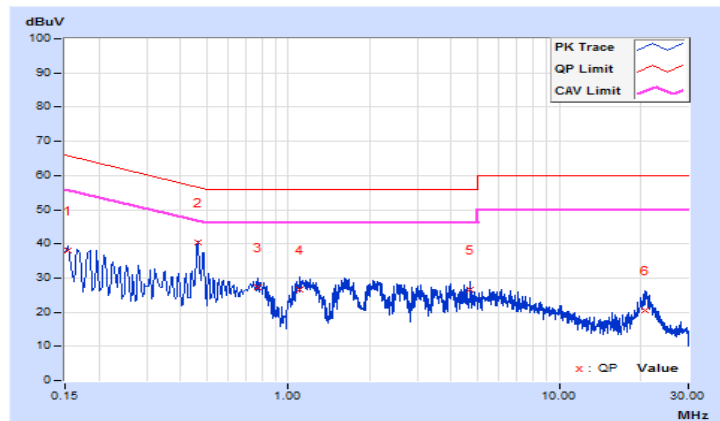

### 4.3 Number of Hopping Frequency Used

#### 4.3.1 Limits of Hopping Frequency Used Measurement

At least 15 channels frequencies, and should be equally spaced.

#### 4.3.2 Test Setup

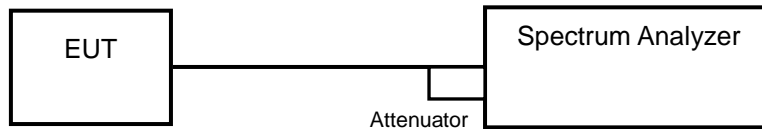

#### 4.3.3 Test Instruments

Refer to section 4.1.2 to get information of above instrument.

#### 4.3.4 Test Procedure

- a. Check the calibration of the measuring instrument (SA) using either an internal calibrator or a known signal from an external generator.
- b. Turn on the EUT and connect its antenna terminal to measurement via a low loss cable. Then set it to any one measured frequency within its operating range and make sure the instrument is operated in its linear range.
- c. Set the SA on MaxHold Mode, and then keep the EUT in hopping mode. Record all the signals from each channel until each one has been recorded.
- d. Set the SA on View mode and then plot the result on SA screen.
- e. Repeat above procedures until all frequencies measured were complete.

#### 4.3.5 Deviation from Test Standard

No deviation.

### 4.3.6 Test Results

There are 79 hopping frequencies in the hopping mode. Please refer to next page for the test result. On the plots, it shows that the hopping frequencies are equally spaced.

#### <GFSK>

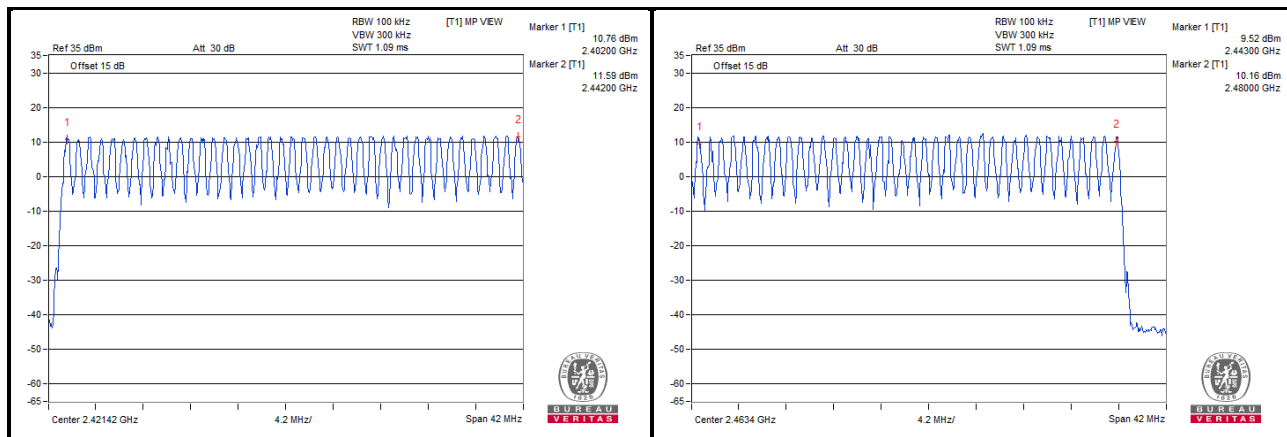

#### <8DPSK>

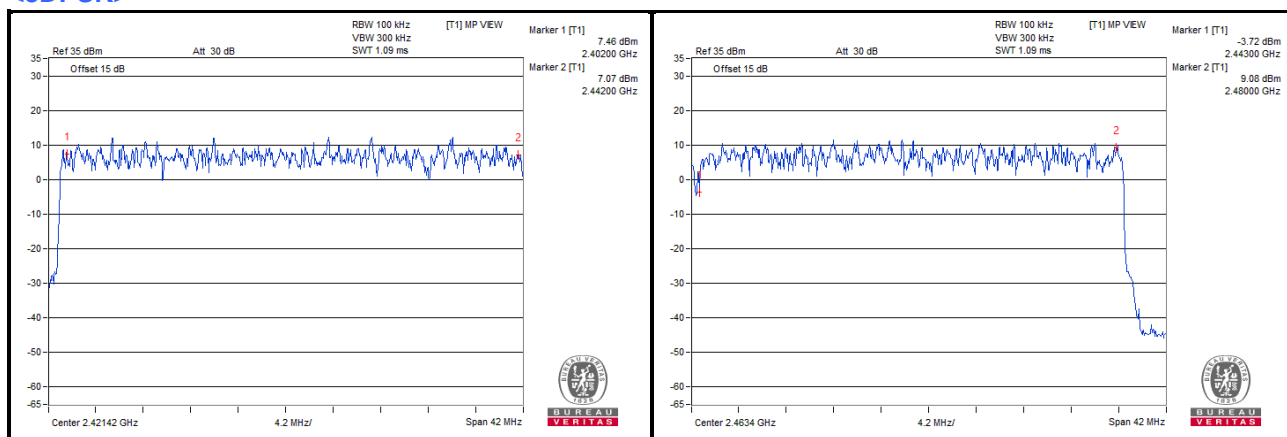

#### 4.4 Dwell Time on Each Channel

##### 4.4.1 Limits of Dwell Time on Each Channel Measurement

The average time of occupancy on any channel shall not be greater than 0.4 seconds within a period of 0.4 seconds multiplied by the number of hopping channels employed.

##### 4.4.2 Test Setup

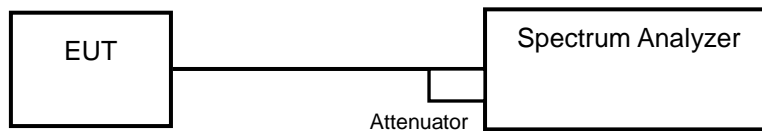

##### 4.4.3 Test Instruments

Refer to section 4.1.2 to get information of above instrument.

##### 4.4.4 Test Procedures

- a. Check the calibration of the measuring instrument (SA) using either an internal calibrator or a known signal from an external generator.
- b. Turn on the EUT and connect its antenna terminal to measurement via a low loss cable. Then set it to any one measured frequency within its operating range and make sure the instrument is operated in its linear range.
- c. Adjust the center frequency of SA on any frequency be measured and set SA to zero span mode. And then, set RBW and VBW of spectrum analyzer to proper value.
- d. Measure the time duration of one transmission on the measured frequency. And then plot the result with time difference of this time duration.
- e. Repeat above procedures until all different time-slot modes have been completed.

##### 4.4.5 Deviation from Test Standard

No deviation.

### 4.4.6 Test Results

#### GFSK

Mode	Number of Transmission in a 31.6 (79 Hopping*0.4)	Length of Transmission Time (msec)	Result (msec)	Limit (msec)
DH1	50 (times / 5 sec) * 6.32 = 316 times	0.42	132.72	400
DH3	25 (times / 5 sec) * 6.32 = 158 times	1.69	267.02	400
DH5	16 (times / 5 sec) * 6.32 = 101.12 times	2.99	302.35	400

**Note:** Test plots of the transmitting time slot are shown as below.



### 8DPSK

Mode	Number of Transmission in a 31.6 (79 Hopping*0.4)	Length of Transmission Time (msec)	Result (msec)	Limit (msec)
3DH1	51 (times / 5 sec) * 6.32 = 322.32 times	0.434	139.89	400
3DH3	26 (times / 5 sec) * 6.32 = 164.32 times	1.74	285.92	400
3DH5	17 (times / 5 sec) * 6.32 = 107.44 times	2.99	321.25	400

**Note:** Test plots of the transmitting time slot are shown as below.



## 4.5 Channel Bandwidth

### 4.5.1 Limits of Channel Bandwidth Measurement

For frequency hopping system operating in the 2400-2483.5 MHz, if the 20 dB bandwidth of hopping channel is greater than 25 kHz, two-thirds 20 dB bandwidth of hopping channel shall be a minimum limit for the hopping channel separation.

### 4.5.2 Test Setup



### 4.5.3 Test Instruments

Refer to section 4.1.2 to get information of above instrument.

### 4.5.4 Test Procedure

- Check the calibration of the measuring instrument using either an internal calibrator or a known signal from an external generator.
- Turn on the EUT and connect it to measurement instrument. Then set it to any one convenient frequency within its operating range. Set a reference level on the measuring instrument equal to the highest peak value.
- Measure the frequency difference of two frequencies that were attenuated 20 dB from the reference level. Record the frequency difference as the emission bandwidth.
- Repeat above procedures until all frequencies measured were complete.

### 4.5.5 Deviation from Test Standard

No deviation.

### 4.5.6 EUT Operating Condition

The software provided by client enabled the EUT to transmit and receive data at lowest, middle and highest channel frequencies individually.

### 4.5.7 Test Results

Channel	Frequency (MHz)	20 dB Bandwidth (MHz)	
		GFSK	8DPSK
0	2402	0.96	1.30
39	2441	0.96	1.31
78	2480	0.96	1.31

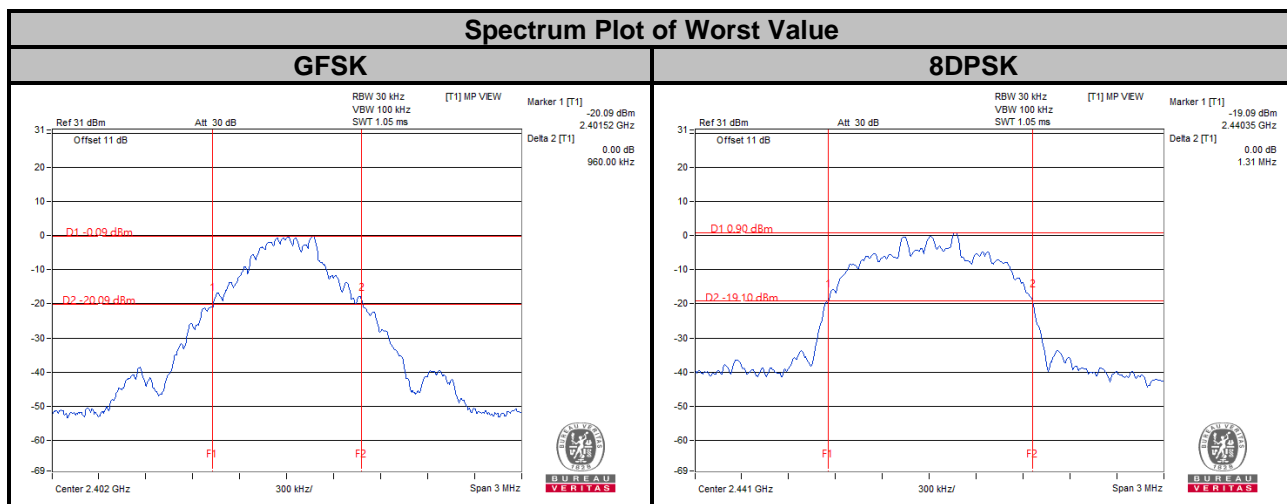



## 4.6 Occupied Bandwidth Measurement

### 4.6.1 Test Setup

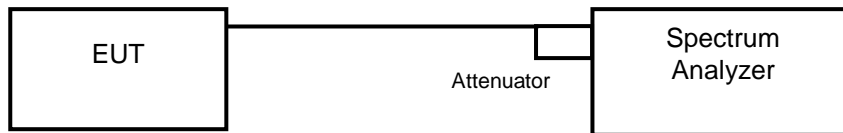

### 4.6.2 Test Instruments

Refer to section 4.1.2 to get information of above instrument

### 4.6.3 Test Procedure

The transmitter output was connected to the spectrum analyzer through an attenuator. The bandwidth of the fundamental frequency was measured by spectrum analyzer with resolution bandwidth in the range of 1 % to 5 % of the anticipated emission bandwidth, and a video bandwidth at least 3x the resolution bandwidth and set the detector to sampling. The width of a frequency band such that, below the lower and above the upper frequency limits, the mean powers emitted are each equal to a specified percentage 0.5 % of the total mean power of a given emission.

### 4.6.4 Deviation from Test Standard

No deviation.

### 4.6.5 EUT Operating Conditions

The software provided by client to enable the EUT under transmission condition continuously at lowest, middle and highest channel frequencies individually.

#### 4.6.6 Test Results

Channel	Frequency (MHz)	Occupied Bandwidth (MHz)	
		GFSK	8DPSK
0	2402	0.87	1.18
39	2441	0.87	1.18
78	2480	0.87	1.18

#### Spectrum Plot of Worst Value

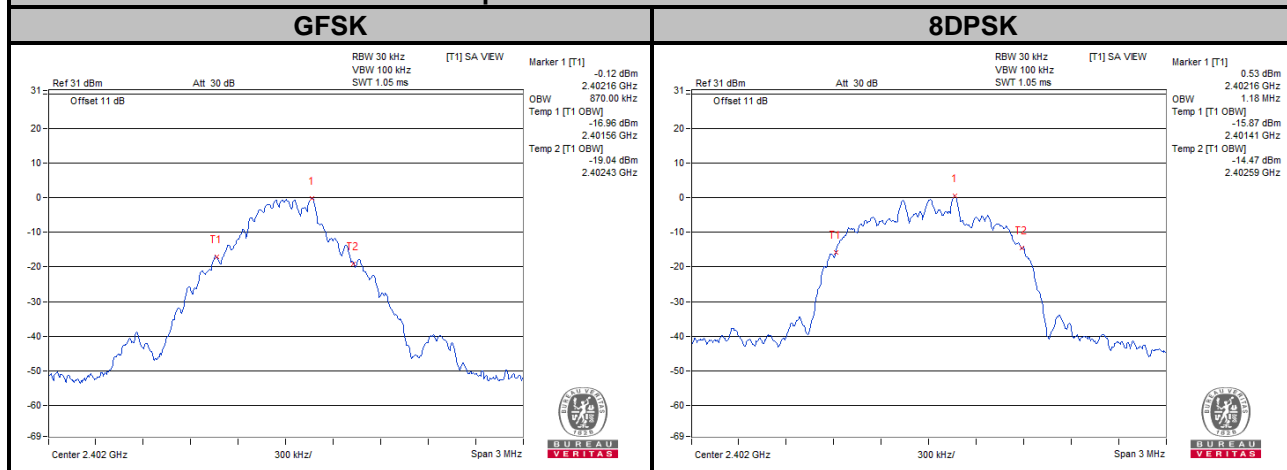

## 4.7 Hopping Channel Separation

### 4.7.1 Limits of Hopping Channel Separation Measurement

At least 25 kHz or two-third of 20 dB hopping channel bandwidth (whichever is greater).

### 4.7.2 Test Setup

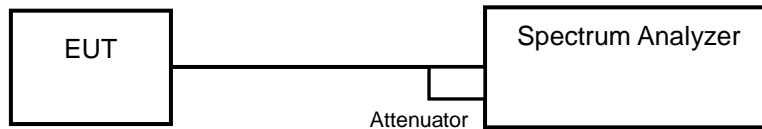

### 4.7.3 Test Instruments

Refer to section 4.1.2 to get information of above instrument.

### 4.7.4 Test Procedure

#### Measurement Procedure REF

- a. Check the calibration of the measuring instrument using either an internal calibrator or a known signal from an external generator.
- b. Turn on the EUT and connect it to measurement instrument. Then set it to any one convenient frequency within its operating range.
- c. By using the MaxHold function record the separation of two adjacent channels.
- d. Measure the frequency difference of these two adjacent channels by SA MARK function. And then plot the result on SA screen.
- e. Repeat above procedures until all frequencies measured were complete.

### 4.7.5 Deviation from Test Standard

No deviation.

#### 4.7.6 Test Results

Channel	Freq. (MHz)	Adjacent Channel Separation (MHz)		20 dB Bandwidth (MHz)		Minimum Limit (MHz)		Pass / Fail
		GFSK	8DPSK	GFSK	8DPSK	GFSK	8DPSK	
0	2402	1.00	1.00	0.96	1.30	0.64	0.87	Pass
39	2441	1.00	1.00	0.96	1.31	0.64	0.88	Pass
78	2480	1.00	1.00	0.96	1.31	0.64	0.88	Pass

**Note:**

- The minimum limit is two-third 20 dB bandwidth.

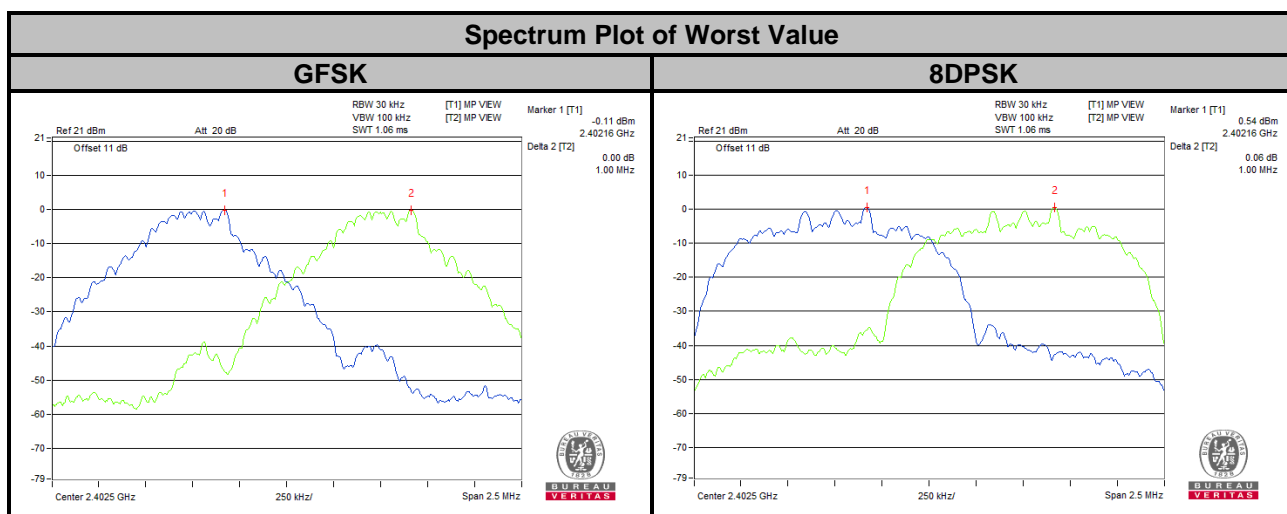

## 4.8 Maximum Output Power

### 4.8.1 Limits of Maximum Output Power Measurement

For frequency hopping systems operating in the 2400-2483.5 MHz band employing at least 75 non-overlapping hopping channels: 1 watt.

For all other frequency hopping systems in the 2400-2483.5 MHz band: 0.125 watts.

### 4.8.2 Test Setup

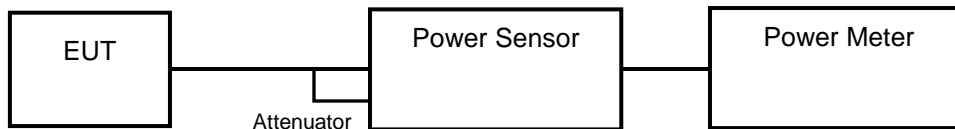

### 4.8.3 Test Instruments

Refer to section 4.1.2 to get information of above instrument.

### 4.8.4 Test Procedure

A peak power sensor was used on the output port of the EUT. A power meter was used to read the response of the peak power sensor. Record the power level.

Average power sensor was used to perform output power measurement, trigger and gating function of wide band power meter is enabled to measure max output power of TX on burst. Duty factor is not added to measured value.

### 4.8.5 Deviation from Test Standard

No deviation.

### 4.8.6 EUT Operating Condition

The software provided by client enabled the EUT to transmit and receive data at lowest, middle and highest channel frequencies individually.

#### 4.8.7 Test Results

##### <GFSK>

Channel	Freq. (MHz)	Peak Power		Average Power		Power Limit (mW)	Pass / Fail
		(mW)	(dBm)	(mW)	(dBm)		
0	2402	1.503	1.77	1.483	1.71	125 / 1000 <sup>Note</sup>	Pass
39	2441	2.388	3.78	2.36	3.73	125 / 1000 <sup>Note</sup>	Pass
78	2480	2.421	3.84	2.399	3.80	125 / 1000 <sup>Note</sup>	Pass

Note: RF Output Power limit depends on the operating channel numbers, please refer to section 4.3 of the results.

##### <8DPSK>

Channel	Freq. (MHz)	Peak Power		Average Power		Power Limit (mW)	Pass / Fail
		(mW)	(dBm)	(mW)	(dBm)		
0	2402	2.193	3.41	2.168	3.36	125 / 1000 <sup>Note</sup>	Pass
39	2441	2.388	3.78	2.36	3.73	125 / 1000 <sup>Note</sup>	Pass
78	2480	2.443	3.88	2.41	3.82	125 / 1000 <sup>Note</sup>	Pass

Note: RF Output Power limit depends on the operating channel numbers, please refer to section 4.3 of the results.

## 4.9 Conducted Out of Band Emission Measurement

### 4.9.1 Limits Of Conducted Out of Band Emission Measurement

Below  $-20$  dB of the highest emission level of operating band (in 100 kHz RBW).

### 4.9.2 Test Instruments

Refer to section 4.1.2 to get information of above instrument.

### 4.9.3 Test Procedure

The transmitter output was connected to the spectrum analyzer via a low lose cable. Set both RBW and VBW of spectrum analyzer to 100 kHz and 300 kHz with suitable frequency span including 100 MHz bandwidth from band edge. The band edges was measured and recorded.

### 4.9.4 Deviation from Test Standard

No deviation.

### 4.9.5 EUT Operating Condition

The software provided by client enabled the EUT to transmit and receive data at lowest, middle and highest channel frequencies individually.

### 4.9.6 Test Results

The spectrum plots are attached on the following images. D1 line indicates the highest level, D2 line indicates the 20 dB offset below D1. It shows compliance with the requirement.



BUREAU VERITAS

GFSK

### Hopping Disabled\_Low Channel

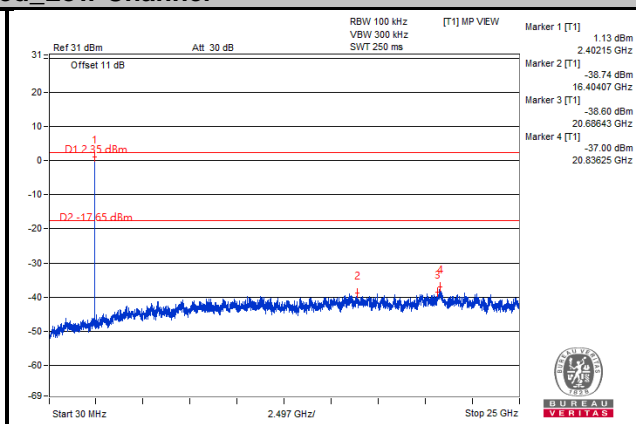
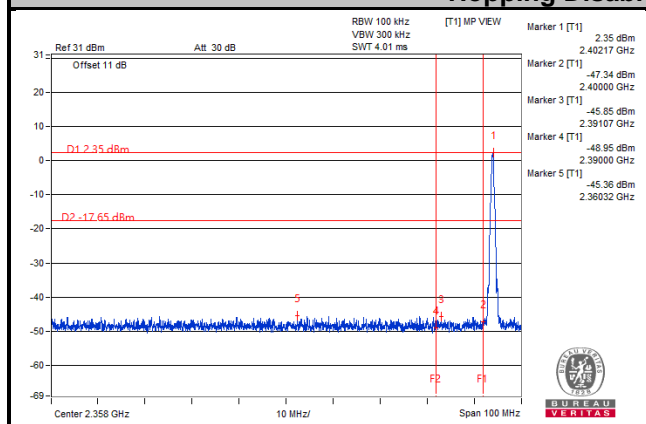

### Hopping Disabled\_High Channel

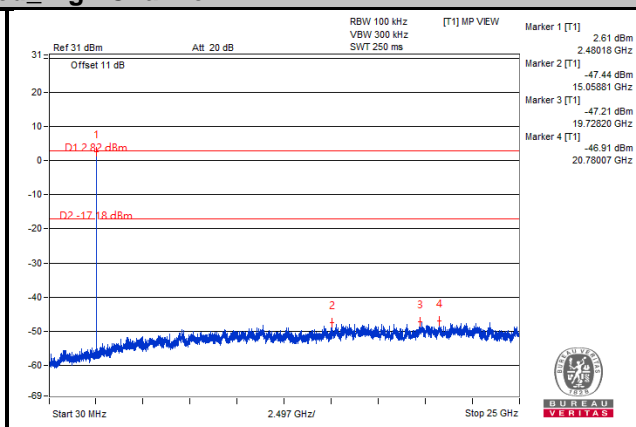
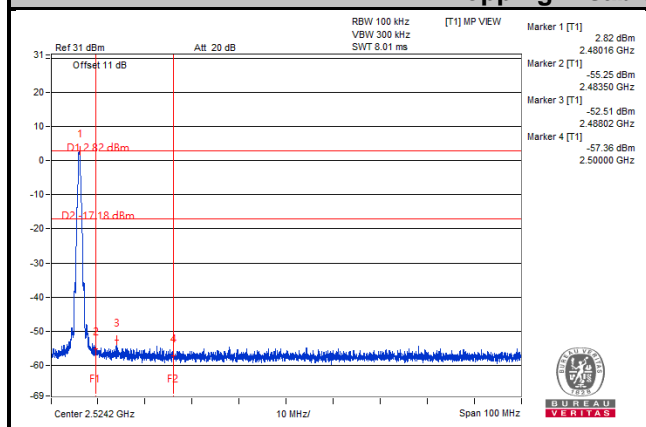



### Hopping Enabled\_Low Channel

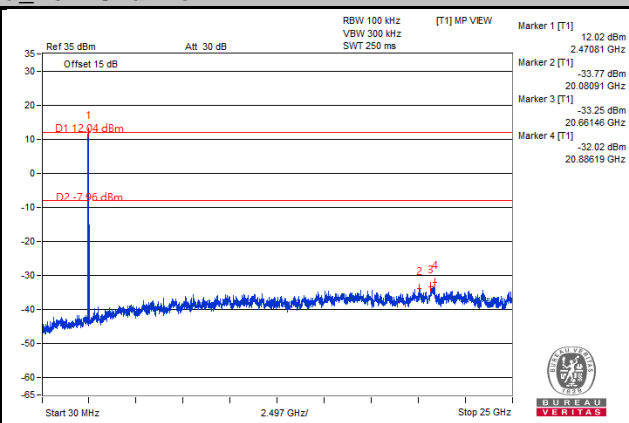
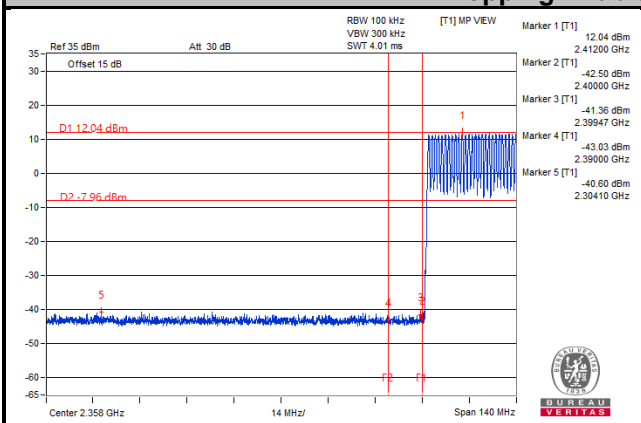

### Hopping Enabled\_High Channel

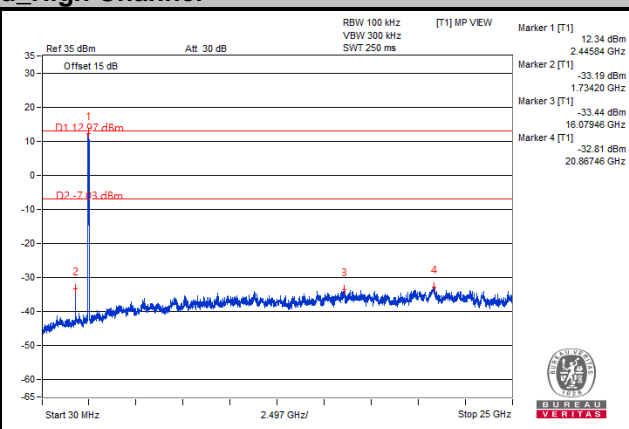
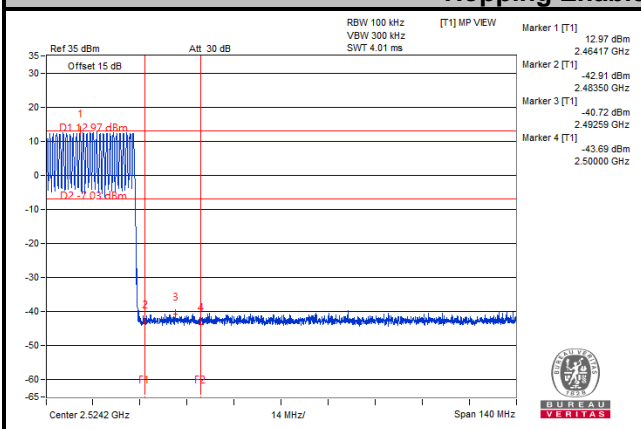



BUREAU VERITAS

# 8DPSK

## Hopping Disabled\_Low Channel

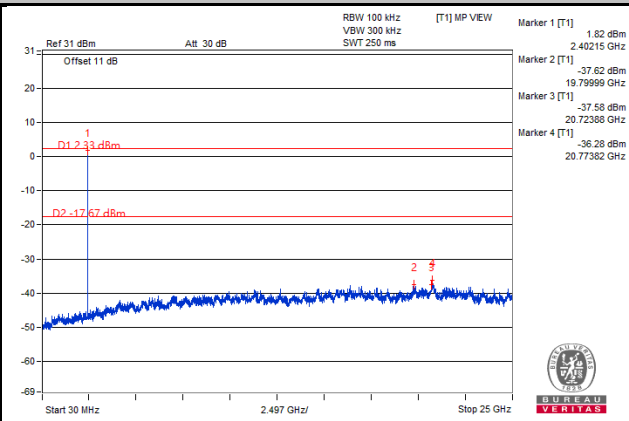
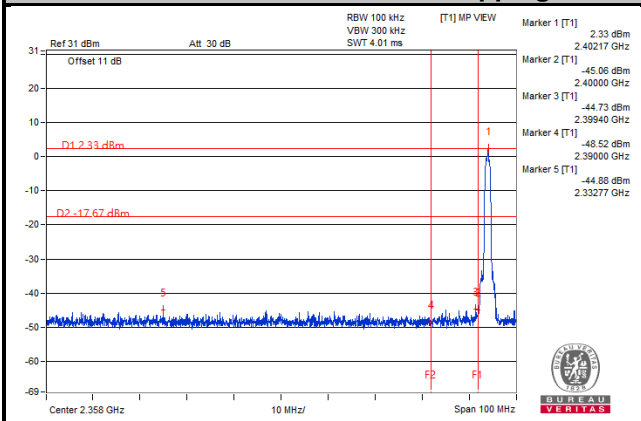

## Hopping Disabled\_High Channel

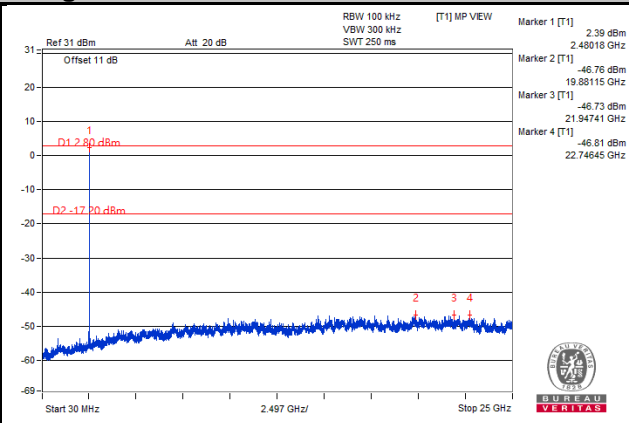
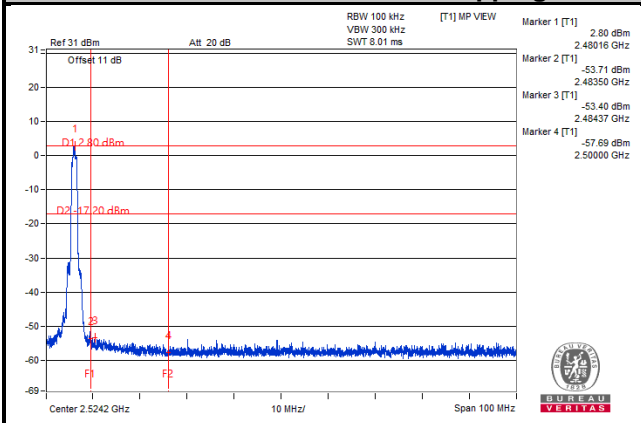



BUREAU VERITAS

### Hopping Enabled\_Low Channel

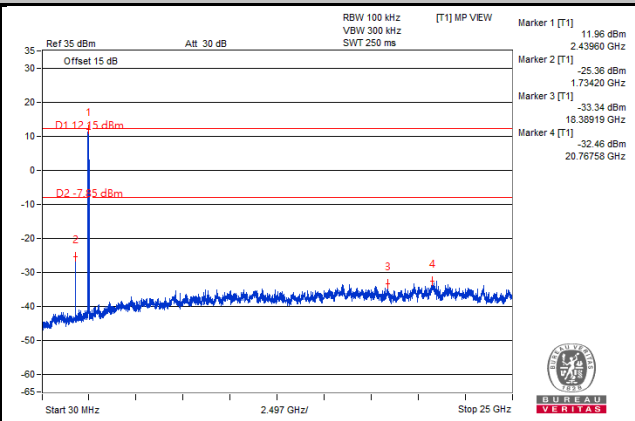
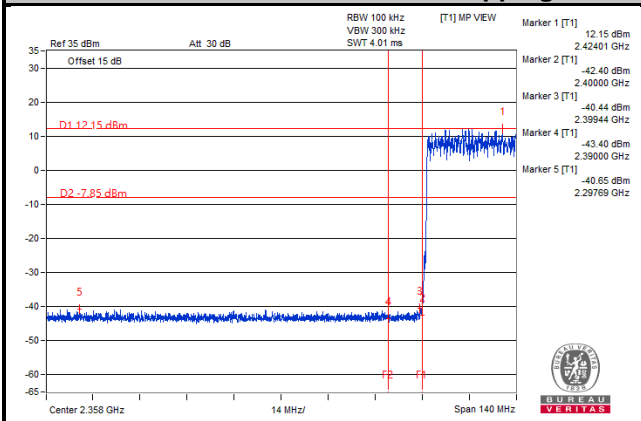

### Hopping Enabled\_High Channel

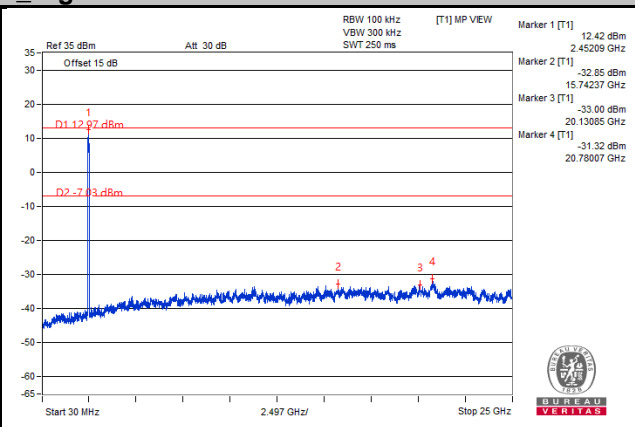
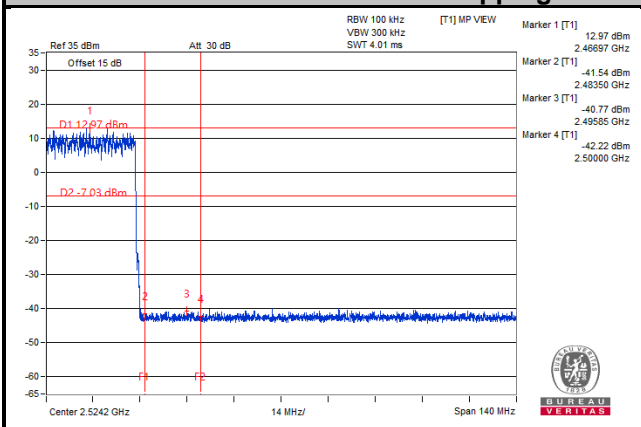

## 5 Photographs of the Test Configuration

Please refer to the attached file (Reference no.: 200618C02 (TSup photo)).

## 6 Construction Photos of EUT

Please refer to the attached file (200618C02 (EUT photo))

## Appendix – Information of the Testing Laboratories

We, Bureau Veritas Consumer Products Services (H.K.) Ltd., Taoyuan Branch, were founded in 1988 to provide our best service in EMC, Radio, Telecom and Safety consultation. Our laboratories are FCC recognized accredited test firms and accredited according to ISO/IEC 17025.

If you have any comments, please feel free to contact us at the following:

**Lin Kou EMC/RF Lab**

Tel: 886-2-26052180

Fax: 886-2-26051924

**Hsin Chu EMC/RF/Telecom Lab**

Tel: 886-3-6668565

Fax: 886-3-6668323

**Hwa Ya EMC/RF/Safety Lab**

Tel: 886-3-3183232

Fax: 886-3-3270892

**Email:** [service.adt@tw.bureauveritas.com](mailto:service.adt@tw.bureauveritas.com)

**Web Site:** [www.bureauveritas-adt.com](http://www.bureauveritas-adt.com)

The address and road map of all our labs can be found in our web site also.

--- END ---