

5.2 Schematic Diagrams

5.2.1 AF-Module

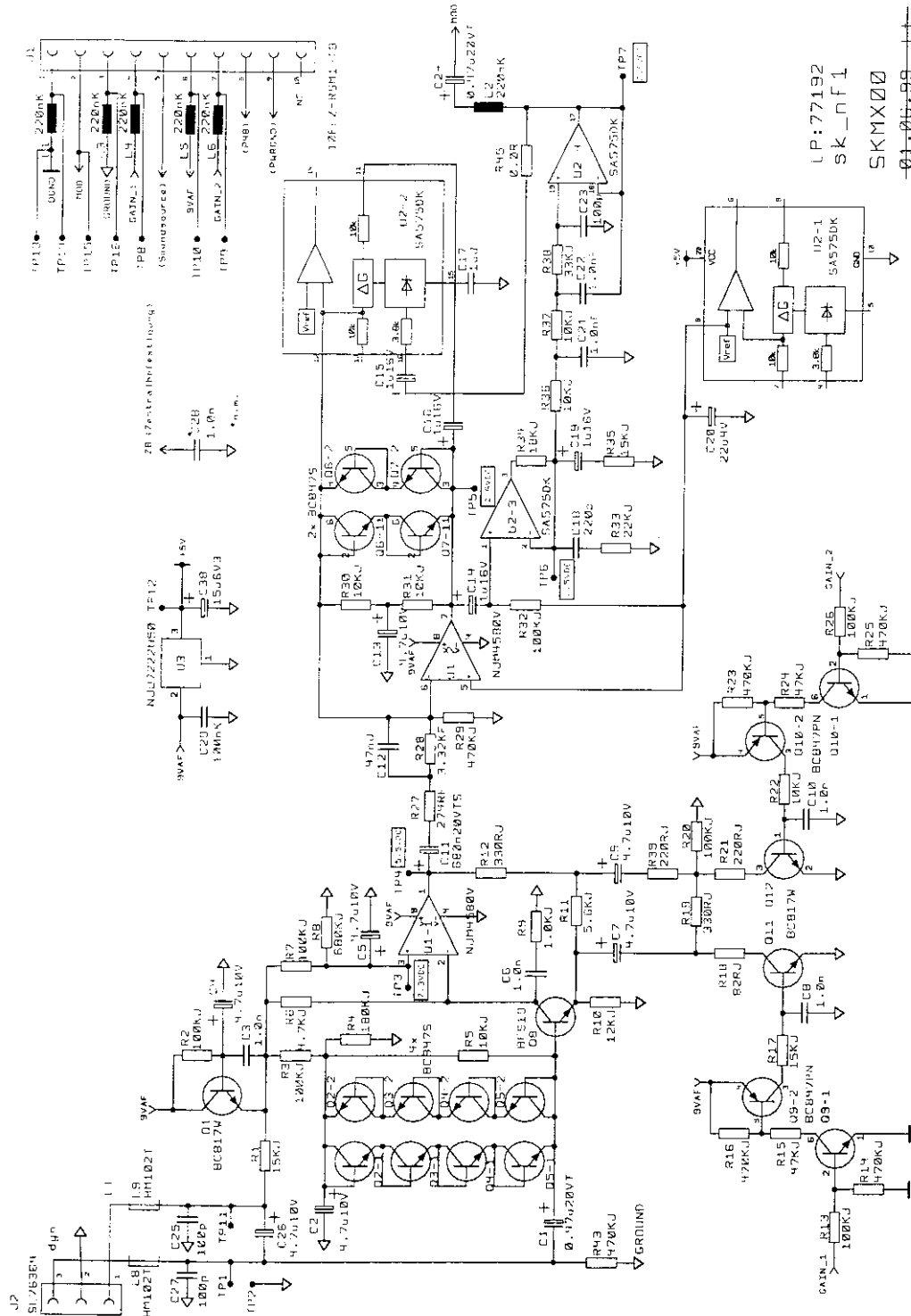

LP:77192  
 sk\_nfl  
 SKMX00  
 01.06.99  
 21.07.99 Kra.

## 5.2.2 RF-Module

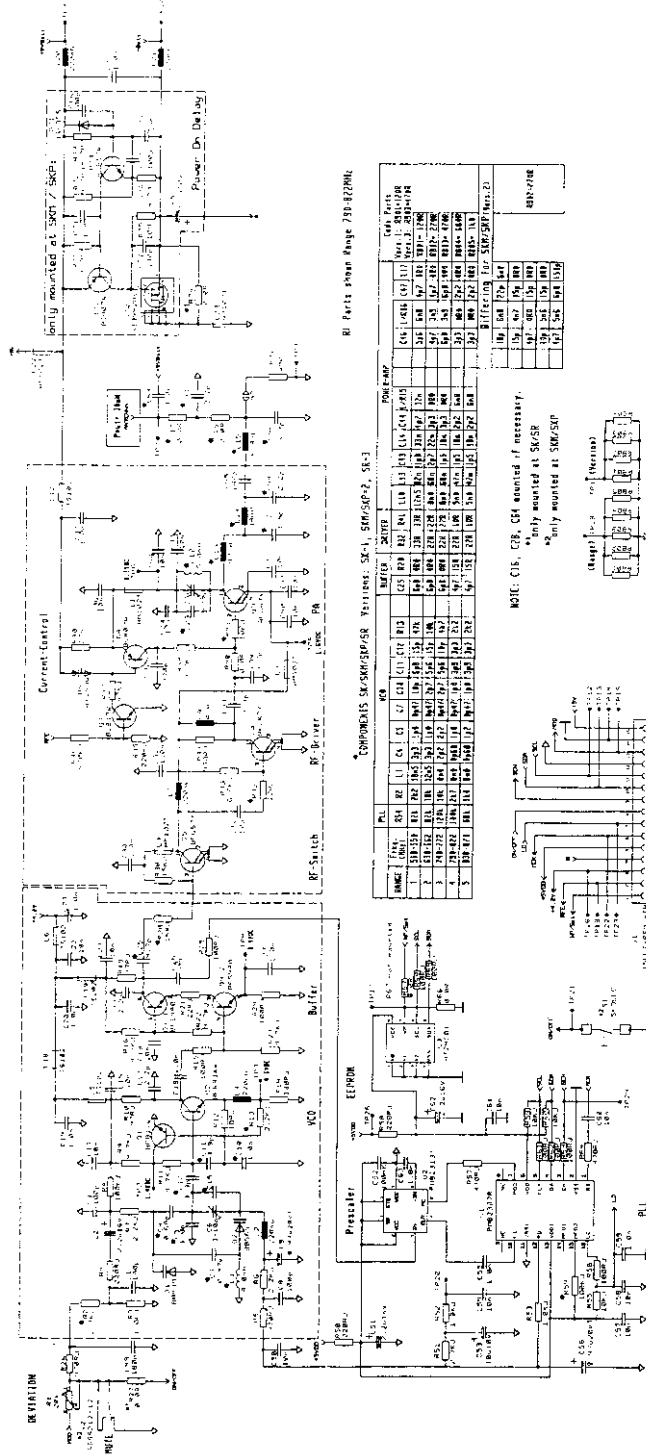

50k 1000 uF  
 HF-Jo11  
 SYMBAUFPLAN  
 11-00-99-00-00  
 00-00-00-00-00  
 00-00-00-00-00  
 00-00-00-00-00  
 00-00-00-00-00  
 20.00.33 P11

### 5.2.3 Processor Module

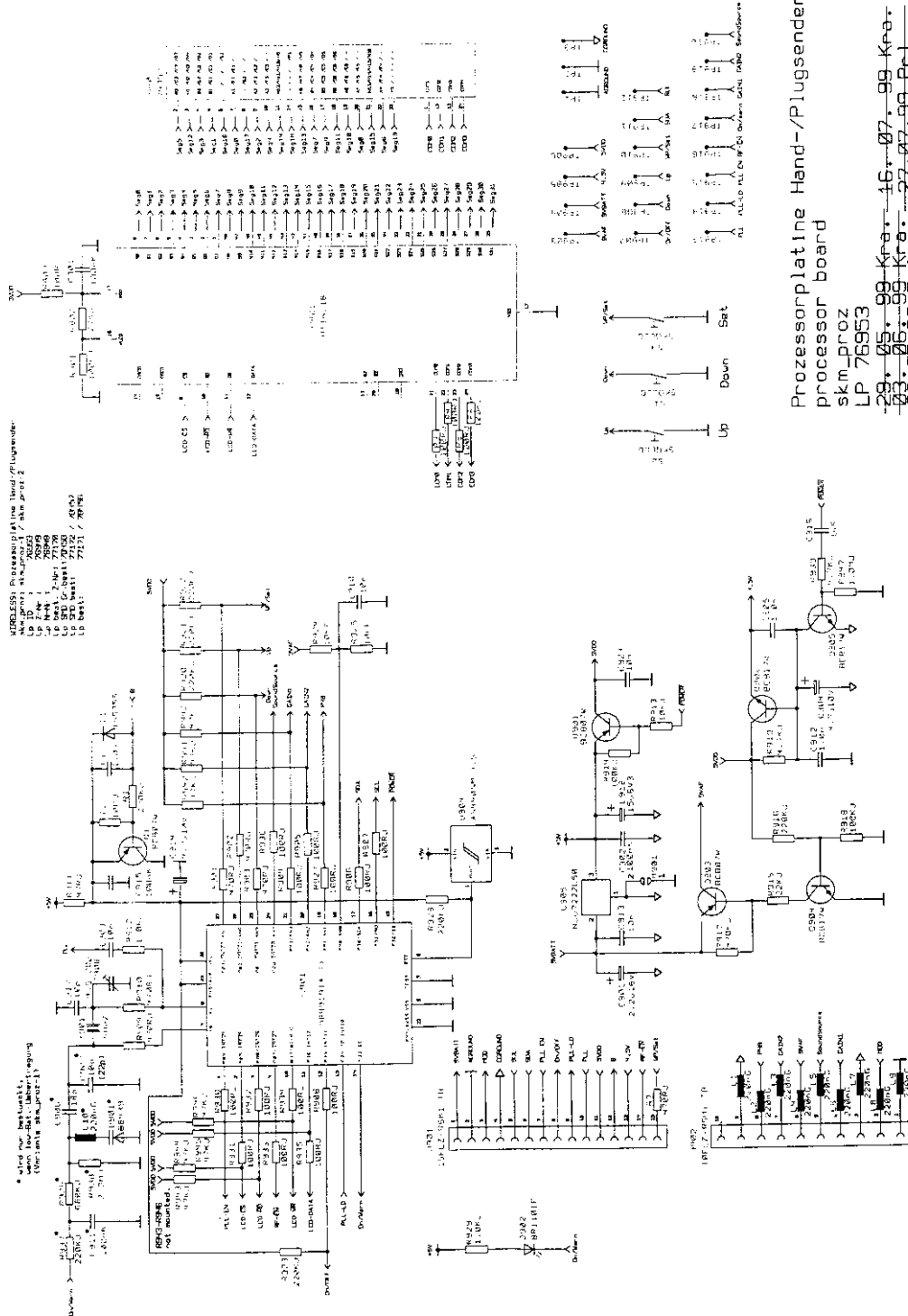

Processorplatine Hand-/Plugsender  
 processor board  
 skm\_proz  
 LP 76953  
 -29.05.99 Kra-16.07.99 Kra-  
 08.06.99 Kra-27.07.99 Pr1  
 09.07.99 Pr1-20.08.99 Pr1

5.3 Printed Circuit Board Layouts

5.3.1.f AF-Module (front)

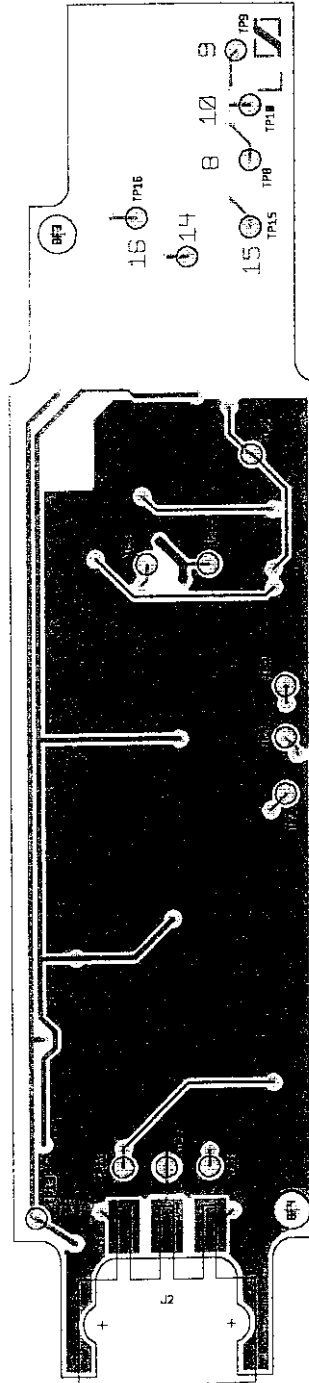

5.3.1.b AF-Module (back)

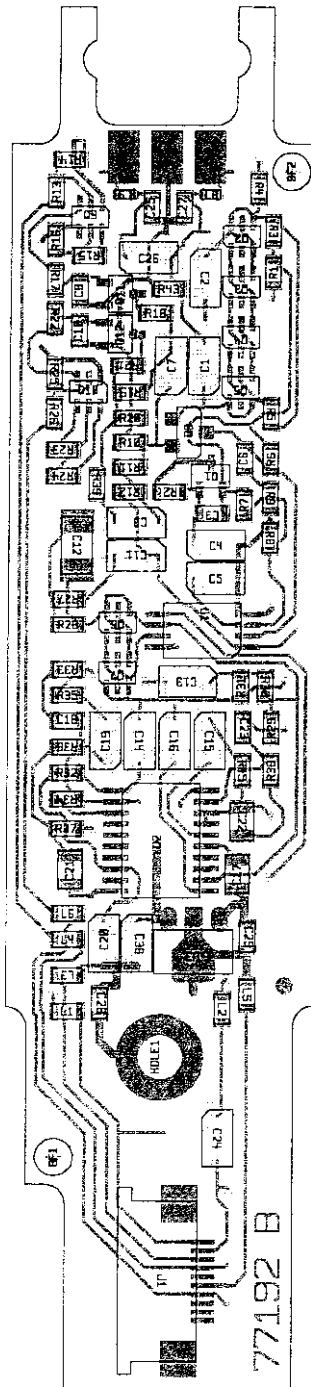

5.3.2.f RF-Module (front)

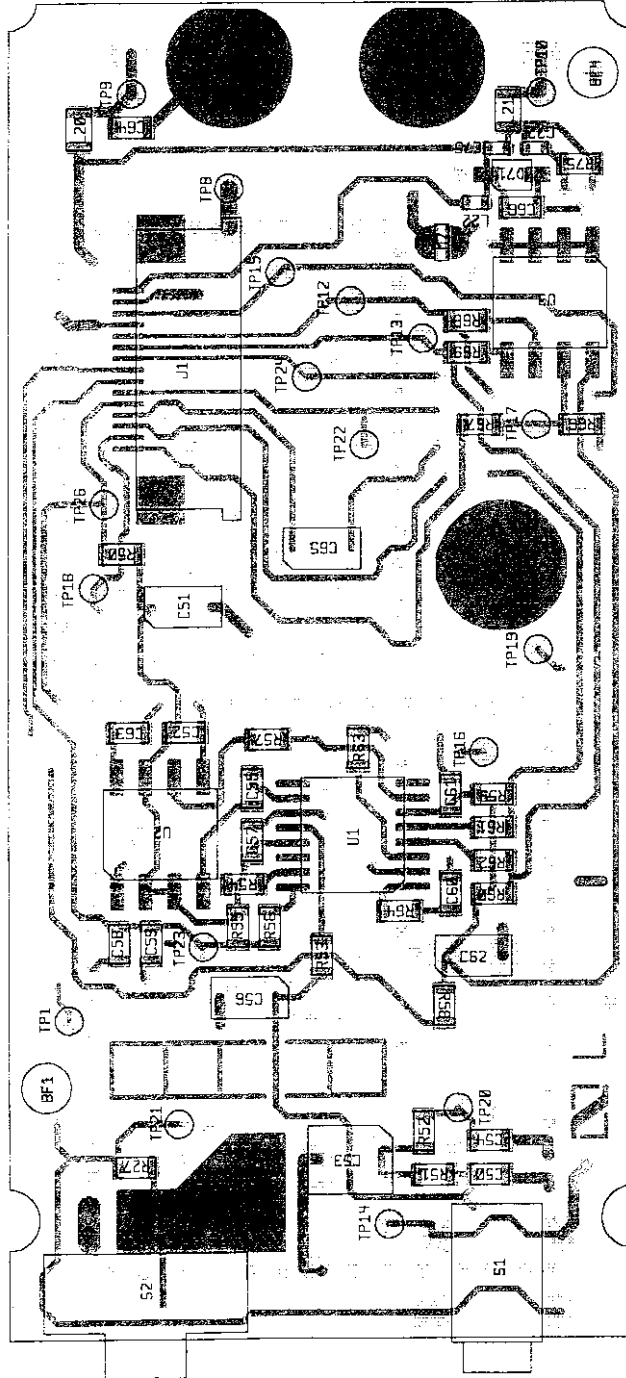

5.3.2.b RF-Module (back)

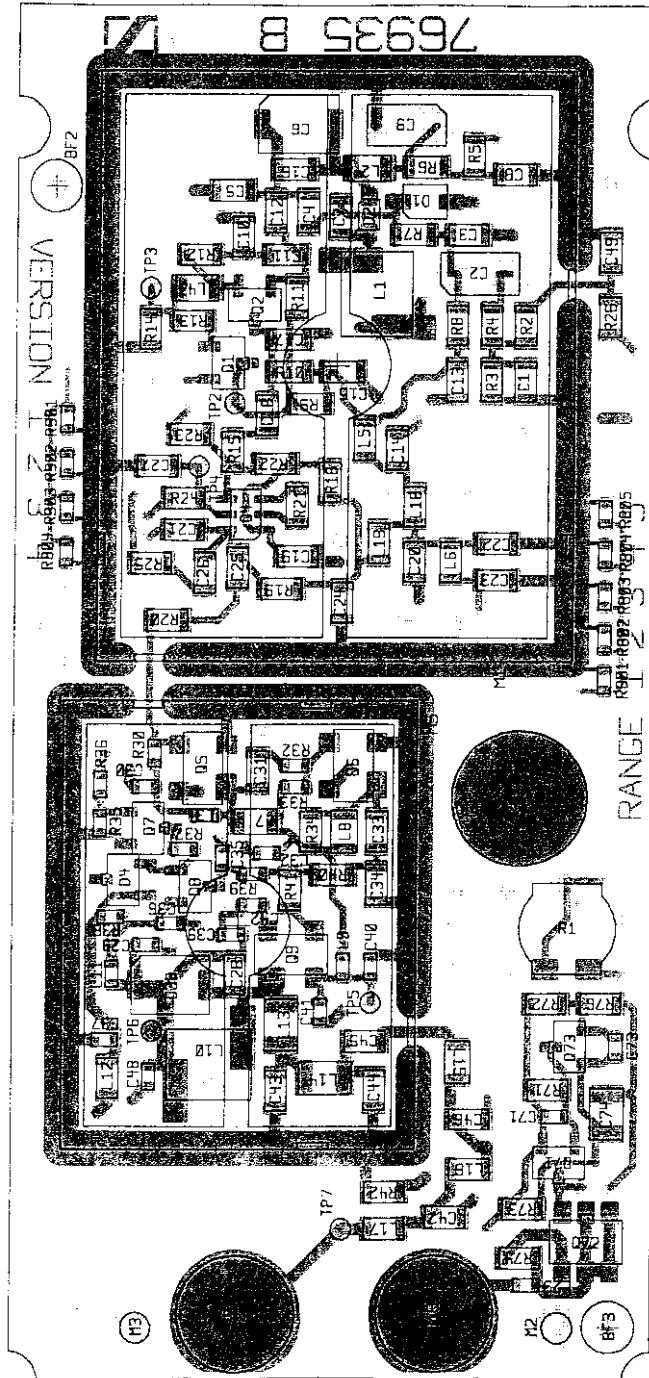

5.3.3.f Processor Module (front)

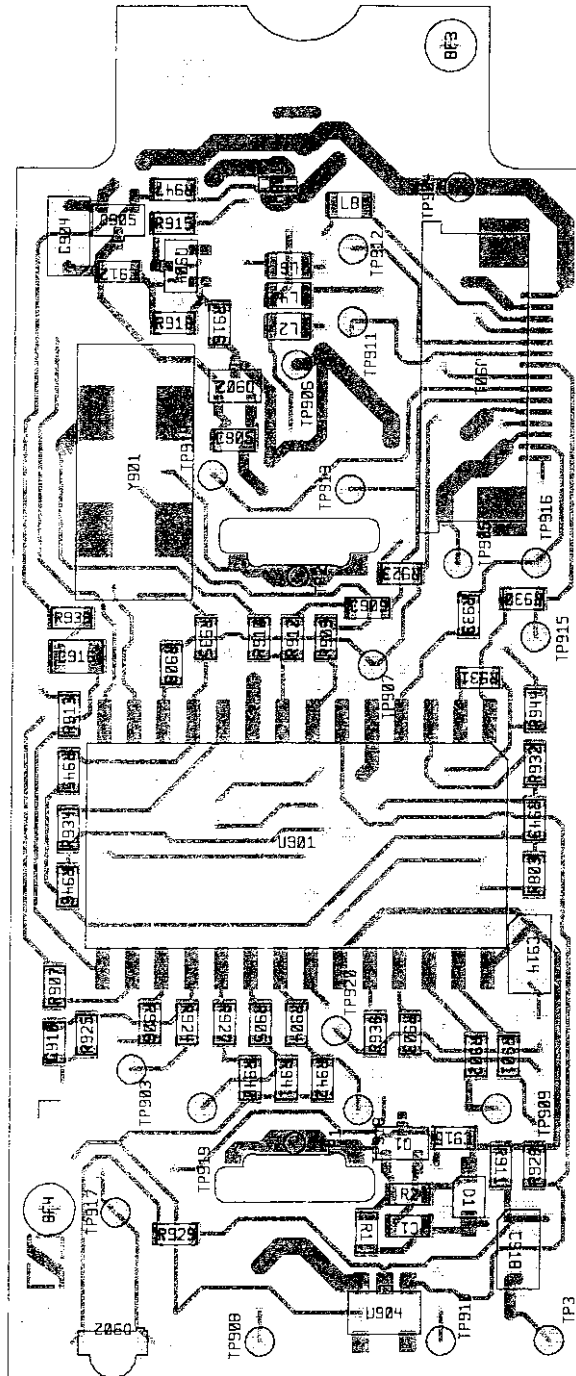



5.3.3.b Processor Module (back)

