

XS WIRELESS 1

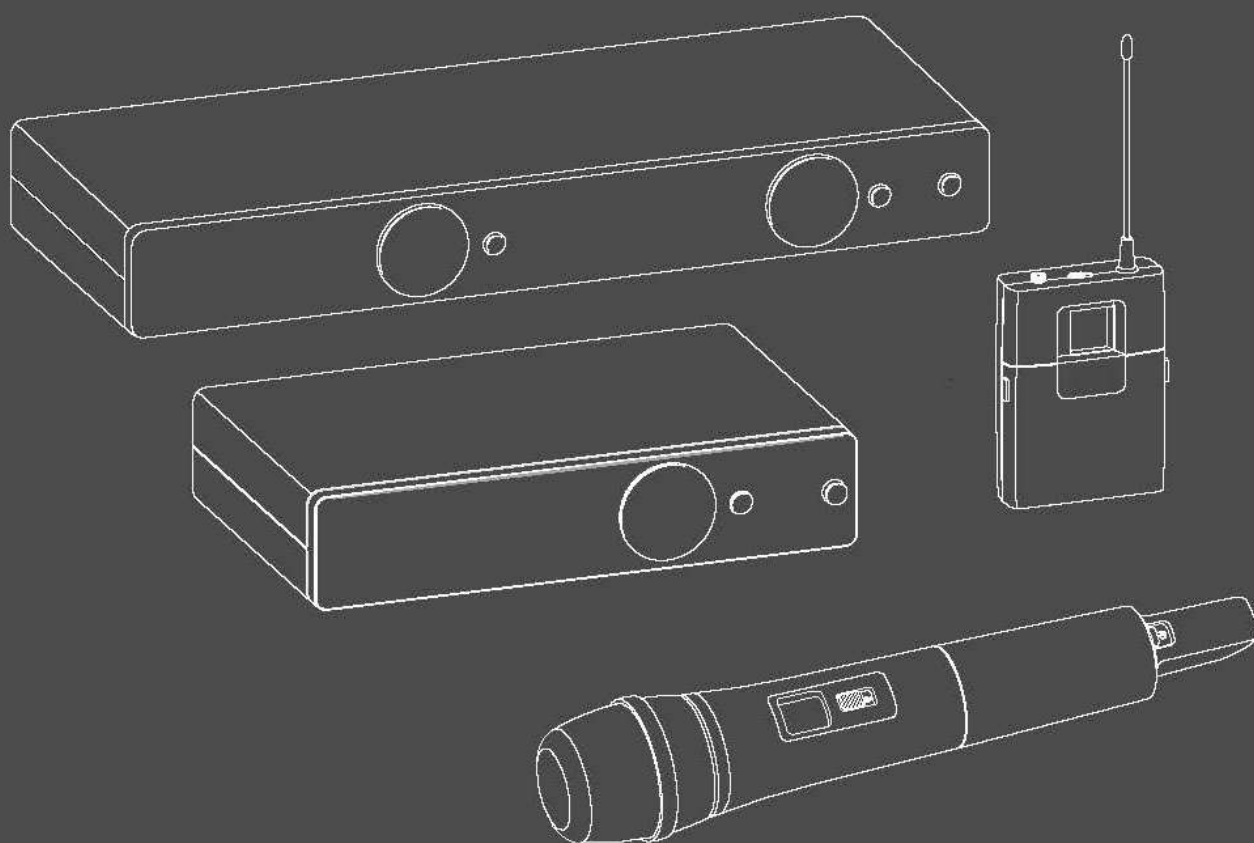

Technische Daten
Specifications
Caractéristiques techniques
Dati tecnici
Especificaciones técnicas
Dados técnicos
Technische specificaties
Dane techniczne

Tekniska data
Tekniska data
Tekniset tiedot
Τεχνικά χαρακτηριστικά
Технические характеристики
技术参数
기술 데이터

Specifications

System

Modulation	wideband FM
Frequency ranges	A: 548 to 572 MHz GB: 606 to 630 MHz B: 614 to 638 MHz C: 766 to 790 MHz D: 794 to 806 MHz E: 821 to 832 MHz and 863 to 865 MHz K: 925 to 937.5 MHz
Switching bandwidth	up to 24 MHz
Frequencies	8 frequency banks, each with up to 10 factory-preset channels
Signal-to-noise ratio	≥ 103 dBA
THD	≤ 0.9%
Temperature range	operation: 0°C to +40°C storage: -20°C to +70°C
Transmitter synchronization	2.4 GHz, Low Power OQPSK (only active during synchronization)

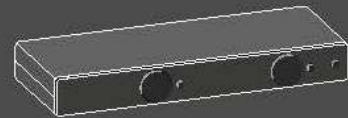

Receiver

	EM-XSW1	EM-XSW1 DUAL
Receiver principle	double superheterodyne	
Diversity principle	antenna switching diversity via internal antennas	
Sensitivity (at peak deviation)	< 3 μV at 52 dB(A) _{rms} S/N	
AF frequency response	50 to 16,000 Hz (-3 dB)	
Max. AF output voltage (at peak deviation, 1 kHz AF)	1/4" (6.3 mm) jack socket (unbalanced): +6 dBu XLR socket (balanced): +12 dBu	
Audio adjustment range	45 dB, adjustable in 5-dB steps	
Power supply	12 V $\overline{\text{DC}}$ nom. / 300 mA	12 V $\overline{\text{DC}}$ nom. / 500 mA
Squelch	adjustable from 3 dB μV to 28 dB μV (combined with pilot tone)	
Line/Mic level	20 dB, switchable	
Housing material	rugged ABS housing	
Dimensions (W x H x D)	approx. 200 x 42 x 127 mm	approx. 320 x 42 x 127 mm
Weight	approx. 340 g	approx. 610 g

DE

EN

FR

IT

ES

PT

NL

PL

SE

DK

FI

GR

RU

ZH

KO

COMPLIANCE

Specifications

System

Modulation	wideband FM
Frequency ranges	A: 548 to 572 MHz GB: 606 to 630 MHz B: 614 to 638 MHz C: 766 to 790 MHz D: 794 to 806 MHz E: 821 to 832 MHz and 863 to 865 MHz K: 925 to 937.5 MHz
Switching bandwidth	up to 24 MHz
Frequencies	8 frequency banks, each with up to 10 factory-preset channels
Signal-to-noise ratio	≥ 103 dBA
THD	$\leq 0.9\%$
Temperature range	operation: 0°C to +40°C storage: -20°C to +70°C
Transmitter synchronization	2.4 GHz, Low Power OQPSK (only active during synchronization)



Receiver

	EM-XSW1	EM-XSW1 DUAL
Receiver principle	double superheterodyne	
Diversity principle	antenna switching diversity via internal antennas	
Sensitivity (at peak deviation)	$< 3 \mu\text{V}$ at 52 dB(A) _{rms} S/N	
AF frequency response	50 to 16,000 Hz (-3 dB)	
Max. AF output voltage (at peak deviation, 1 kHz AF)	1/4" (6.3 mm) jack socket (unbalanced): +6 dBu XLR socket (balanced): +12 dBu	
Audio adjustment range	45 dB, adjustable in 5-dB steps	
Power supply	12 V $\overline{\text{---}}$ nom. / 300 mA	12 V $\overline{\text{---}}$ nom. / 500 mA
Squelch	adjustable from 3 dB μV to 28 dB μV (combined with pilot tone)	
Line/Mic level	20 dB, switchable	
Housing material	rugged ABS housing	
Dimensions (W x H x D)	approx. 200 x 42 x 127 mm	approx. 320 x 42 x 127 mm
Weight	approx. 340 g	approx. 610 g

DE
EN
FR
IT
ES
PT
NL
PL
SE
DK
FI
GR
RU
ZH
KO
COMPLIANCE

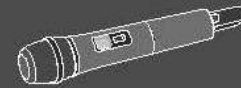

Transmitters

	SK-XSW	SKM-XSW	
		e 825	e 835
RF output power	10 mW		
AF frequency response	50 to 16,000 Hz (Line) 80 to 16,000 Hz (Mic)	80 to 14,000 Hz	80 to 16,000 Hz
Audio input	3.5 mm jack socket	–	
Max. input voltage (Mic/Line) at 3% THD	typ. 1.5 V _{RMS} Mic/ typ. 2.6 V _{RMS} Line @ –30 dB Gain	–	
Power supply	2 AA size batteries, 1.5 V	2 AA size batteries, 1.5 V	
Operating time	approx. 10 hours		
Microphone type	–	dynamic	
Input sensitivity (capsule)	–	1.5 mV/Pa	
Pick-up pattern	–	cardioid	
Adjustment range of transmitter sensitivity	0 to –30 dB, adjustable in 10-dB steps		
Housing material	rugged ABS housing		
Dimensions	approx. 71 x 96 x 28 mm (W x H x D)	approx. 260 x 50 mm (L x Ø)	
Weight	approx. 95 g	approx. 245 g	

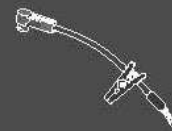
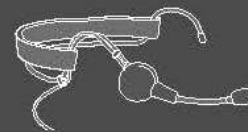

Microphones

	ME 2-2	ME 3-II	e 908T
Transducer principle	condenser, pre-polarized	condenser, pre-polarized	condenser, pre-polarized
Sensitivity	20 mV/Pa	1.6 mV/Pa	0.6 mV/Pa
Pick-up pattern	omni-directional	cardioid	Cardioid
Max. SPL	130 dB	150 dB	147 dB

NT 12-5CW power supply unit

Nominal input voltage	100 to 240 V~
Power frequency	50 or 60 Hz
Input current	≤ max. 200 mA
Nominal output voltage	12 V=
Output current	≤ 500 mA
Standby power consumption	≤ 0.075 W @230 V AC ≤ 0.1 W @115 V AC
Energy efficiency level	DoE Level VI
Temperature range	0°C to +40°C
Storage temperature	-20°C to +60°C
Relative air humidity	max. 95%
Weight (without adapter)	approx. 65 g
Cable length	approx. 1.83 m

Connector assignment

EM-XSW1

1/4" (6.3 mm) mono jack plug

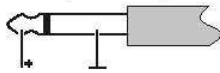

XLR-3 connector

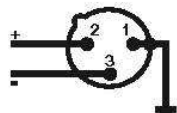

SK-XSW

3.5 mm jack plug

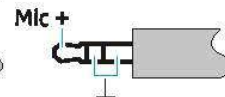
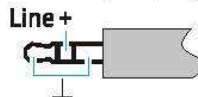

DE

EN

FR

IT

ES

PT

NL

PL

SE

DK

FI

GR

RU

ZH

KO

COMPLIANCE

Manufacturer Declarations

Warranty

Sennheiser electronic GmbH & Co. KG gives a warranty of 24 months on this product. For the current warranty conditions, please visit our website at www.sennheiser.com or contact your Sennheiser partner.

For Australia only

Sennheiser goods come with guarantees that cannot be excluded under the Australian Consumer Law. You are entitled to a replacement or refund for a major failure and compensation for any other reasonably foreseeable loss or damage. You are also entitled to have the goods repaired or replaced if the goods fail to be of acceptable quality and the failure does not amount to a major failure.

This warranty is in addition to other rights or remedies under law. Nothing in this warranty excludes, limits or modifies any liability of Sennheiser which is imposed by law, or limits or modifies any remedy available to the consumer which is granted by law.

To make a claim under this warranty, contact

Sennheiser Australia Pty Ltd, Unit 3, 31 Gibbes Street Chatswood NSW 2067, AUSTRALIA
Phone: (02) 9910 6700, email: service@sennheiser.com.au.

All expenses of claiming the warranty will be borne by the person making the claim.

The Sennheiser International Warranty is provided by
Sennheiser Australia Pty Ltd (ABN 68 165 388 312), Unit 3,
31 Gibbes Street Chatswood
NSW 2067 Australia.

In compliance with the following requirements

- WEEE Directive (2012/19/EU) 
- Battery Directive (2013/56/EU & 2006/66/EU) 

Notes on disposal

The symbol of the crossed-out wheeled bin on the product, the battery/rechargeable battery and/or the packaging indicates that these products must not be disposed of with normal household waste, but must be disposed of separately at the end of their operational lifetime.

Further information on the recycling of these products can be obtained from your municipal administration, from the municipal collection points, or from your Sennheiser partner.

The separate collection of waste electrical and electronic equipment, batteries/rechargeable batteries and packagings is used to promote the reuse and recycling and to prevent negative effects caused by e.g. potentially hazardous substances contained in these products. Herewith you make an important contribution to the protection of the environment and public health.

CE Declaration of Conformity



- RoHS Directive (2011/65/EU)
- EMC Directive (2014/30/EU)
- Low Voltage Directive (2014/35/EU)

Hereby, Sennheiser electronic GmbH & Co. KG declares that the radio equipment type XS WIRELESS 1 consisting of SKM-XSW, SK-XSW and EM-XSW1 is in compliance with Directive 2014/53/EU

The full text of this declaration is available at www.sennheiser.com/download.

Before putting into operation, please observe the respective country-specific regulations.

Information about approvals and certifications can be found in the "Compliance" section.

Statements regarding the FCC and Industry Canada rules

This device complies with Part 15 of the FCC Rules. Operation is subject to the following two conditions: (1) This device may not cause harmful interference, and (2) this device must accept any interference received, including interference that may cause undesired operation.

This equipment has been tested and found to comply with the limits for a Class B digital device, pursuant to part 15 of the FCC Rules. These limits are designed to provide reasonable protection against harmful interference in a residential installation. This equipment generates, uses and can radiate radio frequency energy and, if not installed and used in accordance with the instructions, may cause harmful interference to radio communications. However, there is no guarantee that interference will not occur in a particular installation. If this equipment does cause harmful interference to radio or television reception, which can be determined by turning the equipment off and on, the user is encouraged to try to correct the interference by one or more of the following measures:

- Reorient or relocate the receiving antenna.
- Increase the separation between the equipment and receiver.
- Connect the equipment into an outlet on a circuit different from that to which the receiver is connected.
- Consult the dealer or an experienced radio/ TV technician for help.

CAN ICES-3 (B)/NMB-3(B):

This Class B digital apparatus complies with the Canadian ICES-003. Changes or modifications not expressly approved by Sennheiser electronic Corp. could void the user's authority to operate the equipment.

DE

EN

FR

IT

ES

PT

NL

PL

SE

DK

FI

GR

RU

ZH

KO

COMPLIANCE

XS WIRELESS 1 DUAL

Quick Guide

Kurzanleitung | Guide rapide | Guida rapida | Guia de início rápido | Guia rápido | Beknopte handleiding | Krótka instrukcja obsługi | Snabbguide | Quickguide | Quick Guide | Γρήγορος οδηγός | Краткая инструкция | 快速指南 | 요약 설명서

In the box	Vocal Sets	
	XSW 1-825 DUAL	XSW 1-835 DUAL
XS WIRELESS 1 DUAL		
EM-XSW1 DUAL  NT 12-5CW	1	1
SKM-XSW e825 	2	-
SKM-XSW e835	-	2
MZQ 1 	2	2
AA LR6 1.5 V 	4	4

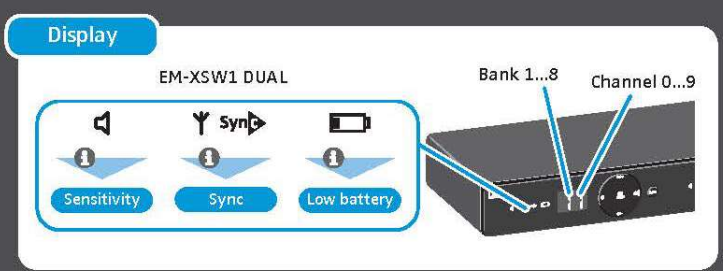
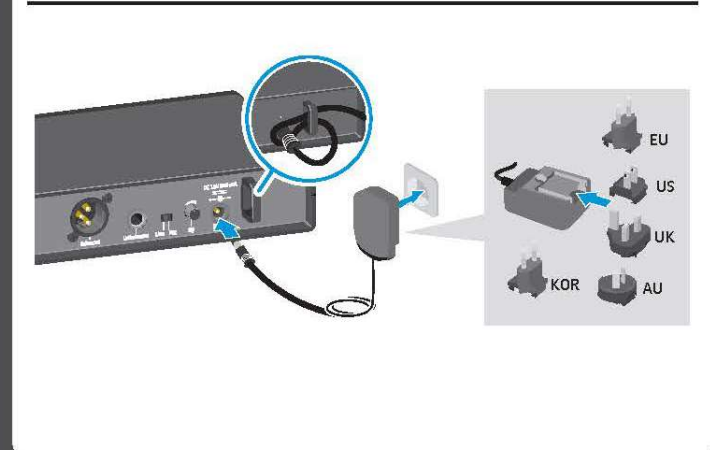
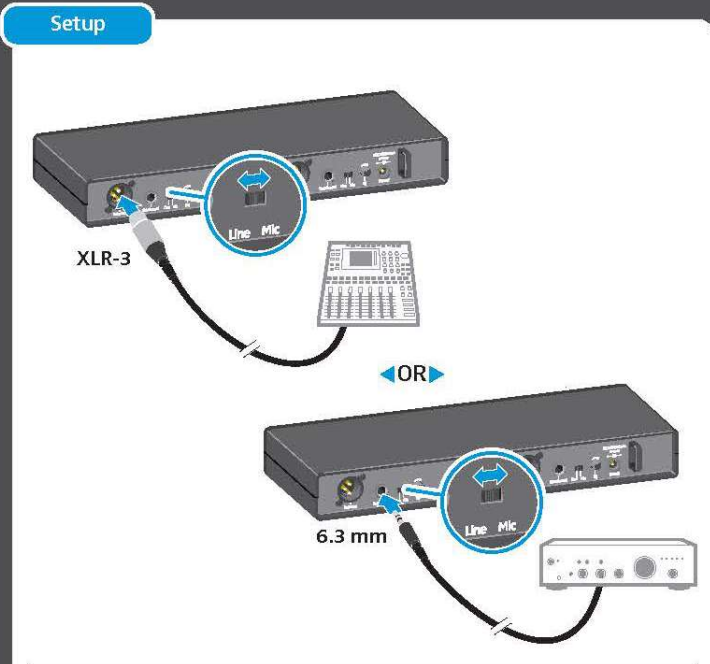
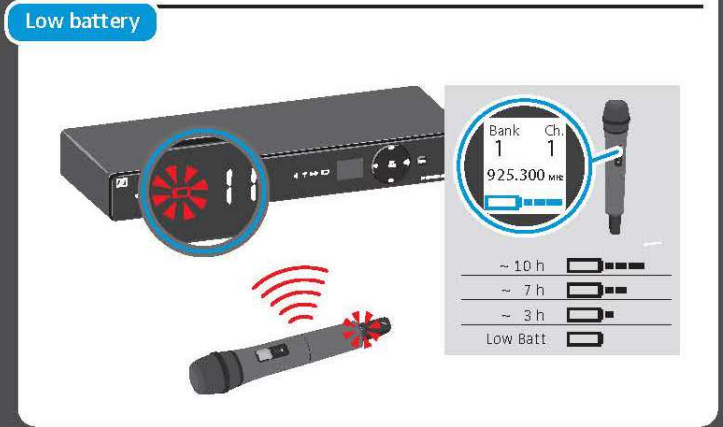
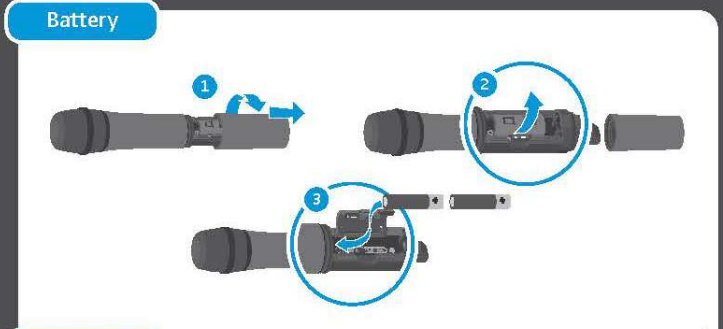

Change frequency

Automatically/Scan

Off

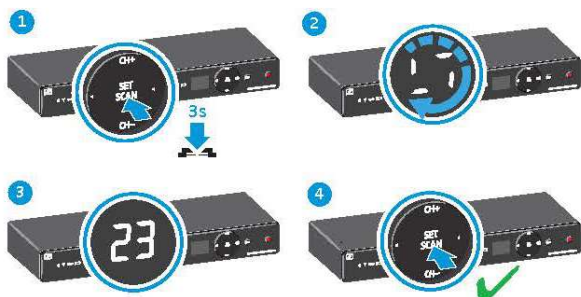

Manually

Bank Channel



Sync

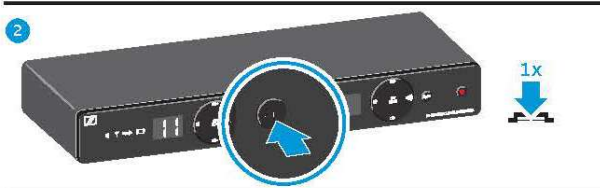
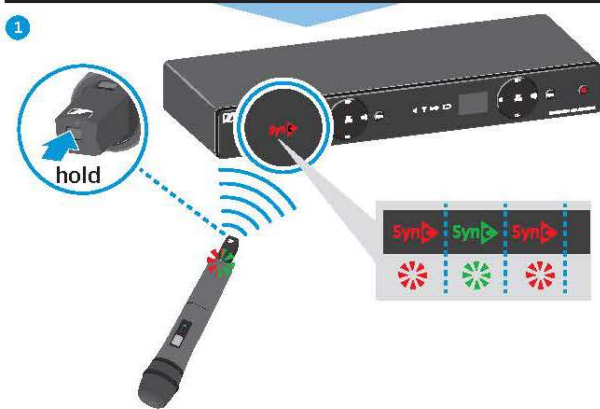

Multichannel

Bank 1...8
Ch. 0...9



Bank Ch.	Bank Ch.	Bank Ch.	Bank Ch.	
2 3	2 4	2 5	2 6	✓
1 1	1 2	1 3	1 8	✓
2 3	1 3	4 7	8 9	✗
2 3	2 3	2 3	2 3	✗

Sensitivity

0 dB
-10 dB

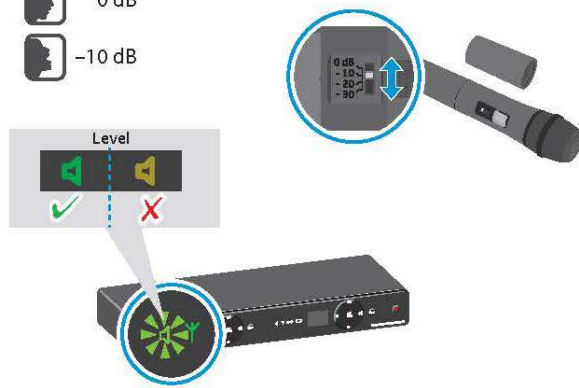

Squelch



Min. distance



SKM

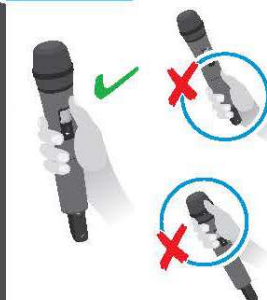



Sennheiser electronic GmbH & Co. KG

Am Labor 1, 30900 Wedemark, Germany

www.sennheiser.com

Printed in Taiwan, Publ. 01/18, 571314/A04