

**Antennas**

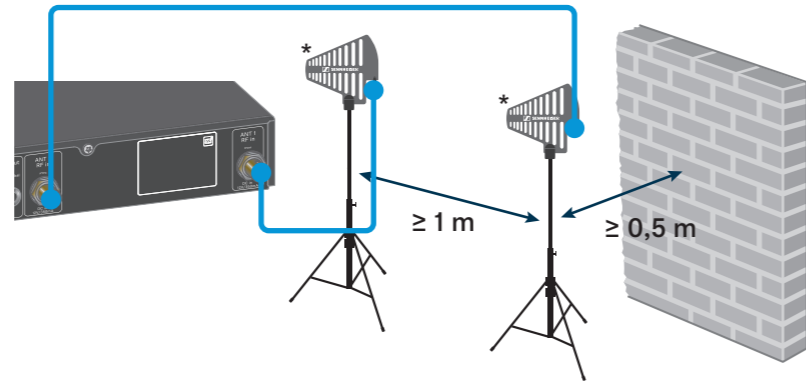

\*optional accessories:  
ADP UHF (470 - 1075 MHz)  
AD 1800 (1400 - 2400 MHz)



**EW-D Smart Assist**



**Sennheiser Documentation App**



or online at  
[www.sennheiser.com/download](http://www.sennheiser.com/download)  
EW-D\_

Sennheiser electronic GmbH & Co. KG

Am Labor 1, 30900 Wedemark, Germany  
[www.sennheiser.com](http://www.sennheiser.com)

Printed in Germany  
Publ. 04./20, 583962/A01



**Evolution Wireless Digital**

- Quick Guide
- Kurzanleitung
- Guide rapide
- Γρήγορος οδηγός
- Guida rapida
- Kısa Kılavuz
- Guía de inicio rápido
- Краткая инструкция
- Guia rápido
- Бекнопте handleiding
- クイックガイド
- Krótka instrukcja obsługi
- 퀵 가이드
- Snabbguide

**SENNHEISER**

**Audio Out**

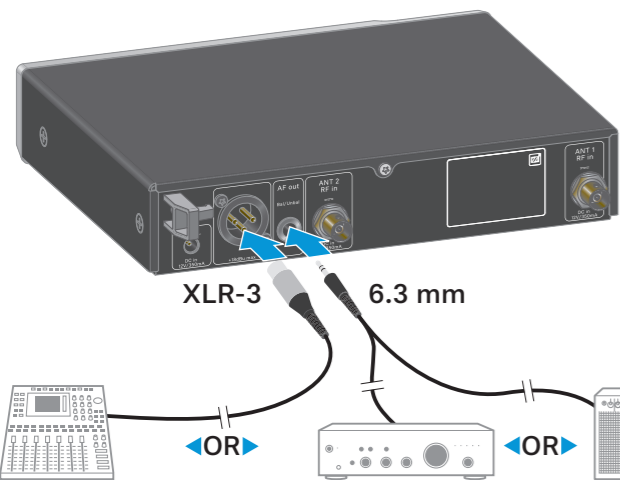

**Power supply**

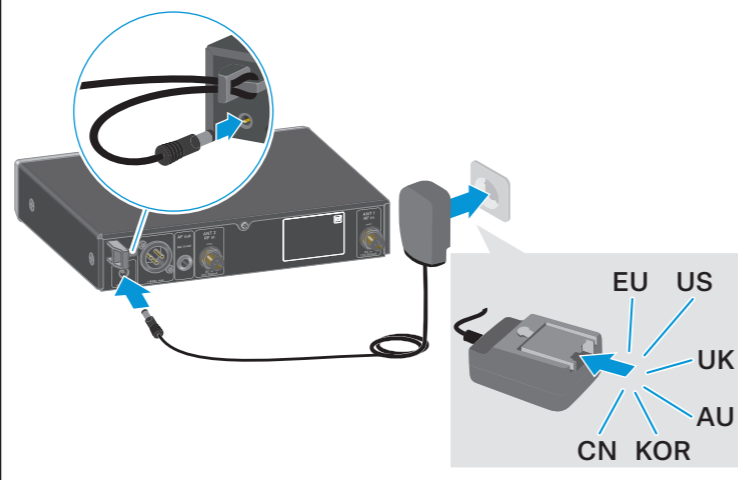

**EW-D Smart Assist**

The EW-D Smart Assist app simplifies your workflow

- EW-D Smart Assist app provides automated setup, operation and monitoring using any iOS or Android device
- Intelligent setup automatically creates reliable wireless connections, no wireless expertise required
- Mobile access to all system settings centralizes control and eliminates the need for complicated menu navigation on each device
- Easy frequency allocation and wireless channel naming help to keep systems organized



**In the box**

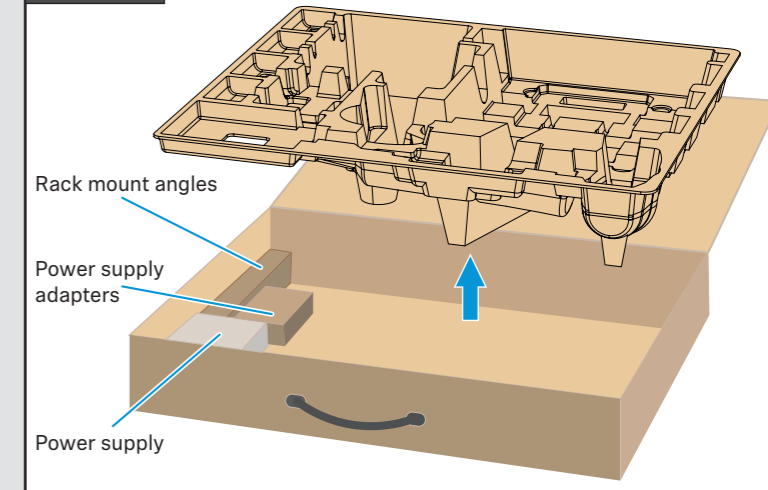

**Battery**

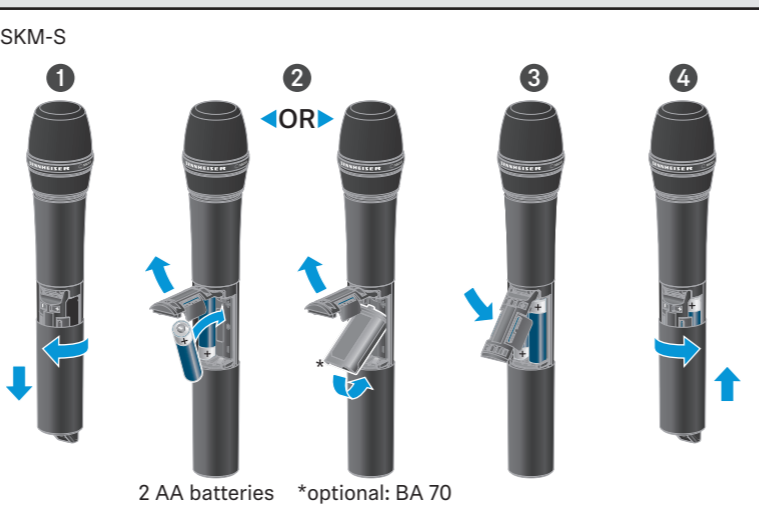
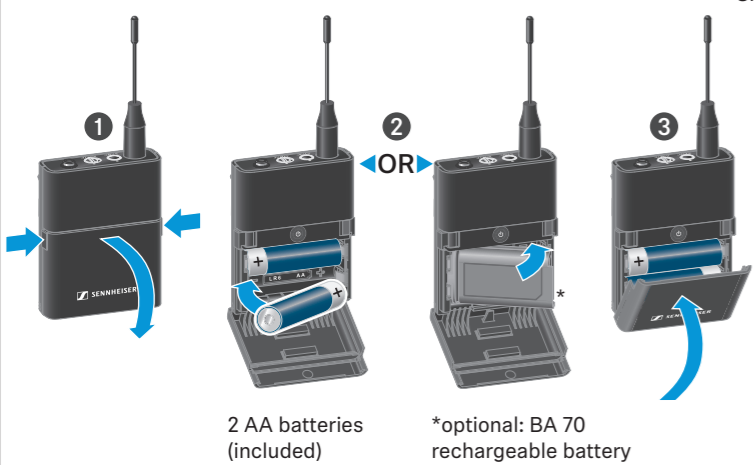

**EW-D EM**

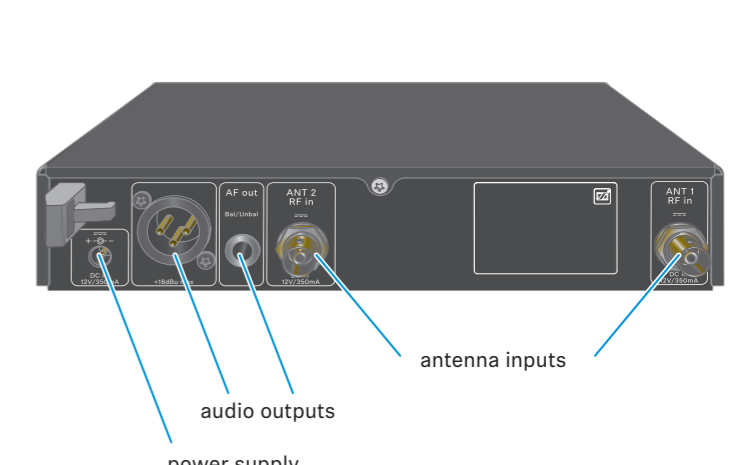
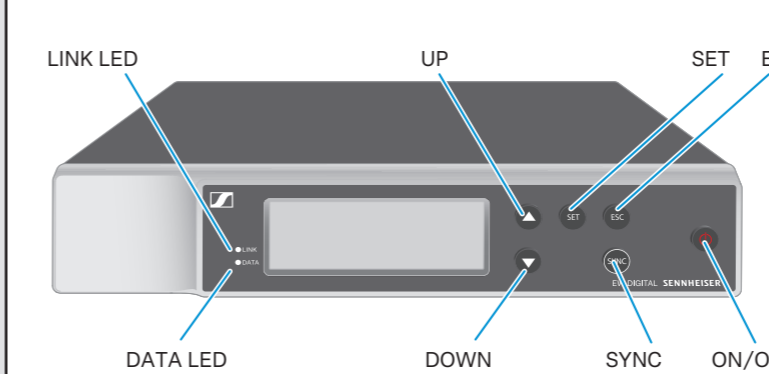

**On/Off**

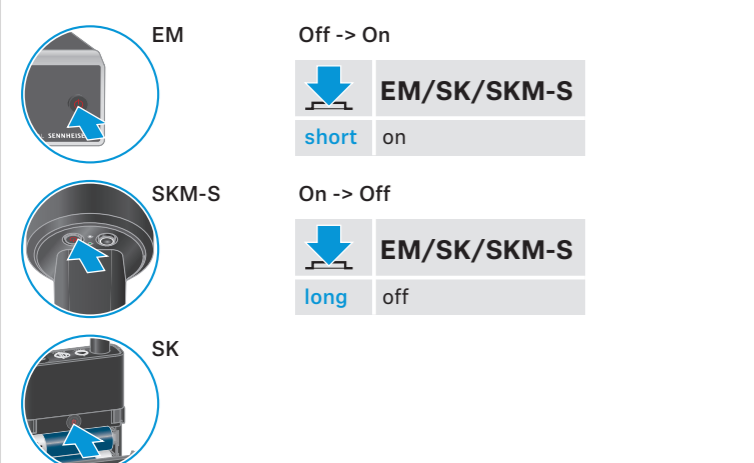

**Identify/Battery check**

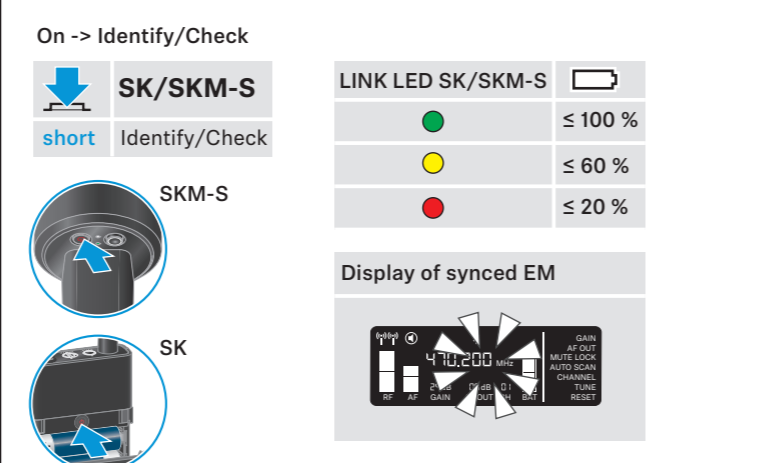

**EW-D SKM-S**

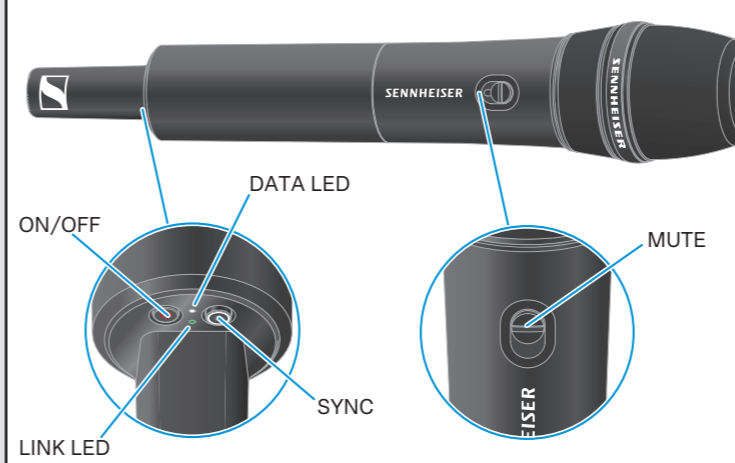

**EW-D SK**



**Display**

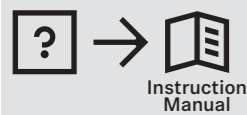
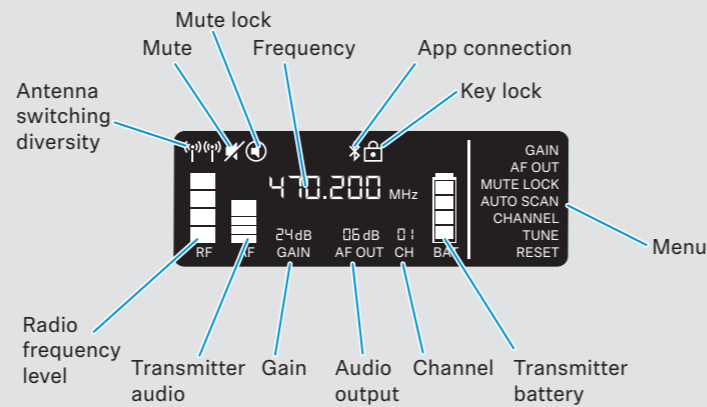
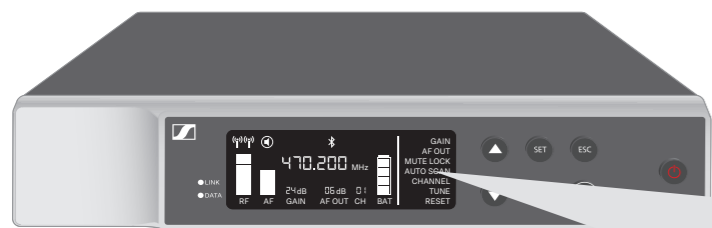

**Menu**

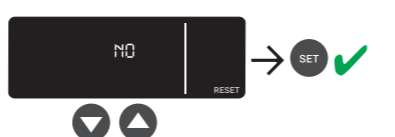
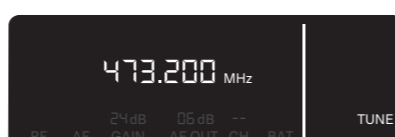
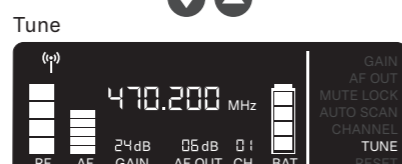
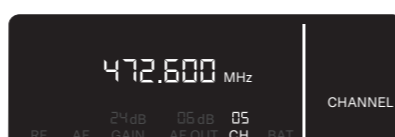
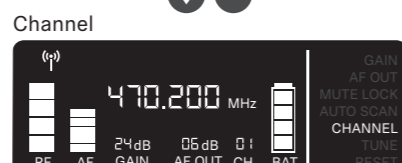
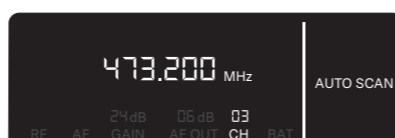
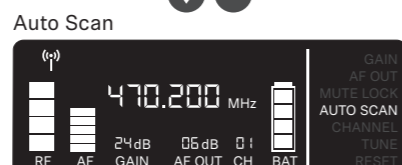
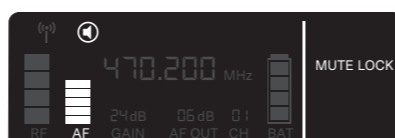
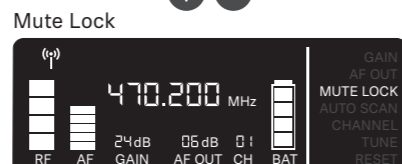
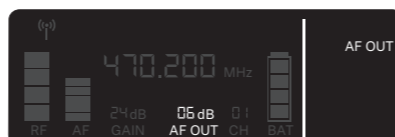
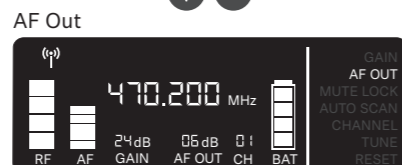
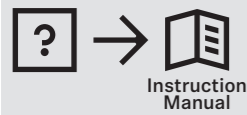
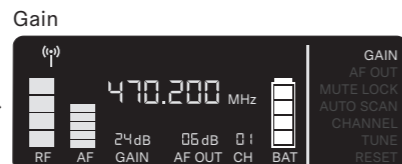
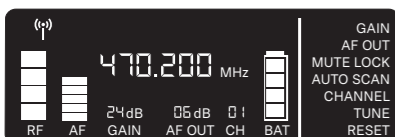

Instruction manual | Bedienungsanleitung | Notice d'emploi | Istruzioni per l'uso | Instrucciones de manejo | Manual de instruções | Gebruiksaanwijzing | Instrukcja obsługi | Bruksanvisning | Betjenings vejledning | Käyttöohje | Οδηγίες λειτουργίας | Kullanım kılavuzu | Инструкция по эксплуатации | 使用说明书 | 取扱説明書 | 사용 설명서 |

**EW-D Smart Assist**



**Sennheiser Documentation App**



**LEDs**

LINK LED	
	- Link ok - audio active
	- Link ok - audio muted or no capsule on SKM
	- Link ok - audio clip
	- No link
	- Link ok - Low transmitter battery
	- No link - Device switched off

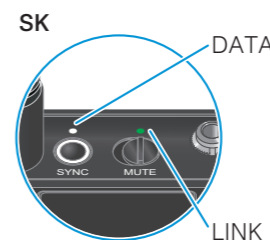
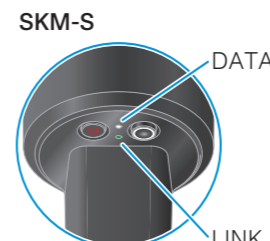
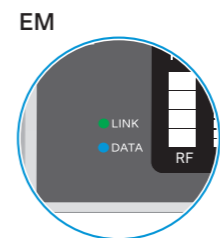

DATA LED	
	Bluetooth active to - sync with transmitter - connect with app
	Firmware update in progress



**Mute**

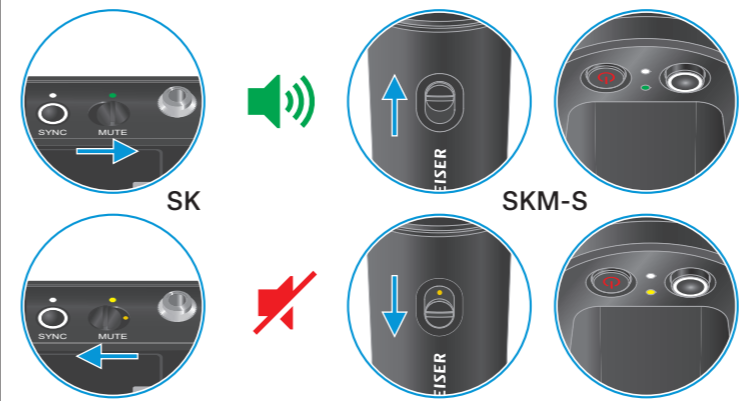

**Sync**

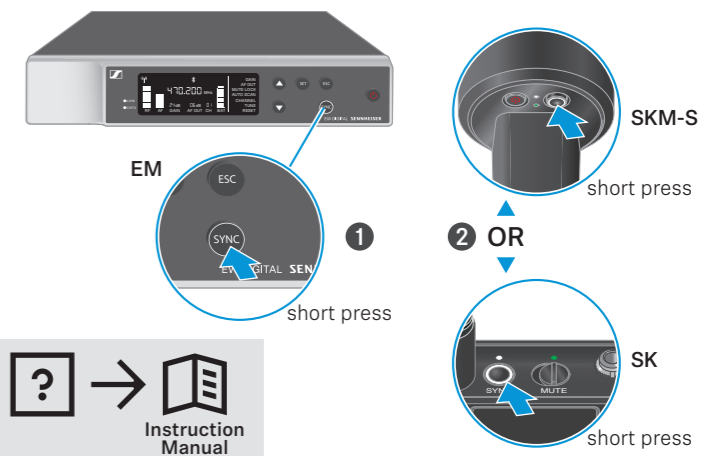

**Key lock**

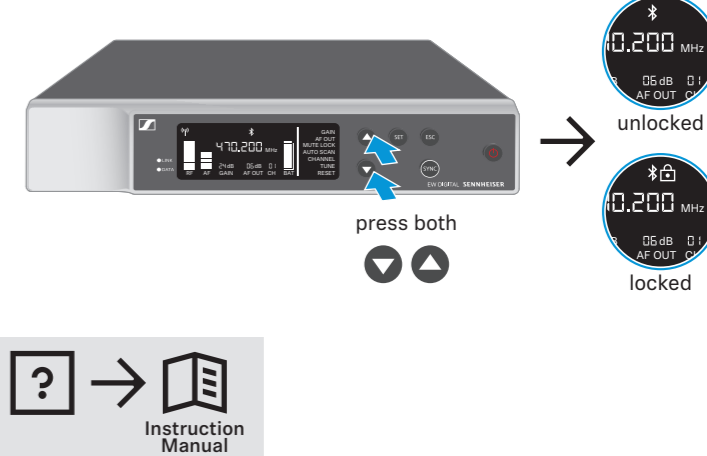

**Color coding sets**

