

FCC Test Report

Report No.: RF200508C01-1

FCC ID: DMOCX400TW1L

Test Model: CX400TW1 L

Received Date: May 08, 2020

Test Date: May 13 ~ May 21, 2020

Issued Date: Jun. 05, 2020

Applicant: Sennheiser electronic GmbH & Co. KG

Address: Am Labor 1, D-30900 Wedemark, Germany

Issued By: Bureau Veritas Consumer Products Services (H.K.) Ltd., Taoyuan Branch
Lin Kou Laboratories

Lab Address: No. 47-2, 14th Ling, Chia Pau Vil., Lin Kou Dist., New Taipei City, Taiwan

Test Location: No.19, Hwa Ya 2nd Rd., Wen Hwa Vil., Kwei Shan Dist., Taoyuan City
33383, Taiwan

**FCC Registration /
Designation Number:** 788550 / TW0003



This report is for your exclusive use. Any copying or replication of this report to or for any other person or entity, or use of our name or trademark, is permitted only with our prior written permission. This report sets forth our findings solely with respect to the test samples identified herein. The results set forth in this report are not indicative or representative of the quality or characteristics of the lot from which a test sample was taken or any similar or identical product unless specifically and expressly noted. Our report includes all of the tests requested by you and the results thereof based upon the information that you provided to us. You have 60 days from date of issuance of this report to notify us of any material error or omission caused by our negligence, provided, however, that such notice shall be in writing and shall specifically address the issue you wish to raise. A failure to raise such issue within the prescribed time shall constitute your unqualified acceptance of the completeness of this report, the tests conducted and the correctness of the report contents. Unless specific mention, the uncertainty of measurement has been explicitly taken into account to declare the compliance or non-compliance to the specification. The report must not be used by the client to claim product certification, approval, or endorsement by TAF or any government agencies.

Table of Contents

Release Control Record	4
1 Certificate of Conformity	5
2 Summary of Test Results.....	6
2.1 Measurement Uncertainty.....	6
2.2 Modification Record	6
3 General Information	7
3.1 General Description of EUT	7
3.2 Description of Test Modes.....	8
3.2.1 Test Mode Applicability and Tested Channel Detail.....	9
3.3 Duty Cycle of Test Signal	11
3.4 Description of Support Units	12
3.4.1 Configuration of System under Test	12
3.5 General Description of Applied Standards and References	12
4 Test Types and Results	13
4.1 Radiated Emission and Bandedge Measurement	13
4.1.1 Limits of Radiated Emission and Bandedge Measurement	13
4.1.2 Test Instruments	14
4.1.3 Test Procedures.....	15
4.1.4 Deviation from Test Standard	15
4.1.5 Test Set Up	16
4.1.6 EUT Operating Conditions.....	17
4.1.7 Test Results	18
4.2 Conducted Emission Measurement.....	40
4.2.1 Limits of Conducted Emission Measurement	40
4.2.2 Test Instruments	40
4.2.3 Test Procedures.....	40
4.2.4 Deviation from Test Standard	41
4.2.5 Test Setup.....	41
4.2.6 EUT Operating Conditions.....	41
4.2.7 Test Results	42
4.3 6 dB Bandwidth Measurement.....	50
4.3.1 Limits of 6 dB Bandwidth Measurement.....	50
4.3.2 Test Setup.....	50
4.3.3 Test Instruments	50
4.3.4 Test Procedure	50
4.3.5 Deviation from Test Standard	50
4.3.6 EUT Operating Conditions.....	50
4.3.7 Test Results	51
4.4 Occupied Bandwidth Measurement.....	53
4.4.1 Test Setup.....	53
4.4.2 Test Instruments	53
4.4.3 Test Procedure	53
4.4.4 Deviation from Test Standard	53
4.4.5 EUT Operating Conditions.....	53
4.4.6 Test Results	54
4.5 Conducted Output Power Measurement	56
4.5.1 Limits of Conducted Output Power Measurement.....	56
4.5.2 Test Setup.....	56
4.5.3 Test Instruments	56
4.5.4 Test Procedures.....	56
4.5.5 Deviation from Test Standard	56
4.5.6 EUT Operating Conditions.....	56
4.5.7 Test Results	57

4.6	Power Spectral Density Measurement	58
4.6.1	Limits of Power Spectral Density Measurement.....	58
4.6.2	Test Setup.....	58
4.6.3	Test Instruments	58
4.6.4	Test Procedure	58
4.6.5	Deviation from Test Standard	58
4.6.6	EUT Operating Condition	58
4.6.7	Test Results	59
4.7	Conducted Out of Band Emission Measurement	61
4.7.1	Limits of Conducted Out of Band Emission Measurement.....	61
4.7.2	Test Setup.....	61
4.7.3	Test Instruments	61
4.7.4	Test Procedure	61
4.7.5	Deviation from Test Standard	61
4.7.6	EUT Operating Condition	61
4.7.7	Test Results	62
5	Photographs of the Test Configuration.....	64
6	Construction Photos of EUT	65
	Appendix – Information of the Testing Laboratories	66

Release Control Record

Issue No.	Description	Date Issued
RF200508C01-1	Original Release	Jun. 05, 2020

1 Certificate of Conformity

Product: CX True Wireless (CX400TW1)

Brand: SENNHEISER

Test Model: CX400TW1 L

Sample Status: Engineering Sample

Applicant: Sennheiser electronic GmbH & Co. KG

Test Date: May 13 ~ May 21, 2020

Standards: 47 CFR FCC Part 15, Subpart C (Section 15.247)
ANSI C63.10:2013

The above equipment has been tested by **Bureau Veritas Consumer Products Services (H.K.) Ltd., Taoyuan Branch**, and found compliance with the requirement of the above standards. The test record, data evaluation & Equipment Under Test (EUT) configurations represented herein are true and accurate accounts of the measurements of the sample's RF characteristics under the conditions specified in this report.

Prepared by : Gina Liu, **Date:** Jun. 05, 2020
Gina Liu / Specialist

Approved by : Dylan Chiou, **Date:** Jun. 05, 2020
Dylan Chiou / Senior Project Engineer

2 Summary of Test Results

47 CFR FCC Part 15, Subpart C (Section 15.247)			
FCC Clause	Test Item	Result	Remarks
15.207	AC Power Conducted Emission	Pass	Meet the requirement of limit. Minimum passing margin is -11.71 dB at 0.17000 MHz.
15.205 & 209	Radiated Emissions	Pass	Meet the requirement of limit. Minimum passing margin is -8.37 dB at 33.88 MHz.
15.247(d)	Band Edge Measurement	Pass	Meet the requirement of limit.
15.247(d)	Antenna Port Emission	Pass	Meet the requirement of limit.
15.247(a)(2)	6 dB Bandwidth	Pass	Meet the requirement of limit.
---	Occupied Bandwidth Measurement	Pass	Reference only
15.247(b)	Conducted Power	Pass	Meet the requirement of limit.
15.247(e)	Power Spectral Density	Pass	Meet the requirement of limit.
15.203	Antenna Requirement	Pass	No antenna connector is used.

Note: Determining compliance based on the results of the compliance measurement, not taking into account measurement instrumentation uncertainty.

2.1 Measurement Uncertainty

Where relevant, the following measurement uncertainty levels have been estimated for tests performed on the EUT as specified in CISPR 16-4-2:

Measurement	Frequency	Expanded Uncertainty (k=2) (\pm)
Conducted Emissions at mains ports	150 kHz ~ 30 MHz	2.79 dB
Radiated Emissions up to 1 GHz	9 kHz ~ 30 MHz	3.04 dB
	30 MHz ~ 200 MHz	2.93 dB
	200 MHz ~ 1000 MHz	2.95 dB
Radiated Emissions above 1 GHz	1 GHz ~ 18 GHz	2.26 dB
	18 GHz ~ 40 GHz	1.94 dB

2.2 Modification Record

There were no modifications required for compliance.

3 General Information

3.1 General Description of EUT

Product	CX True Wireless (CX400TW1)
Brand	SENNHEISER
Test Model	CX400TW1 L
Status of EUT	Engineering Sample
Power Supply Rating	5Vdc from USB interface 3.7Vdc from battery (a) Earbuds: 54-60mAh (b) Charging Case: 400-420mAh
Modulation Type	GFSK
Transfer Rate	LE 4.0: 1 Mbps LE 5.1: 2 Mbps
Operating Frequency	2402 ~ 2480 MHz
Number of Channel	40
Output Power	LE 4.0: 7.834 mW LE 5.1: 7.727 mW
Antenna Type	MONOPOLE antenna with -2.42 dBi gain
Antenna Connector	N/A
Accessory Device	Refer to Note as below
Data Cable Supplied	0.2m shielded USB cable without core

Note:

- The EUT system CX True Wireless (CX400TW1), contain the following devices:

Item	Brand	Device Model
Right Earbud	SENNHEISER	CX400TW1 R
Left Earbud	SENNHEISER	CX400TW1 L
Charging Case	SENNHEISER	CX400TW1 C

* CX400TW1 R and CX400TW1 L with BT & BT LE TX/RX function

* Charging case is solely used for charging CX400TW1 R and CX400TW1 L only

- The above EUT information is declared by manufacturer and for more detailed features description, please refers to the manufacturer's specifications or User's Manual.

3.2 Description of Test Modes

40 channels are provided to this EUT:

Channel	Freq. (MHz)	Channel	Freq. (MHz)	Channel	Freq. (MHz)	Channel	Freq. (MHz)
0	2402	10	2422	20	2442	30	2462
1	2404	11	2424	21	2444	31	2464
2	2406	12	2426	22	2446	32	2466
3	2408	13	2428	23	2448	33	2468
4	2410	14	2430	24	2450	34	2470
5	2412	15	2432	25	2452	35	2472
6	2414	16	2434	26	2454	36	2474
7	2416	17	2436	27	2456	37	2476
8	2418	18	2438	28	2458	38	2478
9	2420	19	2440	29	2460	39	2480

3.2.1 Test Mode Applicability and Tested Channel Detail

<LE 4.0>

EUT Configure Mode	Applicable To				Description
	RE \geq 1G	RE $<$ 1G	PLC	APCM	
A	√	√	-	√	EUT (Left Earbud (main battery cell))
B	-	√	-	-	EUT (Left Earbud (alternative battery cell))
C	-	√	√	-	EUT (Left Earbud + Right Earbud + Charging case (main battery))
D	-	√	√	-	EUT (Left Earbud + Right Earbud + Charging case (alternative battery))

Where **RE \geq 1G**: Radiated Emission above 1 GHz
PLC: Power Line Conducted Emission

RE $<$ 1G: Radiated Emission below 1 GHz
APCM: Antenna Port Conducted Measurement

Note: The EUT had been pre-tested on the positioned of each 3 axis. The worst case was found when positioned on **Z-plane**.

Note: "-" means no effect.

Radiated Emission Test (Above 1 GHz):

- Pre-Scan has been conducted to determine the worst-case mode from all possible combinations between available modulations, data rates and antenna ports (if EUT with antenna diversity architecture).
- Following channel(s) was (were) selected for the final test as listed below.

EUT Configure Mode	Available Channel	Tested Channel	Modulation Type	Data Rate (Mbps)
A	0 to 39	0, 19, 39	GFSK	1

Radiated Emission Test (Below 1 GHz):

- Pre-Scan has been conducted to determine the worst-case mode from all possible combinations between available modulations, data rates and antenna ports (if EUT with antenna diversity architecture).
- Following channel(s) was (were) selected for the final test as listed below.

EUT Configure Mode	Available Channel	Tested Channel	Modulation Type	Data Rate (Mbps)
A, B, C, D	0 to 39	19	GFSK	1

Power Line Conducted Emission Test:

- Pre-Scan has been conducted to determine the worst-case mode from all possible combinations between available modulations, data rates and antenna ports (if EUT with antenna diversity architecture).
- Following channel(s) was (were) selected for the final test as listed below.

EUT Configure Mode	Available Channel	Tested Channel	Modulation Type	Data Rate (Mbps)
C, D	0 to 39	19	GFSK	1

Antenna Port Conducted Measurement:

- This item includes all test value of each mode, but only includes spectrum plot of worst value of each mode.
- Pre-Scan has been conducted to determine the worst-case mode from all possible combinations between available modulations, data rates and antenna ports (if EUT with antenna diversity architecture).
- Following channel(s) was (were) selected for the final test as listed below.

EUT Configure Mode	Available Channel	Tested Channel	Modulation Type	Data Rate (Mbps)
A	0 to 39	0, 19, 39	GFSK	1

<LE 5.1>

EUT Configure Mode	Applicable To				Description
	RE≥1G	RE<1G	PLC	APCM	
A	√	√	-	√	EUT (Left Earbud (main battery cell))
B	-	√	-	-	EUT (Left Earbud (alternative battery cell))
C	-	√	√	-	EUT (Left Earbud + Right Earbud + Charging case (main battery))
D	-	√	√	-	EUT (Left Earbud + Right Earbud + Charging case (alternative battery))

Where **RE≥1G**: Radiated Emission above 1 GHz **RE<1G**: Radiated Emission below 1 GHz
PLC: Power Line Conducted Emission **APCM**: Antenna Port Conducted Measurement

Note: The EUT had been pre-tested on the positioned of each 3 axis. The worst case was found when positioned on **Z-plane**.
Note: “-” means no effect.

Radiated Emission Test (Above 1 GHz):

- Pre-Scan has been conducted to determine the worst-case mode from all possible combinations between available modulations, data rates and antenna ports (if EUT with antenna diversity architecture).
- Following channel(s) was (were) selected for the final test as listed below.

EUT Configure Mode	Available Channel	Tested Channel	Modulation Type	Data Rate (Mbps)
A	0 to 39	0, 19, 39	GFSK	2

Radiated Emission Test (Below 1 GHz):

- Pre-Scan has been conducted to determine the worst-case mode from all possible combinations between available modulations, data rates and antenna ports (if EUT with antenna diversity architecture).
- Following channel(s) was (were) selected for the final test as listed below.

EUT Configure Mode	Available Channel	Tested Channel	Modulation Type	Data Rate (Mbps)
A, B, C, D	0 to 39	19	GFSK	2

Power Line Conducted Emission Test:

- Pre-Scan has been conducted to determine the worst-case mode from all possible combinations between available modulations, data rates and antenna ports (if EUT with antenna diversity architecture).
- Following channel(s) was (were) selected for the final test as listed below.

EUT Configure Mode	Available Channel	Tested Channel	Modulation Type	Data Rate (Mbps)
C, D	0 to 39	19	GFSK	2

Antenna Port Conducted Measurement:

- This item includes all test value of each mode, but only includes spectrum plot of worst value of each mode.
- Pre-Scan has been conducted to determine the worst-case mode from all possible combinations between available modulations, data rates and antenna ports (if EUT with antenna diversity architecture).
- Following channel(s) was (were) selected for the final test as listed below.

EUT Configure Mode	Available Channel	Tested Channel	Modulation Type	Data Rate (Mbps)
A	0 to 39	0, 19, 39	GFSK	2

Test Condition:

Applicable To	Environmental Conditions	Input Power	Tested by
RE≥1G	25 deg. C, 65 % RH	3.7 Vdc	Getaz Yang, Tim Chen
RE<1G	25 deg. C, 65 % RH	3.7 Vdc, 120 Vac, 60Hz	Tim Chen
PLC	25 deg. C, 65 % RH	120 Vac, 60 Hz	Jisyong Wang
APCM	25 deg. C, 65 % RH	3.7 Vdc	Wayne Lin

3.3 Duty Cycle of Test Signal

<LE 4.0>

Duty cycle = 0.384/0.625 = 0.614, Duty factor = 10 * log(1/0.614) = 2.12

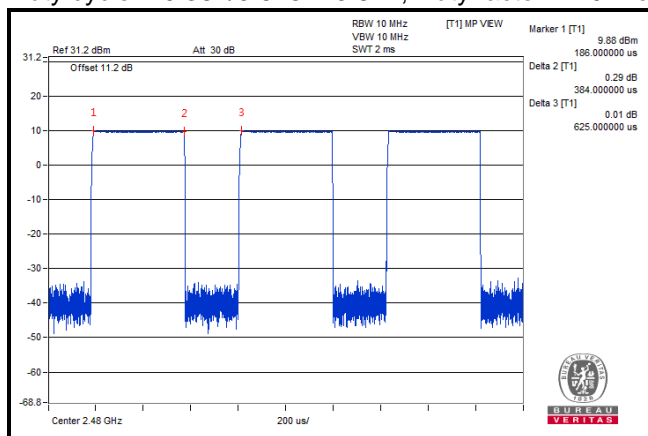

<LE 5.1>

Duty cycle = 0.198/0.624 = 0.317, Duty factor = 10 * log(1/0.317) = 4.99

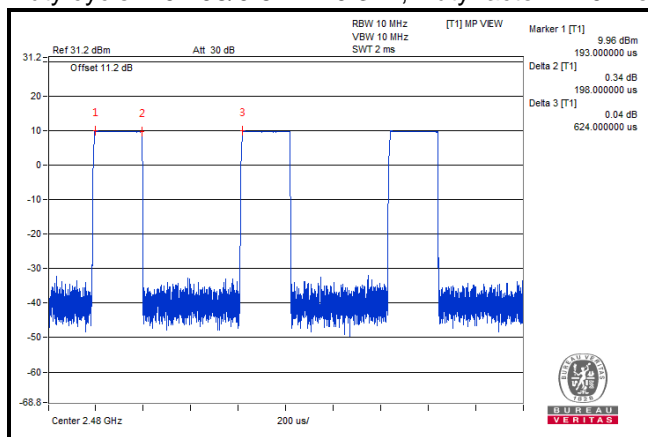

3.4 Description of Support Units

The EUT has been tested as an independent unit together with other necessary accessories or support units. The following support units or accessories were used to form a representative test configuration during the tests.

ID	Product	Brand	Model No.	Serial No.	FCC ID	Remarks
1.	Adapter	ASUS	AD827M	NA	NA	-

3.4.1 Configuration of System under Test

Test Mode A, B



Test Mode C, D

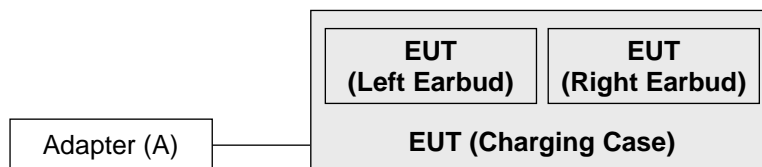

3.5 General Description of Applied Standards and References

The EUT is a RF Product. According to the specifications of the manufacturer, it must comply with the requirements of the following standards and references:

Test Standard:

FCC Part 15, Subpart C (15.247)

ANSI C63.10-2013

All test items have been performed and recorded as per the above standards.

References Test Guidance:

KDB 558074 D01 15.247 Meas Guidance v05r02

All test items have been performed as a reference to the above KDB test guidance.

4 Test Types and Results

4.1 Radiated Emission and Bandedge Measurement

4.1.1 Limits of Radiated Emission and Bandedge Measurement

Radiated emissions which fall in the restricted bands must comply with the radiated emission limits specified as below table. Other emissions shall be at least 20 dB below the highest level of the desired power:

Frequencies (MHz)	Field Strength (microvolts/meter)	Measurement Distance (meters)
0.009 ~ 0.490	2400/F (kHz)	300
0.490 ~ 1.705	24000/F (kHz)	30
1.705 ~ 30.0	30	30
30 ~ 88	100	3
88 ~ 216	150	3
216 ~ 960	200	3
Above 960	500	3

Note:

1. The lower limit shall apply at the transition frequencies.
2. Emission level (dBuV/m) = 20 log Emission level (uV/m).
3. For frequencies above 1000 MHz, the field strength limits are based on average detector, however, the peak field strength of any emission shall not exceed the maximum permitted average limits, specified above by more than 20 dB under any condition of modulation.

4.1.2 Test Instruments

Description & Manufacturer	Model No.	Serial No.	Date of Calibration	Due Date of Calibration
Test Receiver Agilent	N9038A	MY51210203	Mar. 18, 2020	Mar. 17, 2021
Spectrum Analyzer Agilent	N9010A	MY52220314	Dec. 12, 2019	Dec. 11, 2020
Spectrum Analyzer ROHDE & SCHWARZ	FSU43	101261	Apr. 16, 2020	Apr. 15, 2021
Broadband Horn Antenna SCHWARZBECK	BBHA 9170	148	Nov. 24, 2019	Nov. 23, 2020
HORN Antenna SCHWARZBECK	BBHA 9120D	9120D-969	Nov. 24, 2019	Nov. 23, 2020
BILOG Antenna SCHWARZBECK	VULB 9168	9168-472	Nov. 08, 2019	Nov. 07, 2020
MXG Vector signal generator Agilent	N5182B	MY53050430	Oct. 25, 2019	Oct. 24, 2020
Loop Antenna	EM-6879	269	Sep. 16, 2019	Sep. 15, 2020
Preamplifier EMCI	EMC001340	980201	Oct. 14, 2019	Oct. 13, 2020
Preamplifier EMCI	EMC 012645	980115	Oct. 08, 2019	Oct. 07, 2020
Preamplifier EMCI	EMC 184045	980116	Oct. 08, 2019	Oct. 07, 2020
Preamplifier EMCI	EMC 330H	980112	Oct. 08, 2019	Oct. 07, 2020
Power Meter Anritsu	ML2495A	1012010	Sep. 04, 2019	Sep. 03, 2020
Power Sensor Anritsu	MA2411B	1315050	Sep. 04, 2019	Sep. 03, 2020
RF Coaxial Cable HUBER+SUHNNER	EMC104-SM-SM-8 000&3000	140811+170717	Oct. 08, 2019	Oct. 07, 2020
RF Coaxial Cable HUBER+SUHNNER	SUCOFLEX 104	EMC104-SM-SM-1 000(140807)	Oct. 08, 2019	Oct. 07, 2020
RF Coaxial Cable WOKEN	8D-FB	Cable-Ch10-01	Oct. 08, 2019	Oct. 07, 2020
Boresight Antenna Fixture	FBA-01	FBA-SIP01	NA	NA
Software BV ADT	E3 6.120103	NA	NA	NA
Antenna Tower MF	MFA-440H	NA	NA	NA
Turn Table MF	MFT-201SS	NA	NA	NA
Antenna Tower & Turn Table Controller MF	MF-7802	NA	NA	NA

- Note: 1. The calibration interval of the above test instruments is 12 months and the calibrations are traceable to NML/ROC and NIST/USA.
2. The test was performed in HwaYa Chamber 10.

4.1.3 Test Procedures

For Radiated Emission below 30 MHz

- a. The EUT was placed on the top of a rotating table 0.8 meters above the ground at a 3 meter chamber room. The table was rotated 360 degrees to determine the position of the highest radiation.
- b. The EUT was set 3 meters away from the interference-receiving antenna, which was mounted on the top of a variable-height antenna tower.
- c. Parallel, perpendicular, and ground-parallel orientations of the antenna are set to make the measurement.
- d. For each suspected emission, the EUT was arranged to its worst case and the rotatable table was turned from 0 degrees to 360 degrees to find the maximum reading.
- e. The test-receiver system was set to Quasi-Peak Detect Function and Specified Bandwidth with Maximum Hold Mode.

Note:

1. The resolution bandwidth and video bandwidth of test receiver/spectrum analyzer is 9 kHz at frequency below 30 MHz.

For Radiated Emission above 30 MHz

- a. The EUT was placed on the top of a rotating table 0.8 meters (for 30 MHz ~ 1 GHz) / 1.5 meters (for above 1 GHz) above the ground at 3 meter chamber room for test. The table was rotated 360 degrees to determine the position of the highest radiation.
- b. The EUT was set 3 meters away from the interference-receiving antenna, which was mounted on the top of a variable-height antenna tower.
- c. The height of antenna is varied from one meter to four meters above the ground to determine the maximum value of the field strength. Both horizontal and vertical polarizations of the antenna are set to make the measurement.
- d. For each suspected emission, the EUT was arranged to its worst case and then the antenna was tuned to heights from 1 meter to 4 meters and the rotatable table was turned from 0 degrees to 360 degrees to find the maximum reading.
- e. The test-receiver system was set to quasi-peak detect function and specified bandwidth with maximum hold mode when the test frequency is below 1 GHz.
- f. The test-receiver system was set to peak and average detected function and specified bandwidth with maximum hold mode when the test frequency is above 1 GHz. If the peak reading value also meets average limit, measurement with the average detector is unnecessary.

Note:

1. The resolution bandwidth and video bandwidth of test receiver/spectrum analyzer is 120 kHz for Quasi-peak detection (QP) or Peak detection (PK) at frequency below 1 GHz.
2. The resolution bandwidth of test receiver/spectrum analyzer is 1 MHz and the video bandwidth is 3 MHz for Peak detection (PK) at frequency above 1 GHz.
3. The resolution bandwidth of test receiver/spectrum analyzer is 1 MHz and the video bandwidth is $\geq 1/T$ (Duty cycle < 98 %) or 10 Hz (Duty cycle ≥ 98 %) for Average detection (AV) at frequency above 1 GHz. (RBW = 1 MHz, VBW = 3 kHz)
4. All modes of operation were investigated and the worst-case emissions are reported.

4.1.4 Deviation from Test Standard

No deviation.

4.1.5 Test Set Up

<Radiated Emission below 30 MHz>

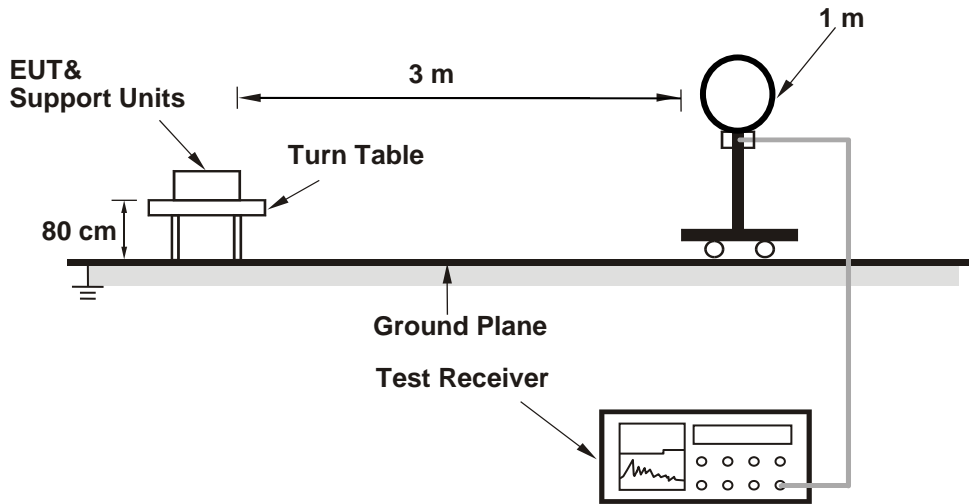

<Radiated Emission 30 MHz to 1 GHz>

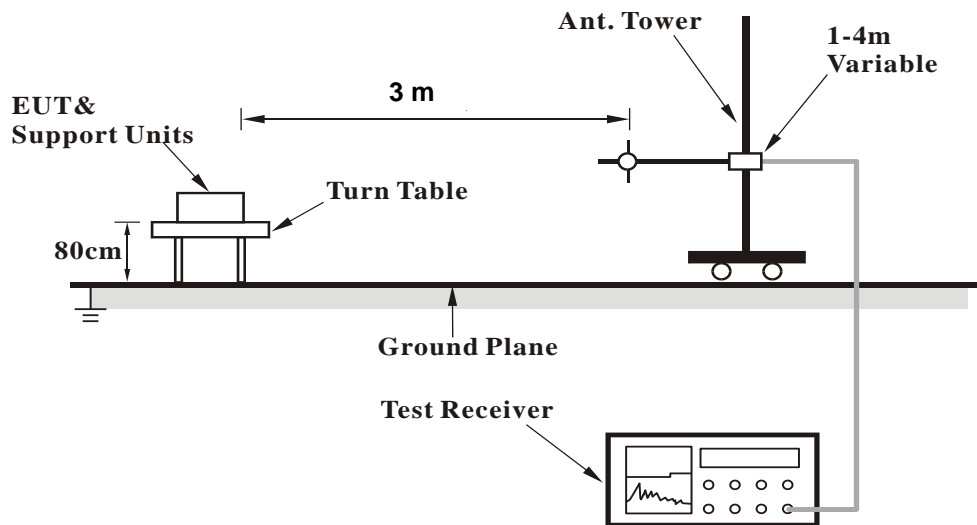

<Radiated Emission above 1 GHz>

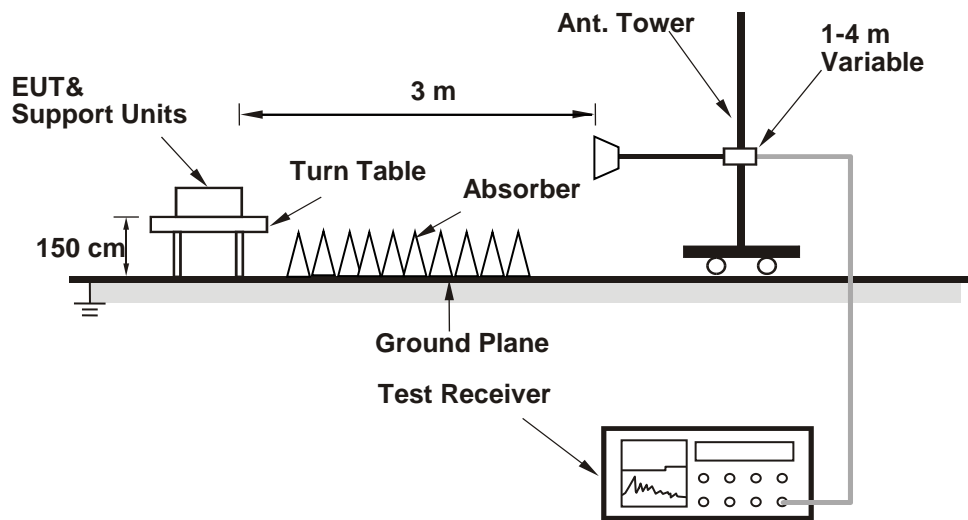

For the actual test configuration, please refer to the attached file (Test Setup Photo).

4.1.6 EUT Operating Conditions

- a. Placed the EUT on the testing table.
- b. Set the EUT under transmission condition continuously at specific channel frequency.

4.1.7 Test Results

Above 1 GHz Data:

<LE 4.0>

EUT Test Condition		Measurement Detail	
Channel	Channel 0	Frequency Range	1 GHz ~ 25 GHz
Input Power	120 Vac, 60 Hz	Detector Function	Peak (PK) Average (AV)
Environmental Conditions	25 deg. C, 65 % RH	Tested By	Tim Chen

Antenna Polarity & Test Distance: Horizontal at 3 m								
Frequency (MHz)	Emission Level (dBuV/m)	Read Level (dBuV)	Factor (dB/m)	Limit (dBuV/m)	Margin (dB)	Antenna Height (cm)	Table Angle (Degree)	Remark
2390	36.79	42.71	-5.92	54	-17.21	182	70	Average
2390	46.06	51.98	-5.92	74	-27.94	182	70	Peak
2402	96.69	102.63	-5.94	-----	-----	182	70	Average
2402	97.59	103.53	-5.94	-----	-----	182	70	Peak
4804	37.63	53.27	-15.64	54	-16.37	173	102	Average
4804	44.88	60.52	-15.64	74	-29.12	173	102	Peak

Antenna Polarity & Test Distance: Vertical at 3 m								
Frequency (MHz)	Emission Level (dBuV/m)	Read Level (dBuV)	Factor (dB/m)	Limit (dBuV/m)	Margin (dB)	Antenna Height (cm)	Table Angle (Degree)	Remark
2390	36.51	42.43	-5.92	54	-17.49	102	119	Average
2390	45.75	51.67	-5.92	74	-28.25	102	119	Peak
2402	89.98	95.92	-5.94	-----	-----	102	119	Average
2402	90.86	96.8	-5.94	-----	-----	102	119	Peak
4804	39.02	54.66	-15.64	54	-14.98	156	73	Average
4804	46.52	62.16	-15.64	74	-27.48	156	73	Peak

Remarks:

- Emission Level = Read Level + Factor
Correction Factor(dB/m) = Antenna Factor(dB/m) + Cable Factor(dB) – Pre-Amplifier Factor(dB).
Margin value = Emission level – Limit value
- 2402 MHz: Fundamental frequency.
- The emission levels of other frequencies were very low against the limit.

EUT Test Condition		Measurement Detail	
Channel	Channel 19	Frequency Range	1 GHz ~ 25 GHz
Input Power	120 Vac, 60 Hz	Detector Function	Peak (PK) Average (AV)
Environmental Conditions	25 deg. C, 65 % RH	Tested By	Tim Chen

Antenna Polarity & Test Distance: Horizontal at 3 m								
Frequency (MHz)	Emission Level (dBuV/m)	Read Level (dBuV)	Factor (dB/m)	Limit (dBuV/m)	Margin (dB)	Antenna Height (cm)	Table Angle (Degree)	Remark
2390	36.86	42.78	-5.92	54	-17.14	131	58	Average
2390	46.43	52.35	-5.92	74	-27.57	131	58	Peak
2440	94.87	100.75	-5.88	-----	-----	131	58	Average
2440	95.74	101.62	-5.88	-----	-----	131	58	Peak
2483.5	37.38	43.08	-5.7	54	-16.62	131	58	Average
2483.5	46.67	52.37	-5.7	74	-27.33	131	58	Peak
4880	35.64	51.2	-15.56	54	-18.36	162	23	Average
4880	43.75	59.31	-15.56	74	-30.25	162	23	Peak
7320	44.01	52.28	-8.27	54	-9.99	178	54	Average
7320	52.15	60.42	-8.27	74	-21.85	178	54	Peak
Antenna Polarity & Test Distance: Vertical at 3 m								
Frequency (MHz)	Emission Level (dBuV/m)	Read Level (dBuV)	Factor (dB/m)	Limit (dBuV/m)	Margin (dB)	Antenna Height (cm)	Table Angle (Degree)	Remark
2390	36.72	42.64	-5.92	54	-17.28	120	118	Average
2390	46.36	52.28	-5.92	74	-27.64	120	118	Peak
2440	90.4	96.28	-5.88	-----	-----	120	118	Average
2440	91.31	97.19	-5.88	-----	-----	120	118	Peak
2483.5	36.79	42.49	-5.7	54	-17.21	120	118	Average
2483.5	45.8	51.5	-5.7	74	-28.2	120	118	Peak
4880	37.49	53.05	-15.56	54	-16.51	113	305	Average
4880	46.2	61.76	-15.56	74	-27.8	113	305	Peak
7320	44.38	52.65	-8.27	54	-9.62	112	169	Average
7320	52.72	60.99	-8.27	74	-21.28	112	169	Peak

Remarks:

- Emission Level = Read Level + Factor
Correction Factor(dB/m) = Antenna Factor(dB/m) + Cable Factor(dB) – Pre-Amplifier Factor(dB).
Margin value = Emission level – Limit value
- 2440 MHz: Fundamental frequency.
- The emission levels of other frequencies were very low against the limit.

EUT Test Condition		Measurement Detail	
Channel	Channel 39	Frequency Range	1 GHz ~ 25 GHz
Input Power	120 Vac, 60 Hz	Detector Function	Peak (PK) Average (AV)
Environmental Conditions	25 deg. C, 65 % RH	Tested By	Tim Chen

Antenna Polarity & Test Distance: Horizontal at 3 m								
Frequency (MHz)	Emission Level (dBuV/m)	Read Level (dBuV)	Factor (dB/m)	Limit (dBuV/m)	Margin (dB)	Antenna Height (cm)	Table Angle (Degree)	Remark
2480	95.46	101.16	-5.7	-----	-----	174	37	Average
2480	96.33	102.03	-5.7	-----	-----	174	37	Peak
2483.5	38.18	43.88	-5.7	54	-15.82	174	37	Average
2483.5	47.47	53.17	-5.7	74	-26.53	174	37	Peak
4960	35.65	51.1	-15.45	54	-18.35	131	96	Average
4960	44.94	60.39	-15.45	74	-29.06	131	96	Peak
Antenna Polarity & Test Distance: Vertical at 3 m								
Frequency (MHz)	Emission Level (dBuV/m)	Read Level (dBuV)	Factor (dB/m)	Limit (dBuV/m)	Margin (dB)	Antenna Height (cm)	Table Angle (Degree)	Remark
2480	92.09	97.79	-5.7	-----	-----	109	120	Average
2480	92.96	98.66	-5.7	-----	-----	109	120	Peak
2483.5	37.2	42.9	-5.7	54	-16.8	109	120	Average
2483.5	46.23	51.93	-5.7	74	-27.77	109	120	Peak
4960	37.92	53.37	-15.45	54	-16.08	135	202	Average
4960	46.63	62.08	-15.45	74	-27.37	135	202	Peak

Remarks:

- Emission Level = Read Level + Factor
Correction Factor(dB/m) = Antenna Factor(dB/m) + Cable Factor(dB) – Pre-Amplifier Factor(dB).
Margin value = Emission level – Limit value
- 2480 MHz: Fundamental frequency.
- The emission levels of other frequencies were very low against the limit.

<LE 5.1>

EUT Test Condition		Measurement Detail	
Channel	Channel 0	Frequency Range	1 GHz ~ 25 GHz
Input Power	120 Vac, 60 Hz	Detector Function	Peak (PK) Average (AV)
Environmental Conditions	25 deg. C, 65 % RH	Tested By	Tim Chen

Antenna Polarity & Test Distance: Horizontal at 3 m								
Frequency (MHz)	Emission Level (dBuV/m)	Read Level (dBuV)	Factor (dB/m)	Limit (dBuV/m)	Margin (dB)	Antenna Height (cm)	Table Angle (Degree)	Remark
2390	36.62	42.54	-5.92	54	-17.38	135	243	Average
2390	45.43	51.35	-5.92	74	-28.57	135	243	Peak
2402	94.64	100.58	-5.94	-----	-----	135	243	Average
2402	97.14	103.08	-5.94	-----	-----	135	243	Peak
4804	35.7	51.34	-15.64	54	-18.3	132	301	Average
4804	44.01	59.65	-15.64	74	-29.99	132	301	Peak
Antenna Polarity & Test Distance: Vertical at 3 m								
Frequency (MHz)	Emission Level (dBuV/m)	Read Level (dBuV)	Factor (dB/m)	Limit (dBuV/m)	Margin (dB)	Antenna Height (cm)	Table Angle (Degree)	Remark
2390	36.61	42.53	-5.92	54	-17.39	100	110	Average
2390	45.5	51.42	-5.92	74	-28.5	100	110	Peak
2402	88.73	94.67	-5.94	-----	-----	100	110	Average
2402	91.29	97.23	-5.94	-----	-----	100	110	Peak
4804	37.63	53.27	-15.64	54	-16.37	162	155	Average
4804	46.23	61.87	-15.64	74	-27.77	162	155	Peak

Remarks:

- Emission Level = Read Level + Factor
Correction Factor(dB/m) = Antenna Factor(dB/m) + Cable Factor(dB) – Pre-Amplifier Factor(dB).
Margin value = Emission level – Limit value
- 2402 MHz: Fundamental frequency.
- The emission levels of other frequencies were very low against the limit.

EUT Test Condition		Measurement Detail	
Channel	Channel 19	Frequency Range	1 GHz ~ 25 GHz
Input Power	120 Vac, 60 Hz	Detector Function	Peak (PK) Average (AV)
Environmental Conditions	25 deg. C, 65 % RH	Tested By	Tim Chen

Antenna Polarity & Test Distance: Horizontal at 3 m								
Frequency (MHz)	Emission Level (dBuV/m)	Read Level (dBuV)	Factor (dB/m)	Limit (dBuV/m)	Margin (dB)	Antenna Height (cm)	Table Angle (Degree)	Remark
2390	36.76	42.68	-5.92	54	-17.24	190	36	Average
2390	46	51.92	-5.92	74	-28	190	36	Peak
2440	94.26	100.14	-5.88	-----	-----	190	36	Average
2440	96.68	102.56	-5.88	-----	-----	190	36	Peak
2483.5	36.94	42.64	-5.7	54	-17.06	190	36	Average
2483.5	45.8	51.5	-5.7	74	-28.2	190	36	Peak
4880	36.78	52.34	-15.56	54	-17.22	163	257	Average
4880	44.48	60.04	-15.56	74	-29.52	163	257	Peak

Antenna Polarity & Test Distance: Vertical at 3 m								
Frequency (MHz)	Emission Level (dBuV/m)	Read Level (dBuV)	Factor (dB/m)	Limit (dBuV/m)	Margin (dB)	Antenna Height (cm)	Table Angle (Degree)	Remark
2390	36.89	42.81	-5.92	54	-17.11	100	119	Average
2390	46.67	52.59	-5.92	74	-27.33	100	119	Peak
2440	89	94.88	-5.88	-----	-----	100	119	Average
2440	91.39	97.27	-5.88	-----	-----	100	119	Peak
2483.5	36.79	42.49	-5.7	54	-17.21	100	119	Average
2483.5	46.26	51.96	-5.7	74	-27.74	100	119	Peak
4880	37.67	53.23	-15.56	54	-16.33	102	33	Average
4880	45.77	61.33	-15.56	74	-28.23	102	33	Peak

Remarks:

- Emission Level = Read Level + Factor
Correction Factor(dB/m) = Antenna Factor(dB/m) + Cable Factor(dB) – Pre-Amplifier Factor(dB).
Margin value = Emission level – Limit value
- 2440 MHz: Fundamental frequency.
- The emission levels of other frequencies were very low against the limit.

EUT Test Condition		Measurement Detail	
Channel	Channel 39	Frequency Range	1 GHz ~ 25 GHz
Input Power	120 Vac, 60 Hz	Detector Function	Peak (PK) Average (AV)
Environmental Conditions	25 deg. C, 65 % RH	Tested By	Getaz Yang

Antenna Polarity & Test Distance: Horizontal at 3 m								
Frequency (MHz)	Emission Level (dBuV/m)	Read Level (dBuV)	Factor (dB/m)	Limit (dBuV/m)	Margin (dB)	Antenna Height (cm)	Table Angle (Degree)	Remark
2480	82.11	87.81	-5.7	-----	-----	230	160	Average
2480	96.11	101.81	-5.7	-----	-----	230	160	Peak
2483.5	38.53	44.23	-5.7	54	-15.47	230	160	Average
2483.5	53.51	59.21	-5.7	74	-20.49	230	160	Peak
4960	34.78	50.23	-15.45	54	-19.22	125	142	Average
4960	43.53	58.98	-15.45	74	-30.47	125	142	Peak
Antenna Polarity & Test Distance: Vertical at 3 m								
Frequency (MHz)	Emission Level (dBuV/m)	Read Level (dBuV)	Factor (dB/m)	Limit (dBuV/m)	Margin (dB)	Antenna Height (cm)	Table Angle (Degree)	Remark
2480	77.35	83.05	-5.7	-----	-----	110	288	Average
2480	89.76	95.46	-5.7	-----	-----	110	288	Peak
2483.5	36.07	41.77	-5.7	54	-17.93	110	288	Average
2483.5	48.35	54.05	-5.7	74	-25.65	110	288	Peak
4960	33.78	49.23	-15.45	54	-20.22	111	124	Average
4960	44.09	59.54	-15.45	74	-29.91	111	124	Peak

Remarks:

- Emission Level = Read Level + Factor
Correction Factor(dB/m) = Antenna Factor(dB/m) + Cable Factor(dB) – Pre-Amplifier Factor(dB).
Margin value = Emission level – Limit value
- 2480 MHz: Fundamental frequency.
- The emission levels of other frequencies were very low against the limit.

9 kHz ~ 30 MHz Data:

The amplitude of spurious emissions attenuated more than 20 dB below the permissible value is not required to be report.

30 MHz ~ 1 GHz Worst-Case Data:

Mode A

<LE 4.0>

EUT Test Condition		Measurement Detail	
Channel	Channel 19	Frequency Range	30 MHz ~ 1 GHz
Input Power	120 Vac, 60 Hz	Detector Function	Peak (PK) Quasi-peak (QP)
Environmental Conditions	25 deg. C, 65 % RH	Tested By	Tim Chen

Horizontal

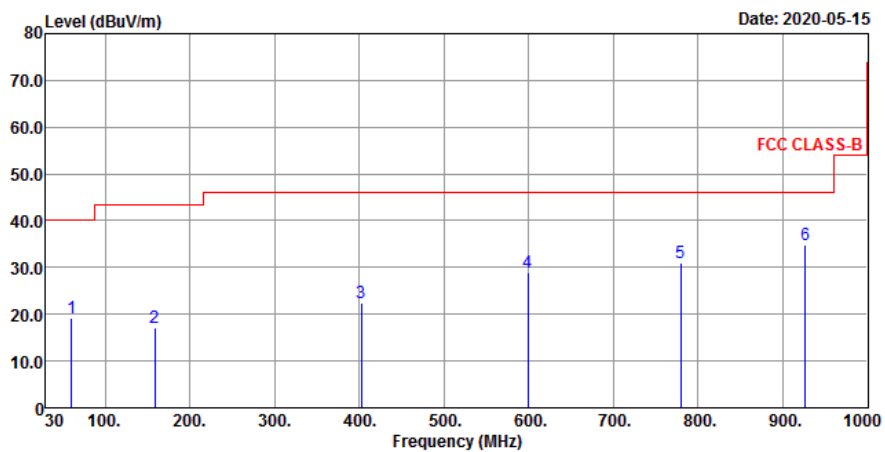

Vertical

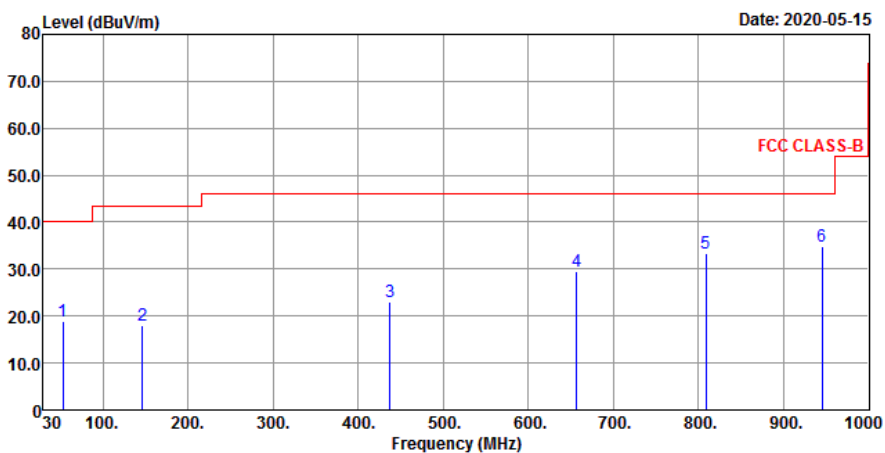

Antenna Polarity & Test Distance: Horizontal at 3 m								
Frequency (MHz)	Emission Level (dBuV/m)	Read Level (dBuV)	Factor (dB/m)	Limit (dBuV/m)	Margin (dB)	Antenna Height (cm)	Table Angle (Degree)	Remark
60.07	19.07	31.63	-12.56	40	-20.93	182	130	Peak
159.01	17.26	28.97	-11.71	43.5	-26.24	155	162	Peak
402.48	22.3	30.61	-8.31	46	-23.7	170	52	Peak
599.39	28.96	31.69	-2.73	46	-17.04	148	199	Peak
779.81	30.93	29.43	1.5	46	-15.07	101	327	Peak
926.28	34.79	31.42	3.37	46	-11.21	165	327	Peak
Antenna Polarity & Test Distance: Vertical at 3 m								
Frequency (MHz)	Emission Level (dBuV/m)	Read Level (dBuV)	Factor (dB/m)	Limit (dBuV/m)	Margin (dB)	Antenna Height (cm)	Table Angle (Degree)	Remark
53.28	18.96	30.81	-11.85	40	-21.04	131	182	Peak
146.4	18.03	29.76	-11.73	43.5	-25.47	202	251	Peak
437.4	23.11	29.88	-6.77	46	-22.89	103	167	Peak
656.62	29.57	31.09	-1.52	46	-16.43	125	196	Peak
808.91	33.42	31.54	1.88	46	-12.58	170	288	Peak
945.68	34.74	31.09	3.65	46	-11.26	148	327	Peak

Remarks:

- Emission Level = Read Level + Factor
 Correction Factor(dB/m) = Antenna Factor(dB/m) + Cable Factor(dB) – Pre-Amplifier Factor(dB).
 Margin value = Emission level – Limit value
- The emission levels of other frequencies were very low against the limit.

<LE 5.1>

EUT Test Condition		Measurement Detail	
Channel	Channel 19	Frequency Range	30 MHz ~ 1 GHz
Input Power	120 Vac, 60 Hz	Detector Function	Peak (PK) Quasi-peak (QP)
Environmental Conditions	25 deg. C, 65 % RH	Tested By	Tim Chen

Horizontal

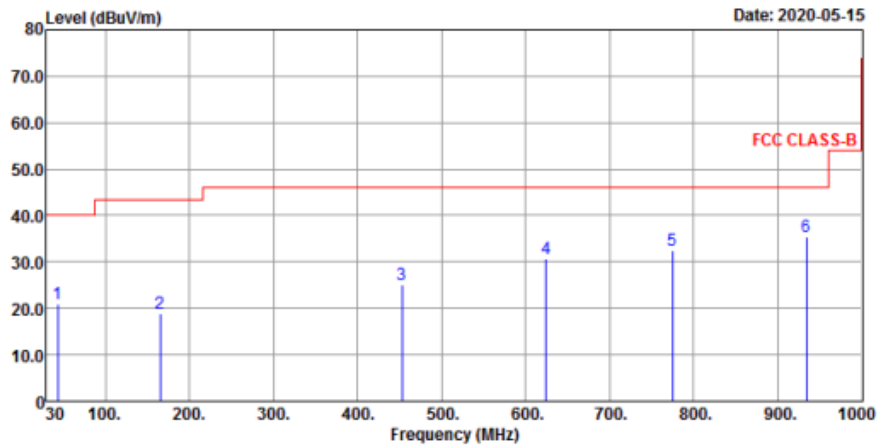

Vertical

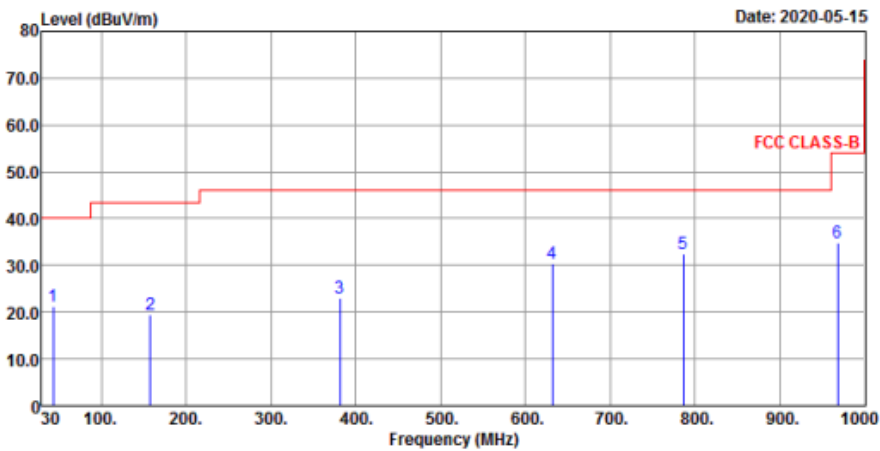

Antenna Polarity & Test Distance: Horizontal at 3 m								
Frequency (MHz)	Emission Level (dBuV/m)	Read Level (dBuV)	Factor (dB/m)	Limit (dBuV/m)	Margin (dB)	Antenna Height (cm)	Table Angle (Degree)	Remark
43.58	20.9	32.82	-11.92	40	-19.1	198	74	Peak
164.83	18.76	30.72	-11.96	43.5	-24.74	184	23	Peak
452.92	25.16	31.53	-6.37	46	-20.84	134	133	Peak
624.61	30.66	32.57	-1.91	46	-15.34	113	212	Peak
774.96	32.33	30.89	1.44	46	-13.67	112	191	Peak
934.04	35.38	31.95	3.43	46	-10.62	162	29	Peak
Antenna Polarity & Test Distance: Vertical at 3 m								
Frequency (MHz)	Emission Level (dBuV/m)	Read Level (dBuV)	Factor (dB/m)	Limit (dBuV/m)	Margin (dB)	Antenna Height (cm)	Table Angle (Degree)	Remark
43.58	21.33	33.25	-11.92	40	-18.67	159	26	Peak
158.04	19.34	31.02	-11.68	43.5	-24.16	147	133	Peak
381.14	23.07	31.78	-8.71	46	-22.93	133	142	Peak
631.4	30.31	32.09	-1.78	46	-15.69	181	83	Peak
785.63	32.53	30.98	1.55	46	-13.47	153	176	Peak
967.99	34.96	31.19	3.77	54	-19.04	139	143	Peak

Remarks:

- Emission Level = Read Level + Factor
 Correction Factor(dB/m) = Antenna Factor(dB/m) + Cable Factor(dB) – Pre-Amplifier Factor(dB).
 Margin value = Emission level – Limit value
- The emission levels of other frequencies were very low against the limit.

Mode B
<LE 4.0>

EUT Test Condition		Measurement Detail	
Channel	Channel 19	Frequency Range	30 MHz ~ 1 GHz
Input Power	120 Vac, 60 Hz	Detector Function	Peak (PK) Quasi-peak (QP)
Environmental Conditions	25 deg. C, 65 % RH	Tested By	Tim Chen

Horizontal

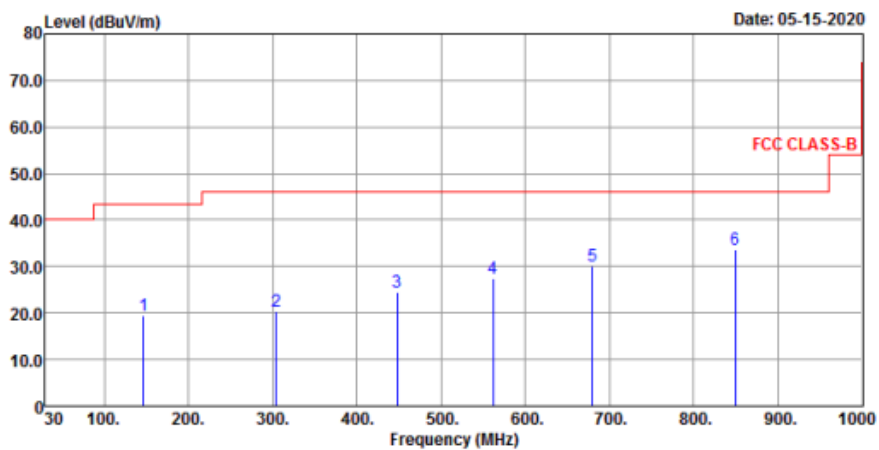

Vertical

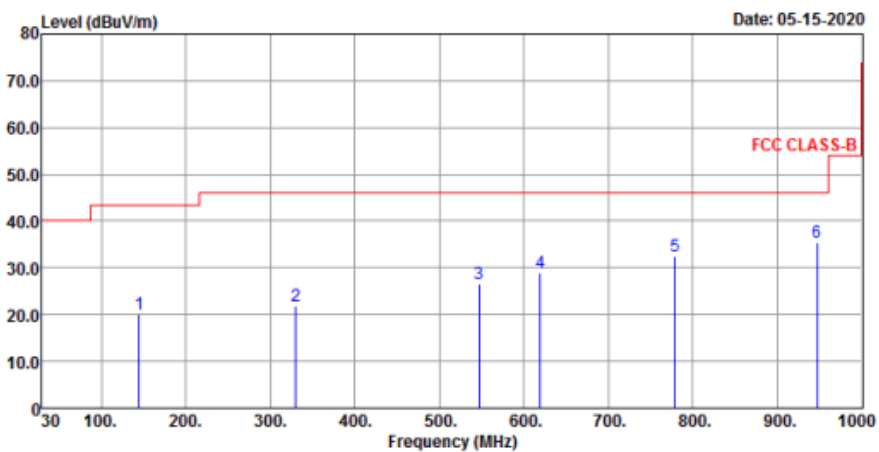

Antenna Polarity & Test Distance: Horizontal at 3 m

Frequency (MHz)	Emission Level (dBuV/m)	Read Level (dBuV)	Factor (dB/m)	Limit (dBuV/m)	Margin (dB)	Antenna Height (cm)	Table Angle (Degree)	Remark
146.4	19.39	31.12	-11.73	43.5	-24.11	125	132	Peak
304.51	20.27	31.27	-11	46	-25.73	111	162	Peak
448.07	24.63	31.11	-6.48	46	-21.37	145	125	Peak
561.56	27.35	31.43	-4.08	46	-18.65	102	231	Peak
679.9	30.13	31.17	-1.04	46	-15.87	111	152	Peak
849.65	33.6	31.16	2.44	46	-12.4	148	251	Peak

Antenna Polarity & Test Distance: Vertical at 3 m

Frequency (MHz)	Emission Level (dBuV/m)	Read Level (dBuV)	Factor (dB/m)	Limit (dBuV/m)	Margin (dB)	Antenna Height (cm)	Table Angle (Degree)	Remark
144.46	19.97	31.81	-11.84	43.5	-23.53	132	256	Peak
329.73	21.75	31.76	-10.01	46	-24.25	102	231	Peak
547.01	26.57	31.12	-4.55	46	-19.43	111	145	Peak
619.76	28.96	31.03	-2.07	46	-17.04	132	256	Peak
778.84	32.44	30.96	1.48	46	-13.56	102	285	Peak
946.65	35.52	31.86	3.66	46	-10.48	132	145	Peak

Remarks:

- Emission Level = Read Level + Factor
 Correction Factor(dB/m) = Antenna Factor(dB/m) + Cable Factor(dB) – Pre-Amplifier Factor(dB).
 Margin value = Emission level – Limit value
- The emission levels of other frequencies were very low against the limit.

<LE 5.1>

EUT Test Condition		Measurement Detail	
Channel	Channel 19	Frequency Range	30 MHz ~ 1 GHz
Input Power	120 Vac, 60 Hz	Detector Function	Peak (PK) Quasi-peak (QP)
Environmental Conditions	25 deg. C, 65 % RH	Tested By	Tim Chen

Horizontal

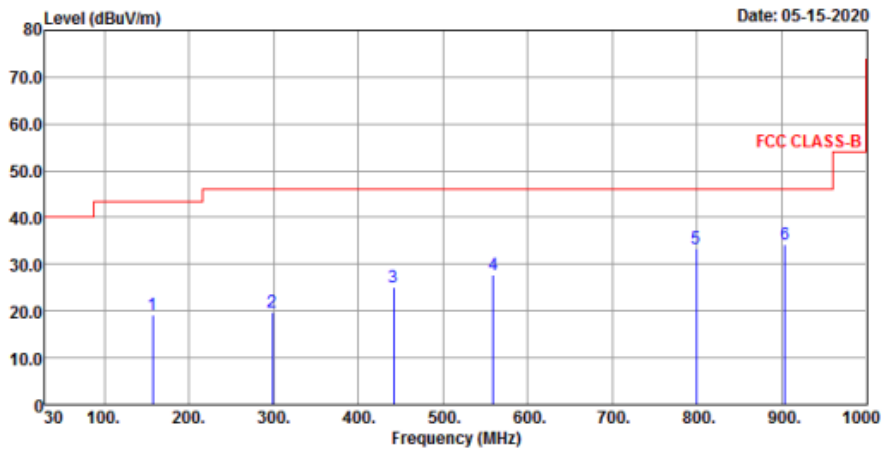

Vertical

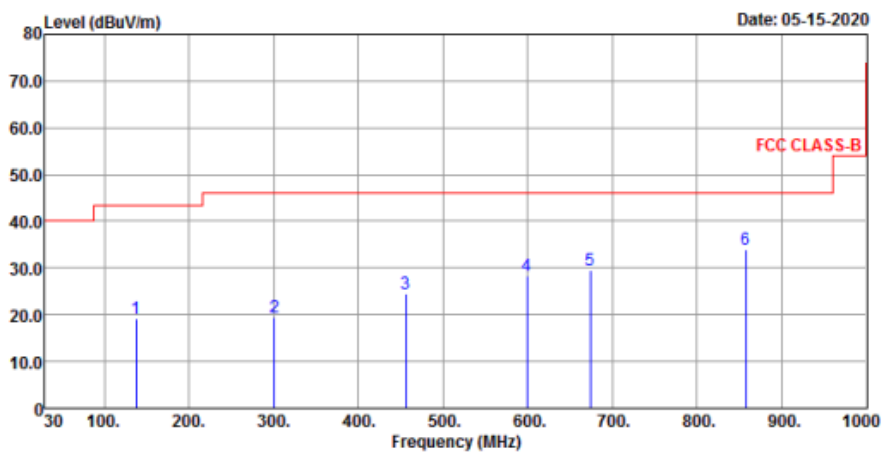

Antenna Polarity & Test Distance: Horizontal at 3 m								
Frequency (MHz)	Emission Level (dBuV/m)	Read Level (dBuV)	Factor (dB/m)	Limit (dBuV/m)	Margin (dB)	Antenna Height (cm)	Table Angle (Degree)	Remark
157.07	19.14	30.74	-11.6	43.5	-24.36	102	132	Peak
298.69	19.67	30.89	-11.22	46	-26.33	145	152	Peak
441.28	24.95	31.58	-6.63	46	-21.05	111	132	Peak
559.62	27.77	31.93	-4.16	46	-18.23	165	152	Peak
799.21	33.46	31.81	1.65	46	-12.54	102	231	Peak
903.97	34.31	31.24	3.07	46	-11.69	111	145	Peak
Antenna Polarity & Test Distance: Vertical at 3 m								
Frequency (MHz)	Emission Level (dBuV/m)	Read Level (dBuV)	Factor (dB/m)	Limit (dBuV/m)	Margin (dB)	Antenna Height (cm)	Table Angle (Degree)	Remark
137.67	19.33	31.6	-12.27	43.5	-24.17	102	231	Peak
300.63	19.61	30.77	-11.16	46	-26.39	111	145	Peak
455.83	24.45	30.74	-6.29	46	-21.55	162	251	Peak
599.39	28.44	31.17	-2.73	46	-17.56	132	251	Peak
674.08	29.51	30.71	-1.2	46	-16.49	185	124	Peak
857.41	34.08	31.53	2.55	46	-11.92	132	265	Peak

Remarks:

- Emission Level = Read Level + Factor
 Correction Factor(dB/m) = Antenna Factor(dB/m) + Cable Factor(dB) – Pre-Amplifier Factor(dB).
 Margin value = Emission level – Limit value
- The emission levels of other frequencies were very low against the limit.

Mode C
<LE 4.0>

EUT Test Condition		Measurement Detail	
Channel	Channel 19	Frequency Range	30 MHz ~ 1 GHz
Input Power	120 Vac, 60 Hz	Detector Function	Peak (PK) Quasi-peak (QP)
Environmental Conditions	25 deg. C, 65 % RH	Tested By	Tim Chen

Horizontal

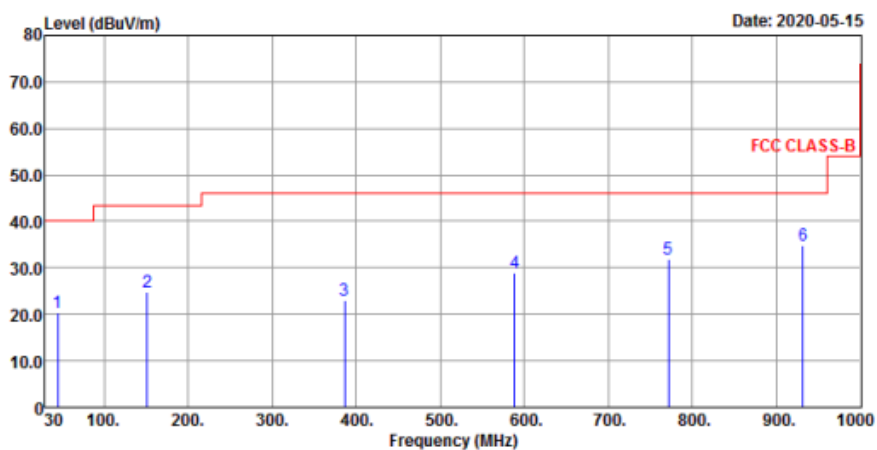

Vertical

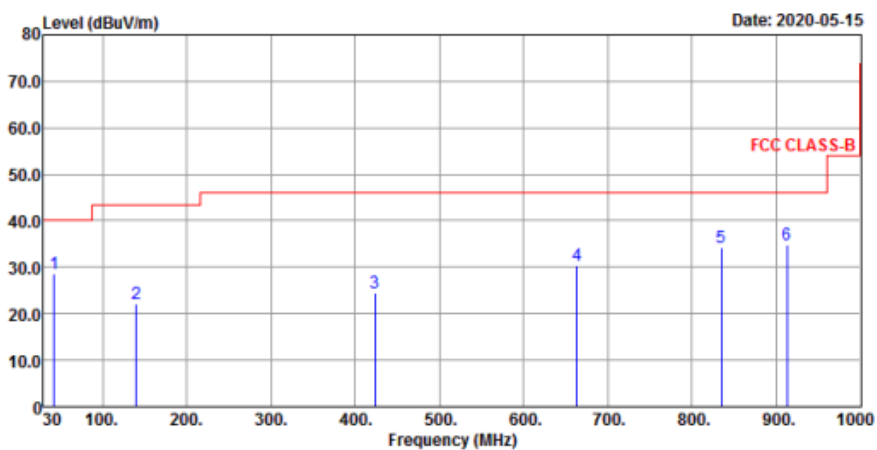

Antenna Polarity & Test Distance: Horizontal at 3 m								
Frequency (MHz)	Emission Level (dBuV/m)	Read Level (dBuV)	Factor (dB/m)	Limit (dBuV/m)	Margin (dB)	Antenna Height (cm)	Table Angle (Degree)	Remark
44.55	20.33	32.2	-11.87	40	-19.67	154	122	Peak
151.25	24.81	36.52	-11.71	43.5	-18.69	132	155	Peak
385.99	23.03	31.66	-8.63	46	-22.97	166	36	Peak
588.72	28.82	31.9	-3.08	46	-17.18	112	352	Peak
771.08	31.88	30.61	1.27	46	-14.12	147	87	Peak
931.13	34.83	31.4	3.43	46	-11.17	111	121	Peak
Antenna Polarity & Test Distance: Vertical at 3 m								
Frequency (MHz)	Emission Level (dBuV/m)	Read Level (dBuV)	Factor (dB/m)	Limit (dBuV/m)	Margin (dB)	Antenna Height (cm)	Table Angle (Degree)	Remark
42.61	28.78	40.76	-11.98	40	-11.22	171	74	Peak
139.61	22.14	34.29	-12.15	43.5	-21.36	146	166	Peak
423.82	24.55	31.9	-7.35	46	-21.45	188	163	Peak
663.41	30.54	31.96	-1.42	46	-15.46	142	144	Peak
835.1	34.18	31.9	2.28	46	-11.82	181	156	Peak
912.7	34.8	31.59	3.21	46	-11.2	177	192	Peak

Remarks:

- Emission Level = Read Level + Factor
 Correction Factor(dB/m) = Antenna Factor(dB/m) + Cable Factor(dB) – Pre-Amplifier Factor(dB).
 Margin value = Emission level – Limit value
- The emission levels of other frequencies were very low against the limit.

<LE 5.1>

EUT Test Condition		Measurement Detail	
Channel	Channel 19	Frequency Range	30 MHz ~ 1 GHz
Input Power	120 Vac, 60 Hz	Detector Function	Peak (PK) Quasi-peak (QP)
Environmental Conditions	25 deg. C, 65 % RH	Tested By	Tim Chen

Horizontal

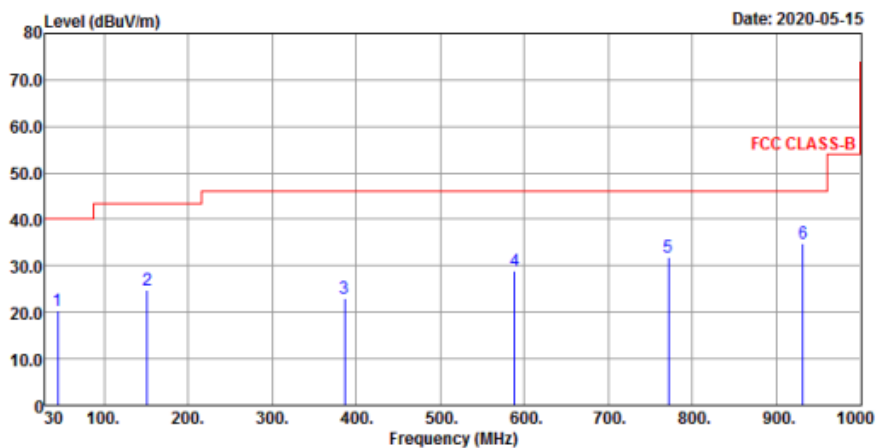

Vertical

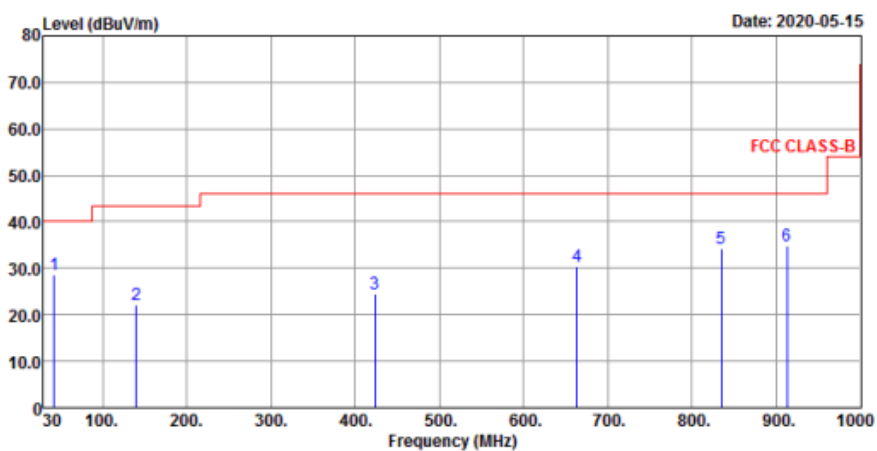

Antenna Polarity & Test Distance: Horizontal at 3 m								
Frequency (MHz)	Emission Level (dBuV/m)	Read Level (dBuV)	Factor (dB/m)	Limit (dBuV/m)	Margin (dB)	Antenna Height (cm)	Table Angle (Degree)	Remark
44.55	20.33	32.2	-11.87	40	-19.67	154	122	Peak
151.25	24.81	36.52	-11.71	43.5	-18.69	132	155	Peak
385.99	23.03	31.66	-8.63	46	-22.97	166	36	Peak
588.72	28.82	31.9	-3.08	46	-17.18	112	352	Peak
771.08	31.88	30.61	1.27	46	-14.12	147	87	Peak
931.13	34.83	31.4	3.43	46	-11.17	111	121	Peak
Antenna Polarity & Test Distance: Vertical at 3 m								
Frequency (MHz)	Emission Level (dBuV/m)	Read Level (dBuV)	Factor (dB/m)	Limit (dBuV/m)	Margin (dB)	Antenna Height (cm)	Table Angle (Degree)	Remark
42.61	28.78	40.76	-11.98	40	-11.22	171	74	Peak
139.61	22.14	34.29	-12.15	43.5	-21.36	146	166	Peak
423.82	24.55	31.9	-7.35	46	-21.45	188	163	Peak
663.41	30.54	31.96	-1.42	46	-15.46	142	144	Peak
835.1	34.18	31.9	2.28	46	-11.82	181	156	Peak
912.7	34.8	31.59	3.21	46	-11.2	177	192	Peak

Remarks:

- Emission Level = Read Level + Factor
 Correction Factor(dB/m) = Antenna Factor(dB/m) + Cable Factor(dB) – Pre-Amplifier Factor(dB).
 Margin value = Emission level – Limit value
- The emission levels of other frequencies were very low against the limit.

Mode D
<LE 4.0>

EUT Test Condition		Measurement Detail	
Channel	Channel 19	Frequency Range	30 MHz ~ 1 GHz
Input Power	120 Vac, 60 Hz	Detector Function	Peak (PK) Quasi-peak (QP)
Environmental Conditions	25 deg. C, 65 % RH	Tested By	Tim Chen

Horizontal

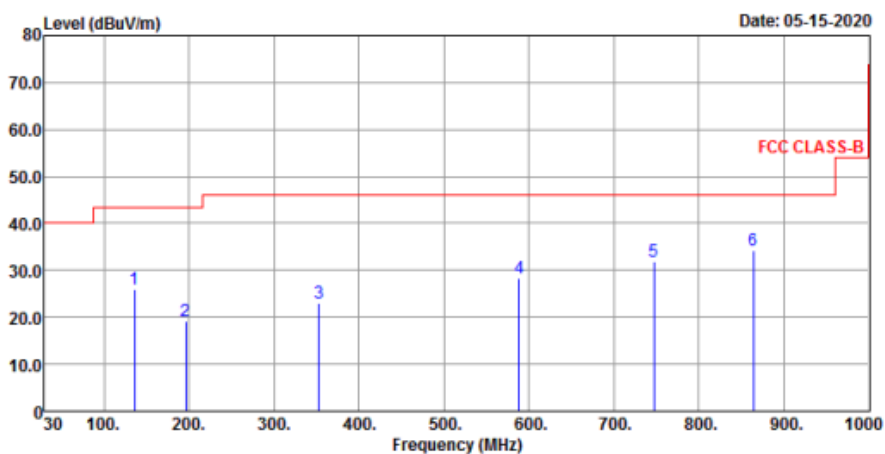

Vertical

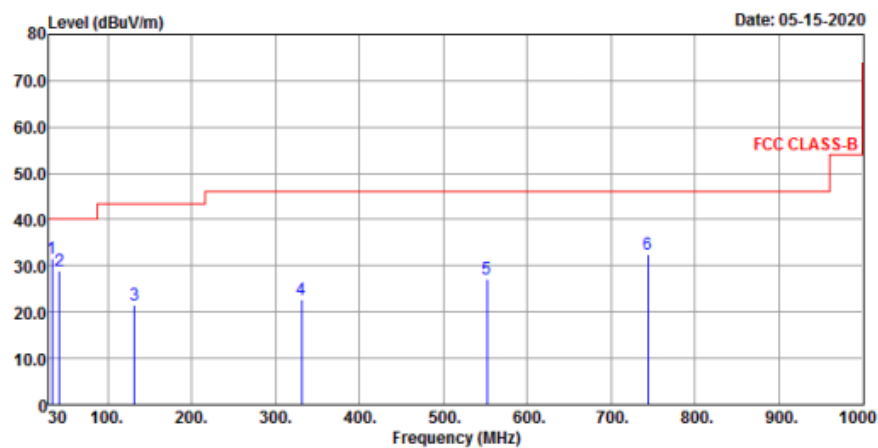

Antenna Polarity & Test Distance: Horizontal at 3 m								
Frequency (MHz)	Emission Level (dBuV/m)	Read Level (dBuV)	Factor (dB/m)	Limit (dBuV/m)	Margin (dB)	Antenna Height (cm)	Table Angle (Degree)	Remark
135.73	25.93	38.29	-12.36	43.5	-17.57	145	152	Peak
195.87	19.15	34.14	-14.99	43.5	-24.35	102	231	Peak
353.01	22.9	32.57	-9.67	46	-23.1	165	295	Peak
588.72	28.44	31.52	-3.08	46	-17.56	147	152	Peak
746.83	31.94	30.99	0.95	46	-14.06	111	132	Peak
864.2	34.26	31.65	2.61	46	-11.74	158	256	Peak
Antenna Polarity & Test Distance: Vertical at 3 m								
Frequency (MHz)	Emission Level (dBuV/m)	Read Level (dBuV)	Factor (dB/m)	Limit (dBuV/m)	Margin (dB)	Antenna Height (cm)	Table Angle (Degree)	Remark
33.88	31.63	44.5	-12.87	40	-8.37	145	125	Peak
42.61	28.98	40.96	-11.98	40	-11.02	145	285	Peak
131.85	21.49	34.31	-12.82	43.5	-22.01	132	265	Peak
330.7	22.79	32.79	-10	46	-23.21	111	142	Peak
551.86	27.14	31.55	-4.41	46	-18.86	185	147	Peak
743.92	32.49	31.56	0.93	46	-13.51	102	231	Peak

Remarks:

- Emission Level = Read Level + Factor
Correction Factor(dB/m) = Antenna Factor(dB/m) + Cable Factor(dB) – Pre-Amplifier Factor(dB).
Margin value = Emission level – Limit value
- The emission levels of other frequencies were very low against the limit.

<LE 5.1>

EUT Test Condition		Measurement Detail	
Channel	Channel 19	Frequency Range	30 MHz ~ 1 GHz
Input Power	120 Vac, 60 Hz	Detector Function	Peak (PK) Quasi-peak (QP)
Environmental Conditions	25 deg. C, 65 % RH	Tested By	Tim Chen

Horizontal

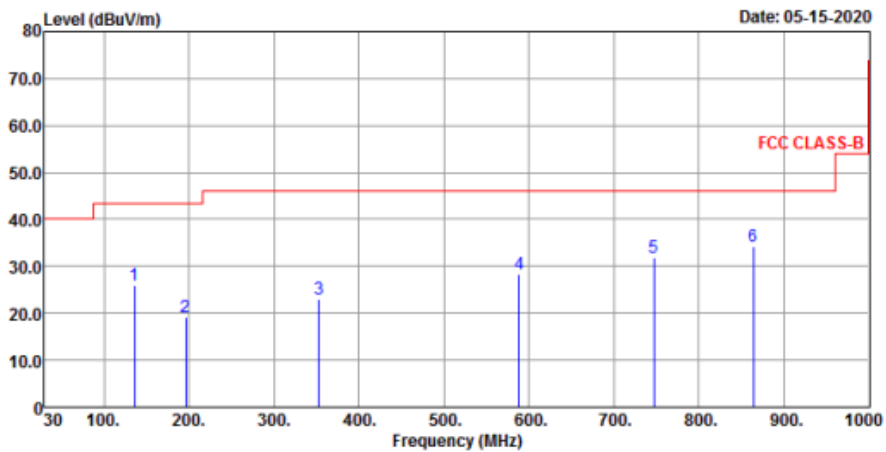

Vertical

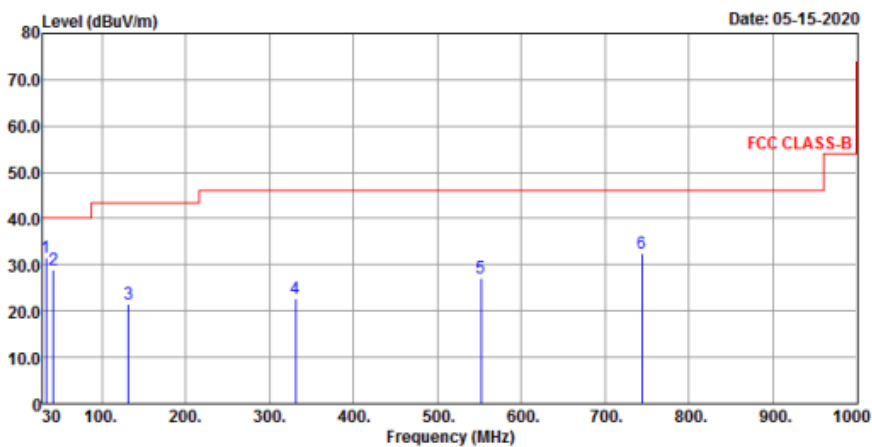

Antenna Polarity & Test Distance: Horizontal at 3 m

Frequency (MHz)	Emission Level (dBuV/m)	Read Level (dBuV)	Factor (dB/m)	Limit (dBuV/m)	Margin (dB)	Antenna Height (cm)	Table Angle (Degree)	Remark
135.73	25.93	38.29	-12.36	43.5	-17.57	145	152	Peak
195.87	19.15	34.14	-14.99	43.5	-24.35	102	231	Peak
353.01	22.9	32.57	-9.67	46	-23.1	165	295	Peak
588.72	28.44	31.52	-3.08	46	-17.56	147	152	Peak
746.83	31.94	30.99	0.95	46	-14.06	111	132	Peak
864.2	34.26	31.65	2.61	46	-11.74	158	256	Peak

Antenna Polarity & Test Distance: Vertical at 3 m

Frequency (MHz)	Emission Level (dBuV/m)	Read Level (dBuV)	Factor (dB/m)	Limit (dBuV/m)	Margin (dB)	Antenna Height (cm)	Table Angle (Degree)	Remark
33.88	31.63	44.5	-12.87	40	-8.37	145	125	Peak
42.61	28.98	40.96	-11.98	40	-11.02	145	285	Peak
131.85	21.49	34.31	-12.82	43.5	-22.01	132	265	Peak
330.7	22.79	32.79	-10	46	-23.21	111	142	Peak
551.86	27.14	31.55	-4.41	46	-18.86	185	147	Peak
743.92	32.49	31.56	0.93	46	-13.51	102	231	Peak

Remarks:

- Emission Level = Read Level + Factor
 Correction Factor(dB/m) = Antenna Factor(dB/m) + Cable Factor(dB) – Pre-Amplifier Factor(dB).
 Margin value = Emission level – Limit value
- The emission levels of other frequencies were very low against the limit.

4.2 Conducted Emission Measurement

4.2.1 Limits of Conducted Emission Measurement

Frequency (MHz)	Conducted Limit (dBUV)	
	Quasi-Peak	Average
0.15 - 0.5	66 - 56	56 - 46
0.50 - 5.0	56	46
5.0 - 30.0	60	50

- Note: 1. The lower limit shall apply at the transition frequencies.
 2. The limit decreases in line with the logarithm of the frequency in the range of 0.15 to 0.50 MHz.

4.2.2 Test Instruments

Description & Manufacturer	Model No.	Serial No.	Date of Calibration	Due Date of Calibration
Test Receiver ROHDE & SCHWARZ	ESCI	100613	Dec. 11, 2019	Dec. 10, 2020
RF signal cable Woken	5D-FB	Cable-cond1-01	Sep. 05, 2019	Sep. 04, 2020
LISN/AMN ROHDE & SCHWARZ (EUT)	ENV216	101826	Feb. 20, 2020	Feb. 19, 2021
LISN/AMN ROHDE & SCHWARZ (Peripheral)	ESH3-Z5	100311	Aug. 22, 2019	Aug. 21, 2020
Software ADT	BV ADT_Cond_ V7.3.7.4	NA	NA	NA

- Note: 1. The calibration interval of the above test instruments is 12 months and the calibrations are traceable to NML/ROC and NIST/USA.
 2. The test was performed in HwaYa Shielded Room 1.
 3. The VCCI Site Registration No. is C-12040.

4.2.3 Test Procedures

- The EUT was placed 0.4 meters from the conducting wall of the shielded room with EUT being connected to the power mains through a line impedance stabilization network (LISN). Other support units were connected to the power mains through another LISN. The two LISNs provide 50 ohm/50 uH of coupling impedance for the measuring instrument.
- Both lines of the power mains connected to the EUT were checked for maximum conducted interference.
- The frequency range from 150 kHz to 30 MHz was searched. Emission levels under (Limit – 20 dB) was not recorded.

Note: The resolution bandwidth and video bandwidth of test receiver is 9 kHz for quasi-peak detection (QP) and average detection (AV) at frequency 0.15 MHz - 30 MHz.

4.2.4 Deviation from Test Standard

No deviation.

4.2.5 Test Setup

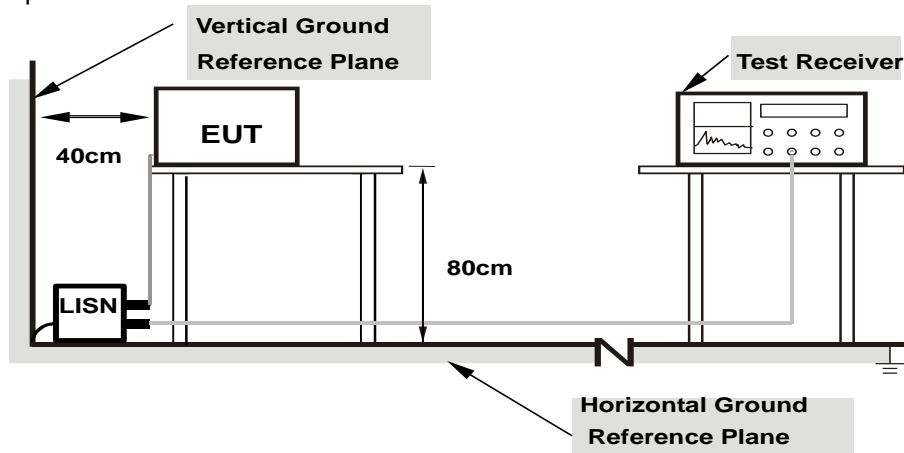

**Note: 1.Support units were connected to second LISN.
2.Both of LISNs (AMN) are 80 cm from EUT and at least 80 from other units and other metal planes**

4.2.6 EUT Operating Conditions

- Placed the EUT on the testing table.
- Set the EUT under transmission condition continuously at specific channel frequency.

4.2.7 Test Results

CONDUCTED WORST-CASE DATA

<LE4.0>

Frequency Range	150kHz ~ 30MHz	Detector Function & Resolution Bandwidth	Quasi-Peak (QP) / Average (AV), 9kHz
Input Power	120Vac, 60Hz	Environmental Conditions	25°C, 65%RH
Tested by	Jisyong Wang	Test Date	2020/5/13
Test Mode	Mode C		

Phase Of Power : Line (L)										
No	Frequency (MHz)	Correction Factor (dB)	Reading Value (dBuV)		Emission Level (dBuV)		Limit (dBuV)		Margin (dB)	
			Q.P.	AV.	Q.P.	AV.	Q.P.	AV.	Q.P.	AV.
1	0.16600	9.63	27.54	25.95	37.17	35.58	65.16	55.16	-27.99	-19.58
2	0.19000	9.62	23.99	20.38	33.61	30.00	64.04	54.04	-30.43	-24.04
3	0.22565	9.62	20.67	17.53	30.29	27.15	62.61	52.61	-32.32	-25.46
4	0.31800	9.64	11.48	10.38	21.12	20.02	59.76	49.76	-38.64	-29.74
5	2.95000	9.76	8.66	5.11	18.42	14.87	56.00	46.00	-37.58	-31.13
6	6.37000	9.82	12.03	10.00	21.85	19.82	60.00	50.00	-38.15	-30.18

Remarks:

1. Q.P. and AV. are abbreviations of quasi-peak and average individually.
2. The emission levels of other frequencies were very low against the limit.
3. Margin value = Emission level – Limit value
4. Correction factor = Insertion loss + Cable loss
5. Emission Level = Correction Factor + Reading Value

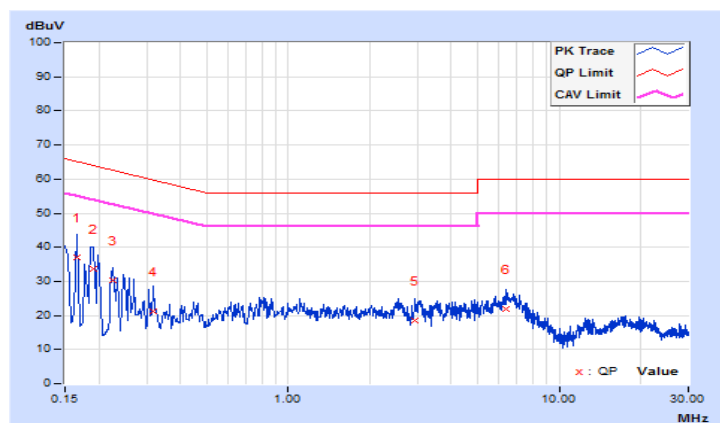

Frequency Range	150kHz ~ 30MHz	Detector Function & Resolution Bandwidth	Quasi-Peak (QP) / Average (AV), 9kHz
Input Power	120Vac, 60Hz	Environmental Conditions	25°C, 65%RH
Tested by	Jisyong Wang	Test Date	2020/5/13
Test Mode	Mode C		

Phase Of Power : Neutral (N)										
No	Frequency (MHz)	Correction Factor (dB)	Reading Value (dBuV)		Emission Level (dBuV)		Limit (dBuV)		Margin (dB)	
			Q.P.	AV.	Q.P.	AV.	Q.P.	AV.	Q.P.	AV.
1	0.18200	9.65	16.26	13.18	25.91	22.83	64.39	54.39	-38.48	-31.56
2	0.20600	9.64	13.23	10.16	22.87	19.80	63.37	53.37	-40.50	-33.57
3	0.46200	9.67	10.12	8.28	19.79	17.95	56.66	46.66	-36.87	-28.71
4	0.81000	9.69	8.05	6.21	17.74	15.90	56.00	46.00	-38.26	-30.10
5	2.07400	9.76	2.83	1.54	12.59	11.30	56.00	46.00	-43.41	-34.70
6	4.67400	9.83	15.50	13.05	25.33	22.88	56.00	46.00	-30.67	-23.12

Remarks:

1. Q.P. and AV. are abbreviations of quasi-peak and average individually.
2. The emission levels of other frequencies were very low against the limit.
3. Margin value = Emission level – Limit value
4. Correction factor = Insertion loss + Cable loss
5. Emission Level = Correction Factor + Reading Value

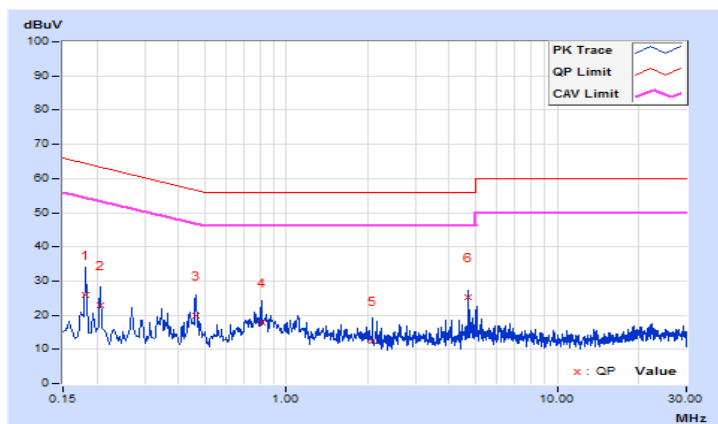

<LE 5.1>

Frequency Range	150kHz ~ 30MHz	Detector Function & Resolution Bandwidth	Quasi-Peak (QP) / Average (AV), 9kHz
Input Power	120Vac, 60Hz	Environmental Conditions	25°C, 65%RH
Tested by	Jisyong Wang	Test Date	2020/5/13
Test Mode	Mode C		

Phase Of Power : Line (L)										
No	Frequency (MHz)	Correction Factor (dB)	Reading Value (dBuV)		Emission Level (dBuV)		Limit (dBuV)		Margin (dB)	
			Q.P.	AV.	Q.P.	AV.	Q.P.	AV.	Q.P.	AV.
1	0.16579	9.63	26.78	21.64	36.41	31.27	65.17	55.17	-28.76	-23.90
2	0.19000	9.62	23.39	20.16	33.01	29.78	64.04	54.04	-31.03	-24.26
3	0.23000	9.62	19.09	12.65	28.71	22.27	62.45	52.45	-33.74	-30.18
4	0.26200	9.63	15.05	11.54	24.68	21.17	61.37	51.37	-36.69	-30.20
5	4.67400	9.80	14.28	10.46	24.08	20.26	56.00	46.00	-31.92	-25.74
6	6.80200	9.83	10.90	8.50	20.73	18.33	60.00	50.00	-39.27	-31.67

Remarks:

1. Q.P. and AV. are abbreviations of quasi-peak and average individually.
2. The emission levels of other frequencies were very low against the limit.
3. Margin value = Emission level – Limit value
4. Correction factor = Insertion loss + Cable loss
5. Emission Level = Correction Factor + Reading Value

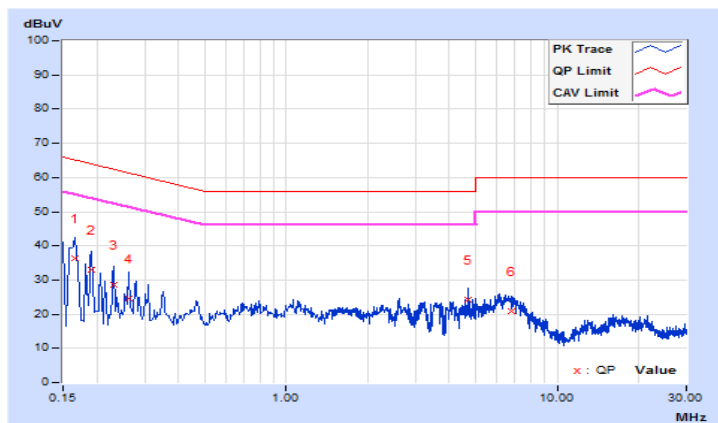

Frequency Range	150kHz ~ 30MHz	Detector Function & Resolution Bandwidth	Quasi-Peak (QP) / Average (AV), 9kHz
Input Power	120Vac, 60Hz	Environmental Conditions	25°C, 65%RH
Tested by	Jisyong Wang	Test Date	2020/5/13
Test Mode	Mode C		

Phase Of Power : Neutral (N)										
No	Frequency (MHz)	Correction Factor (dB)	Reading Value (dBuV)		Emission Level (dBuV)		Limit (dBuV)		Margin (dB)	
			Q.P.	AV.	Q.P.	AV.	Q.P.	AV.	Q.P.	AV.
1	0.15800	9.66	18.58	13.78	28.24	23.44	65.57	55.57	-37.33	-32.13
2	0.18200	9.65	16.75	14.99	26.40	24.64	64.39	54.39	-37.99	-29.75
3	0.21400	9.64	11.75	10.92	21.39	20.56	63.05	53.05	-41.66	-32.49
4	0.83400	9.69	6.93	5.12	16.62	14.81	56.00	46.00	-39.38	-31.19
5	2.06600	9.76	3.01	1.57	12.77	11.33	56.00	46.00	-43.23	-34.67
6	4.67800	9.83	10.67	8.23	20.50	18.06	56.00	46.00	-35.50	-27.94

Remarks:

1. Q.P. and AV. are abbreviations of quasi-peak and average individually.
2. The emission levels of other frequencies were very low against the limit.
3. Margin value = Emission level – Limit value
4. Correction factor = Insertion loss + Cable loss
5. Emission Level = Correction Factor + Reading Value

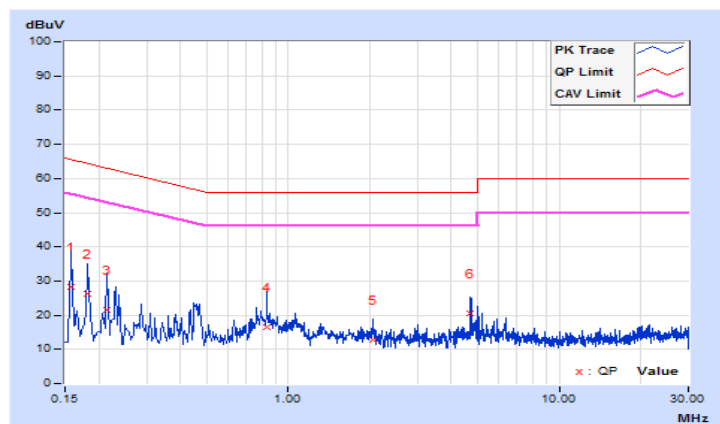

<LE 4.0>

Frequency Range	150kHz ~ 30MHz	Detector Function & Resolution Bandwidth	Quasi-Peak (QP) / Average (AV), 9kHz
Input Power	120Vac, 60Hz	Environmental Conditions	25°C, 65%RH
Tested by	Jisyong Wang	Test Date	2020/5/13
Test Mode	Mode D		

Phase Of Power : Line (L)										
No	Frequency (MHz)	Correction Factor (dB)	Reading Value (dBuV)		Emission Level (dBuV)		Limit (dBuV)		Margin (dB)	
			Q.P.	AV.	Q.P.	AV.	Q.P.	AV.	Q.P.	AV.
1	0.16799	9.63	35.74	27.52	45.37	37.15	65.06	55.06	-19.69	-17.91
2	0.17800	9.62	35.39	27.04	45.01	36.66	64.58	54.58	-19.57	-17.92
3	0.20577	9.62	31.57	28.36	41.19	37.98	63.37	53.37	-22.18	-15.39
4	0.23000	9.62	27.64	21.02	37.26	30.64	62.45	52.45	-25.19	-21.81
5	0.25400	9.63	24.45	21.63	34.08	31.26	61.63	51.63	-27.55	-20.37
6	6.61000	9.82	16.76	11.04	26.58	20.86	60.00	50.00	-33.42	-29.14

Remarks:

1. Q.P. and AV. are abbreviations of quasi-peak and average individually.
2. The emission levels of other frequencies were very low against the limit.
3. Margin value = Emission level – Limit value
4. Correction factor = Insertion loss + Cable loss
5. Emission Level = Correction Factor + Reading Value

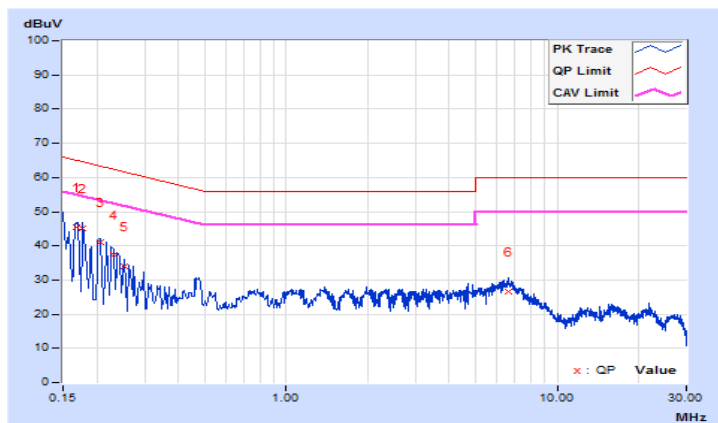

Frequency Range	150kHz ~ 30MHz	Detector Function & Resolution Bandwidth	Quasi-Peak (QP) / Average (AV), 9kHz
Input Power	120Vac, 60Hz	Environmental Conditions	25°C, 65%RH
Tested by	Jisyong Wang	Test Date	2020/5/13
Test Mode	Mode D		

Phase Of Power : Neutral (N)										
No	Frequency (MHz)	Correction Factor (dB)	Reading Value (dBuV)		Emission Level (dBuV)		Limit (dBuV)		Margin (dB)	
			Q.P.	AV.	Q.P.	AV.	Q.P.	AV.	Q.P.	AV.
1	0.18200	9.65	35.76	30.95	45.41	40.60	64.39	54.39	-18.98	-13.79
2	0.22985	9.64	28.49	24.80	38.13	34.44	62.46	52.46	-24.33	-18.02
3	0.25000	9.65	26.66	23.98	36.31	33.63	61.76	51.76	-25.45	-18.13
4	0.30600	9.66	19.25	15.83	28.91	25.49	60.08	50.08	-31.17	-24.59
5	0.46200	9.67	18.56	13.49	28.23	23.16	56.66	46.66	-28.43	-23.50
6	4.57000	9.83	16.94	12.19	26.77	22.02	56.00	46.00	-29.23	-23.98

Remarks:

1. Q.P. and AV. are abbreviations of quasi-peak and average individually.
2. The emission levels of other frequencies were very low against the limit.
3. Margin value = Emission level – Limit value
4. Correction factor = Insertion loss + Cable loss
5. Emission Level = Correction Factor + Reading Value

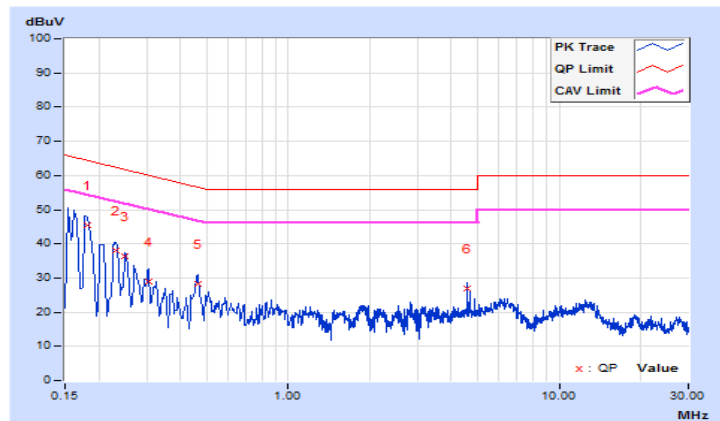

<LE 5.1>

Frequency Range	150kHz ~ 30MHz	Detector Function & Resolution Bandwidth	Quasi-Peak (QP) / Average (AV), 9kHz
Input Power	120Vac, 60Hz	Environmental Conditions	25°C, 65%RH
Tested by	Jisyong Wang	Test Date	2020/5/13
Test Mode	Mode D		

Phase Of Power : Line (L)										
No	Frequency (MHz)	Correction Factor (dB)	Reading Value (dBuV)		Emission Level (dBuV)		Limit (dBuV)		Margin (dB)	
			Q.P.	AV.	Q.P.	AV.	Q.P.	AV.	Q.P.	AV.
1	0.19400	9.62	32.96	30.49	42.58	40.11	63.86	53.86	-21.28	-13.75
2	0.23800	9.63	26.76	21.19	36.39	30.82	62.17	52.17	-25.78	-21.35
3	0.26200	9.63	23.71	20.85	33.34	30.48	61.37	51.37	-28.03	-20.89
4	0.46567	9.65	17.72	12.96	27.37	22.61	56.59	46.59	-29.22	-23.98
5	0.80200	9.67	15.06	11.16	24.73	20.83	56.00	46.00	-31.27	-25.17
6	6.36200	9.82	16.42	10.50	26.24	20.32	60.00	50.00	-33.76	-29.68

Remarks:

1. Q.P. and AV. are abbreviations of quasi-peak and average individually.
2. The emission levels of other frequencies were very low against the limit.
3. Margin value = Emission level – Limit value
4. Correction factor = Insertion loss + Cable loss
5. Emission Level = Correction Factor + Reading Value

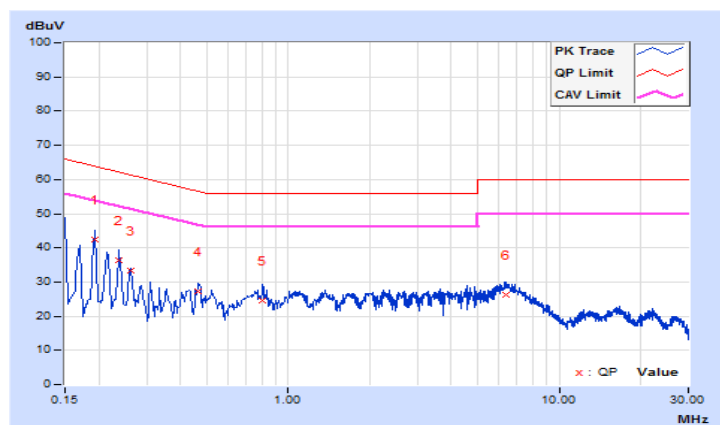

Frequency Range	150kHz ~ 30MHz	Detector Function & Resolution Bandwidth	Quasi-Peak (QP) / Average (AV), 9kHz
Input Power	120Vac, 60Hz	Environmental Conditions	25°C, 65%RH
Tested by	Jisyong Wang	Test Date	2020/5/13
Test Mode	Mode D		

Phase Of Power : Neutral (N)										
No	Frequency (MHz)	Correction Factor (dB)	Reading Value (dBuV)		Emission Level (dBuV)		Limit (dBuV)		Margin (dB)	
			Q.P.	AV.	Q.P.	AV.	Q.P.	AV.	Q.P.	AV.
1	0.15800	9.66	39.05	31.53	48.71	41.19	65.57	55.57	-16.86	-14.38
2	0.17000	9.65	35.09	33.60	44.74	43.25	64.96	54.96	-20.22	-11.71
3	0.21800	9.64	29.77	23.96	39.41	33.60	62.89	52.89	-23.48	-19.29
4	0.25000	9.65	26.31	23.95	35.96	33.60	61.76	51.76	-25.80	-18.16
5	0.45800	9.67	18.46	15.18	28.13	24.85	56.73	46.73	-28.60	-21.88
6	4.77400	9.83	13.95	11.44	23.78	21.27	56.00	46.00	-32.22	-24.73

Remarks:

1. Q.P. and AV. are abbreviations of quasi-peak and average individually.
2. The emission levels of other frequencies were very low against the limit.
3. Margin value = Emission level – Limit value
4. Correction factor = Insertion loss + Cable loss
5. Emission Level = Correction Factor + Reading Value

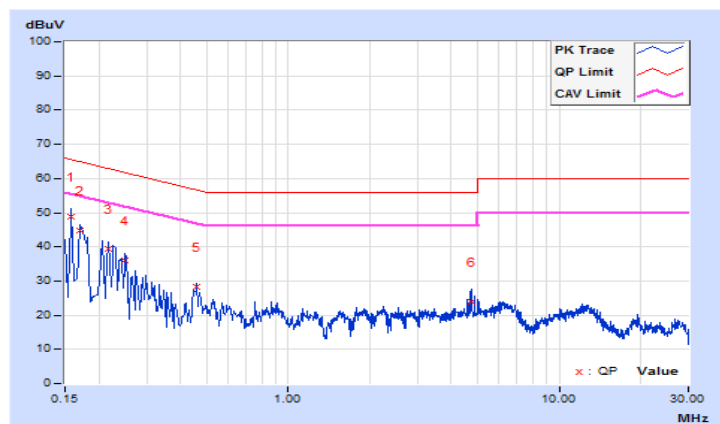

4.3 6 dB Bandwidth Measurement

4.3.1 Limits of 6 dB Bandwidth Measurement

The minimum of 6 dB Bandwidth Measurement is 0.5 MHz.

4.3.2 Test Setup



4.3.3 Test Instruments

Refer to section 4.1.2 to get information of above instrument.

4.3.4 Test Procedure

- a. Set resolution bandwidth (RBW) = 100 kHz
- b. Set the video bandwidth (VBW) $\geq 3 \times$ RBW, Detector = Peak.
- c. Trace mode = max hold.
- d. Sweep = auto couple.
- e. Measure the maximum width of the emission that is constrained by the frequencies associated with the two amplitude points (upper and lower) that are attenuated by 6 dB relative to the maximum level measured in the fundamental emission

4.3.5 Deviation from Test Standard

No deviation.

4.3.6 EUT Operating Conditions

The software provided by client to enable the EUT under transmission condition continuously at lowest, middle and highest channel frequencies individually.

4.3.7 Test Results

<LE 4.0>

Channel	Frequency (MHz)	6 dB Bandwidth (MHz)	Minimum Limit (MHz)	Pass / Fail
0	2402	0.73	0.5	Pass
19	2440	0.73	0.5	Pass
39	2480	0.73	0.5	Pass

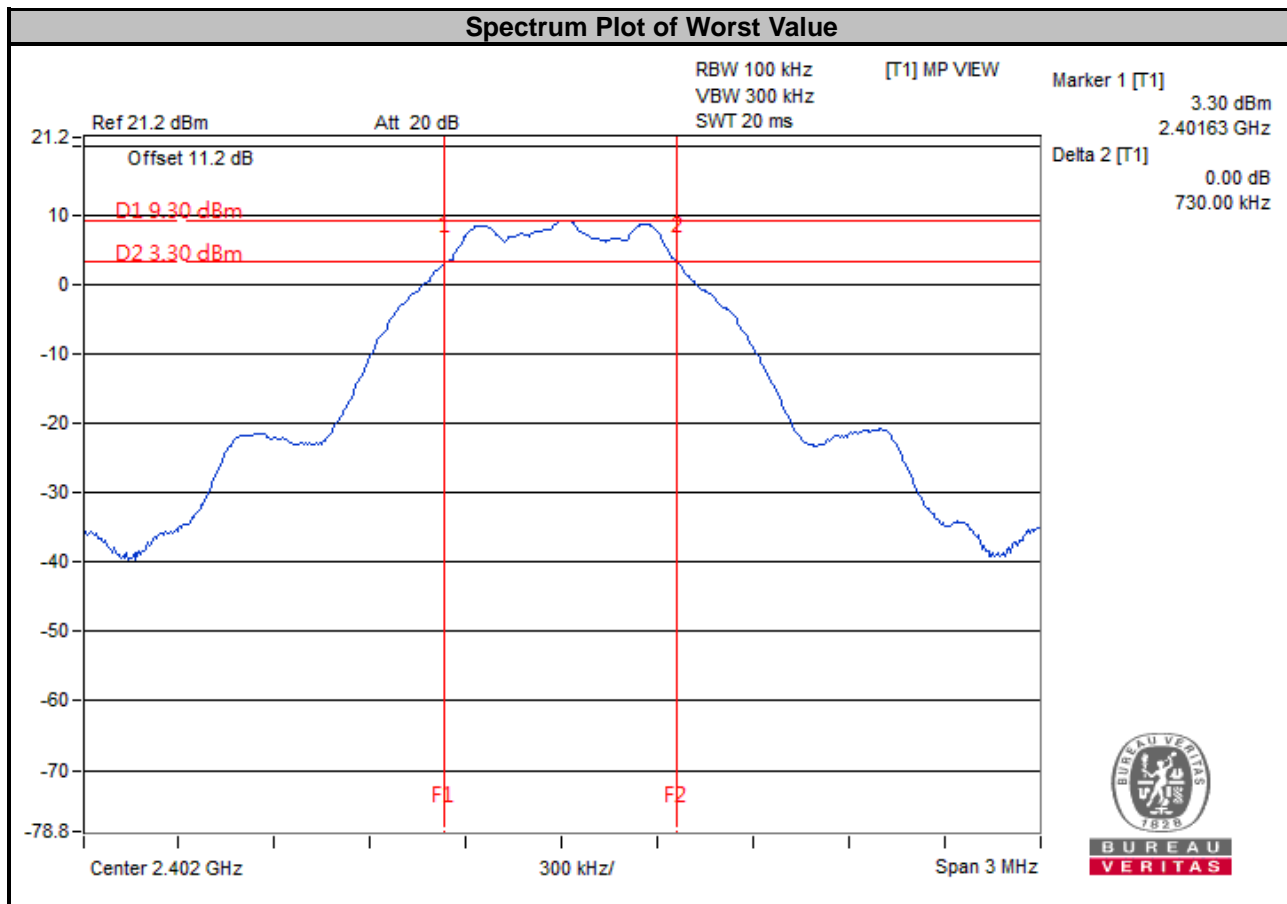

<LE 5.1>

Channel	Frequency (MHz)	6 dB Bandwidth (MHz)	Minimum Limit (MHz)	Pass / Fail
0	2402	1.27	0.5	Pass
19	2440	1.27	0.5	Pass
39	2480	1.26	0.5	Pass

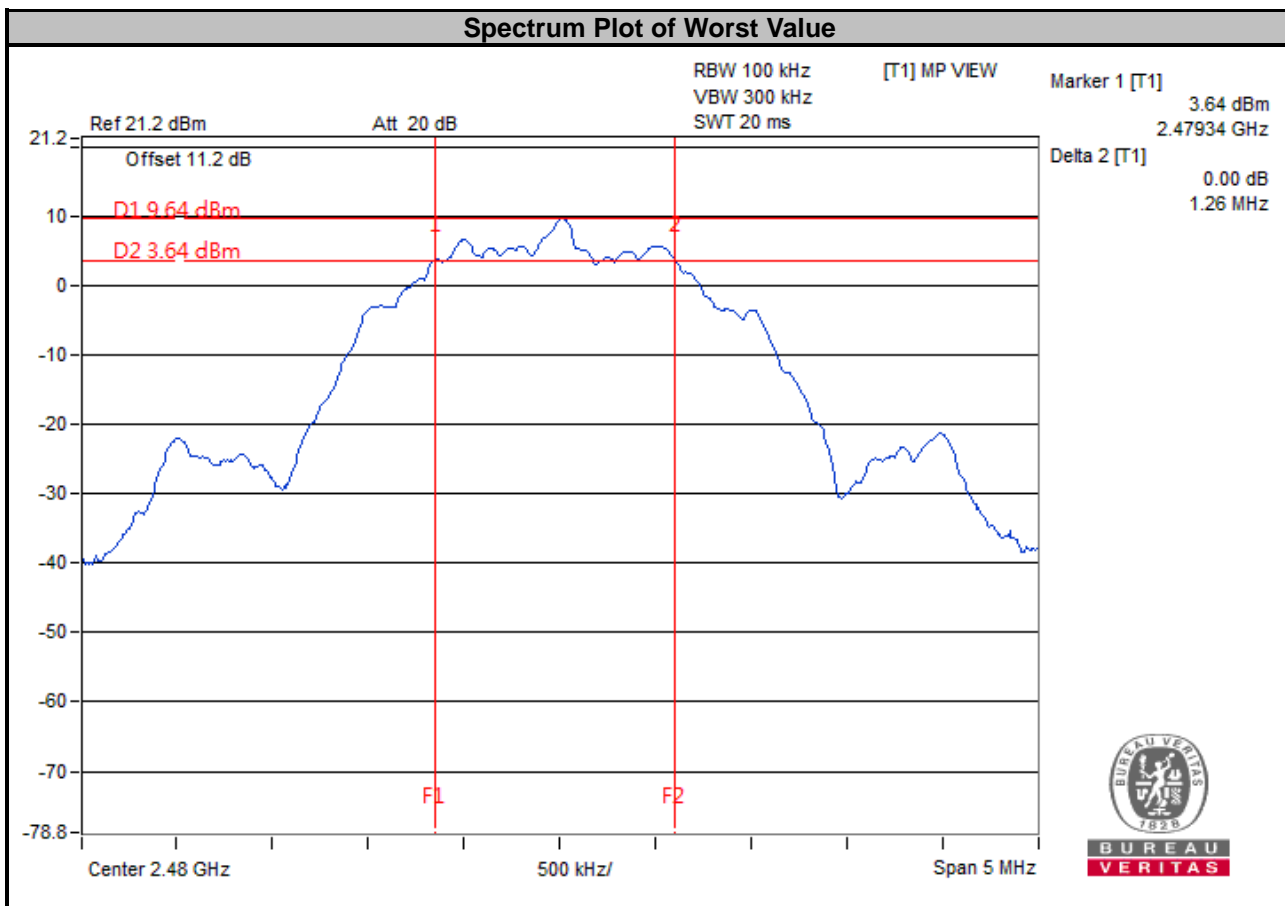

4.4 Occupied Bandwidth Measurement

4.4.1 Test Setup

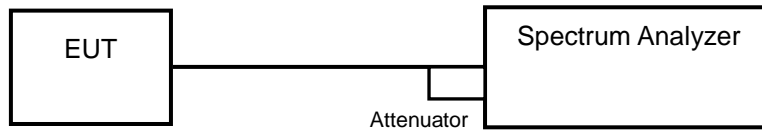

4.4.2 Test Instruments

Refer to section 4.1.2 to get information of above instrument.

4.4.3 Test Procedure

The transmitter output was connected to the spectrum analyzer through an attenuator. The bandwidth of the fundamental frequency was measured by spectrum analyzer with resolution bandwidth in the range of 1 % to 5 % of the anticipated emission bandwidth, and a video bandwidth at least 3x the resolution bandwidth and set the detector to sampling. The width of a frequency band such that, below the lower and above the upper frequency limits, the mean powers emitted are each equal to a specified percentage 0.5 % of the total mean power of a given emission.

4.4.4 Deviation from Test Standard

No deviation.

4.4.5 EUT Operating Conditions

The software provided by client to enable the EUT under transmission condition continuously at lowest, middle and highest channel frequencies individually.

4.4.6 Test Results

<LE 4.0>

Channel	Frequency (MHz)	Occupied Bandwidth (MHz)	Pass / Fail
0	2402	1.04	Pass
19	2440	1.03	Pass
39	2480	1.03	Pass

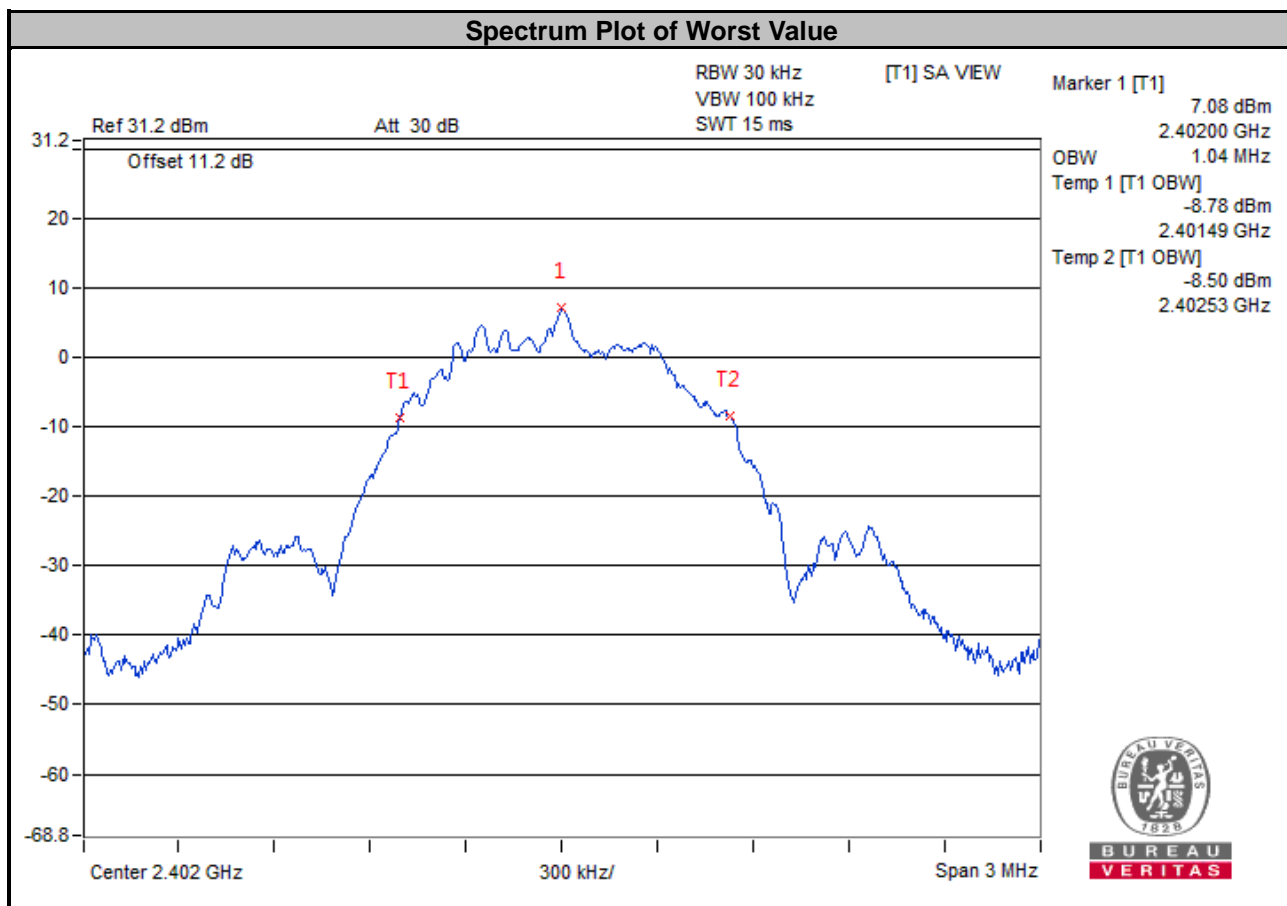

<LE 5.1>

Channel	Frequency (MHz)	Occupied Bandwidth (MHz)	Pass / Fail
0	2402	2.06	Pass
19	2440	2.05	Pass
39	2480	2.05	Pass

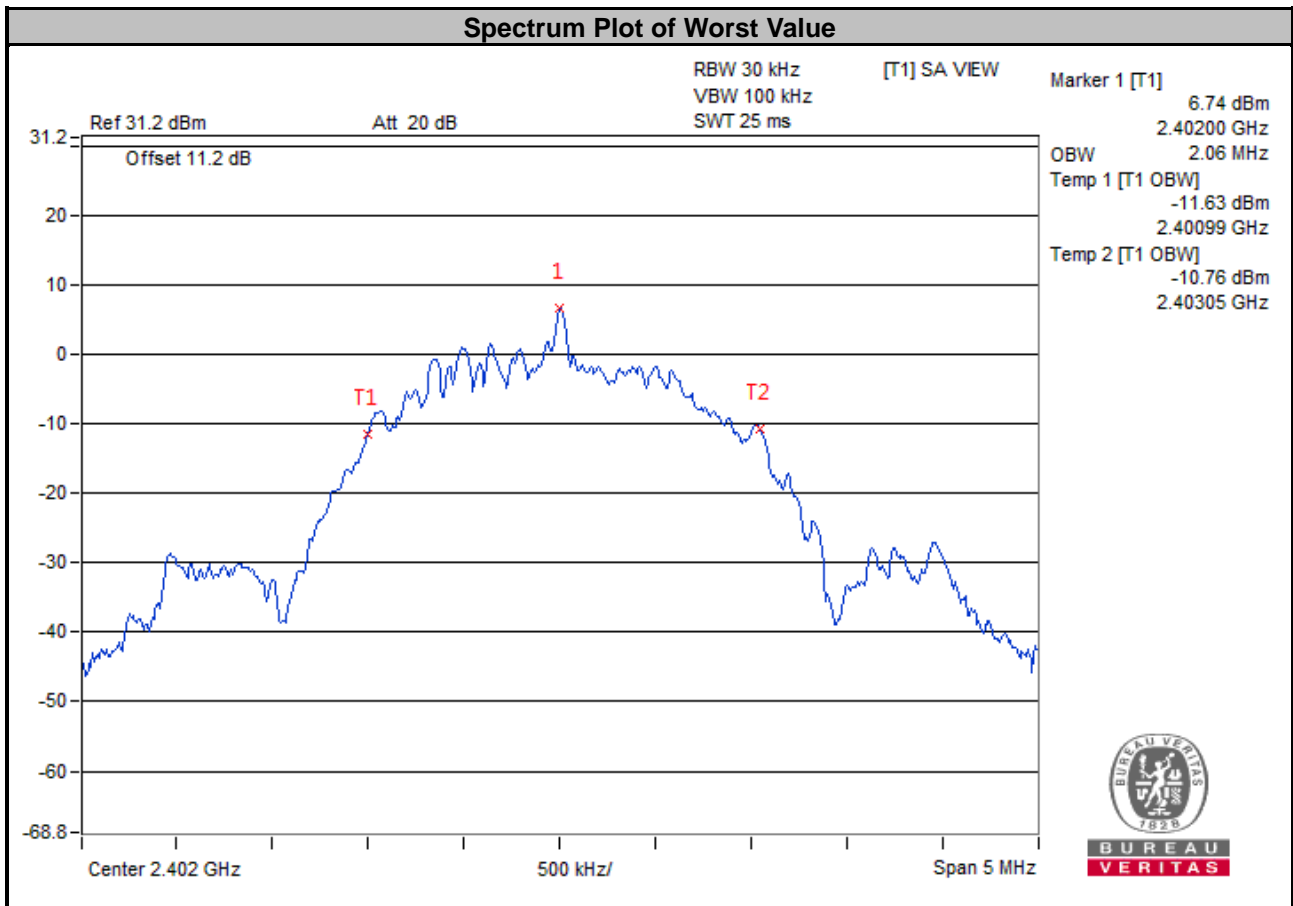

4.5 Conducted Output Power Measurement

4.5.1 Limits of Conducted Output Power Measurement

For systems using digital modulation in the 2400–2483.5 MHz bands: 1 Watt (30 dBm)

4.5.2 Test Setup

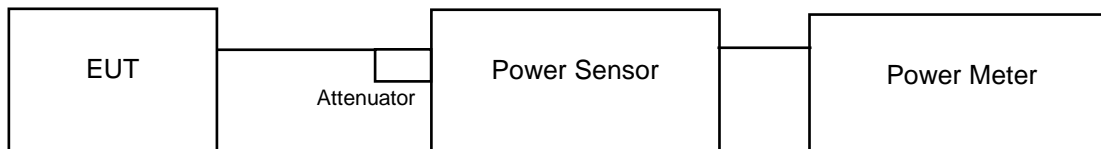

4.5.3 Test Instruments

Refer to section 4.1.2 to get information of above instrument.

4.5.4 Test Procedures

A peak power sensor was used on the output port of the EUT. A power meter was used to read the response of the peak power sensor. Record the power level.

Average power sensor was used to perform output power measurement, trigger and gating function of wide band power meter is enabled to measure max output power of TX on burst. Duty factor is not added to measured value.

4.5.5 Deviation from Test Standard

No deviation.

4.5.6 EUT Operating Conditions

The software provided by client to enable the EUT under transmission condition continuously at lowest, middle and highest channel frequencies individually.

4.5.7 Test Results

<LE 4.0>

Channel	Freq. (MHz)	Peak Power		Average Power		Power Limit (dBm)	Pass / Fail
		(mW)	(dBm)	(mW)	(dBm)		
0	2402	7.244	8.60	7.129	8.53	30	Pass
19	2440	7.709	8.87	7.568	8.79	30	Pass
39	2480	7.834	8.94	7.691	8.86	30	Pass

<LE 5.1>

Channel	Freq. (MHz)	Peak Power		Average Power		Power Limit (dBm)	Pass / Fail
		(mW)	(dBm)	(mW)	(dBm)		
0	2402	7.328	8.65	7.211	8.58	30	Pass
19	2440	7.727	8.88	7.603	8.81	30	Pass
39	2480	7.674	8.85	7.551	8.78	30	Pass

4.6 Power Spectral Density Measurement

4.6.1 Limits of Power Spectral Density Measurement

The Maximum of Power Spectral Density Measurement is 8 dBm in any 3 kHz band during any time interval of continuous transmission.

4.6.2 Test Setup



4.6.3 Test Instruments

Refer to section 4.1.2 to get information of above instrument.

4.6.4 Test Procedure

- a. Set analyzer center frequency to DTS channel center frequency.
- b. Set the span to 1.5 times the DTS bandwidth.
- c. Set the RBW to: $3 \text{ kHz} \leq \text{RBW} \leq 100 \text{ kHz}$.
- d. Set the VBW $\geq 3 \times \text{RBW}$.
- e. Detector = peak.
- f. Sweep time = auto couple.
- g. Trace mode = max hold.
- h. Allow trace to fully stabilize.
- i. Use the peak marker function to determine the maximum amplitude level within the RBW.

4.6.5 Deviation from Test Standard

No deviation.

4.6.6 EUT Operating Condition

The software provided by client to enable the EUT under transmission condition continuously at lowest, middle and highest channel frequencies individually.

4.6.7 Test Results

<LE 4.0>

Channel	Frequency (MHz)	PSD (dBm/3 kHz)	Limit (dBm/3 kHz)	Pass / Fail
0	2402	-5.67	8	Pass
19	2440	-5.34	8	Pass
39	2480	-5.29	8	Pass

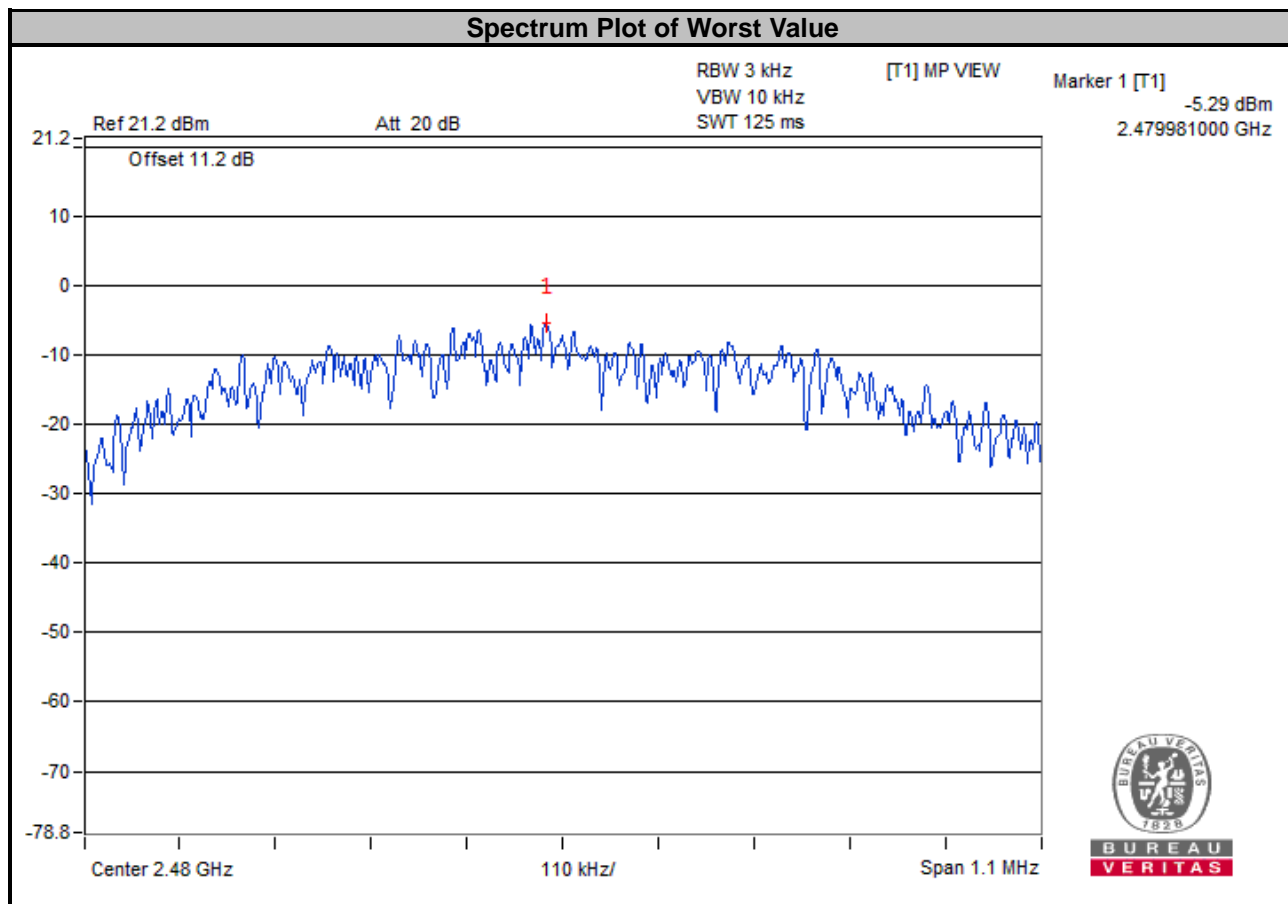

<LE 5.1>

Channel	Frequency (MHz)	PSD (dBm/3 kHz)	Limit (dBm/3 kHz)	Pass / Fail
0	2402	-8.23	8	Pass
19	2440	-7.99	8	Pass
39	2480	-7.85	8	Pass

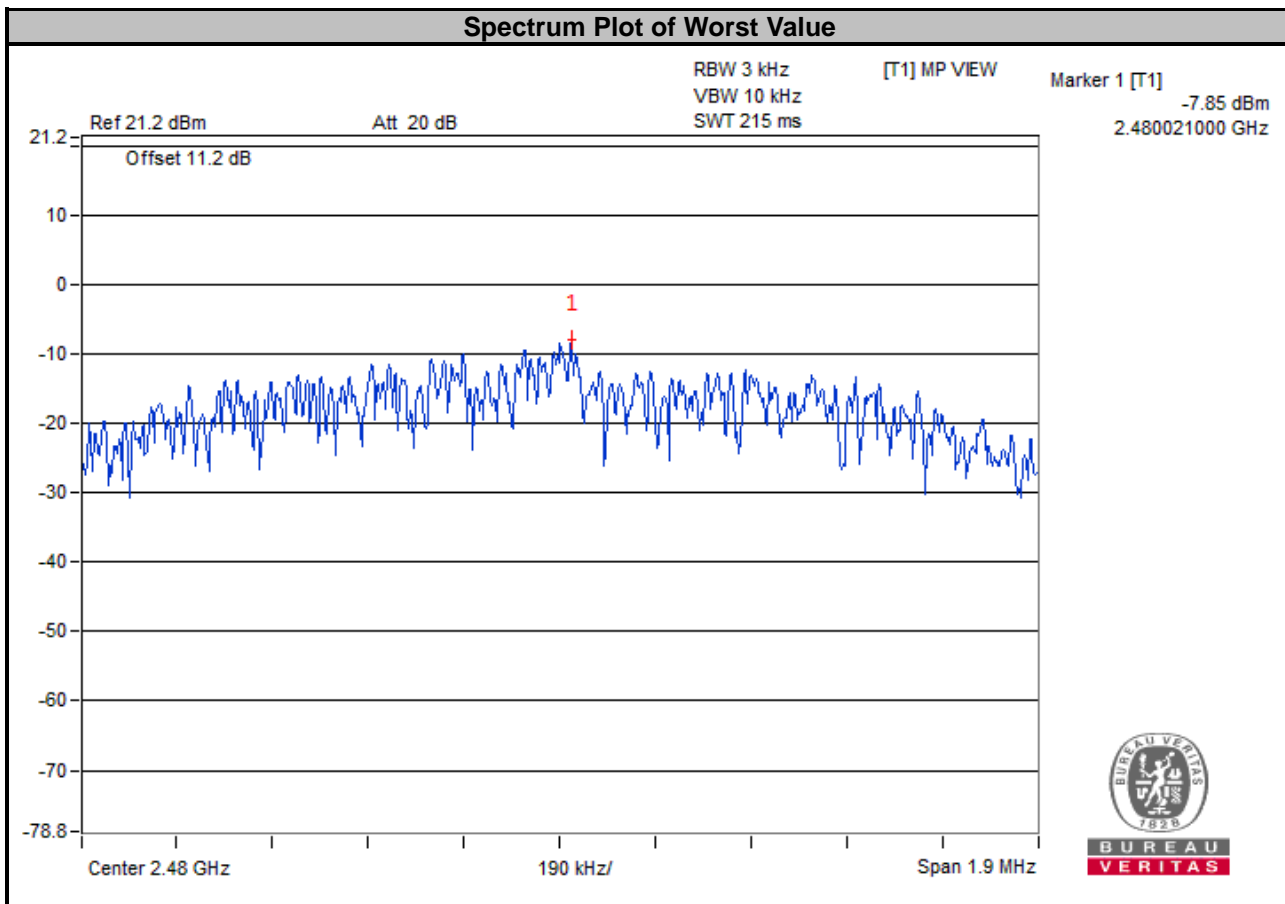

4.7 Conducted Out of Band Emission Measurement

4.7.1 Limits of Conducted Out of Band Emission Measurement

Below -20 dB of the highest emission level of operating band (in 100 kHz Resolution Bandwidth).

4.7.2 Test Setup

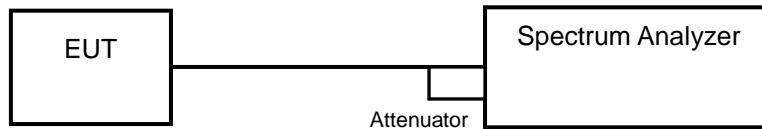

4.7.3 Test Instruments

Refer to section 4.1.2 to get information of above instrument.

4.7.4 Test Procedure

MEASUREMENT PROCEDURE REF

1. Set the RBW = 100 kHz.
2. Set the VBW \geq 300 kHz.
3. Detector = peak.
4. Sweep time = auto couple.
5. Trace mode = max hold.
6. Allow trace to fully stabilize.
7. Use the peak marker function to determine the maximum power level in any 100 kHz band segment within the fundamental EBW.

MEASUREMENT PROCEDURE OOB

1. Set RBW = 100 kHz.
2. Set VBW \geq 300 kHz.
3. Detector = peak.
4. Sweep = auto couple.
5. Trace Mode = max hold.
6. Allow trace to fully stabilize.
7. Use the peak marker function to determine the maximum amplitude level.

4.7.5 Deviation from Test Standard

No deviation.

4.7.6 EUT Operating Condition

The software provided by client to enable the EUT under transmission condition continuously at lowest, middle and highest channel frequencies individually.

4.7.7 Test Results

The spectrum plots are attached on the following images. D1 line indicates the highest level, D2 line indicates the 20 dB offset below D1. It shows compliance with the requirement.

<LE 4.0>

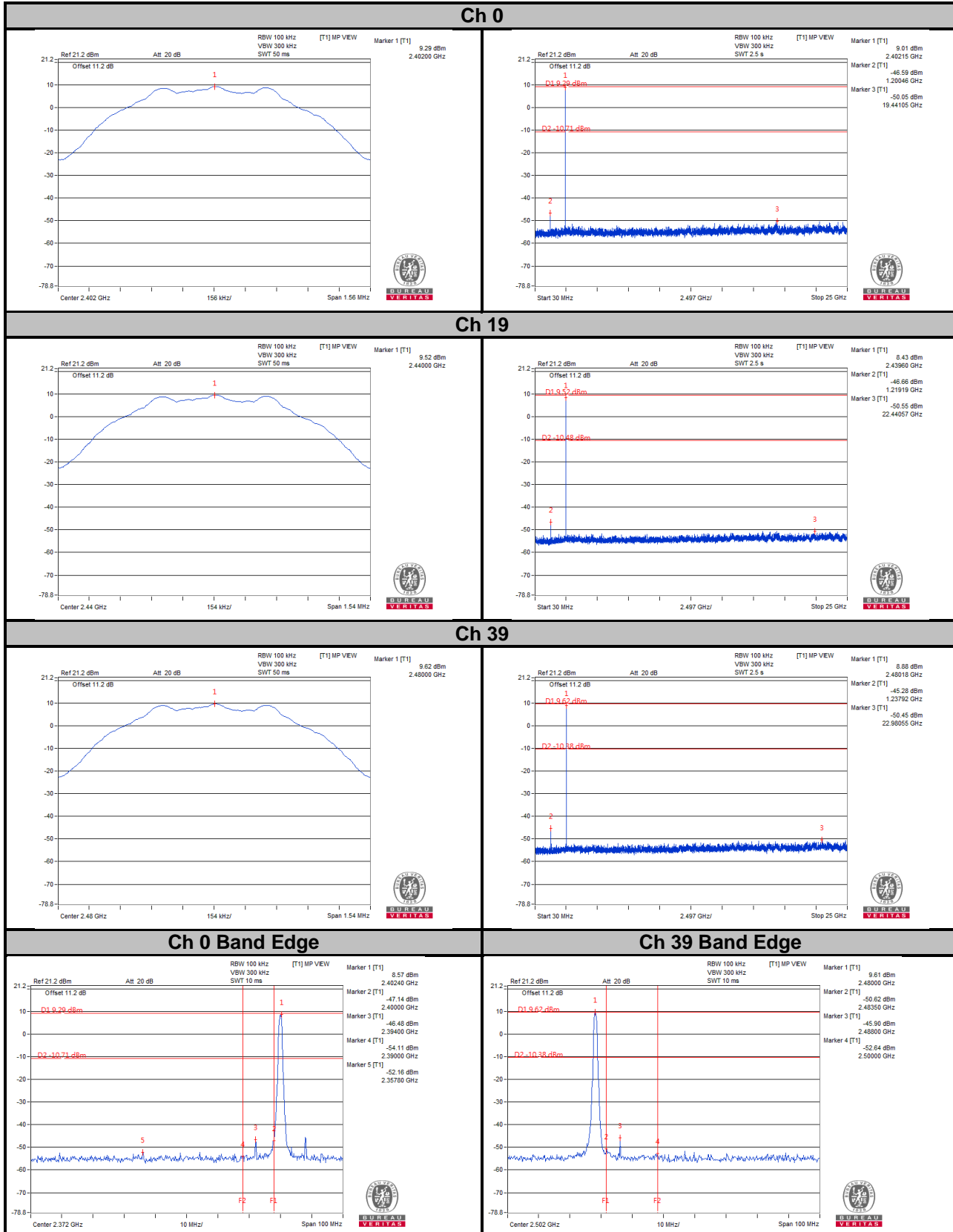

<LE 5.1>

Ch 0

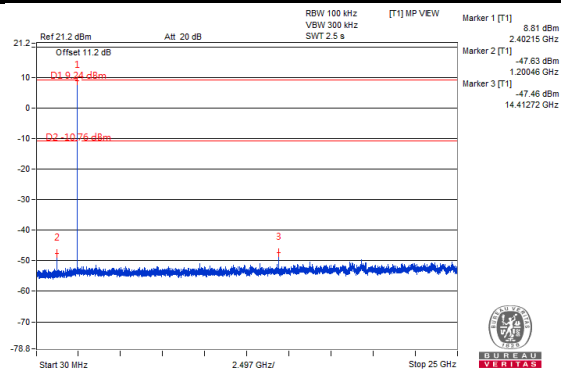
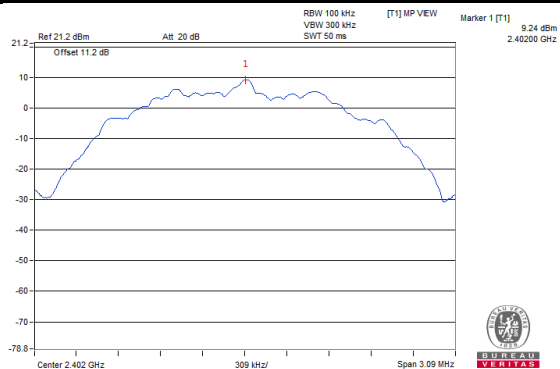

Ch 19

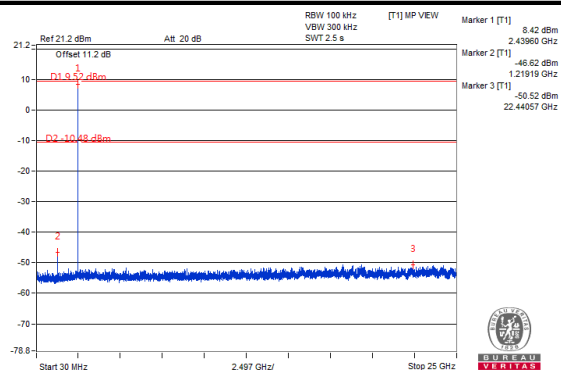
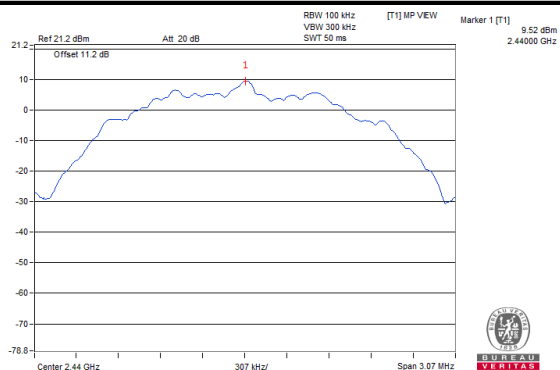

Ch 39

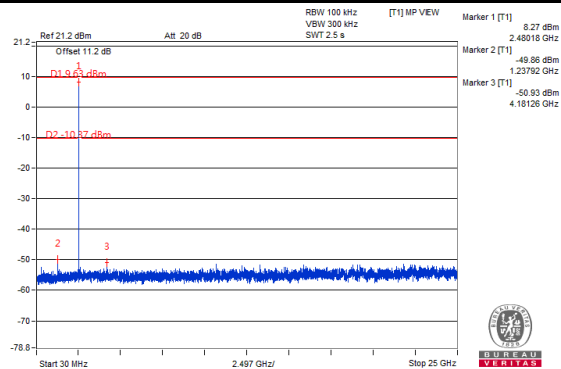
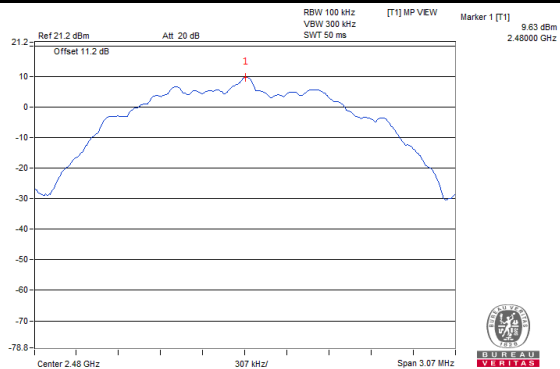

Ch 0 Band Edge

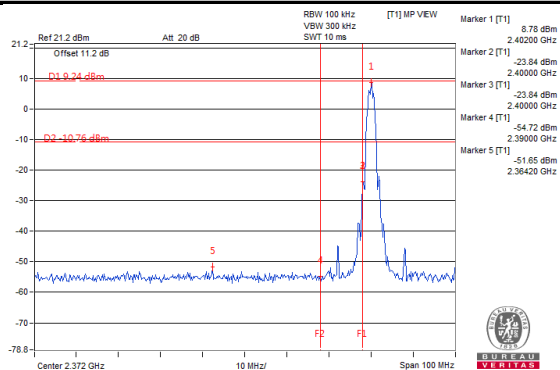

Ch 39 Band Edge

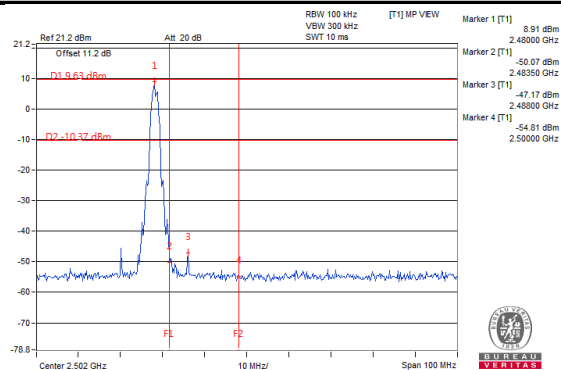

5 Photographs of the Test Configuration

Please refer to the attached file (Reference no.: RF200508C01 (TSup photo_left earbud)).

6 Construction Photos of EUT

Please refer to the attached file (200508C01 (EUT photo)).

Appendix – Information of the Testing Laboratories

We, Bureau Veritas Consumer Products Services (H.K.) Ltd., Taoyuan Branch, were founded in 1988 to provide our best service in EMC, Radio, Telecom and Safety consultation. Our laboratories are FCC recognized accredited test firms and accredited according to ISO/IEC 17025.

If you have any comments, please feel free to contact us at the following:

Lin Kou EMC/RF Lab

Tel: 886-2-26052180

Fax: 886-2-26051924

Hsin Chu EMC/RF/Telecom Lab

Tel: 886-3-6668565

Fax: 886-3-6668323

Hwa Ya EMC/RF/Safety Lab

Tel: 886-3-3183232

Fax: 886-3-3270892

Email: service.adt@tw.bureauveritas.com

Web Site: www.bureauveritas-adt.com

The address and road map of all our labs can be found in our web site also.

--- END ---