



DECT Headset System
DW Office
Instruction manual

Contents

Important safety information	2
The DW Office wireless headset system	4
Delivery includes	5
Product overview	6
Base station	6
Headset	7
Overview of the buttons	8
Overview of the LEDs	9
Putting the headset system into operation	10
Putting the base station into operation	10
Putting the headset into operation	16
Testing the headset system in Phone mode and adjusting it	17
Testing the headset system in PC mode and adjusting it	19
Adjusting advanced settings	20
Using the headset system	22
Charging the headset rechargeable battery	22
Switching the headset on/off	23
Establishing a wireless link between headset and base station	23
Putting the headset on and adjusting it	24
Calling via the fixed line phone using the headset	24
Calling via the PC using the headset	26
Switching between Phone and PC mode	28
Adjusting the volume	28
Muting the headset's microphone	29
Using the advanced functions	29
If you leave the DECT range	31
Cleaning and maintaining the headset system	32
Replacing the ear pad of the headband	33
Replacing the headset's rechargeable battery	34
If a problem occurs	35
Accessories and spare parts	36
Specifications	37
Manufacturer Declarations	39
Index	41

Important safety information

- Please read these instructions carefully and completely before using the product.
- Make these instructions easily accessible to all users at all times. Always include these instructions when passing the product on to third parties.
- Do not use the product in situations which require special attention (e.g. when performing skilled jobs).
- Always keep the product dry and do not expose it to extreme temperatures (normal operating temperatures: +5°C/+41°F to +45°C/+113°F).
- Use the product with care and store it in a clean, dust-free environment.
- Switch off the headset after use to conserve battery power.
- Only use the DW Office base station for charging DW Office headsets fitted with the DW Office rechargeable battery. Never try to charge other rechargeable batteries or non-rechargeable batteries in the DW Office base station.
- Do not short-circuit the contacts of the product. Make sure that no metal objects (e.g. paper clips, hair pins, earrings) come into contact with the interfaces and contacts.
- Sennheiser Communications is not liable for damages resulting from the loss of connection due to a run flat battery, an old battery or exceeding the DECT transmission range.
- This equipment generates, uses and can radiate radio frequency energy and, if not used in accordance with the instructions, may cause harmful interference to radio communications. However, there is no guarantee that interference will not occur in a particular installation.
- The DW Office headset contains magnets that generate a magnetic field which could cause interference with cardiac pacemakers and implanted defibrillators. Keep the DW Office headset at least 1.2" (3 cm) from cardiac pacemakers or implanted defibrillators!
- Protect your hearing from high volume levels.
- Only use the mains units supplied by Sennheiser Communications.
- To reduce the risk of fire or electric shock, do not use the product near water and do not expose it to rain or moisture.
- Unplug the mains unit from the wall socket
 - to completely disconnect the product from the mains
 - during lightning storms or
 - when unused for long periods of time.
- Only operate the mains unit from the type of power source specified in the chapter "Specifications" (see page 37).
- Ensure that the mains unit is
 - in a safe operating condition and easily accessible,
 - properly plugged into the wall socket,
 - only operated within the permissible temperature range,
 - not covered or exposed to direct sunlight for longer periods of time in order to prevent heat accumulation (see "Specifications" on page 37).

- Do not operate the product near any heat sources.
- Only use attachments/accessories specified by Sennheiser Communications (see “Accessories” on page 36).
- Keep plastic wrap and plastic bags of the packaging out of reach of children – danger of suffocation!

Intended use

Intended use of the product includes

- having read this instruction manual, especially the chapter “Important safety instructions” on page 2,
- using the product within the operating conditions and limitations described in this instruction manual.

“Improper use” means using the product other than as described in this instruction manual, or under operating conditions which differ from those described herein.











Safety instructions for the Lithium-Polymer rechargeable batteries

If abused or misused, rechargeable batteries may leak. In extreme cases, rechargeable batteries may even present



- a heat hazard,
- a fire hazard,
- an explosion hazard,
- a smoke or gas hazard.

Please understand that Sennheiser Communications does not accept liability for damage arising from abuse or misuse.

	Keep away from children.		Do not short-circuit.
	Do not expose to moisture.		Do not heat above +45°C/ +113°F, e.g. do not expose to sunlight or throw into a fire.
	Do not mutilate or dismantle.		Do not charge the rechargeable battery if the device is obviously defective.
	Only charge rechargeable batteries at ambient tempera- tures between +5°C/+41°F to +45°C/+113°F.		Only charge rechargeable batteries with an appropriate Sennheiser Communications charger.
	When not using rechargeable batteries for extended periods of time, charge them regularly (every six months for about one hour).		Store in a cool and dry place at room temperature (approx. 20°C/68°F).
	Return defective devices or devices with defective rechargeable batteries to your specialist dealer.		

The DW Office wireless headset system

The Sennheiser Communications DW Office is a wireless DECT headset system which is intended for professional office use.

- Can be used with a fixed line phone or PC (VoIP)
- Quick link establishment between headset and base station
- Excellent sound quality in narrowband and wideband mode ensures optimum speech intelligibility
- Range of up to 180 m outdoors and up to 55 m indoors
- Monaural headset with 2 wearing styles:
 - earhook or
 - headband with ear pad
- Noise cancelling microphone for optimum speech intelligibility without annoying background noise
- Permits conference calls with up to 4 headsets
- Quick and easy pairing of a new headset
- Long battery operating time:
 - up to 12 hours of talk time in narrowband mode
 - up to 8 hours of talk time in wideband mode
 - up to 4 days of standby time
- Quick and convenient charging of the headset (1 hour)
- [HeadSetup](#) software for convenient call control and headset management via a PC
- Headset can be integrated into existing DECT GAP systems

DECT

The Sennheiser Communications DW Office wireless headset system uses DECT radio technology. Due to a dynamic adjustment of the transmission power, the DECT technology offers an increased transmission range, minimized radiation exposure and has a good energy efficiency. Encrypted radio transmission provides maximum security for wireless communication.



Delivery includes

- 1 base station
- 1 headset with built-in rechargeable battery
- 4 earhooks (size [S](#) (pre-installed), [M](#), [L](#) and [XL](#))
- 1 headband
- 1 name plate with cheek spacer (pre-installed)
- 1 name plate
- 1 mains unit
- 1 telephone cable
- 1 USB cable
- 1 safety guide (booklet with important safety information)
- 1 quick guide
- 1 CD ROM (including, among other things, the [HeadSetup](#) software and a detailed instruction manual as PDF)

Product overview

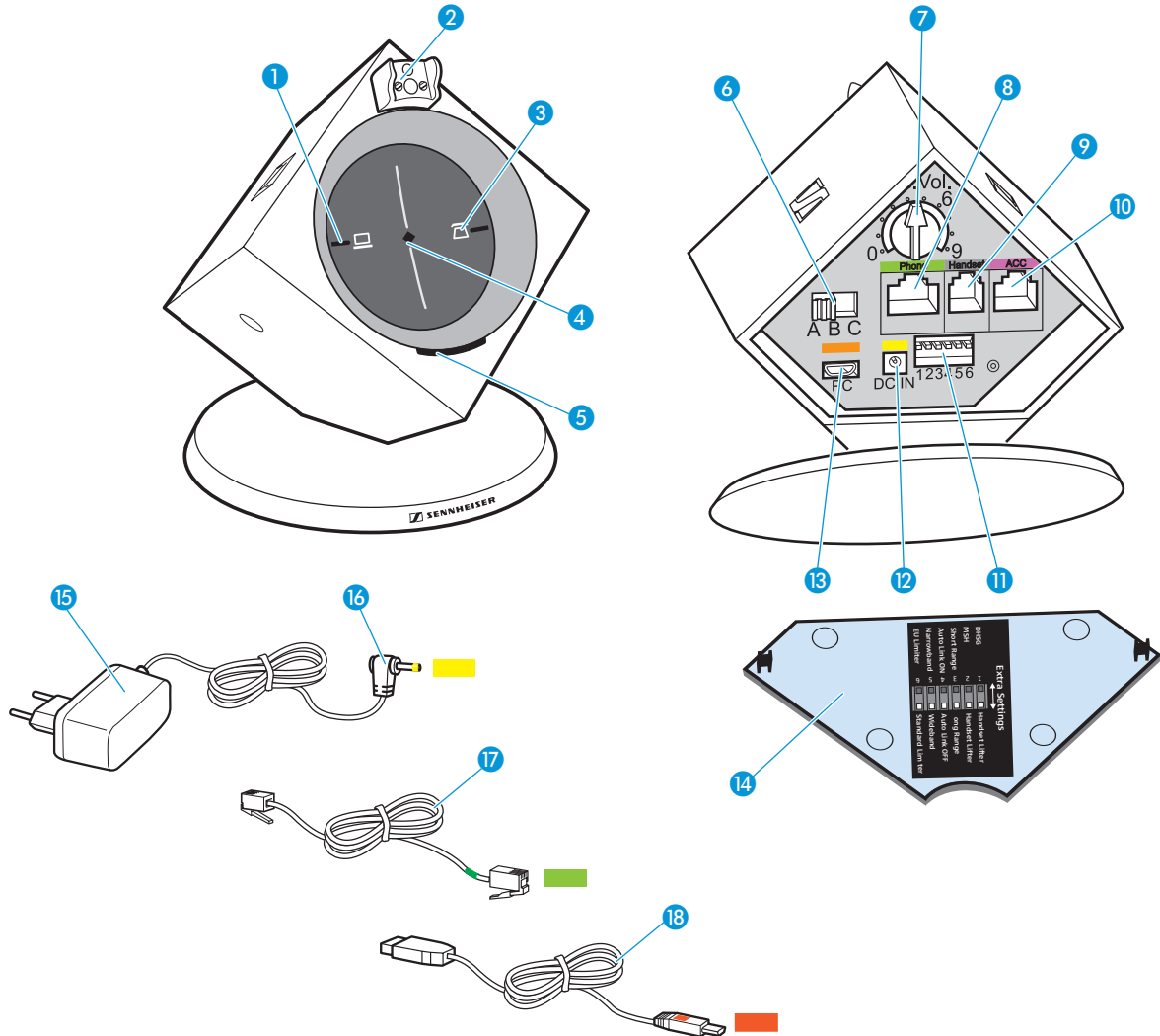
Base station



- 1 PC button  with LED
- 2 Charging contacts
- 3 PHONE button  with LED
- 4 LINK LED
- 5 CHARGE STATUS LED
- 6 ABC switch
- 7 Microphone volume control
- 8 Phone socket
- 9 Handset socket
- 10 ACC socket
- 11 DIP switch row 1 to 6
- 12 DC IN socket
- 13 PC socket (USB)
- 14 Cover with overview of DIP switch assignment
- 15 Mains unit
- 16 DC IN connector
- 17 Telephone cable
- 18 USB cable

Headset

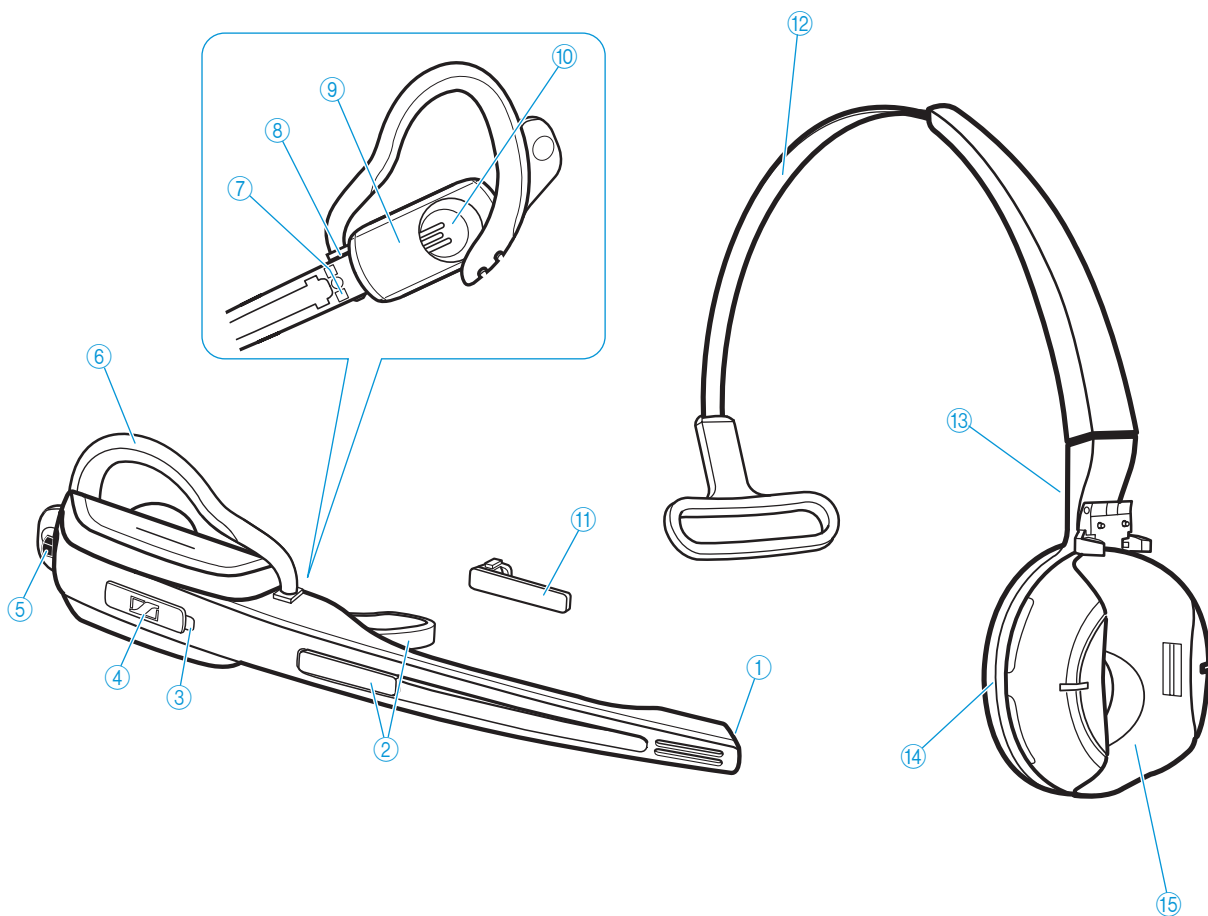



- | | |
|---|-----------------------------|
| ① Microphone | ⑨ Battery compartment cover |
| ② Name plate with cheek spacer | ⑩ Earpiece |
| ③ HEADSET LED | ⑪ Name plate |
| ④ LINK button  | ⑫ Headband |
| ⑤ AUDIO button | ⑬ Charging contacts |
| ⑥ Earhook (size <i>S, M, L, XL</i>) | ⑭ Ear pad |
| ⑦ Charging contacts | ⑮ Headset holder |
| ⑧ Earhook slot | |

Overview of the buttons

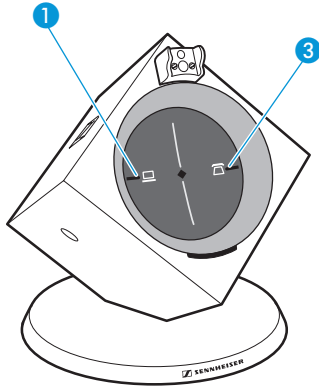

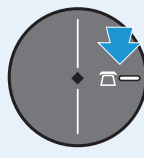

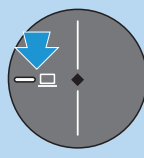



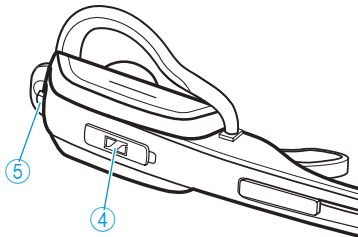



Base station



Action	Button	Functions	Page
▶ Press the PHONE button  ③		Selects the Phone mode	24
		Establishes/disconnects the link between headset and base station	23
		Accepts/ends a call (with electronic call control/handset lifter)	24
▶ Press the PC button  ①		Selects the PC mode	26
		Establishes/disconnects the wireless link between headset and base station	23
		Accepts/ends a call (depending on the softphone used)	26

Headset

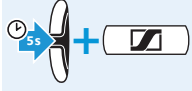



Action	Button	Functions	Page
▶ Press the LINK button  ④		Establishes/disconnects the link between headset and base station	23
		Accepts/ends a call (with electronic call control/handset lifter or depending on the softphone used)	24/26
▶ Press and hold the LINK button  ④ for 5 seconds		Switches the headset on/off	23
▶ Push the AUDIO button  ⑤ upwards/downwards		Increases/reduces the ring tone volume, the volume of the acoustic signals or the audio volume by 1 step	28
▶ Press the AUDIO button  ⑤		Mutes the microphone/unmutes the microphone	29
▶ Press and hold the LINK button  ④ and the AUDIO button  ⑤ for 5 seconds		Setting mode	
		GAP pairing mode	30
		Swaps the assignment of the AUDIO button  ⑤	17

Overview of the LEDs

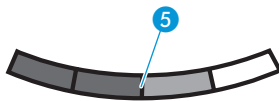
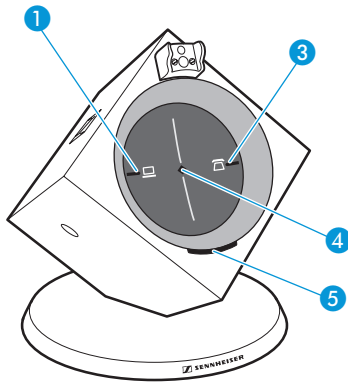
Base station



LED of the PC button  ①	Meaning
lights up	PC mode
flashes	Incoming PC call

LED of the PHONE button  ③	Meaning
lights up	Phone mode
flashes	Incoming telephone call

LINK LED ④	Meaning
lights up blue	Active link to the headset
lights up red	No link to the headset
flashes red	Headset is muted
is off	Standby mode Base station is switched off (not powered)

CHARGE STATUS LED ⑤		
LED segment*	Battery charge	Required charging time
1	0-25%	approx. 10 min
2	25-50%	approx. 10 min
3	50-75%	approx. 20 min
4	75-100%	approx. 20 min
		total: approx. 60 min

* during charging, each segment gets brighter in 5 steps

i When the LED segment 1 flashes in rapid succession, the battery is almost flat. You have to recharge the battery within the next few minutes (see also page 22).

Headset

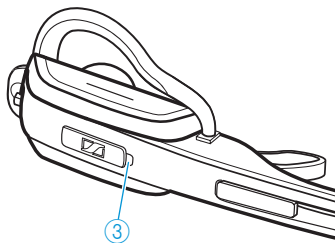

HEADSET LED ③	Meaning
lights up blue (when placed into base station)	Charging mode
flashes blue slowly	Active link to base station
flashes red	Rechargeable battery is almost flat
if off	Standby mode Headset is switched off
flashes blue/red	Setting mode/GAP pairing mode Pairing of an additional headset to the base station

Putting the headset system into operation

Putting the base station into operation

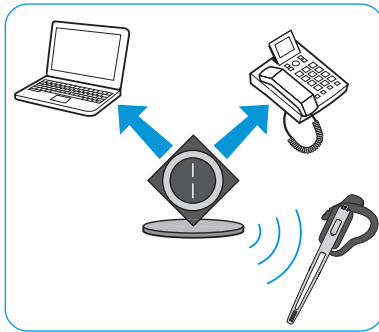

You can use the headset system with your fixed line phone (**Phone mode**) and/or your PC (**PC mode**). The base station controls the wireless communication between the products.

Removing/attaching the cover

To remove the cover:

- ▶ Remove the cover **14** by inserting a finger into the recess as shown.

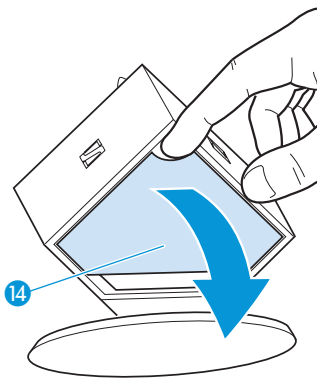

To attach the cover and to secure the connected cables:

- ▶ Replace the cover **14** to the rear of the base station (see diagram).
- ▶ Tilt the cover **14** upwards until it locks into place.

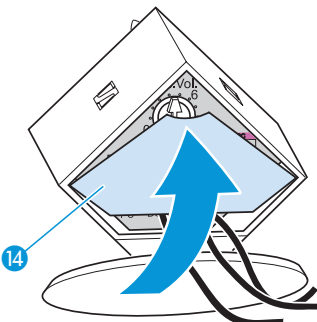
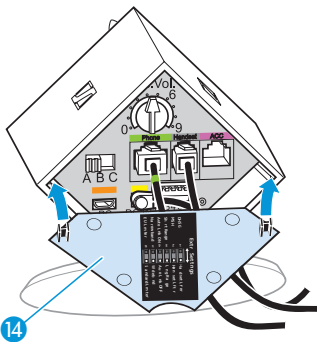

Connecting the base station to the mains

i The base station is ready for operation as soon as it is connected to the mains.

▶ Connect the DC IN connector **16** of the mains unit to the DC IN socket **12**.

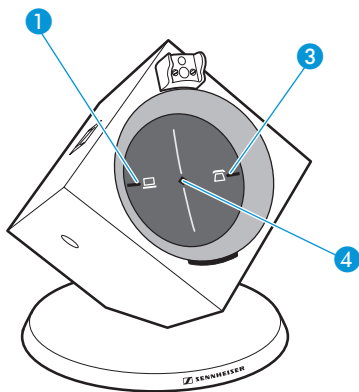
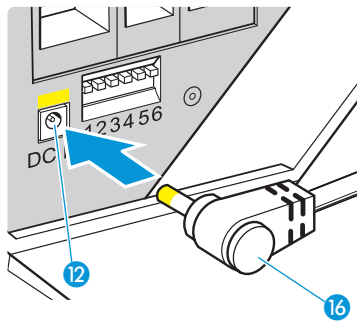

▶ Plug the mains unit **15** into a wall socket. The LINK LED **4** lights up red. The LED of the last used mode button (PHONE **3** or PC **1**) lights up white.

i When using the headset system only in PC mode, the power from the PC via the USB cable is sufficient to power the base station. All other modes require the mains unit.

Connecting the base station to a fixed line phone

If your telephone features a headset socket for connecting the electronic call control, please use this socket.

To connect the base station to a fixed line telephone, choose one of the follow options:

Possibility	Connection
A	to a fixed line phone without headset socket
B	to a fixed line phone with headset socket
C	of an optional mechanical handset lifter (with connection possibilities A and B only)
D	to an optional electronic hook switch control (EHS)

▶ Choose your connection possibility and proceed as described under **A**, **B**, **C** or **D** on the following pages.

i For additional information on the individual settings for the headset system via the DIP switch row **11**, refer to page 20.

A Connection to a fixed line phone without headset socket

- ▶ Disconnect the handset cable from the telephone.
- ▶ Connect the handset cable to the **Handset** socket **9**.
- ▶ Use the telephone cable **17** to connect the **Phone** socket **8** to the handset socket on the telephone.

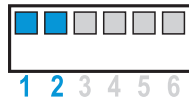
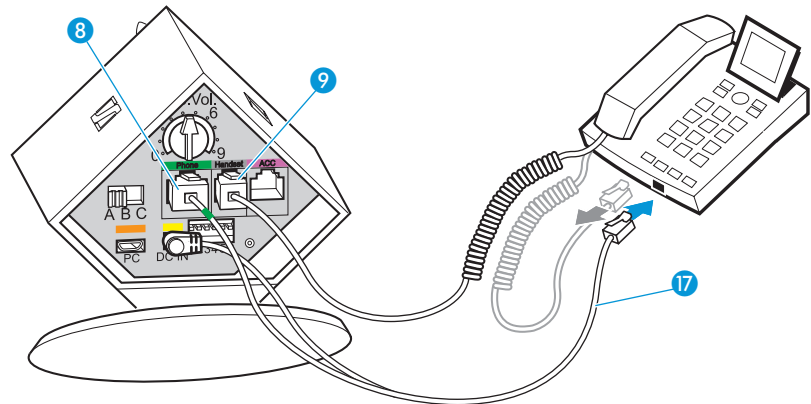

- ▶ Set the DIP switch **11** #1 and #2 to the upper position.

B Connection to a fixed line phone with headset socket

- ▶ Use the telephone cable **17** to connect the **Phone** socket **8** to the headset socket on the telephone.

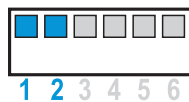
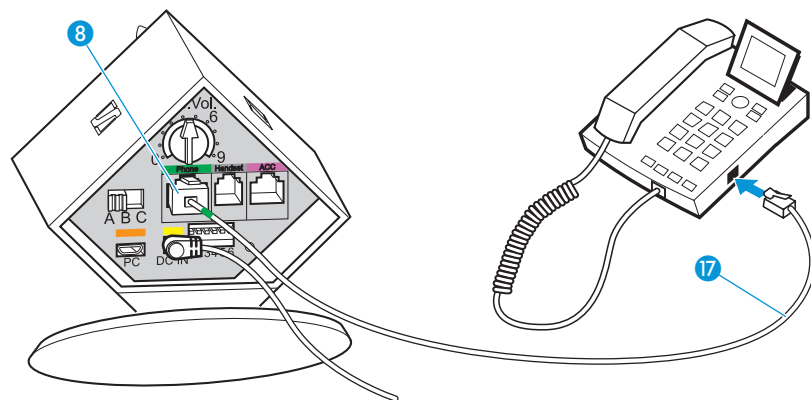

- ▶ Set the DIP switch **11** # 1 and # 2 to the upper position.

C Connection of an optional mechanical handset lifter (with connection possibilities **A** and **B** only)

You can also connect the HSL 10 mechanical handset lifter from Sennheiser Communications (see "Accessories and spare parts" on page 36):

- ▶ Connect the base station to the fixed line phone as described under **A** or **B**.
- ▶ Connect the handset lifter to the ACC socket **10** on the base station.

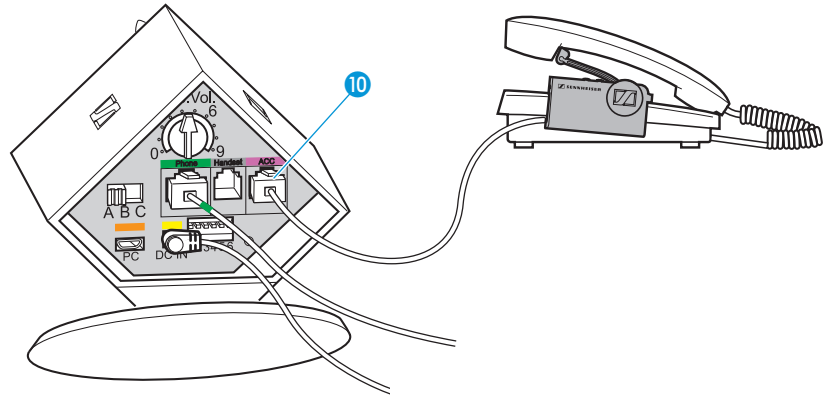

- ▶ Connect the handset lifter to the fixed line phone as described in the instruction manual of the handset lifter.

D Connection to an optional electronic hook switch control (EHS)

If your telephone has a built-in electronic hook switch, supporting either the DHSG or the MSH standard, you require the corresponding connection cables. Other hook switch standards require suitable adapter cables which convert the control signals to the DHSG standard. Both the connections cables and the adapter cables are available as accessories (see "Accessories and spare parts" on page 36).

DHSG standard

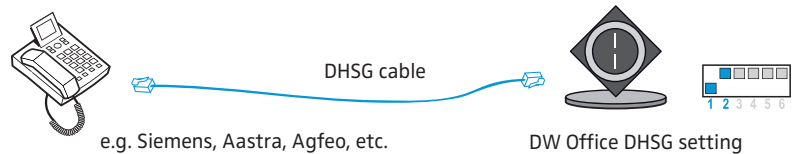

Other standards

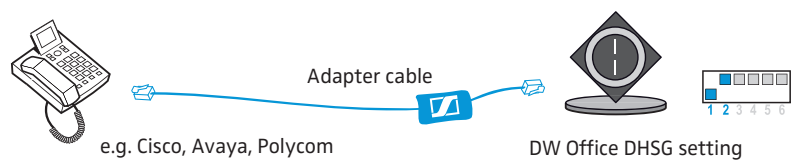

If your telephone has a built-in electronic hook switch supporting the DHSG or the any other hook switch standard (except for the MSH standard):

- ▶ Set the DIP switch **11** # 1 to the lower position.
- ▶ Set the DIP switch **11** # 2 to the upper position.

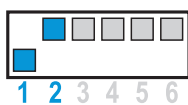

MSH standard

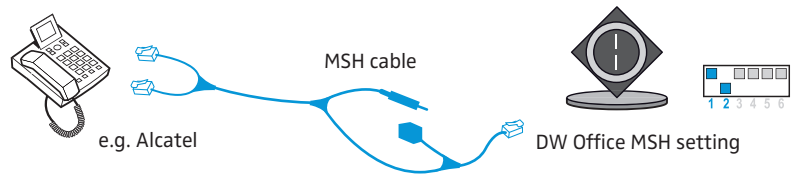

If your telephone has a built-in electronic hook switch supporting the MSH standard:

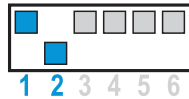

- ▶ Set the DIP switch 11 # 1 to the upper position.
- ▶ Set the DIP switch 11 # 2 to the lower position.

The necessary connection and adapter cables are available from your Sennheiser partner. For additional information, please visit our website at www.sennheisercommunications.com/headsetselector.

Setting up the base station

- ▶ Place the base station at a minimum distance of 15 to 20 cm from the fixed line phone.

Connecting the base station to a PC

You can connect the headset system to a PC in order to use it for Internet telephone (VoIP) with softphones or multimedia applications.

- ▶ Use the USB cable 18 to connect the PC socket 13 to a USB socket of your PC.
The operating system detects the USB audio device "Sennheiser DECT" and installs the necessary drivers.

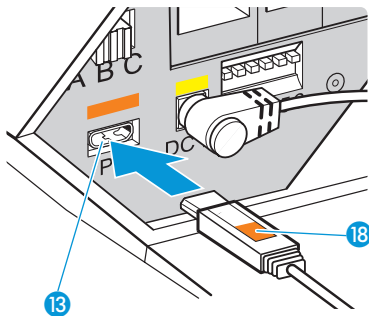



Installing the HeadSetup software

The **HeadSetup** software enables the headset system to communicate with a wide variety of softphones and allows you to use the call control functions.

For updates and additional information on the **HeadSetup** software, please visit our website at www.sennheiser.com/headsetup.

Specifications of the version 1.0

File size	approx. 16 MB
Supported operating systems	Microsoft Windows 2000 Microsoft Windows XP Microsoft Windows Vista Microsoft Windows 7
Supported softphones	Cisco IP Communicator Version 2.0 - 2.1 Avaya IP Softphone 4.0x - 5.0x - 6.0x Skype AOL Instant Messenger

To install the **HeadSetup** software:

- ▶ Run the "Setup.exe" file in the "HeadSetup" folder on the CD ROM and follow the instructions of the install program.

Additional information can be found in the Help section of the software:

- ▶ Click the "Help ..." button.

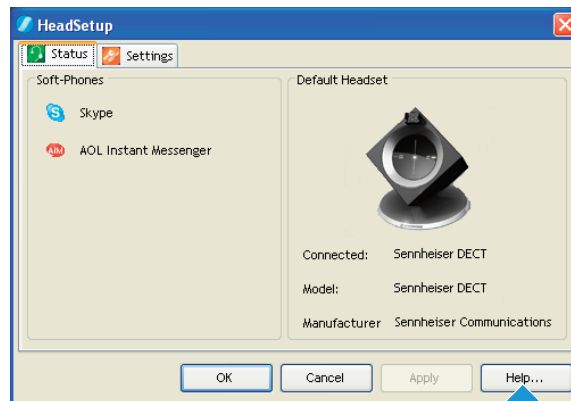

Putting the headset into operation

The headset comes with earhooks in different sizes and a headband with ear pad and can be worn on the left or right ear.

i Before using the headset for the first time, charge the rechargeable battery for at least 20 minutes (see page 22).

Attaching the earhook

- ▶ Select a suitable earhook ⑥.
- ▶ Insert the earhook ⑥ into the earhook slot ⑧.

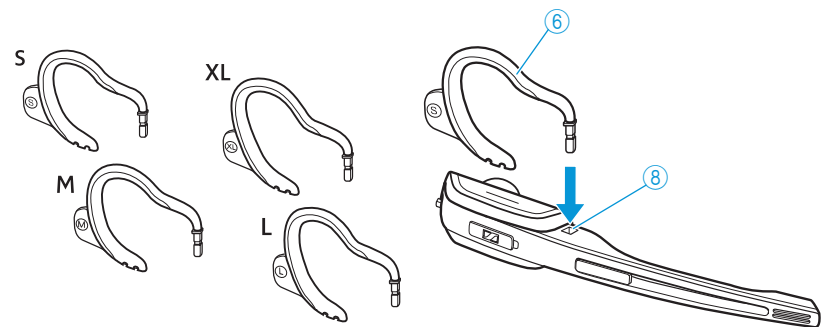

Attaching the headband

- ▶ Replace the name plate with cheek spacer ② with the name plate ⑪.
- ▶ Attach the headset to the headset holder ⑮ of the headband.

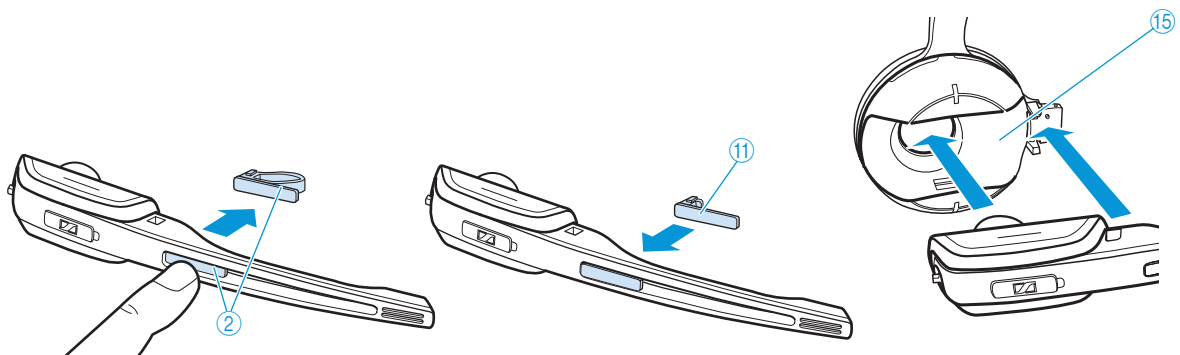

Identifying the headset

The name plate ② or ⑪ allows you to clearly identify the headset.

- ▶ Change the lettering of the name plate.

i The "Name" program included on the CD enables you to create and print individual name plates.

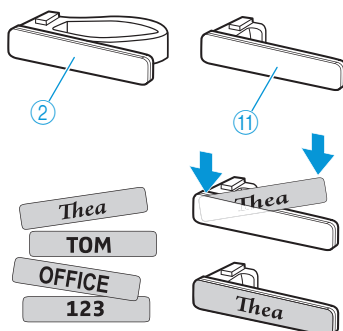

Swapping the assignment of the AUDIO button ⑤

The assignment of the AUDIO button ⑤ can be swapped depending on whether you wear the headset on the right or left ear. By default, the headset is configured for wearing on the right ear. Pushing the AUDIO button ⑤ upwards increases the volume, pushing it downwards reduces the volume (see page 28).

To swap the assignment of the AUDIO button ⑤:

- ▶ Simultaneously press and hold the headset's LINK button ④ and AUDIO button ⑤ for 5 seconds.
The HEADSET LED ③ flashes blue/red.
- ▶ Push the AUDIO button ⑤ in the direction in which you want to increase the volume until the HEADSET LED ③ goes off.
The headset switches to standby mode.

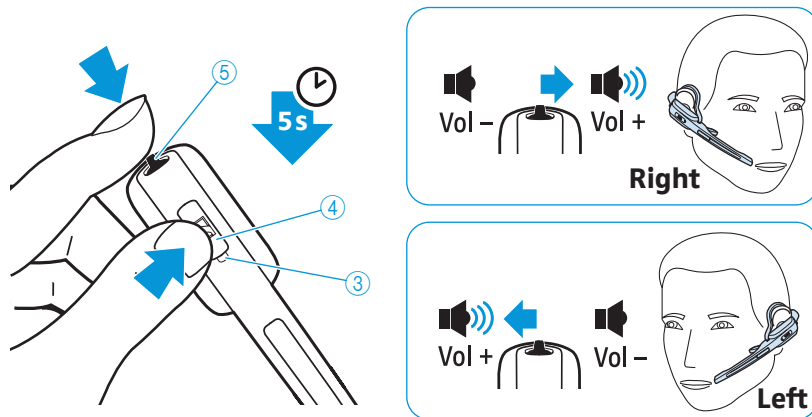

Testing the headset system in Phone mode and adjusting it

Testing the telephone connection

When PC mode is selected (the LED of the PC button ① lights up white):

- ▶ Press the PHONE button ③ on the base station.
The base station is set to Phone mode and the LED of the PHONE button ③ lights up white.
- ▶ Press either the LINK button ④ on the headset or the PHONE button ③ on the base station.
A wireless link is established between the headset and the base station, the LINK LED ④ lights up blue and the HEADSET LED ③ flashes blue.

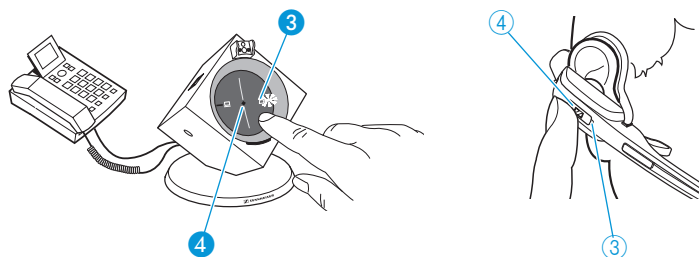

- ▶ Lift the handset (If a handset lifter is connected, it automatically lifts the handset).
The system is correctly connected if you can hear a clear dial tone and if the other party can hear you at a comfortable level. If the audio signal/dial tone is disturbed, adjust the audio signal (see next section). If the other party cannot hear you well, adjust the microphone sensitivity (see below).

Adjusting the audio signal

- ▶ Set the ABC switch to A (default setting), B or C so that you can hear a clear signal (e.g. a dial tone) in the headset.

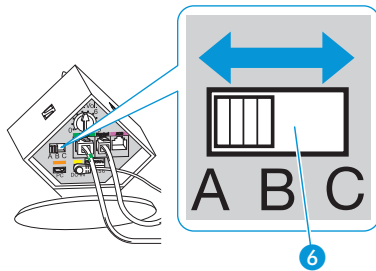

Adjusting the microphone sensitivity

By default, the microphone volume control 7 is set to between position 4 and position 5. This setting is suitable for most telephones and your voice gets reproduced at a good volume. To change the volume, adjust the microphone volume control accordingly.

i The microphone volume control 7 only adjusts the microphone sensitivity in Phone mode. The volume of the headset earpiece 10 is not adjusted (see also page 28).



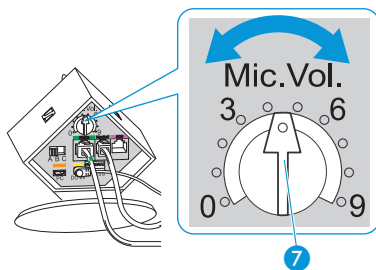



- ▶ Make a call to someone who will help you find the correct sensitivity setting for your microphone (see page 24).
- ▶ Turn the microphone volume control 7 so that the other party can hear at a comfortable level.



Testing the headset system in PC mode and adjusting it

Testing the PC connection

When **Phone** mode is selected (the LED of the PHONE button  3 lights up white):

- ▶ Press the PC button  1 on the base station.
The base station is set to **PC** mode and the LED of the PC button  1 lights up white.
- ▶ Press either the LINK button  4 on the headset or the PC button  1 on the base station.
A wireless link is established between the headset and the base station, the LINK LED  4 lights up blue and the HEADSET LED  3 flashes blue.

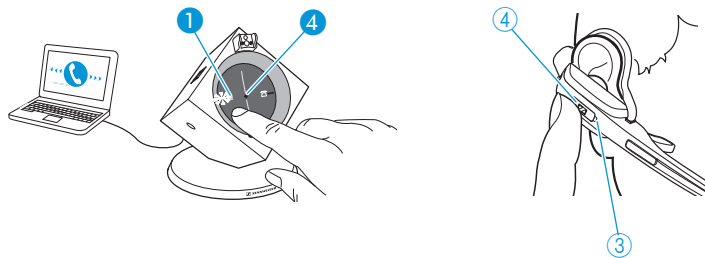

- ▶ Make a call to someone who will help you adjust the correct microphone sensitivity for **PC** mode (see below).
The system is correctly connected if the other party can hear you at a comfortable level.

Adjusting the microphone sensitivity

- ▶ Depending on the operating system used, adjust the microphone sensitivity so that the other party can hear you at a comfortable level (see the instruction manual of your operating system).



Some softphones provide automatic adjustment of the microphone sensitivity. If possible, activate this function in order to be able to use the headset microphone to the full.

Adjusting advanced settings

The DIP switch row 11 allows you to adjust the headset system to your individual needs. By default, all DIP switches are set to the upper position.

To change the settings of the DIP switch row 11:

- ▶ If necessary, disconnect an existing wireless link between base station and headset (see page 23).

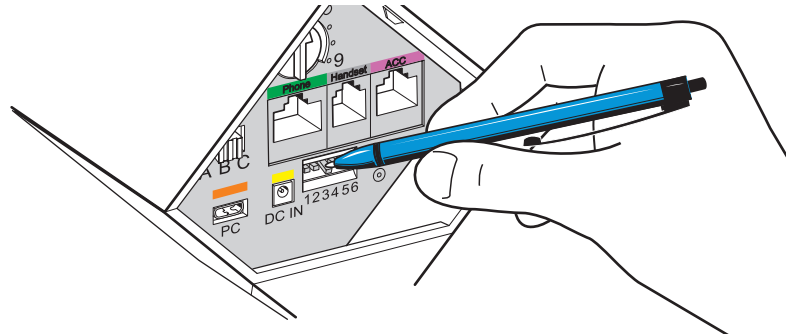

- ▶ Use a pointed object (e.g. a pen) to set the DIP switches to the desired position.

Configuring the handset lifter/hook switch – DIP switch 1 and 2

Switch position	Function
	Manual operation Lifts/hangs up the handset manually or using the handset lifter.
	Electronic hook switch (DHSG standard) Call control via the DW Office headset system.
	Electronic hook switch (MSH standard) Call control via the DW Office headset system.
	Manual operation Lifts/hangs up the handset manually or using the handset lifter.

Adjusting the radio range – DIP switch 3

If many DECT systems are operated in a confined space, interference can occur. In this case, you should change the radio range.

Switch position	Function
	Standard radio range
	Reduced radio range Use this setting in order to avoid interference with other DECT systems.

Automatically establishing the wireless link between headset and base station – DIP switch 4

Switch position	Function
<p>1 2 3 4 5 6</p>	<p>Switched off</p> <p>You have to manually establish the wireless link (see page 23).</p>
<p>1 2 3 4 5 6</p>	<p>Switched on</p> <p>When taking the headset out of the base station, a wireless link is automatically established between headset and base station.</p>

Switching between wideband and narrowband mode – DIP switch 5

Switch position	Function
<p>1 2 3 4 5 6</p>	<p>Wideband mode</p> <p>Automatic frequency adjustment of wideband and narrowband calls in PC and Phone mode.</p> <p>Battery life: 8 hours</p>
<p>1 2 3 4 5 6</p>	<p>Narrowband mode</p> <p>Narrowband audio transmission in PC and Phone mode.</p> <p>Battery life: 12 hours</p>

Limiting the volume – DIP switch 6

Switch position	Function
<p>1 2 3 4 5 6</p>	<p>Standard limitation</p>
<p>1 2 3 4 5 6</p>	<p>Limited volume (country specific)</p> <ul style="list-style-type: none"> • AU version: in compliance with Directive AS/ACIF S004:2008 • EU and US version: in compliance with Directive 2003/10/EC

Using the headset system

Charging the headset rechargeable battery

If you charge the rechargeable battery for the first time, allow charging for at least 20 minutes without interruption. A complete charging process takes about 60 minutes. You can interrupt charging at any time without damaging the rechargeable battery.

Operating time with a fully charged rechargeable battery:

Talk time/standby time	Mode
12 hours	narrowband mode (see page 21)
8 hours	wideband mode (see page 21)
4 days	standby mode

To charge the headset rechargeable battery:

- ▶ Place the headset into the magnetic holder of the base station. The HEADSET LED ③ lights up blue and the CHARGE STATUS LED ⑤ indicates the battery charge:

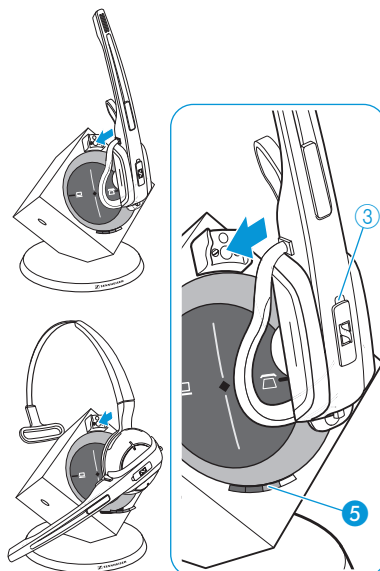

LED segment*	Battery charge	Required charging time	
1	0-25%	approx. 10 min	} total: approx. 60 min
2	25-50%	approx. 10 min	
3	50-75%	approx. 20 min	
4	75-100%	approx. 20 min	

* during charging, each segment gets brighter in 5 steps

To stop the charging process:

- ▶ Take the headset out of the base station. The CHARGE STATUS LED ⑤ indicates the remaining battery charge of the headset.

When the battery is about to run flat ...

... only the LED segment 1 lights up weakly or flashes (see page 9).

... the HEADSET LED ③ flashes red.

... you hear a low battery warning (three beeps) in the headset.

... you have several minutes of battery reserve.

When the battery is flat, the headset switches off.



If the headset is outside the range of the base station, it will switch off after 30 minutes in order to conserve battery power.

Switching the headset on/off



If you place the headset into the base station, the headset automatically switches to standby mode. In standby mode, the power consumption is very low and the radiated power is reduced to a minimum. The HEADSET LED ③ lights up blue and the rechargeable battery is being charged.

Switching the headset on

- ▶ Press and hold the LINK button ④ for 5 seconds. The HEADSET LED ③ flashes blue 3 times and the wireless link to the base station is established (where required). An ascending confirmation beep is heard in the headset.

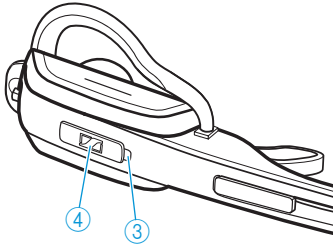

Switching the headset off

- ▶ Press and hold the LINK button ④ for 5 seconds. The HEADSET LED ③ flashes red 3 times.

Establishing a wireless link between headset and base station

To establish a wireless link between headset and base station:

- ▶ Press the LINK button ④ on the headset. The link is established. The LINK LED ④ lights up blue and the HEADSET LED ③ flashes blue.

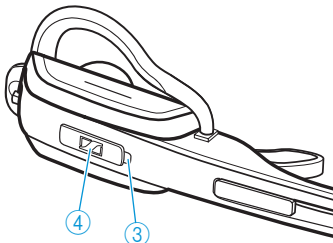

To disconnect a wireless link between headset and base station:

- ▶ Press the LINK button ④ on the headset. The link is disconnected. The LINK LED ④ and the HEADSET LED ③ go off.

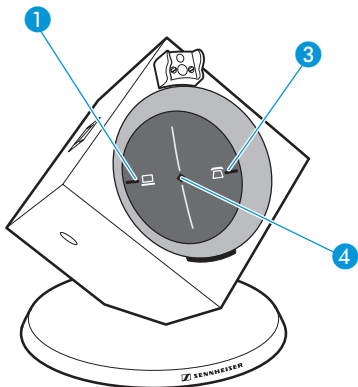

You can also establish or disconnect the wireless link by pressing the PC button ① or the PHONE button ③ on the base station (depending on the selected mode (PC or Phone), see page 28).



If your telephone has a built-in electronic hook switch supporting the MSH standard (see page 13), you can only disconnect the wireless link between headset and base station by placing the headset into the base station. The control signals (“accept a call”, “end a call”) of the headset are still transmitted to the electronic hook switch without.

Putting the headset on and adjusting it

Wearing the headset with the earhook

- ▶ Slightly pull the earhook ⑥ away from the headset.
- ▶ Place the earhook behind your ear so that it follows the contour of your ear.
- ▶ Adjust the headset so that a comfortable and secure fit is ensured.

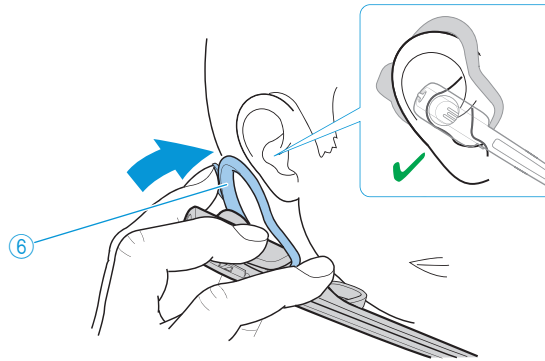

Wearing the headset with the headband

- ▶ Adjust the headband ⑫ to your head.
- ▶ Put on the headset so that the ear pad ⑭ rests comfortably on your ear and that the headband ⑫ runs over the top of your head.
- ▶ Orient the microphone towards your mouth.

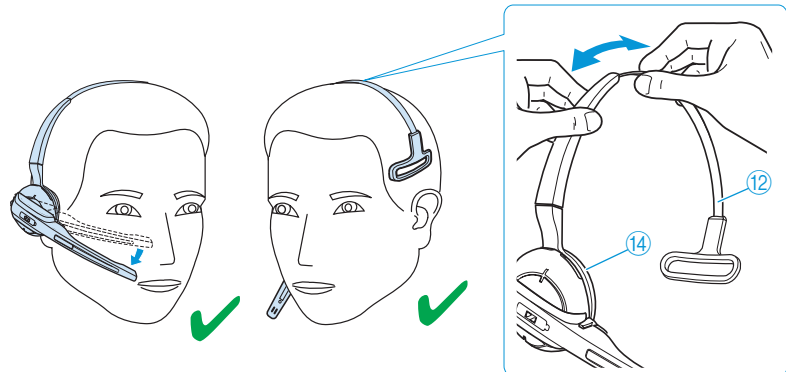

Calling via the fixed line phone using the headset

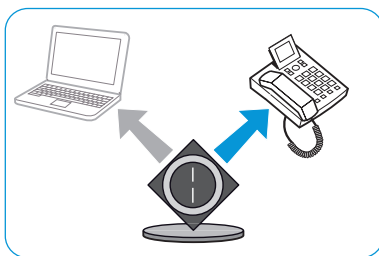



Accepting an incoming call

You hear the ring tone of the fixed line phone:

- ▶ Put on the headset and establish a wireless link between headset and base station (see page 23).

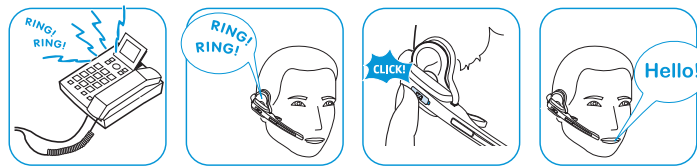
If a handset lifter/electronic hook switch is used, the call is automatically accepted.



If you receive a call and a handset lifter/electronic hook switch with ring tone detection is used, you hear a ring tone in the headset and the LED of the PHONE button  3 flashes white.

If **no** handset lifter/electronic hook switch is used:

- ▶ Accept the call by lifting the handset or by pressing the “accept call” button on your fixed line phone.

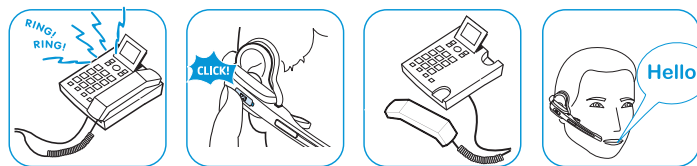

Making a call

If a handset lifter/electronic hook switch is used:

- ▶ Dial the desired number.
- ▶ Put on the headset and establish a wireless link between headset and base station (see page 23). The phone connection is established automatically.

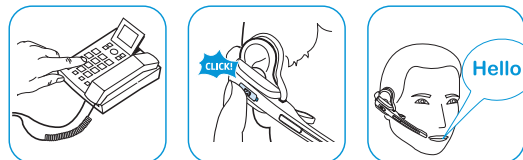

If **no** handset lifter/electronic hook switch is used:

- ▶ Put the headset on and establish a wireless link between headset and base station (see page 23).
- ▶ Lift the handset and dial the desired number. The phone connection is established.



Ending a call

- ▶ Disconnect the wireless link between headset and base station (see page 23).
If a handset lifter/electronic hook switch is used, the call is automatically ended.

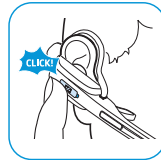

If **no** handset lifter/electronic hook switch is used:

- ▶ Hang up the handset or press the "end call" button on your fixed line phone.

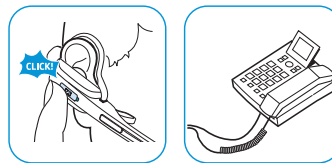

Transferring a call from the headset to the fixed line phone and vice versa

This function is only available if no handset lifter/electronic hook switch is used or if your fixed line phone supports this function.

If a wireless link is established (see page 23):

- ▶ Speak into the headset.

If no wireless link is established (see page 23):

- ▶ Speak into the headset.

Calling via the PC using the headset

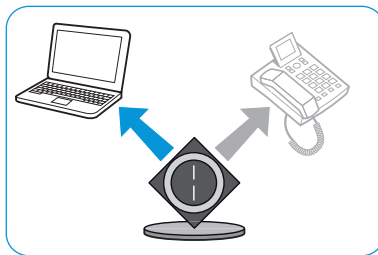

Accepting an incoming PC call

If you receive a call on your softphone:

- ▶ Establish a wireless link between headset and base station (see page 23).
- ▶ Accept the call using your softphone. If the call control function of your softphone is supported, the call is automatically accepted (see page 15).

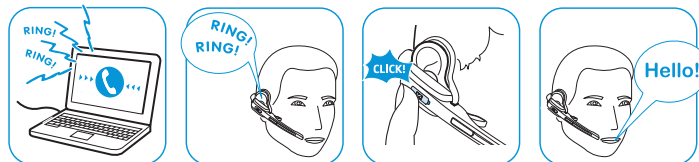

i If you receive a call and if the call control function of your softphone is supported by the **HeadSetup** software (see page 15), you hear a ring tone in the headset and the LED of the PC button  **1** flashed white.

Making a PC call

- ▶ Establish a wireless link between headset and base station (see page 23).
- ▶ Make the call using your softphone.



Ending a PC call

- ▶ Disconnect the wireless link between headset and base station (see page 23).
- ▶ End the call using your softphone. If the call control function of your softphone is supported, the call is automatically ended (see page 15).

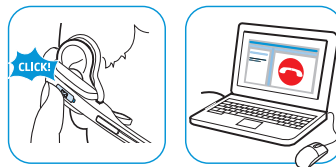

Reproducing PC audio via the headset

The **HeadSetup** software allows you to listen to all PC audio via the headset.

To activate/deactivate the reproduction of PC audio via the headset:

- ▶ In the **HeadSetup** software, activate/deactivate the “Always Audio” function by clicking the corresponding button. All PC audio is permanently reproduced via the headset. The wireless link between headset and base station remains permanently established.

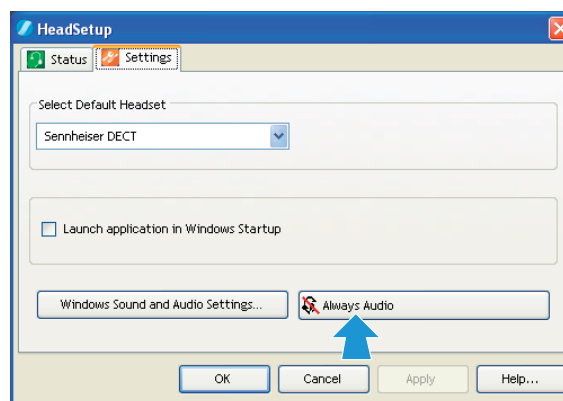



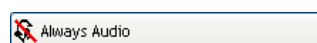

If the “Always Audio” function is deactivated, the icon on the button is crossed out in red.



If the “Always Audio” function is activated, you can still accept calls via the **Phone** mode. After ending the call, the base station automatically switches back to **PC** mode and all PC audio is reproduced via the headset.

Switching between Phone and PC mode

You can switch between **Phone** and **PC** mode and accept calls of the other mode.

- ▶ Press the PC button  ① or the PHONE button  ③ on the base station to select the desired mode.
The LED of the PC button  ① or the LED of the PHONE button  ③ lights up white, indicating the selected mode.

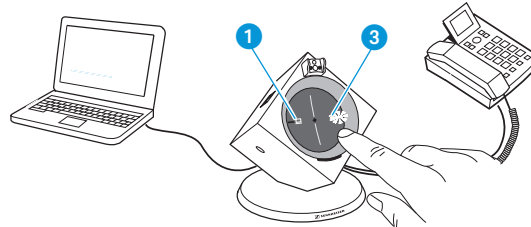

Adjusting the volume

WARNING Hearing damage due to high volumes!



Listening at high volume levels for long periods can lead to permanent hearing defects.

- ▶ Set the volume to a medium level.
- ▶ Do not continuously expose yourself to high volumes.

In order to be able to adjust the volume of the ring tone and the acoustic signals, the headset has to be in standby mode. In order to be able to adjust the audio volume, a wireless link has to be established between headset and base station (see page 23).

- i** In **PC** mode, you can adjust the volume using the AUDIO button ⑤ or by using the volume control of your operating system (see the instruction manual of your operating system).

The volumes can be adjusted in several steps. When the minimum or maximum volume is reached, you hear a double beep in the headset.

- ▶ To increase or reduce the volume step-by-step, push the AUDIO button ⑤ upwards or downwards.

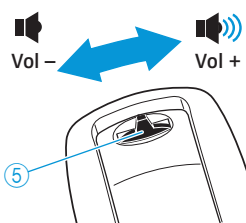

- i** The assignment of the AUDIO button ⑤ can be swapped depending on whether you wear the headset on the right or left ear (see "Swapping the assignment of the AUDIO button ⑤" on page 17).

Muting the headset's microphone

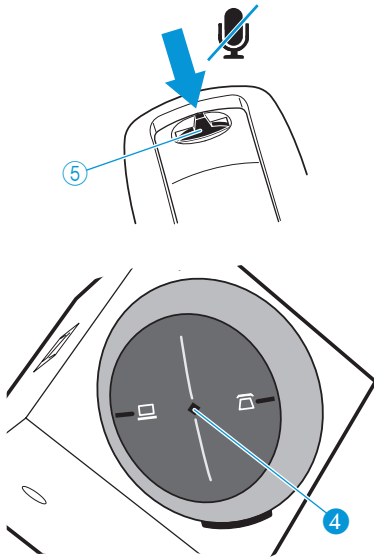

To mute the headset's microphone **during** a call (the LINK LED 4 on the base station lights up blue):

- ▶ Press the AUDIO button 5.
The microphone is muted. While the microphone is muted, you hear a beep in the headset every 5 seconds and the LINK LED 4 on the base station flashes red.

To unmute the headset's microphone:

- ▶ Press the AUDIO button 5 again.
You hear a low confirmation beep in the headset.
- or
- ▶ Disconnect the wireless link between headset and base station (see page 23).
In both cases, the muting is canceled and the LINK LED 4 lights up blue again.

Using the advanced functions

Pairing additional headsets for shared use

You can use one DW Office base station with different DW Office headsets. This can be advantageous if you share a telephone workplace. The last headset paired to the base station can be used without more ado.

If **no** wireless link is established between headset and base station:

- ▶ Place the additional headset into the magnetic holder of the base station.
During pairing of the headset to the base station, the HEADSET LED 3 flashes blue/red. If pairing was successful, the HEADSET LED 3 lights up blue. You can now use the newly paired headset.

Holding a conference call

The headset system allows you to hold a conference call with up to 4 headsets. The master headset is used to control the conference call and up to 3 additional guest headsets can participate in the conference call.

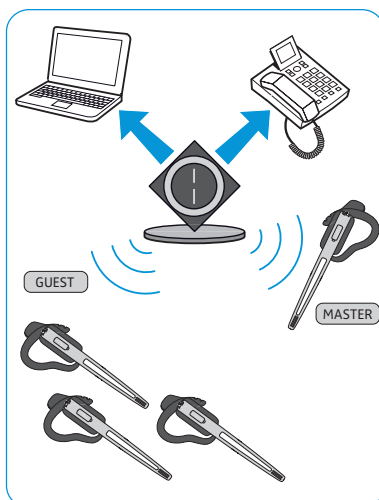

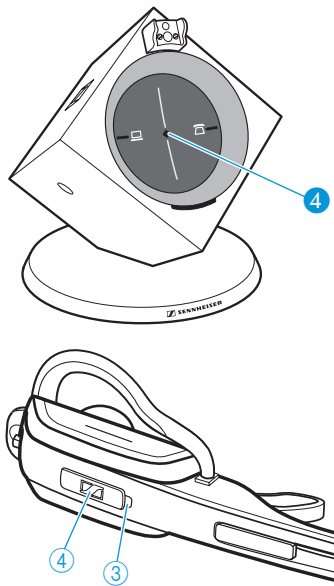

To start the conference call using the master headset:

- ▶ Establish a wireless link between headset and base station (the LINK LED 4 flashes blue).

To add a guest headset to the conference call:

- ▶ Place the guest headset to be added to the conference call into the base station of the master headset. The HEADSET LED 3 flashes blue/red and the headset pairs to the base station. If pairing was successful, the HEADSET LED 3 lights up blue.
- ▶ Take the guest headset out of the base station. You hear a beep in the master headset.
- ▶ Press the LINK button 4 on the master headset within 15 seconds. The guest headset is enabled for the conference call.
- ▶ If necessary, repeat this procedure for the two other guest headsets.
- ▶ Call the other party.

To exit the conference call with a guest headset:

- ▶ Press the LINK button 4 on the guest headset.

To end the conference call:

- ▶ Use the master headset to end the conference call. The wireless links to all other headsets participating in the conference call are disconnected.

i You can only end the conference call using the master headset. Other functions such as volume adjustment and muting the headset's microphone can still be performed on each headset.

Pairing the headset to third party DECT GAP telephones

i The DW Office base station can only be used with DW Office headsets.

- ▶ Place the DW Office headset at a maximum distance of 1 m from the non-DW Office base station.
- ▶ Simultaneously press and hold the headset's LINK button 4 and AUDIO button 5 for 5 seconds. The headset switches to setting mode/GAP pairing mode and the HEADSET LED 3 flashes blue/red.
- ▶ Set the non-DW Office base station to GAP pairing mode (see the instruction manual of the non-DW Office base station). The headset pairs to the non-DW Office base station. If pairing was successful, the HEADSET LED 3 goes off.

i The standard code for DW Office is "0000".

Pairing is not successful

If pairing is not successful within 60 seconds, the DW Office headset switches to standby mode.

- ▶ For information on how to pair the headset to the non-DW Office base station, refer to the instruction manual of the base station.

Charging an additional headset

If you wish to charge an additional headset (headset **b**) in the base station while you are using your headset (headset **a**):

- ▶ Make sure that a wireless link is established between headset **a** and base station (the LINK LED ④ on the base station lights up blue).
- ▶ Place headset **b** into the base station.
Headset **a** can continue to connect to and disconnect from the base station and its use is not restricted while headset **b** is being charged.

If you leave the DECT range

If you leave the DECT range during a call, the audio quality deteriorates. When the link breaks down completely, you hear a descending sequence of beeps in the headset and the LINK LED ④ on the base station lights up red.

To resume the call:

- ▶ Re-enter the DECT range of the headset system within 60 seconds.
As soon as the headset re-establishes the wireless link to the base station, you hear a ring tone in the headset.
- ▶ Press the LINK button  ④ on the headset to resume the call.



If a handset lifter/electronic hook switch is used or if your soft-phone supports call control, the call will automatically be ended 60 seconds after leaving the DECT range.

Cleaning and maintaining the headset system

CAUTION Damage to the product due to liquids!

Liquids entering the product can short-circuit the electronics or damage the mechanics.

Solvents or cleansing agents can damage the surface of the product.

- ▶ Keep all liquids far away from the product.
 - ▶ Do not use any solvents or cleansing agents.
-

- ▶ Before cleaning, switch the product off and disconnect the base station from the mains.
- ▶ Only use a dry and soft cloth to clean the product.
- ▶ Clean the charging contacts ② of the base station and the charging contacts ⑧ or ⑬ of the headset from time to time using e.g. a cotton swab.

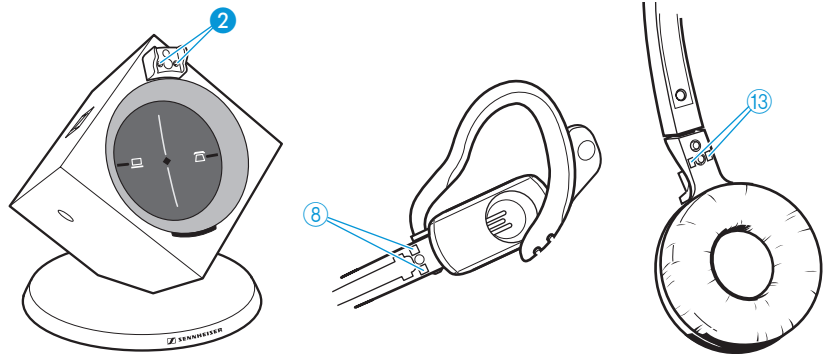

Replacing the ear pad of the headband

You can replace the ear pad. Spare ear pads are available from your Sennheiser partner.

- ▶ Remove the old ear pad ⑭.
- ▶ Attach the new ear pad by placing the fastening tab **B** of the ear pad over the notch **A** of the headband (see diagram).
- ▶ Turn the ear pad counter-clockwise.
The notch **A** guides the fastening tab **B** so that the ear pad is securely attached to the headband.

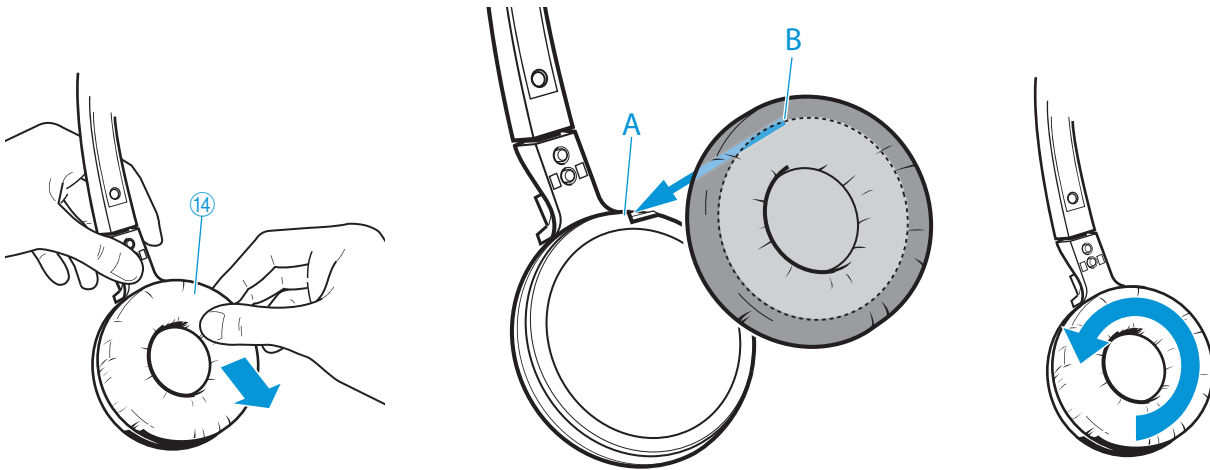

Replacing the headset's rechargeable battery

You can replace the rechargeable battery. Spare rechargeable batteries are available from your Sennheiser partner. Only use spare rechargeable batteries recommended by Sennheiser Communications.

CAUTION Damage to the product due to improper handling

The cable connections can be damaged when subjected to mechanical stress.

- ▶ Open the battery compartment cover ⑨ carefully loosen the connector plug of the rechargeable battery.

- ▶ Remove the earhook or the headband.
- ▶ Open the battery compartment cover ⑨ using your finger nail (see first diagram).
- ▶ Carefully move the battery compartment cover ⑨ in the direction of the arrow until you overcome a slight resistance.
- ▶ Remove the rechargeable battery and carefully loosen the connector plug of the battery cable.
- ▶ Insert the connector plug of the new rechargeable battery into the connection socket. Observe correct orientation of the connector plug.
- ▶ Replace the battery compartment cover ⑨ onto the headset.
- ▶ Carefully lift the headset housing with your finger nail while fixing the battery compartment cover ⑨ with your thumb. The battery compartment cover ⑨ locks into place (see last diagram).

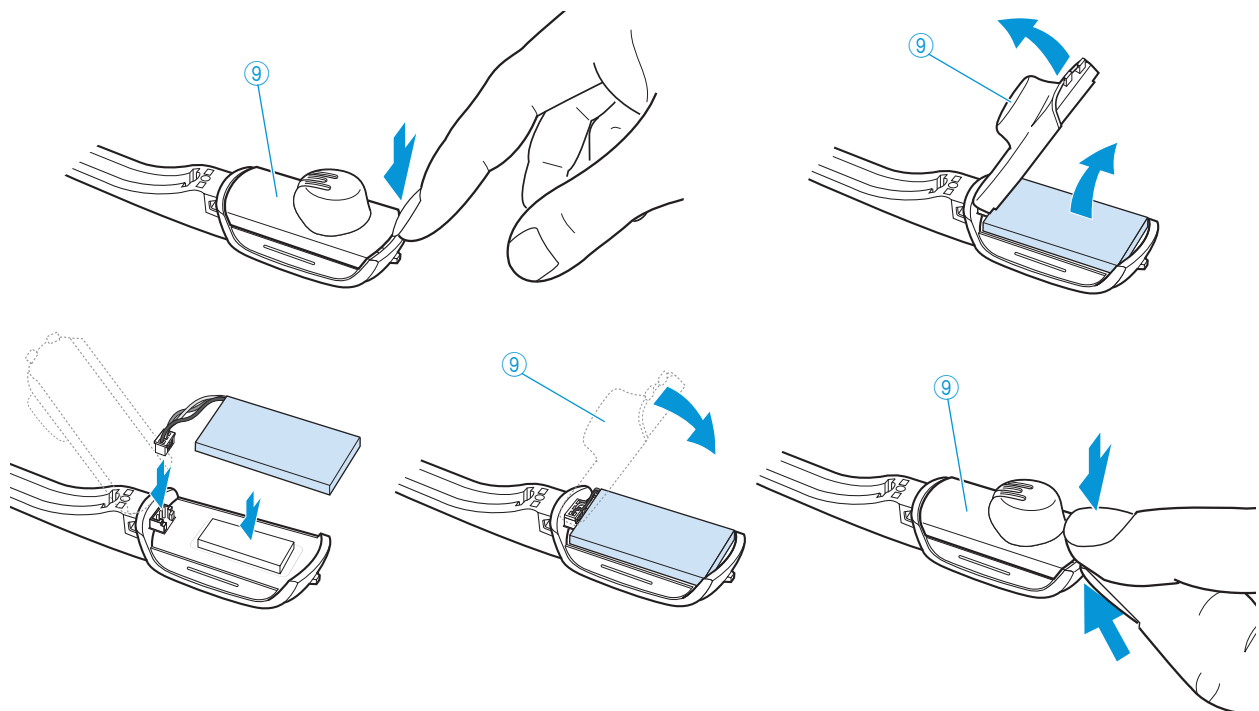

- ▶ Charge the new rechargeable battery (see "Charging the headset rechargeable battery" on page 22).

If a problem occurs

Problem	Possible cause	Possible solution
The headset is placed into the base station but does not show any reaction	Base station is not connected to the mains	Connect the base station to the mains (see page 11).
	Rechargeable battery is deep discharged	Wait several minutes until the charging process starts.
Link between headset and base station cannot be established (Phone mode)	Base station is not connected to the mains	Connect the base station to the mains (see page 11).
	Headset is not paired to the base station	Pair your headset to the base station (see page 29).
Link between headset and base station cannot be established (PC mode)	Base station is only connected to the mains	Connect the base station to the PC using the USB cable.
	Headset is not paired to the base station	Pair your headset to the base station (see page 29).
Bad radio link between headset and base station	Transmission range is exceeded	Reduce the distance between headset and base station.
		Adjust the radio range (see page 20).
The headset causes noise and connection losses	Microphone rubs on the cheek or perhaps the beard	Use the name plate with cheek spacer ②.
	Distance between base station and fixed line phone is so small that interference occurs	Increase the distance between base station and fixed line phone (see page 14).
	Too many DECT systems within the radio range	Reduce the radio range (see page 20).
Set the base station to narrowband mode (see page 21).		
The rechargeable battery cannot be charged	Charging contacts of the headset or the base station are dirty	Clean the charging contacts on the headset and on the base station (see page 32).
	Rechargeable battery is defective	Replace the defective rechargeable battery by a new rechargeable battery (see page 34).
	Charging contacts of the headset ⑧ and the headband do not make good contact	Check if the headset is properly attached to the headset holder of the headband ⑭ (see page 16).
The rechargeable battery is quickly depleted even after charging	Overaged rechargeable battery	Replace the overaged rechargeable battery by a new rechargeable battery (see page 34).
The sound from the fixed line phone is distorted and disturbed	Base station is not adjusted to the fixed line phone	Adjust the base station to your fixed line phone (see page 18).
The other party cannot hear me properly, my voice sounds too low or too loud	Microphone sensitivity is not correctly adjusted	Adjust the microphone sensitivity to the Phone mode (see page 18) or the PC mode (see page 19).
Your headset is no longer paired to the base station if an additional headset has been used with the base station	You can only use the last headset paired to the base station (exception: conference call)	Replace your headset into the base station (see page 29).

For additional information and an FAQ list, please visit our website at www.sennheiser.com/DW

If a problem occurs that is not listed in the above table or if the problem cannot be solved with the proposed solutions, please contact your local Sennheiser partner for assistance.

To find a Sennheiser partner in your country, search at www.sennheisercommunications.com under "Service & Support".

Accessories and spare parts

For additional information on accessories and spare parts, please contact your Sennheiser partner or visit our website at www.sennheiser.com

Accessories

- HSL 10 handset lifter
 - mechanical handset lifter
 - incl. ring tone detection
 - supports nearly all standard desktop telephones
- DHSG cable
 - electronic hook switch cable
 - for e.g. Siemens, Aastra, etc.
- MSH cable
 - electronic hook switch cable
 - for e.g. Alcatel, etc.
- Adapter cables for manufacturer specific standards
 - available for Cisco, Avaya, Polycom, etc.

Spare parts

- Handband
- Ear pad for headband
- Set of earhooks (size S, M, L, XL)
- Set of name plates (with and without cheek spacer)
- Rechargeable battery
- Telephone cable
- Micro-USB cable
- Mains unit, EU version
- Mains unit, UK version
- Mains unit, US version
- Mains unit, AU version

Specifications

DW Office base station

Dimensions	108 x 116 x 114 mm (W x H x D)
Weight	approx. 368 g
Operating temperature range	+5°C to +45°C (+41°F to +113°F)
Storage temperature range	-20°C to +70°C (-4°F to +158°F)

DW Office headset

Dimensions	140 x 24 x 22 mm (W x H x D)
Weight	with earhook: approx. 22 g with headband: approx. 50 g
Talk time	narrowband: up to 12 hours wideband: up to 8 hours
Charging time of rechargeable battery	50%: approx. 20 min 100%: approx. 1 hour
Range	environment dependent: <ul style="list-style-type: none"> • up to 180 m outdoors • up to 55 m in office buildings with reduced radio range (see page 20): <ul style="list-style-type: none"> • up to 10 m in office buildings
Speaker type	dynamic, neodymium magnet
Microphone type	electret microphone, noise canceling
Operating temperature range	+5°C to +45°C (+41°F to +113°F)
Storage temperature range	-20°C to +70°C (-4°F to +158°F)

Type approvals (DW Office headset system)

In compliance with

Europe:	EMC	EN 301489-6
	Radio	EN 301406
	Safety	EN 60950-1
	SAR	EN 50360 ref EN 62209-1 (headset)

USA: This product meets the safety requirements of CSA No. 231437

Approved by

Canada:	Industry Canada RSS 213 Issue 2 IC ID: 2099D-TDB1 (base station) IC ID: 2099D-TDH1 (headset)
USA:	 47 CFR Part 15 (d) FCC ID: DMOCDBDIB (base station) FCC ID: DMOCDHDKB (headset)

DW Office mains unit

Nominal input voltage	100 to 240 V~
Nominal input current	max. 0.2 A
Mains frequency	50 to 60 Hz
Nominal output voltage	6 V ===
Nominal output current	max. 850 mA
Operating temperature range	+5°C to +45°C (+41°F to +113°F)
Storage temperature range	-20°C to +70°C (-4°F to +158°F)
Relative humidity	operation: 20 to 85% storage: 20 to 95%
Weight	approx. 75 g

DECT

	EU version: CAT IQ 1.0	US version: DECT 6.0
Transmission frequency	1,880 to 1,900 MHz	1,920 to 1,930 MHz
SAR value	0.196 W/kg (max. 10 g SAR)	0.093 W/kg (max. 1 g SAR)

Manufacturer Declarations

Warranty

Sennheiser Communications A/S gives a warranty of 24 months on this product.

For the current warranty conditions, please visit our web site at www.sennheiser.com or contact your Sennheiser partner.

In compliance with the following requirements

- RoHS Directive (2002/95/EC)
- WEEE Directive (2002/96/EC)



Please dispose of this product at the end of its operational life-time by taking it to your local collection point or recycling center for such equipment.

- Battery Directive (2006/66/EC)



The supplied rechargeable battery can be recycled. Please dispose of it as special waste or return it to your specialist dealer. In order to protect the environment, only dispose of exhausted rechargeable batteries.

CE Conformity

- **CE 1321**
- R&TTE Directive (1999/5/EC)
- EMC Directive (2004/108/EC)
- Low Voltage Directive (2006/95/EC)

The declarations are available at www.sennheiser.com. Before putting the product into operation, please observe the respective country-specific regulations.

Statements regarding FCC and Industry Canada

This equipment complies with Part 15 of the FCC Rules and with RSS-213 of Industry Canada. Operation is subject to the following two conditions: (1) this equipment may not cause harmful interference, and (2) this equipment must accept any interference received, including interference that may cause undesired operation.

This equipment has been tested and found to comply with the limits for a Class B digital device, pursuant to Part 15 of the FCC Rules. These limits are designed to provide reasonable protection against harmful interference in a residential installation. This equipment generates, uses and can radiate radio frequency energy and, if not installed and used in accordance with the instructions, may cause harmful interference to radio communications. However, there is no guarantee that interference will not occur in a particular installation. If this equipment does cause harmful interference to radio or television reception, which can be determined by turning the equipment off and on, the user is encouraged to try to correct the interference by one or more of the following measures:

- Reorient or relocate the receiving antenna.
- Increase the separation between the equipment and receiver.
- Connect the equipment into an outlet on a circuit different from that to which the receiver is connected.
- Consult the dealer or an experienced radio/TV technician for help.

This class B digital equipment complies with the Canadian ICES-003

Changes or modifications made to this equipment not expressly approved by Sennheiser electronic Corp. may void the FCC authorization to operate this equipment. Before putting the equipment into operation, please observe the respective country-specific regulations!

Since the radiated output of this device is far below the FCC radio frequency exposure limits, it is not subjected to routine RF exposure evaluation as per Section 2.1093 of the FCC rules.

Trademarks

Sennheiser is a registered trademark of Sennheiser electronic GmbH & Co. KG.

Other product and company names mentioned in this instruction manual may be the trademarks or registered trademarks of their respective owners.

Index

A

- ABC switch
 - adjusting 18
- ACC
 - connection of an optional mechanical handset lifter 13
- Accessories
 - connection of an optional mechanical handset lifter 13
- Acoustic signals
 - adjusting the volume 28
- Additional headsets
 - pairing for shared use 29
- Advanced functions
 - pairing/using additional headsets 29
 - using 29
- Advanced settings
 - adjusting 20
 - adjusting the radio range 20
 - DIP switch row 20
 - establishing the wireless link automatically 21
 - limiting the volume 21
 - wideband and narrowband mode 21
- Always Audio
 - 27
- Audio signal
 - adjusting 18
- Audio volume
 - adjusting 28
- AUTIO button
 - swapping the assignment 17

B

- Base station
 - connecting to a fixed line phone 11
 - connecting to a fixed line phone with headset socket 12
 - connecting to a fixed line phone without headset socket 12
 - connecting to a PC 14
 - connecting to the mains 11
 - connection of an optional mechanical handset lifter 13
 - connection to an optional electronic hook switch 13
 - putting into operation 10
 - removing/attaching the cover 10
 - setting up 14

Buttons

- base station 8
- headset 8
- overview 8

C

Calling

- accepting an incoming call (fixed line phone) 24
- accepting an incoming PC call 26
- ending a call (fixed line phone) 26
- ending a PC call 27
- making a call (fixed line phone) 25
- making a PC call 27
- transferring a call from the headset to the fixed line phone and vice versa 26
- via the fixed line phone 24
- via the PC 26

calling

- making a call (fixed line phone) 25

D

- DECT 4
 - leaving the DECT range 31
- DECT GAP telephone
 - pairing 30
- DHSG
 - connection of an optional electronic hook switch 13
- Dial tone
 - adjusting 18
- DIP switch 1 and 2
 - configuring the handset lifter/hook switch 20
- DIP switch 3
 - adjusting the radio range 20
- DIP switch 4
 - establishing the wireless link 21
- DIP switch 5
 - switching between wideband and narrowband mode 21
- DIP switch 6
 - limiting the volume 21

E

- Ear pad
 - replacing 33
- Earhook 16

- G**
- GAP telephone
 - pairing 30
- H**
- Headband 16
 - Headset
 - adjusting 24
 - attaching the earhook 16
 - attaching the headband 16
 - charging 22
 - identifying 16
 - pairing to third party DECT GAP telephone 30
 - putting into operation 16
 - putting on 24
 - wearing with earhook 24
 - wearing with headband 24
 - Headset microphone
 - muting 29
 - Headset system
 - testing the headset system in PC mode and adjusting it 19
 - testing the headset system in Phone mode and adjusting it 17
 - HeadSetup software
 - installing 15
 - specifications 15
- L**
- LEDs
 - base station 9
 - headset 9
 - overview 9
- M**
- Microphone sensitivity
 - adjustment for Phone mode 18
 - Microphone volume control
 - setting 18
 - MSH
 - connection of an optional electronic hook switch 13
 - Muting
 - 29
- N**
- Name plate 16
- P**
- PC
 - connecting the base station to a PC 14
 - PC audio
 - reproducing via the headset 27
 - PC mode
 - adjusting 19
 - testing 19
 - Phone
 - connecting the base station to a fixed line phone with headset socket 12
 - connecting the base station to a fixed line phone without headset socket 12
 - Phone and PC mode
 - switching between Phone and PC mode 28
 - Phone mode
 - adjusting 17
 - testing 17
- R**
- Radio range
 - adjusting 20
 - exceeding 31
 - Rechargeable battery
 - charging 22
 - replacing 34
 - Ring tone
 - adjusting the volume 28
- S**
- Softphone
 - calling via the PC 26
 - supported softphones 15
 - Specifications
 - HeadSetup 15
- T**
- Telephone connection
 - testing 17
 - Troubleshooting 35
- V**
- Volume
 - adjusting 28
 - limiting 21
 - Volume button
 - swapping the assignment 17
- W**
- Wideband and narrowband mode
 - switching between wideband and narrowband mode 21
 - Wireless link
 - establishing automatically 21



Sennheiser Communications A/S
6 Langager, 2680 Solrød Strand, Denmark
www.sennheisercommunications.com

Printed in China
Publ. 11/09
A01