

BW 900

Instruction Manual
Bedienungsanleitung
Notice d'emploi
Istruzioni per l'uso
Instrucciones de uso
Manual de instruções
Gebruiksaanwijzing
Betjeningsvejledning
Handhavande Manual
Bruksanvisning

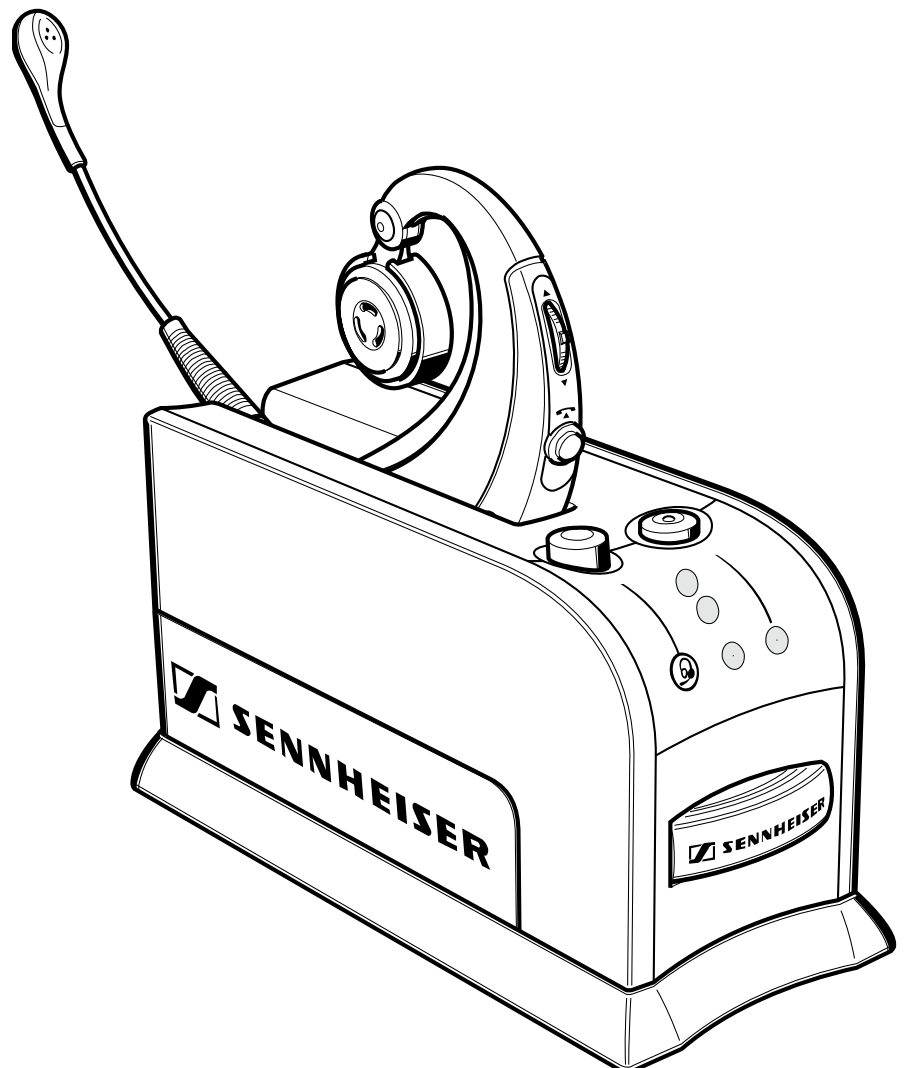

Wireless System BW 900

Contents

Intended use	4
Observe the following instructions for the BW 900 system	4
Related documents	5
Product description	5
Adaptive Intelligence for optimal speech intelligibility	5
ActiveGard™ for your well-being	5
Stylish and lightweight, with high wearing comfort	5
More room to move	5
Optimum connectivity	5
Non-stop talking	6
Delivery includes	6
Operating elements	7
BW 900 base station	7
BW 900 headset	7
Button overview	8
Setting up the BW 900 system	9
Setting up the headset	9
Inserting the battery into the headset	9
Adapting the headset to your ear	9
Setting up the base station	9
Connecting the base station to the office phone	9
Connecting a handset lifter to the BW 900 system (optional)	10
Testing the setup	10
Testing the handset lifter setup (optional)	10
Adjusting the BW 900 to your office phone	11
Connecting the headset to other Bluetooth devices (pairing)	11
Connecting the BW 900 system to a PC (optional)	12
Summary of settings	13
Basic settings	14
Switching the headset on/off	14
Switching the base station on/off	14
Phoning	15
Accepting incoming calls	15
Making calls with your office phone	15
Making calls with your mobile device	15
Voice dialling	16
Redialling	16
Terminating office phone calls	16
Terminating mobile phone calls	16
Setting the volume	16
Setting the speaker volume	16
Changing the ring tone volume	17
Power management	17
How long does the battery last?	17
Indications when the battery is about to run flat	18
Charging the battery	18
Changing the battery during a call	18

If you leave the transmitting range	19
Leaving/entering the transmitting range of the base station.....	20
Leaving/entering the transmitting range of the mobile device	20
Advanced settings	21
Call management	21
Redialling	21
Toggling between calls via office phone and via mobile phone.....	21
Transferring calls between headset and phone	21
Rejecting a call from the mobile device	22
Muting.....	22
Muting/unmuting the headset microphone	22
Muting the ring tone	22
Listening to an external audio source.....	22
Activating/deactivating the adaptive volume adjustment	23
Pairing	23
Resetting the BW 900 system.....	24
Maintenance and care	24
Spare parts	24
Accessories	24
Specifications.....	25
Overall system	25
Headset.....	25
Manufacturer declarations	25
Warranty regulations.....	25
CE Declaration of Conformity	25
FCC statements.....	26
Batteries or rechargeable batteries.....	26
WEEE Declaration	26
Index	27

We have designed this product to give you reliable operation over many years. Over 60 years of accumulated expertise in the design and manufacture of high-quality electro-acoustic equipment have made Sennheiser a world-leading company in this field.

Please take a few moments to read these instructions carefully, as we want you to enjoy your new Sennheiser product quickly and to the fullest.

Safety information



The BW 900 system has been manufactured according to the accepted rules of safety and current technology. However, there is still a danger of damage to equipment if the following general safety instructions are not complied with.

- Read these instructions completely before working with the BW 900 system.
- Keep these instructions in a location where they are accessible to all users at all times.
- Always include the operating instructions when you pass the BW 900 system on to third parties.

Intended use

The BW 900 system is an accessory for fixed line phones, and Bluetooth-enabled devices such as mobile phones, PCs and PDAs, allowing for wireless communication in office and home office applications.

It is considered improper use when the BW 900 system

- is used for any application not named in these instructions,
- is used under operating conditions that deviate from those described in these instructions.

Observe the following instructions for the BW 900 system

General instructions

- Never disassemble or modify components of the BW 900 system. The right to disassemble or modify is reserved to authorized personnel. This applies especially to all units connected to AC outlets. If units are opened by customers in breach of this instruction, the warranty becomes null and void.
- The rechargeable battery used in this device may present a fire or chemical burn hazard if mistreated. Therefore, do not disassemble, heat above 100°C (212°F) or incinerate the battery.
- Sennheiser Communications is not liable for damages resulting from the loss of connection.

Before assembly

- Use the BW 900 system in dry places only and keep liquids and small electrically conductive parts away from the BW 900 system and its connecting sockets.

During assembly

- Set up the unit on an even surface and lay the cables in such a way that nobody can pull the BW 900 system or your phone from the table by accident.

During operation

- This equipment generates, uses and can radiate radio frequency energy and, if not installed and used in accordance with the instructions, may cause harmful interference to radio communications. However, there is no guarantee that interference will not occur in a particular installation.
- When you are not using your headset, place it in the base station cradle to recharge its battery.
- The rechargeable headset battery must be charged in the BW 900 base station, only! Never try to charge batteries other than those specified for use with the BW 900 headset in the base station!
- Only to be used with Sennheiser Communications supplied approved and certified power supply (EU 094707, UK 092892, US 092893, AUS 520334).

- Cleaning**
- For cleaning the BW 900 system, use a dry cloth only. Do not use any solvents or cleansing agents.
- Disposal**
- Dispose of used batteries according to the legal regulations of your country.



Related documents

The BW 900 system may be used together with other Sennheiser Communications system components. Also follow the instructions for the other system components. This includes:

- the HSL 10 Handset Lifter for all types of fixed line phones
- the TCI 01 "Telephone Controlling Interface" for phones featuring an AEI or DHSG interface

Product description

Adaptive Intelligence for optimal speech intelligibility

The new Bluetooth office headset BW 900 features unique Adaptive Intelligence technology (patent pending) providing excellent sound quality. The BW 900 automatically compensates for ambient noise and "remembers" the user's preferred settings. During conversation, these settings are adapted automatically in order to compensate for fluctuations in ambient noise levels.

Adaptive Intelligence also ensures that the interlocutor listening to the headset user can enjoy optimum speech clarity.

ActiveGard™ for your well-being

The headset is equipped with ActiveGard™, a unique technology patented by Sennheiser Communications. It uses sophisticated sound pressure limitation systems to actively safeguard your hearing against acoustic shocks. A safe and comfortable sound level allows for stress-free work with the headset.

Stylish and lightweight, with high wearing comfort

Its discreet design is another plus of this headset. The fashionable and lightweight device is placed behind the user's ear. As it is barely noticeable, it is comfortable enough to wear it all day. It can be adjusted ergonomically for a perfect fit on any ear. The BW 900 blue-and-charcoal design is unobtrusive. The small microphone boom impairs neither the user's freedom of movement nor his or her field of vision.

More room to move

BW 900 is a Bluetooth Class 1 device supporting the version 1.2 standard. It provides long-range operation and maximum compatibility. With the base station connected to your office phone, you can roam around the building up to a distance of 100 m. Additionally, you can move up to 10 metres away from your Bluetooth-enabled devices such as mobile phones, PCs and PDAs.

Optimum connectivity

The Bluetooth interface allows the BW 900 to be connected to several devices. Whether you are using a mobile phone or other phone types such as smart phones or soft phones – the BW 900 is compatible with all types of speech-based Bluetooth devices. The user-friendly pushbutton

interface provides for seamless changeover between your fixed line phone and any Bluetooth-enabled phone paired.

Non-stop talking

Should the battery run flat while you are talking via your office phone, you can easily replace it with a fully charged battery without terminating your call. While no battery is being connected, the BW 900 base station maintains the connection to the telephone line.

Delivery includes

- 1 BW 900 base station
- 1 BW 900 Bluetooth headset
- 1 rechargeable Li-polymer battery, partially pre-charged
- 3 speaker adjustment rings, sizes S, M (premounted on earpiece) and L
- 1 phone connecting cable already plugged to base station
- 1 quick guide
- 1 CD with detailed instruction manual (PDF)
- 1 power supply
- 1 microphone windshield
- 1 battery dummy, inserted in the base station's spare battery charging slot

Operating elements

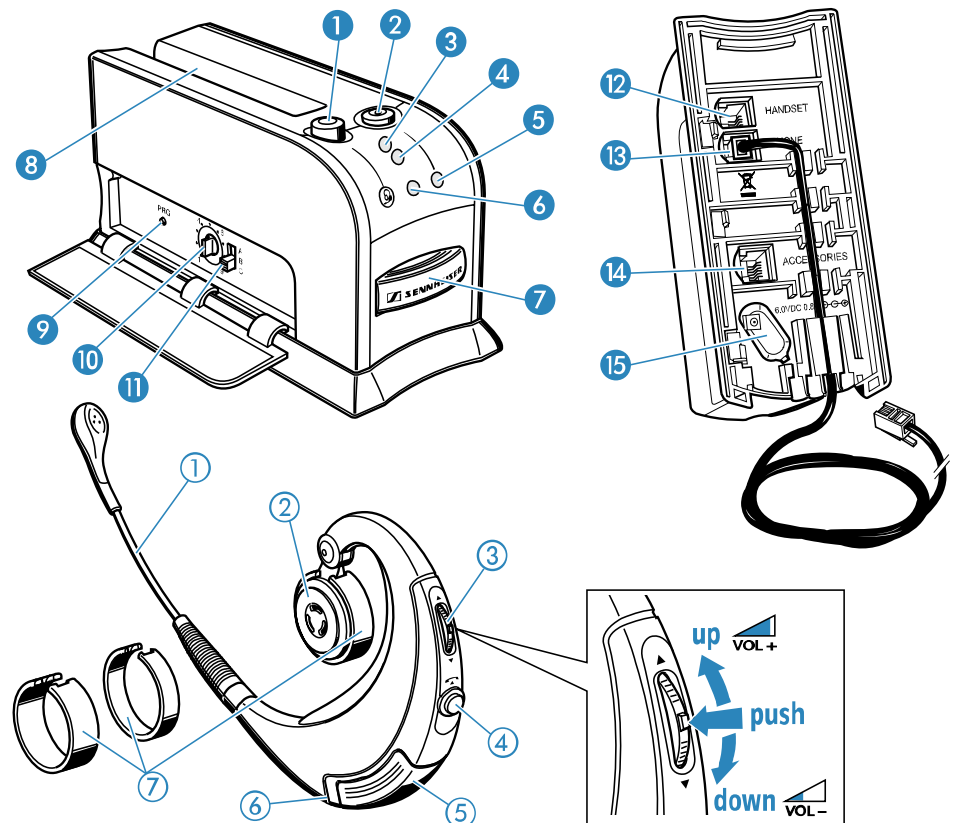

BW 900 base station

- ① Headset/handset switch
- ② Base station hook button
- ③ Headset charging LED
- ④ Spare battery charging LED
- ⑤ Hook LED
- ⑥ Mute LED
- ⑦ Spare battery charging slot
- ⑧ Headset cradle
- ⑨ Program button
- ⑩ Microphone volume knob
- ⑪ Telephone adjustment switch
- ⑫ HANDSET socket
- ⑬ PHONE socket
- ⑭ ACCESSORIES socket
- ⑮ DC IN socket

BW 900 headset

- ① Microphone boom
- ② Hinged speaker
- ③ Multi switch
- ④ Headset hook button
- ⑤ Battery compartment
- ⑥ Headset LED
- ⑦ Speaker adapters

Button overview

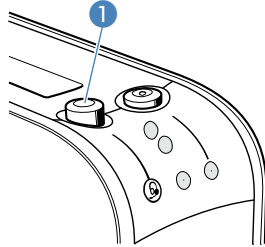
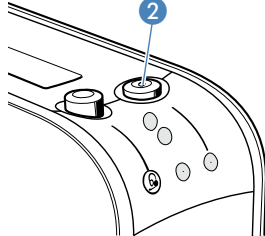
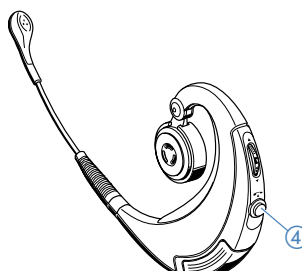
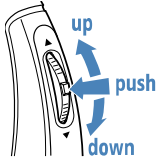
Button	Function	See
<p>Headset/handset switch ①</p> 	<ul style="list-style-type: none"> toggle between the office phone handset (up position) and the BW 900 headset (down position) 	page 14
<p>Base station hook button ②</p> 	<ul style="list-style-type: none"> accept an incoming call end a call 	<p>page 15</p> <p>page 16</p>
<p>Headset hook button ④</p> 	<ul style="list-style-type: none"> accept a call end a call toggle between mobile phone and office phone redial with mobile device activate voice dialling 	<p>page 14</p> <p>page 16</p> <p>page 21</p> <p>page 21</p> <p>page 15</p>
<p>Multi switch ③</p> 	<ul style="list-style-type: none"> adjust the volume (up/down) mute the headset microphone or acoustic signals (push) reject calls from the mobile device (push) switch on/off (push until LED flashes 3 x blue: on – red: off) 	<p>page 16</p> <p>page 22</p> <p>page 22</p> <p>page 14</p>

Setting up the BW 900 system

Setting up the headset

Inserting the battery into the headset

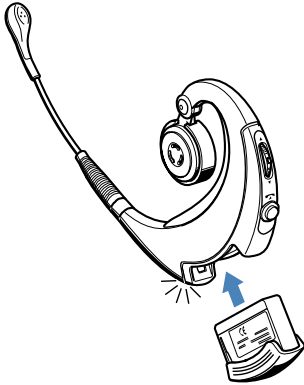

- ▶ Insert the battery into the headset's battery compartment. The headset LED ⑥ flashes blue every 5 seconds to indicate that the headset is in standby mode.

Note

If the headset is not switched on automatically, the battery is flat and must be charged as described under "Charging the battery" on page 18.

Adapting the headset to your ear

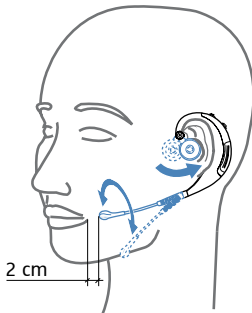

- ▶ Put the headset on. You can wear the headset on either the left or right ear without changing the headset.
- ▶ Close the speaker housing so that the headset firmly fits your ear.

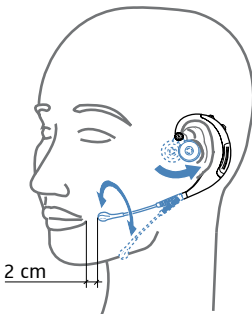

- ▶ Then adjust to your own comfort level by opening the housing just a few millimetres.

Note:

If the pre-installed speaker adapter ⑦ size "M" does not fit your ear, clip on the smaller or larger one.

- ▶ Turn the microphone boom ① towards your mouth. The optimal microphone position is two cm from the corner of the mouth.

Setting up the base station

Connecting the base station to the office phone

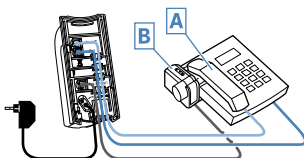

- ▶ Disconnect the handset A from your office phone, but leave it on the phone.
- ▶ Plug the free handset cable connector to the BW 900 HANDSET socket ⑫.
- ▶ Connect the cable which is already connected to the base station (PHONE socket ⑬) to the office phone socket where the handset cable was connected before.
- ▶ Connect the power supply to the DC IN socket ⑮ and to the mains. All LEDs light up for 2 seconds.

Connecting a handset lifter to the BW 900 system (optional)

When connecting a Sennheiser Communications handset lifter (see "Accessories" on page 24):

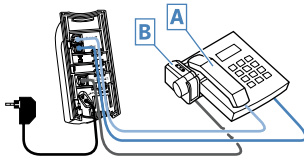

- ▶ Connect the handset lifter B to the ACCESSORIES socket 14.
- ▶ Install the microphone as described in the handset lifter manual.
- ▶ Attach the handset lifter to the phone as described in the handset lifter manual.

Note:

The BW 900 system also supports handset lifters from manufacturers other than Sennheiser Communications but you require an additional interface (TCI 01, see "Accessories" on page 24).

If your office phone features an AEI or a DHSG interface, you do not require any mechanical handset lifter but only the TCI 01 interface:

- ▶ Connect the TCI 01 as described in the TCI 01 manual.

Testing the setup

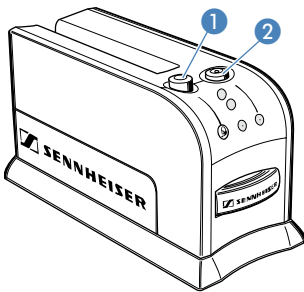

- ▶ Make sure the headset is in standby mode and the base station is in range (the headset LED 6 flashes once every five seconds).
- ▶ Press the headset/handset switch 1 to the "up" position. The connection to the handset is established.
- ▶ Pick up the handset from your office phone. If a dial tone is heard in the handset, the system is connected properly. If no dial tone is heard, please refer to the next section.

Testing the handset lifter setup (optional)

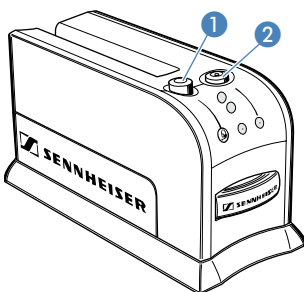

- ▶ Put the headset in the headset cradle 8 and wait until the headset charging LED 3 lights up.
- ▶ Take the headset out of the headset cradle 8. The headset LED 6 flashes once every 5 seconds to indicate that the headset is in standby mode.
- ▶ Press the headset/handset switch 1 to the "down" position. The connection to the headset can be established.
- ▶ Press either the headset hook button 4 or the base station hook button 2.

A wireless link is established between the headset and the base station. The handset lifter lifts off the handset automatically and the dial tone is heard in the headset. If no clear dial tone is heard, please refer to the next section.

Adjusting the BW 900 to your office phone

To ensure optimum intelligibility, adjust the BW 900 system to your phone as follows:

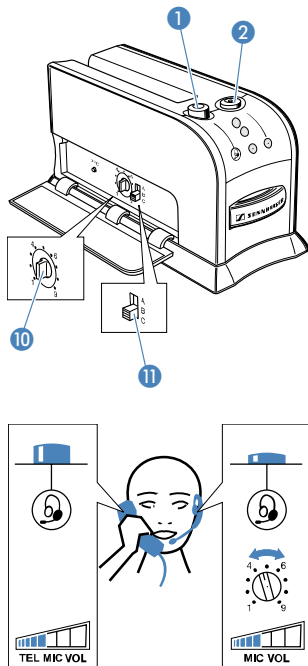

- ▶ Press the headset/handset switch ① to the “down” position. The connection to the headset can be established.
- ▶ Put on the headset and adjust it for comfort.
- ▶ Press the headset hook button ④ or the base station hook button ②. A wireless link is established between the headset and the base station.
- ▶ Pick up the phone handset from its cradle.
- ▶ Adjust the telephone adjustment switch ⑪ so that the dial tone can be heard loud and clear in the headset.
- ▶ Turn the microphone volume knob ⑩ to position 1.
- ▶ Make a test call to someone while adjusting the microphone sensitivity.
- ▶ Speak to the other party by alternately using the handset (headset/handset switch ① is in the “up” position) and the headset (headset/handset switch ① is in the “down” position), always starting with the handset.
- ▶ Turn the microphone volume knob ⑩ so that the other party can hear you at a comfortable level, whether you use the headset or the handset.

Connecting the headset to other Bluetooth devices (pairing)

The headset is capable of being paired with up to three Bluetooth devices:

- one base station (cannot be changed)
- one mobile phone (can be changed for another mobile phone)
- one PC or one PDA (can be changed for another PC or PDA, respectively)

The Bluetooth devices must feature a “hands free profile” and “headset profile”.

Note:

As soon as you pair for example a new mobile phone, the old mobile phone is no longer detected. Certain features like redialling and voice dialling are only possible if supported by the mobile device.

- ▶ Make sure the headset is turned on and placed close to your mobile device.
- ▶ Set your mobile device to Bluetooth pairing mode (see the manual of your mobile device).
- ▶ Press and hold down both the headset hook button ④ and the multi switch ③ (in “push” direction) until the headset LED ⑥ starts flashing blue and red alternately. The headset is in pairing mode.

Note:

If pairing is not successful within 60 seconds, the headset returns automatically to standby mode.

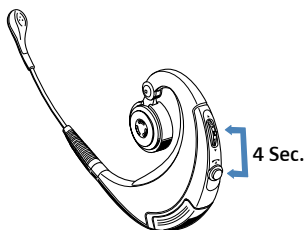

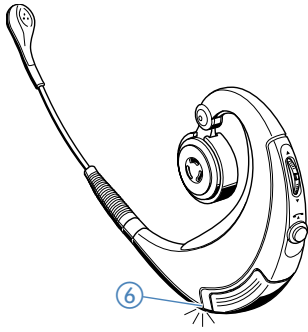

- ▶ When your mobile device prompts a keyword, enter four zeros (0000). When pairing was successful, the headset LED ⑥ lights up blue 3 times. The headset acknowledges with a tone, and your mobile device displays a message.

Note:

See also www.senncom.com/bw900 for pairing instructions for your mobile device.

Connecting the BW 900 system to a PC (optional)

For multimedia purposes or voice over IP (internet telephony), the BW 900 base station can be connected to a computer. There are two ways to connect to a PC:

- Connecting via the PC sound card – no office phone connection: you require a PC cable (see "Spare parts" on page 24)
- If you wish to connect via Bluetooth: refer to "Connecting the headset to other Bluetooth devices" on page 11).

Please refer to the corresponding manual for setup information.

Summary of settings

Function	Button(s) to be actuated	See
switching the headset on/off	press and hold down for 4 seconds the multi switch ③ in "push" direction	page 14
activating the headset	set the headset/handset switch ① to its "down" position	page 14
activating the office phone handset	set the headset/handset switch ① to its "up" position	page 14
accepting an office phone call	press the base station hook button ② or the headset hook button ④ and lift the handset	page 15
accepting a mobile device call	press and hold down the headset hook button ④ until a confirmation beep is heard in the headset	page 15
making an office phone call	press the base station hook button ② or the headset hook button ④ and lift the handset, then dial	page 15
making a mobile phone call	press the headset hook button ④, then dial	page 15
voice dialling (if supported by your mobile device)	press and hold down the headset hook button ④ until a confirmation beep is heard, then speak	page 16
redialling the last number (mobile device only)	quickly press the headset hook button ④ two times	page 16
terminating an office phone call	press the base station hook button ② or the headset hook button ④ and hang up the handset	page 16
terminating a mobile device call	press the base station hook button ② or the headset hook button ④	page 16
increasing the speaker volume by one step	press the multi switch ③ in "up" direction during the conversation	page 16
reducing the speaker volume by one step	press the multi switch ③ in "down" direction during the conversation	page 16
increasing the ring tone volume by one step	press the multi switch ③ in "up" direction while the phone is ringing or in standby mode	page 17
reducing the ring tone volume by one step	press the multi switch ③ in "down" direction while the phone is ringing or in standby mode	page 17
muting the ring tone on a call from the office phone	press the multi switch ③ in "push" direction – once muted, the ring tone cannot be unmuted	Page 22
rejecting a call	press the multi switch ③ in "push" direction while the mobile device is ringing	page 22
muting/unmuting the headset microphone	press the multi switch ③ in "push" direction during the conversation	page 22
starting the pairing mode	press and hold both the multi switch ③ and the headset hook button ④ for 4 seconds	page 23
deactivating the adaptive volume adjustment	press and hold the program button ⑨ and the base station hook button ② for 4 seconds	page 22

Basic settings

Switching the headset on/off

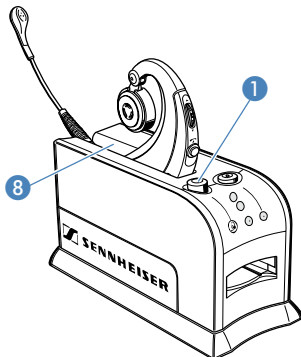

In the office it is not necessary to switch off the headset. If you do not want to use the headset:

- ▶ Simply place the headset in the headset cradle **8** and set the headset/handset switch **1** to the “up” position. The headset is deactivated. Your office phone works as usual with the handset.

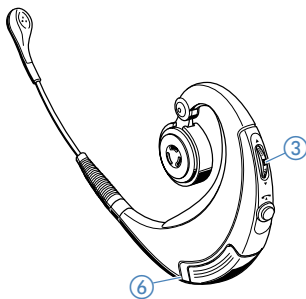

To switch off the headset (e.g. when taken away from the base station):

- ▶ Press and hold down the headset multi switch **3** for approx. 4 seconds until the headset LED **6** flashes red three times to indicate that the headset is switched off.

Note:

All settings are saved when the headset is switched off.

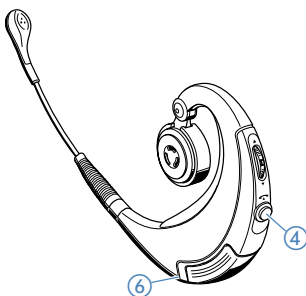

To switch the headset on, either:

- ▶ Place the headset in the headset cradle **8**.

or:

- ▶ Press and hold the headset hook button **4** for approx. 4 seconds until the headset LED **6** flashes blue three times to indicate that the headset is switched on. Then the headset LED **6** flashes blue once every 5 seconds to indicate that the headset is in standby mode.

Switching the base station on/off

To switch the base station off:

- ▶ Unplug the power supply.

Phoning

Accepting incoming calls

When you receive a call either via your office phone or via your mobile device, you hear a ring tone in the headset. In addition, the headset LED ⑥ flashes quickly.

Note:

There are two different ring tone melodies:

- one ring tone melody for incoming calls from the office phone,
- another ring tone melody for incoming calls from the mobile device.

It is not possible to change the ring tone melody.

To accept the call:

- ▶ Press either the base station hook button ② or the headset hook button ④.
A wireless link is established between the headset and the base station.
- ▶ If you receive a call via your office phone and no automatic headset lifter is installed to your office phone, pick up the phone's handset manually. If an automatic headset lifter is installed, the handset lifter picks up the headset automatically.
The link to the phone line is established.
- ▶ Start to talk.

Making calls with your office phone

- ▶ Press either the base station hook button ② or the headset hook button ④.
A wireless link is established between the headset and the base station.
- ▶ If no automatic headset lifter is installed to your office phone, pick up the phone handset manually. If an automatic headset lifter is installed, the handset lifter picks up the headset automatically.
The link to the phone line is established and the dial tone is heard.
- ▶ Dial the number and talk.

Making calls with your mobile device

- ▶ Press and hold down the headset hook button ④ until a beep is heard in the headset.
A wireless link is established between the headset and your master mobile device.
- ▶ Dial the number and talk.

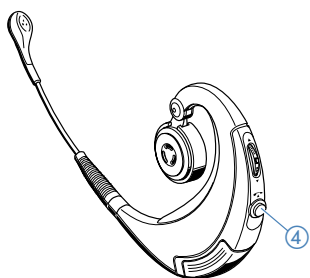
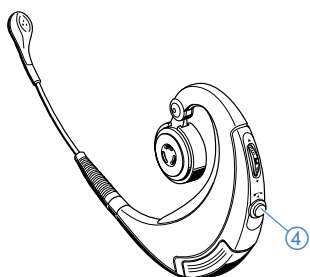
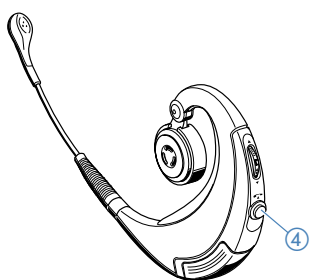
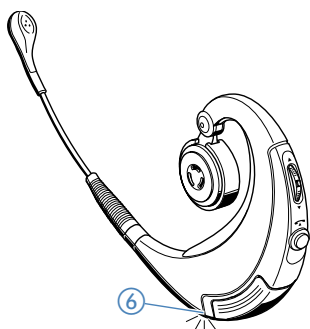

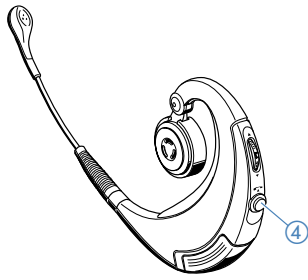

Voice dialling

The voice dialling function must be supported by your mobile device. Please refer to your mobile phone's manual.

- ▶ Make sure the breaking-in of the voice dialling function is done with the headset as the headset provides a better sound quality than most mobile phone microphones do.
- ▶ Press and hold down the headset hook button ④ until a confirmation beep is heard.
- ▶ Say the name of the other party.
The mobile device dials the corresponding number automatically.

Redialling

Automatic redialling the last number is only possible with certain mobile devices. Please refer to your mobile phone's manual.

- ▶ Quickly press the headset hook button ④ two times.
The last dialled number is redialled.

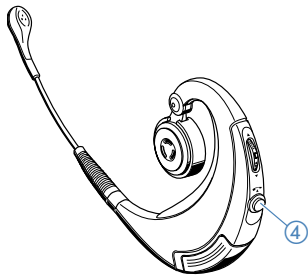

Terminating office phone calls

- ▶ Press either the base station hook button ② or the headset hook button ④. The wireless link between the headset and the base station is terminated.
- ▶ If no automatic handset lifter is installed to your office phone, hang up the phone's handset manually. If an automatic handset lifter is installed, the handset lifter hangs up the handset automatically.

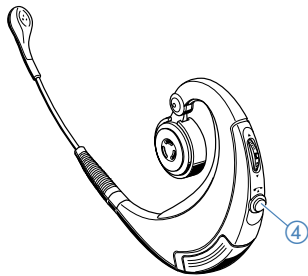

Terminating mobile phone calls

- ▶ Press the headset hook button ④. The wireless link between the headset and the mobile phone is terminated.
See your mobile phone manual whether your mobile phone terminates the call automatically or you have to terminate the call manually.

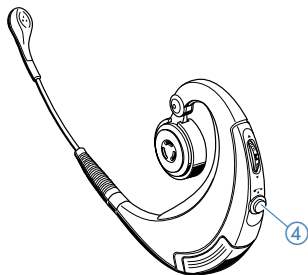

Setting the volume

Use the multi switch ③ to adjust the volume.

Setting the speaker volume

The adaptive volume adjustment function adjusts the volume automatically, e.g. when you enter or leave a noisy environment. If you take corrective action, the adaptive volume adjustment will memorize your settings and apply them automatically next time.

The speaker volume can be adjusted between step 1 and step 9. The factory setting is step 5. Your settings for your office phone and your mobile device are saved independently.

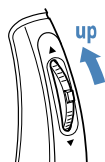

To manually increase the speaker volume:

- ▶ Push the multi switch ③ in "up" direction during a conversation. A confirmation beep is heard and the speaker volume is increased.

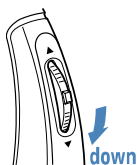

To manually decrease the speaker volume manually:

- ▶ Push the multi switch ③ in "down" direction during a conversation. A confirmation beep is heard and the speaker volume is decreased.

Changing the ring tone volume

The ring tone volume can be adjusted between step 1 and 9. The factory setting is step 5. To be able to change the ring tone volume the headset must be in standby mode or ringing.

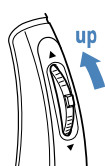

To increase the ring tone volume:

- ▶ Push the multi switch ③ in the "up" direction while the ring tone is being heard in the headset. One high frequency beep is heard in the headset. The ring tone volume is increased by one step.

Note:

When the maximum volume is reached, two high frequency beeps are heard.

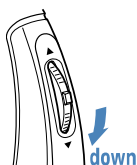

To decrease the ring tone volume:

- ▶ Push the multi switch ③ in the "down" direction while the ring tone is being heard in the headset. One low frequency beep is heard in the headset. The ring tone volume is decreased by one step.

Note:

When the minimum volume is reached, two low frequency beeps are heard.

Power management

How long does the battery last?

The battery life depends on the distance between headset and the base station or mobile phone and corresponds to 4 to 5 hours of talk time.

To prevent the battery from running flat:

- ▶ Place the headset in the headset cradle ⑧ when you are not using it. The battery is recharged.

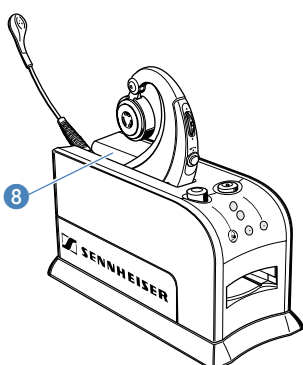

Indications when the battery is about to run flat

When the battery is about to run flat:

- The hook LED ⑤ flashes red three times every 15 seconds.

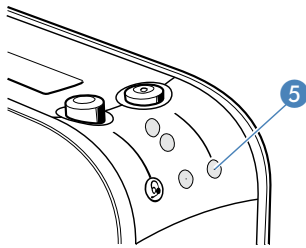

- The headset LED ⑥ flashes red three times every 15 seconds.
- Three beeps are heard every 15 seconds, however, after three times there is no further warning.

Note:

With every new connection either to the base station or to the mobile phone the warning sequence will start again.

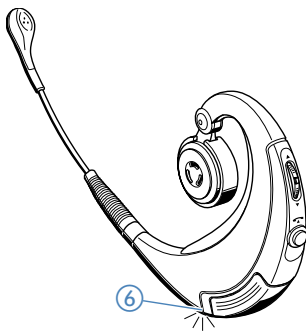

Charging the battery

Note:

If you charge the battery for the first time, allow charging for at least 4 hours without interruption.

To charge the battery in the headset:

- ▶ Place the headset in the headset cradle ⑧. The headset charging LED ③ lights up red to indicate that the battery is being recharged. When recharging is complete, the headset charging LED ③ lights up blue.

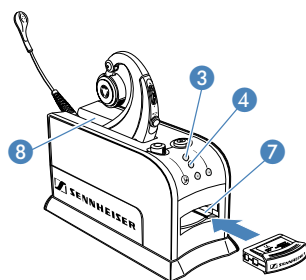

To charge a second battery:

- ▶ Insert the battery in the spare battery charging slot ⑦. The spare battery charging LED ④ lights up red indicating the battery is being recharged. When recharging is complete the spare battery charging LED ④ lights up blue.

Note:

When – after 2-3 years – the battery capacity is reduced significantly, replace the battery with a new one.

Changing the battery during a call

If you have a second, fully charged battery, you can replace a flat battery even during an office phone call as follows:

Note:

Do not take the battery out of the headset during a mobile device call as this will interrupt the phone link immediately!

- ▶ Take the flat battery out of the headset. The headset LED Headset LED ⑥ goes off and the hook LED ⑤ lights up red indicating the headset is not received (out of range). The call is briefly interrupted, however, the call is held by the base station for 40 seconds.
- ▶ Take the fully charged battery out of the spare battery charging slot ⑦ and insert it into the headset. The headset LED Headset LED ⑥ flashes blue three times indicating the headset is switched on. Subsequently the headset LED Headset LED ⑥

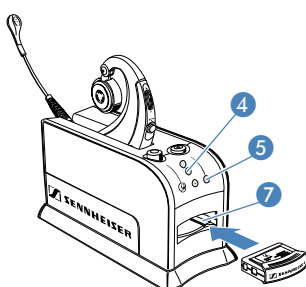

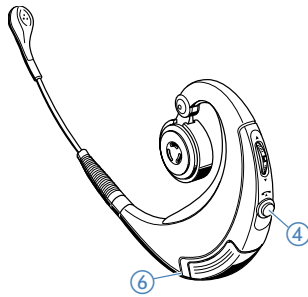

flashes blue once every 5 seconds to indicate that the headset is in standby mode and a ring tone is heard via the headset.

- ▶ Press the headset hook button ④.
The call is resumed.
- ▶ Insert the flat battery into the spare battery charging slot ⑦.
The spare battery charging LED ④ lights up red to indicate that the battery is being recharged.

If you leave the transmitting range

Telephoning is only possible in the Bluetooth transmitting range of the base station or the mobile device, respectively. The transmitting range depends largely on environmental conditions like wall thickness, wall composition etc. With a free line of sight, the transmitting range of the base station is up to 100 metres; the transmitting range of the mobile device is up to 10 metres.

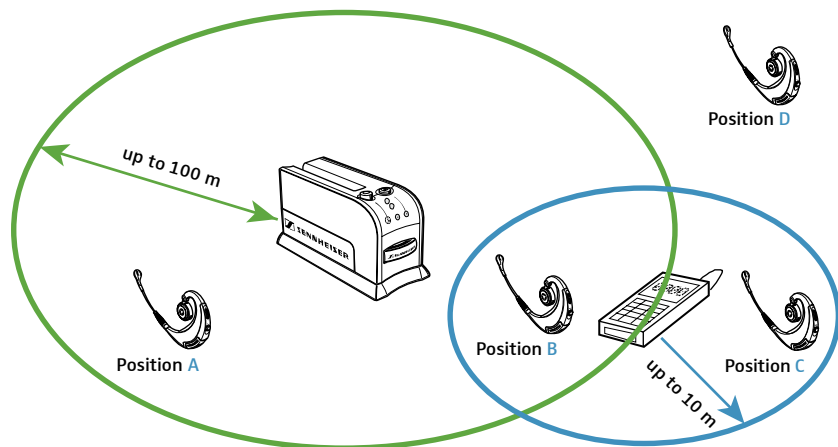

Headset is in position	Indication		Result
	base station hook LED	headset LED	
A	is off	flashes blue once every 5 seconds	no telephoning via mobile device
B			telephoning possible via base station or mobile device
C	lights up red constantly	flashes blue twice every 5 seconds, two high frequency beeps are heard in the headset every 10 seconds	no telephoning via base station but only via mobile device
D			no telephoning via base station or mobile device

We recommend to make a test call to another person in the same office and to walk around during the call to find out if any areas are out of range.

Leaving/entering the transmitting range of the base station

If the headset leaves the base station transmitting range during a call:

- The sound quality deteriorates before the connection finally brakes down.
- The hook LED ⑤ lights up red constantly to indicate that the headset is out of the base station range.

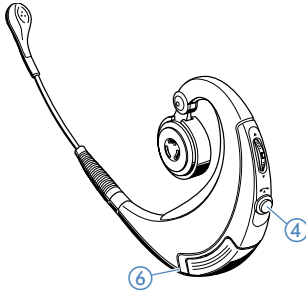
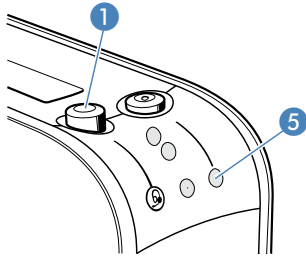

- The headset LEDHeadset LED ⑥ flashes blue **twice** every 5 seconds indicating that the headset is out of the base station range in standby mode.

If you get back into range within 40 seconds, a ring tone is heard in the headset. To resume the call:

- ▶ Press the headset hook button ④.

Leaving/entering the transmitting range of the mobile device

If the headset leaves the mobile device transmitting range during a call:

- The sound quality deteriorates before the connection finally breaks down.
- Your mobile device displays the loss of connection.
- Please refer to your mobile device's manual to find out whether the call is transferred to the mobile device automatically or requires an acknowledgement to do so.

Advanced settings

Call management

Redialling

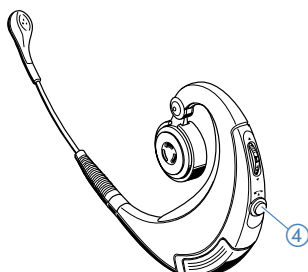

To redial the same number as in the mobile call before:

- ▶ Double press the headset hook button **4**.
The mobile device dials the same number as in the call before.

Note:

The redialling function works only with the mobile device. For further information please refer to your mobile device's manual.

toggling between calls via office phone and via mobile phone

toggling between calls via office phone and via mobile phone allows you to quickly switch from one call to another.

- ▶ Press and hold the headset hook button **4** until a beep is heard in the headset.
The current call is terminated automatically and the new call is accepted.

Note:

You can use the call waiting functions of your office and mobile phone as usual.

Transferring calls between headset and phone

To transfer a call from your mobile device to the headset:

- ▶ Press and hold the headset hook button **4** until a beep is heard in the headset.

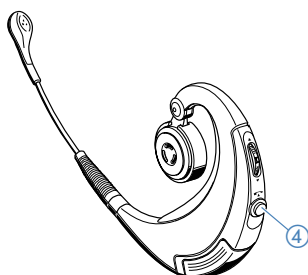

To transfer a call from the headset to your mobile device:

- ▶ Switch off the headset (see page 14) or use the mobile phone to transfer the call from the headset to the mobile phone.

To transfer a call from your office phone handset to the headset:

- ▶ Set the base station headset/handset switch **1** to the "down" position.
- ▶ Press either the base station hook button **2** or the headset hook button **4**.

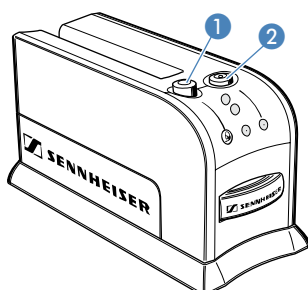

To transfer a call from the headset to your office phone handset:

- ▶ Set the base station headset/handset switch **1** to the "up" position.

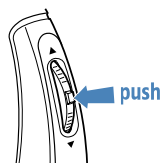

Rejecting a call from the mobile device

- ▶ Press the multi switch ③ in “push” direction.
Depending on the mobile device settings, the call is transferred to a voice mailbox.

Note:

It is not possible to reject an office phone call. But you can mute the ring tone as described in “Muting the ring tone” on page 22.

Muting

Muting/unmuting the headset microphone

To mute the headset microphone:

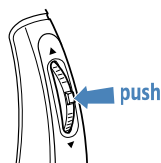

- ▶ Press the multi switch ③ in “push” direction during a conversation.
On the base station, the mute LED ⑥ lights up red constantly. A high frequency beep is heard every 5 seconds in the headset.

To unmute the headset microphone:

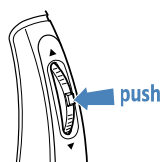

- ▶ Press the multi switch ③ in “push” direction.
On the base station the mute LED ⑥ goes off. The beeping stops.

Muting the ring tone

To mute the ring tone in the headset:

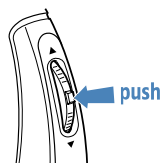

- ▶ Press the multi switch ③ in “push” direction while a ring tone is being heard in the headset.
The ringing stops. However, you can still accept the call by pressing the base station hook button ② or the headset hook button ④.

Listening to an external audio source

To establish a link to a Bluetooth audio source:

- ▶ Pair the headset with the audio source as described under “Connecting the headset to other Bluetooth devices” on page 11.
- ▶ Use the audio source to establish a Bluetooth connection to the headset (the headset hook button ④ does not work with external audio sources).
The headset accepts the audio signal automatically. The audio is heard in the headset.

Note:

During the reception of a Bluetooth audio source the headset is unable to detect or to make any call via your mobile or office phone!

To end the link to a Bluetooth audio source:

- ▶ Press the headset hook button ④ or use the audio source to end the Bluetooth connection to the headset.

Activating/deactivating the adaptive volume adjustment

If you wish to deactivate the adaptive volume adjustment:

- ▶ Press and hold down the program button **9** and additionally press the base station hook button **2**. The hook LED **5** flashes red twice to indicate that the adaptive volume adjustment is deactivated.

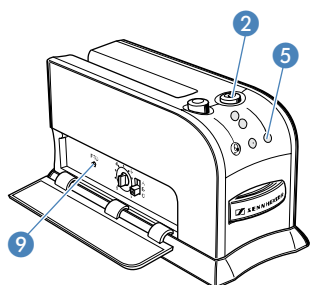

If you wish to reactivate the adaptive volume adjustment:

- ▶ Press and hold the program button **9** and additionally press the base station hook button **2**. The hook LED **5** flashes blue twice indicating that the adaptive volume adjustment is activated.

Note:

If you get out of range of the base station, the adaptive volume adjustment is activated!

Pairing

Upon delivery, the headset and the base station are already paired, i.e. they automatically recognize each other and do not interfere with other Bluetooth devices. You do not have to pair them again.

However, if you have to replace the headset with a new one, e.g. because it is damaged, the base station will not recognize the new headset unless they are paired as follows:

- ▶ Press the program button **9** quickly two times. The base station is set to pairing mode. The hook LED **5** flashes blue.

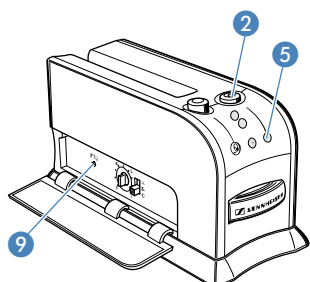

- ▶ Press and hold down for 4 seconds the headset hook button **4** and the multi switch **3**. The headset LED **6** lights up blue and red and then flashes blue to indicate that the headset is in pairing mode.

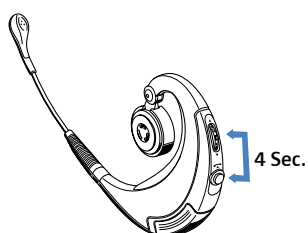

Note:

If pairing is not successful within 60 seconds, the headset returns to standby mode.

The pairing process starts automatically. When pairing has been successful, the blinking stops and the headset LED **6** and the base station hook LED **5** quickly flash blue three times.

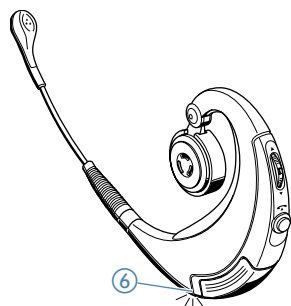

Resetting the BW 900 system

In order to reset the system to the factory setting:

- ▶ Pair the base station and the headset (see “Pairing” on page 23)
All learning memory values and all volume settings are reset to the factory setting.

Maintenance and care

If you do not want to use the headset for a longer time:

- ▶ Set the headset/handset switch **1** to the “up” position.
You can still use your office phone as usual.

To clean the components of the system:

- ▶ Use a dry cloth only. Do not use any solvents or cleansing agents.

Spare parts

- Headset
- Base station
- Rechargeable battery
- Power supply (AUS, EU, UK, US)
- Ear pad, foam
- Ear pad for headband, leather-like
- Quick Guide
- CD with manual as a PDF file
- Microphone windscreen

Accessories

- PC cable
- Handset lifter including a ring tone detection microphone unit
- Adjustment ring set – 3 sizes S, M and L
- Headband
- TCI 01 “Telephone Controlling Interface” for phones featuring an AEI or DHSG interface
- Cable extension kit (to increase the distance between the office phone and the base station).
- Long handset/phone connection cable (2.5 m)
- Long handset connection cable
- PC cable RJ 11 with two 3.5 mm jack plugs (2.5 m)

Specifications

Overall system

Host phone compatibility with all types of business phones which comply with the RF immunity standard IEC CISPR24/EN55024.

Indoor operating range (depending on the environment) up to 100 m

Operating range with free line of sight up to 150 m

Temperature range for use 10 °C (50 °F) to 40 °C (104 °F)

Headset

Charging time of rechargeable battery approx. 3 h

Talking time approx. 4.5 h

Transmitting power $p_A < 100 \text{ mW}$ (20 dBm) EIRP

Weight (incl. battery) approx. 26 g

Manufacturer declarations

Warranty regulations

The guarantee period for this Sennheiser product is 24 months from the date of purchase. Excluded are accessory items, rechargeable or disposable batteries that are delivered with the product; due to their characteristics these products have a shorter service life that is principally dependent on the individual frequency of use.

The guarantee period starts from the date of original purchase. For this reason, we recommend that the sales receipt be retained as proof of purchase. Without this proof (which is checked by the responsible Sennheiser service partner) you will not be reimbursed for any repairs that are carried out.

Depending on our choice, guarantee service comprises, free of charge, the removal of material and manufacturing defects through repair or replacement of either individual parts or the entire device. Inappropriate usage (e.g. operating faults, mechanical damages, incorrect operating voltage), wear and tear, force majeure and defects which were known at the time of purchase are excluded from guarantee claims. The guarantee is void if the product is manipulated by non-authorized persons or repair stations.

In the case of a claim under the terms of this guarantee, send the device, including accessories and sales receipt, to the responsible service partner. To minimise the risk of transport damage, we recommend that the original packaging is used. Your legal rights against the seller, resulting from the contract of sale, are not affected by this guarantee.

The guarantee can be claimed in all countries outside the U.S. provided that no national law limits our terms of guarantee.

CE Declaration of Conformity



This equipment is in compliance with the essential requirements and other relevant provisions of Directives 1999/5/EC, 89/336/EC or 73/23/EC.

Before putting the device into operation, please observe the respective country-specific regulations!

Warning!



FCC statements

Changes or modifications made to this equipment not expressly approved by Sennheiser Communications may void the FCC authorization to operate this equipment.

This device complies with Part 15 of the FCC Rules and with RSS-210 of Industry Canada.

Operation is subject to the following two conditions:

- this device may not cause harmful interference, and
- this device must accept any interference received, including interference that may cause undesired operation.

The radiated output power of the BW 900 system is far below the FCC radio frequency exposure limits. Nevertheless, the BW 900 system shall be used in such a manner that the potential for human contact during normal operation is minimized.

Batteries or rechargeable batteries



The supplied batteries or rechargeable batteries can be recycled. Please dispose of them as special waste or return them to your specialist dealer. In order to protect the environment, only dispose of exhausted batteries.

WEEE Declaration



Your Sennheiser product was developed and manufactured with high quality materials and components which can be recycled and/or reused. This symbol indicates that electrical and electronic equipment must be disposed of separately from normal waste at the end of its operational lifetime.

Please dispose of this product by bringing it to your local collection point or recycling centre for such equipment. This will help to protect the environment in which we all live.

Index

- accepting incoming calls 15
- accessories 24
- ActiveGard™ 5
- adaptive intelligence 5
 - activating 23
 - deactivating 23
- battery
 - battery life 17
 - changing during a call 18
 - charging 18
 - indications when the battery runs flat 18
 - inserting into headset 9
- Bluetooth 11
 - transmitting range 19
- call
 - accepting 15
 - making with mobile phone 15
 - making with office phone 15
 - rejecting 22
 - terminating 16
 - toggling between calls 21
 - transferring between headset and phone 21
- cleaning 24
- functions
 - summary 13
- handset lifter 9, 10, 15, 16
- headset
 - switching off 14
 - switching on 14
- headset button 7
- hook button
 - base station 7
 - headset 7
- intended use 4
- LED
 - headset charging LED 7
 - hook LED 7
 - mute LED 7
 - on headset 7
 - spare battery charging LED 7
- making calls with a mobile phone 15
- making calls with the office phone 15
- microphone
 - muting 22
 - sensitivity
 - adjustment knob 7
- multi-switch 7
- muting
 - headset microphone 22
 - ring tone 22
- office phone 10
 - connection to base station 9
- pairing
 - headset with base station 23
 - headset with Bluetooth device 11
- PC 11
- phoning 15
- programme button 7
- putting out of operation 24
- redialling 16, 21
- resetting 24
- ring tone
 - muting 22
- ring tone volume
 - changing 17
- safety 4
- socket
 - ACCESSORIES 7
 - HANDESET 7
 - PHONE 7
- spare battery
 - charging slot 7
- speaker volume
 - changing 16
- switching on/off
 - headset 14
- Switching on/off
 - headset 14
- telephone adjustment switch 7
- testing 10
- toggling between calls 21
- transmitting range 19
 - (re-) entering 20
 - leaving 20
 - of mobile phone 20
- voice dialling 16
- volume
 - of ring tone 17
 - of speaker 16