

TEST REPORT

Test report no.: 1-3791/11-01-16-A



Testing laboratory

CETECOM ICT Services GmbH
 Untertuerkheimer Strasse 6 – 10
 66117 Saarbruecken / Germany
 Phone: + 49 681 5 98 - 0
 Fax: + 49 681 5 98 - 9075
 Internet: <http://www.cetecom.com>
 e-mail: ict@cetecom.com

Accredited Testing Laboratory:

The testing laboratory (area of testing) is accredited according to DIN EN ISO/IEC 17025 (2005) by the Deutsche Akkreditierungsstelle GmbH (DAkkS). The accreditation is valid for the scope of testing procedures as stated in the accreditation certificate with the registration number: D-PL-12076-01-01. Area of Testing: Radio/Satellite Communications

Applicant

Sennheiser electronic GmbH & Co. KG
 Am Labor 1
 30900 Wedemark / GERMANY
 Phone: +49 5130 600-0
 Fax: +49 5130 600-574
 Contact: Marco Happ
 e-mail: marco.happ@sennheiser.com
 Phone: +49 5130 600-2621

Manufacturer

Sennheiser electronic GmbH & Co. KG
 Am Labor 1
 30900 Wedemark / GERMANY

Test standard/s

47 CFR Part 15 Title 47 of the Code of Federal Regulations; Chapter I
 Part 15 - Radio frequency devices

RSS - 210 Issue 8 Spectrum Management and Telecommunications - Radio Standards Specification
 Low-power Licence-exempt Radiocommunication Devices (All Frequency Bands):
 Category I Equipment

For further applied test standards please refer to section 3 of this test report.

Test Item

Kind of test item: Wireless conference system
Model name: ADN-W C1 / ADN-W D1
FCC ID: DMOADNWDU
IC: 2099A-ADNWDU
 Frequency: UNII band 5150 MHz to 5250 MHz
 (lowest channel 5180 MHz,
 highest channel 5240 MHz)
 Technology tested: Proprietary wireless audio transmission system
 Antenna: 2 integrated antennas
 Power Supply: 7.4 V DC by battery
 Temperature Range: +5°C to +45°C



This test report is electronically signed and valid without handwriting signature. For verification of the electronic signatures, the public keys can be requested at the testing laboratory.

Test report authorised:

p.o.

Marco Bertolino
 Testing Manager

Test performed:

Andreas Luckenbill
 Expert

1 Table of contents

1 Table of contents2

2 General information3

 2.1 Notes and disclaimer3

 2.2 Application details.....3

3 Test standard/s3

 3.1 Measurement guidance.....3

4 Test environment.....4

5 Test item4

 5.1 Additional information4

6 Test laboratories sub-contracted4

7 Summary of measurement results5

8 RF measurements6

 8.1 Description of test setup6

 8.1.1 Radiated measurements.....6

 8.1.2 Conducted measurements.....7

 8.2 Additional comments7

 8.3 RSP100 test report cover sheet / performance test data8

9 Measurement results.....9

 9.1 Gain.....9

 9.2 Duty cycle.....10

 9.3 Maximum output power conducted and radiated11

 9.4 Power spectral density13

 9.5 Spectrum bandwidth – 26 dB bandwidth18

 9.6 Peak excursion measurements.....23

 9.7 Band edge compliance radiated28

 9.8 TX spurious emissions radiated30

 9.9 RX spurious emissions radiated.....44

 9.10 Spurious emissions radiated < 30 MHz48

 9.11 Spurious emissions conducted < 30 MHz.....50

10 Test equipment and ancillaries used for tests54

11 Observations55

Annex A Document history56

Annex B Further information.....56

Annex C Accreditation Certificate57

2 General information

2.1 Notes and disclaimer

The test results of this test report relate exclusively to the test item specified in this test report. CETECOM ICT Services GmbH does not assume responsibility for any conclusions and generalizations drawn from the test results with regard to other specimens or samples of the type of the equipment represented by the test item.

The test report may only be reproduced or published in full. Reproduction or publication of extracts from the report requires the prior written approval of CETECOM ICT Services GmbH.

The testing service provided by CETECOM ICT Services GmbH has been rendered under the current "General Terms and Conditions for CETECOM ICT Services GmbH".

CETECOM ICT Services GmbH will not be liable for any loss or damage resulting from false, inaccurate, inappropriate or incomplete product information provided by the customer.

Under no circumstances does the CETECOM ICT Services GmbH test report include any endorsement or warranty regarding the functionality, quality or performance of any other product or service provided.

Under no circumstances does the CETECOM ICT Services GmbH test report include or imply any product or service warranties from CETECOM ICT Services GmbH, including, without limitation, any implied warranties of merchantability, fitness for purpose, or non-infringement, all of which are expressly disclaimed by CETECOM ICT Services GmbH.

All rights and remedies regarding vendor's products and services for which CETECOM ICT Services GmbH has prepared this test report shall be provided by the party offering such products or services and not by CETECOM ICT Services GmbH.

In no case this test report can be considered as a Letter of Approval.

This test report is electronically signed and valid without handwritten signature. For verification of the electronic signatures, the public keys can be requested at the testing laboratory.

2.2 Application details

Date of receipt of order:	2011-09-30
Date of receipt of test item:	2013-02-26
Start of test:	2013-02-26
End of test:	2013-03-20
Person(s) present during the test:	-/-

3 Test standard/s

Test standard	Date	Test standard description
47 CFR Part 15	2010-10	Title 47 of the Code of Federal Regulations; Chapter I Part 15 - Radio frequency devices
RSS - 210 Issue 8	2010-12	Spectrum Management and Telecommunications - Radio Standards Specification Low-power Licence-exempt Radiocommunication Devices (All Frequency Bands): Category I Equipment

3.1 Measurement guidance

UNII: KDB 789033	2011-10	Guidelines for Compliance Testing of Unlicensed National Information Infrastructure (U-NII) Devices - Part 15, Subpart E
------------------	---------	--

4 Test environment

Temperature:	T_{nom}	+22 °C during room temperature tests
	T_{max}	+45 °C during high temperature tests
	T_{min}	+5 °C during low temperature tests
Relative humidity content:		42 %
Barometric pressure:		not relevant for this kind of testing
Power supply:	V_{nom}	7.4 V DC by battery
	V_{max}	7.5 V
	V_{min}	6.2 V

5 Test item

Kind of test item	:	Wireless conference system
Type identification	:	ADN-W C1 / ADN-W D1
S/N serial number	:	Not available!
HW hardware status	:	FPGA : 2_8_5_prod2/ D1w_LX45_PROD_TX_279.bin
SW software status	:	ADNW_TERMINAL.EXE from 16.11.2012 / APP: 001120
Frequency band [MHz]	:	UNII band 5150 MHz to 5250 MHz (lowest channel 5180 MHz; highest channel 5240 MHz)
Type of radio transmission	:	OFDM
Use of frequency spectrum	:	
Type of modulation	:	QPSK with coding rate 1/2
Number of channels	:	4
Antenna	:	2 integrated antennas
Power supply	:	7.4 V DC by battery
Temperature range	:	+5°C to +45 °C

5.1 Additional information

Test setup - and EUT - photos are included in the following test reports:

External EUT photos:	1-3791/12-01-29_AnnexA
Internal EUT photos:	1-3791/12-01-29_AnnexB
Test setup:	1-3791/12-01-29_AnnexD

6 Test laboratories sub-contracted

None

7 Summary of measurement results

- No deviations from the technical specifications were ascertained
- There were deviations from the technical specifications ascertained

TC Identifier	Description	Verdict	Date	Remark
RF-Testing	CFR Part 15 RSS 210, Issue 8, Annex 9	Passed	2013-08-07	!

Test specification clause	Test case	Temperature conditions	Power source voltages	Pass	Fail	NA	NP	Remark
-/-	System gain	Nominal	Nominal					No passed / fail criteria!
U-NII Part 15	Duty cycle	Nominal	Nominal					No passed / fail criteria!
§15.407(a) RSS-210	Maximum output power (conducted & radiated)	Nominal	Nominal	<input checked="" type="checkbox"/>	<input type="checkbox"/>	<input type="checkbox"/>	<input type="checkbox"/>	complies
§15.407(a) RSS-210	Power spectral density	Nominal	Nominal	<input checked="" type="checkbox"/>	<input type="checkbox"/>	<input type="checkbox"/>	<input type="checkbox"/>	measurement made with antenna module
§15.407(a) RSS-210	Spectrum bandwidth 26dB bandwidth	Nominal	Nominal	<input checked="" type="checkbox"/>	<input type="checkbox"/>	<input type="checkbox"/>	<input type="checkbox"/>	measurement made with antenna module
§15.407(a) RSS-210	Peak excursion measurements	Nominal	Nominal	<input checked="" type="checkbox"/>	<input type="checkbox"/>	<input type="checkbox"/>	<input type="checkbox"/>	measurement made with antenna module
§15.205 RSS-210	Band edge compliance radiated	Nominal	Nominal	<input checked="" type="checkbox"/>	<input type="checkbox"/>	<input type="checkbox"/>	<input type="checkbox"/>	complies
§15.407(b) RSS-210	TX spurious emissions radiated	Nominal	Nominal	<input checked="" type="checkbox"/>	<input type="checkbox"/>	<input type="checkbox"/>	<input type="checkbox"/>	complies
§15.109 RSS-Gen	Unintentional radiator spurious emissions radiated	Nominal	Nominal	<input checked="" type="checkbox"/>	<input type="checkbox"/>	<input type="checkbox"/>	<input type="checkbox"/>	complies
§15.209(a) RSS-Gen	Spurious emissions radiated < 30 MHz	Nominal	Nominal	<input checked="" type="checkbox"/>	<input type="checkbox"/>	<input type="checkbox"/>	<input type="checkbox"/>	complies
§15.107(a)	Spurious emissions conducted emissions < 30 MHz	Nominal	Nominal	<input checked="" type="checkbox"/>	<input type="checkbox"/>	<input type="checkbox"/>	<input type="checkbox"/>	complies

Note: NA = Not Applicable; NP = Not Performed

8 RF measurements

8.1 Description of test setup

8.1.1 Radiated measurements

The radiated measurements are performed in vertical and horizontal plane in the frequency range from 9 kHz to 25 GHz in semi-anechoic chambers. The EUT is positioned on a non-conductive support with a height of 0.80 m above a conductive ground plane that covers the whole chamber. The receiving antennas are confirmed with specifications ANSI C63.2-1996 clause 15 and ANSI C63.4-2009 clause 4.1.5. These antennas can be moved over the height range between 1.0 m and 4.0 m in order to search for maximum field strength emitted from EUT. The measurement distances between EUT and receiving antennas are indicated in the test setups for the various frequency ranges. For each measurement, the EUT is rotated in all three axes until the maximum field strength is received. The wanted and unwanted emissions are received by spectrum analysers where the detector modes and resolution bandwidths over various frequency ranges are set according to requirement ANSI C63-4-2009 clause 4.2.

Antennas are confirmed with ANSI C63.2-1996 item 15.

Semi anechoic chamber

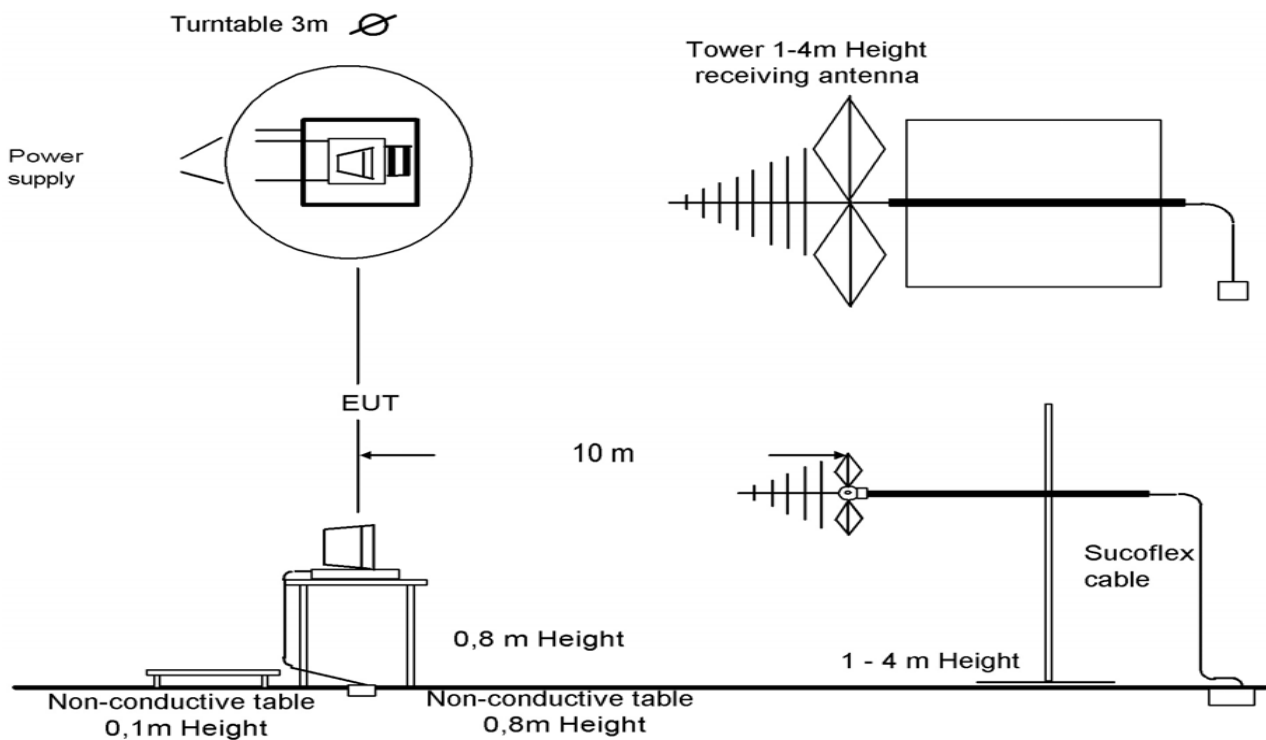

Picture 1: Diagram radiated measurements

9 kHz - 30 MHz:	active loop antenna
30 MHz – 1 GHz:	tri-log antenna
> 1 GHz:	horn antenna

The EUT is powered by an external power supply with nominal voltage

8.1.2 Conducted measurements

The EUT's RF signal is coupled out by the antenna connector which is supplied by the manufacturer. The signal is first 10dB attenuated before it is power divided (~6dB loss per branch). One of the signal paths is connected to the communication base Station (CMU200 or other), the other one is connected to the spectrum analyzer. The specific losses for both signal paths are first checked within a calibration. The measurement readings on the signalling unit/spectrum analyzer are corrected by the specific test set-up loss. The attenuator, power divider, signalling unit and the spectrum analyzer are impedance matched on 50 Ohm.

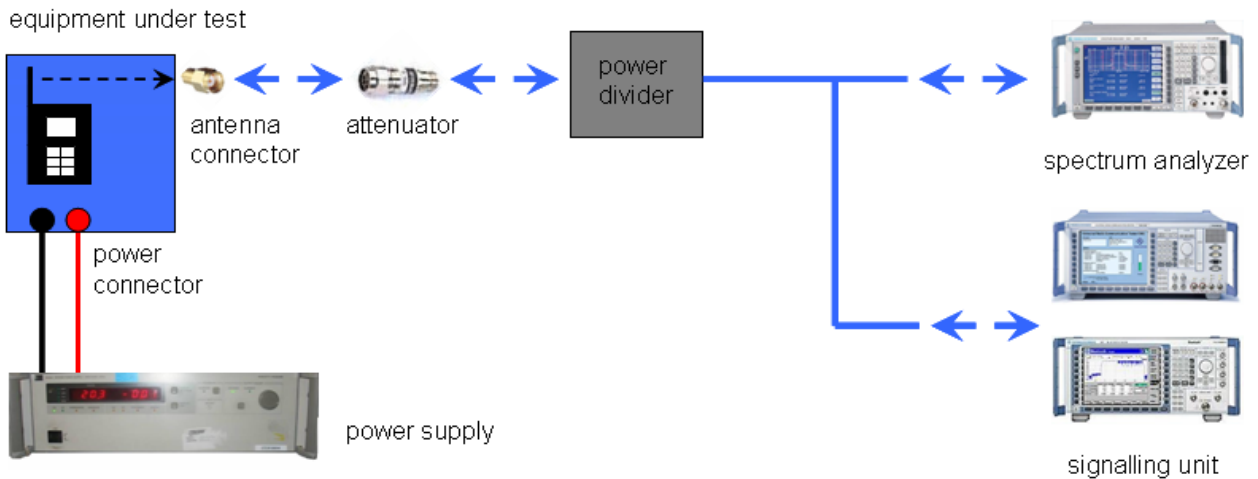

Picture 2: Diagram conducted measurements

8.2 Additional comments

Reference documents: ANT_D1-W C1-W

Special test descriptions: The antenna port 1 shows the same behaviour as antenna port 2. Antenna port 1 is included to show the fulfilment according to FCC Part 15.247 standard. The conducted measurements are made with Sennheiser ADN-W Antenna Module. The same module is used in the EUT.

The C1 unit and the D1 unit have the same integrated RF electronic part. The C1 unit has an additional electronic part with 2 buttons. The C1 unit is tested a worst case scenario.

Configuration descriptions: None

Test mode: No test mode available.
 Special software is used.
 EUT is transmitting pseudo random data by itself

8.3 RSP100 test report cover sheet / performance test data

Test report number	:	1-3791/11-01-16-A			
Equipment model number	:	ADN-W C1 / ADN-W D1			
Certification number	:	2099A-ADNWDU			
Manufacturer (complete address)	:	Sennheiser electronic GmbH & Co. KG Am Labor 1 30900 Wedemark / GERMANY			
Tested to radio standards specification no.	:	RSS 210, Issue 8, Annex 9			
Open area test site IC No.	:	IC 3462C-1			
Frequency range	:	UNII band 5150 MHz to 5250 MHz			
RF-power [mW] (max.)	:	Conducted values:			
		Band	OFDM antenna port 1	OFDM antenna port 2	-/-
		5180 – 5240 MHz	1.3 mW	1.0 mW	
		5190 – 5230 MHz			-/-
		5260 – 5320 MHz	-/-	-/-	
		5270 – 5310 MHz			-/-
		5500 – 5700 MHz	-/-	-/-	
		5510 – 5670 MHz			-/-
		Radiated values:			
		Band	OFDM antenna port 1	OFDM antenna port 2	-/-
		5180 – 5240 MHz	3.1 mW	3.4 mW	
		5190 – 5230 MHz			-/-
		5260 – 5320 MHz	-/-	-/-	
		5270 – 5310 MHz			-/-
5500 – 5700 MHz	-/-	-/-			
5510 – 5670 MHz			-/-		
Occupied bandwidth (99%-BW) [MHz] / Emission designator (TRC-43)	:	Band	OFDM antenna port 1	OFDM antenna port 2	-/-
		5180 – 5240 MHz	16.36 MHz / 16M4G7D	16.35 MHz / 16M4G7D	
		5190 – 5230 MHz			-/-
		5260 – 5320 MHz	-/-	-/-	
		5270 – 5310 MHz			-/-
		5500 – 5700 MHz	-/-	-/-	
5510 – 5670 MHz			-/-		
Type of modulation	:	OFDM technology with QPSK modulation.			
Antenna information	:	2 integrated antennas			
Transmitter spurious (worst case)[dB μ V/m @ 3m]:	:	41.99 dB μ V/m @ 6.22 GHz (peak)			

ATTESTATION:

DECLARATION OF COMPLIANCE:

I attest that the testing was performed or supervised by me; that the test measurements were made in accordance with the above-mentioned Industry Canada standard(s); and that the equipment identified in this application has been subjected to all the applicable test conditions specified in the Industry Canada standards and all of the requirements of the standard have been met.

Laboratory manager:

2013-08-07

Date

Andreas Luckenbill

Name



Signature

9 Measurement results

9.1 Gain

Reference document antenna gain:

D-Puck

Model Number:
WID2452

Internal Antenna – Surface Mount

Specifications:

- Tape and reel packaging for high volume pick-and-place manufacturing processes
- Planar Inverted F Antenna (PIFA) requires ground plane to radiate efficiently
- Conformance to European RoHS Directive 2002/95/EC

Frequency Ranges	2.4 - 2.5 GHz	5.15 - 5.875 GHz
Gain	>3 dBi	>4 dBi
Polarization	Linear	
Impedance	50 ohms	
VSWR	<2.5:1	
Dimensions (L x W x H)	16 x 16 x 6 mm	
Weight	2 g	
Carrier Material	Black color resin	

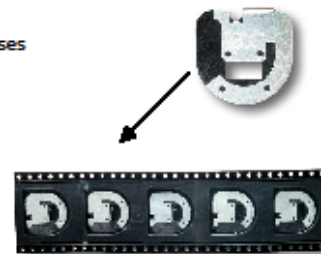

Connectors:

Model #	Part #	Description	Connector
WID2452	CAF94400	Tape and Reel	N/A
WID2452-SM	CAF94377	Eval PCBA	SMA-female Panel



Azimuth:
Total Gain

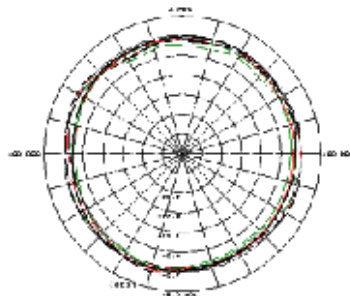

Elevation:
Total Gain

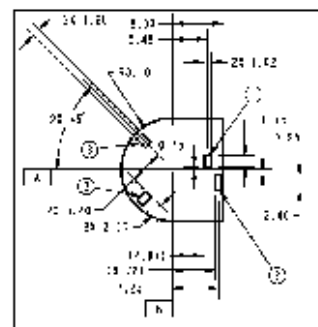
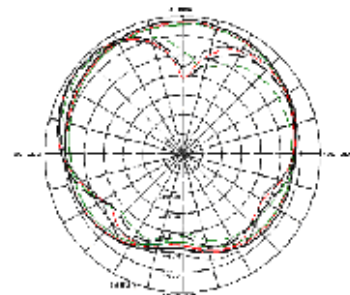

PCB FOOTPRINT LAYOUT

SCALE: 2

VSWR

1. Feed pad. Provide 50-ohm signal to pad. Isolate feed pad from ground as required to provide 50-ohm signal at top mounting surface. Matching network components (PI or L type) will be required on the input feed line.
2. Ground pad.

Specifications subject to change without notice.

D-Puck a - 12/28/05



3425 N.44th Street, LINCOLN, NE 68504 USA
 SALES PHONE: 800.228.4563
 PHONE: 402.467.4491 • FAX: 402.467.4528
 www.centurion.com • sales@centurion.com



Copyright © 2005 Centurion Wireless Technologies, Inc. All Rights Reserved

9.2 Duty cycle

Measurement:

Measurement parameter	
Detector:	Peak
Sweep time:	Auto
Resolution bandwidth:	10 MHz
Video bandwidth:	10 MHz
Span:	Zero
Trace-Mode:	Video trigger / view / single sweep

Results:

Plot 1: duty cycle of the transmitter – OFDM antenna port 1 & 2

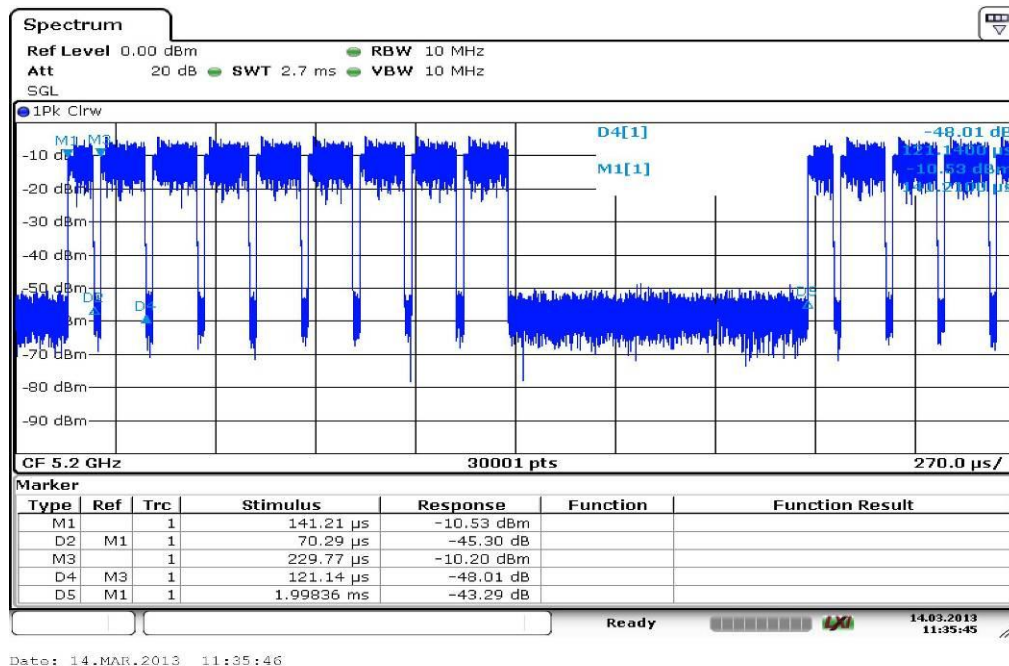

Results:

- Burst No. 1 = 70 μs
- Burst No. 2 = 121.14 μs → 8 burst @ 121.14 μs = 969.12 μs
- T_{on time} = 969.12 μs + 70 μs = 1.03912 ms
- T_{complete time} = 1.99836 ms
- Duty cycle = 52 % → 2.84 dB (duty cycle correction factor)

9.3 Maximum output power conducted and radiated

Description:

Measurement of the maximum output power conducted and radiated

Measurement:

Measurement parameter	
Detector:	RMS
Sweep time:	60s
Resolution bandwidth:	1 MHz
Video bandwidth:	≥ 3 MHz
Span:	> EBW
Trace-Mode:	Max hold
Analyzer function	Band power / channel power Interval > 26 dB EBW

Limits:

Radiated output power	Conducted output power
Conducted power + 6dBi antenna gain	The lesser one of 50mW or 4 dBm + 10 log Bandwidth 5.150-5.250 GHz (where Bandwidth is the 26dB Bandwidth [MHz])

Result: OFDM, antenna port 1

OFDM, antenna port 1 Channel	Maximum output power conducted [dBm]			
	Lowest 5180 MHz	Middle 5200 MHz	Highest 5240 MHz	-/-
+2.84 dB duty cycle correction	0.2*	0.4*	1.0*	-/-
Measurement uncertainty	± 1 dB			

*Measured with Sennheiser ADN-W Antenna module.

Result: **Passed**

OFDM, antenna port 1 Channel	Maximum output power radiated - EIRP [dBm]			
	Lowest 5180 MHz	Middle 5200 MHz	Highest 5240 MHz	-/-
+2.84 dB duty cycle correction	4.7	4.8	4.9	-/-
Measurement uncertainty	± 3 dB			

Result: **Passed**

Result: OFDM, antenna port 2

OFDM, antenna port 2 Channel	Maximum output power conducted [dBm]			
	Lowest 5180 MHz	Middle 5200 MHz	Highest 5240 MHz	-/-
	-0.8*	-0.6*	0.1*	-/-
Measurement uncertainty	± 1 dB			

*Measured with Sennheiser ADN-W Antenna module.

Result: Passed

OFDM, antenna port 2 Channel	Maximum output power radiated - EIRP [dBm]			
	Lowest 5180 MHz	Middle 5200 MHz	Highest 5240 MHz	-/-
+2.84 dB duty cycle correction	4.9	5.1	5.3	-/-
Measurement uncertainty	± 3 dB			

Result: Passed

9.4 Power spectral density

Description:

Measurement of the power spectral density of a digital modulated system. The measurement is repeated at the lowest, middle and highest channel.

Measurement:

Measurement parameter	
Detector:	RMS
Sweep time:	60 s / 120 s
Resolution bandwidth:	1 MHz
Video bandwidth:	≥ 3 MHz
Span:	> EBW
Trace-Mode:	Max hold

Limits:

Power Spectral Density
power spectral density conducted ≤ 4 dBm in any 1 MHz band (band 5150 – 5250 MHz)

Additional information:

The conducted measurements are made with Sennheiser ADN-W Antenna Module. The same module is used in the EUT.

Result: OFDM antenna port 1

OFDM antenna port 1 Channel	Power Spectral density [dBm/MHz]			
	Lowest 5180 MHz	Middle 5200 MHz	Highest 5240 MHz	-/-
+2.84 dB duty cycle correction	-10.54	-10.36	-9.85	-/-
Measurement uncertainty	± 1 dB			

Result: **Passed**

Result: OFDM antenna port 2

OFDM antenna port 2 Channel	Power Spectral density [dBm/MHz]			
	Lowest 5180 MHz	Middle 5200 MHz	Highest 5240 MHz	-/-
+2.84 dB duty cycle correction	-11.64	-11.38	-10.74	-/-
Measurement uncertainty	± 1 dB			

Result: **Passed**

Plots: OFDM, antenna port 1

Plot 1: TX mode, lowest channel



Plot 2: TX mode, middle channel

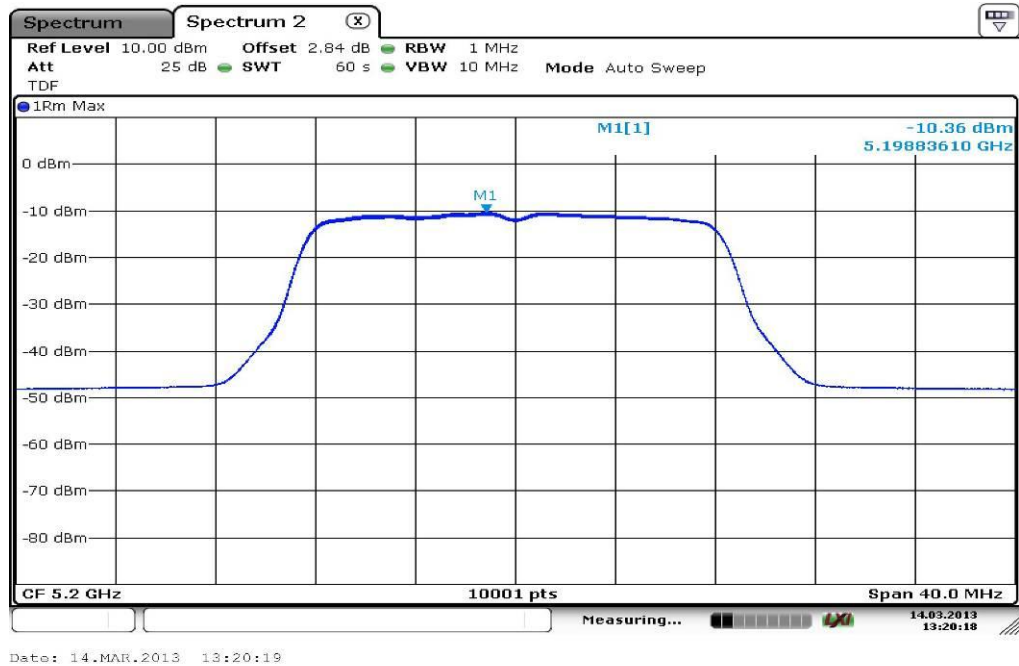

Plot 3: TX mode, highest channel



Date: 14.MAR.2013 13:18:39

Plots: OFDM, antenna port 2

Plot 1: TX mode, lowest channel



Plot 2: TX mode, middle channel

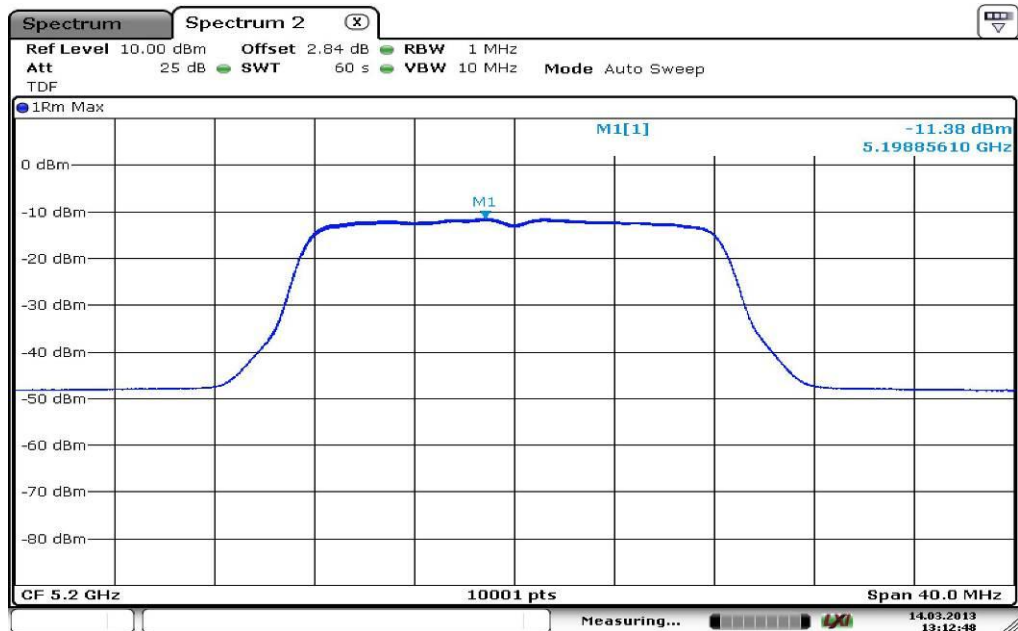

Plot 3: TX mode, highest channel

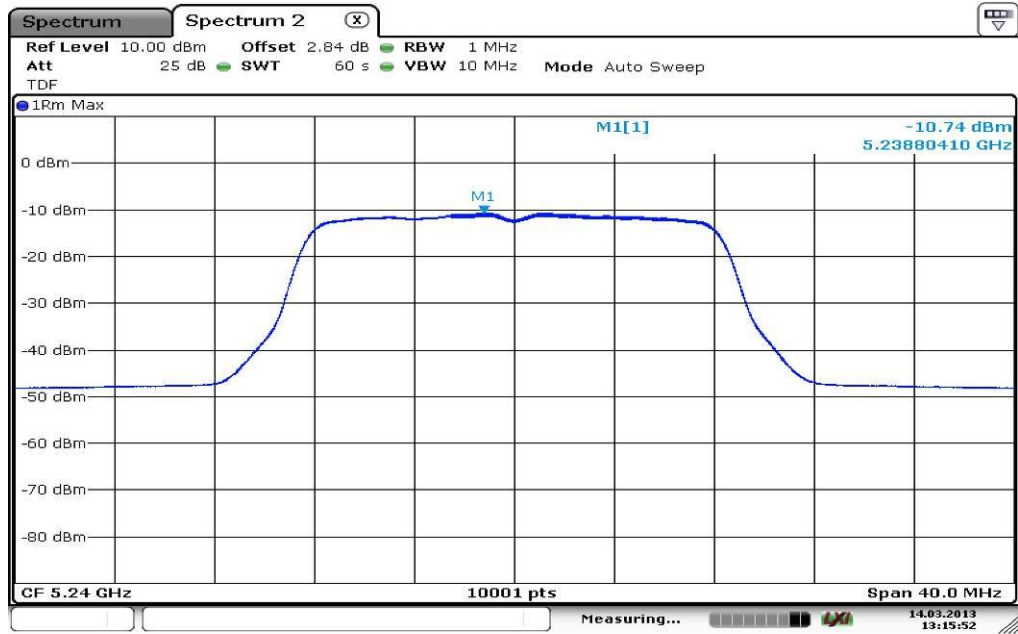

Date: 14.MAR.2013 13:15:52

9.5 Spectrum bandwidth – 26 dB bandwidth

Description:

Measurement of the 26 dB bandwidth of the modulated signal.

Measurement:

Measurement parameter	
Detector:	Peak
Sweep time:	Auto
Resolution bandwidth:	1% EBW
Video bandwidth:	≥ RBW
Span:	> complete signal!
Trace-Mode:	Max hold

Limits:

Spectrum Bandwidth – 26 dB Bandwidth
-/-

Additional information:

The conducted measurements are made with Sennheiser ADN-W Antenna Module. The same module is used in the EUT.

Result: OFDM antenna port 1

OFDM antenna port 1 Channel	26 dB BANDWIDTH [MHz]			
	Lowest 5180 MHz	Middle 5200 MHz	Highest 5240 MHz	-/-
	20.73	20.78	20.78	-/-
Measurement uncertainty	± 1 dB			

Result: **Passed**

Result: OFDM antenna port 2

OFDM antenna port 2 Channel	26 dB BANDWIDTH [MHz]			
	Lowest 5180 MHz	Middle 5200 MHz	Highest 5240 MHz	-/-
	20.58	20.53	20.43	-/-
Measurement uncertainty	± 1 dB			

Result: **Passed**

Plots: OFDM, antenna port 1

Plot 1: TX mode, lowest channel

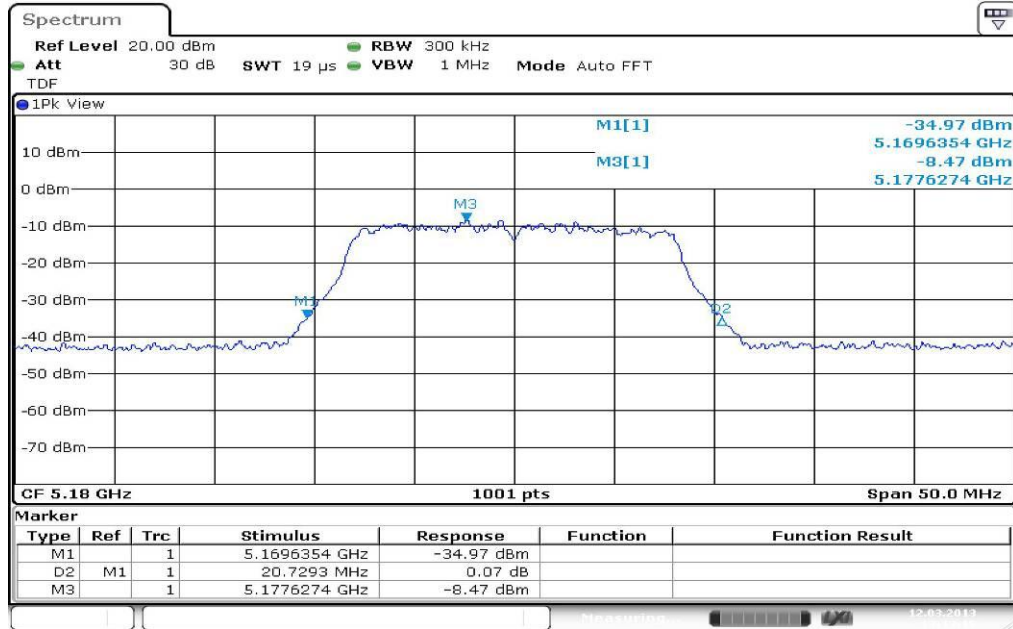

Date: 12.MAR.2013 13:13:16

Plot 2: TX mode, middle channel

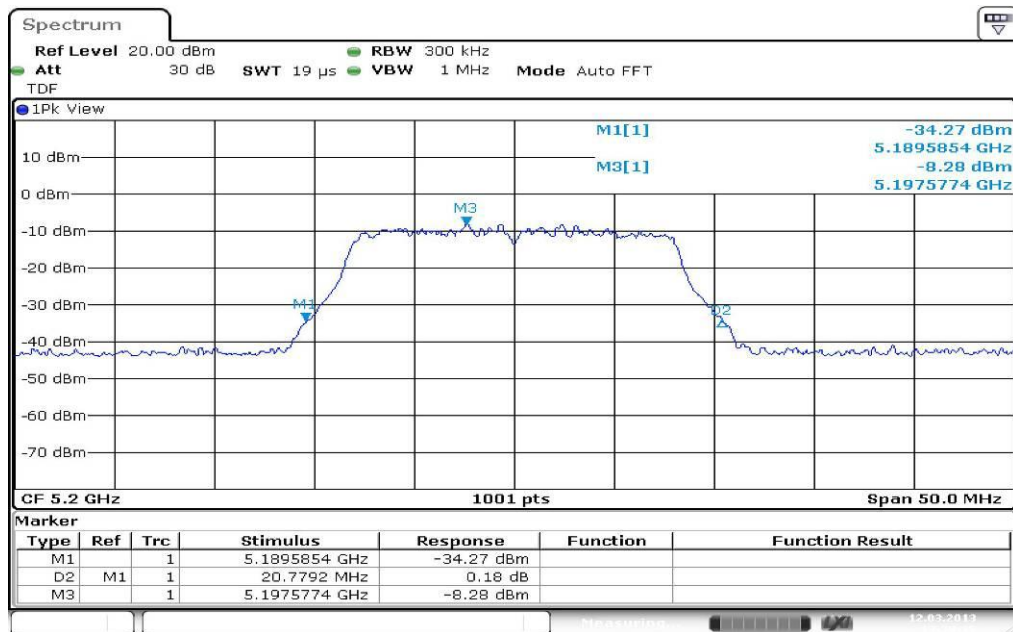

Date: 12.MAR.2013 13:29:36

Plot 3: TX mode, highest channel

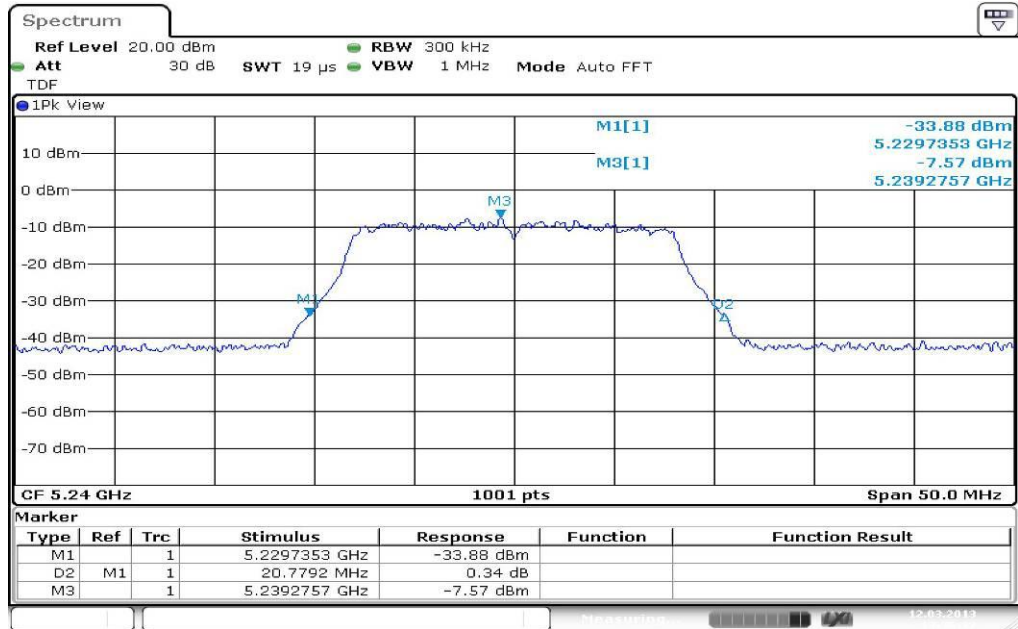

Date: 12.MAR.2013 13:36:33

Plots: OFDM, antenna port 2

Plot 1: TX mode, lowest channel

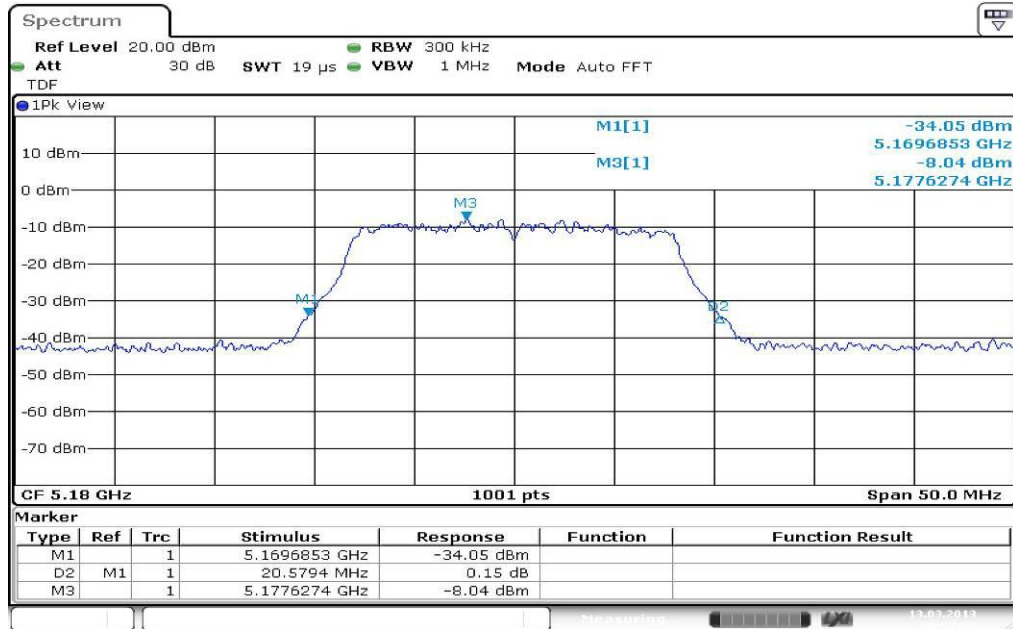

Date: 13.MAR.2013 06:57:22

Plot 2: TX mode, middle channel

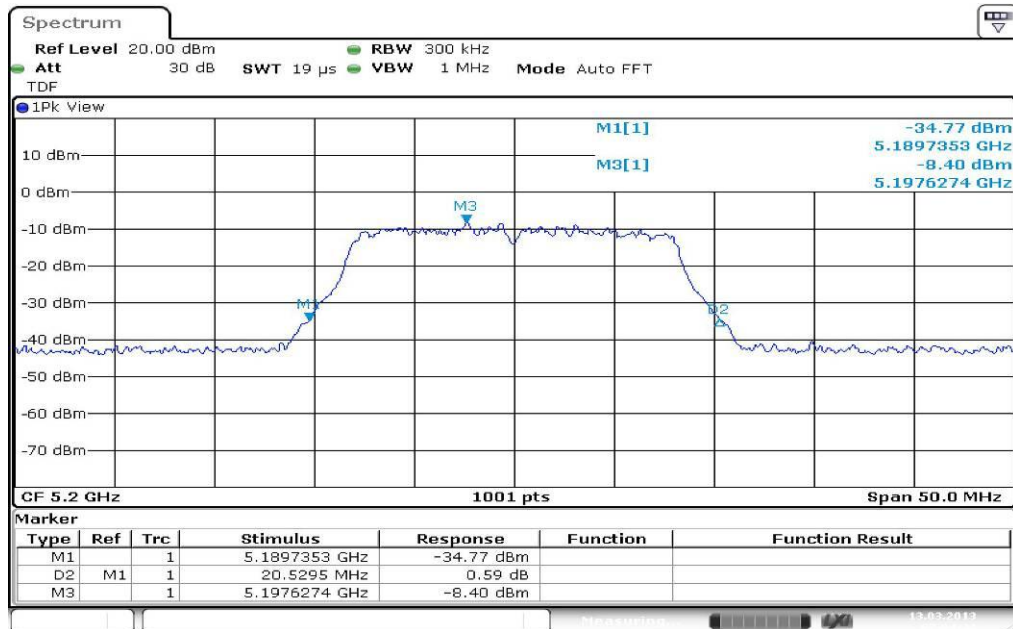

Date: 13.MAR.2013 07:04:44

Plot 3: TX mode, highest channel

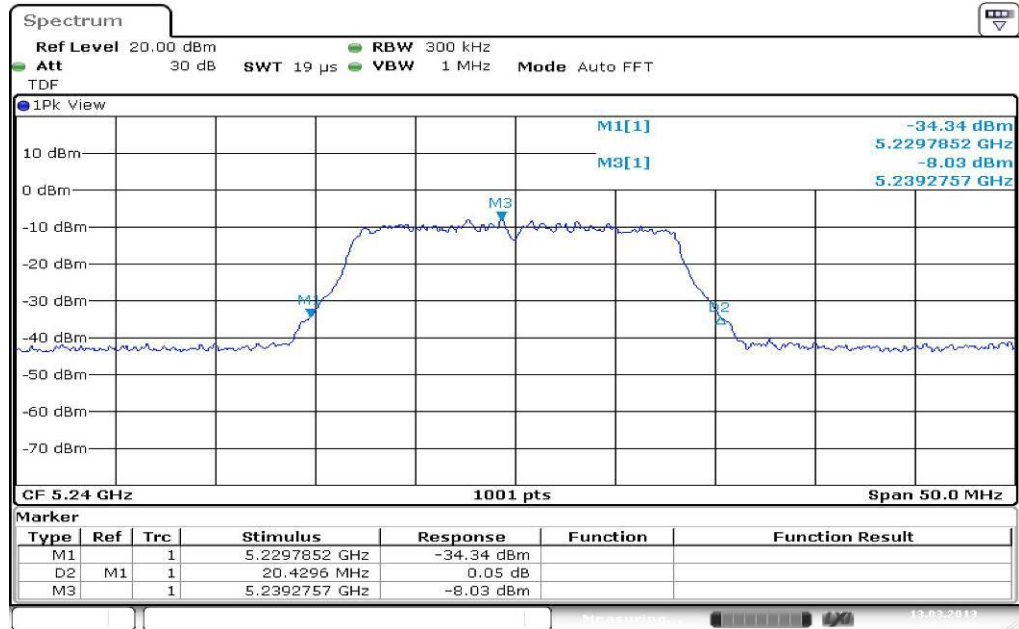

Date: 13.MAR.2013 07:15:05

9.6 Peak excursion measurements

Description:

Peak to average value.

Measurement:

Measurement parameter	
Detector:	Peak
Sweep time:	60 s / 120 s
Resolution bandwidth:	1 MHz
Video bandwidth:	≥ 3 MHz
Span:	> Complete signal
Trace-Mode:	Max hold

Limits:

Peak excursion value
Does not exceed 13 dB.

Additional information:

The conducted measurements are made with Sennheiser ADN-W Antenna Module. The same module is used in the EUT.

Results:

Modulation OFDM antenna port 1	Peak excursion value		
	5180 MHz	5200 MHz	5240 MHz
Channel			
RMS	-10.54	-10.36	-9.85
Peak	-2.43	-2.16	-1.71
Peak excursion value	8.11	8.20	8.14
Measurement uncertainty	± 1 dB		

Result: Passed

Results:

Modulation OFDM antenna port 2	Peak excursion value		
	5180 MHz	5200 MHz	5240 MHz
Channel			
RMS	-11.64	-11.38	-10.74
Peak	-2.01	-2.19	-2.20
Peak excursion value	9.63	9.19	8.54
Measurement uncertainty	± 1 dB		

Result: Passed

Plots: OFDM, antenna port 1

Plot 1: TX mode, lowest channel

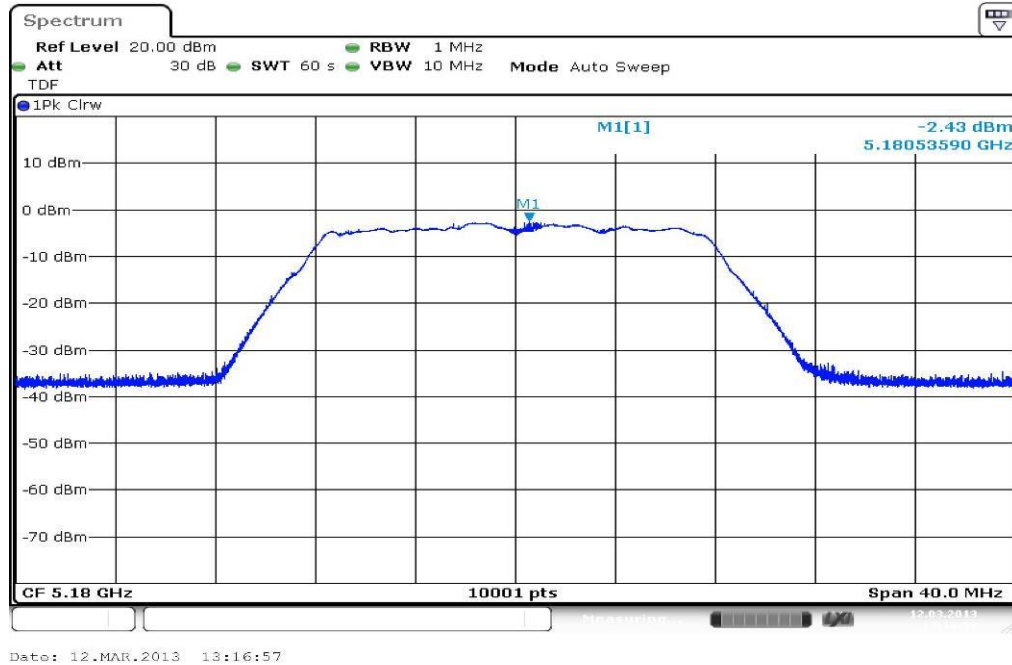

Plot 2: TX mode, middle channel

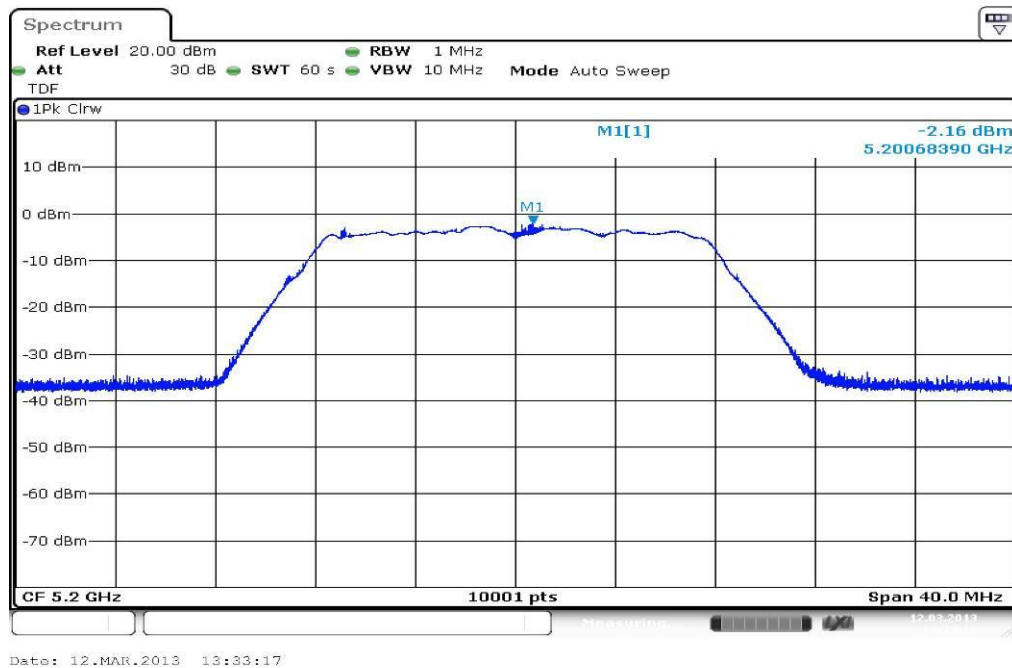

Plot 3: TX mode, highest channel



Date: 12.MAR.2013 18:40:14

Plots: OFDM, antenna port 2

Plot 1: TX mode, lowest channel



Plot 2: TX mode, middle channel

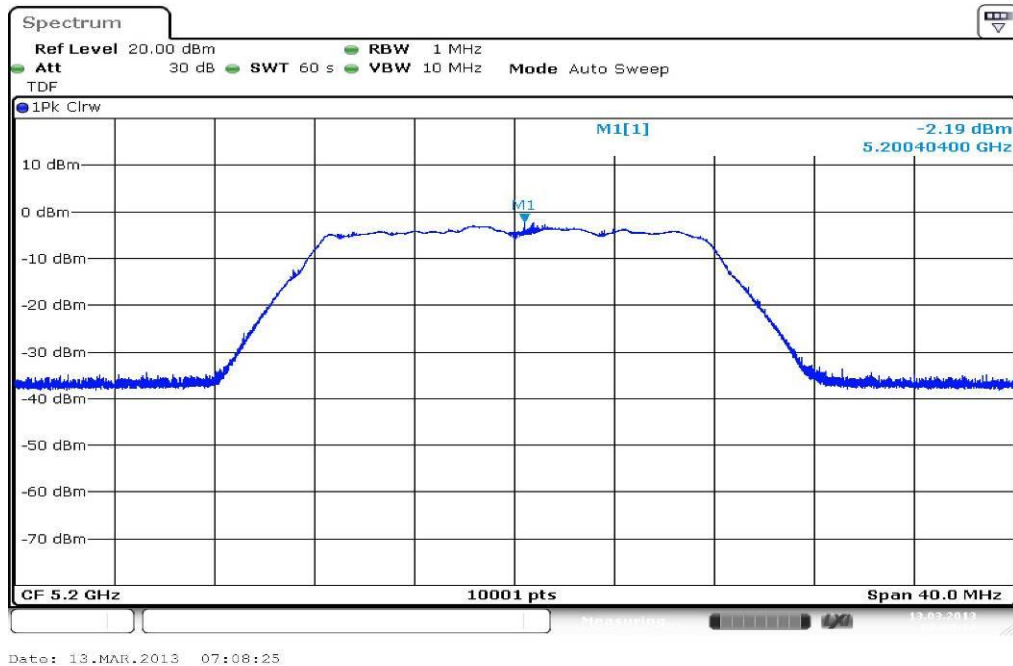

Plot 3: TX mode, highest channel

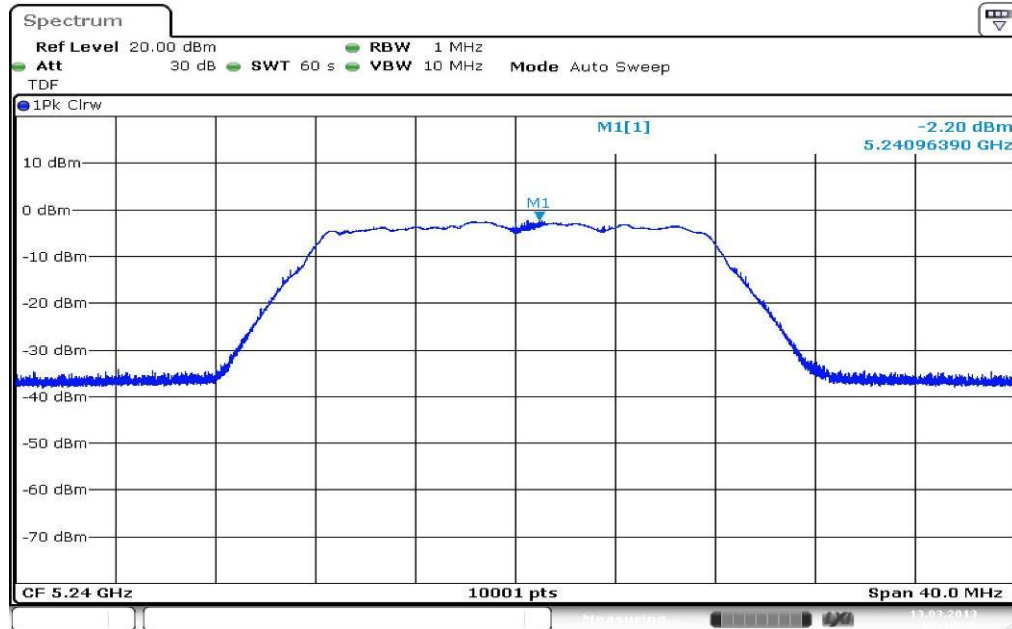

Date: 13.MAR.2013 07:18:46

9.7 Band edge compliance radiated

Description:

Measurement of the radiated band edge compliance. The EUT is turned in the position that results in the maximum level at the band edge. Then a sweep over the corresponding restricted band is performed. The EUT is set to the lowest channel for the lower restricted band and to the highest channel for the upper restricted band. Measurement distance is 3m.

Measurement:

Measurement parameter	
Detector:	Peak / RMS
Sweep time:	Auto
Resolution bandwidth:	1 MHz
Video bandwidth:	10 Hz / 1 MHz
Span:	See plots!
Trace-Mode:	Max Hold

Limits:

Band Edge Compliance Radiated
In any 100 kHz bandwidth outside the frequency band in which the spread spectrum or digitally modulated intentional radiator is operating, the radio frequency power that is produced by the intentional radiator shall be at least 20 dB below that in the 100 kHz bandwidth within the band that contains the highest level of the desired power, based on either an RF conducted or a radiated measurement. Attenuation below the general limits specified in Section 15.209(a) is not required. In addition, radiated emissions which fall in the restricted bands, as defined in Section 15.205(a), must also comply with the radiated emission limits specified in Section 15.209(a) (see Section 5.205(c)).
74 dB μ V/m PEAK 54 dB μ V/m AVG -27 dBm/MHz PEAK (acc. Part 15.407)

Result:

Scenario	Band Edge Compliance Radiated [dB μ V/m / dBm/MHz]
band edge	< 74 dB μ V/m (AVG) < 54 dB μ V/m (PEAK) or -27 dBm/MHz (PEAK)
Measurement uncertainty	\pm 3 dB

Plots:

Plot 1: lower band edge, vertical & horizontal polarization (ANT 1 & 2), channel 36

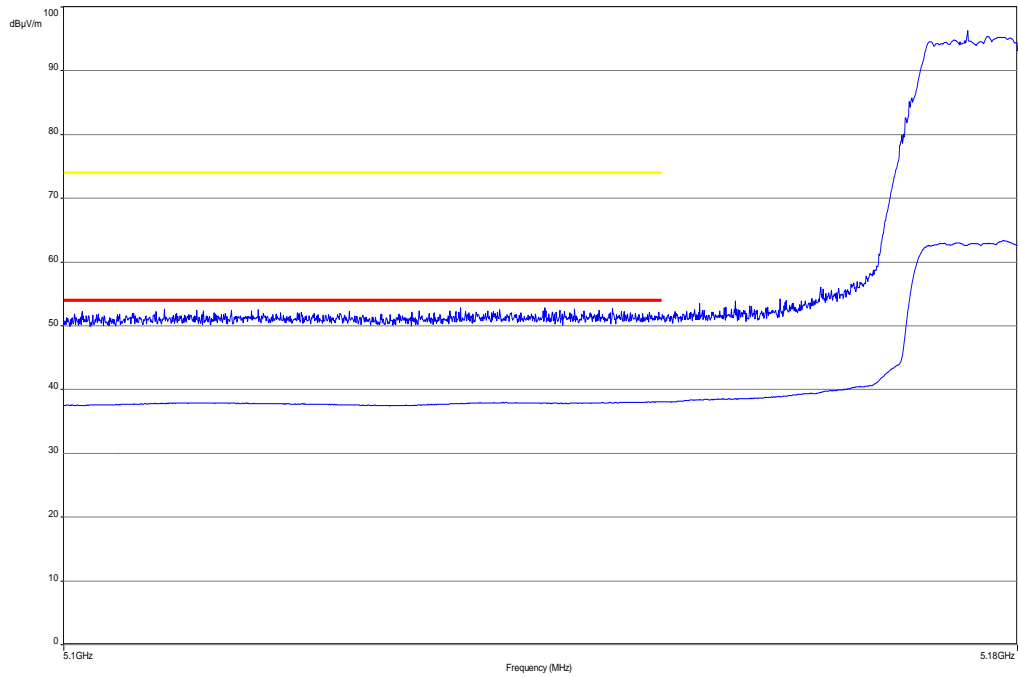

Plot 2: upper band edge, vertical & horizontal polarization (ANT 1 & 2), channel 48 (according Part 15.407)

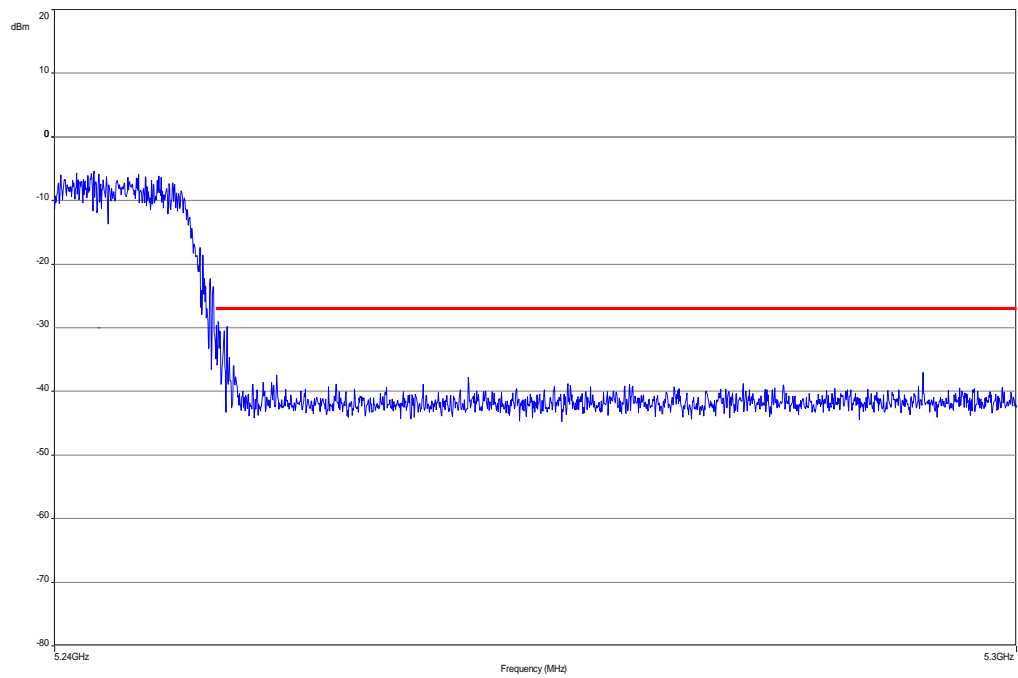

Result: Passed

9.8 TX spurious emissions radiated

Description:

Measurement of the radiated spurious emissions in transmit mode. The measurement is performed at lowest, middle and highest channel.

Measurement:

Measurement parameter	
Detector:	Quasi Peak below 1 GHz (alternative Peak) Peak above 1 GHz / RMS
Sweep time:	Auto
Resolution bandwidth:	F < 1 GHz: 100 kHz F > 1 GHz: 1 MHz
Video bandwidth:	F < 1 GHz: 100 kHz F > 1 GHz: ≥ 3 MHz /10 Hz
Span:	30 MHz to 40 GHz
Trace-Mode:	Max Hold / Average with 100 counts + 20 log (1 / X) for duty cycle lower than 100 %

Limits:

TX Spurious Emissions Radiated		
§15.209		
Frequency (MHz)	Field Strength (dBµV/m)	Measurement distance
30 - 88	30.0	10
88 – 216	33.5	10
216 – 960	36.0	10
Above 960	54.0	3
§15.407		
Outside the restricted bands!	-27 dBm / MHz	

Results: OFDM, antenna port 1

TX Spurious Emissions Radiated [dBµV/m] / dBm								
OFDM, antenna port 1								
Lowest 5180 MHz			Middle 5200 MHz			Highest 5240 MHz		
F [MHz]	Detector	Level [dBµV/m]	F [MHz]	Detector	Level [dBµV/m]	F [MHz]	Detector	Level [dBµV/m]
For emissions below 1 GHz, please take a look at the table below the 1 GHz plot.			For emissions below 1 GHz, please take a look at the table below the 1 GHz plot.			For emissions below 1 GHz, please take a look at the table below the 1 GHz plot.		
All detected peak emissions between 1 GHz and 12.75 GHz are more than 10 dB below the average limit.			All detected peak emissions between 1 GHz and 12.75 GHz are more than 10 dB below the average limit.			All detected peak emissions between 1 GHz and 12.75 GHz are more than 10 dB below the average limit.		
For emissions above 12.75 GHz, please take a look at the plots.			For emissions above 12.75 GHz, please take a look at the plots.			For emissions above 12.75 GHz, please take a look at the plots.		
Measurement uncertainty			± 3 dB					

Result: Passed

Results: OFDM, antenna port 2

TX Spurious Emissions Radiated [dBµV/m] / dBm								
OFDM, antenna port 2								
-/-			Middle 5200 MHz			-/-		
F [MHz]	Detector	Level [dBµV/m]	F [MHz]	Detector	Level [dBµV/m]	F [MHz]	Detector	Level [dBµV/m]
-/-			For emissions below 1 GHz, please take a look at the table below the 1 GHz plot.			-/-		
-/-			All detected peak emissions between 1 GHz and 12.75 GHz are more than 10 dB below the average limit.			-/-		
-/-			For emissions above 12.75 GHz, please take a look at the plots.			-/-		
Measurement uncertainty			± 3 dB					

Result: Passed

Note:

The long gooseneck is the worst case configuration of all different available microphones. These EUT configurations are added to see the behaviour of the EUT.

The antenna port 1 shows the same behaviour as antenna port 2 and is measured to see the fulfilment according to the FCC Part 15.407 standard.

Plots: OFDM, antenna port 1

Plot 1: 30 MHz to 1 GHz, 5180 MHz, vertical & horizontal polarization

Common Information

EUT: C1W
 Serial Number: prototype
 Test Description: FCC part 15 class B @ 10m
 Operating Conditions: TX 5180 MHz | long gooseneck microphone | Ant. 1
 Operator Name: Hennemann
 Comment: battery powered

Scan Setup: STAN_Fin [EMI radiated]

Hardware Setup: Electric Field (NOS)
 Receiver: [ESCI 3]
 Level Unit: dBµV/m

Subrange	Step Size	Detectors	IF BW	Meas. Time	Preamp
30 MHz - 2 GHz	60 kHz	QPK	120 kHz	1 s	20 dB

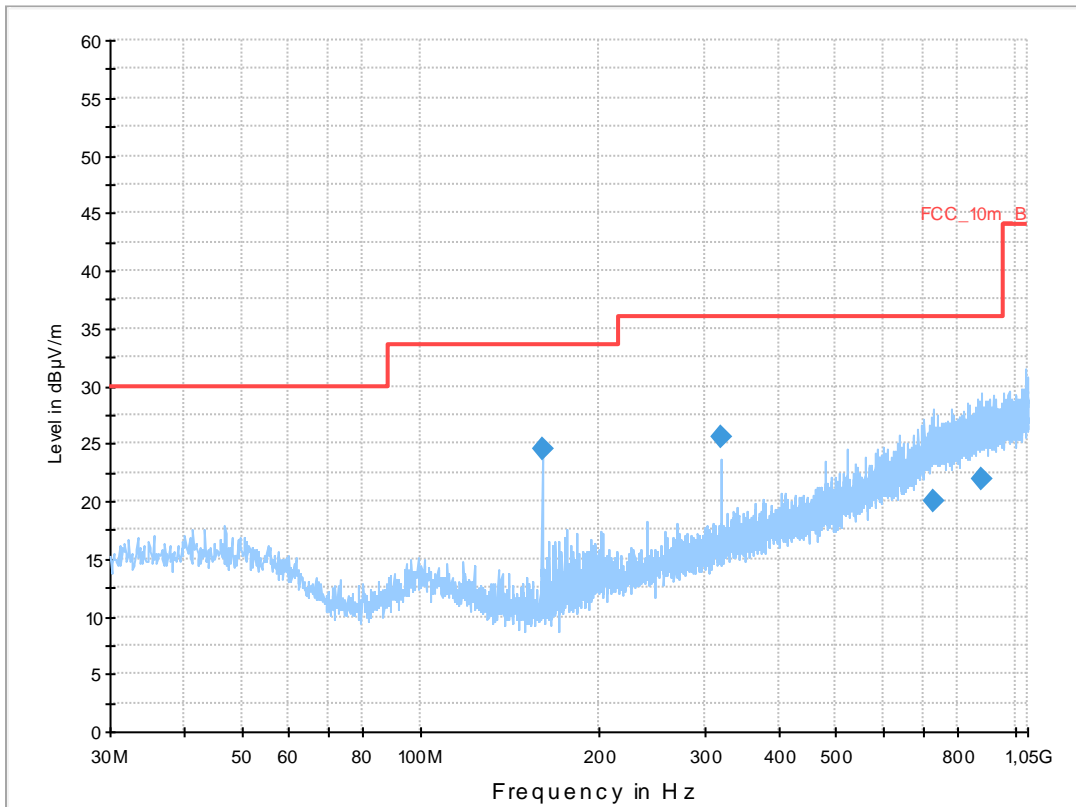

Final Result 1

Frequency (MHz)	QuasiPeak (dBµV/m)	Meas. Time (ms)	Bandwidth (kHz)	Height (cm)	Polarization	Azimuth (deg)	Corr. (dB)	Margin (dB)	Limit (dBµV/m)	Comment
160.011150	24.6	1000.0	120.000	120.0	V	10.0	9.2	8.9	33.5	
320.005650	25.5	1000.0	120.000	170.0	H	180.0	15.2	10.5	36.0	
728.929050	20.0	1000.0	120.000	170.0	V	-10.0	23.2	16.0	36.0	
876.691800	21.9	1000.0	120.000	170.0	V	-5.0	24.9	14.1	36.0	

Plot 2: 1 GHz to 12.75 GHz, 5180 MHz, vertical & horizontal polarization

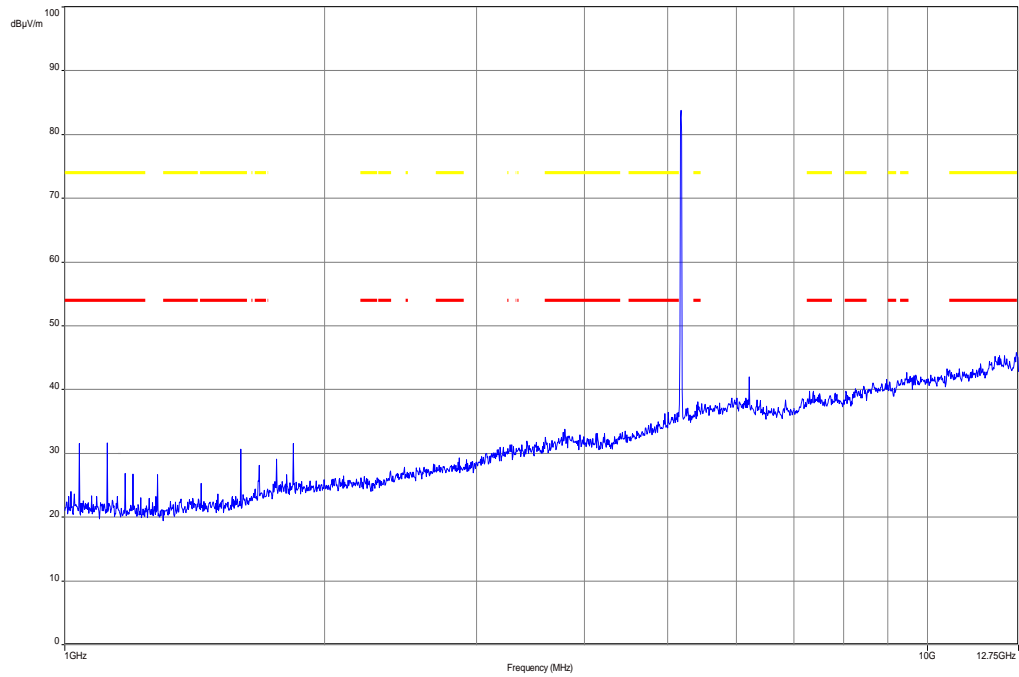

Plot 3: 12.75 GHz to 18 GHz, 5180 MHz, vertical & horizontal polarization

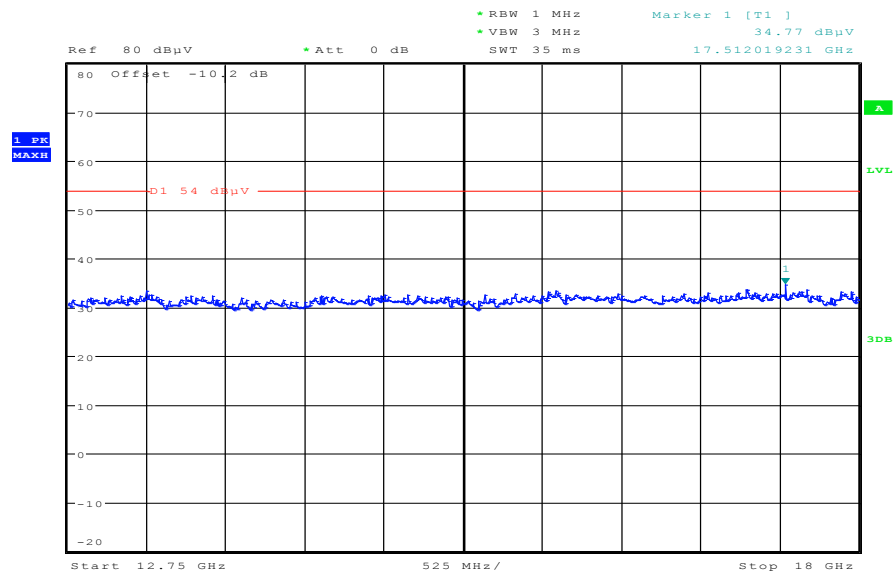

Date: 20.MAR.2013 09:55:19

Plot 4: 18 GHz to 26 GHz, 5180 MHz, vertical & horizontal polarization

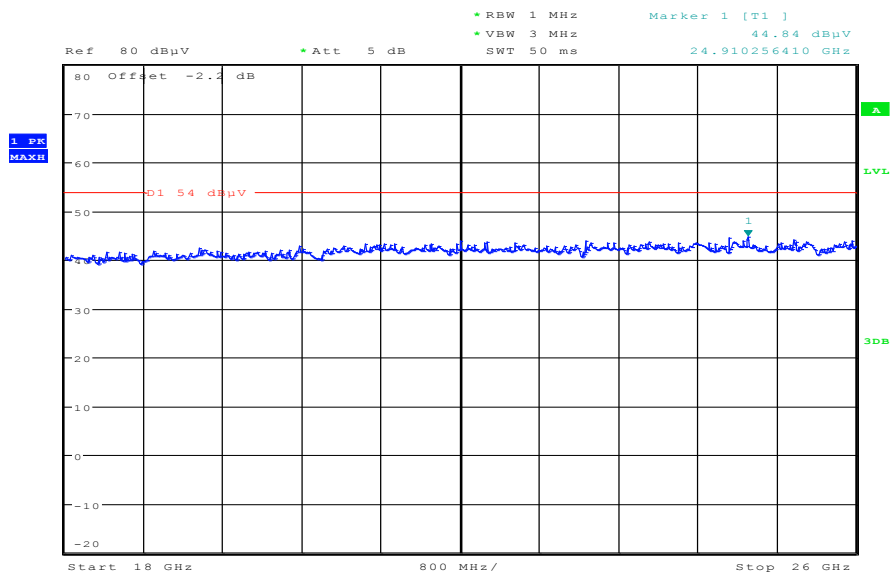

Date: 20.MAR.2013 10:22:18

Plot 5: 26 GHz to 40 GHz, 5180 MHz, vertical & horizontal polarization

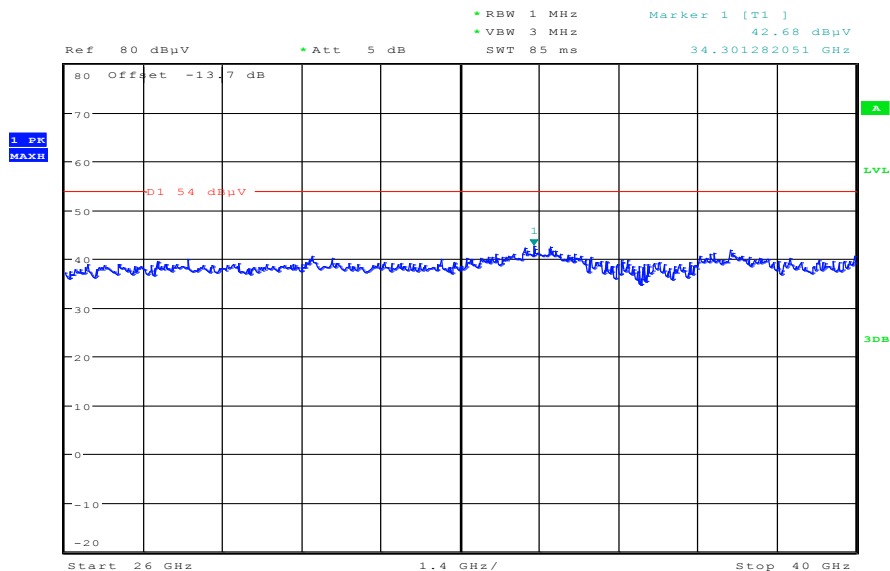

Date: 20.MAR.2013 10:39:00

Plot 6: 30 MHz to 1 GHz, 5200 MHz, vertical & horizontal polarization

Common Information

EUT: C1W
 Serial Number: prototype
 Test Description: FCC part 15 class B @ 10m
 Operating Conditions: TX 5200 MHz | long gooseneck microphone | Ant. 1
 Operator Name: Hennemann
 Comment: battery powered

Scan Setup: STAN_Fin [EMI radiated]

Hardware Setup: Electric Field (NOS)
 Receiver: [ESCI 3]
 Level Unit: dBµV/m

Subrange	Step Size	Detectors	IF BW	Meas. Time	Preamp
30 MHz - 2 GHz	60 kHz	QPK	120 kHz	1 s	20 dB

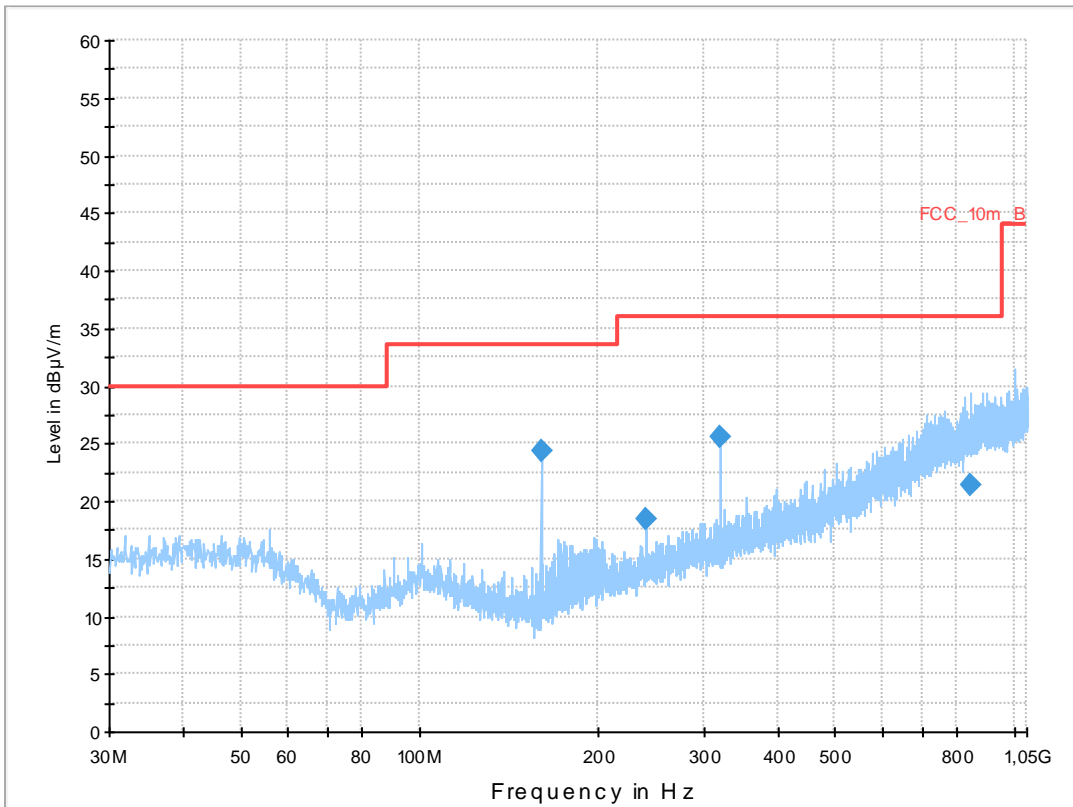

Final Result 1

Frequency (MHz)	QuasiPeak (dBµV/m)	Meas. Time (ms)	Bandwidth (kHz)	Height (cm)	Polarization	Azimuth (deg)	Corr. (dB)	Margin (dB)	Limit (dBµV/m)	Comment
159.998400	24.4	1000.0	120.000	98.0	V	81.0	9.2	9.1	33.5	
240.010500	18.4	1000.0	120.000	163.0	H	-3.0	13.0	17.6	36.0	
319.990650	25.6	1000.0	120.000	170.0	H	180.0	15.2	10.4	36.0	
844.212450	21.3	1000.0	120.000	170.0	V	190.0	24.5	14.7	36.0	

Plot 7: 1 GHz to 12.75 GHz, 5200 MHz, vertical & horizontal polarization

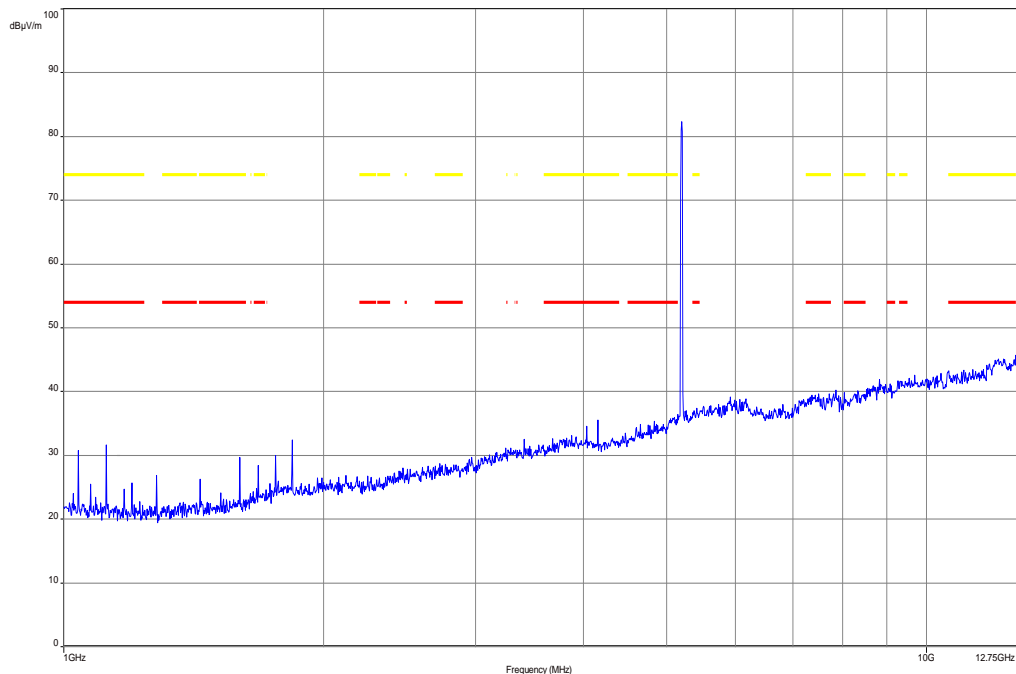

Plot 8: 12.75 GHz to 18 GHz, 5200 MHz, vertical & horizontal polarization

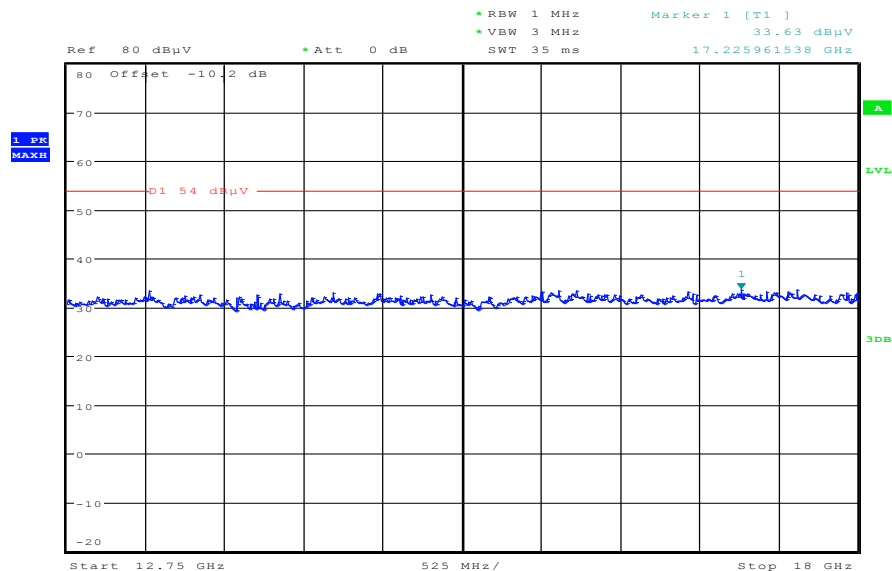

Date: 20.MAR.2013 09:57:35

Plot 9: 18 GHz to 26 GHz, 5200 MHz, vertical & horizontal polarization

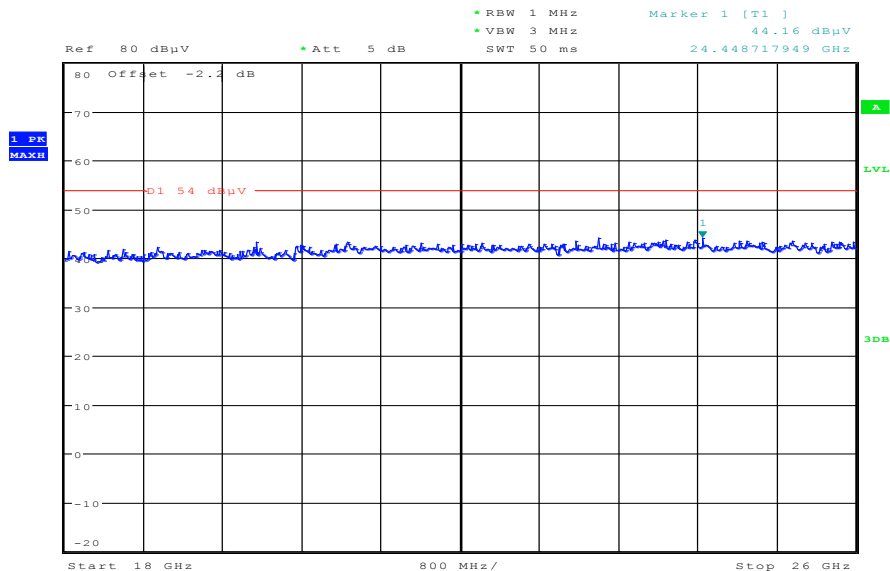

Date: 20.MAR.2013 10:23:00

Plot 10: 26 GHz to 40 GHz, 5200 MHz, vertical & horizontal polarization

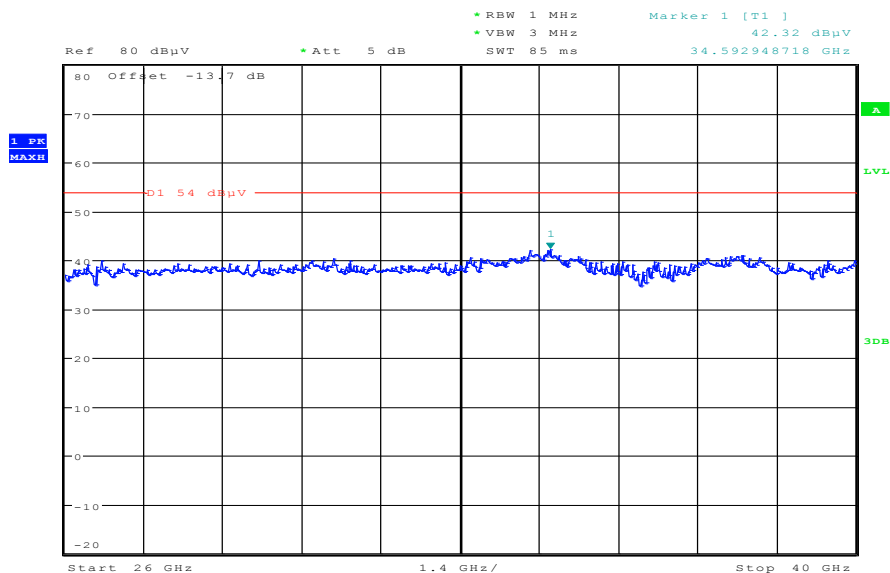

Date: 20.MAR.2013 10:39:50

Plot 11: 30 MHz to 1 GHz, 5240 MHz, vertical & horizontal polarization

Common Information

EUT: C1W
 Serial Number: prototype
 Test Description: FCC part 15 class B @ 10m
 Operating Conditions: TX 5240 MHz | long gooseneck microphone | Ant. 1
 Operator Name: Hennemann
 Comment: battery powered

Scan Setup: STAN_Fin [EMI radiated]

Hardware Setup: Electric Field (NOS)
 Receiver: [ESCI 3]
 Level Unit: dBµV/m

Subrange	Step Size	Detectors	IF BW	Meas. Time	Preamp
30 MHz - 2 GHz	60 kHz	QPK	120 kHz	1 s	20 dB

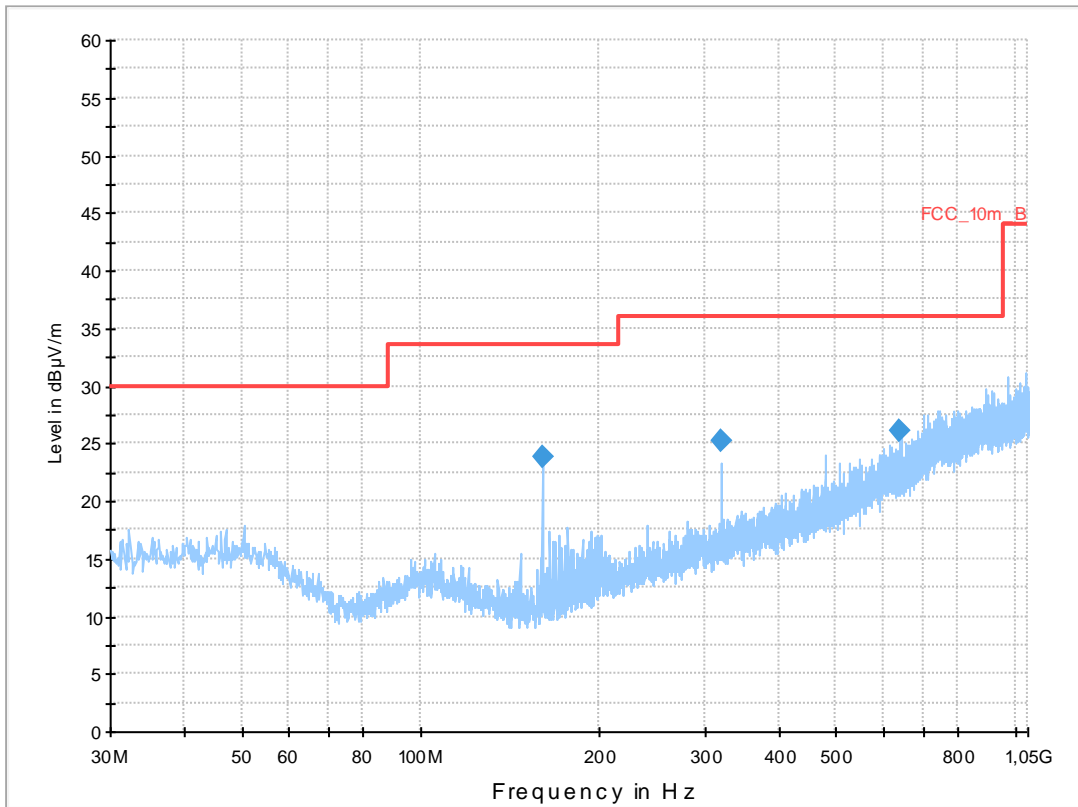

Final Result 1

Frequency (MHz)	QuasiPeak (dBµV/m)	Meas. Time (ms)	Bandwidth (kHz)	Height (cm)	Polarization	Azimuth (deg)	Corr. (dB)	Margin (dB)	Limit (dBµV/m)	Comment
160.021350	23.8	1000.0	120.000	104.0	V	10.0	9.2	9.7	33.5	
320.020650	25.1	1000.0	120.000	170.0	H	182.0	15.2	10.9	36.0	
640.000050	26.0	1000.0	120.000	170.0	H	100.0	21.0	10.0	36.0	

Plot 12: 1 GHz to 12.75 GHz, 5240 MHz, vertical & horizontal polarization

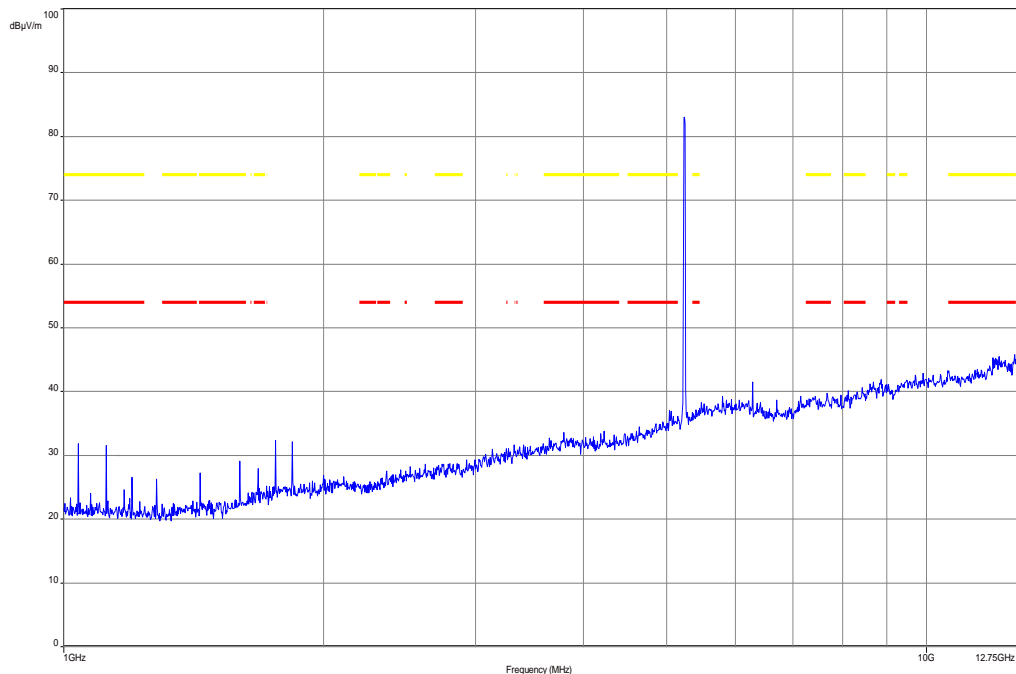

Plot 13: 12.75 GHz to 18 GHz, 5240 MHz, vertical & horizontal polarization

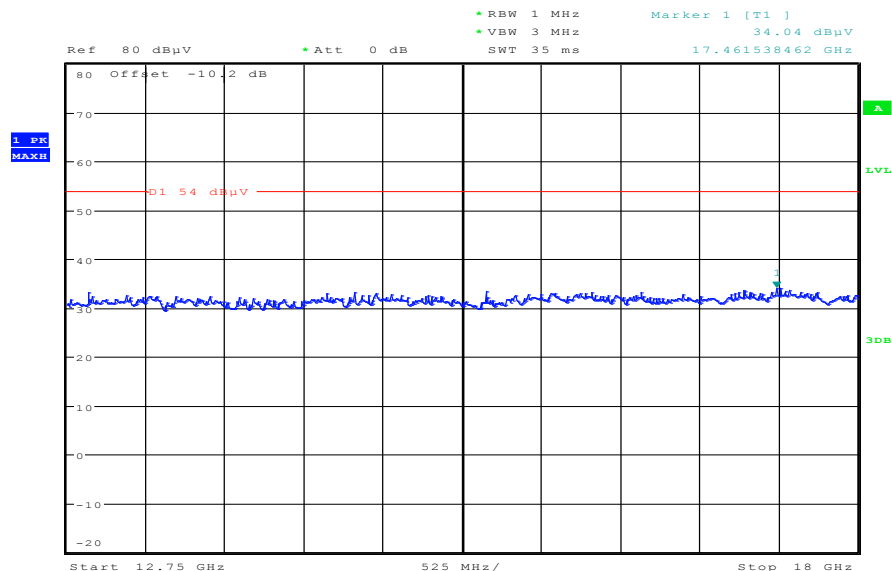

Date: 20.MAR.2013 09:59:10

Plot 14: 18 GHz to 26 GHz, 5240 MHz, vertical & horizontal polarization

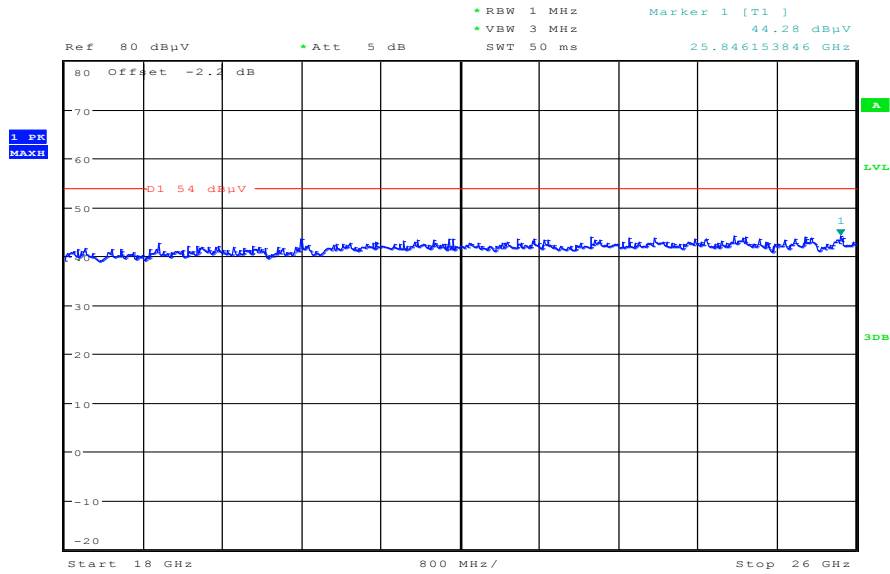

Date: 20.MAR.2013 10:23:43

Plot 15: 26 GHz to 40 GHz, 5240 MHz, vertical & horizontal polarization

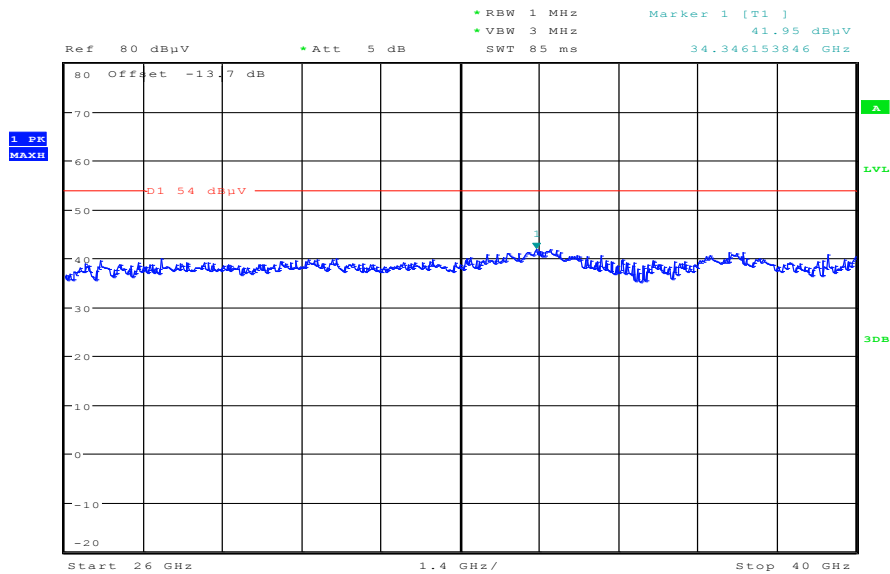

Date: 20.MAR.2013 10:40:46

Plots: OFDM, antenna port 2

Plot 16: 30 MHz to 1 GHz, 5200 MHz, vertical & horizontal polarization

Common Information

EUT: C1W
 Serial Number: prototype
 Test Description: FCC part 15 class B @ 10m
 Operating Conditions: TX 5200 MHz | long gooseneck microphone | Ant. 2
 Operator Name: Hennemann
 Comment: battery powered

Scan Setup: STAN_Fin [EMI radiated]

Hardware Setup: Electric Field (NOS)
 Receiver: [ESCI 3]
 Level Unit: dBµV/m

Subrange	Step Size	Detectors	IF BW	Meas. Time	Preamp
30 MHz - 2 GHz	60 kHz	QPK	120 kHz	1 s	20 dB

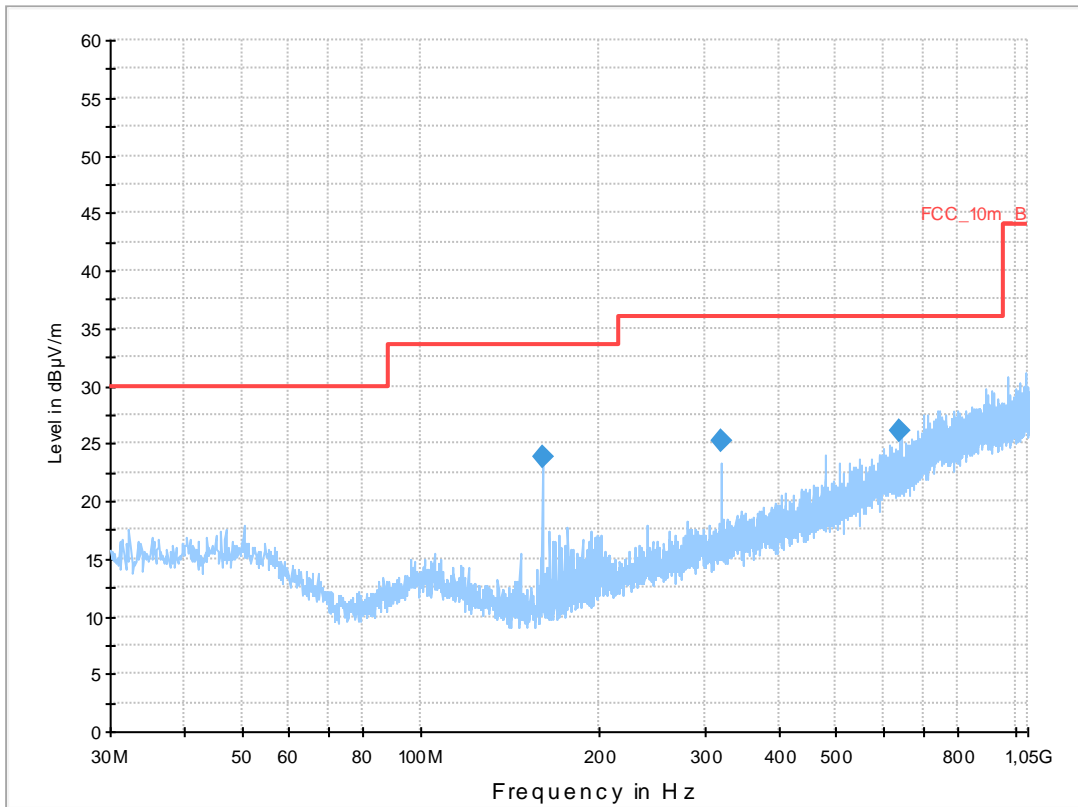

Final Result 1

Frequency (MHz)	QuasiPeak (dBµV/m)	Meas. Time (ms)	Bandwidth (kHz)	Height (cm)	Polarization	Azimuth (deg)	Corr. (dB)	Margin (dB)	Limit (dBµV/m)	Comment
160.021350	23.8	1000.0	120.000	104.0	V	10.0	9.2	9.7	33.5	
320.020650	25.1	1000.0	120.000	170.0	H	182.0	15.2	10.9	36.0	
640.000050	26.0	1000.0	120.000	170.0	H	100.0	21.0	10.0	36.0	

Plot 17: 1 GHz to 12.75 GHz, 5200 MHz, vertical & horizontal polarization

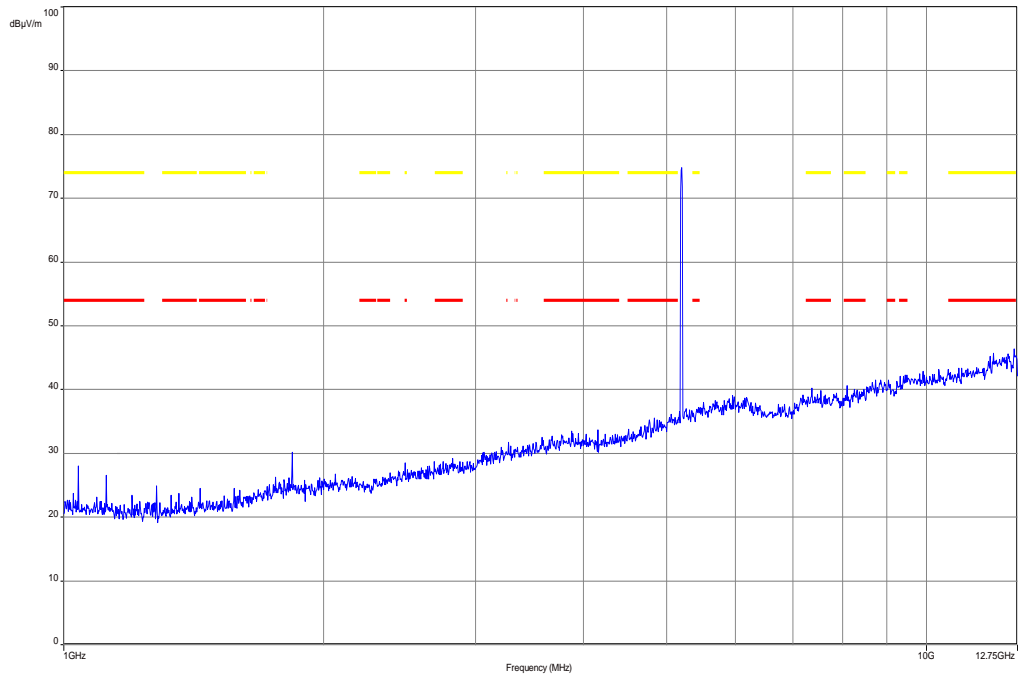

Plot 18: 12.75 GHz to 18 GHz, 5200 MHz, vertical & horizontal polarization

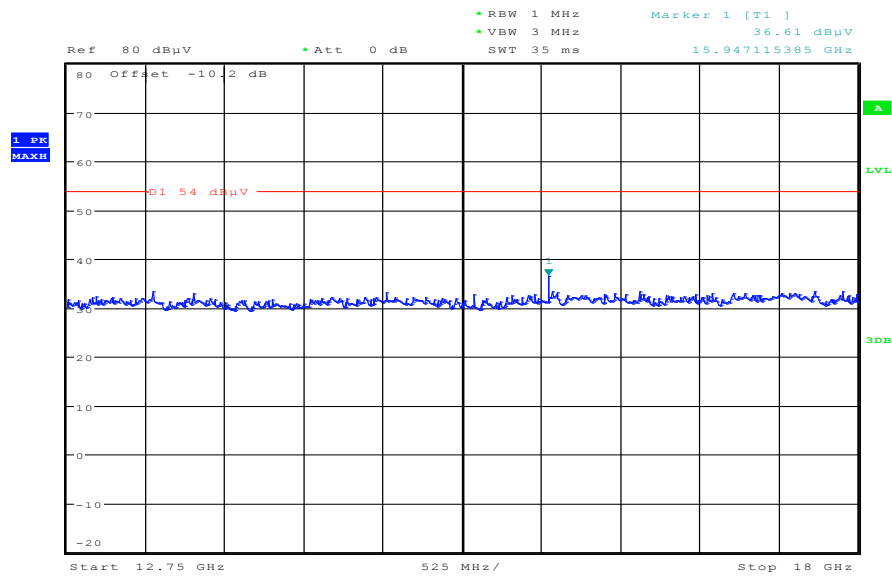

Date: 20.MAR.2013 10:07:02

Plot 19: 18 GHz to 26 GHz, 5200 MHz, vertical & horizontal polarization

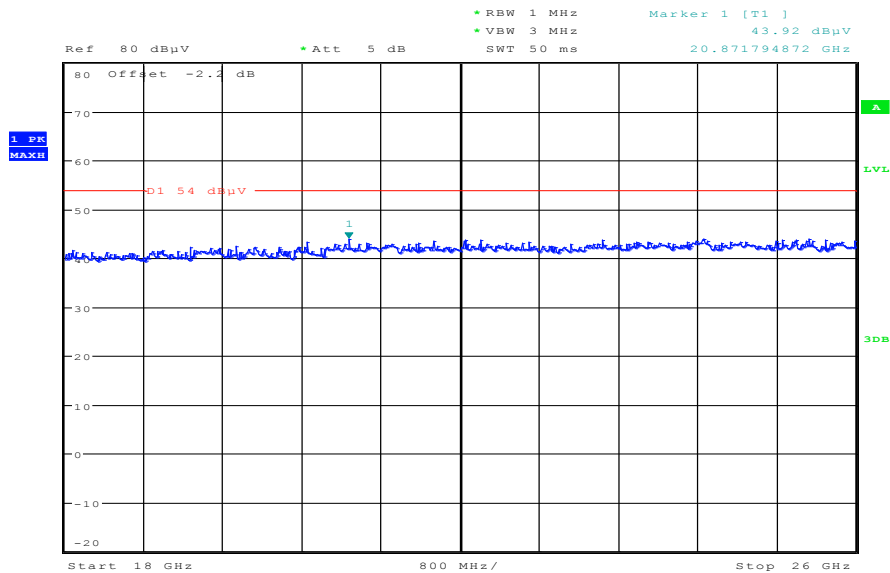

Date: 20.MAR.2013 10:28:50

Plot 20: 26 GHz to 40 GHz, 5200 MHz, vertical & horizontal polarization

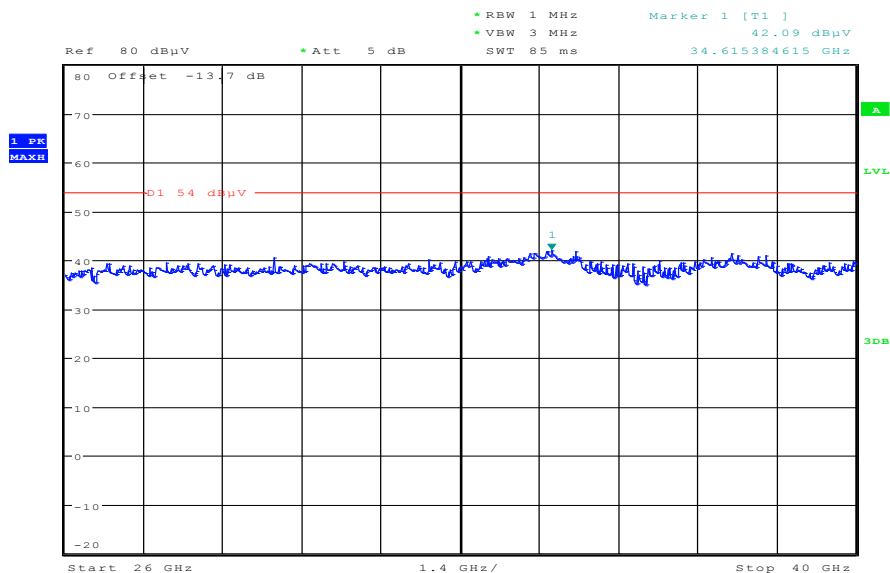

Date: 20.MAR.2013 10:44:39

9.9 RX spurious emissions radiated

Description:

Measurement of the radiated spurious emissions in idle/receive mode.

Measurement:

Measurement parameter	
Detector:	Quasi Peak below 1 GHz (alternative Peak) Peak above 1 GHz / RMS
Sweep time:	Auto
Resolution bandwidth:	F < 1 GHz: 100 kHz F > 1 GHz: 1 MHz
Video bandwidth:	F < 1 GHz: 100 kHz F > 1 GHz: ≥ 3 MHz / 10 Hz
Span:	30 MHz to 40 GHz
Trace-Mode:	Max Hold / Average with 100 counts + 20 log (1 / X) for duty cycle lower than 100 %

Limits:

RX Spurious Emissions Radiated		
Frequency (MHz)	Field Strength (dB μ V/m)	Measurement distance
30 - 88	30.0	10
88 – 216	33.5	10
216 – 960	36.0	10
Above 960	54.0	3

Results:

RX Spurious Emissions Radiated [dB μ V/m]		
F [MHz]	Detector	Level [dB μ V/m]
For emissions below 1 GHz, please take a look at the table below the 1 GHz plot.		
All detected peak emissions between 1 GHz and 12.75 GHz are more than 10 dB below the average limit.		
For emissions above 12.75 GHz, please take a look at the plots.		
Measurement uncertainty	± 3 dB	

Result: Passed

Plots: RX / Idle – mode

Plot 1: 30 MHz to 1 GHz, vertical & horizontal polarization

Common Information

EUT: C1W
 Serial Number: prototype
 Test Description: FCC part 15 class B @ 10m
 Operating Conditions: RX | long gooseneck microphone | Ant. 1
 Operator Name: Hennemann
 Comment: battery powered

Scan Setup: STAN_Fin [EMI radiated]

Hardware Setup: Electric Field (NOS)
 Receiver: [ESCI 3]
 Level Unit: dBµV/m

Subrange	Step Size	Detectors	IF BW	Meas. Time	Preamp
30 MHz - 2 GHz	60 kHz	QPK	120 kHz	1 s	20 dB

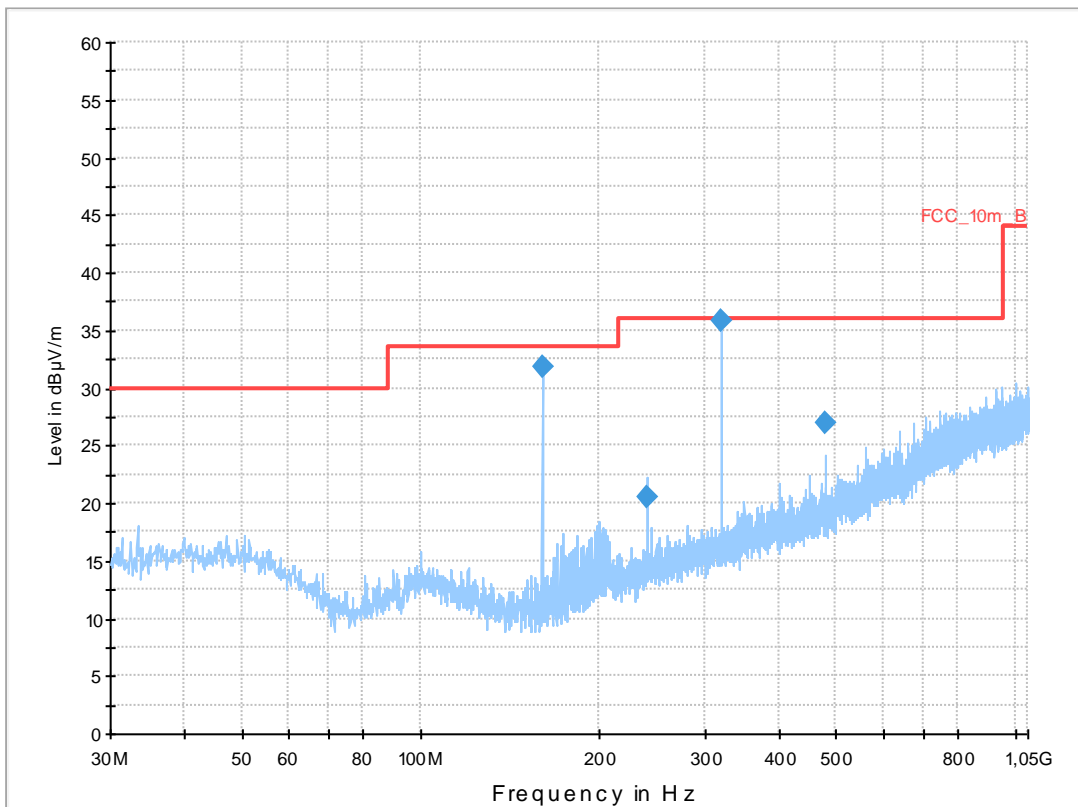

Final Result 1

Frequency (MHz)	QuasiPeak (dBµV/m)	Meas. Time (ms)	Bandwidth (kHz)	Height (cm)	Polarization	Azimuth (deg)	Corr. (dB)	Margin (dB)	Limit (dBµV/m)	Comment
159.999900	31.8	1000.0	120.000	98.0	V	-5.0	9.2	1.7	33.5	
240.034350	20.5	1000.0	120.000	98.0	V	87.0	13.0	15.5	36.0	
319.997400	35.8	1000.0	120.000	170.0	H	10.0	15.2	0.2	36.0	
479.984400	26.9	1000.0	120.000	170.0	H	260.0	18.3	9.1	36.0	

Plot 2: 1 GHz to 12.75 GHz, vertical & horizontal polarization

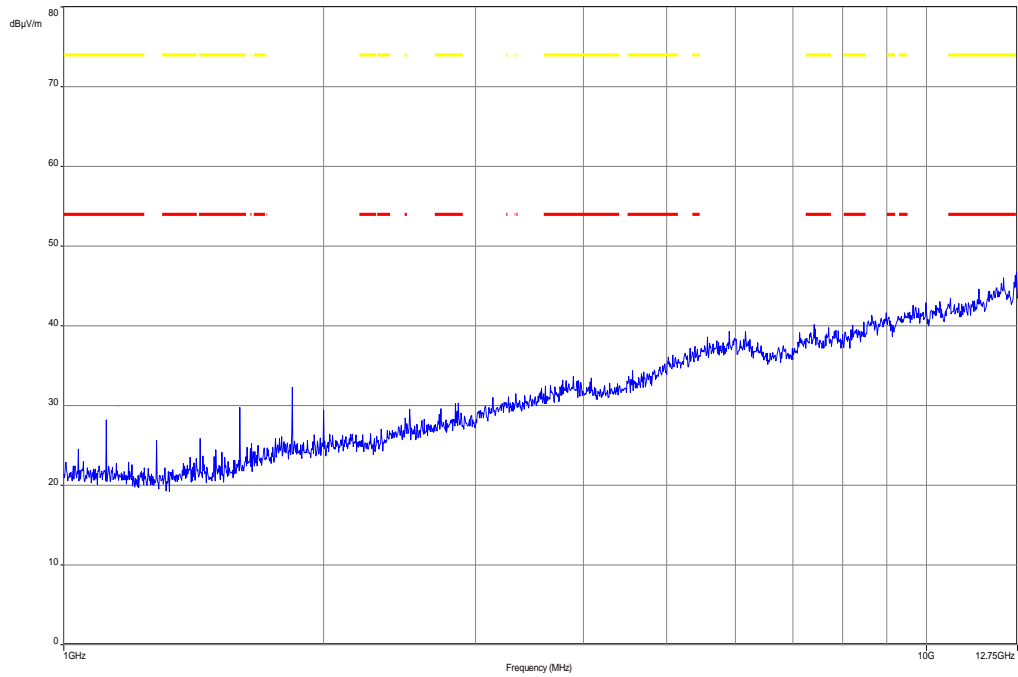

Plot 3: 12.75 GHz to 18 GHz, vertical & horizontal polarization

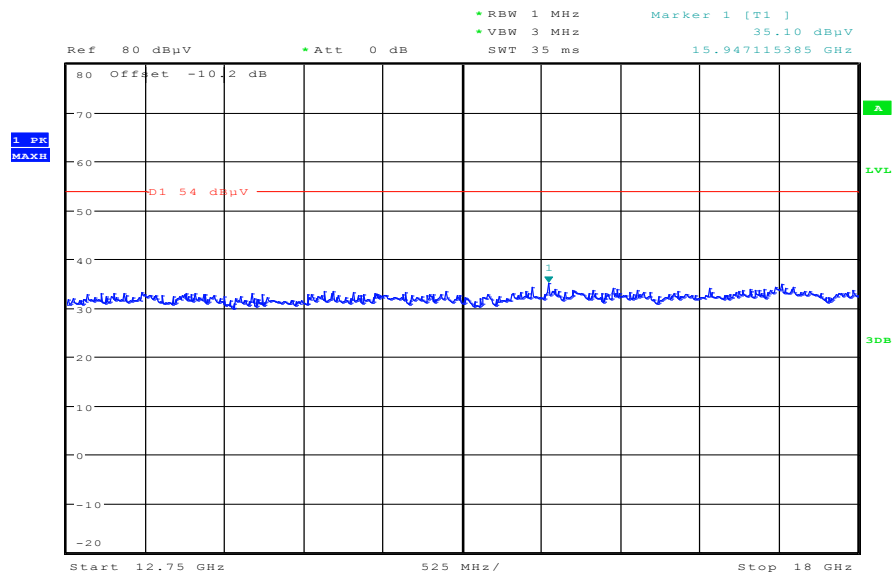

Date: 20.MAR.2013 10:53:28

Plot 4: 18 GHz to 26 GHz, vertical & horizontal polarization

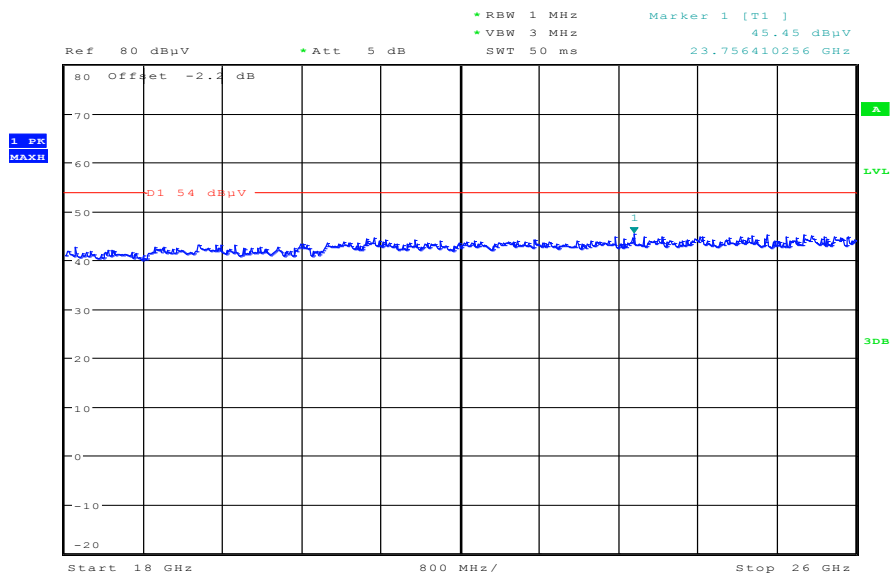

Date: 20.MAR.2013 10:51:54

Plot 5: 26 GHz to 40 GHz, vertical & horizontal polarization

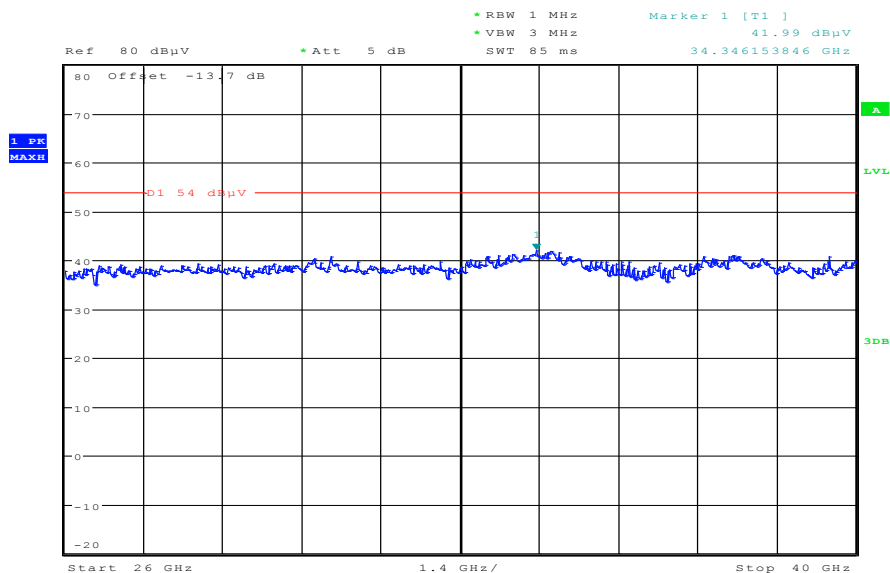

Date: 20.MAR.2013 10:47:29

9.10 Spurious emissions radiated < 30 MHz

Description:

Measurement of the radiated spurious emissions in transmit mode and receive mode below 30 MHz. The EUT is set first to middle channel. This measurement is representative for all channels and modes. If critical peaks are found the lowest channel and the highest channel will be measured too. Then the EUT is set to receive or idle mode. The limits are recalculated to a measurement distance of 3 m with 40 dB/decade according CFR Part 2.

Measurement:

Measurement parameter	
Detector:	Peak / Quasi Peak
Sweep time:	Auto
Video bandwidth:	F < 150 kHz: 200 Hz F > 150 kHz: 9 kHz
Resolution bandwidth:	F < 150 kHz: 1 kHz F > 150 kHz: 100 kHz
Span:	9 kHz to 30 MHz
Trace-Mode:	Max Hold

Limits:

Spurious Emissions Radiated < 30 MHz		
Frequency (MHz)	Field Strength (dB μ V/m)	Measurement distance
0.009 – 0.490	2400/F(kHz)	300
0.490 – 1.705	24000/F(kHz)	30
1.705 – 30.0	30	30

Results:

Spurious Emissions Radiated < 30 MHz [dB μ V/m]		
F [MHz]	Detector	Level [dB μ V/m]
No peaks found.		
Measurement uncertainty	± 3 dB	

Result: Passed

Plots:

Plot 1: 9 kHz to 30 MHz, TX mode

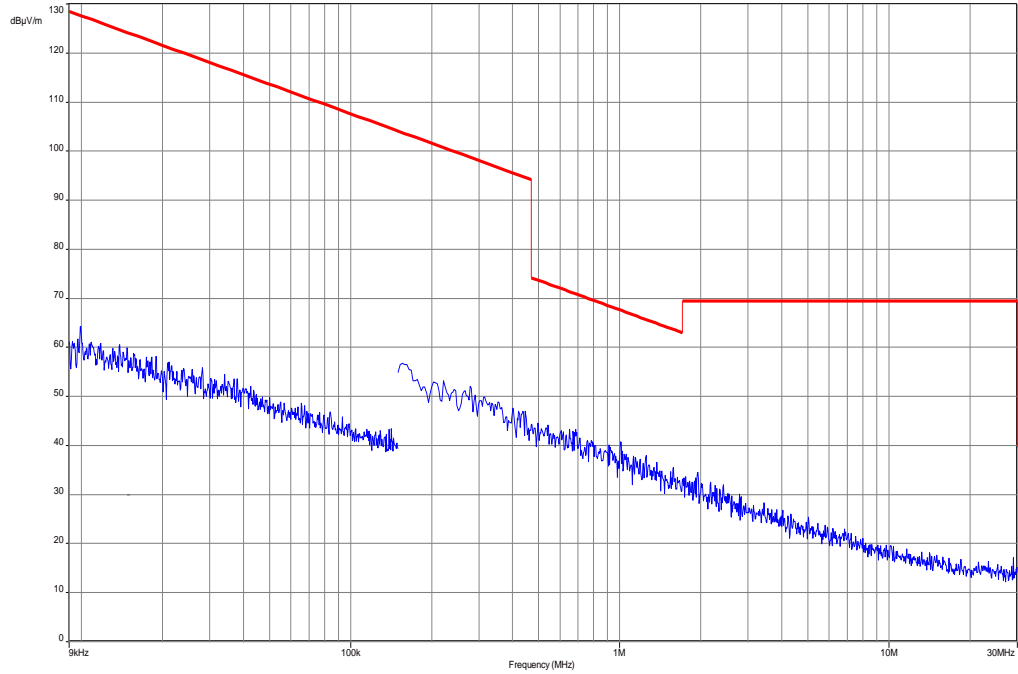

Plot 2: 9 kHz to 30 MHz, RX mode

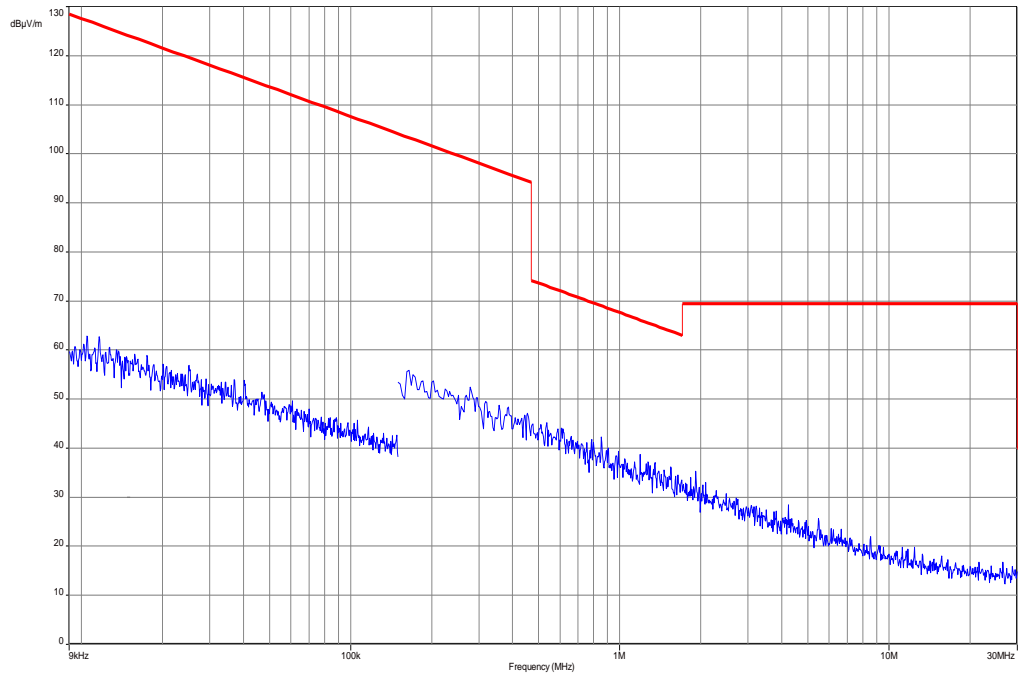

9.11 Spurious emissions conducted < 30 MHz

Description:

Measurement of the conducted spurious emissions in transmit mode below 30 MHz. The EUT is set to middle channel. If critical peaks are found the lowest channel and the highest channel will be measured too. Both power lines, phase and neutral line, are measured. Found peaks are remeasured with average and quasi peak detection to show compliance to the limits.

Measurement:

Measurement parameter	
Detector:	Peak - Quasi Peak / Average
Sweep time:	Auto
Video bandwidth:	F > 150 kHz: 9 kHz
Resolution bandwidth:	F > 150 kHz: 100 kHz
Span:	150 kHz to 30 MHz
Trace-Mode:	Max Hold

Limits:

Spurious Emissions Conducted < 30 MHz		
Frequency (MHz)	Quasi-Peak (dBµV/m)	Average (dBµV/m)
0.15 – 0.5	66 to 56*	56 to 46*
0.5 – 5	56	46
5 – 30.0	60	50

*Decreases with the logarithm of the frequency

Results:

Spurious Emissions Conducted < 30 MHz [dBµV/m]		
F [MHz]	Detector	Level [dBµV/m]
All detected peak values are below the average limits.		
Measurement uncertainty	± 3 dB	

Result: Passed

Plots:

Plot 1: 150 kHz to 30 MHz / phase line, TX mode

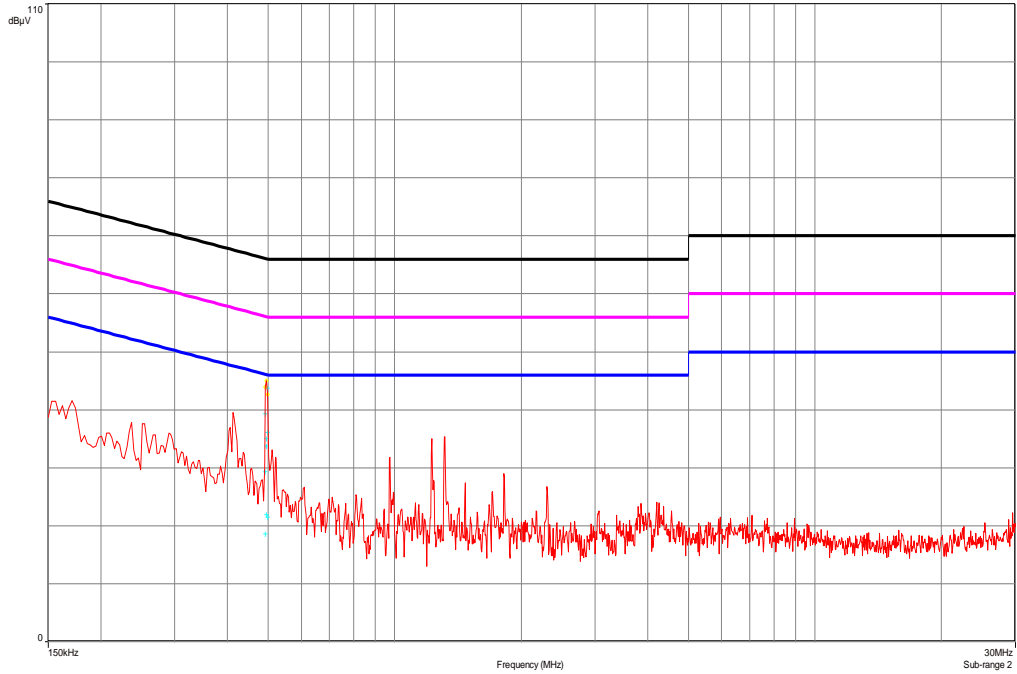

Plot 2: 150 kHz to 30 MHz / phase line, TX mode, zoomed

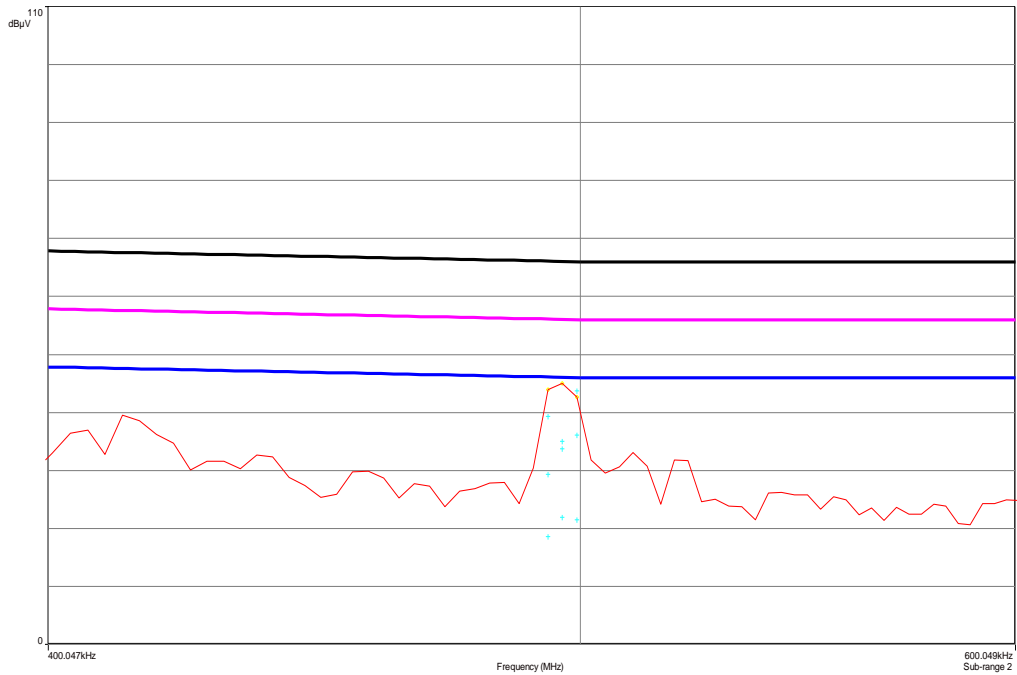

Plot 3: 150 kHz to 30 MHz / neutral line, TX mode

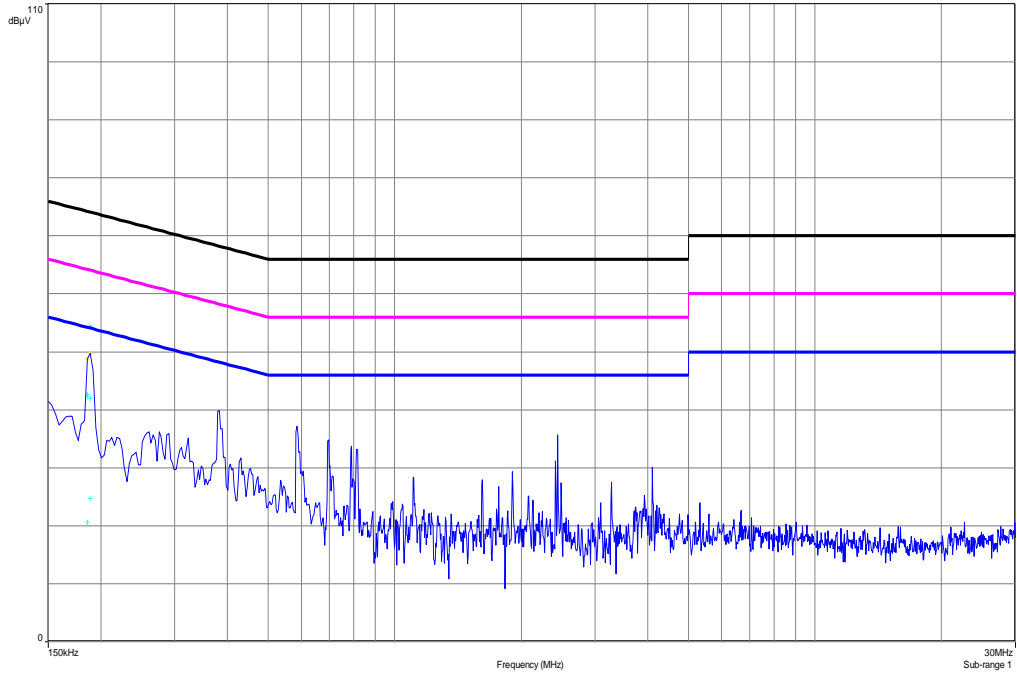

Plot 4: 150 kHz to 30 MHz / neutral line, TX mode, zoomed

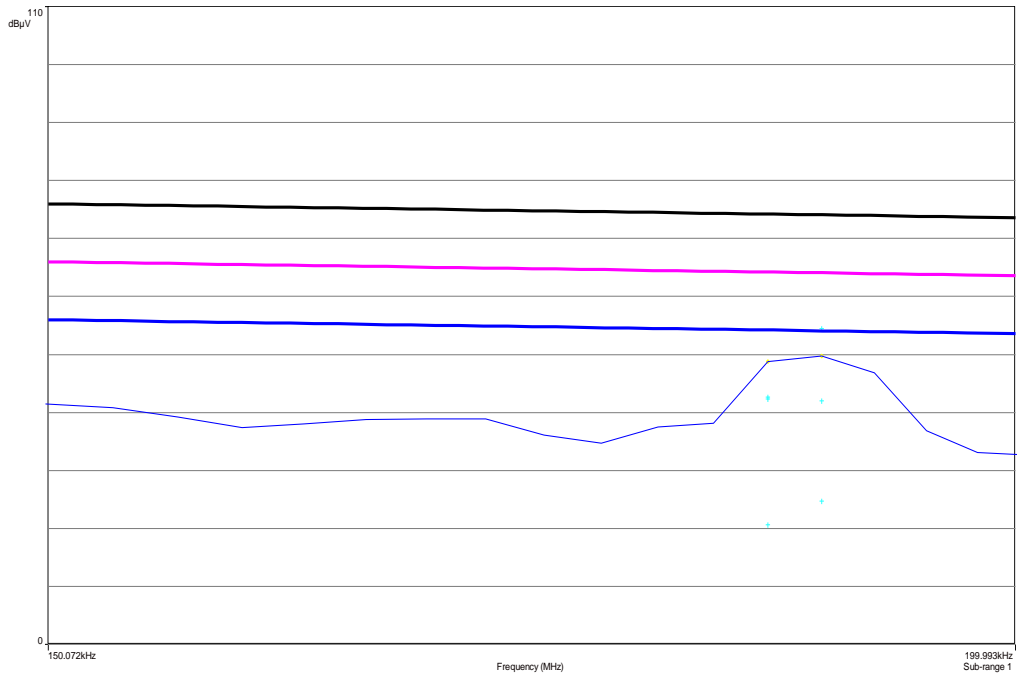

Plot 5: 150 kHz to 30 MHz / phase line, RX mode

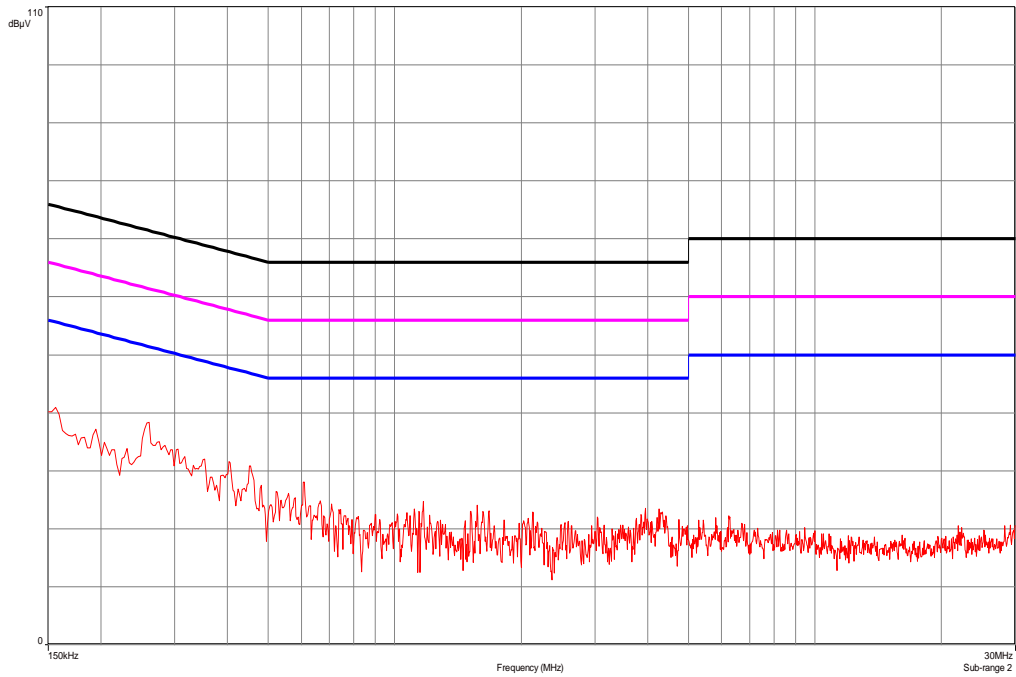

Plot 6: 150 kHz to 30 MHz / neutral line, RX mode

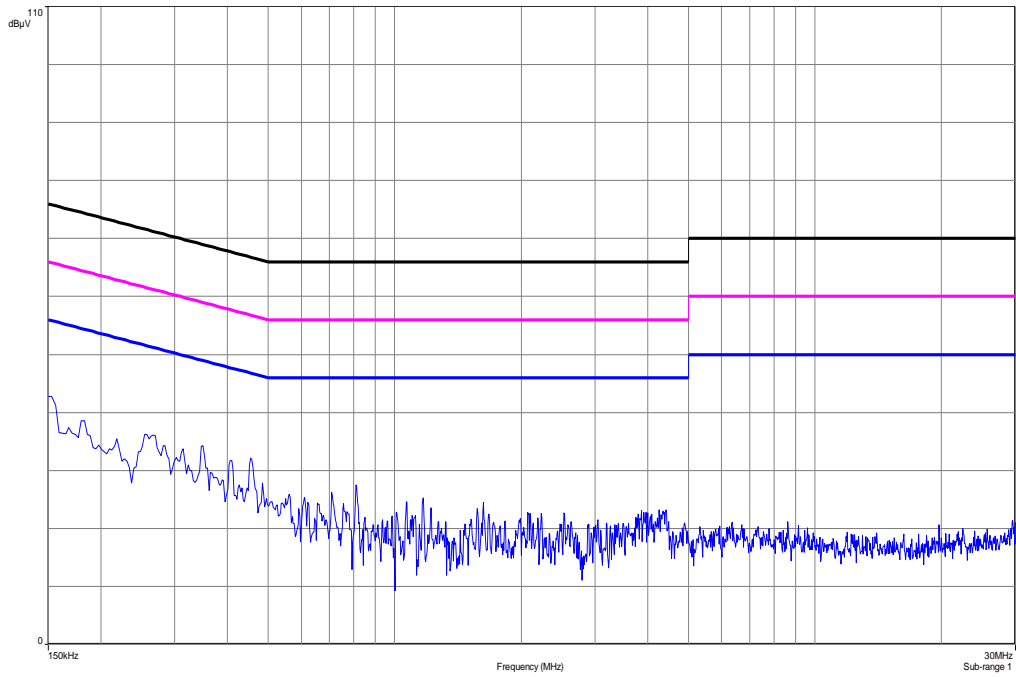

10 Test equipment and ancillaries used for tests

Typically, the calibrations of the test apparatus are commissioned to and performed by an accredited calibration laboratory. The calibration intervals are determined in accordance with the DIN EN ISO/IEC 17025. In addition to the external calibrations, the laboratory executes comparison measurements with other calibrated test systems or effective verifications. Weekly chamber inspections and range calibrations are performed. Where possible, rf-generating and signalling equipment as well as measuring receivers and analyzers are connected to an external high-precision 10 MHz reference (GPS-based or rubidium frequency standard).

In order to simplify the identification of the equipment used at some special tests, some items of test equipment and ancillaries can be provided with an identifier or number in the equipment list below (Labor/Item).

No.	Lab / Item	Equipment	Type	Manufact.	Serial No.	INV. No Cetecom	Kind of Calibration	Last Calibration	Next Calibration
1	45	Switch-Unit	3488A	HP Meßtechnik	2719A14505	300000368	g		
2	50	DC power supply, 60Vdc, 50A, 1200 W	6032A	HP Meßtechnik	2920A04466	300000580	ne		
3	n. a.	software	SPS_PHE 1.4f	Spitzberger & Spieß	B5981; 5D1081;B597 9	300000210	ne		
4	n. a.	EMI Test Receiver	ESCI 3	R&S	100083	300003312	k	09.01.2013	09.01.2014
5	n. a.	Analyzer- Reference- System (Harmonics and Flicker)	ARS 16/1	SPS	A3509 07/0 0205	300003314	k	14.07.2011	14.07.2013
6	n. a.	Amplifier	JS42- 00502650- 28-5A	MITEQ	1084532	300003379	ev		
7	n. a.	Antenna Tower	Model 2175	ETS- LINDGREN	64762	300003745	izw		
8	n. a.	Positioning Controller	Model 2090	ETS- LINDGREN	64672	300003746	izw		
9	n. a.	Turntable Interface-Box	Model 105637	ETS- LINDGREN	44583	300003747	izw		
10	n. a.	TRILOG Broadband Test-Antenna 30 MHz - 3 GHz	VULB9163	Schwarzbe ck	295	300003787	k	12.04.2012	12.04.2014
11	n. a.	Spectrum- Analyzer	FSU26	R&S	200809	300003874	k	16.01.2013	16.01.2015
12	n. a.	DC power supply, 60Vdc, 50A, 1200 W	6032A	HP Meßtechnik	2818A03450	300001040	Ve	12.01.2012	12.01.2015
13	n. a.	Double-Ridged Waveguide Horn Antenna 1-18.0GHz	3115	EMCO	8812-3088	300001032	viKI!	11.05.2011	11.05.2013
14	n. a.	Active Loop Antenna	6502	EMCO	2210	300001015	ne		
15	n. a.	Anechoic chamber	FAC 3/5m	MWB / TDK	87400/02	300000996	ev		
16	9	Isolating Transformer	MPL IEC625 Bus Regeltrennt ravo	Erfi	91350	300001155	ne		
17	n. a.	Three-Way Power Splitter, 50 Ohm	11850C	HP Meßtechnik		300000997	ne		
18	n. a.	Amplifier	js42- 00502650- 28-5a	Parzich GMBH	928979	300003143	ne		
19	n. a.	TRILOG Broadband Test-Antenna 30 MHz - 3 GHz	VULB9163	Schwarzbe ck	371	300003854	viKI!	14.10.2011	14.10.2014
20	n. a.	MXE EMI Receiver 20 Hz bis 26,5 GHz	N9038A	Agilent Technologi es	MY51210197	300004405	k	21.02.2013	21.02.2014
21	11b	Microwave System Amplifier, 0.5- 26.5 GHz	83017A	HP Meßtechnik	00419	300002268	ev		

22	A025	Std. Gain Horn Antenna 12.4 to 18.0 GHz	639	Narda		300000786	ne		
23	A027	Std. Gain Horn Antenna 18.0 to 26.5 GHz	638	Narda		300000486	ne		
24	n. a.	Std. Gain Horn Antenna 26.5-40.0 GHz	V637	Narda	7911	300001752	ne		
25	n. a.	Spectrum Analyzer 20 Hz - 50 GHz	FSU50	R&S	200012	300003443	Ve	09.10.2012	09.10.2014
26	n. a.	Broadband Low Noise Amplifier 18-50 GHz	CBL18503 070-XX	CERNEX	19338	300004273	ne		
27	n. a.	Signal Analyzer 40 GHz	FSV40	R&S	101042	300004517	k	22.10.2012	22.10.2013

Agenda: Kind of Calibration

k	calibration / calibrated	EK	limited calibration
ne	not required (k, ev, izw, zw not required)	zw	cyclical maintenance (external cyclical maintenance)
ev	periodic self verification	izw	internal cyclical maintenance
Ve	long-term stability recognized	g	blocked for accredited testing
vlk!	Attention: extended calibration interval	*	next calibration ordered / currently in progress
NK!	Attention: not calibrated		

11 Observations

No observations exceeding those reported with the single test cases have been made.

Annex A Document history

Version	Applied changes	Date of release
1.0	Initial release	2013-03-20
-A	Correction of output power values. Add conducted measurements.	2013-08-07

Annex B Further information**Glossary**

AVG	-	Average
DUT	-	Device under test
EMC	-	Electromagnetic Compatibility
EN	-	European Standard
EUT	-	Equipment under test
ETSI	-	European Telecommunications Standard Institute
FCC	-	Federal Communication Commission
FCC ID	-	Company Identifier at FCC
HW	-	Hardware
IC	-	Industry Canada
Inv. No.	-	Inventory number
N/A	-	Not applicable
PP	-	Positive peak
QP	-	Quasi peak
S/N	-	Serial number
SW	-	Software

Annex C Accreditation Certificate

Front side of certificate

Deutsche Akkreditierungsstelle GmbH
 Bellehene gemäß § 8 Absatz 1 AkkStelleG i.V.m. § 1 Absatz 1 AkkStelleGBV
 Unterzeichnerin der Multilateralen Abkommen
 von EA, ILAC und IAF zur gegenseitigen Anerkennung

Akkreditierung

Die Deutsche Akkreditierungsstelle GmbH bestätigt hiermit, dass das Prüflaboratorium
CETECOM ICT Services GmbH
 Untertürkheimer Straße 6-10, 66117 Saarbrücken
 die Kompetenz nach DIN EN ISO/IEC 17025:2005 besitzt, Prüfungen in folgenden Bereichen
 durchzuführen:

- Drahtgebundene Kommunikation einschließlich xDSL
- VoIP und DECT
- Akustik
- Funk einschließlich WLAN
- Short Range Devices (SRD)
- RFID
- WiMax und Richtfunk
- Mobilfunk (GSM / GPRS, Over the Air (OTA) Performance)
- Elektromagnetische Verträglichkeit (EMV) einschließlich Automotive
- Produktsicherheit
- SAR und Hearing Aid Compatibility (HAC)
- Umweltsimulation
- Smart Card Terminals
- Bluetooth
- Wi-Fi Services

Die Akkreditierungsurkunde gilt nur in Verbindung mit dem Bescheid vom 18.01.2013 mit der
 Akkreditierungsnummer D-PL-12076-01 und ist gültig 17.01.2018. Sie besteht aus diesem Deckblatt, der
 Rückseite des Deckblatts und der folgenden Anlage mit insgesamt 80 Seiten.

Registrierungsnummer der Urkunde: D-PL-12076-01-01

Frankfurt am Main, 18.01.2013

Ingrid Dießing (FH) Stellv. Leiterin
 Abteilungsleiterin

Siehe Hinweise auf der Rückseite

Back side of certificate

Deutsche Akkreditierungsstelle GmbH

Standort Berlin Spittelmarkt 10 10117 Berlin	Standort Frankfurt am Main Gartenstraße 6 60594 Frankfurt am Main	Standort Braunschweig Rundesallee 100 38116 Braunschweig
--	---	--

Die auszugsweise Veröffentlichung der Akkreditierungsurkunde bedarf der vorherigen schriftlichen
 Zustimmung der Deutsche Akkreditierungsstelle GmbH (DAkkS). Ausgenommen davon ist die separate
 Weiterverbreitung des Deckblatts durch die umseitig genannte Konformitätsbewertungsstelle in
 unveränderter Form.

Es darf nicht der Anschein erweckt werden, dass sich die Akkreditierung auch auf Bereiche erstreckt,
 die über den durch die DAkkS bestätigten Akkreditierungsbereich hinausgehen.

Die Akkreditierung erfolgte gemäß des Gesetzes über die Akkreditierungsstelle (AkkStelleG) vom
 31. Juli 2009 (BGBl. I S. 2625) sowie der Verordnung (EG) Nr. 765/2008 des Europäischen Parlaments
 und des Rates vom 9. Juli 2008 über die Vorschriften für die Akkreditierung und Marktüberwachung
 im Zusammenhang mit der Vermarktung von Produkten (Abt. L 218 vom 9. Juli 2008, S. 30).
 Die DAkkS ist Unterzeichnerin der Multilateralen Abkommen zur gegenseitigen Anerkennung der
 European co-operation for Accreditation (EA), des International Accreditation Forum (IAF) und
 der International Laboratory Accreditation Cooperation (ILAC). Die Unterzeichner dieser Abkommen
 erkennen ihre Akkreditierungen gegenseitig an.

Der aktuelle Stand der Mitgliedschaft kann folgenden Webseiten entnommen werden:
 EA: www.european-accreditation.org
 ILAC: www.ilac.org
 IAF: www.iaf.nu

Note:
 The current certificate including annex is published on our website (see link below) or may be received
 from CETECOM ICT Services on request.

<http://www.cetecom.com/eu/de/cetecom-group/europa/deutschland-saarbruecken/akkreditierungen.html>