

TEST REPORT

Test report no.: 1-3791/11-01-14-A



Testing laboratory

CETECOM ICT Services GmbH
 Untertuerkheimer Strasse 6 – 10
 66117 Saarbruecken / Germany
 Phone: + 49 681 5 98 - 0
 Fax: + 49 681 5 98 - 9075
 Internet: <http://www.cetecom.com>
 e-mail: ict@cetecom.com

Accredited Testing Laboratory:

The testing laboratory (area of testing) is accredited according to DIN EN ISO/IEC 17025 (2005) by the Deutsche Akkreditierungsstelle GmbH (DAkkS). The accreditation is valid for the scope of testing procedures as stated in the accreditation certificate with the registration number: D-PL-12076-01-01. Area of Testing: Radio/Satellite Communications

Applicant

Sennheiser electronic GmbH & Co. KG
 Am Labor 1
 30900 Wedemark / GERMANY
 Phone: +49 5130 600-0
 Fax: +49 5130 600-574
 Contact: Marco Happ
 e-mail: marco.happ@sennheiser.com
 Phone: +49 5130 600-2621

Manufacturer

Sennheiser electronic GmbH & Co. KG
 Am Labor 1
 30900 Wedemark / GERMANY

Test standard/s

47 CFR Part 15	Title 47 of the Code of Federal Regulations; Chapter I Part 15 - Radio frequency devices
RSS - 210 Issue 8	Spectrum Management and Telecommunications - Radio Standards Specification Low-power Licence-exempt Radiocommunication Devices (All Frequency Bands): Category I Equipment

For further applied test standards please refer to section 3 of this test report.

Test Item

Kind of test item:	Wireless conference system
Model name:	ADN-W AM-US
FCC ID:	DMOADNWAM
IC:	2099A-ADNWAM
Frequency:	ISM band 5725 MHz to 5850 MHz (lowest channel 5745 MHz; highest channel 5825 MHz)
Technology tested:	Proprietary wireless audio transmission system
Antenna:	External rod. antennas
Power Supply:	52.8 V DC by POE power supply
Temperature Range:	+5°C to +45°C



This test report is electronically signed and valid without handwriting signature. For verification of the electronic signatures, the public keys can be requested at the testing laboratory.

Test report authorised:

p.o.

Marco Bertolino
 Testing Manager

Test performed:

Andreas Luckenbill
 Expert

1 Table of contents	
1	Table of contents2
2	General information3
2.1	Notes and disclaimer3
2.2	Application details.....3
3	Test standard/s3
3.1	Measurement guidance.....3
4	Test environment.....4
5	Test item4
5.1	Additional information4
6	Test laboratories sub-contracted4
7	Summary of measurement results5
8	RF measurements6
8.1	Description of test setup6
8.1.1	Radiated measurements.....6
8.1.2	Conducted measurements.....7
8.2	Additional comments7
8.3	RSP100 test report cover sheet / performance test data8
9	Measurement results.....9
9.1	System gain.....9
9.2	Maximum output power12
9.3	Power spectral density18
9.4	Spectrum bandwidth – 6 dB23
9.5	Spectrum bandwidth – 20 dB28
9.6	Band edge compliance conducted33
9.7	Band edge compliance radiated33
9.8	TX spurious emissions conducted34
9.9	TX spurious emissions radiated40
9.10	Unintentional radiator spurious emissions radiated54
9.11	Spurious emissions radiated < 30 MHz58
9.12	Spurious emissions conducted < 30 MHz60
10	Test equipment and ancillaries used for tests65
11	Observations66
Annex A	Document history67
Annex B	Further information.....67
Annex C	Accreditation Certificate68

2 General information

2.1 Notes and disclaimer

The test results of this test report relate exclusively to the test item specified in this test report. CETECOM ICT Services GmbH does not assume responsibility for any conclusions and generalizations drawn from the test results with regard to other specimens or samples of the type of the equipment represented by the test item.

The test report may only be reproduced or published in full. Reproduction or publication of extracts from the report requires the prior written approval of CETECOM ICT Services GmbH.

The testing service provided by CETECOM ICT Services GmbH has been rendered under the current "General Terms and Conditions for CETECOM ICT Services GmbH".

CETECOM ICT Services GmbH will not be liable for any loss or damage resulting from false, inaccurate, inappropriate or incomplete product information provided by the customer.

Under no circumstances does the CETECOM ICT Services GmbH test report include any endorsement or warranty regarding the functionality, quality or performance of any other product or service provided.

Under no circumstances does the CETECOM ICT Services GmbH test report include or imply any product or service warranties from CETECOM ICT Services GmbH, including, without limitation, any implied warranties of merchantability, fitness for purpose, or non-infringement, all of which are expressly disclaimed by CETECOM ICT Services GmbH.

All rights and remedies regarding vendor's products and services for which CETECOM ICT Services GmbH has prepared this test report shall be provided by the party offering such products or services and not by CETECOM ICT Services GmbH.

In no case this test report can be considered as a Letter of Approval.

This test report is electronically signed and valid without handwritten signature. For verification of the electronic signatures, the public keys can be requested at the testing laboratory.

2.2 Application details

Date of receipt of order:	2011-09-30
Date of receipt of test item:	2013-02-26
Start of test:	2013-02-26
End of test:	2013-03-15
Person(s) present during the test:	-/-

3 Test standard/s

Test standard	Date	Test standard description
47 CFR Part 15	2010-10	Title 47 of the Code of Federal Regulations; Chapter I Part 15 - Radio frequency devices
RSS - 210 Issue 8	2010-12	Spectrum Management and Telecommunications - Radio Standards Specification Low-power Licence-exempt Radiocommunication Devices (All Frequency Bands): Category I Equipment

3.1 Measurement guidance

DTS : KDB 558074	2012-04	Guidance for Performing Compliance Measurements on Digital Transmission Systems (DTS) Operating Under §15.247
------------------	---------	---

4 Test environment

Temperature:	T_{nom}	+22 °C during room temperature tests
	T_{max}	+45 °C during high temperature tests
	T_{min}	+5 °C during low temperature tests
Relative humidity content:		42 %
Barometric pressure:		not relevant for this kind of testing
Power supply:	V_{nom}	52.8 V DC by POE power supply
	V_{max}	54.0 V
	V_{min}	33.0 V

5 Test item

Kind of test item	:	Wireless conference system
Type identification	:	ADN-W AM-US
S/N serial number	:	Conducted / radiated units: 1462100048; 1462100049 (EUT)
HW hardware status	:	FPGA: 2_8_5_prod2/ AM1.bin
SW software status	:	ADNW_TERMINAL.EXE from 16.11.2012; APP:001120
Frequency band [MHz]	:	ISM band 5725 MHz to 5850 MHz (lowest channel 5745 MHz; highest channel 5825 MHz)
Type of radio transmission	:	OFDM
Use of frequency spectrum	:	
Type of modulation	:	QPSK with coding rate 1/2
Number of channels	:	5
Antenna	:	External rod. antennas
Power supply	:	52.8 V DC by POE power supply
Temperature range	:	+5°C to +45 °C

5.1 Additional information

Test setup - and EUT - photos are included in the following test reports:

External EUT photos: 1-3791/12-01-01_AnnexA
 Internal EUT photos: 1-3791/12-01-01_AnnexB
 Test setup: 1-3791/12-01-01_AnnexD

6 Test laboratories sub-contracted

None

7 Summary of measurement results

- No deviations from the technical specifications were ascertained
- There were deviations from the technical specifications ascertained

TC Identifier	Description	Verdict	Date	Remark
RF-Testing	CFR Part 15 RSS 210, Issue 8	Passed	2013-08-05	-/-

Test specification clause	Test case	Temperature conditions	Power source voltages	Mode	Pass	Fail	NA	NP	Remark
§15.247(b)(4) RSS 210 / A8.4(2)	System gain	Nominal	Nominal	OFDM	<input checked="" type="checkbox"/>	<input type="checkbox"/>	<input type="checkbox"/>	<input type="checkbox"/>	complies
§15.247(e) RSS 210 / A8.2(b)	Power spectral density	Nominal	Nominal	OFDM	<input checked="" type="checkbox"/>	<input type="checkbox"/>	<input type="checkbox"/>	<input type="checkbox"/>	complies
§15.247(a)(2) RSS 210 / A8.2(a)	Spectrum bandwidth - 6dB bandwidth	Nominal	Nominal	OFDM	<input checked="" type="checkbox"/>	<input type="checkbox"/>	<input type="checkbox"/>	<input type="checkbox"/>	complies
§15.247(a)(2) RSS 210 / A8.2(a)	Spectrum bandwidth - 20dB bandwidth	Nominal	Nominal	OFDM	<input checked="" type="checkbox"/>	<input type="checkbox"/>	<input type="checkbox"/>	<input type="checkbox"/>	complies
§15.247(b)(3) RSS-210 / A8.4(4)	Maximum output power	Nominal	Nominal	OFDM	<input checked="" type="checkbox"/>	<input type="checkbox"/>	<input type="checkbox"/>	<input type="checkbox"/>	complies
§15.247(d) RSS-210 / A8.5	Band edge compliance conducted	Nominal	Nominal	OFDM	<input type="checkbox"/>	<input type="checkbox"/>	<input checked="" type="checkbox"/>	<input type="checkbox"/>	-/-
§15.205 RSS-210 / A8.5	Band edge compliance radiated	Nominal	Nominal	OFDM	<input type="checkbox"/>	<input type="checkbox"/>	<input checked="" type="checkbox"/>	<input type="checkbox"/>	-/-
§15.247(d) RSS-210 / A8.5	TX spurious emissions conducted	Nominal	Nominal	OFDM	<input checked="" type="checkbox"/>	<input type="checkbox"/>	<input type="checkbox"/>	<input type="checkbox"/>	complies
§15.247(d) RSS-210 / A8.5	TX spurious emissions radiated	Nominal	Nominal	OFDM	<input checked="" type="checkbox"/>	<input type="checkbox"/>	<input type="checkbox"/>	<input type="checkbox"/>	complies
§15.109 RSS-Gen	Unintentional radiator spurious emissions radiated	Nominal	Nominal	-/-	<input checked="" type="checkbox"/>	<input type="checkbox"/>	<input type="checkbox"/>	<input type="checkbox"/>	complies
§15.209(a) RSS-Gen	TX spurious emissions radiated < 30 MHz	Nominal	Nominal	OFDM	<input checked="" type="checkbox"/>	<input type="checkbox"/>	<input type="checkbox"/>	<input type="checkbox"/>	complies
§15.107(a)	Conducted emissions < 30 MHz	Nominal	Nominal	OFDM	<input checked="" type="checkbox"/>	<input type="checkbox"/>	<input type="checkbox"/>	<input type="checkbox"/>	complies

Note: NA = Not Applicable; NP = Not Performed

8 RF measurements

8.1 Description of test setup

8.1.1 Radiated measurements

The radiated measurements are performed in vertical and horizontal plane in the frequency range from 9 kHz to 25 GHz in semi-anechoic chambers. The EUT is positioned on a non-conductive support with a height of 0.80 m above a conductive ground plane that covers the whole chamber. These antennas can be moved over the height range between 1.0 m and 4.0 m in order to search for maximum field strength emitted from EUT. The measurement distances between EUT and receiving antennas are indicated in the test setups for the various frequency ranges. For each measurement, the EUT is rotated in all three axes until the maximum field strength is received. The wanted and unwanted emissions are received by spectrum analysers where the detector modes and resolution bandwidths over various frequency ranges are set according to requirement ANSI C63. Antennas are confirmed with ANSI C63.

Semi anechoic chamber

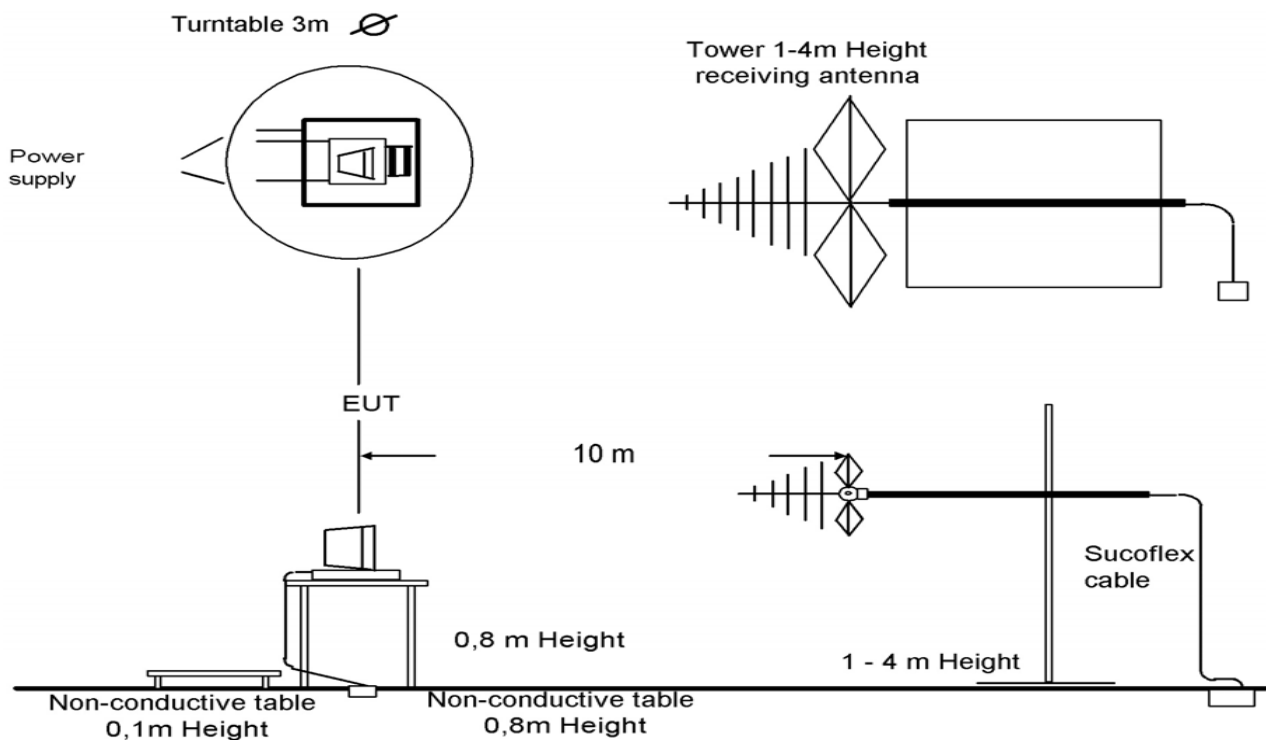

Picture 1: Diagram radiated measurements

9 kHz - 30 MHz:	active loop antenna
30 MHz – 1 GHz:	tri-log antenna
> 1 GHz:	horn antenna

The EUT is powered by an external power supply with nominal voltage. The signalling is performed from outside the chamber with a signalling unit (CMU200 or other) by air link using signalling antenna.

8.1.2 Conducted measurements

The EUT's RF signal is coupled out by the antenna connector which is supplied by the manufacturer. The signal is first 10dB attenuated before it is power divided (~6dB loss per branch). One of the signal paths is connected to the communication base Station (CMU200 or other), the other one is connected to the spectrum analyzer. The specific losses for both signal paths are first checked within a calibration. The measurement readings on the signalling unit/spectrum analyzer are corrected by the specific test set-up loss. The attenuator, power divider, signalling unit and the spectrum analyzer are impedance matched on 50 Ohm.

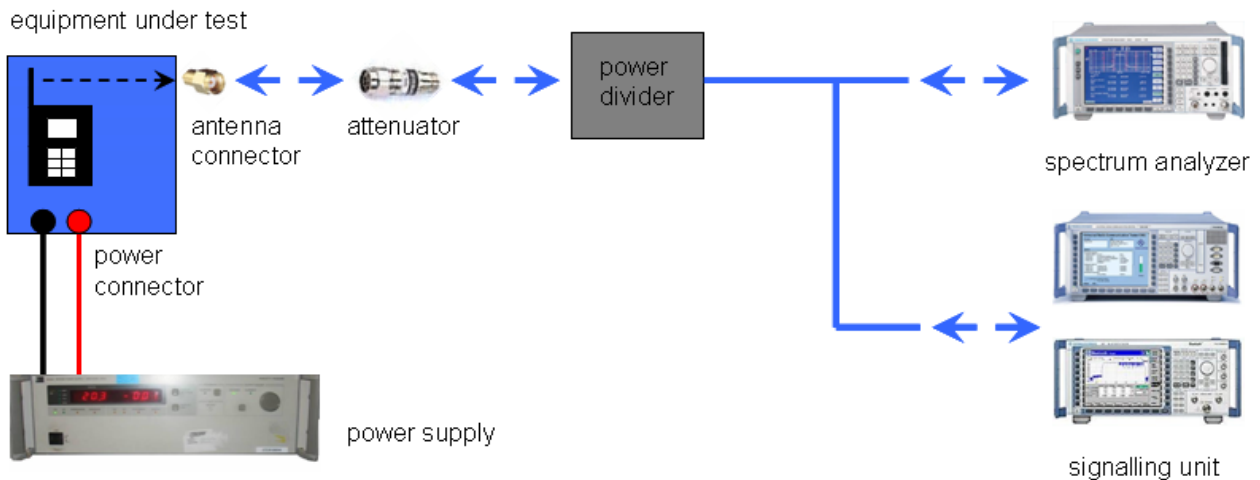

Picture 2: Diagram conducted measurements

8.2 Additional comments

Reference documents: ANT_AM1

Special test descriptions: None

Configuration descriptions: None

- Test mode:
- No test mode available.
lperf was used to ping another device with the largest support packet size
 - Special software is used.
EUT is transmitting pseudo random data by itself

8.3 RSP100 test report cover sheet / performance test data

Test report number	:	1-3791/11-01-14-A			
Equipment model number	:	ADN-W AM-US			
Certification number	:	2099A-ADNWAM			
Manufacturer (complete address)	:	Sennheiser electronic GmbH & Co. KG Am Labor 1 30900 Wedemark / GERMANY			
Tested to radio standards specification no.	:	RSS 210, Issue 8			
Open area test site IC No.	:	IC 3462C-1			
Frequency range	:	ISM band 5725 MHz to 5850 MHz			
Conducted values:					
RF-power [W] (max.)	:	Band	OFDM antenna port 1	OFDM antenna port 2	-/-
		5745 – 5825 MHz	25.82 mW	26.61 mW	-/-
		5755 – 5835 MHz	-/-	-/-	-/-
	Radiated values:				
		Band	OFDM antenna port 1	OFDM antenna port 2	-/-
	5745 – 5825 MHz	46.34 mW	47.75 mW	-/-	
	5755 – 5835 MHz	-/-	-/-	-/-	
Occupied bandwidth (99%-BW) [kHz]	:	Band	OFDM antenna port 1	OFDM antenna port 2	-/-
		5745 – 5825 MHz	16.36 MHz / 16M4G7D	16.35 MHz / 16M4G7D	-/-
		5755 – 5835 MHz	-/-	-/-	-/-
Type of modulation	:	OFDM technology with QPSK modulation.			
Antenna information	:	External rod. antennas			
Transmitter spurious (worst case) [dB μ V/m @ 3m]:	:	44.05 @ 10.11 GHz (peak)			

ATTESTATION:

DECLARATION OF COMPLIANCE:

I attest that the testing was performed or supervised by me; that the test measurements were made in accordance with the above-mentioned Industry Canada standard(s); and that the equipment identified in this application has been subjected to all the applicable test conditions specified in the Industry Canada standards and all of the requirements of the standard have been met.

Laboratory manager:

2013-08-05

Date

Andreas Luckenbill

Name

Signature

9 Measurement results

9.1 System gain

Measurement:

The antenna gain of the complete system is calculated by the difference of radiated power in EIRP and the conducted power of the module.

Measurement parameters:

Measurement parameter	
Detector:	Peak
Sweep time:	5 s
Resolution bandwidth:	3 MHz
Video bandwidth:	3 MHz
Trace-Mode:	Max hold

Limits:

FCC	IC
Antenna Gain	
6 dBi or below 36 dBm	

Results:

T _{nom}	V _{nom}	lowest channel 5745 MHz	middle channel 5785 MHz	highest channel 5825 MHz
Conducted power [dBm]		8.76	8.95	8.12
Radiated power [dBm]		11.30	10.90	11.00
Gain [dBi] Calculated		2.54	1.95	2.88
Measurement uncertainty			± 1.5 dB (cond.) / ± 3 dB (rad.)	

Result: **Passed**

Plots: OFDM

Plot 1: TX mode, lowest channel

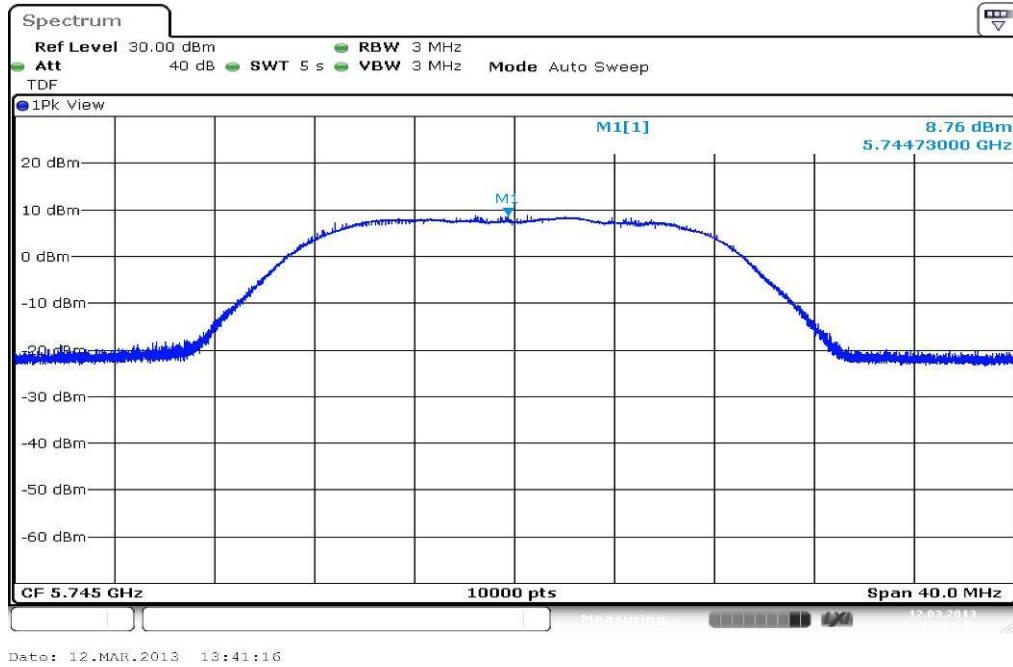

Plot 2: TX mode, middle channel

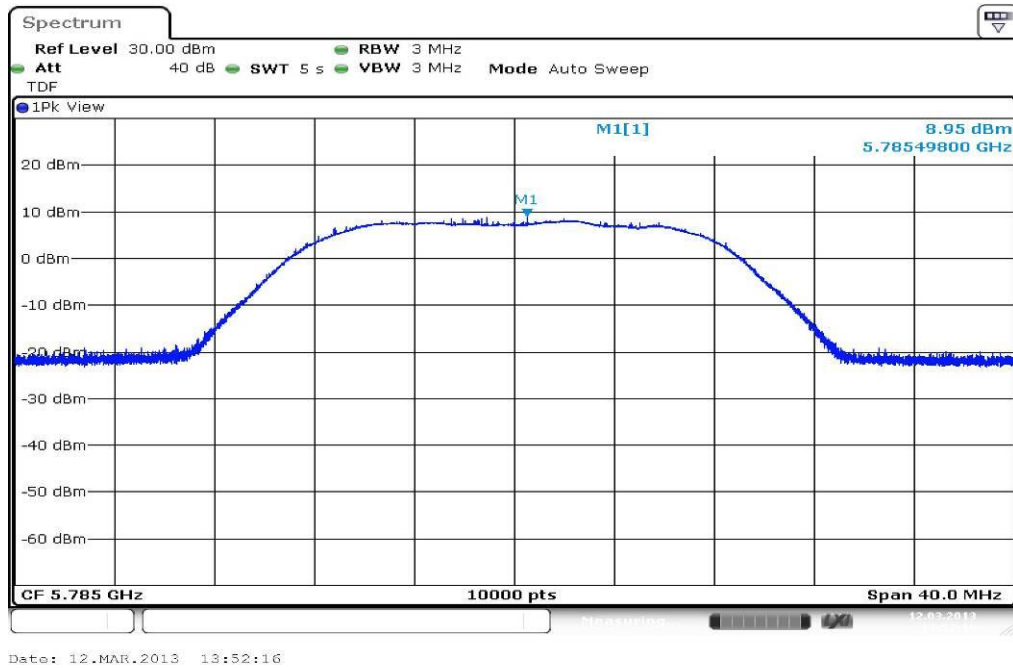

Plot 3: TX mode, highest channel



Date: 12.MAR.2013 14:02:11

9.2 Maximum output power

Description:

Measurement of the maximum output power conducted and radiated. The measurements are performed using the data rate producing the highest conducted output power. The determination of these data rates was performed at the beginning of the tests.

Measurement:

Measurement parameter	
Detector:	Peak
Sweep time:	Auto
Resolution bandwidth:	3 MHz / 10 MHz (at least 1 MHz)
Video bandwidth:	≥ 3 x RBW (or maximum of available setting)
Span:	> DTS bandwidth
Trace-Mode:	Max hold (allow trace to fully stabilize)

Limits:

FCC	IC
Maximum Output Power	
Conducted: 1.0 W – Antenna Gain max. 6 dBi	

Results: OFDM, antenna port 1

OFDM / a – mode Frequency	Maximum Output Power [dBm]		
	5745 MHz	5785 MHz	5825 MHz
Peak Output Power Conducted	14.12	13.82	13.24
Output Power Radiated – EIRP*)	16.66	15.77	16.12
Measurement uncertainty	± 1.5 dB (cond.) / ± 3 dB (rad.)		

*) calculated with Antenna gain

Result: Passed

Results: OFDM, antenna port 2

OFDM / a – mode Frequency	Maximum Output Power [dBm]		
	5745 MHz	5785 MHz	5825 MHz
Peak Output Power Conducted	14.25	13.59	12.77
Output Power Radiated – EIRP*)	16.79	15.54	15.65
Measurement uncertainty	± 1.5 dB (cond.) / ± 3 dB (rad.)		

*) calculated with Antenna gain

Result: Passed

Plots: OFDM, antenna port 1

Plot 1: TX mode, lowest channel

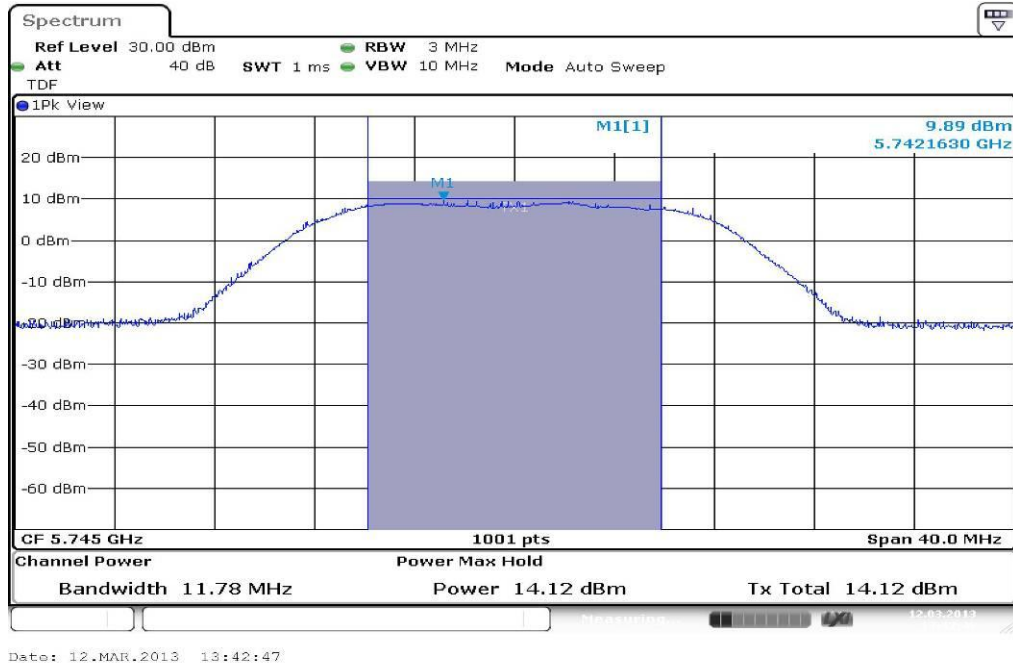

Plot 2: TX mode, middle channel

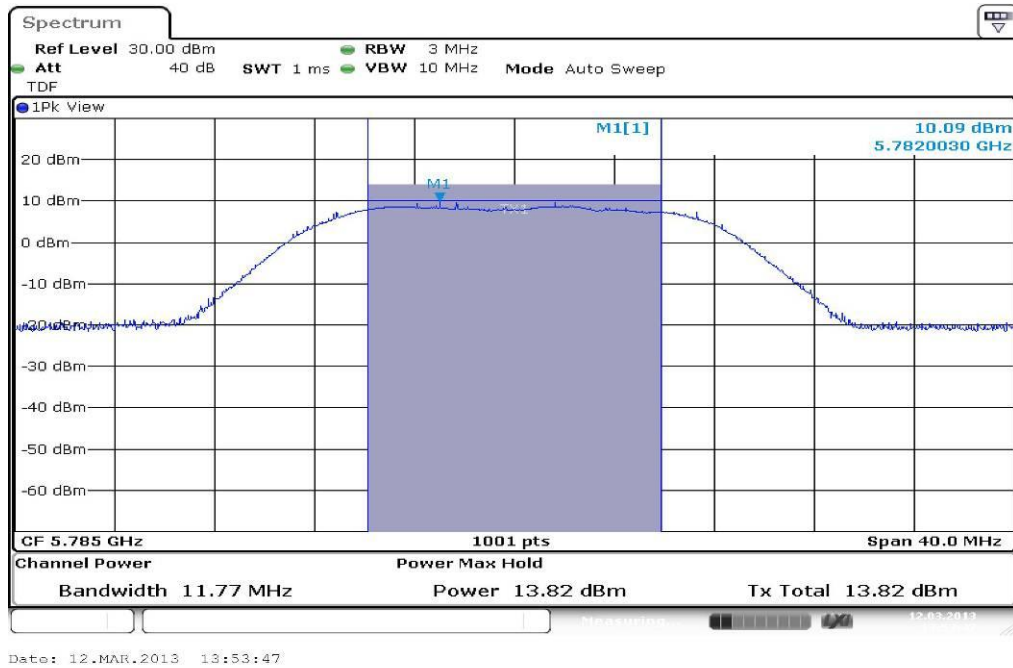

Plot 3: TX mode, highest channel

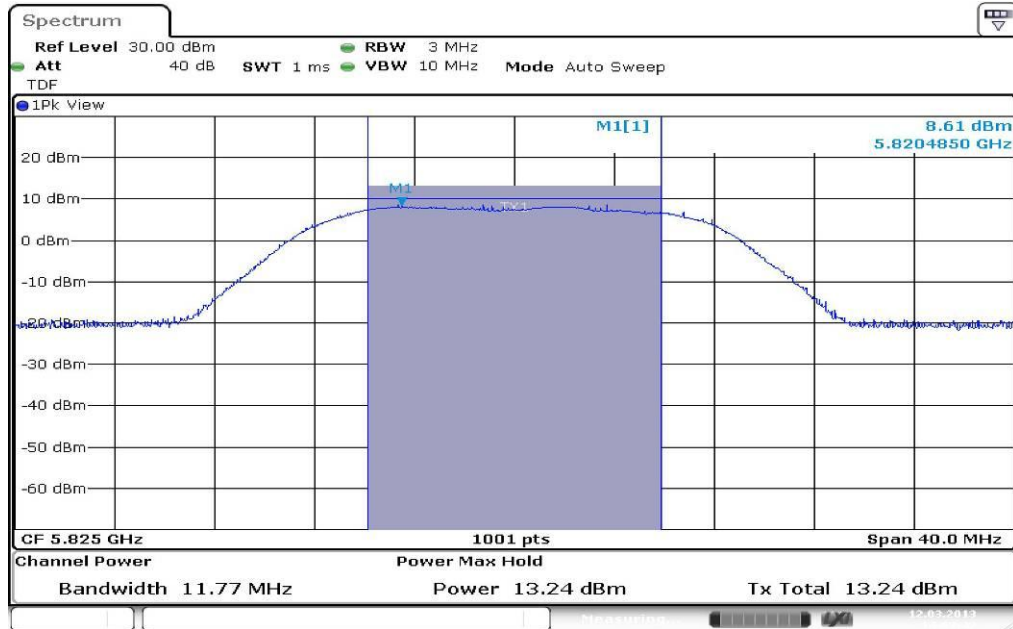

Date: 12.MAR.2013 14:03:42

Plots: OFDM, antenna port 2

Plot 1: TX mode, lowest channel

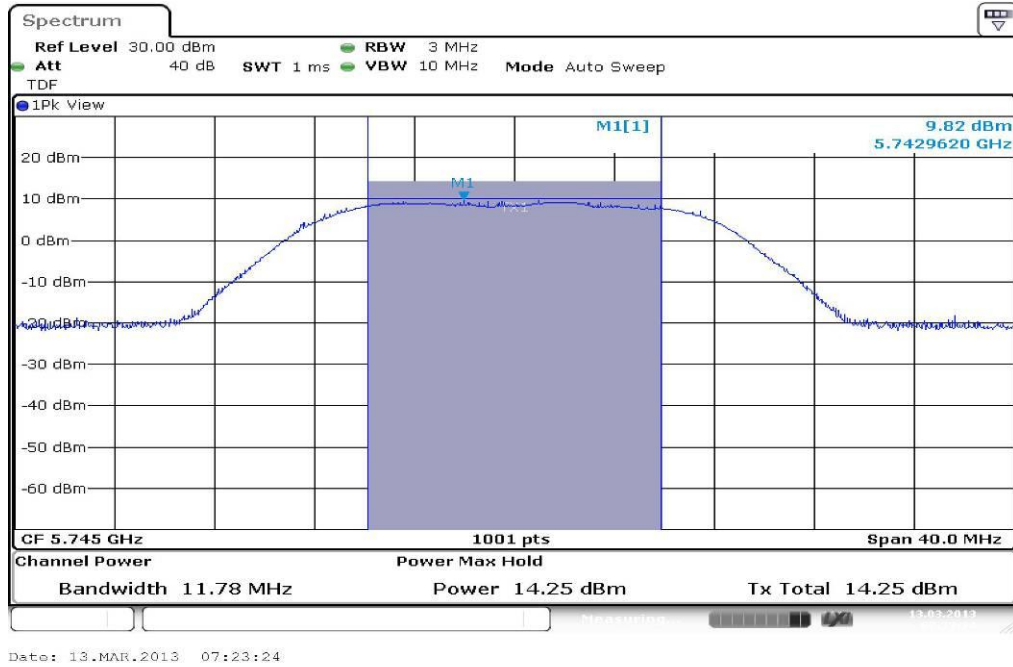

Plot 2: TX mode, middle channel

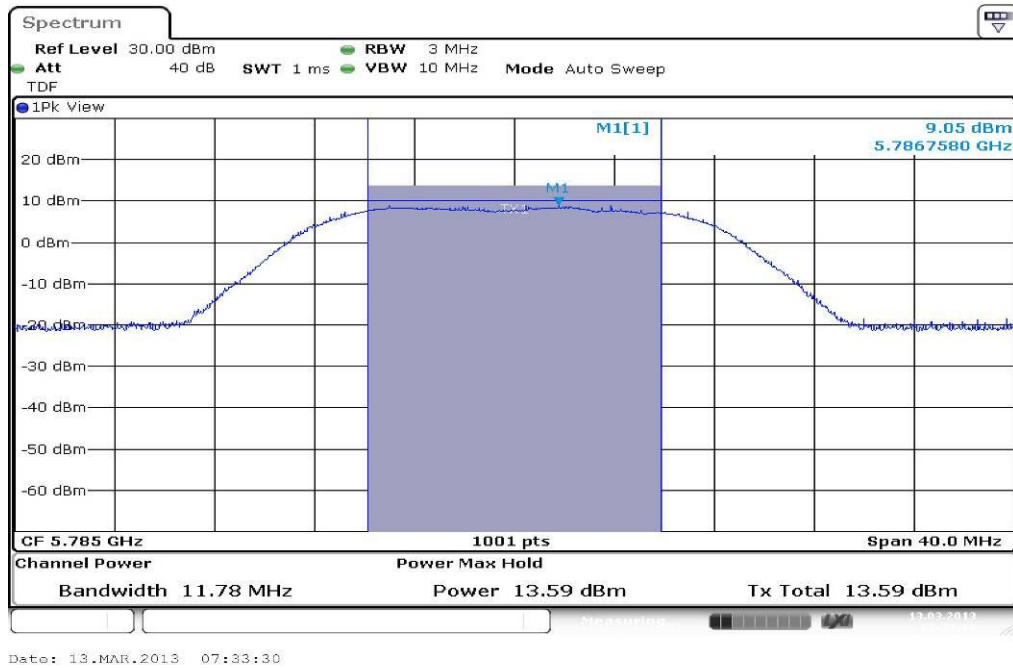

Plot 3: TX mode, highest channel

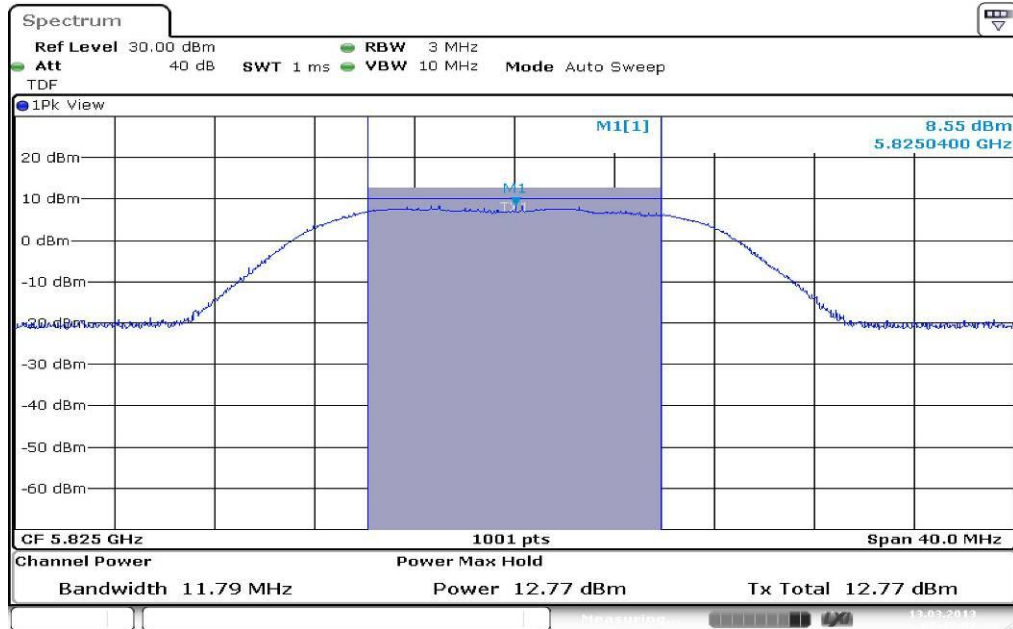

Date: 13.MAR.2013 07:43:02

9.3 Power spectral density

Description:

Measurement of the power spectral density of a digital modulated system. The measurement is repeated for both modulations at the lowest, middle and highest channel.

Measurement:

Measurement parameter	
Detector:	Peak
Sweep time:	Auto
Resolution bandwidth:	≥ 3 kHz
Video bandwidth:	$\geq 3 \times$ RBW
Span:	1.5 times of the DTS BW
Trace-Mode:	Max hold (allow trace to fully stabilize)
Bandwidth correction:	Peak

Limits:

FCC	IC
Power Spectral Density	
8 dBm (conducted)	

Results:

Modulation	Power Spectral density [dBm]		
	5725 MHz	5785 MHz	5825 MHz
Frequency			
OFDM - antenna port 1	-17.01	-17.25	-17.73
OFDM - antenna port 2	-16.72	-17.75	-18.58
Measurement uncertainty	± 1.5 dB		

Result: **Passed**

Plots: OFDM, antenna port 1

Plot 1: TX mode, lowest channel

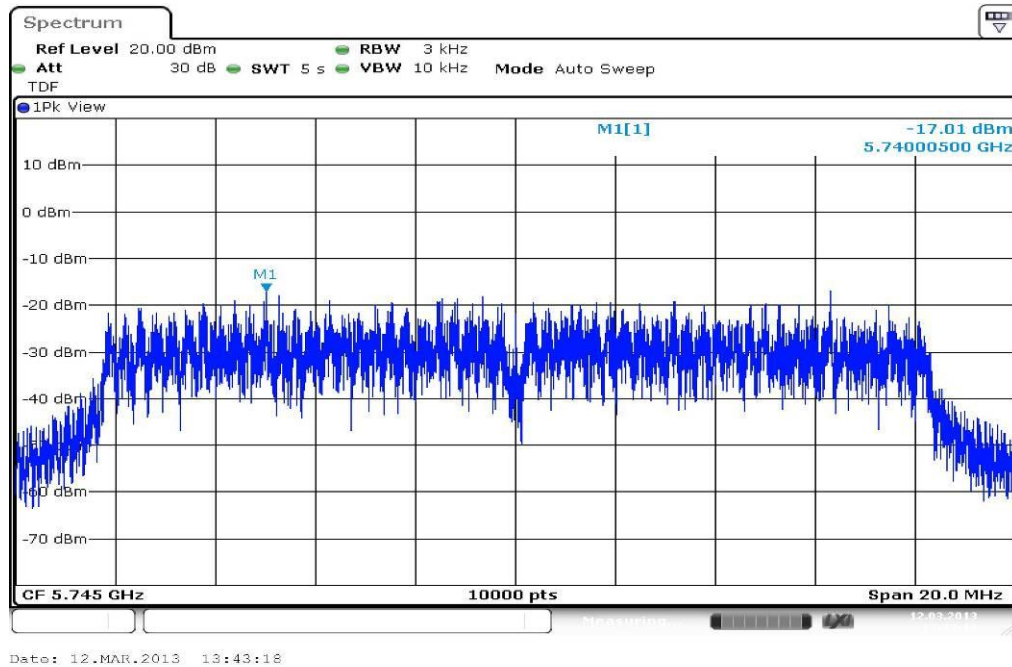

Plot 2: TX mode, middle channel

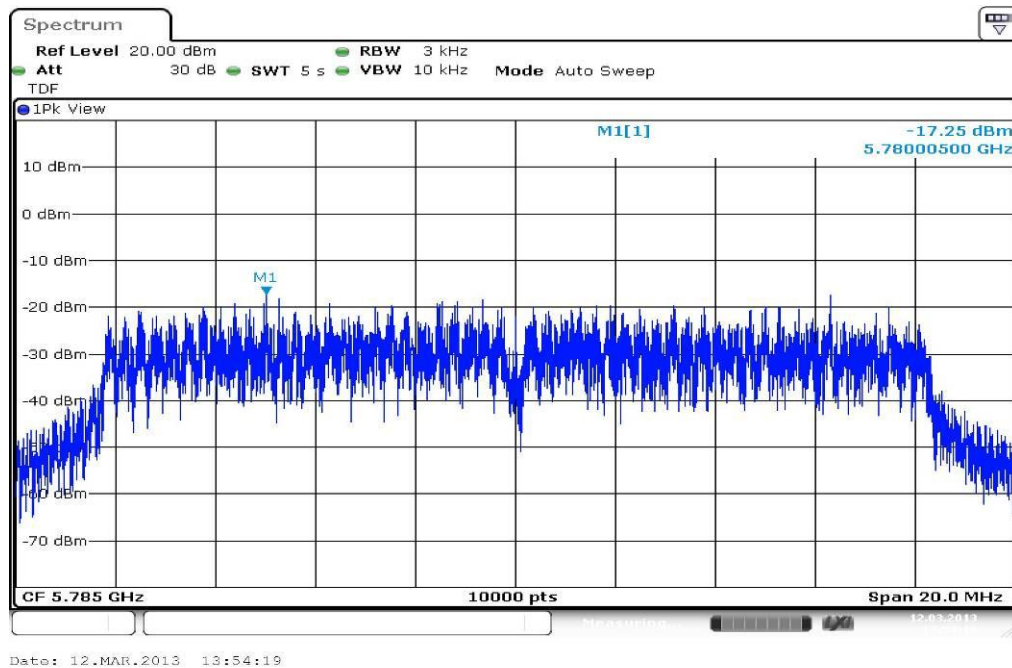

Plot 3: TX mode, highest channel

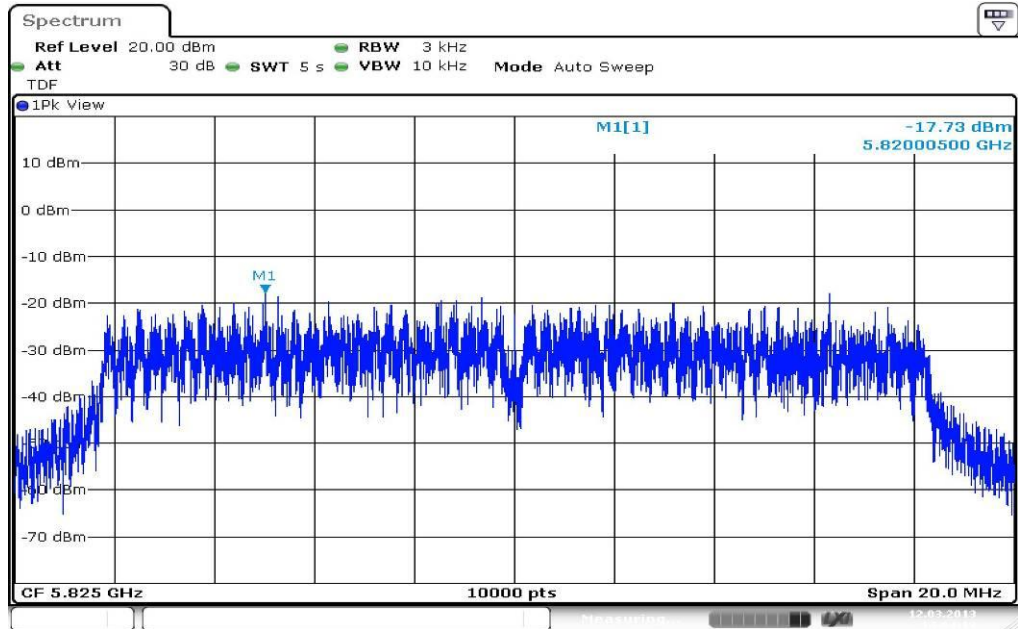

Date: 12.MAR.2013 14:04:14

Plots: OFDM, antenna port 2

Plot 1: TX mode, lowest channel

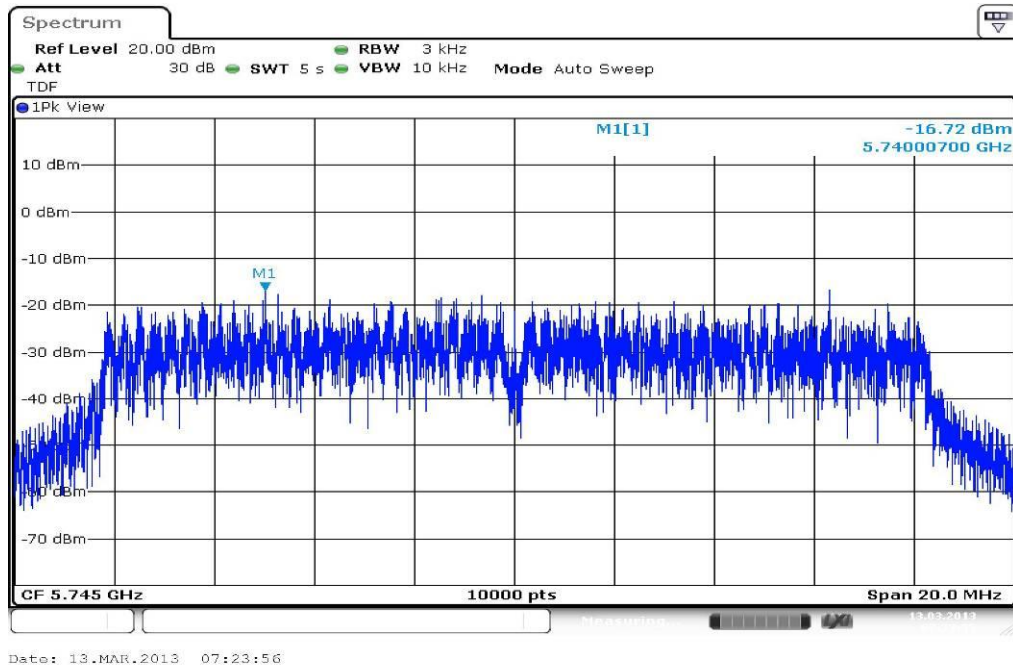

Plot 2: TX mode, middle channel

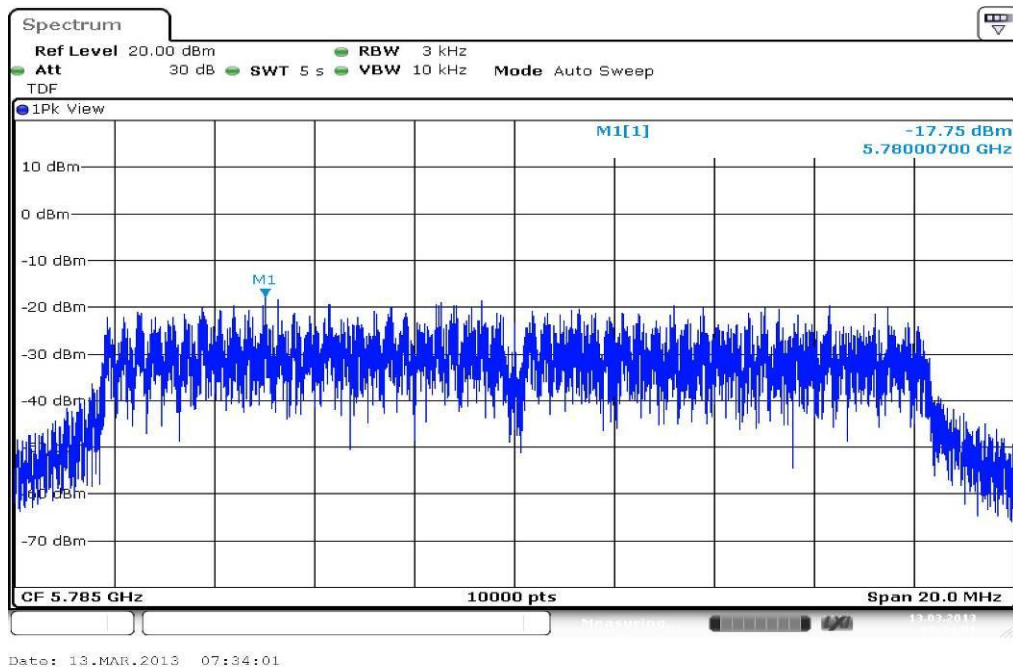

Plot 3: TX mode, highest channel

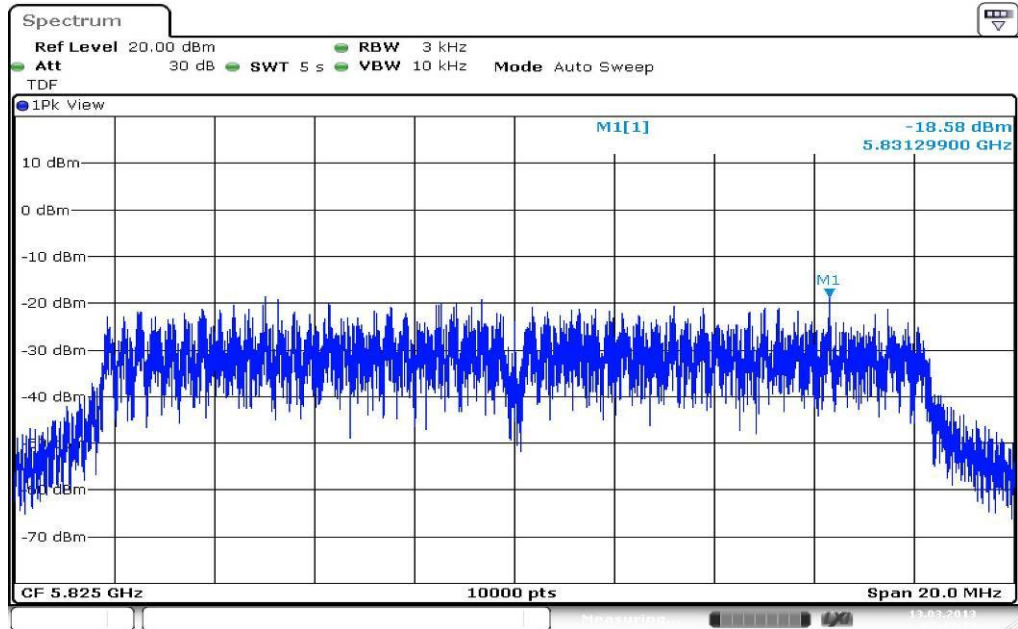

Date: 13.MAR.2013 07:43:34

9.4 Spectrum bandwidth – 6 dB

Description:

Measurement of the 6 dB bandwidth of the modulated signal.

Measurement:

Measurement parameter	
Detector:	Peak
Sweep time:	Auto
Resolution bandwidth:	1 - 5% of the DTS BW but not exceed 100 kHz
Video bandwidth:	$\geq 3 \times \text{RBW}$
Span:	Complete signal
Trace-Mode:	Max hold (allow trace to stabilize)

Limits:

FCC	IC
Spectrum Bandwidth – 6 dB	
Systems using digital modulation techniques may operate in the 5725 – 5850 MHz band. The minimum 6 dB bandwidth shall be at least 500 kHz.	

Results:

Modulation	6 dB bandwidth [MHz]			
	Frequency	Lowest channel	Middle channel	Highest channel
OFDM - antenna port 1	11.78	11.77	11.77	11.77
OFDM - antenna port 2	11.78	11.78	11.78	11.79
Measurement uncertainty	$\pm \text{RBW}$			

Result: Passed

Plots: OFDM, antenna port 1

Plot 1: TX mode, lowest channel

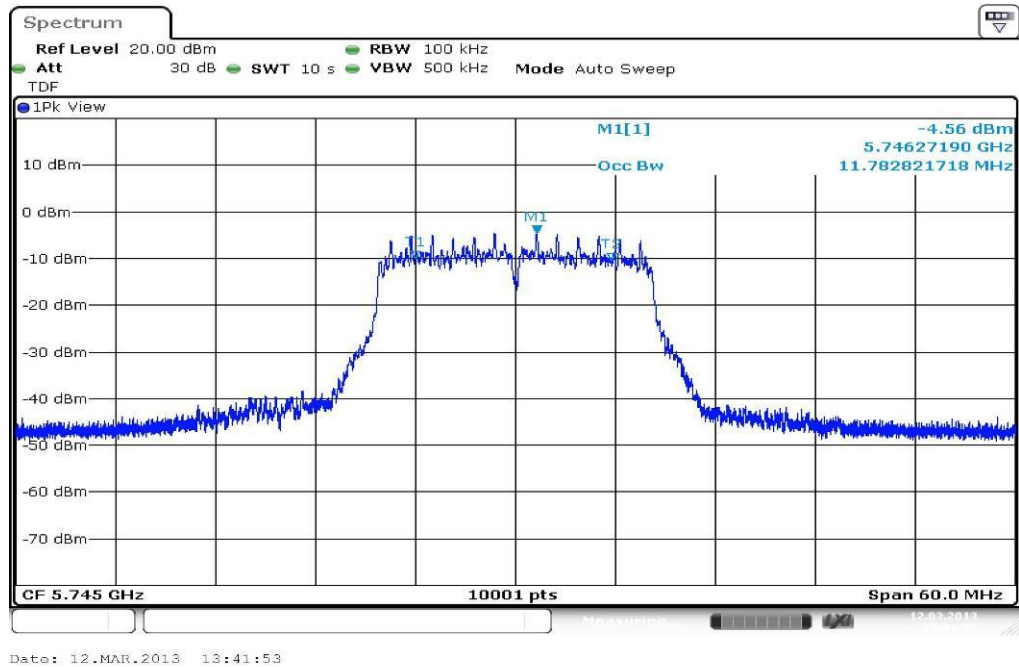

Plot 2: TX mode, middle channel

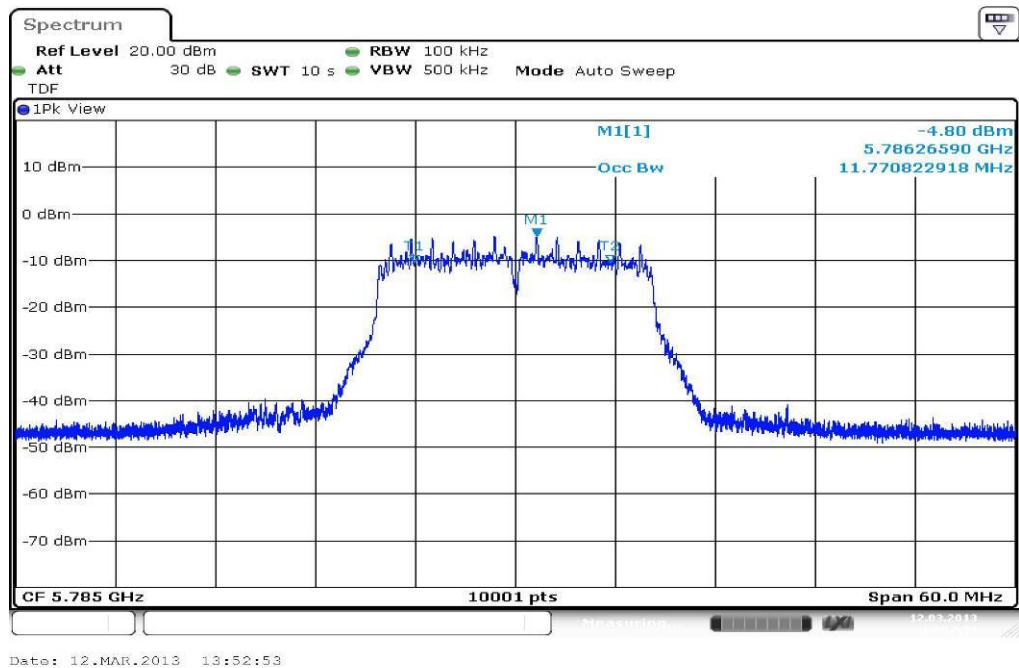

Plot 3: TX mode, highest channel

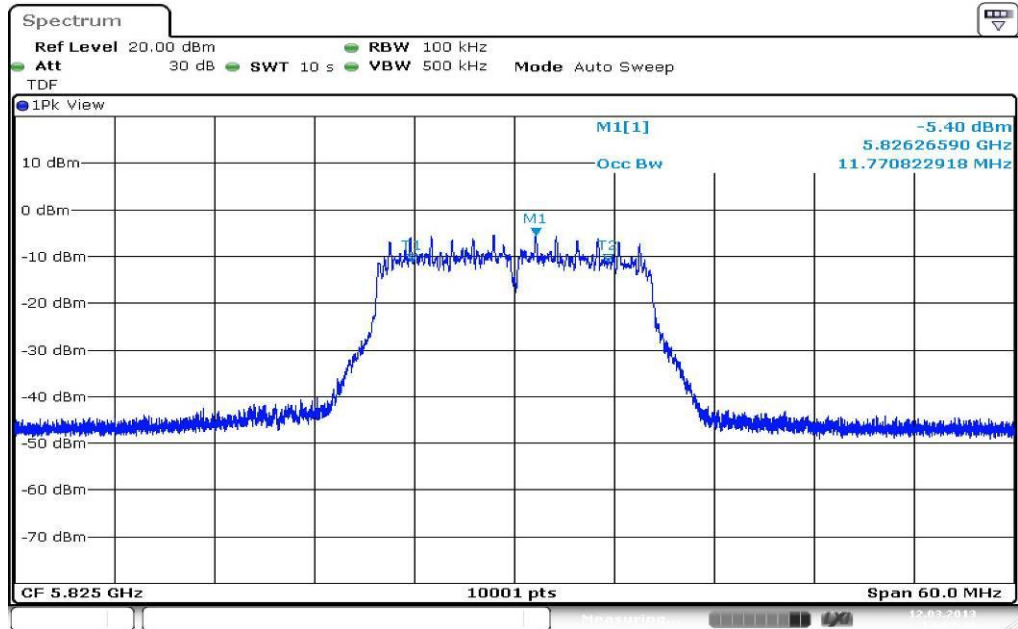

Date: 12.MAR.2013 14:02:48

Plots: OFDM, antenna port 2

Plot 1: TX mode, lowest channel

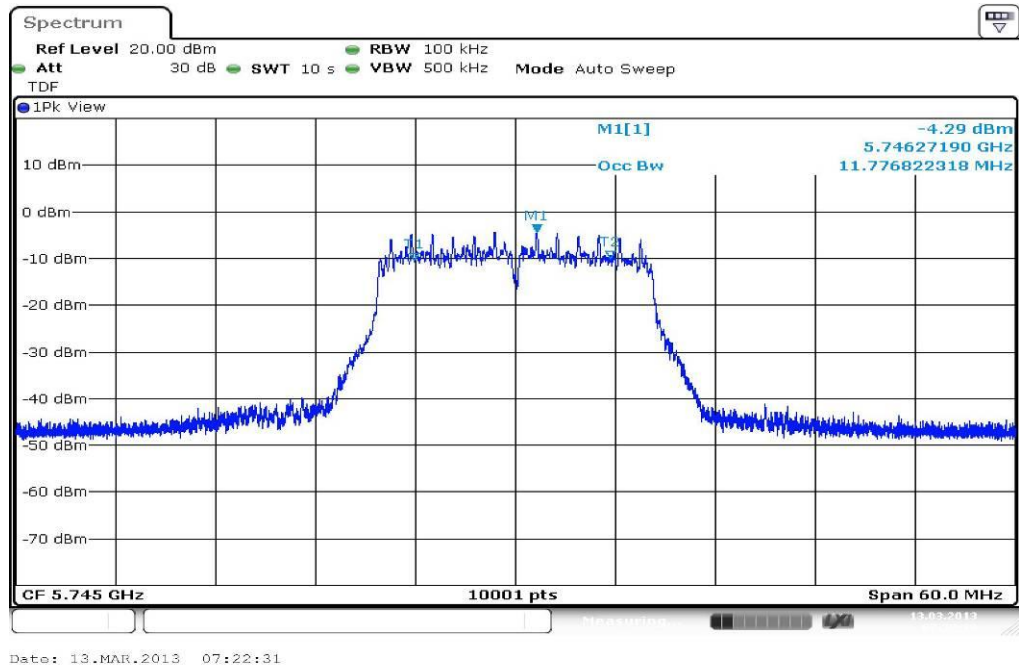

Plot 2: TX mode, middle channel

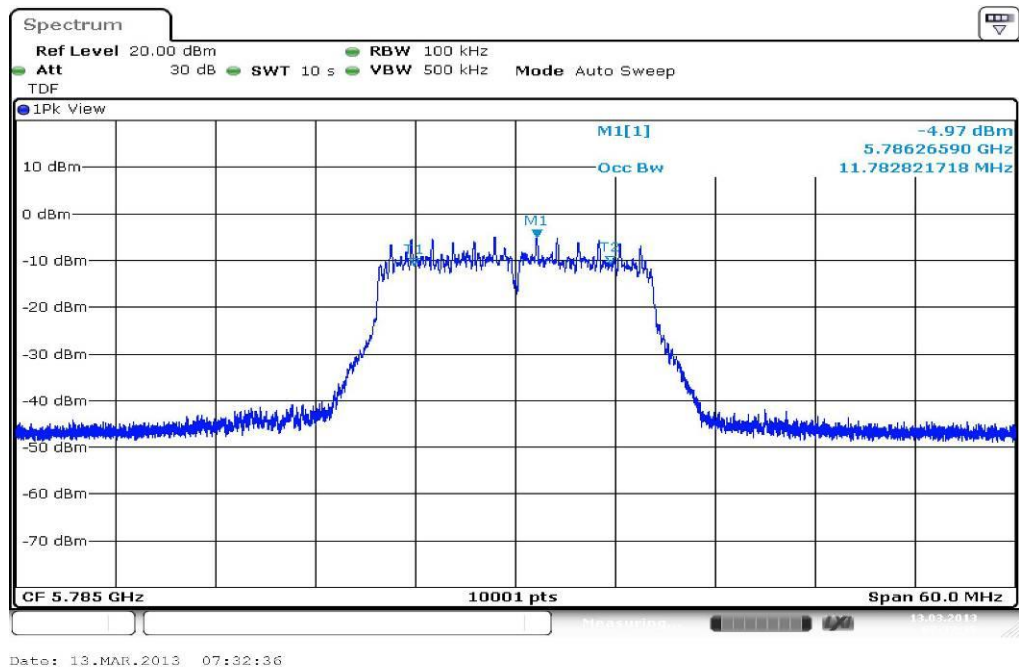

Plot 3: TX mode, highest channel

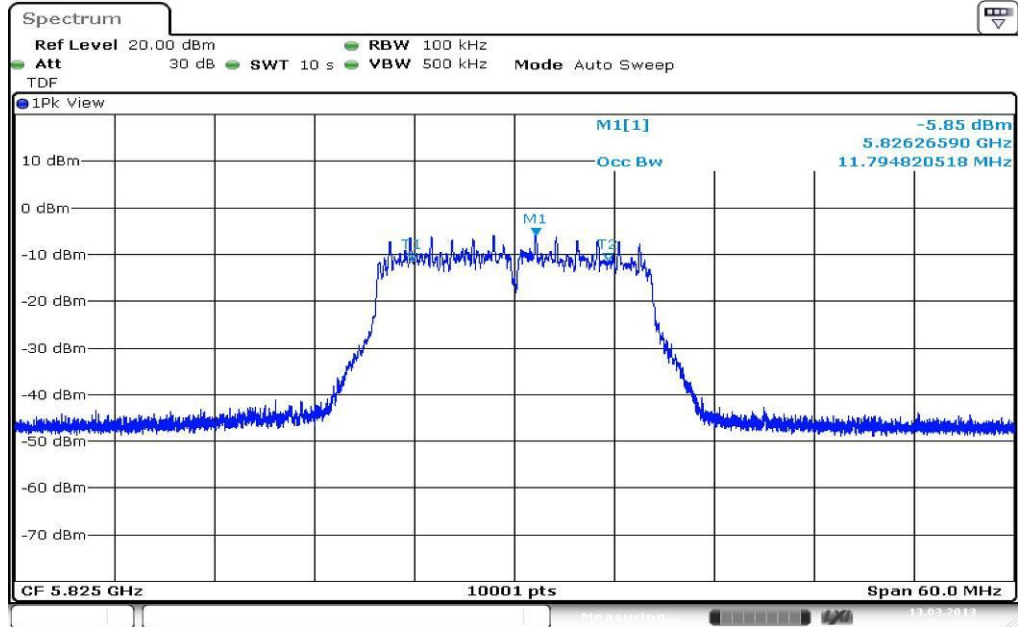

Date: 13.MAR.2013 07:42:08

9.5 Spectrum bandwidth – 20 dB

Description:

Measurement of the 20 dB bandwidth of the modulated signal.

Measurement:

Measurement parameter	
Detector:	Peak
Sweep time:	Auto
Resolution bandwidth:	1 - 5% of the DTS BW but not exceed 100 kHz
Video bandwidth:	$\geq 3 \times \text{RBW}$
Span:	Complete signal
Trace-Mode:	Max hold (allow trace to stabilize)

Limits:

FCC	IC
Spectrum Bandwidth – 20 dB	
Systems using digital modulation techniques may operate in the 5725 – 5825 MHz band. The minimum 6 dB bandwidth shall be at least 500 kHz.	

Results:

Modulation	20 dB bandwidth [MHz]			
	Frequency	Lowest channel	Middle channel	Highest channel
OFDM - antenna port 1	16.36	16.36	16.35	
OFDM - antenna port 2	16.35	16.35	16.35	
Measurement uncertainty	$\pm \text{RBW}$			

Result: **Passed**

Plots: OFDM, antenna port 1

Plot 1: TX mode, lowest channel

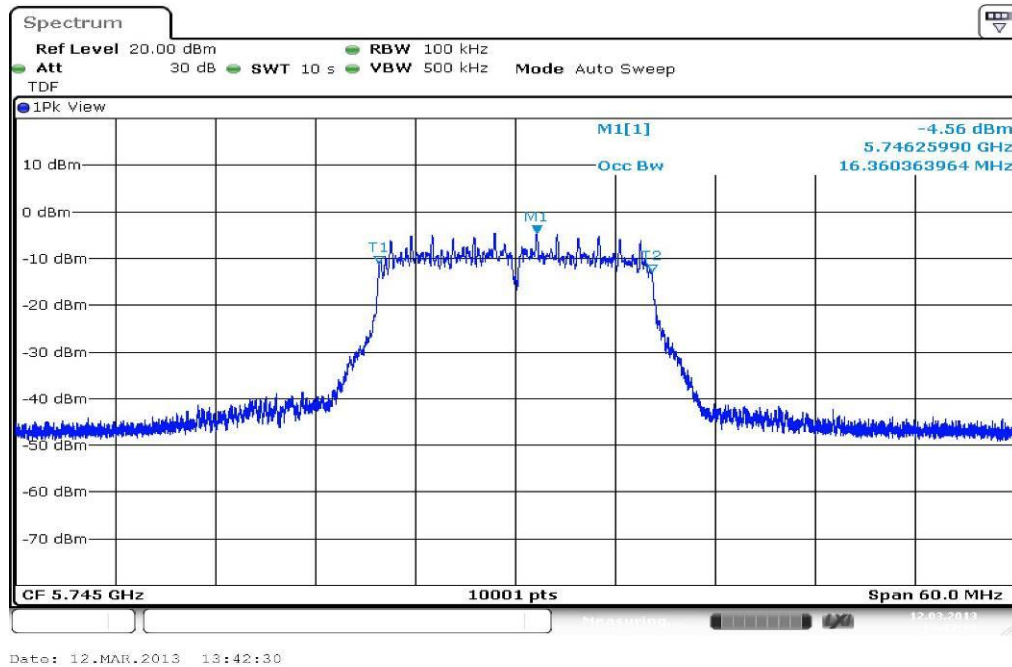

Plot 2: TX mode, middle channel

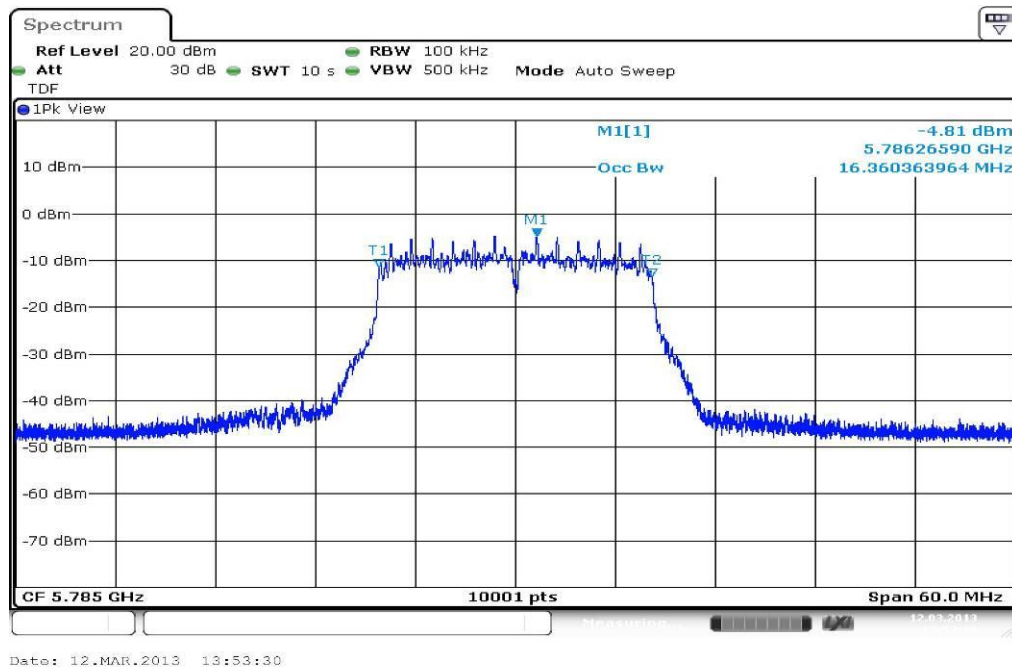

Plots: OFDM, antenna port 2

Plot 1: TX mode, lowest channel

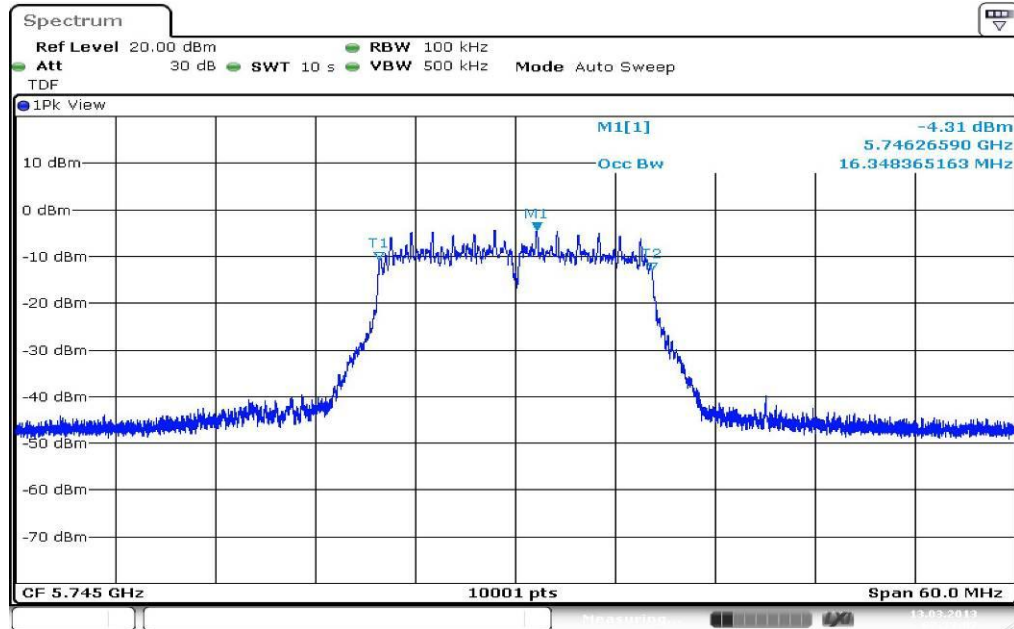

Plot 2: TX mode, middle channel

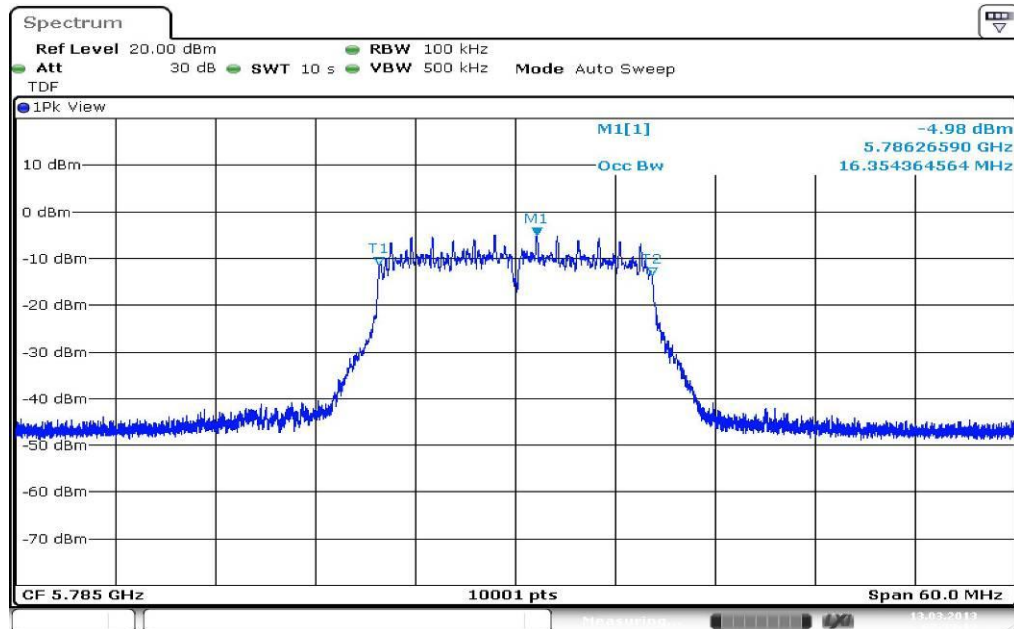

Plot 3: TX mode, highest channel

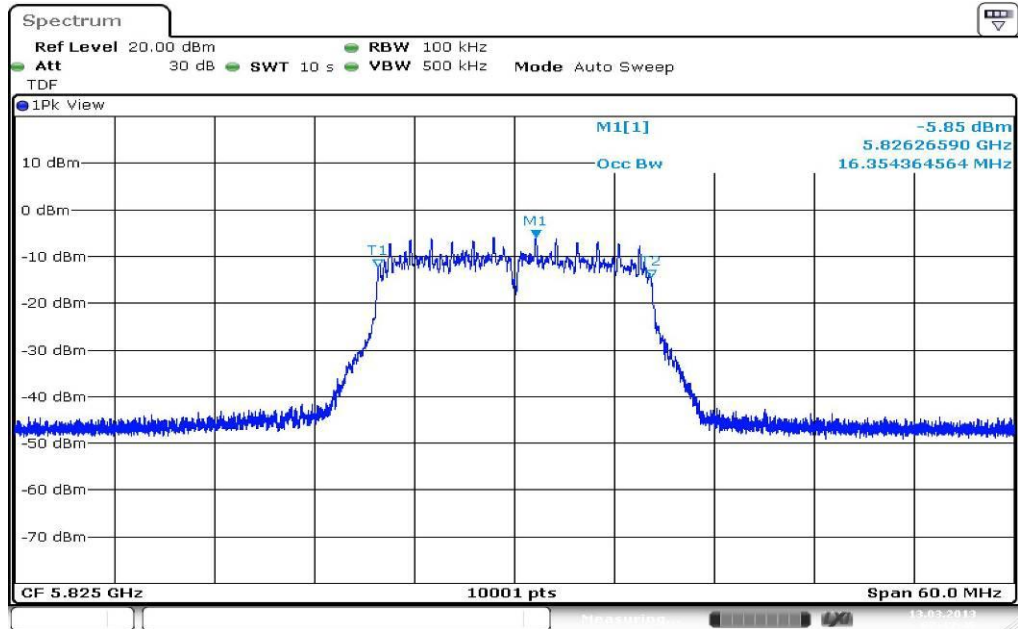

Date: 13.MAR.2013 07:42:45

9.6 Band edge compliance conducted

Not applicable! No restricted band close to used band!

9.7 Band edge compliance radiated

Not applicable! No restricted band close to used band!

9.8 TX spurious emissions conducted

Description:

Measurement of the conducted spurious emissions in transmit mode. The measurement is performed at the lowest, middle and highest channel. The measurement is repeated for all modulations.

Measurement:

Measurement parameter	
Detector:	Peak
Sweep time:	1s / 100 MHz
Resolution bandwidth:	F < 1 GHz: 100 kHz F > 1 GHz: 100 kHz
Video bandwidth:	F < 1 GHz: 500 kHz F > 1 GHz: 500 kHz
Span:	9 kHz to 25 GHz
Trace-Mode:	Max Hold

Limits:

FCC	IC
TX Spurious Emissions Conducted	
<p>In any 100 kHz bandwidth outside the frequency band in which the spread spectrum or digitally modulated intentional radiator is operating, the radio frequency power that is produced by the intentional radiator shall be at least 20 dB below that in the 100 kHz bandwidth within the band that contains the highest level of the desired power, based on either an RF conducted or a radiated measurement. Attenuation below the general limits specified in Section 15.209(a) is not required</p>	

Results: OFDM, antenna port 1

TX Spurious Emissions Conducted					
OFDM antenna port 1					
f [MHz]		amplitude of emission [dBm]	limit max. allowed emission power	actual attenuation below frequency of operation [dB]	results
5745		-4.68	30 dBm		Operating frequency
No spurious emissions detected.			-20 dBc (peak)		complies
			-30 dBc (average)		
5785		-4.94	30 dBm		Operating frequency
No spurious emissions detected.			-20 dBc (peak)		complies
			-30 dBc (average)		
5825		-5.50	30 dBm		Operating frequency
No spurious emissions detected.			-20 dBc (peak)		complies
			-30 dBc (average)		
Measurement uncertainty			± 3 dB		

Result: Passed

Results: OFDM, antenna port 2

TX Spurious Emissions Conducted					
OFDM antenna port 2					
f [MHz]		amplitude of emission [dBm]	limit max. allowed emission power	actual attenuation below frequency of operation [dB]	results
5745		-4.33	30 dBm		Operating frequency
No spurious emissions detected.			-20 dBc (peak)		complies
			-30 dBc (average)		
5785		-5.01	30 dBm		Operating frequency
No spurious emissions detected.			-20 dBc (peak)		complies
			-30 dBc (average)		
5825		-5.94	30 dBm		Operating frequency
No spurious emissions detected.			-20 dBc (peak)		complies
			-30 dBc (average)		
Measurement uncertainty			± 3 dB		

Result: Passed

Plots: OFDM, antenna port 1

Plot 1: TX mode, lowest channel, up to 40 GHz

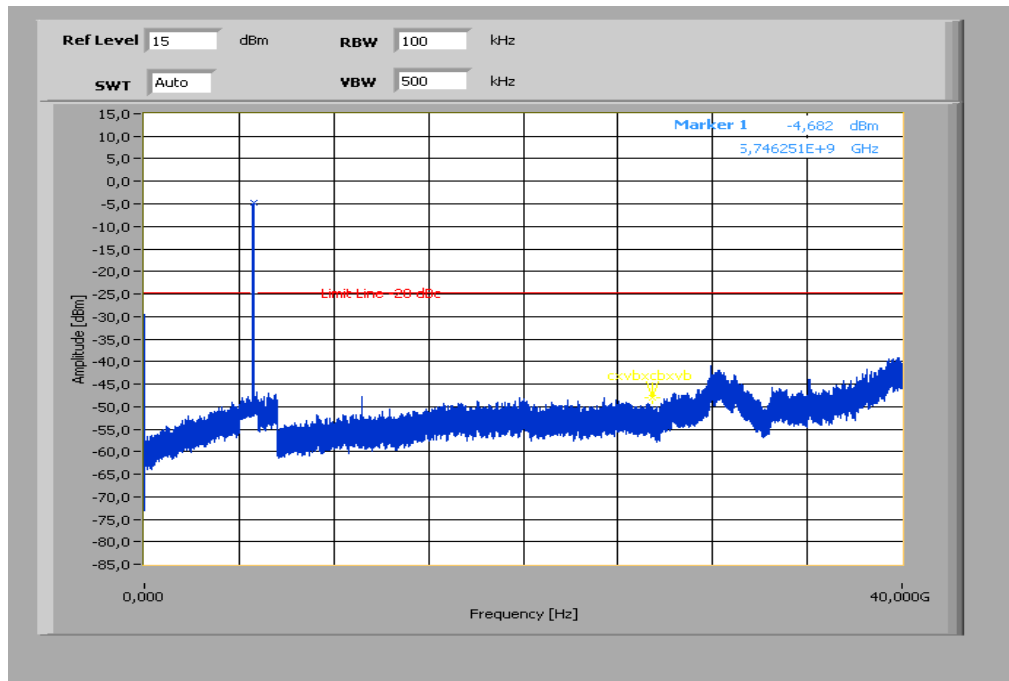

The peak at the beginning of the plot is the LO from the SA.

Plot 2: TX mode, middle channel, up to 40 GHz

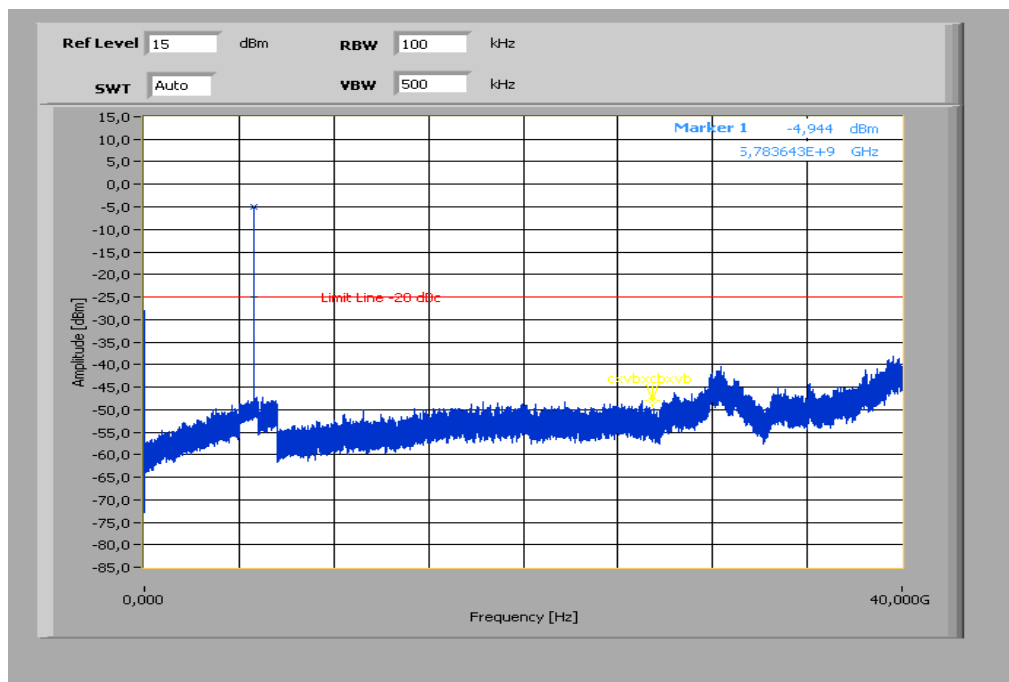

The peak at the beginning of the plot is the LO from the SA.

Plot 3: TX mode, highest channel, up to 40 GHz

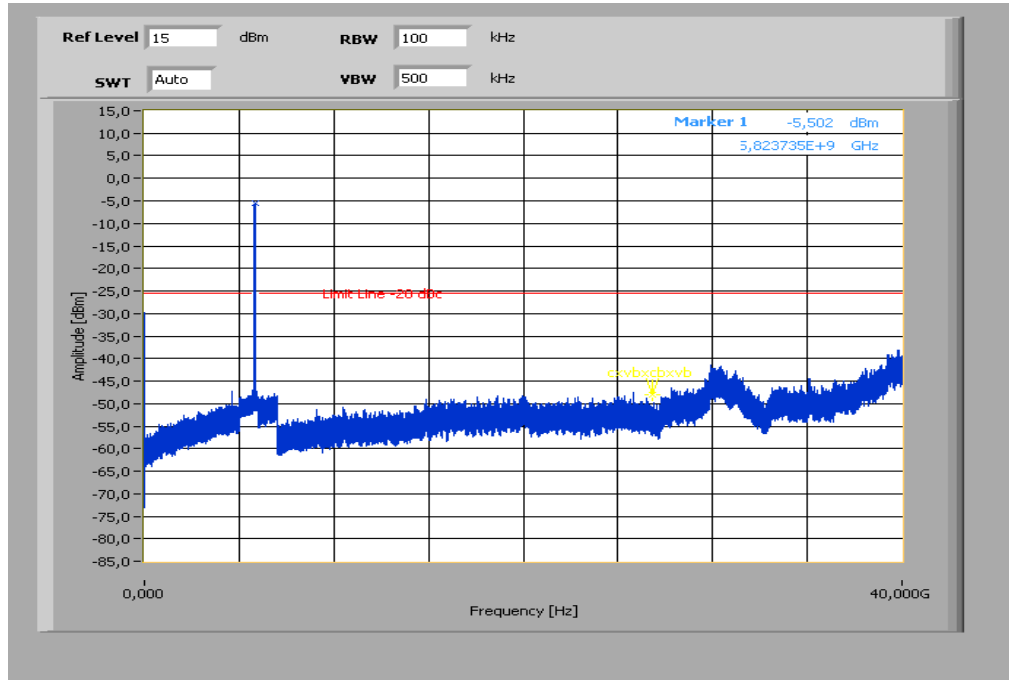

The peak at the beginning of the plot is the LO from the SA.

Plots: OFDM, antenna port 2

Plot 1: TX mode, lowest channel, up to 40 GHz

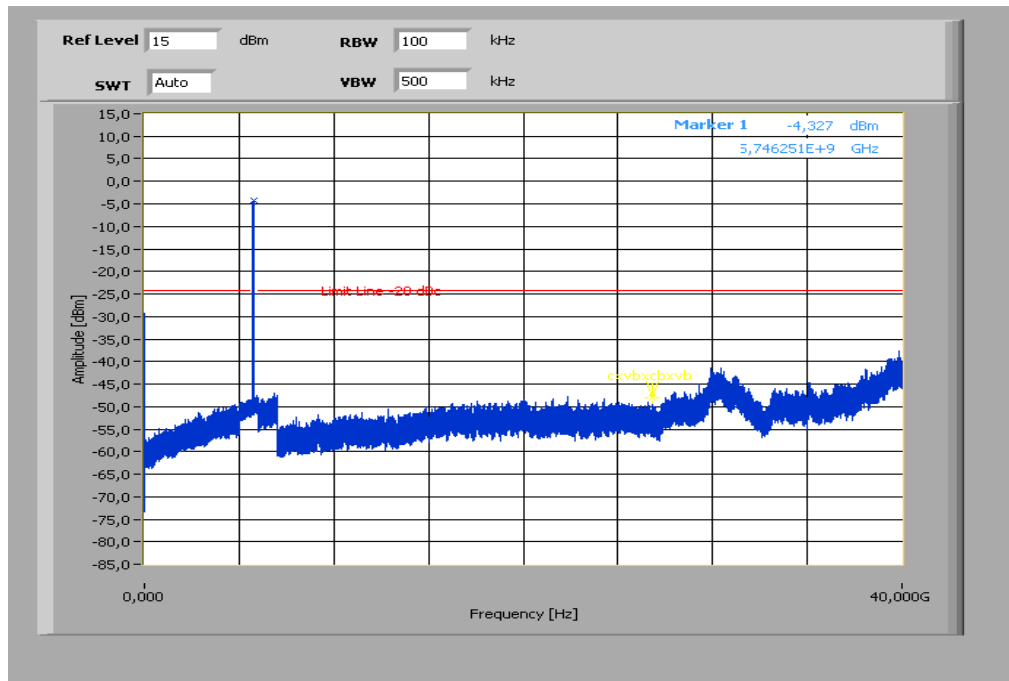

The peak at the beginning of the plot is the LO from the SA.

Plot 2: TX mode, middle channel, up to 40 GHz

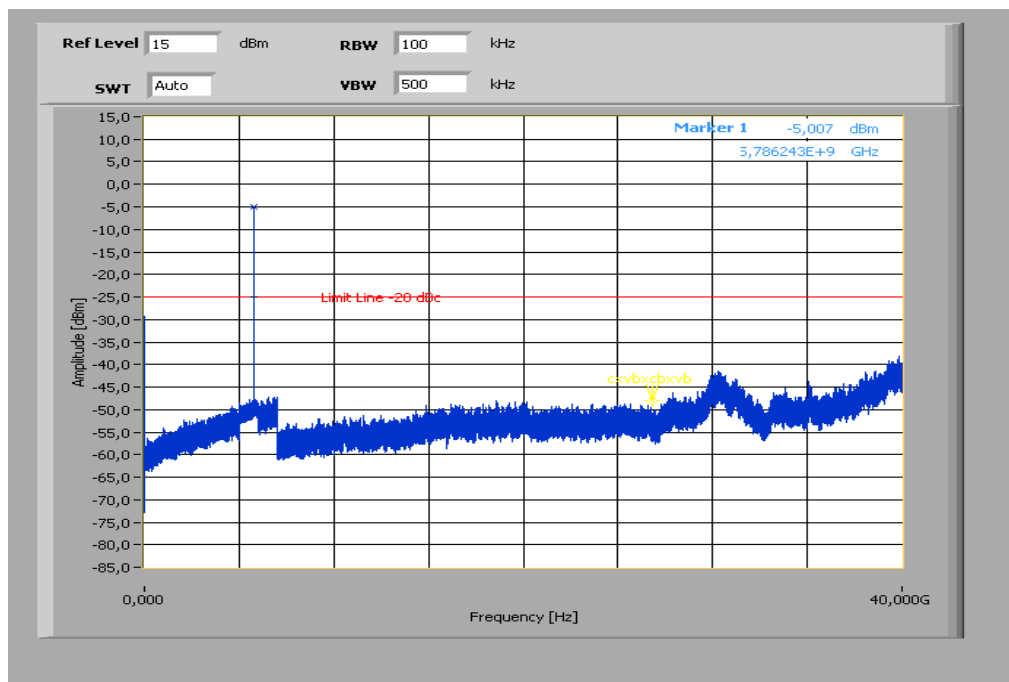

The peak at the beginning of the plot is the LO from the SA.

Plot 3: TX mode, highest channel, up to 40 GHz

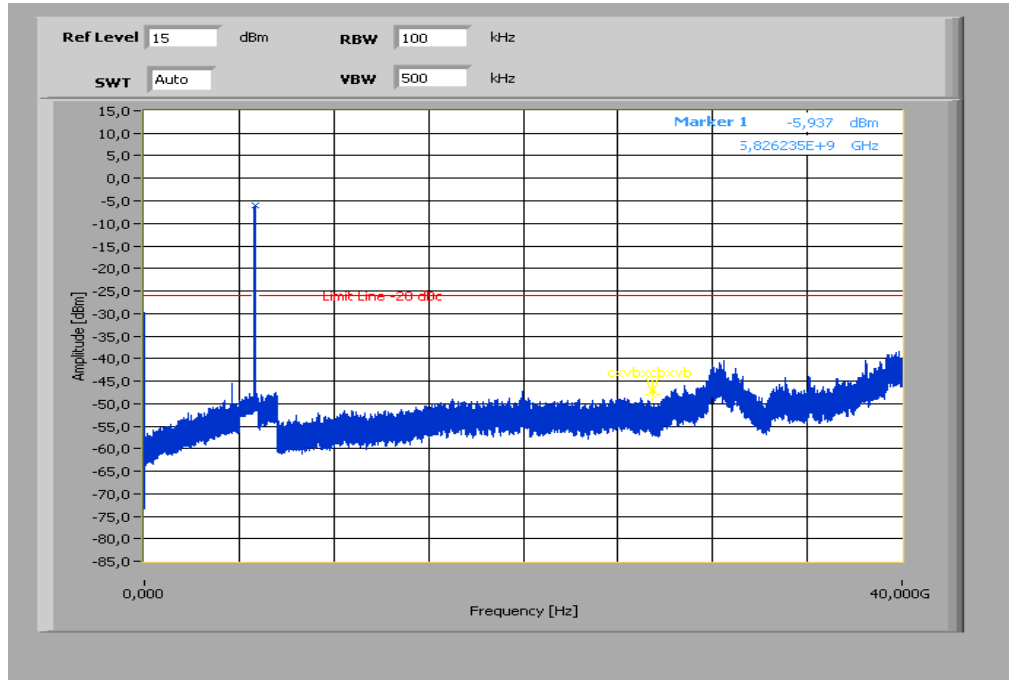

The peak at the beginning of the plot is the LO from the SA.

9.9 TX spurious emissions radiated

Description:

Measurement of the radiated spurious emissions in transmit mode. The measurement is performed at the lowest, middle and highest channel. The measurement is repeated for all modulations.

Measurement:

Measurement parameter	
Detector:	Peak / Quasi Peak / RMS
Sweep time:	Auto
Resolution bandwidth:	F > 1 GHz: 1 MHz F < 1 GHz: 100 kHz
Video bandwidth:	Sweep: 100 kHz Remeasurement: 10 Hz / 3 MHz
Span:	30 MHz to 25 GHz
Trace-Mode:	Max Hold
Measured Modulation	<input checked="" type="checkbox"/> OFDM

The modulation with the highest output power was used to perform the transmitter spurious emissions. If spurious were detected a re-measurement was performed on the detected frequency with each modulation.

Limits:

FCC	IC	
TX Spurious Emissions Radiated		
<p>In any 100 kHz bandwidth outside the frequency band in which the spread spectrum or digitally modulated intentional radiator is operating, the radio frequency power that is produced by the intentional radiator shall be at least 20 dB below that in the 100 kHz bandwidth within the band that contains the highest level of the desired power, based on either an RF conducted or a radiated measurement. Attenuation below the general limits specified in Section 15.209(a) is not required. In addition, radiated emissions which fall in the restricted bands, as defined in §15.205(a), must also comply with the radiated emission limits specified in §15.209(a) (see §15.205(c)).</p>		
Frequency (MHz)	Field Strength (dB μ V/m)	Measurement distance
30 - 88	30.0	10
88 – 216	33.5	10
216 – 960	36.0	10
Above 960	54.0	3

Results: OFDM, antenna port 1

TX Spurious Emissions Radiated [dBµV/m]								
Antenna port 1								
5745 MHz			5785 MHz			5825 MHz		
F [MHz]	Detector	Level [dBµV/m]	F [MHz]	Detector	Level [dBµV/m]	F [MHz]	Detector	Level [dBµV/m]
For emissions below 1 GHz, please take a look at the table below the 1 GHz plot.			For emissions below 1 GHz, please take a look at the table below the 1 GHz plot.			For emissions below 1 GHz, please take a look at the table below the 1 GHz plot.		
All detected peak emissions between 1 GHz and 12.75 GHz are more than 10 dB below the average limit.			All detected peak emissions between 1 GHz and 12.75 GHz are more than 10 dB below the average limit.			All detected peak emissions between 1 GHz and 12.75 GHz are more than 10 dB below the average limit.		
For emissions above 12.75 GHz, please take a look at the plots.			For emissions above 12.75 GHz, please take a look at the plots.			For emissions above 12.75 GHz, please take a look at the plots.		
Measurement uncertainty			± 3 dB					

Result: Passed

Results: OFDM, antenna port 2

TX Spurious Emissions Radiated [dBµV/m]								
Antenna port 2								
5745 MHz			5785 MHz			5825 MHz		
F [MHz]	Detector	Level [dBµV/m]	F [MHz]	Detector	Level [dBµV/m]	F [MHz]	Detector	Level [dBµV/m]
-/-			For emissions below 1 GHz, please take a look at the table below the 1 GHz plot.			-/-		
-/-			All detected peak emissions between 1 GHz and 12.75 GHz are more than 10 dB below the average limit.			-/-		
-/-			For emissions above 12.75 GHz, please take a look at the plots.			-/-		
Measurement uncertainty			± 3 dB					

Result: Passed

Note:

The antenna port 1 shows the same behaviour as antenna port 2 and is measured to see the fulfilment according to the FCC Part 15.247 standard.

Plots: OFDM, antenna port 1

Plot 1: Lowest channel, 30 MHz to 1 GHz, vertical & horizontal polarization

Common Information

EUT: ADN-W AM FM02
 Serial Number: 1462100049
 Test Description: FCC part 15 class B @ 10m
 Operating Conditions: TX 5745 MHz | Ant. 1
 Operator Name: Hennemann
 Comment: powered by main unit

Scan Setup: STAN_Fin [EMI radiated]

Hardware Setup: Electric Field (NOS)
 Receiver: [ESCI 3]
 Level Unit: dBµV/m

Subrange	Step Size	Detectors	IF BW	Meas. Time	Preamp
30 MHz - 2 GHz	60 kHz	QPK	120 kHz	1 s	20 dB

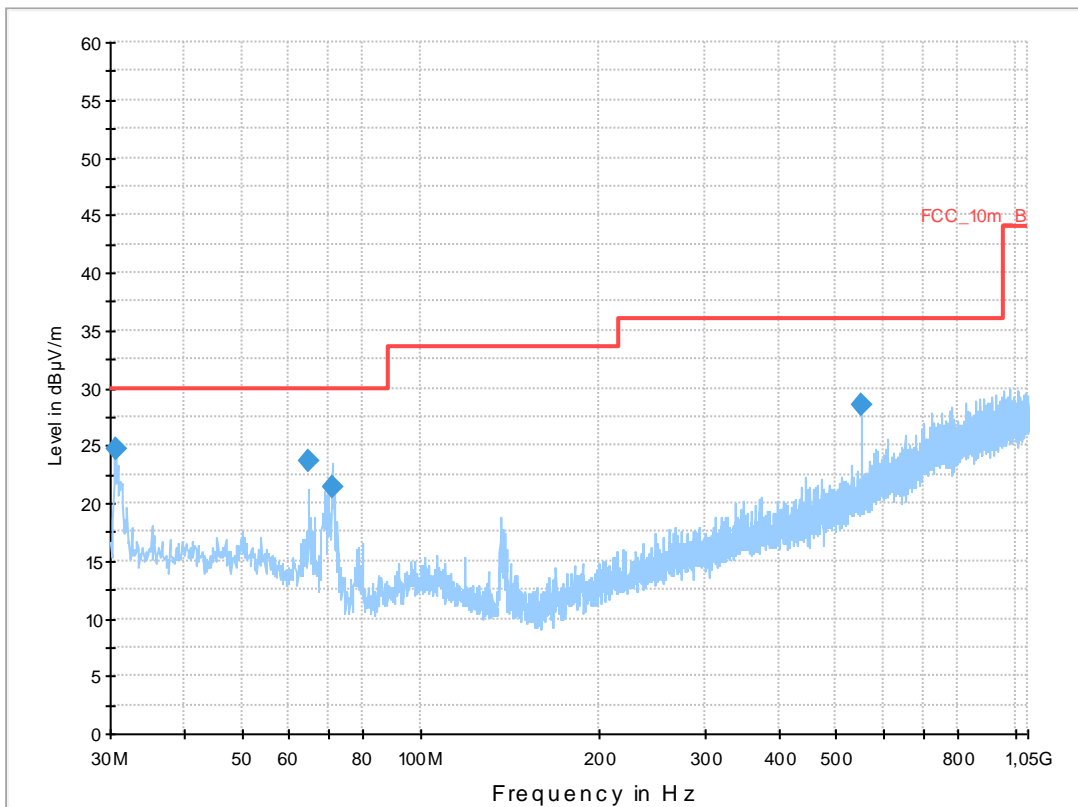

Final Result 1

Frequency (MHz)	QuasiPeak (dBµV/m)	Meas. Time (ms)	Bandwidth (kHz)	Height (cm)	Polarization	Azimuth (deg)	Corr. (dB)	Margin (dB)	Limit (dBµV/m)	Comment
30.628954	24.7	1000.0	120.000	98.0	V	100.0	12.6	5.3	30.0	
64.782600	23.7	1000.0	120.000	170.0	V	10.0	10.5	6.3	30.0	
70.836000	21.5	1000.0	120.000	170.0	V	180.0	9.3	8.5	30.0	
550.020000	28.5	1000.0	120.000	170.0	H	265.0	19.4	7.5	36.0	

Plot 2: Lowest channel, 1 GHz to 12.75 GHz, vertical & horizontal polarization

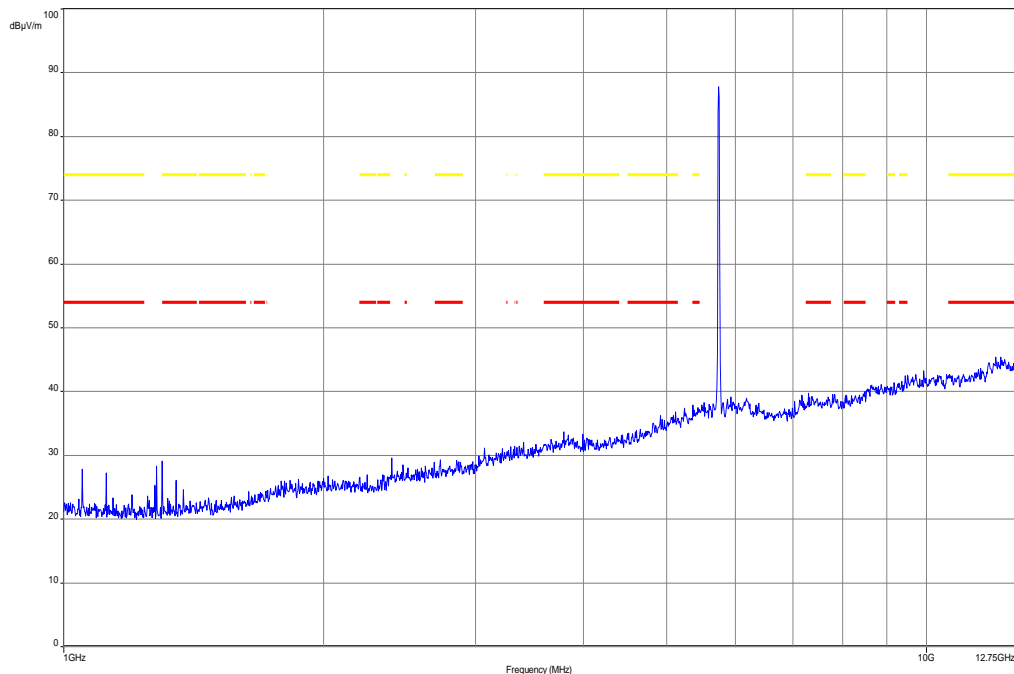

Plot 3: Lowest channel, 12.75 GHz to 18 GHz, vertical & horizontal polarization

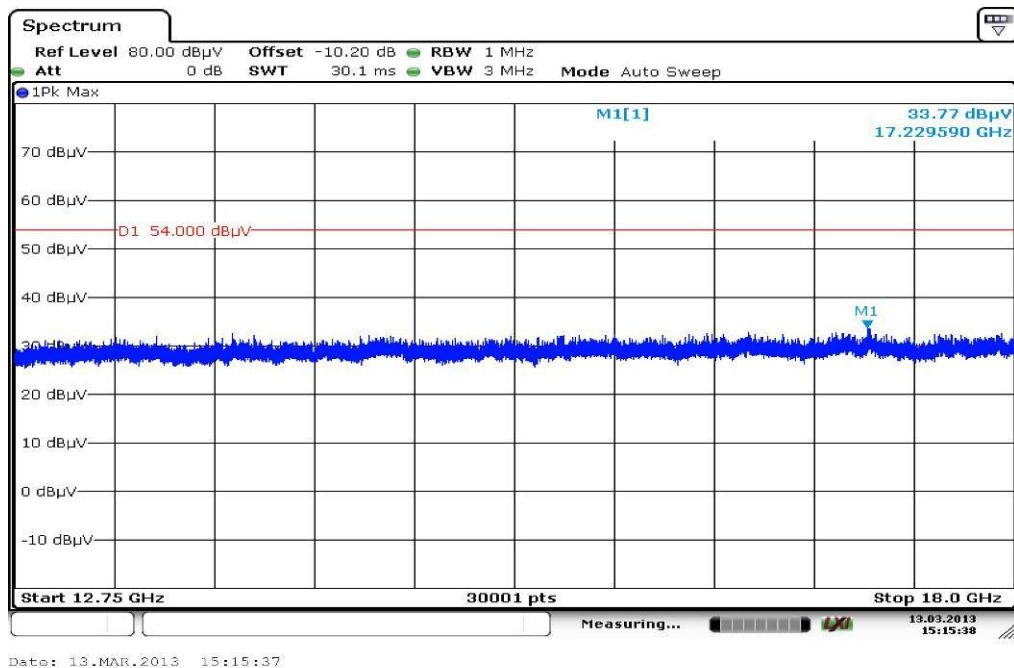

Plot 4: Lowest channel, 18 GHz to 26 GHz, vertical & horizontal polarization

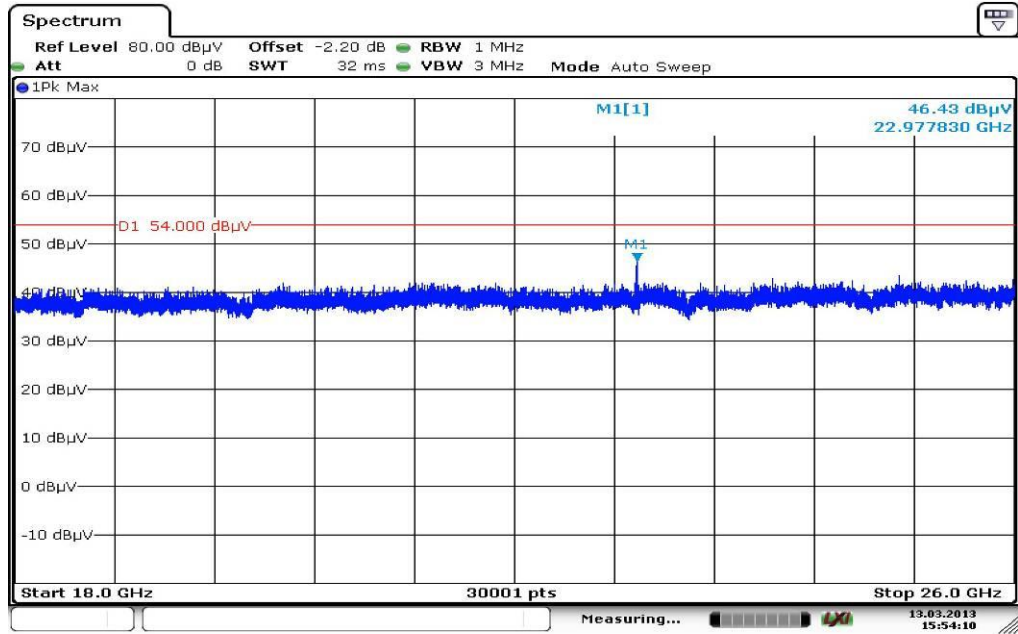

Date: 13.MAR.2013 15:54:11

Plot 5: Lowest channel, 26 GHz to 40 GHz, vertical & horizontal polarization

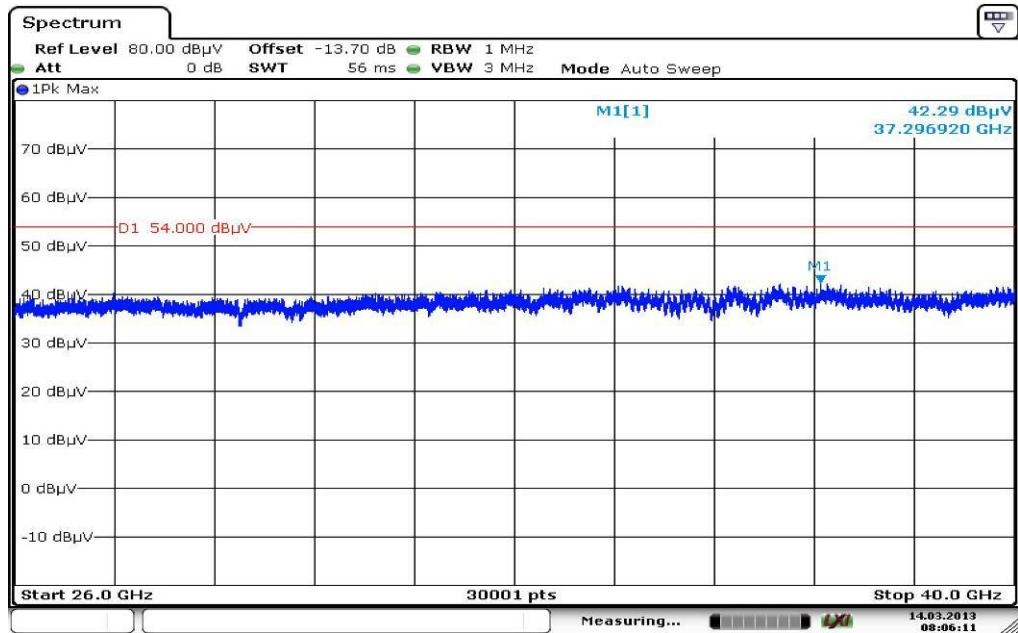

Date: 14.MAR.2013 08:06:12

Plot 6: Middle channel, 30 MHz to 1 GHz, vertical & horizontal polarization

Common Information

EUT: ADN-W AM FM02
 Serial Number: 1462100049
 Test Description: FCC part 15 class B @ 10m
 Operating Conditions: TX 5785 MHz | Ant. 1
 Operator Name: Hennemann
 Comment: powered by main unit

Scan Setup: STAN_Fin [EMI radiated]

Hardware Setup: Electric Field (NOS)
 Receiver: [ESCI 3]
 Level Unit: dBµV/m

Subrange	Step Size	Detectors	IF BW	Meas. Time	Preamp
30 MHz - 2 GHz	60 kHz	QPK	120 kHz	1 s	20 dB

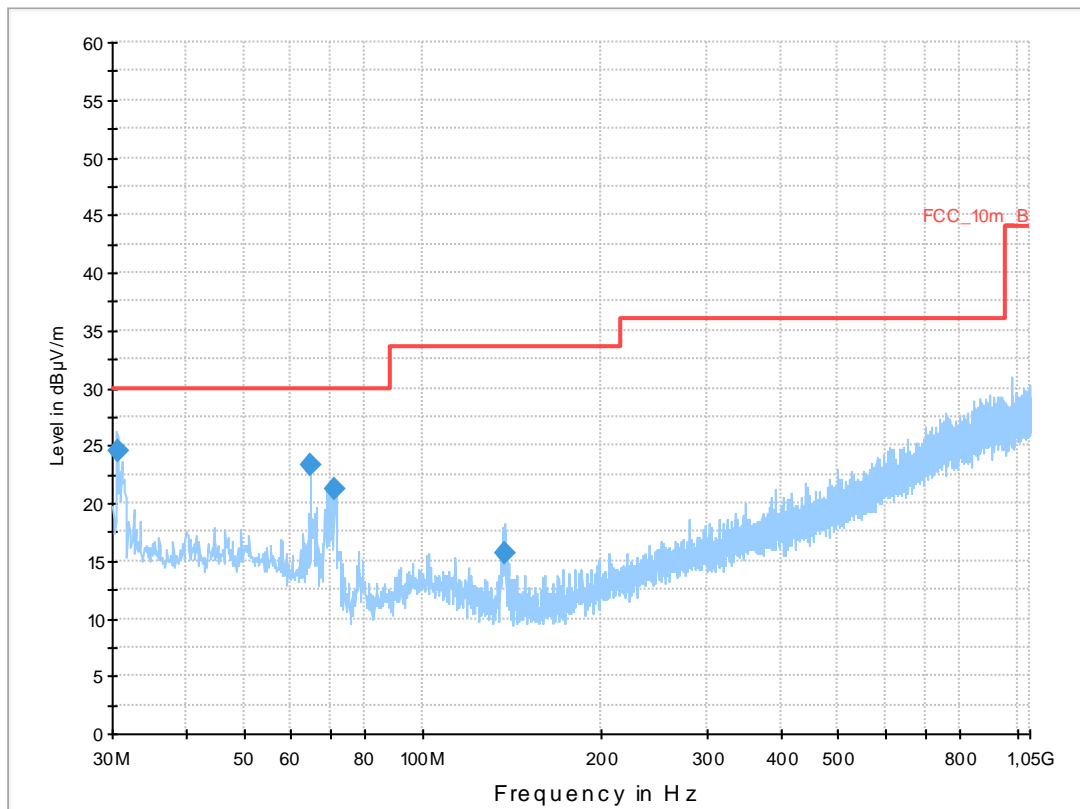

Final Result 1

Frequency (MHz)	QuasiPeak (dBµV/m)	Meas. Time (ms)	Bandwidth (kHz)	Height (cm)	Polarization	Azimuth (deg)	Corr. (dB)	Margin (dB)	Limit (dBµV/m)	Comment
30.636308	24.5	1000.0	120.000	104.0	V	90.0	12.6	5.5	30.0	
64.771050	23.3	1000.0	120.000	170.0	V	10.0	10.5	6.7	30.0	
70.832700	21.3	1000.0	120.000	170.0	V	180.0	9.3	8.7	30.0	
136.899900	15.7	1000.0	120.000	148.0	V	270.0	8.9	17.8	33.5	

Plot 7: Middle channel, 1 GHz to 12.75 GHz, vertical & horizontal polarization

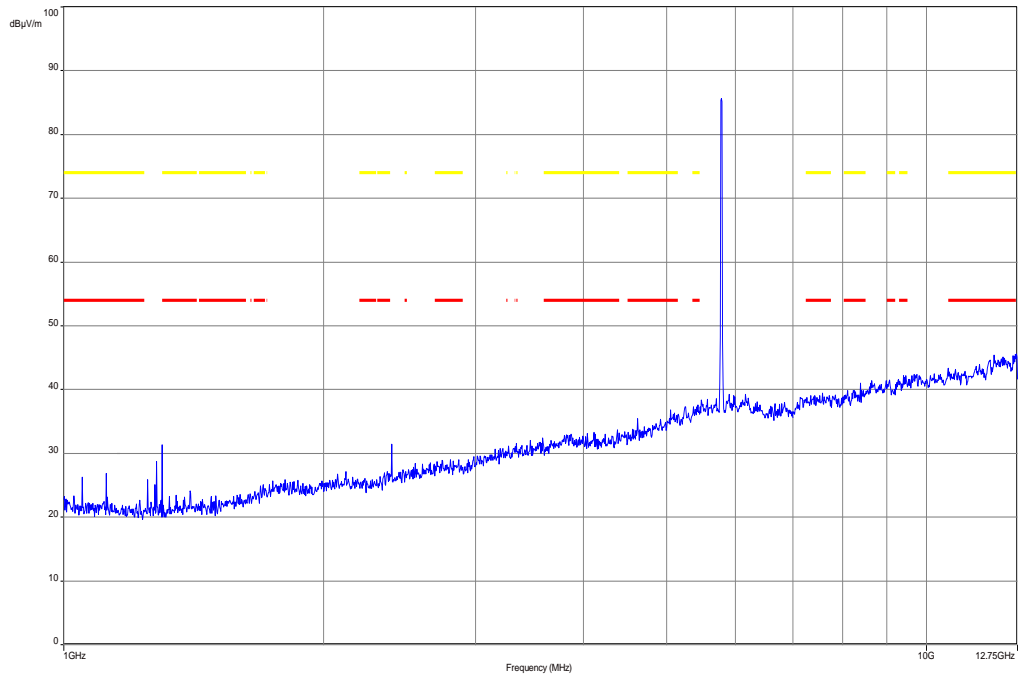

Plot 8: Middle channel, 12.75 GHz to 18 GHz, vertical & horizontal polarization

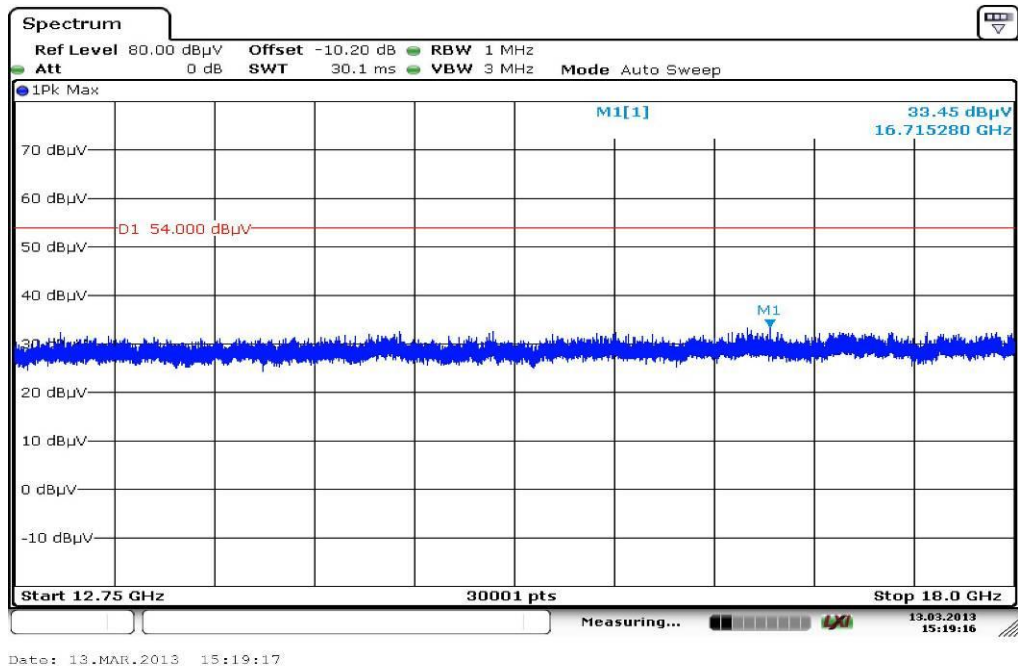

Plot 9: Middle channel, 18 GHz to 26 GHz, vertical & horizontal polarization

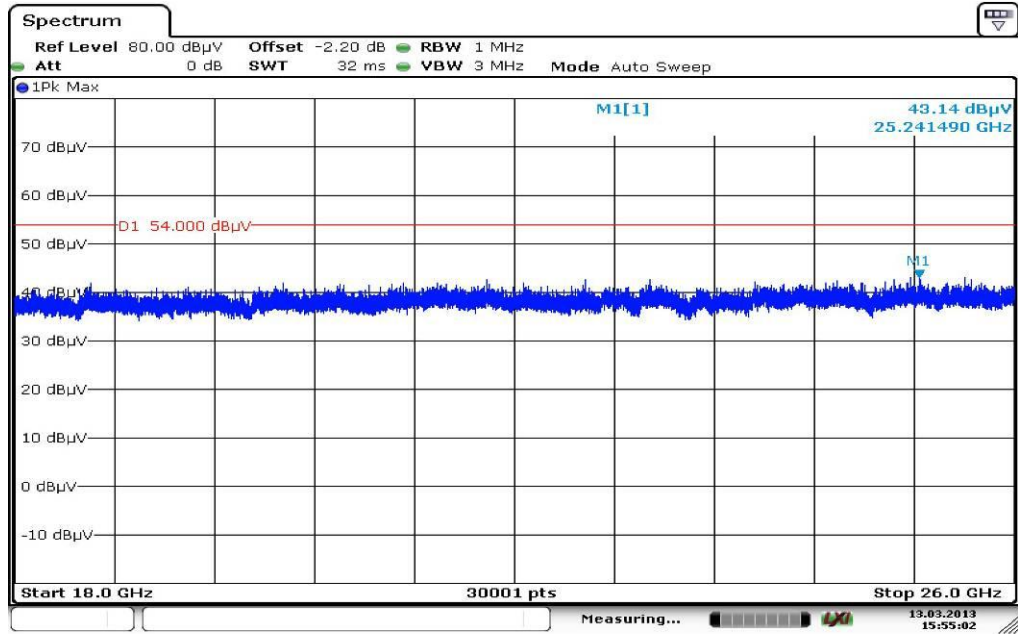

Date: 13.MAR.2013 15:55:02

Plot 10: Middle channel, 26 GHz to 40 GHz, vertical & horizontal polarization

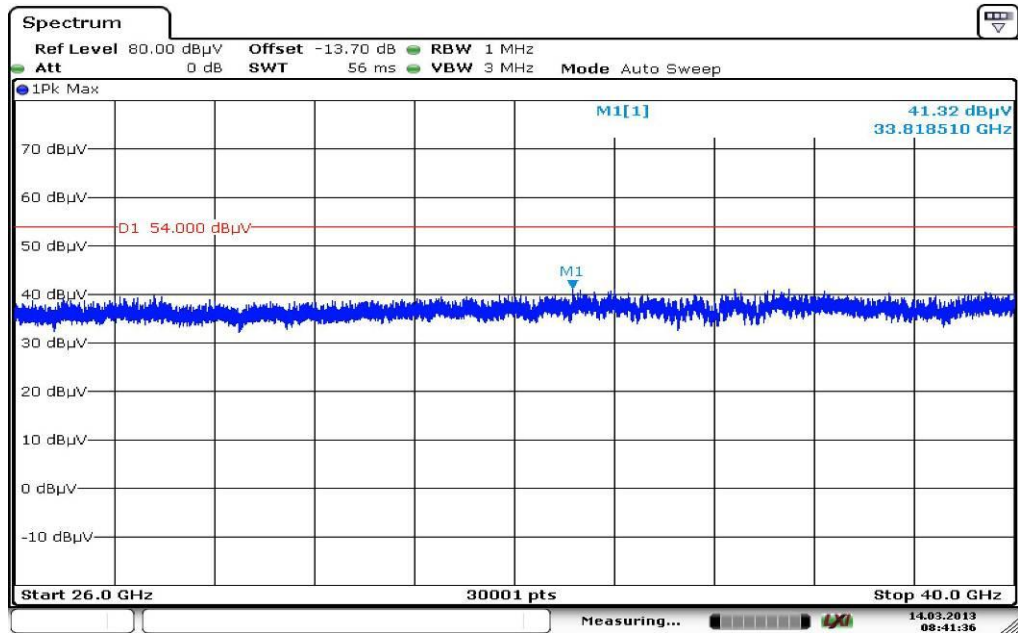

Date: 14.MAR.2013 08:41:36

Plot 11: Highest channel, 30 MHz to 1 GHz, vertical & horizontal polarization

Common Information

EUT: ADN-W AM FM02
 Serial Number: 1462100049
 Test Description: FCC part 15 class B @ 10m
 Operating Conditions: TX 5825 MHz | Ant. 1
 Operator Name: Hennemann
 Comment: powered by main unit

Scan Setup: STAN_Fin [EMI radiated]

Hardware Setup: Electric Field (NOS)
 Receiver: [ESCI 3]
 Level Unit: dBµV/m

Subrange	Step Size	Detectors	IF BW	Meas. Time	Preamp
30 MHz - 2 GHz	60 kHz	QPK	120 kHz	1 s	20 dB

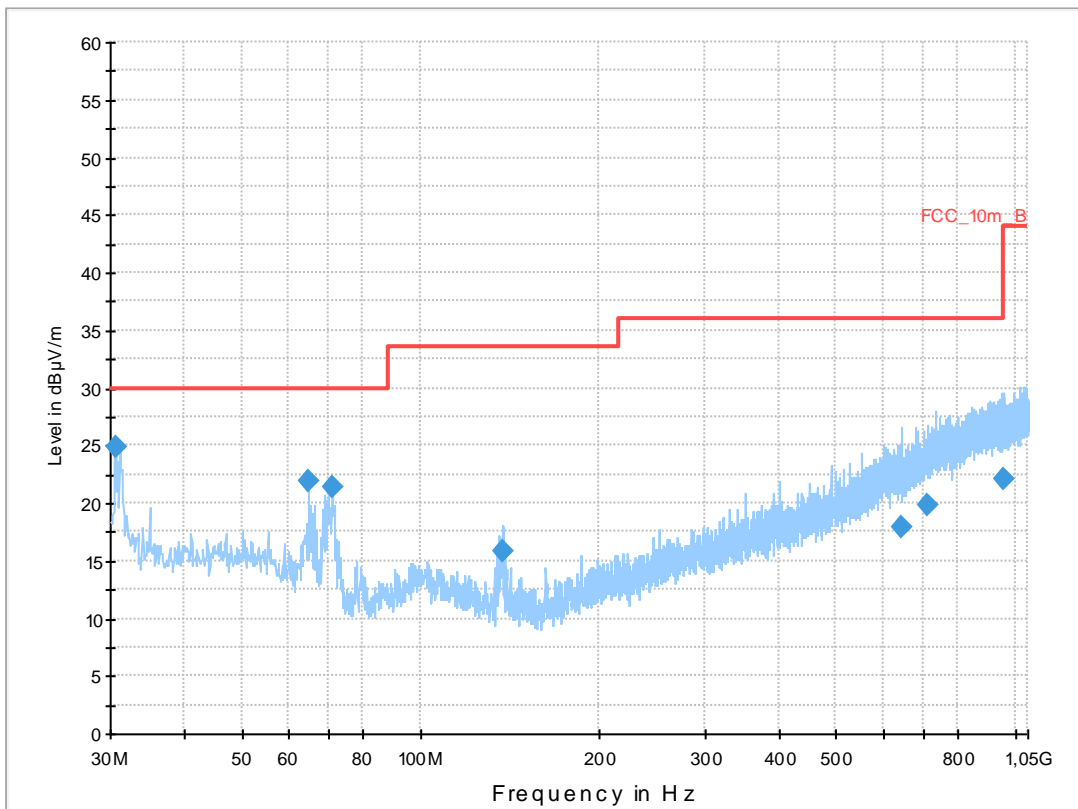

Final Result 1

Frequency (MHz)	QuasiPeak (dBµV/m)	Meas. Time (ms)	Bandwidth (kHz)	Height (cm)	Polarization	Azimuth (deg)	Corr. (dB)	Margin (dB)	Limit (dBµV/m)	Comment
30.602175	24.8	1000.0	120.000	120.0	V	80.0	12.6	5.2	30.0	
64.754250	22.0	1000.0	120.000	143.0	V	100.0	10.5	8.0	30.0	
70.798950	21.4	1000.0	120.000	170.0	V	190.0	9.3	8.6	30.0	
136.902900	15.9	1000.0	120.000	98.0	V	268.0	8.9	17.6	33.5	
642.380850	17.8	1000.0	120.000	170.0	H	2.0	21.1	18.2	36.0	
714.782700	19.7	1000.0	120.000	145.0	V	80.0	22.8	16.3	36.0	
958.919700	22.1	1000.0	120.000	170.0	V	-10.0	25.4	13.9	36.0	

Plot 12: Highest channel, 1 GHz to 12.75 GHz, vertical & horizontal polarization

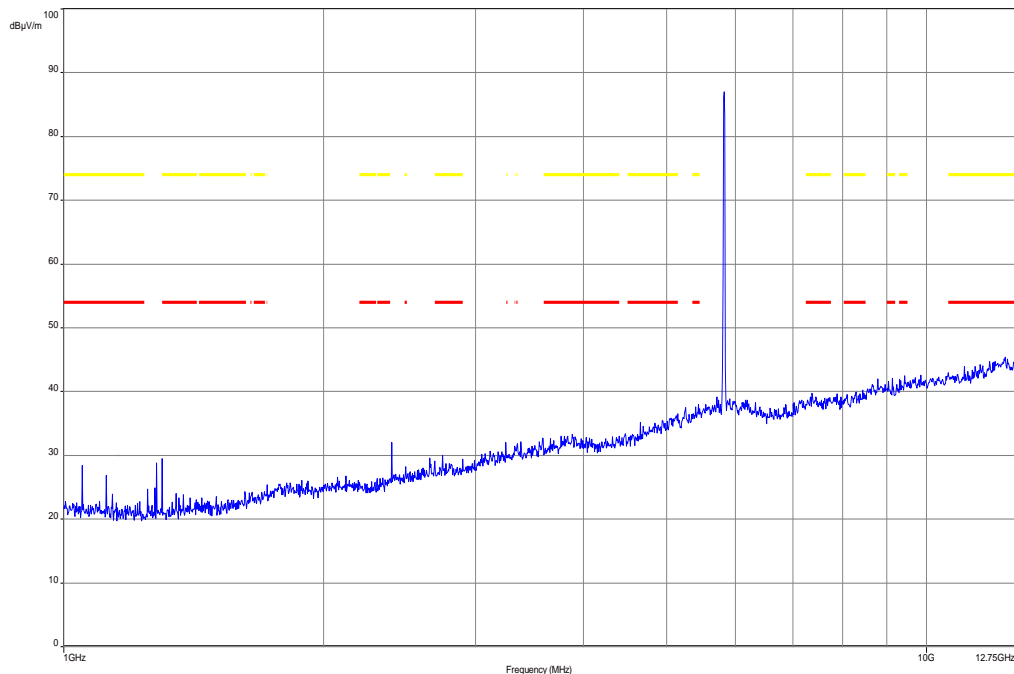

Plot 13: Highest channel, 12.75 GHz to 18 GHz, vertical & horizontal polarization

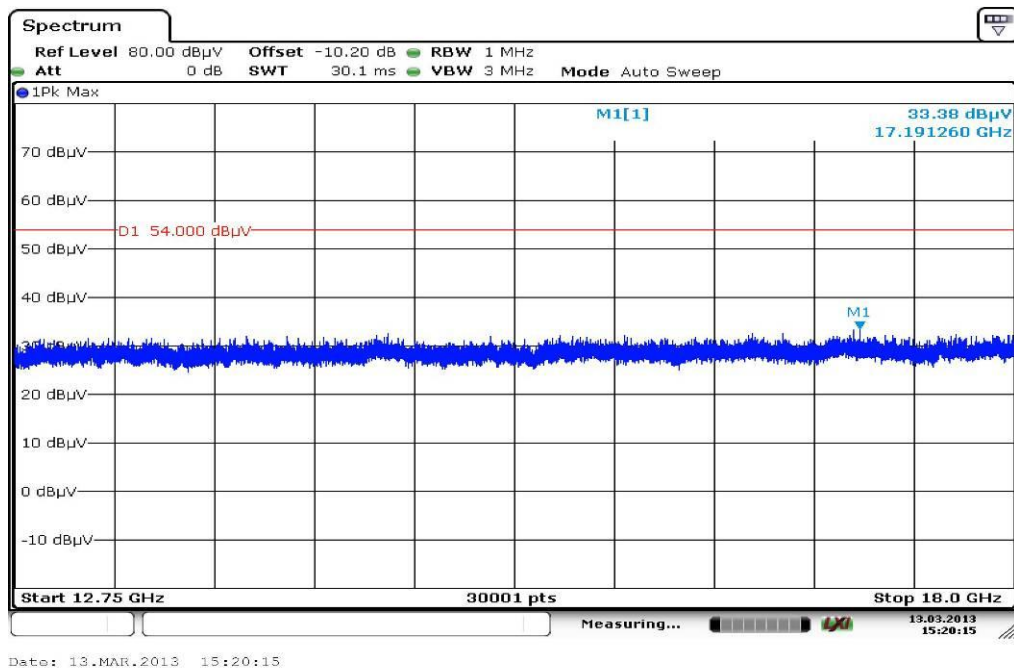

Plot 14: Highest channel, 18 GHz to 26 GHz, vertical & horizontal polarization

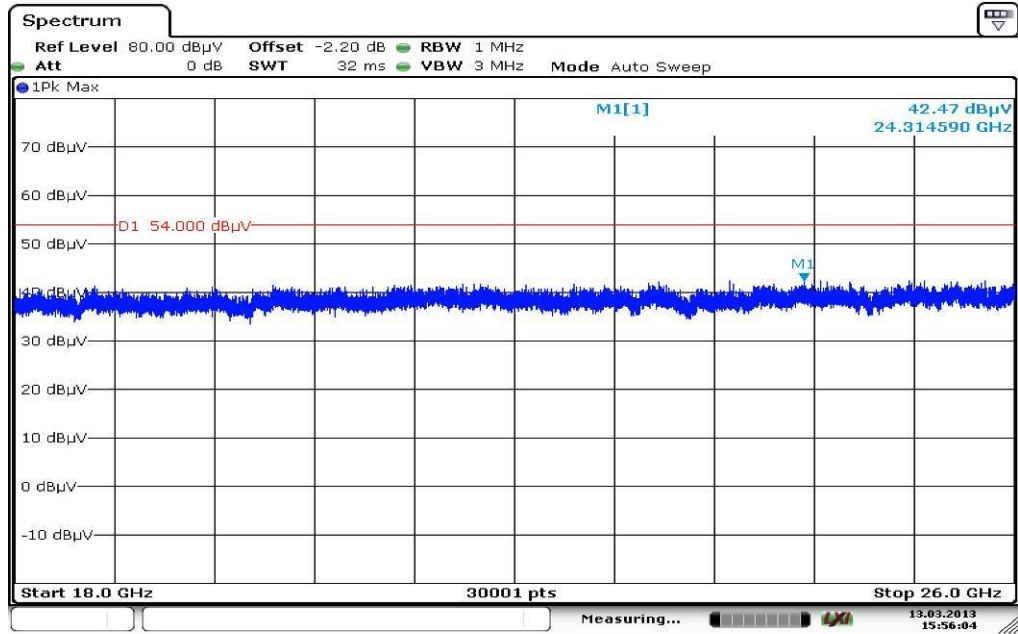

Date: 13.MAR.2013 15:56:05

Plot 15: Highest channel, 26 GHz to 40 GHz, vertical & horizontal polarization

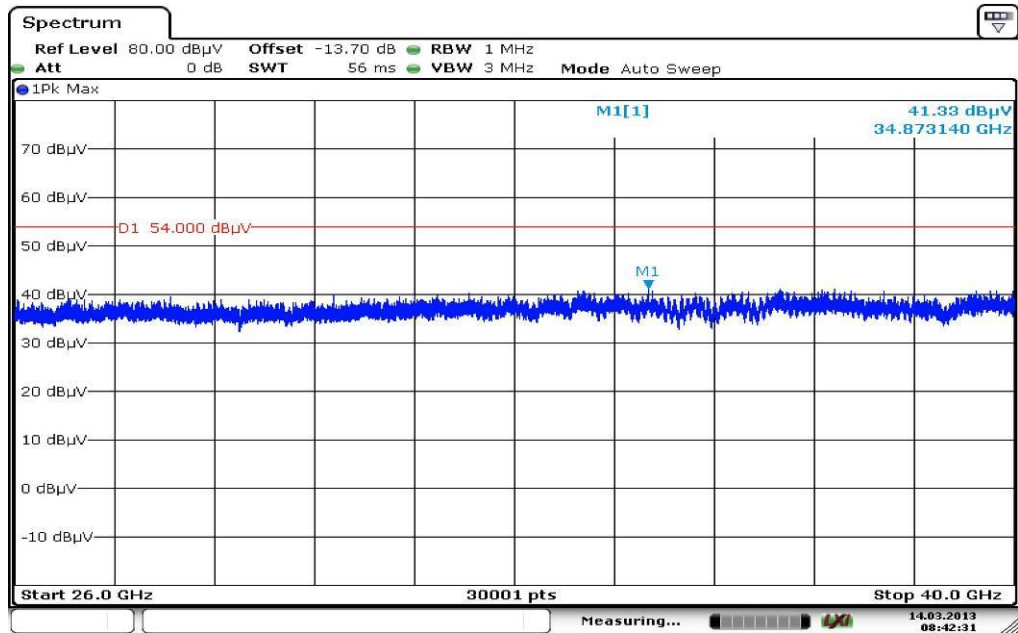

Date: 14.MAR.2013 08:42:31

Plots: OFDM, antenna port 2

Plot 1: Middle channel, 30 MHz to 1 GHz, vertical & horizontal polarization

Common Information

EUT: ADN-W AM FM02
 Serial Number: 1462100049
 Test Description: FCC part 15 class B @ 10m
 Operating Conditions: TX 5785 MHz | Ant. 2
 Operator Name: Hennemann
 Comment: powered by main unit

Scan Setup: STAN_Fin [EMI radiated]

Hardware Setup: Electric Field (NOS)
 Receiver: [ESCI 3]
 Level Unit: dBµV/m

Subrange	Step Size	Detectors	IF BW	Meas. Time	Preamp
30 MHz - 2 GHz	60 kHz	QPK	120 kHz	1 s	20 dB

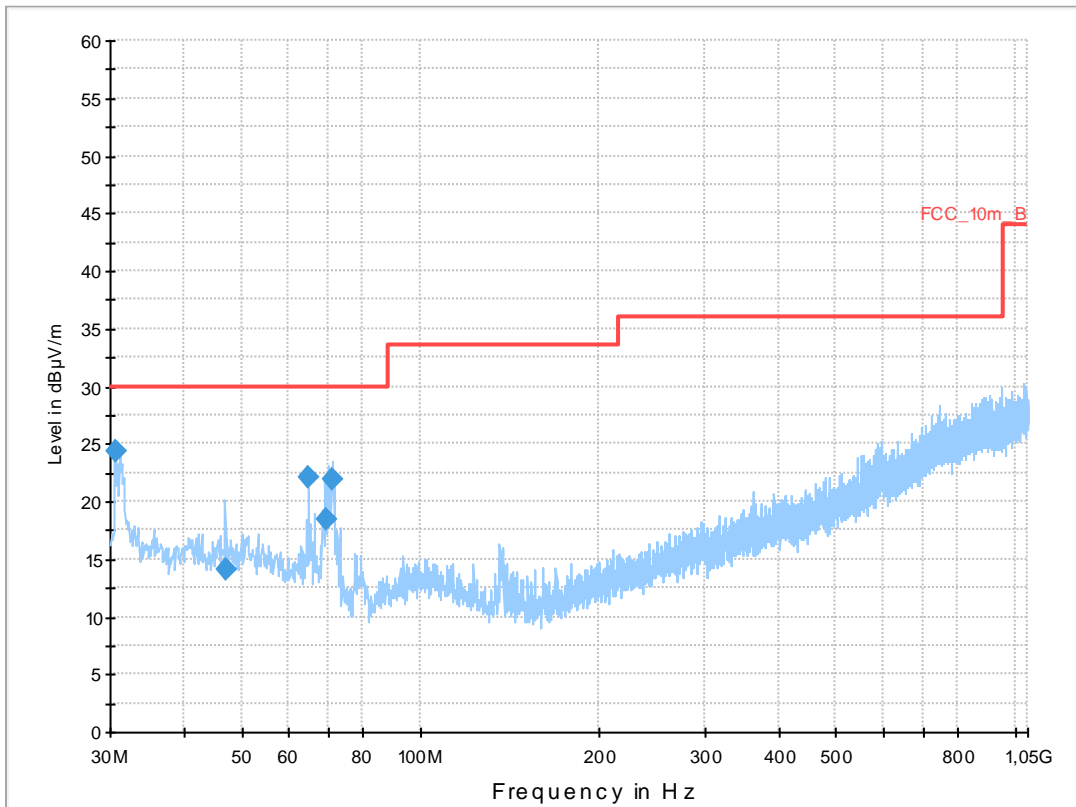

Final Result 1

Frequency (MHz)	QuasiPeak (dBµV/m)	Meas. Time (ms)	Bandwidth (kHz)	Height (cm)	Polarization	Azimuth (deg)	Corr. (dB)	Margin (dB)	Limit (dBµV/m)	Comment
30.624652	24.3	1000.0	120.000	120.0	V	100.0	12.6	5.7	30.0	
47.025600	14.2	1000.0	120.000	112.0	V	178.0	13.3	15.8	30.0	
64.777950	22.1	1000.0	120.000	170.0	V	170.0	10.5	7.9	30.0	
69.132900	18.4	1000.0	120.000	153.0	V	10.0	9.5	11.6	30.0	
70.805550	21.8	1000.0	120.000	170.0	V	180.0	9.3	8.2	30.0	

Plot 2: Middle channel, 1 GHz to 12.75 GHz, vertical & horizontal polarization

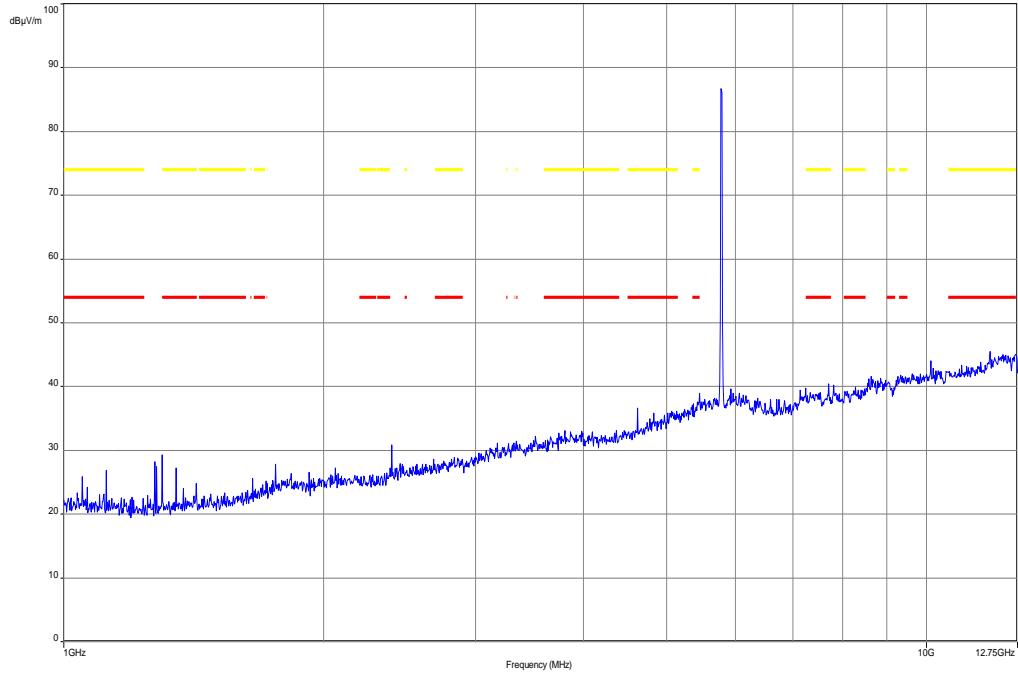

Plot 3: Middle channel, 12.75 GHz to 18 GHz, vertical & horizontal polarization

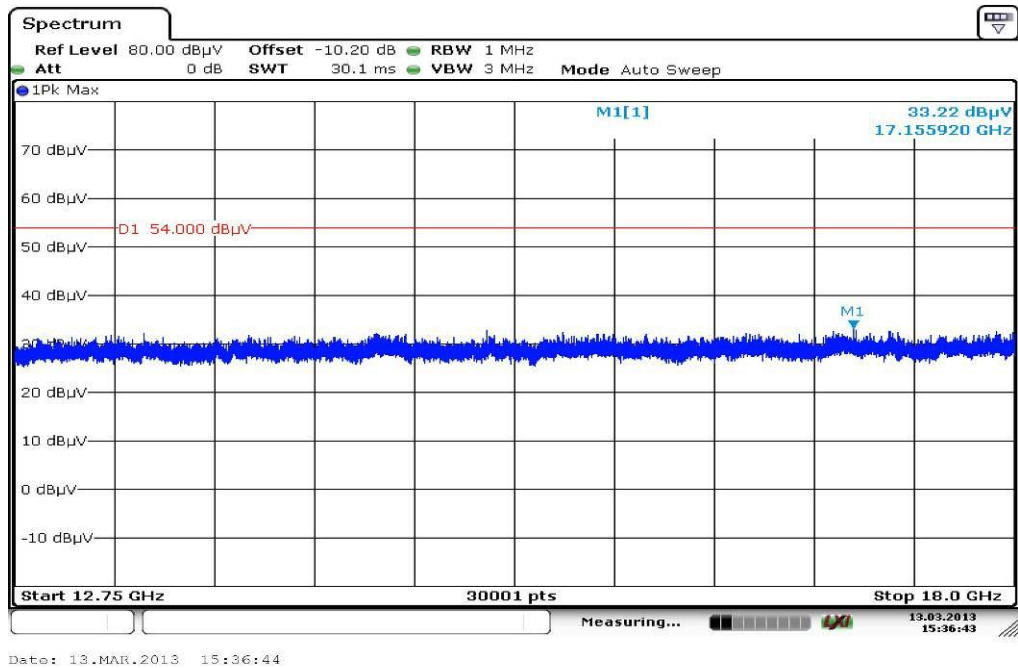

Plot 4: Middle channel, 18 GHz to 26 GHz, vertical & horizontal polarization

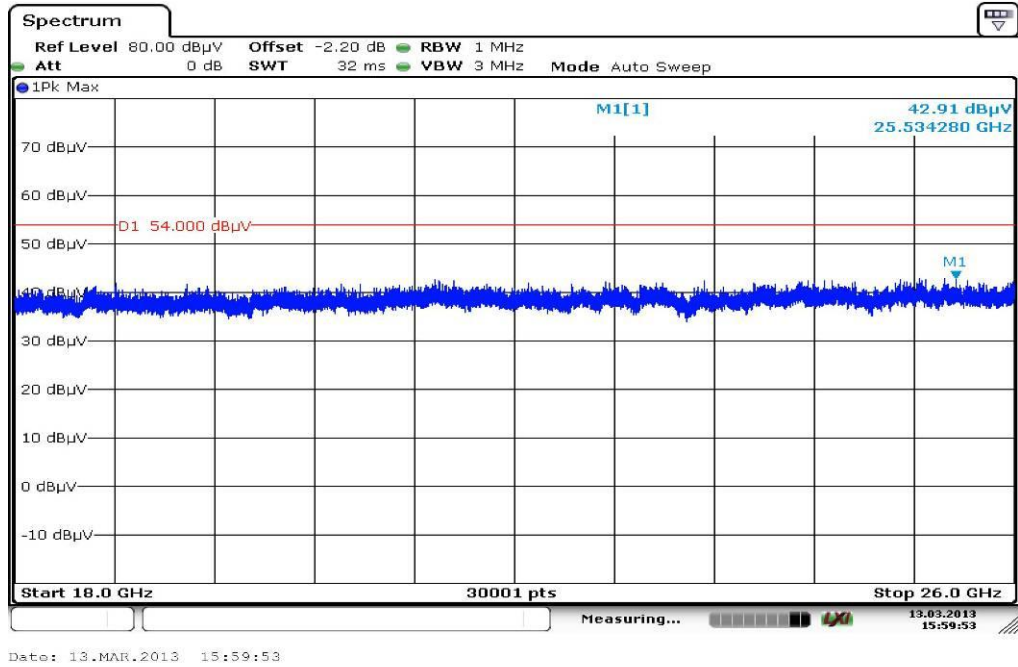

Plot 5: Middle channel, 26 GHz to 40 GHz, vertical & horizontal polarization

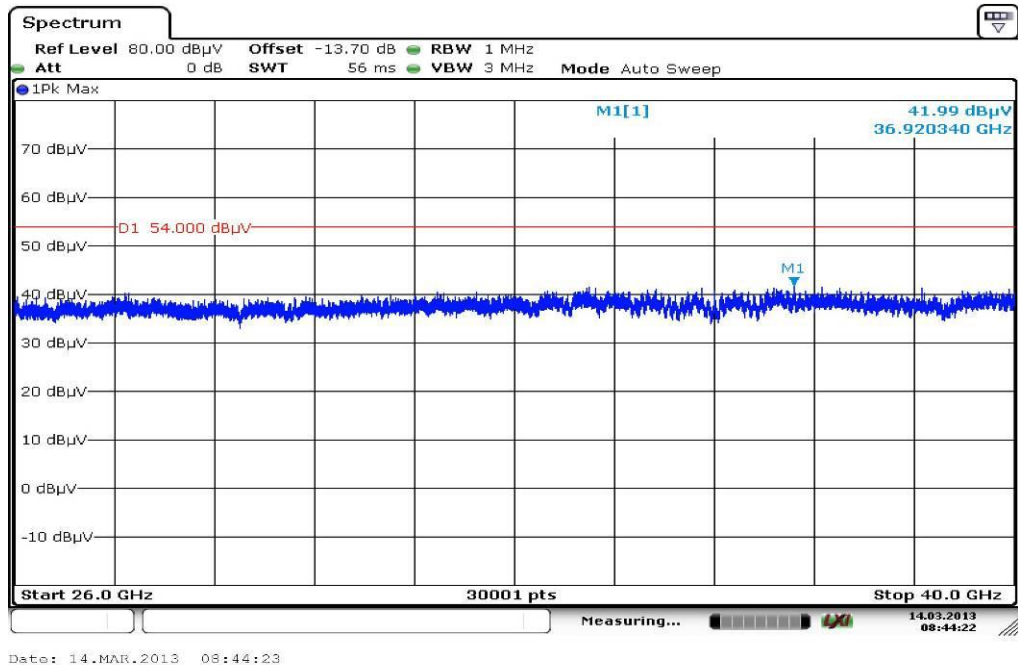

9.10 Unintentional radiator spurious emissions radiated

Description:

Measurement of the radiated spurious emissions in idle/receive mode. The results are valid for both modes.

Measurement:

Measurement parameter	
Detector:	Peak / Quasi Peak / RMS
Sweep time:	Auto
Resolution bandwidth:	F > 1 GHz: 1 MHz F < 1 GHz: 100 kHz
Video bandwidth:	Sweep: 100 kHz Remeasurement: 10 Hz / 3 MHz
Span:	30 MHz to 25 GHz
Trace-Mode:	Max Hold

Limits:

FCC		IC	
Unintentional radiator spurious emissions radiated			
Frequency (MHz)	Field Strength (dBµV/m)	Measurement distance	
30 - 88	30.0	10	
88 – 216	33.5	10	
216 – 960	36.0	10	
Above 960	54.0	3	

Results:

Unintentional radiator spurious emissions radiated [dBµV/m]		
F [MHz]	Detector	Level [dBµV/m]
For emissions below 1 GHz, please take a look at the table below the 1 GHz plot.		
All detected peak emissions between 1 GHz and 12.75 GHz are more than 10 dB below the average limit.		
For emissions above 12.75 GHz, please take a look at the plots.		
Measurement uncertainty	± 3 dB	

Result: Passed.

Plots:

Plot 1: 30 MHz to 1 GHz, vertical & horizontal polarization

Common Information

EUT: ADN-W AM FM02
 Serial Number: 1462100048
 Test Description: FCC part 15 class B @ 10m
 Operating Conditions: RX | Ant. 1
 Operator Name: Hennemann
 Comment: powered by main unit

Scan Setup: STAN_Fin [EMI radiated]

Hardware Setup: Electric Field (NOS)
 Receiver: [ESCI 3]
 Level Unit: dBµV/m

Subrange	Step Size	Detectors	IF BW	Meas. Time	Preamp
30 MHz - 2 GHz	60 kHz	QPK	120 kHz	1 s	20 dB

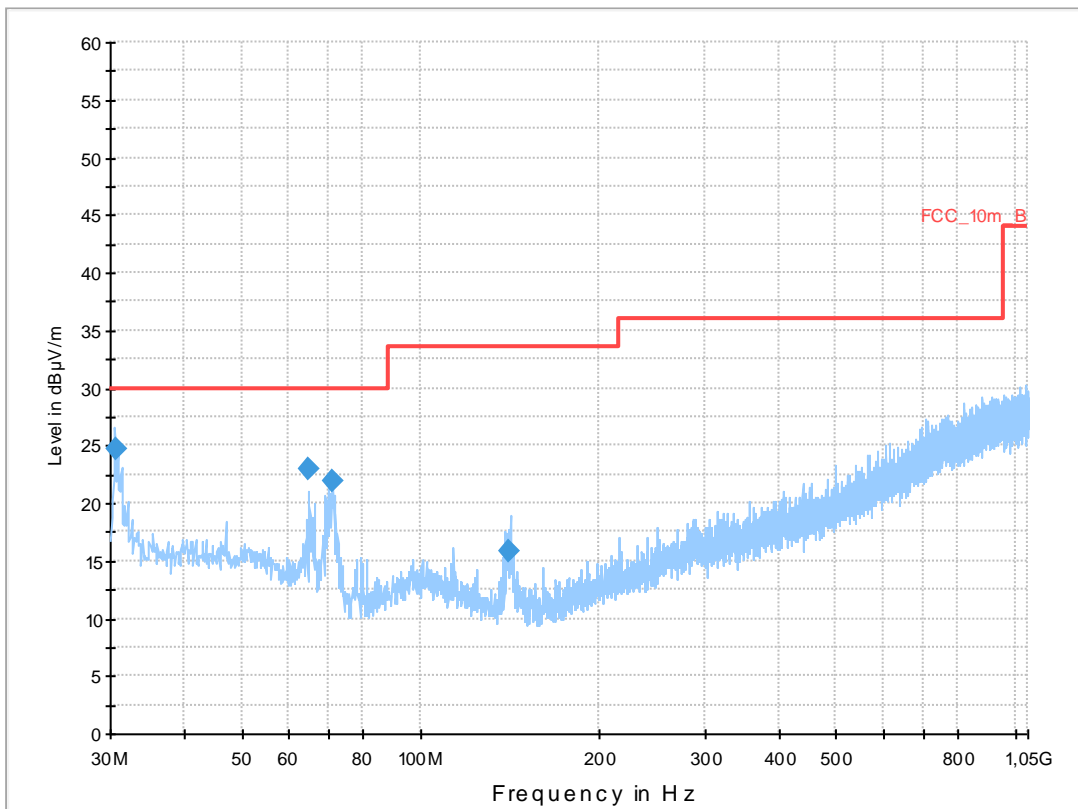

Final Result 1

Frequency (MHz)	QuasiPeak (dBµV/m)	Meas. Time (ms)	Bandwidth (kHz)	Height (cm)	Polarization	Azimuth (deg)	Corr. (dB)	Margin (dB)	Limit (dBµV/m)	Comment
30.631590	24.7	1000.0	120.000	98.0	V	88.0	12.6	5.3	30.0	
64.795950	22.9	1000.0	120.000	163.0	V	88.0	10.5	7.1	30.0	
70.813500	21.9	1000.0	120.000	152.0	V	260.0	9.3	8.1	30.0	
141.150900	15.8	1000.0	120.000	111.0	V	261.0	8.7	17.7	33.5	

Plot 2: 1 GHz to 12.75 GHz, vertical & horizontal polarization

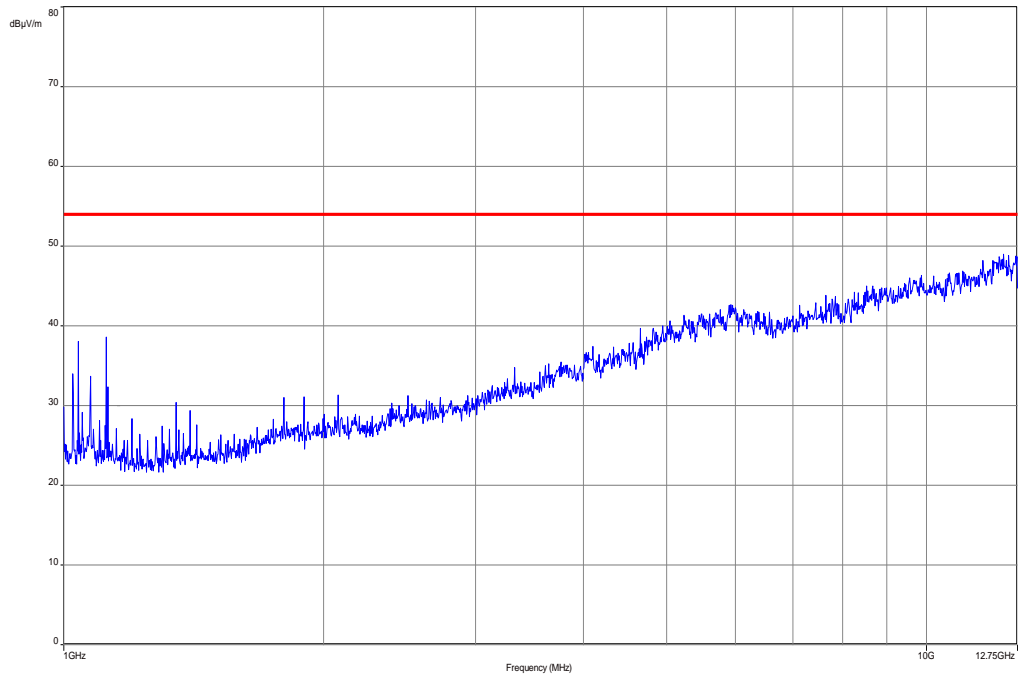

Plot 3: 12.75 GHz to 18 GHz, vertical & horizontal polarization

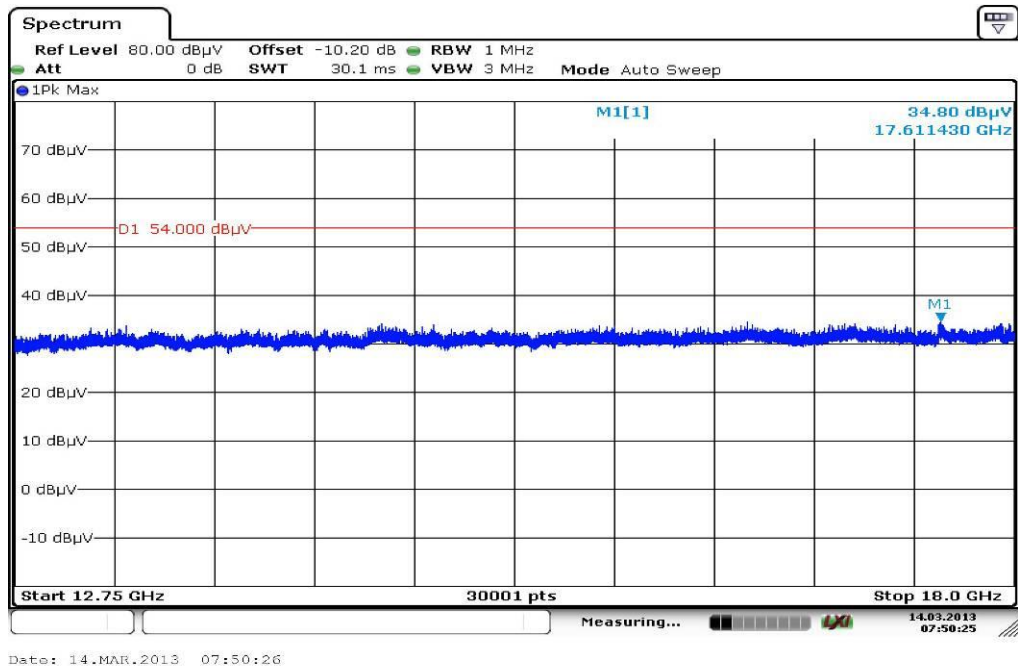

Plot 4: 18 GHz to 26 GHz, vertical & horizontal polarization

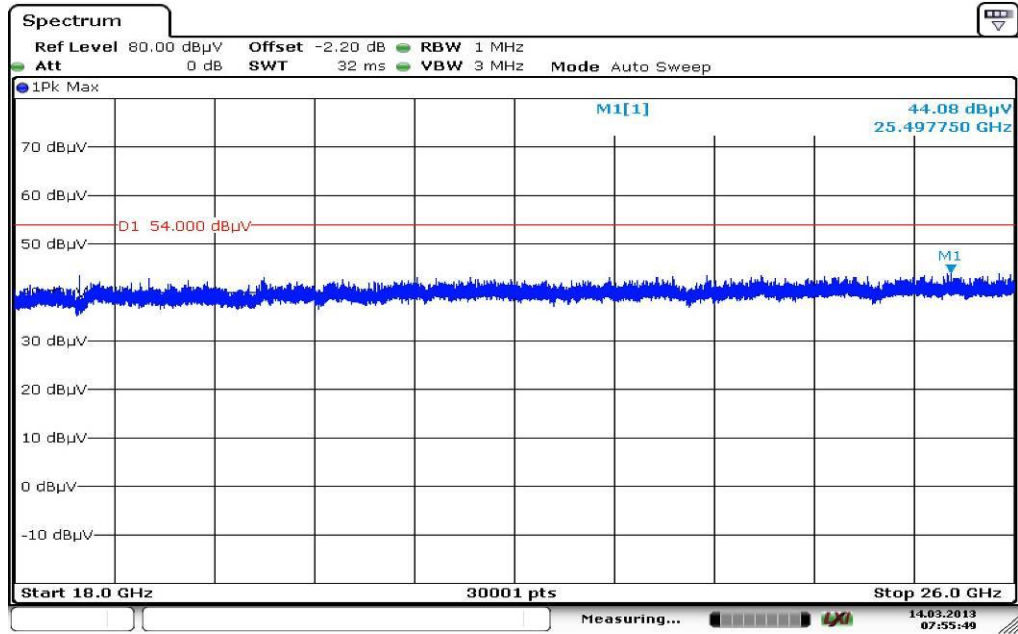

Date: 14.MAR.2013 07:55:49

Plot 5: 26 GHz to 40 GHz, vertical & horizontal polarization

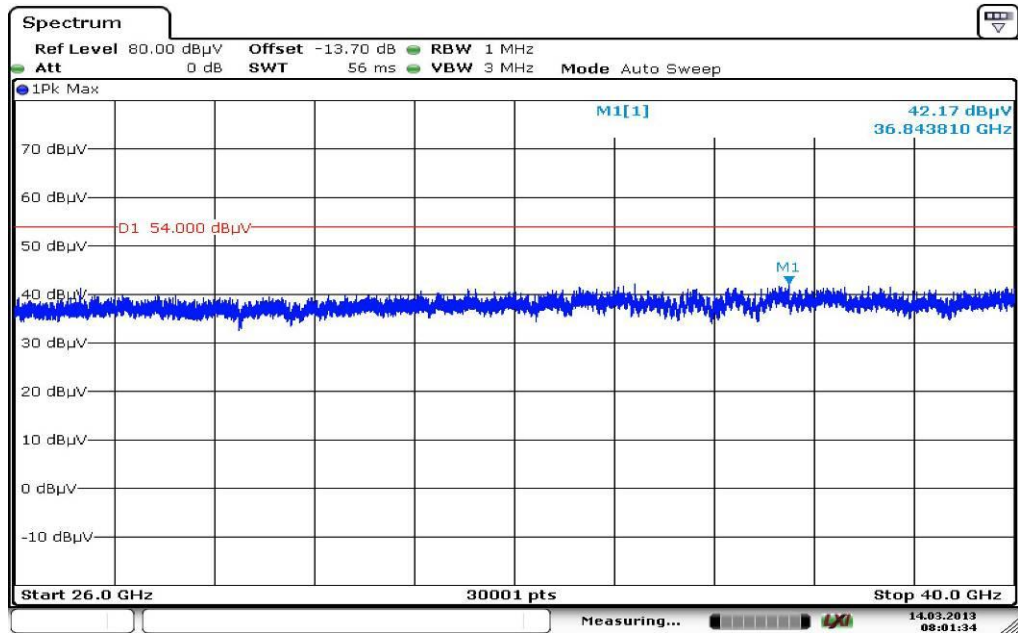

Date: 14.MAR.2013 08:01:35

9.11 Spurious emissions radiated < 30 MHz

Description:

Measurement of the radiated spurious emissions in transmit mode below 30 MHz. The EUT is set to mid channel. This measurement is representative for all channels and modes. If critical peaks are found the lowest channel and the highest channel will be measured too. The measurement is performed with the data rate producing the highest output power. The limits are recalculated to a measurement distance of 3 m with 40 dB/decade according CFR Part 2.

Measurement:

Measurement parameter	
Detector:	Peak / Quasi Peak
Sweep time:	Auto
Video bandwidth:	F < 150 kHz: 200 Hz F > 150 kHz: 9 kHz
Resolution bandwidth:	F < 150 kHz: 1 kHz F > 150 kHz: 100 kHz
Span:	9 kHz to 30 MHz
Trace-Mode:	Max Hold

Limits:

FCC		IC
Spurious Emissions Radiated < 30 MHz		
Frequency (MHz)	Field Strength (dBµV/m)	Measurement distance
0.009 – 0.490	2400/F(kHz)	300
0.490 – 1.705	24000/F(kHz)	30
1.705 – 30.0	30	30

Results:

Spurious Emissions Radiated < 30 MHz [dBµV/m]		
F [MHz]	Detector	Level [dBµV/m]
No peaks detected.		
Measurement uncertainty	± 3 dB	

Result: Passed

Plots: TX mode

Plot 1: 9 kHz to 30 MHz

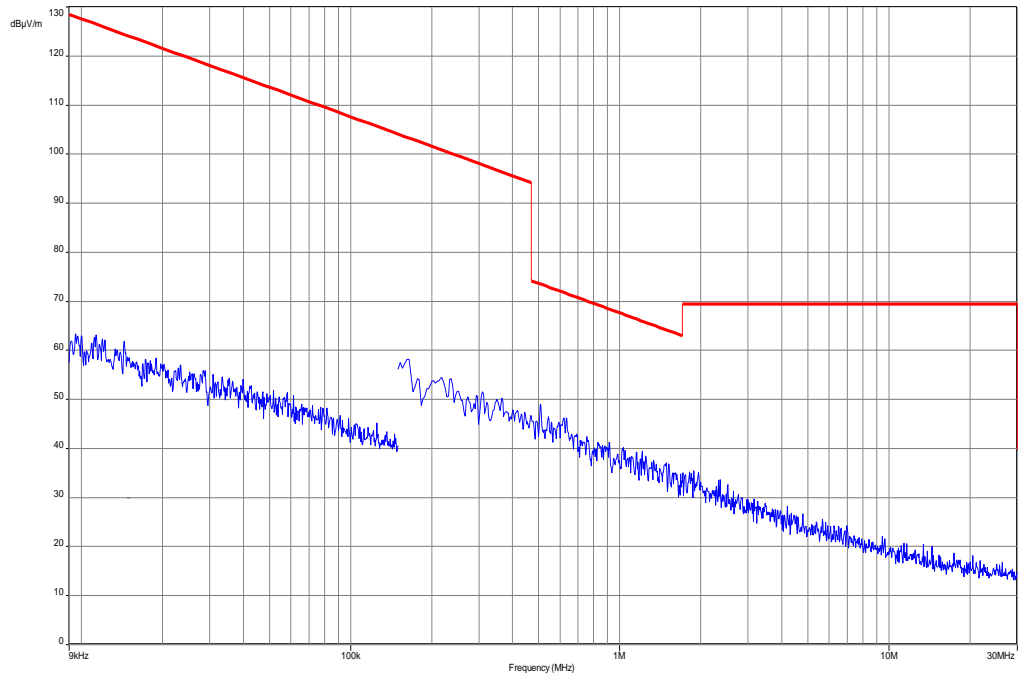

Plots: RX / Idle – mode

Plot 1: 9 kHz to 30 MHz

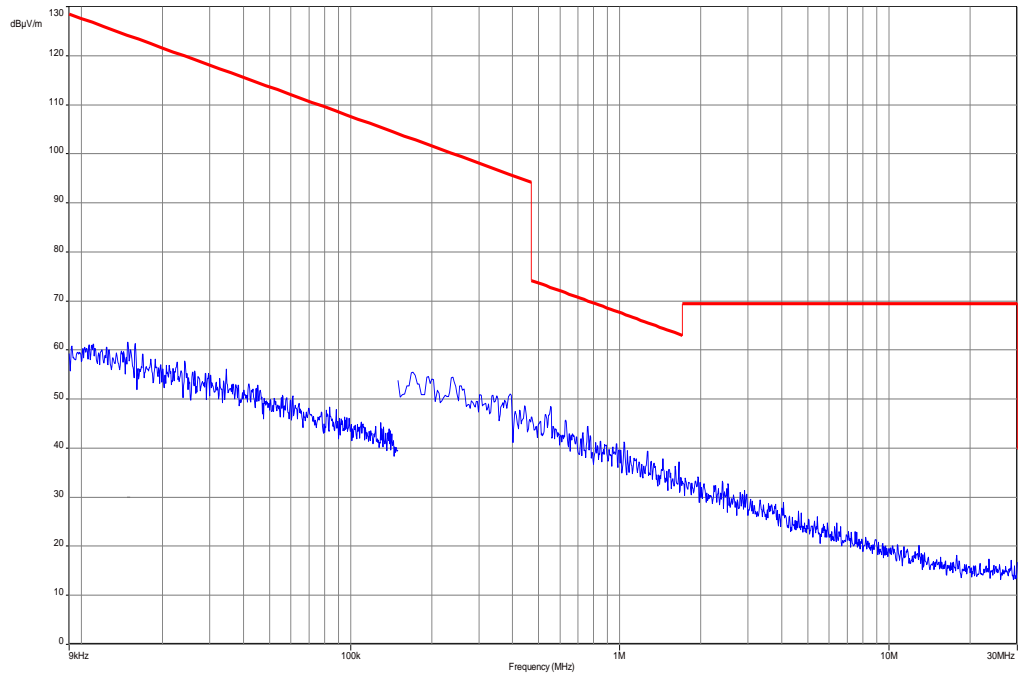

9.12 Spurious emissions conducted < 30 MHz

Description:

Measurement of the conducted spurious emissions in transmit mode below 30 MHz. The EUT is set to mid channel. If critical peaks are found the lowest channel and the highest channel will be measured too. The measurement is performed with the data rate producing the highest output power. Both power lines, phase and neutral line, are measured. Found peaks are re-measured with average and quasi peak detection to show compliance to the limits.

Measurement:

Measurement parameter	
Detector:	Peak - Quasi Peak / Average
Sweep time:	Auto
Video bandwidth:	F < 150 kHz: 200 Hz F > 150 kHz: 9 kHz
Resolution bandwidth:	F < 150 kHz: 1 kHz F > 150 kHz: 100 kHz
Span:	9 kHz to 30 MHz
Trace-Mode:	Max Hold

Limits:

FCC		IC	
Spurious Emissions Conducted < 30 MHz			
Frequency (MHz)	Quasi-Peak (dB μ V/m)	Average (dB μ V/m)	
0.15 – 0.5	66 to 56*	56 to 46*	
0.5 – 5	56	46	
5 – 30.0	60	50	

*Decreases with the logarithm of the frequency

Results:

Spurious Emissions Conducted < 30 MHz [dB μ V/m]		
F [MHz]	Detector	Level [dB μ V/m]
All detected peaks are below the limit. Please take a look at zoomed plots.		
Measurement uncertainty	± 3 dB	

Result: Passed

Plots:

Plot 1: TX mode, 150 kHz to 30 MHz, phase line

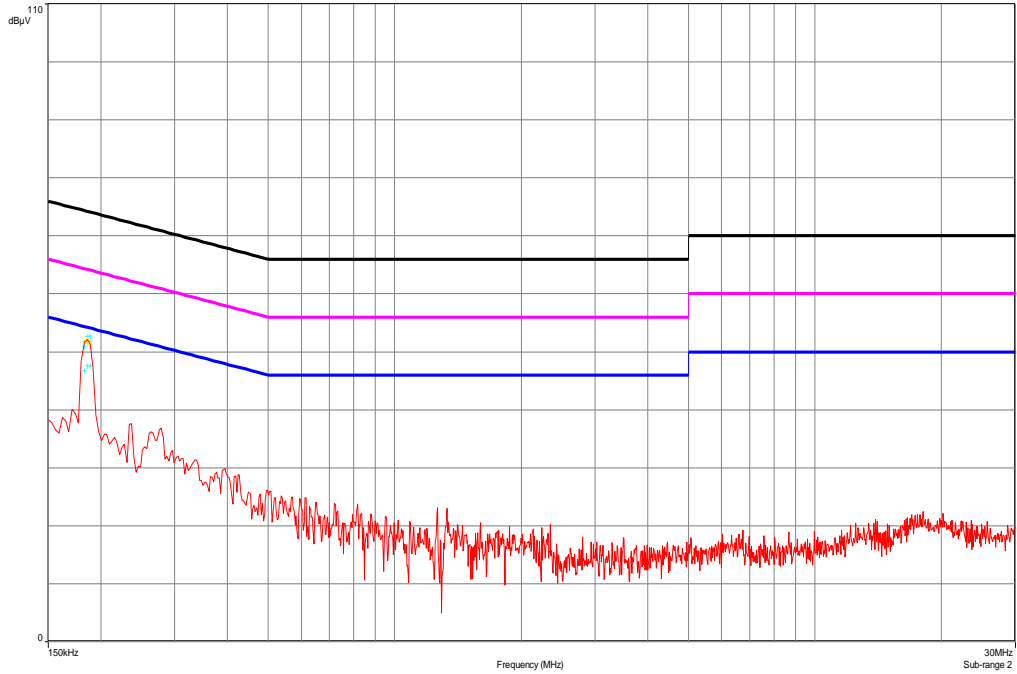

Plot 2: TX mode, 150 kHz to 30 MHz, phase line, zoomed

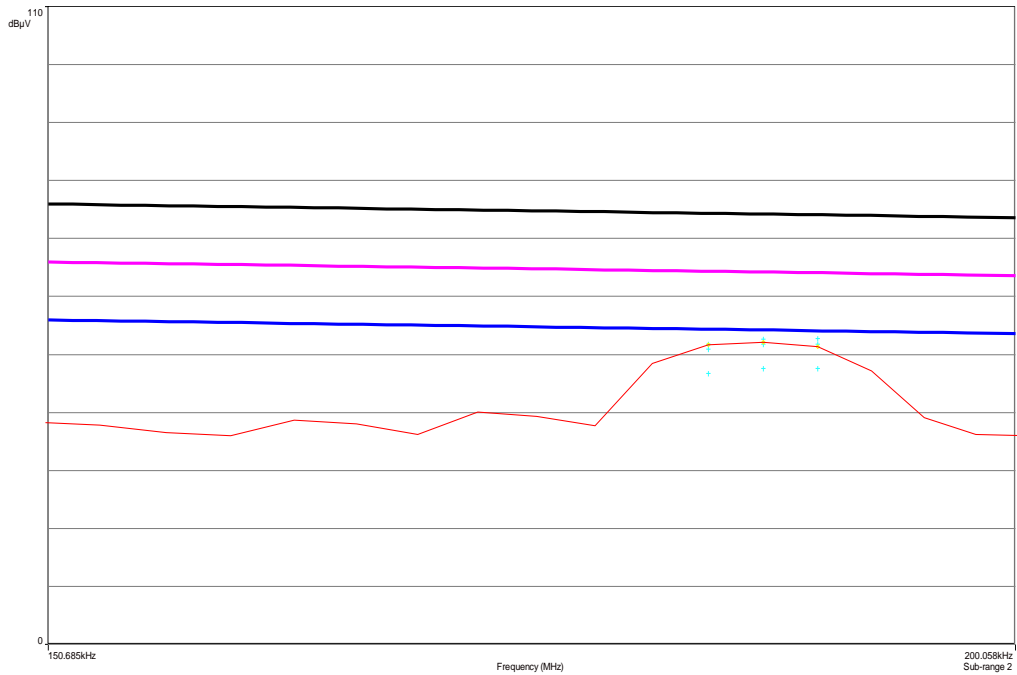

Plot 3: TX mode, 150 kHz to 30 MHz, neutral line

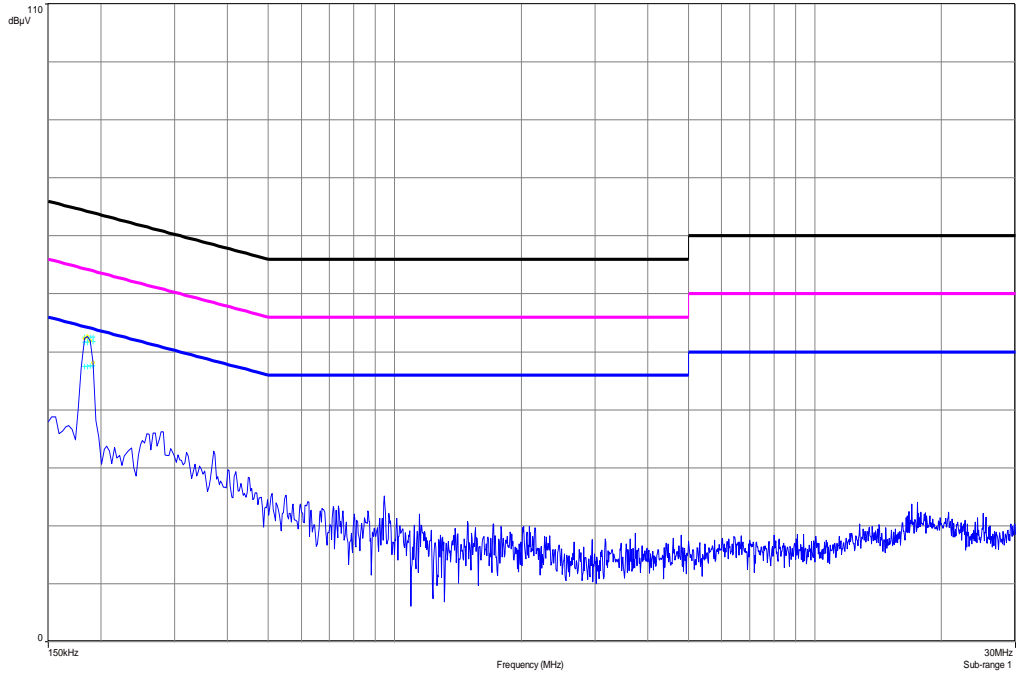

Plot 4: TX mode, 150 kHz to 30 MHz, neutral line, zoomed

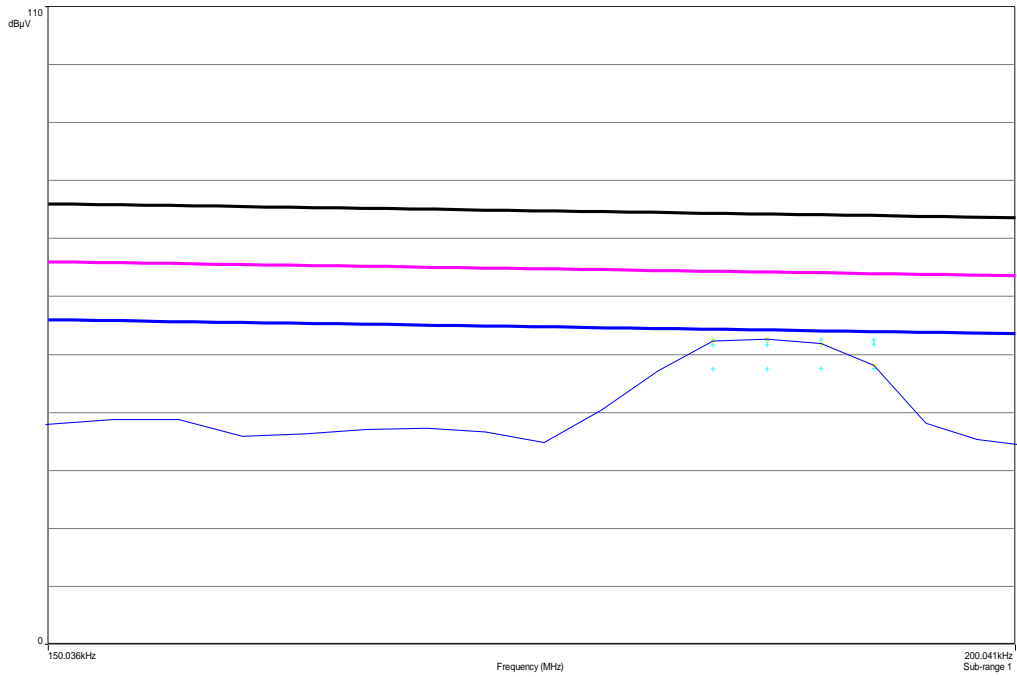

Plot 5: RX / Idle – mode, 150 kHz to 30 MHz, phase line

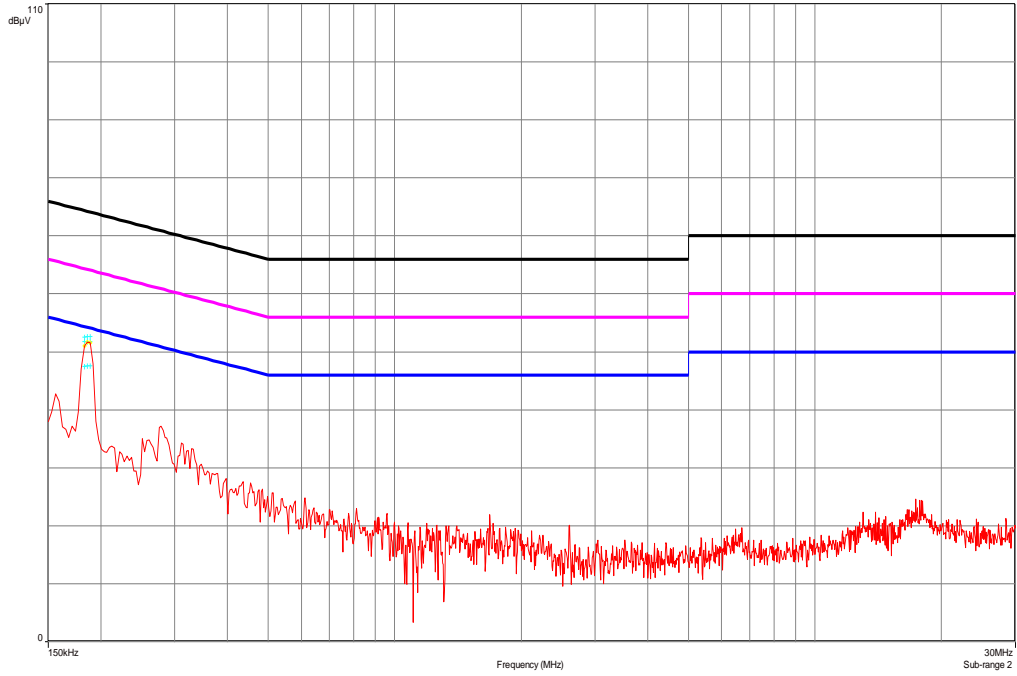

Plot 6: RX / Idle – mode, 150 kHz to 30 MHz, phase line, zoomed

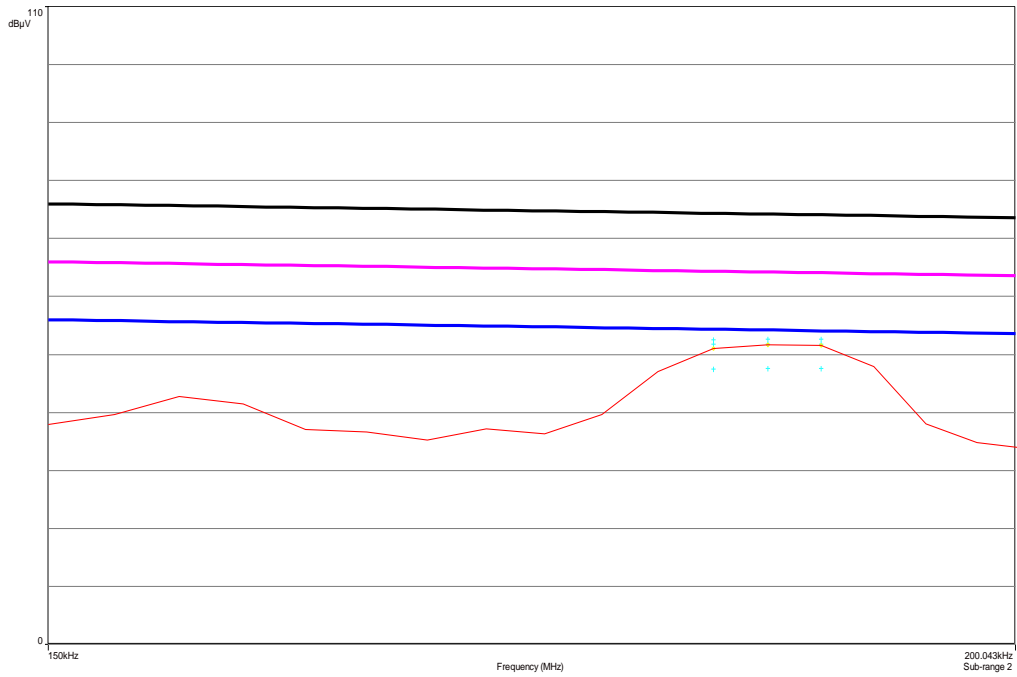

Plot 7: RX / Idle – mode, 150 kHz to 30 MHz, neutral line

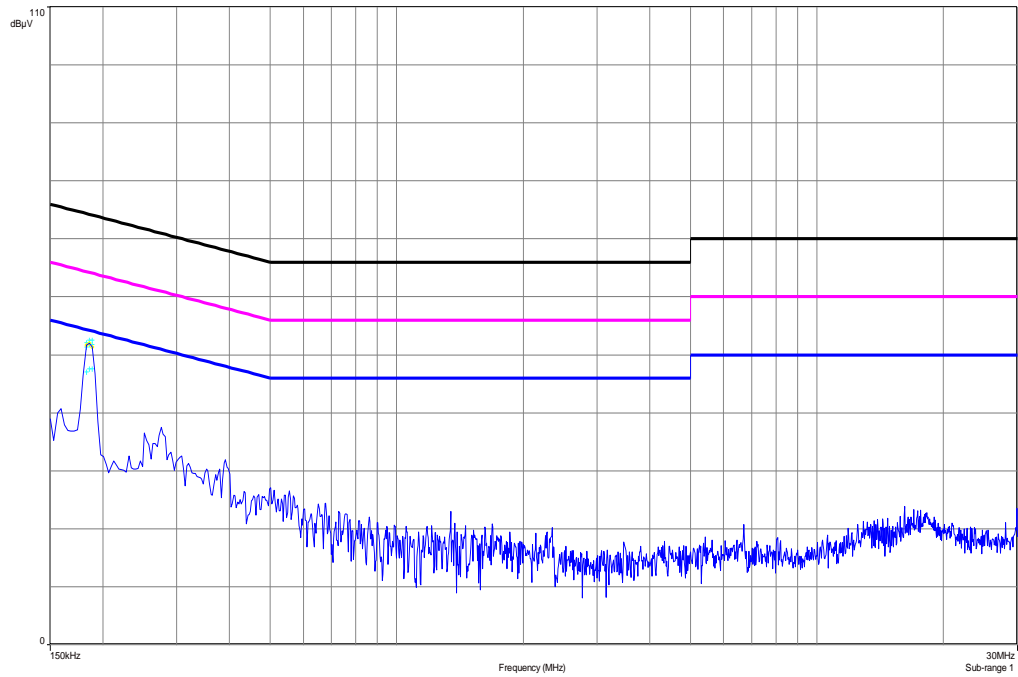

Plot 8: RX / Idle – mode, 150 kHz to 30 MHz, neutral line, zoomed

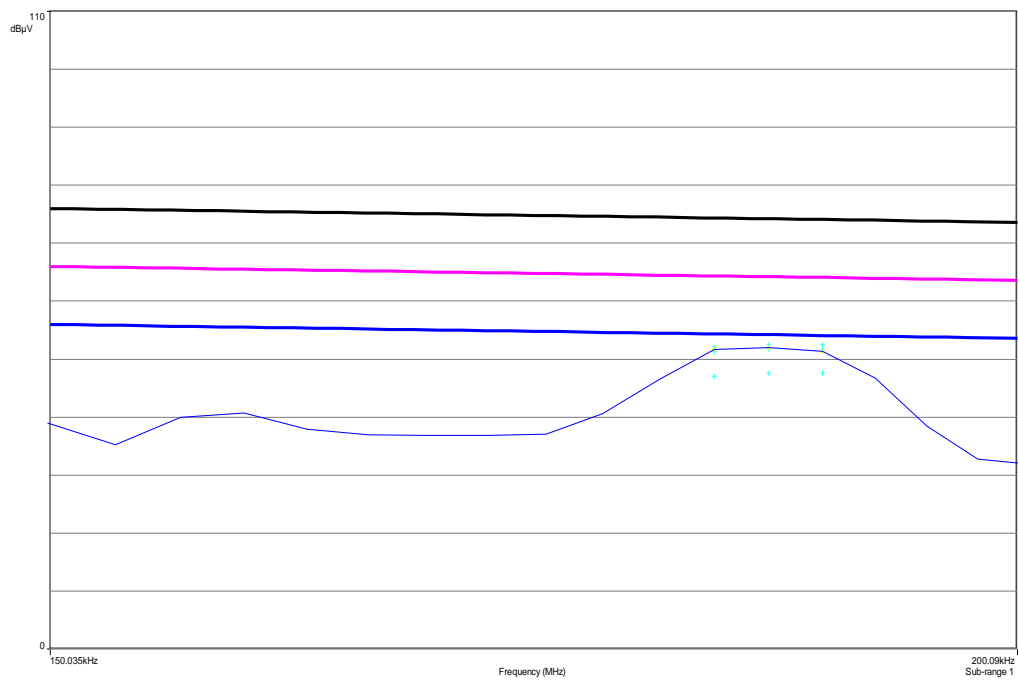

10 Test equipment and ancillaries used for tests

Typically, the calibrations of the test apparatus are commissioned to and performed by an accredited calibration laboratory. The calibration intervals are determined in accordance with the DIN EN ISO/IEC 17025. In addition to the external calibrations, the laboratory executes comparison measurements with other calibrated test systems or effective verifications. Weekly chamber inspections and range calibrations are performed. Where possible, rf-generating and signalling equipment as well as measuring receivers and analyzers are connected to an external high-precision 10 MHz reference (GPS-based or rubidium frequency standard).

In order to simplify the identification of the equipment used at some special tests, some items of test equipment and ancillaries can be provided with an identifier or number in the equipment list below (Labor/Item).

No.	Lab / Item	Equipment	Type	Manufact.	Serial No.	INV. No Cetecom	Kind of Calibration	Last Calibration	Next Calibration
1	45	Switch-Unit	3488A	HP Meßtechnik	2719A14505	300000368	g		
2	50	DC power supply, 60Vdc, 50A, 1200 W	6032A	HP Meßtechnik	2920A04466	300000580	ne		
3	n. a.	software	SPS_PHE 1.4f	Spitzberger & Spieß	B5981; 5D1081;B597 9	300000210	ne		
4	n. a.	EMI Test Receiver	ESCI 3	R&S	100083	300003312	k	09.01.2013	09.01.2014
5	n. a.	Analyzer- Reference- System (Harmonics and Flicker)	ARS 16/1	SPS	A3509 07/0 0205	300003314	k	14.07.2011	14.07.2013
6	n. a.	Amplifier	JS42- 00502650- 28-5A	MITEQ	1084532	300003379	ev		
7	n. a.	Antenna Tower	Model 2175	ETS- LINDGREN	64762	300003745	izw		
8	n. a.	Positioning Controller	Model 2090	ETS- LINDGREN	64672	300003746	izw		
9	n. a.	Turntable Interface-Box	Model 105637	ETS- LINDGREN	44583	300003747	izw		
10	n. a.	TRILOG Broadband Test-Antenna 30 MHz - 3 GHz	VULB9163	Schwarzbe ck	295	300003787	k	12.04.2012	12.04.2014
11	n. a.	Spectrum- Analyzer	FSU26	R&S	200809	300003874	k	16.01.2013	16.01.2015
12	n. a.	DC power supply, 60Vdc, 50A, 1200 W	6032A	HP Meßtechnik	2818A03450	300001040	Ve	12.01.2012	12.01.2015
13	n. a.	Double-Ridged Waveguide Horn Antenna 1-18.0GHz	3115	EMCO	8812-3088	300001032	viKI!	11.05.2011	11.05.2013
14	n. a.	Active Loop Antenna	6502	EMCO	2210	300001015	ne		
15	n. a.	Anechoic chamber	FAC 3/5m	MWB / TDK	87400/02	300000996	ev		
16	n. a.	Switch / Control Unit	3488A	HP Meßtechnik	*	300000199	ne		
17	n. a.	Switch / Control Unit	3488A	HP Meßtechnik	2719A15013	300001156	ne		
18	9	Isolating Transformer	MPL IEC625 Bus Regeltrennt ravo	Erfi	91350	300001155	ne		
19	n. a.	Three-Way Power Splitter, 50 Ohm	11850C	HP Meßtechnik		300000997	ne		
20	n. a.	Amplifier	js42- 00502650- 28-5a	Parzich GMBH	928979	300003143	ne		
21	n. a.	Band Reject filter	WRCG240 0/2483- 2375/2505- 50/10SS	Wainwright	11	300003351	ev		
22	n. a.	TRILOG Broadband Test-Antenna	VULB9163	Schwarzbe ck	371	300003854	viKI!	14.10.2011	14.10.2014

		30 MHz - 3 GHz							
23	n. a.	MXE EMI Receiver 20 Hz bis 26,5 GHz	N9038A	Agilent Technologies	MY51210197	300004405	k	21.02.2013	21.02.2014
24	11b	Microwave System Amplifier, 0.5-26.5 GHz	83017A	HP Meßtechnik	00419	300002268	ev		
25	A025	Std. Gain Horn Antenna 12.4 to 18.0 GHz	639	Narda		300000786	ne		
26	A027	Std. Gain Horn Antenna 18.0 to 26.5 GHz	638	Narda		300000486	ne		
27	n. a.	Std. Gain Horn Antenna 26.5-40.0 GHz	V637	Narda	7911	300001752	ne		
28	n. a.	Broadband Low Noise Amplifier 18-50 GHz	CBL18503 070-XX	CERNEX	19338	300004273	ne		
29	n. a.	Signal Analyzer 40 GHz	FSV40	R&S	101042	300004xxx	k	22.10.2012	22.10.2013
30	n. a.	Spectrum Analyzer 20 Hz - 50 GHz	FSU50	R&S	200012	300003443	Ve	09.10.2012	09.10.2014

Agenda: Kind of Calibration

- | | | | |
|------|--|-----|--|
| k | calibration / calibrated | EK | limited calibration |
| ne | not required (k, ev, izw, zw not required) | zw | cyclical maintenance (external cyclical maintenance) |
| ev | periodic self verification | izw | internal cyclical maintenance |
| Ve | long-term stability recognized | g | blocked for accredited testing |
| vlk! | Attention: extended calibration interval | * | next calibration ordered / currently in progress |
| NK! | Attention: not calibrated | | |

11 Observations

No observations exceeding those reported with the single test cases have been made.

Annex A Document history

Version	Applied changes	Date of release
1.0	Initial release	2013-03-22
-A	Correction of output power values	2013-08-05

Annex B Further information**Glossary**

AVG	-	Average
DUT	-	Device under test
EMC	-	Electromagnetic Compatibility
EN	-	European Standard
EUT	-	Equipment under test
ETSI	-	European Telecommunications Standard Institute
FCC	-	Federal Communication Commission
FCC ID	-	Company Identifier at FCC
HW	-	Hardware
IC	-	Industry Canada
Inv. No.	-	Inventory number
N/A	-	Not applicable
PP	-	Positive peak
QP	-	Quasi peak
S/N	-	Serial number
SW	-	Software

Annex C Accreditation Certificate

Front side of certificate



Deutsche Akkreditierungsstelle GmbH

Befähigung gemäß § 8 Absatz 1 AkkStelleG i.V.m. § 1 Absatz 1 AkkStelleGBV
 Unterzeichnerin der Multilateralen Abkommen
 von EA, ILAC und IAF zur gegenseitigen Anerkennung

Akkreditierung



Die Deutsche Akkreditierungsstelle GmbH bestätigt hiermit, dass das Prüflaboratorium

CETECOM ICT Services GmbH
 Untertürkheimer Straße 6-10, 66117 Saarbrücken

die Kompetenz nach DIN EN ISO/IEC 17025:2005 besitzt, Prüfungen in folgenden Bereichen durchzuführen:

- Drahtgebundene Kommunikation einschließlich xDSL
- VoIP und DECT
- Akustik
- Funk einschließlich WLAN
- Short Range Devices (SRD)
- RFID
- WiMax und Richtfunk
- Mobilfunk (GSM / DCS, Over the Air (OTA) Performance)
- Elektromagnetische Verträglichkeit (EMV) einschließlich Automotive
- Produktsicherheit
- SAR und Hearing Aid Compatibility (HAC)
- Umweltsimulation
- Smart Card Terminals
- Bluetooth
- Wi-Fi Services

Die Akkreditierungsurkunde gilt nur in Verbindung mit dem Bescheid vom 18.01.2013 mit der Akkreditierungsnummer D-PL-12076-01 und ist gültig 17.01.2018. Sie besteht aus diesem Deckblatt, der Rückseite des Deckblatts und der folgenden Anlage mit insgesamt 80 Seiten.

Registrierungsnummer der Urkunde: D-PL-12076-01-01

Frankfurt am Main, 18.01.2013
 Bitte Hinweise auf der Rückseite

Im Auftrag
 Dr. Jörg (FH) von Egnor
 Abteilungsleiter

Back side of certificate

Deutsche Akkreditierungsstelle GmbH

Standort Berlin
 Spittelmarkt 10
 10117 Berlin

Standort Frankfurt am Main
 Gartenstraße 6
 60594 Frankfurt am Main

Standort Braunschweig
 Rundscaife 100
 38116 Braunschweig

Die auszugsweise Veröffentlichung der Akkreditierungsurkunde bedarf der vorherigen schriftlichen Zustimmung der Deutsche Akkreditierungsstelle GmbH (DAkkS). Ausgenommen davon ist die separate Weiterverbreitung des Deckblatts durch die umseitig genannte Konformitätsbewertungsstelle in unveränderter Form.

Es darf nicht der Anschein erweckt werden, dass sich die Akkreditierung auch auf Bereiche erstreckt, die über den durch die DAkkS bestätigten Akkreditierungsbereich hinausgehen.

Die Akkreditierung erfolgte gemäß des Gesetzes über die Akkreditierungsstelle (AkkStelleG) vom 31. Juli 2009 (BGBl. I S. 2625) sowie der Verordnung (EG) Nr. 765/2008 des Europäischen Parlaments und des Rates vom 9. Juli 2008 über die Vorschriften für die Akkreditierung und Marktüberwachung im Zusammenhang mit der Vermarktung von Produkten (Abt. L 218 vom 9. Juli 2008, S. 30). Die DAkkS ist Unterzeichnerin der Multilateralen Abkommen zur gegenseitigen Anerkennung der European co-operation for Accreditation (EA), des International Accreditation Forum (IAF) und der International Laboratory Accreditation Cooperation (ILAC). Die Unterzeichner dieser Abkommen erkennen ihre Akkreditierungen gegenseitig an.

Der aktuelle Stand der Mitgliedschaft kann folgenden Webseiten entnommen werden:
 EA: www.european-accreditation.org
 ILAC: www.ilac.org
 IAF: www.iaf.nu

Note:

The current certificate including annex is published on our website (see link below) or may be received from CETECOM ICT Services on request.

<http://www.cetecom.com/eu/de/cetecom-group/europa/deutschland-saarbruecken/akkreditierungen.html>