



TEST REPORT

Report Number. : 14160419-E1V1

Applicant : DISH TECHNOLOGIES LLC
90 INVERNESS CIRCLE EAST
ENGLEWOOD, CO 80112, UNITED STATES

Model : D35

Brand : DISH

FCC ID : DKNPF99

EUT Description : TV SET TOP BOX CLIENT

Test Standard(s) : FCC 47 CFR PART 15 SUBPART C

Date Of Issue:
March 21, 2022

Prepared by:
UL VERIFICATION SERVICES
47173 Benicia Street
Fremont, CA 94538 U.S.A.
TEL: (510) 319-4000
FAX: (510) 661-0888



REPORT REVISION HISTORY

Rev.	Issue Date	Revisions	Revised By
V1	3/21/2022	Initial Issue	---

TABLE OF CONTENTS

REPORT REVISION HISTORY	2
TABLE OF CONTENTS	3
1. ATTESTATION OF TEST RESULTS	5
2. TEST RESULTS SUMMARY	7
3. TEST METHODOLOGY	8
4. FACILITIES AND ACCREDITATION	8
5. DECISION RULES AND MEASUREMENT UNCERTAINTY	9
5.1. METROLOGICAL TRACEABILITY	9
5.2. DECISION RULES.....	9
5.3. MEASUREMENT UNCERTAINTY.....	9
5.4. SAMPLE CALCULATION	9
6. EQUIPMENT UNDER TEST	10
6.1. EUT DESCRIPTION	10
6.2. MAXIMUM OUTPUT POWER.....	10
6.3. DESCRIPTION OF AVAILABLE ANTENNAS	10
6.4. SOFTWARE AND FIRMWARE.....	10
6.5. WORST-CASE CONFIGURATION AND MODE.....	10
6.6. DESCRIPTION OF TEST SETUP.....	11
7. TEST AND MEASUREMENT EQUIPMENT	14
8. MEASUREMENT METHOD.....	15
9. ANTENNA PORT TEST RESULTS	16
9.1. ON TIME AND DUTY CYCLE.....	16
9.2. 6 dB BANDWIDTH.....	17
9.3. OUTPUT POWER.....	18
9.4. AVERAGE POWER.....	19
9.5. POWER SPECTRAL DENSITY	20
9.6. CONDUCTED SPURIOUS EMISSIONS.....	21
10. RADIATED TEST RESULTS	23
10.1. LIMITS AND PROCEDURE.....	23

10.2.	TRANSMITTER ABOVE 1 GHZ.....	25
10.3.	WORST CASE BELOW 30MHZ.....	35
10.4.	WORST CASE BELOW 1 GHZ.....	36
10.5.	WORST CASE 18-26 GHZ.....	38
11.	AC POWER LINE CONDUCTED EMISSIONS	40
12.	SETUP PHOTOS	43

1. ATTESTATION OF TEST RESULTS

COMPANY NAME: DISH TECHNOLOGIES LLC
90 INVERNESS CIRCLE EAST
ENGLEWOOD, CO 80112, UNITED STATES

EUT DESCRIPTION: TV SET TOP BOX CLIENT

MODEL: D35

BRAND: DISH

SERIAL NUMBER: CONDUCTED: MJ4P6LB7
RADIATED: MJ486L88

SAMPLE RECEIPT DATE: MARCH 03, 2022

DATE TESTED: MARCH 04, 2022 TO MARCH 14, 2022

APPLICABLE STANDARDS	
STANDARD	TEST RESULTS
CFR 47 Part 15 Subpart C	Complies

UL Verification Services Inc. tested the above equipment in accordance with the requirements set forth in the above standards. The test results show that the equipment tested is capable of demonstrating compliance with the requirements as documented in this report.

The results documented in this report apply only to the tested sample, under the conditions and modes of operation as described herein. It is the manufacturer's responsibility to assure that additional production units of this model are manufactured with identical electrical and mechanical components. All samples tested were in good operating condition throughout the entire test program. Measurement Uncertainties are published for informational purposes only and were not taken into account unless noted otherwise.

This document may not be altered or revised in any way unless done so by UL Verification Services Inc. and all revisions are duly noted in the revisions section. Any alteration of this document not carried out by UL Verification Services Inc. will constitute fraud and shall nullify the document. This report must not be used by the client to claim product certification, approval, or endorsement by A2LA, NIST, any agency of the Federal Government, or any agency of the U.S. government.

Approved & Released For
UL Verification Services Inc. By:



Francisco deAnda
Staff Engineer
Consumer Technology Division
UL Verification Services Inc.

Prepared By:



Adrian Fong
Laboratory Engineer
Consumer Technology Division
UL Verification Services Inc.

Reviewed By:



Tina Chu
Senior Project Engineer
Consumer Technology Division
UL Verification Services Inc.

2. TEST RESULTS SUMMARY

This report contains data provided by the customer which can impact the validity of results. UL Verification Services Inc. is only responsible for the validity of results after the integration of the data provided by the customer.

FCC Clause	Requirement	Result	Comment
See Comment	Duty Cycle	Reporting purposes only	ANSI C63.10 Section 11.6.
15.247 (a) (2)	6dB BW	Complies	None.
15.247 (b) (3)	Output Power	Complies	None.
See Comment	Average power	Reporting purposes only	Per ANSI C63.10, Section 11.9.2.3.2.
15.247 (e)	PSD	Complies	None.
15.247 (d)	Conducted Spurious Emissions	Complies	None.
15.209, 15.205	Radiated Emissions	Complies	None.
15.207	AC Mains Conducted Emissions	Complies	None.

3. TEST METHODOLOGY

The tests documented in this report were performed in accordance with FCC CFR 47 Part 2, FCC CFR 47 Part 15, ANSI C63.10-2013, KDB 558074 D01 15.247 Meas Guidance v05r02, KDB 414788 D01 Radiated Test Site v01r01.

4. FACILITIES AND ACCREDITATION

UL Verification Services Inc. is accredited by A2LA, Certificate Number 0751.05, for all testing performed within the scope of this report. Testing was performed at the locations noted below.

	Address	ISED CABID	ISED Company Number	FCC Registration
<input type="checkbox"/>	Building 1: 47173 Benicia Street, Fremont, California, USA	US0104	2324A	550739
<input type="checkbox"/>	Building 2: 47266 Benicia Street, Fremont, California, USA	US0104	22541	550739
<input checked="" type="checkbox"/>	Building 4: 47658 Kato Rd, Fremont, California, USA	US0104	2324B	550739

5. DECISION RULES AND MEASUREMENT UNCERTAINTY

5.1. METROLOGICAL TRACEABILITY

All test and measuring equipment utilized to perform the tests documented in this report are calibrated on a regular basis, with a maximum time between calibrations of one year or the manufacturers' recommendation, whichever is less, and where applicable is traceable to recognized national standards.

5.2. DECISION RULES

The Decision Rule is based on Simple Acceptance in accordance with ISO Guide 98-4:2012 Clause 8.2. (Measurement uncertainty is not taken into account when stating conformity with a specified requirement.)

5.3. MEASUREMENT UNCERTAINTY

Where relevant, the following measurement uncertainty levels have been estimated for tests performed on the apparatus:

PARAMETER	U _{Lab}
Worst Case Conducted Disturbance, 9KHz to 0.15 MHz	3.78 dB
Worst Case Conducted Disturbance, 0.15 to 30 MHz	3.40 dB
Worst Case Radiated Disturbance, 9KHz to 30 MHz	2.84 dB
Worst Case Radiated Disturbance, 30 to 1000 MHz	6.01 dB
Worst Case Radiated Disturbance, 1000 to 18000 MHz	4.73 dB
Worst Case Radiated Disturbance, 18000 to 26000 MHz	4.51 dB
Worst Case Radiated Disturbance, 26000 to 40000 MHz	5.29 dB

Uncertainty figures are valid to a confidence level of 95%.

5.4. SAMPLE CALCULATION

RADIATED EMISSIONS

Where relevant, the following sample calculation is provided:

$$\text{Field Strength (dBuV/m)} = \text{Measured Voltage (dBuV)} + \text{Antenna Factor (dB/m)} + \text{Cable Loss (dB)} - \text{Preamp Gain (dB)}$$

$$36.5 \text{ dBuV} + 18.7 \text{ dB/m} + 0.6 \text{ dB} - 26.9 \text{ dB} = 28.9 \text{ dBuV/m}$$

MAINS CONDUCTED EMISSIONS

Where relevant, the following sample calculation is provided:

$$\text{Final Voltage (dBuV)} = \text{Measured Voltage (dBuV)} + \text{Cable Loss (dB)} + \text{Limiter Factor (dB)} + \text{LISN Insertion Loss.}$$

$$36.5 \text{ dBuV} + 0 \text{ dB} + 10.1 \text{ dB} + 0 \text{ dB} = 46.6 \text{ dBuV}$$

6. EQUIPMENT UNDER TEST

6.1. EUT DESCRIPTION

The EUT is a TV Set Top Box Client with RF4CE Zigbee, BLE (1Mbps), and BT radios.

6.2. MAXIMUM OUTPUT POWER

The transmitter has a maximum peak conducted output power as follows:

Frequency Range (MHz)	Mode	Output Power (dBm)	Output Power (mW)
2402 - 2480	BLE	8.85	7.67

6.3. DESCRIPTION OF AVAILABLE ANTENNAS

The antenna(s) gain and type, as provided by the manufacturer' are as follows:

The radio utilizes a PCB Inverted F antenna, with a maximum gain of 4.2 dBi.

6.4. SOFTWARE AND FIRMWARE

The EUT firmware installed during testing was BCM 002.001.014.0647.0000

The test utility software used during testing was cybluetool 0.1.55.1.

6.5. WORST-CASE CONFIGURATION AND MODE

Radiated emissions below 1GHz, above 18GHz, and power line conducted emission were performed with the EUT set to transmit at the channel with highest output power as worst-case scenario.

Band edge and radiated emissions between 1GHz and 18GHz were performed with the EUT set to transmit at the highest power on low, middle, and high channels.

The EUT is a desktop device, therefore, all final radiated testing was performed with the EUT in X orientation.

This EUT supports BLE/BT + Zigbee simultaneous transmission, radiated emission test was performed, please refer to 14160419-E3 for result.

EUT supports only 1Mbps data rate. Only this mode was investigated.

6.6. DESCRIPTION OF TEST SETUP

SUPPORT TEST EQUIPMENT						
Description	Manufacturer	Model	Serial Number	FCC ID/ DoC		
AC/DC Adapter(EUT)	NetBit	NBC25A120210VU	222109	DoC		
Router	D-Link	EBR-2310	F311388010596	DoC		
Router Adapter	D-Link	AF0605	LF4R07082717180	DoC		
TV Emulator	DISH	TV Emulator	D52-12			
Laptop: Radiated test	HP	Elitebook 740	N/A	DoC		
AC/DC Adapter(Laptop): Radiated test	HP	N/A	N/A	DoC		
Laptop: conducted test	HP	Elitebook 740	N/A	DoC		
AC/DC Adapter(Laptop): conducted test	HP	N/A	N/A	DoC		
USB Flash Drive	Sandisk	Cruzer Glide 16GB	SDCZ60-016G	DoC		
I/O CABLES (CONDUCTED TEST)						
Cable No.	Port	# of Identical Ports	Connector Type	Cable Type	Cable Length (m)	Remarks
1	DC	1	Barrel	Un-shielded	1.5	EUT to AC/DC adapter Mains
2	UART	1	UART	Un-shielded	0.1	EUT to USB adapter
3	UART	1	USB	Un-shielded	3	USB adapter to laptop
4	DC	1	AC	Un-shielded	3	
5	AC	1	AC	Un-shielded	1	
6	Antenna	1	RF	Un-shielded	0.2	To spectrum analyzer
I/O CABLES (RADIATED TEST/AC POWER LINE EMISSIONS)						
Cable No.	Port	# of Identical Ports	Connector Type	Cable Type	Cable Length (m)	Remarks
1	DC	1	Barrel	Un-shielded	1.5	EUT to AC/DC adapter Mains
2	HDMI	1	HDMI	shielded	1	EUT to Emulator
3	RJ45	1	RJ45	Un-shielded	More than 3	EUT to Ethernet Router
4	Coaxial RF	1	Coaxial RF	shielded	0.2	75 ohm load terminated BNC port on coaxial cable
5	DC	1	Barrel	Un-shielded	1	Ethernet router to AC/DC Adapter
6	UART	1	UART	Un-shielded	0.1	EUT to USB adapter
7	UART	1	USB	Un-shielded	2	USB adapter to laptop
8	DC	1	DC	Un-shielded	1	AC Adapter Laptop
9	AC	1	Two Prong	Un-shielded	2	AC adapter to AC Mains

CONDUCTED TEST SETUP DIAGRAM

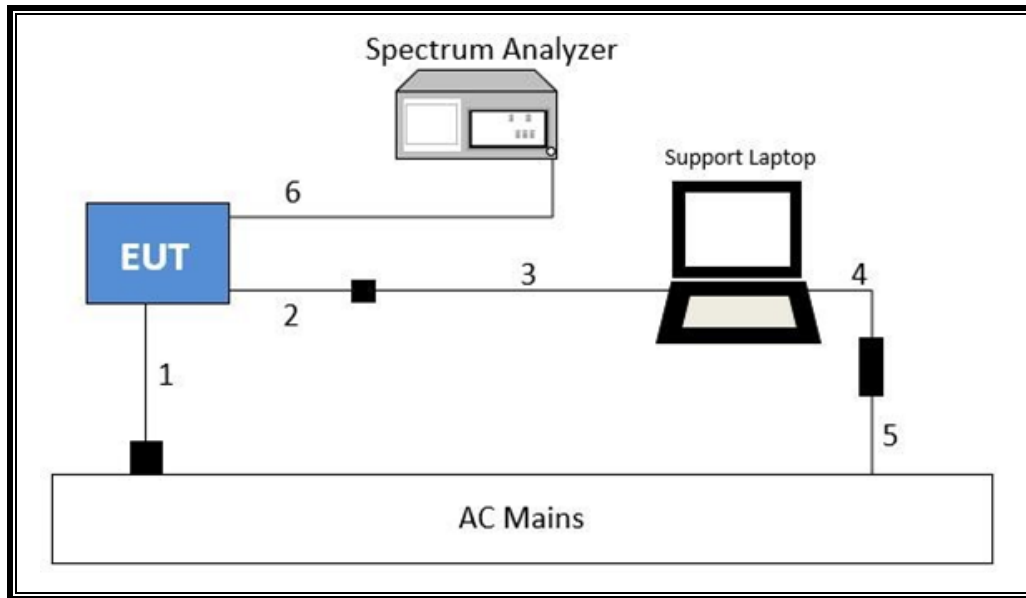

TEST SETUP

The EUT is connected to a test laptop by USB to UART cable adapter during the tests. Test software exercised the radio card.

RADIATED TEST/AC POWER LINE EMISSIONS SETUP DIAGRAM

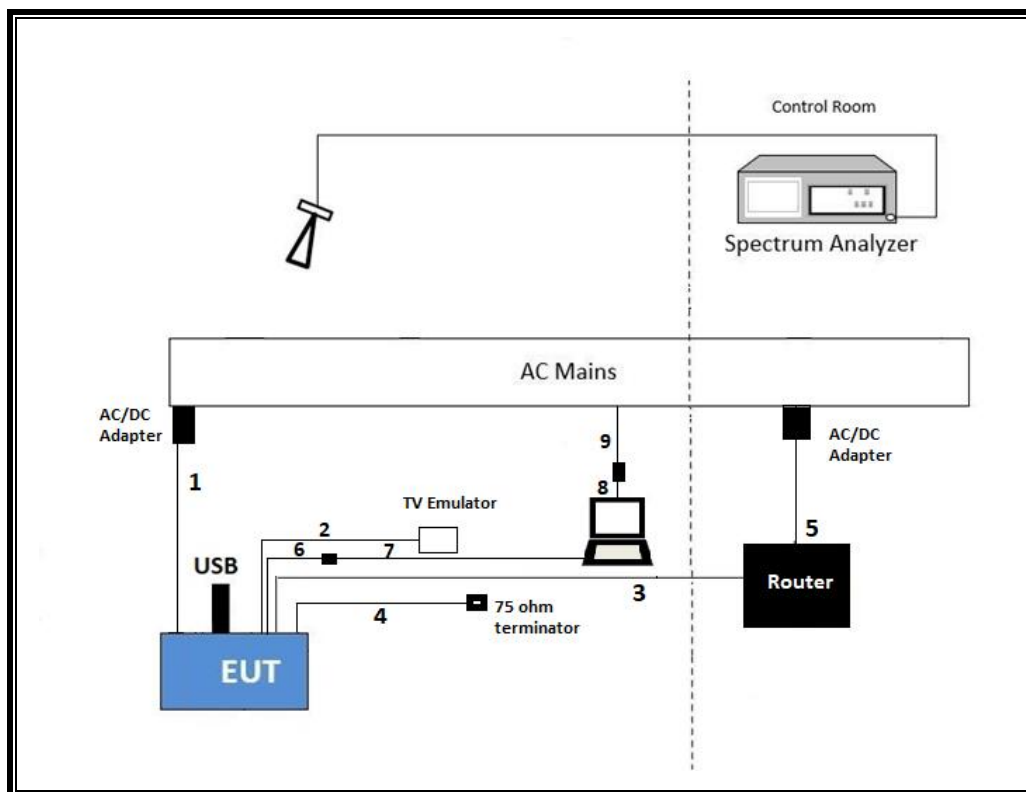

TEST SETUP

The EUT is connected to a test laptop by USB to UART cable adapter, support equipment and powered by AC/DC adapter during the tests. Test software exercised the radio card.

7. TEST AND MEASUREMENT EQUIPMENT

The following test and measurement equipment was utilized for the tests documented in this report:

TEST EQUIPMENT LIST					
Description	Manufacturer	Model	ID Num	Cal Due	Last Cal
Antenna, Horn 1-18GHz	ETS-Lindgren	3117	T119	05/07/2022	05/07/2021
Amplifier 1-8GHz 30dB gain	L3 Narda	AMF-4D-01000800-30-29P	167495	03/09/2023	03/09/2022
Amplifier, 1 - 18GHz	MITEQ	AFS42-00101800-25-S-42	T1568	03/09/2023	03/09/2022
Amplifier, 10KHz to 1GHz, 32dB	SONOMA INSTRUMENT	310N	T300	04/09/2022	04/09/2021
Amplifier, 1-7GHz, 24dB	AMPLICAL	AMP1G7-24-27	T1607	03/09/2023	03/09/2022
Antenna, BroadBand Hybrid, 30MHz to 3GHz	Sunol Sciences Corp.	JB3	171862	09/28/2022	09/28/2021
Loop Antenna	ELECTRO METRICS	EM-6871	PRE0179466	06/08/2022	06/08/2021
Loop Antenna	ELECTRO METRICS	EM-6872	PRE0179468	06/08/2022	06/08/2021
EMI TEST RECEIVER, with B8 option	Rohde & Schwarz	ESW44	PRE0179377	02/20/2023	02/20/2022
NSA, Test Site Validation	TDK RF SOLUTIONS INC.	ANSI C63.4 & CISPR 16-1-4	210613	09/18/2022	09/18/2021
Antenna, Horn 18 to 26.5GHz	A.R.A.	MWH-1826/B	81139	05/25/2022	05/25/2021
Amplifier, 1 to 26.5GHz, 23.5dB Gain minimum	Keysight Technologies Inc	8449B	80671	04/19/2022	04/19/2021
Spectrum Analyzer, PSA, 3Hz to 26.5GHz	Keysight Technologies Inc	E4440A	81311	02/03/2023	02/03/2022
Power Meter, P-series single channel	Keysight Technologies Inc	N1911A	90715	01/26/2023	01/26/2022
Power Sensor, P - series, 50MHz to 18GHz, Wideband	Keysight Technologies Inc	N1921A	81319	01/24/2023	01/24/2022
Thermometer - Digital	Control Company	14-650-118	175731	02/03/2023	02/03/2022
AC Line Conducted					
Description	Manufacturer	Model	ID Num	Cal Due	Last Cal
LISN	Fischer Custom Communications, Inc	FCC-LISN-50/250-25-2-01-480V	175765	1/26/2023	1/26/2022
LISN	Fischer Custom Communications, Inc	FCC-LISN-50/250-25-2	T24	1/20/2023	1/20/2022
EMI TEST RECEIVER	Rohde & Schwarz	ESR	T1436	2/19/2023	2/19/2022
Transient Limiter	COM-POWER	LIT-930A	T1457	1/20/2023	1/20/2022
Test Software List					
Description	Manufacturer	Model	Version		
Radiated Software	UL	UL EMC	Rev 9.5, April 30, 2020, Oct 21, 2019		
Antenna Port Software	UL	UL RF	AP 2021.8.27		
AC Line Conducted Software	UL	UL EMC	Rev 9.5, July 07, 2020		

8. MEASUREMENT METHOD

On Time and Duty Cycle: ANSI C63.10 Section 11.6.

6 dB BW: ANSI C63.10 Subclause -11.8.1 RBW \geq DTS BW

Output Power: ANSI C63.10 Subclause -11.9.1.3 Method PKPM1 Peak-reading power meter

Output Power: ANSI C63.10 Subclause -11.9.2.3.2 Method AVGPM-G (Measurement using a gated RF average-reading power meter)

PSD: ANSI C63.10 Subclause -11.10.2 Method PKPSD (peak PSD)

Radiated emissions non-restricted frequency bands: ANSI C63.10 Subclause -11.11

Radiated emissions restricted frequency bands: ANSI C63.10 Subclause -11.12.1

Conducted emissions in restricted frequency bands: ANSI C63.10 Subclause -11.12.2

Band-edge: ANSI C63.10 Section 6.10

AC Power Line Conducted Emissions: ANSI C63.10-2013, Section 6.2.

Radiated Spurious Emissions Below 30MHz: ANSI C63.10-2013 Section 6.4

9. ANTENNA PORT TEST RESULTS

9.1. ON TIME AND DUTY CYCLE

LIMITS

None; for reporting purposes only.

PROCEDURE

KDB 558074 Zero-Span Spectrum Analyzer Method.

ON TIME AND DUTY CYCLE RESULTS

Mode	ON Time B (msec)	Period (msec)	Duty Cycle x (linear)	Duty Cycle (%)	Duty Cycle Correction Factor (dB)	1/B Minimum VBW (kHz)
2.4GHz Band						
BLE	87.200	87.200	1.000	100.00	0.00	0.010

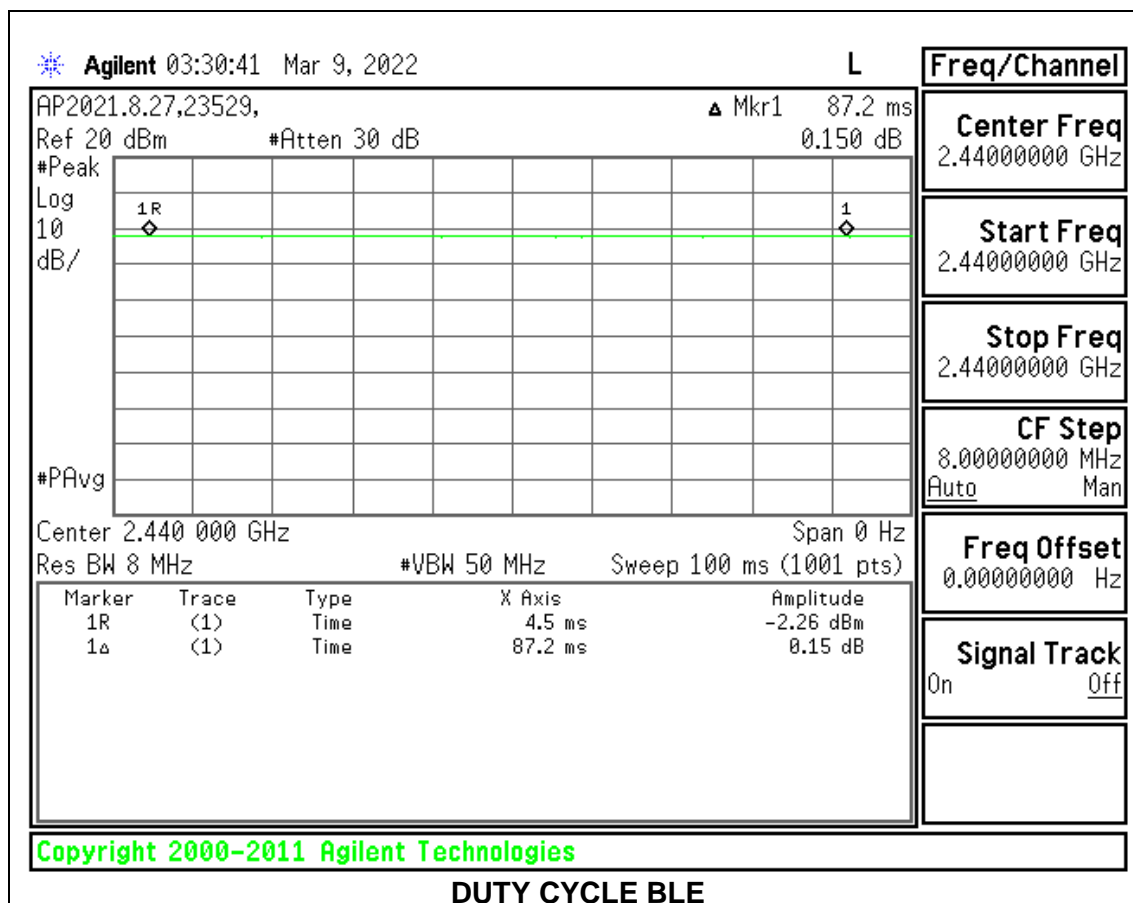

9.2. 6 dB BANDWIDTH

LIMITS

FCC §15.247 (a) (2)

The minimum 6 dB bandwidth shall be at least 500 kHz.

RESULTS

Channel	Frequency (MHz)	6 dB Bandwidth (MHz)	Minimum Limit (MHz)
Low	2402	1.1070	0.5
Middle	2440	0.9720	0.5
High	2480	1.0560	0.5

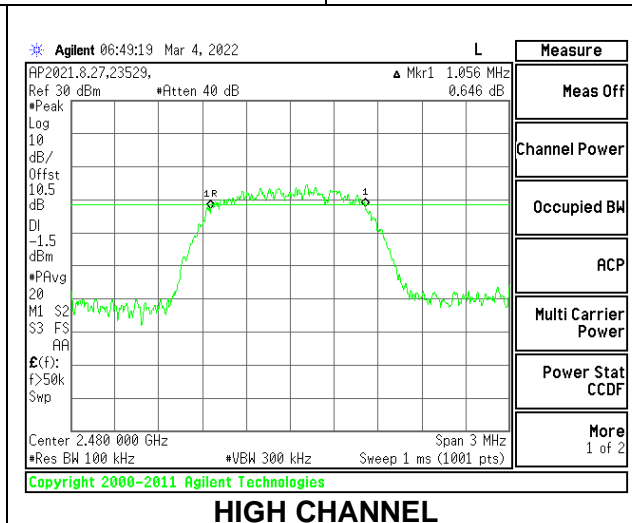
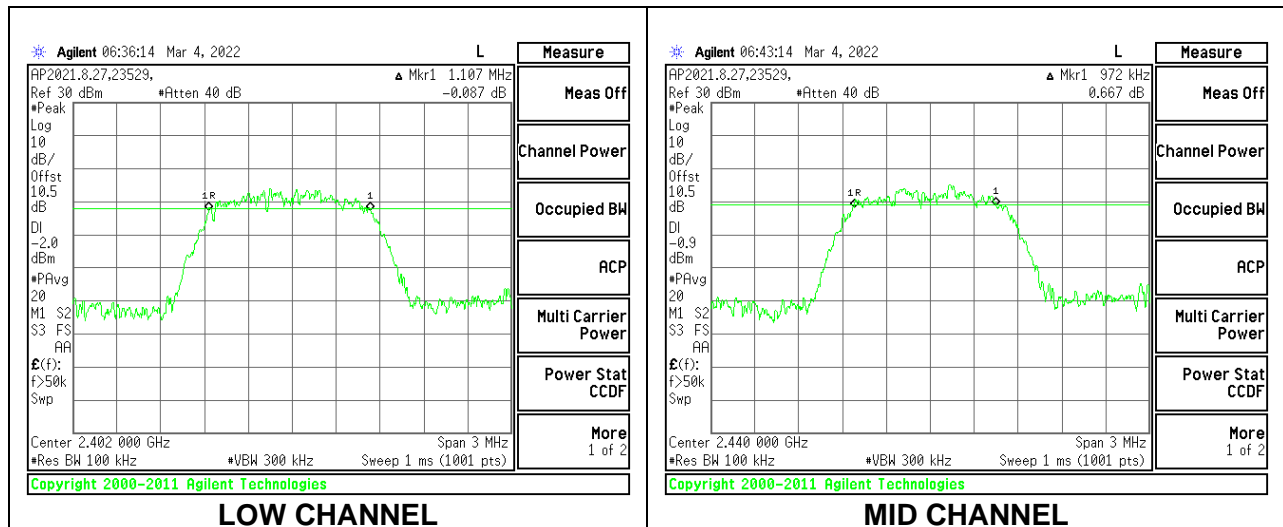

9.3. OUTPUT POWER

LIMITS

FCC §15.247 (b) (3)

The maximum antenna gain is less than or equal to 6 dBi, therefore the limit is 30 dBm.

TEST PROCEDURE

The transmitter output is connected to a power meter.

The power output was measured on the EUT antenna port using SMA cable with 10dB attenuator connected to a power meter via wideband peak power sensor. Peak output power was read directly from power meter.

RESULTS

Tested By:	23529 QL/19497 AF
Date:	3/4/2022

Channel	Frequency (MHz)	Peak Power Reading (dBm)	Limit (dBm)	Margin (dB)
Low	2402	8.62	30	-21.380
Middle	2440	8.85	30	-21.150
High	2480	8.81	30	-21.190

9.4. AVERAGE POWER

LIMITS

None; for reporting purposes only.

TEST PROCEDURE

The transmitter output is connected to a power meter.

The power output was measured on the EUT antenna port using SMA cable with 10dB attenuator connected to a power meter via wideband average power sensor. Gated average output power was read directly from power meter.

RESULTS

Tested By:	23529 QL/19497 AF
Date:	3/4/2022

Channel	Frequency (MHz)	AV power (dBm)
Low	2402	6.02
Middle	2440	6.37
High	2480	6.28

9.5. POWER SPECTRAL DENSITY

LIMITS

FCC §15.247 (e)

The power spectral density conducted from the transmitter to the antenna shall not be greater than 8 dBm in any 3 kHz band during any time interval of continuous transmission.

RESULTS

Channel	Frequency (MHz)	PSD (dBm/3kHz)	Limit (dBm/3kHz)	Margin (dB)
Low	2402	-9.50	8	-17.50
Middle	2440	-9.39	8	-17.39
High	2480	-9.43	8	-17.43

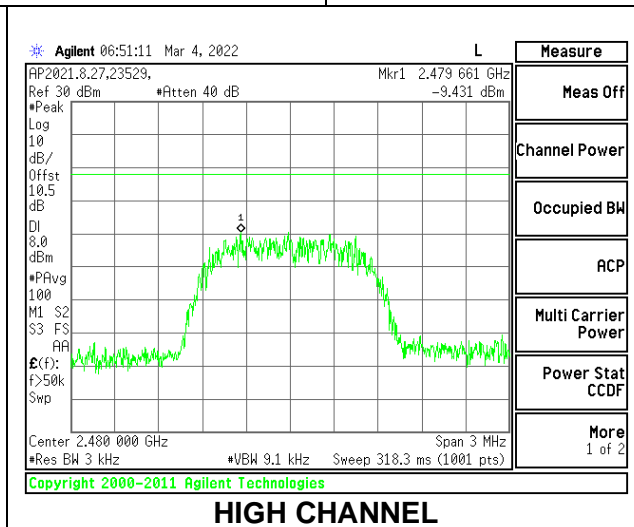
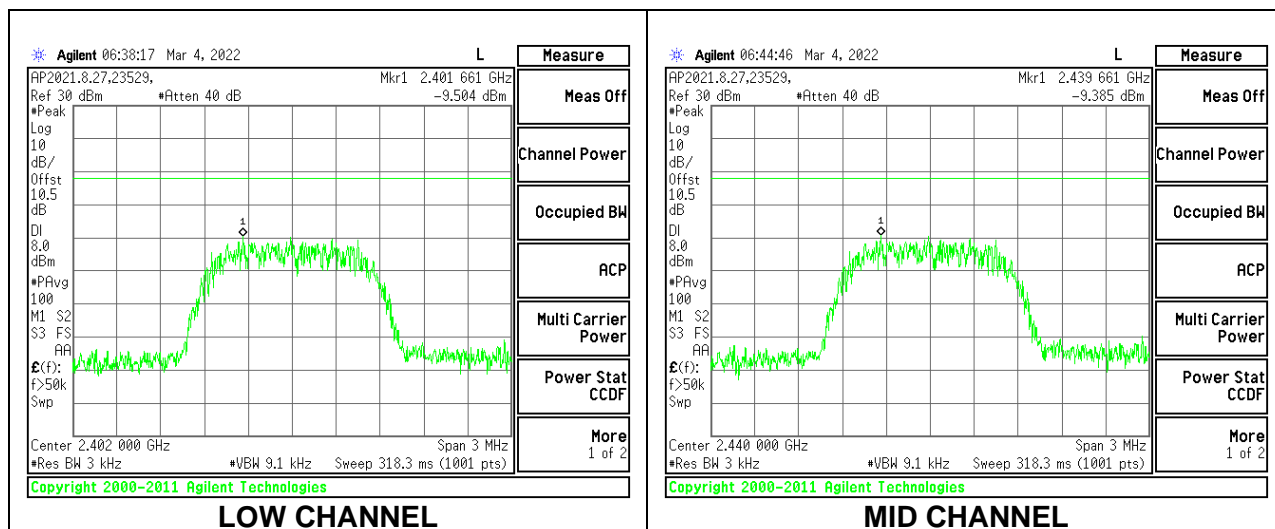

9.6. CONDUCTED SPURIOUS EMISSIONS

LIMITS

FCC §15.247 (d)

Output power was measured based on the use of a peak measurement, therefore the required attenuation is 20 dBc.

RESULTS

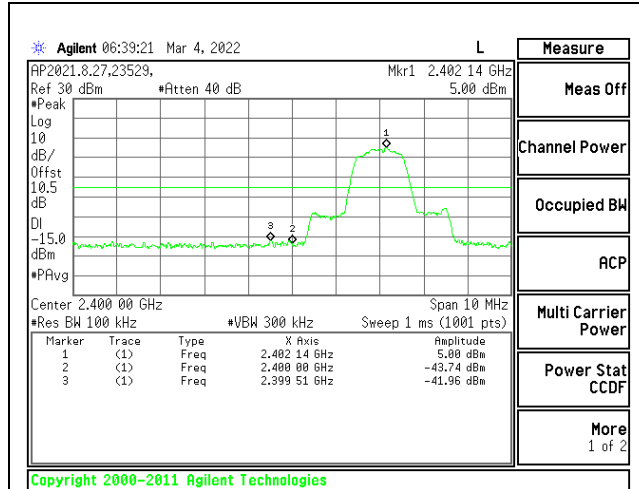

LOW CHANNEL BANDEDGE

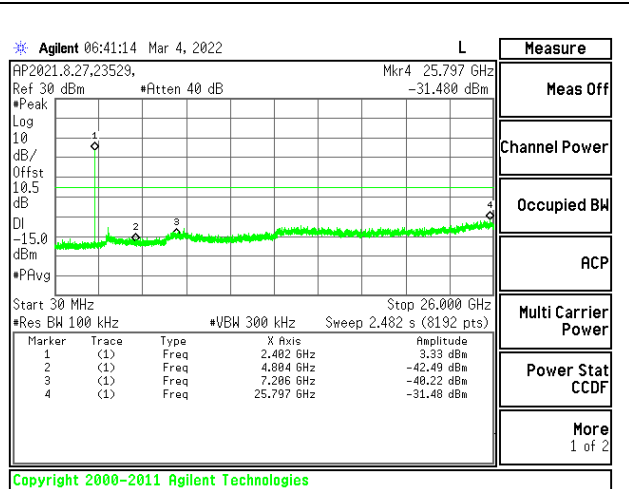

OUT-OF-BAND LOW CHANNEL

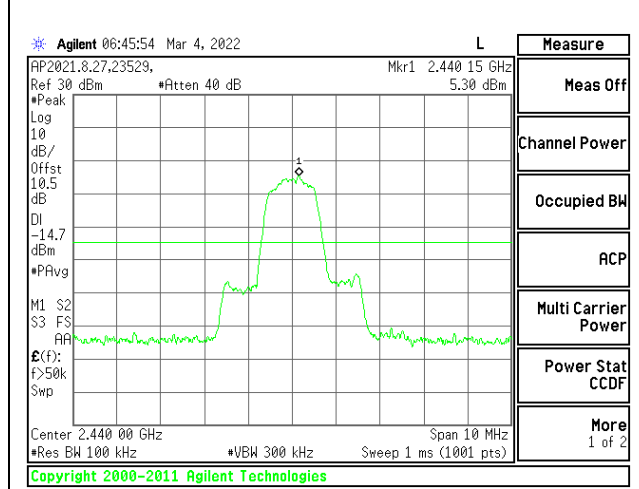

IN-BAND REFERENCE LEVEL

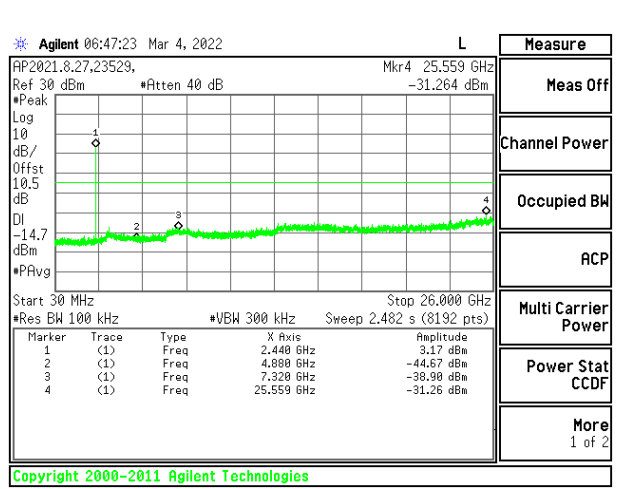

OUT-OF-BAND MID CHANNEL

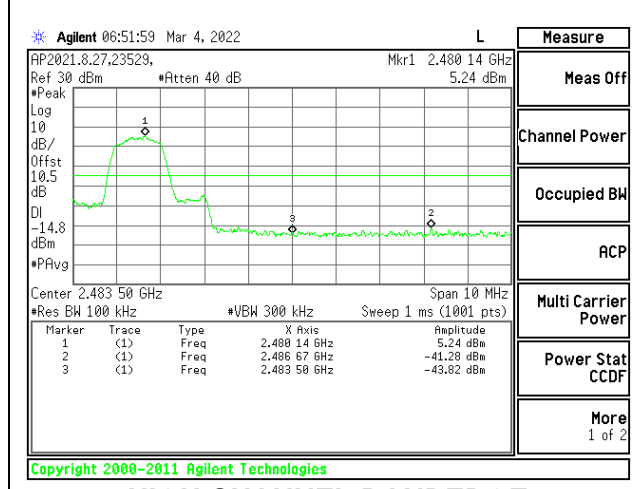

HIGH CHANNEL BANDEDGE

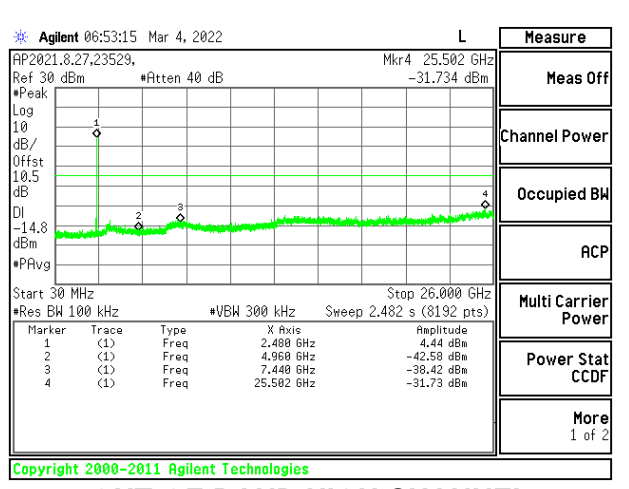

OUT-OF-BAND HIGH CHANNEL

10. RADIATED TEST RESULTS

10.1. LIMITS AND PROCEDURE

LIMITS

FCC §15.205 and §15.209

Frequency Range (MHz)	Field Strength Limit (uV/m) at 3 m	Field Strength Limit (dBuV/m) at 3 m
0.009-0.490	2400/F(kHz) @ 300 m	-
0.490-1.705	24000/F(kHz) @ 30 m	-
1.705 - 30	30 @ 30m	-
30 - 88	100	40
88 - 216	150	43.5
216 - 960	200	46
Above 960	500	54

TEST PROCEDURE

The EUT is placed on a non-conducting table 80 cm above the ground plane for measurement below 1GHz; 1.5 m above the ground plane for measurement above 1GHz. The antenna to EUT distance is 3 meters. The EUT is configured in accordance with ANSI C63.10. The EUT is set to transmit in a continuous mode.

For measurements below 1 GHz the resolution bandwidth is set to 100 kHz for peak detection measurements or 120 kHz for quasi-peak detection measurements in the 30-1000MHz range, 9kHz for peak and/or quasi-peak detection measurements in the 0.15-30MHz range and 200Hz for peak and/or quasi-peak detection measurements in the 9 to 150kHz range. Peak detection is used unless otherwise noted as quasi-peak or average (9-90kHz and 110-490kHz).

For pre-scans above 1 GHz the resolution bandwidth is set to 1 MHz; the video bandwidth is set to 30 KHz for peak measurements.

For final measurements above 1 GHz the resolution bandwidth is set to 1 MHz; the video bandwidth is set to 3 MHz for peak measurements and as applicable for average measurements.

The spectrum from 1 GHz to 18 GHz is investigated with the transmitter set to the lowest, middle, and highest channels in each applicable band. Below 1GHz and above 18GHz emissions, the channel with the highest output power was tested.

The frequency range of interest is monitored at a fixed antenna height and EUT azimuth. The EUT is rotated through 360 degrees to maximize emissions received. The antenna is scanned from 1 to 4 meters above the ground plane to further maximize the emission. Measurements are made with the antenna polarized in both the vertical and the horizontal positions.

For below 30MHz testing, investigation was done on three antenna orientations (parallel, perpendicular, and ground-parallel), parallel and perpendicular are the worst orientations, therefore testing was performed on these two orientations only. Blue color trace on plots: Parallel orientation. Green color trace on plots: Perpendicular orientation.

Base on FCC 15.31 (f) (2): measurements may be performed at a distance closer than that specified in the regulations; however, an attempt should be made to avoid making measurements in the near field.

KDB 414788 Open Field Site(OFS) and Chamber Correlation Justification

OFS and chamber correlation testing had been performed and chamber measured test result is the worst case test result.

KDB 558074 D01 15.247 Meas Guidance v05r02

Use of a duty cycle correction factor (DCCF) is permitted for calculating average radiated field strength emission levels for an FHSS device in 15.247. This DCCF can be applied when the field strength limit (e.g., within a Government Restricted band) and the conditions specified in Section 15.35(c) can be satisfied. The average radiated field strength is calculated by subtracting the DCCF from the maximum radiated field strength level as determined through measurement. The maximum radiated field strength level represents the worst-case (maximum amplitude) RMS measurement of the emission(s) during continuous transmission (i.e., not including any time intervals during which the transmitter is off or is transmitting at a reduced power level). It is also acceptable to apply the DCCF to a measurement performed with a peak detector instead of the specified RMS power averaging detector. Note that Section 15.35(c) specifies that the DCCF shall represent the worst-case (greatest duty cycle) over any 100 msec transmission period.

10.2. TRANSMITTER ABOVE 1 GHz

BANDEDGE (LOW CHANNEL)

HORIZONTAL RESULT

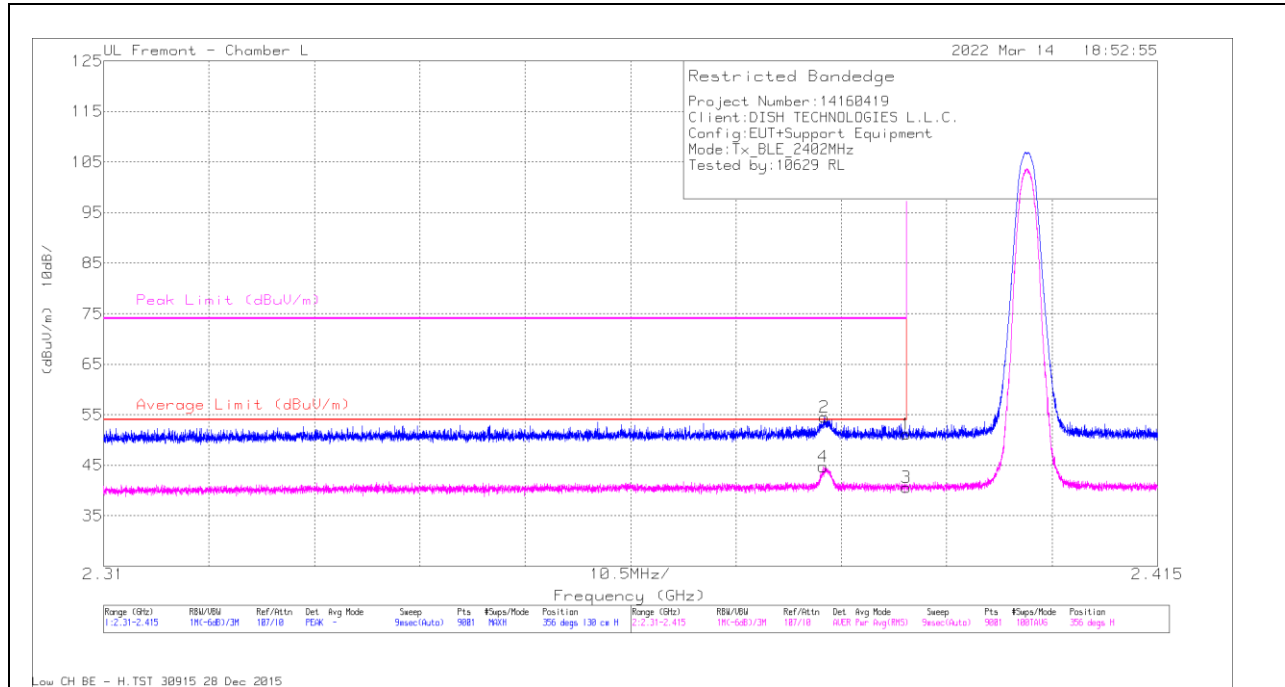

Marker	Frequency (GHz)	Meter Reading (dBuV)	Det	AF T119 (dB/m)	Amp/Cbl/Filtr/Pad (dB)	Corrected Reading (dBuV/m)	Average Limit (dBuV/m)	Margin (dB)	Peak Limit (dBuV/m)	PK Margin (dB)	Azimuth (Degs)	Height (cm)	Polarity
1	* 2.39	38.49	Pk	32	-19.3	51.19	-	-	74	-22.81	356	130	H
2	* 2.381834	41.79	Pk	32.1	-19.4	54.49	-	-	74	-19.51	356	130	H
3	* 2.39	27.96	RMS	32	-19.3	40.66	54	-13.34	-	-	356	130	H
4	* 2.381659	32	RMS	32.1	-19.4	44.7	54	-9.3	-	-	356	130	H

* - indicates frequency in CFR47 Pt 15 / IC RSS-Restricted Band
 Pk - Peak detector
 RMS - RMS detection

VERTICAL RESULT

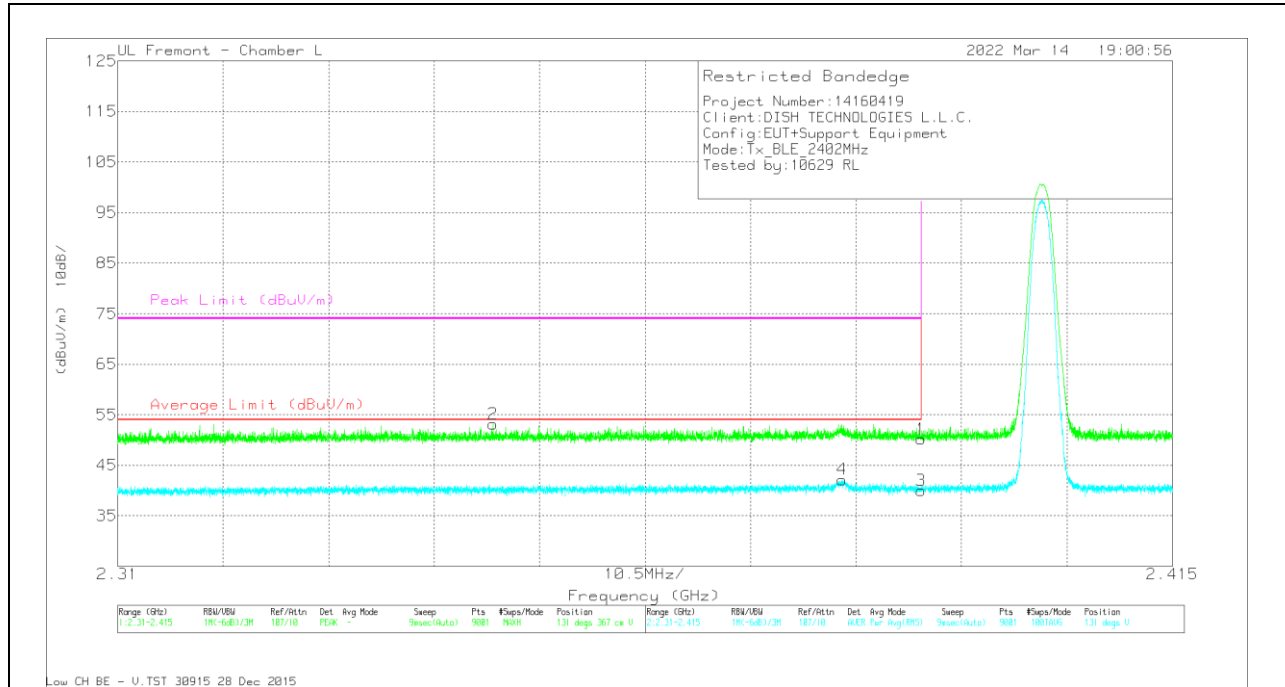

Marker	Frequency (GHz)	Meter Reading (dBuV)	Det	AF T119 (dB/m)	Amp/Cb/Filtr/Pad (dB)	Corrected Reading (dBuV/m)	Average Limit (dBuV/m)	Margin (dB)	Peak Limit (dBuV/m)	PK Margin (dB)	Azimuth (Degs)	Height (cm)	Polarity
1	* 2.39	37.48	Pk	32	-19.3	50.18	-	-	74	-23.82	131	367	V
2	* 2.347369	40.8	Pk	31.9	-19.5	53.2	-	-	74	-20.8	131	367	V
3	* 2.39	27.25	RMS	32	-19.3	39.95	54	-14.05	-	-	131	367	V
4	* 2.382137	29.46	RMS	32.1	-19.4	42.16	54	-11.84	-	-	131	367	V

* - indicates frequency in CFR47 Pt 15 / IC RSS-Restricted Band
 Pk - Peak detector
 RMS - RMS detection

BANDEDGE (HIGH CHANNEL)

HORIZONTAL RESULT

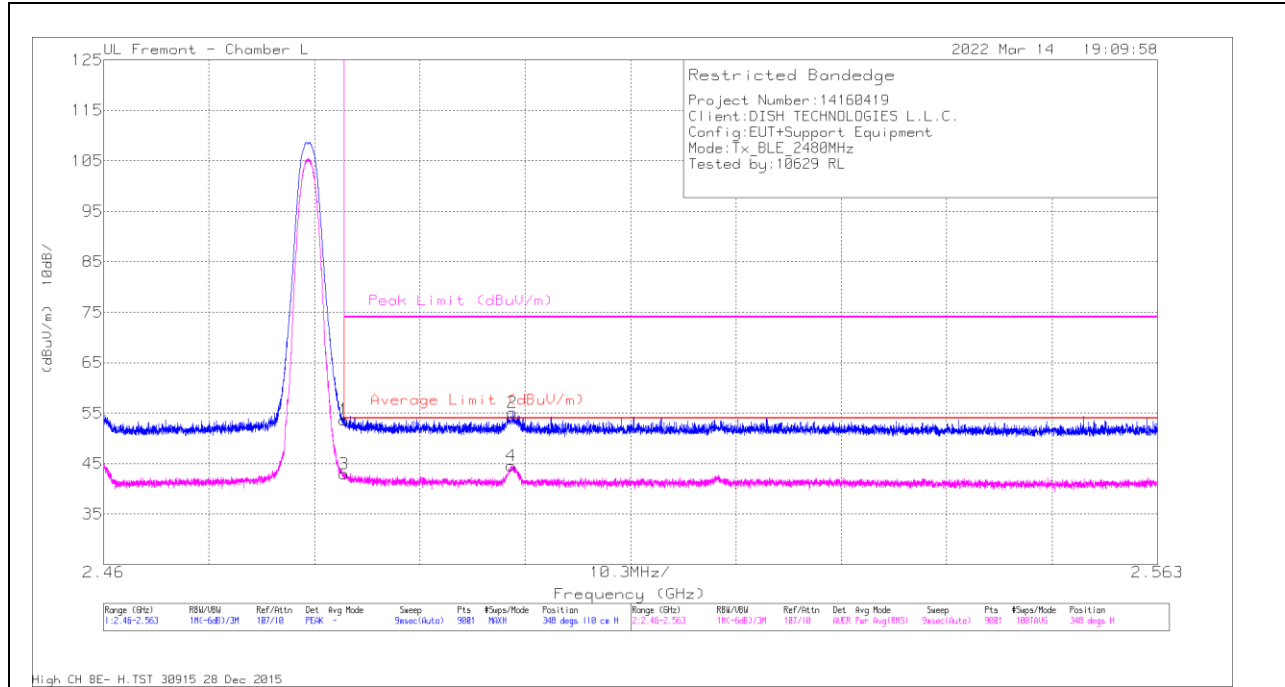

Marker	Frequency (GHz)	Meter Reading (dBuV)	Det	AF T119 (dB/m)	Amp/Cbl/Filtr/Pad (dB)	Corrected Reading (dBuV/m)	Average Limit (dBuV/m)	Margin (dB)	Peak Limit (dBuV/m)	PK Margin (dB)	Azimuth (Degs)	Height (cm)	Polarity
1	* 2.4835	40.4	Pk	32.3	-19	53.7	-	-	74	-20.3	348	110	H
2	* 2.499951	41.86	Pk	32.4	-19.1	55.16	-	-	74	-18.84	348	110	H
3	* 2.4835	29.63	RMS	32.3	-19	42.93	54	-11.07	-	-	348	110	H
4	* 2.499859	31.23	RMS	32.4	-19.1	44.53	54	-9.47	-	-	348	110	H

* - indicates frequency in CFR47 Pt 15 / IC RSS-Restricted Band
 Pk - Peak detector
 RMS - RMS detection

VERTICAL RESULT

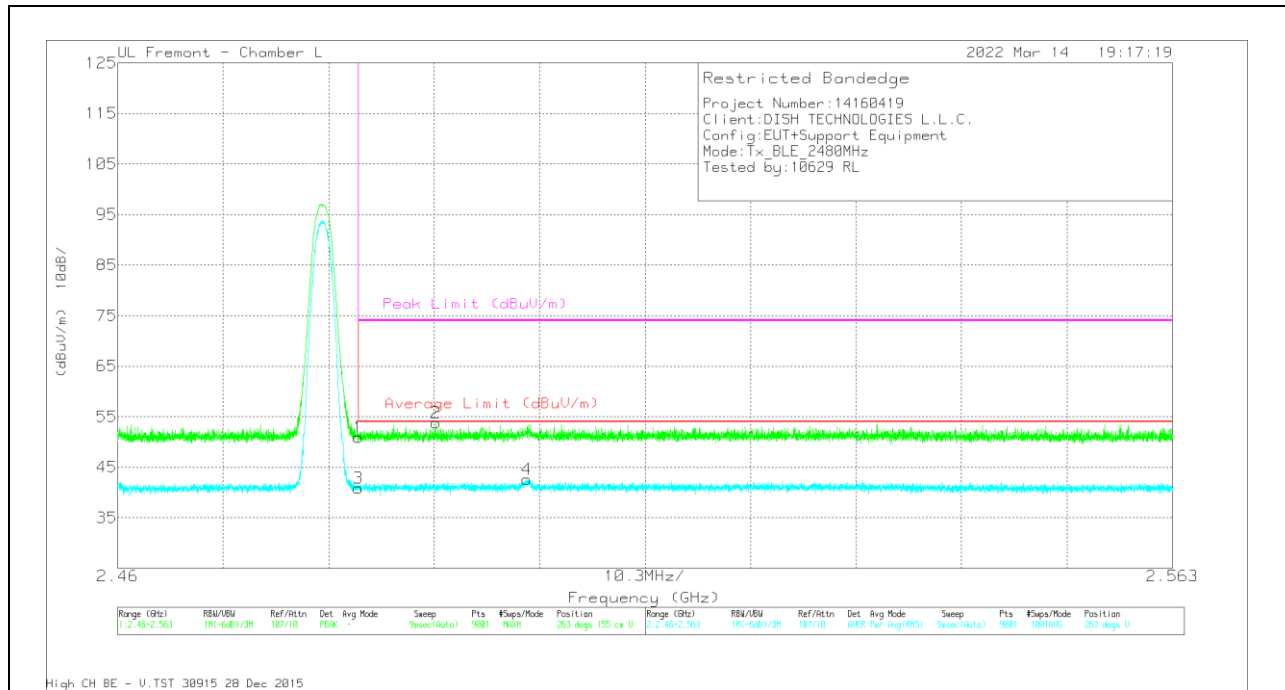

Marker	Frequency (GHz)	Meter Reading (dBuV)	Det	AF T119 (dB/m)	Amp/Cbl/Filtr/Pad (dB)	Corrected Reading (dBuV/m)	Average Limit (dBuV/m)	Margin (dB)	Peak Limit (dBuV/m)	PK Margin (dB)	Azimuth (Degs)	Height (cm)	Polarity
1	* 2.4835	37.6	Pk	32.3	-19	50.9	-	-	74	-23.1	263	155	V
2	* 2.491082	40.48	Pk	32.4	-19.1	53.78	-	-	74	-20.22	263	155	V
3	* 2.4835	27.58	RMS	32.3	-19	40.88	54	-13.12	-	-	263	155	V
4	* 2.499985	29.33	RMS	32.4	-19.1	42.63	54	-11.37	-	-	263	155	V

* - indicates frequency in CFR47 Pt 15 / IC RSS-Restricted Band
 Pk - Peak detector
 RMS - RMS detection

HARMONICS AND SPURIOUS EMISSIONS

LOW CHANNEL RESULTS

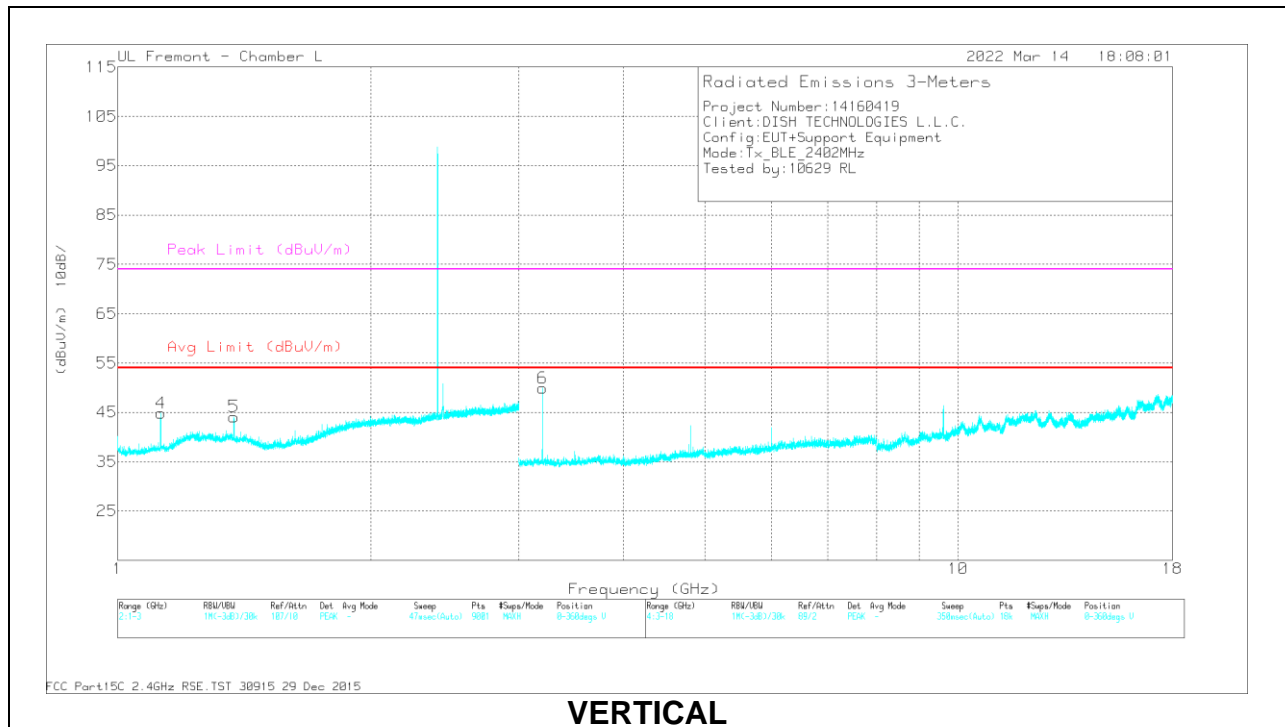
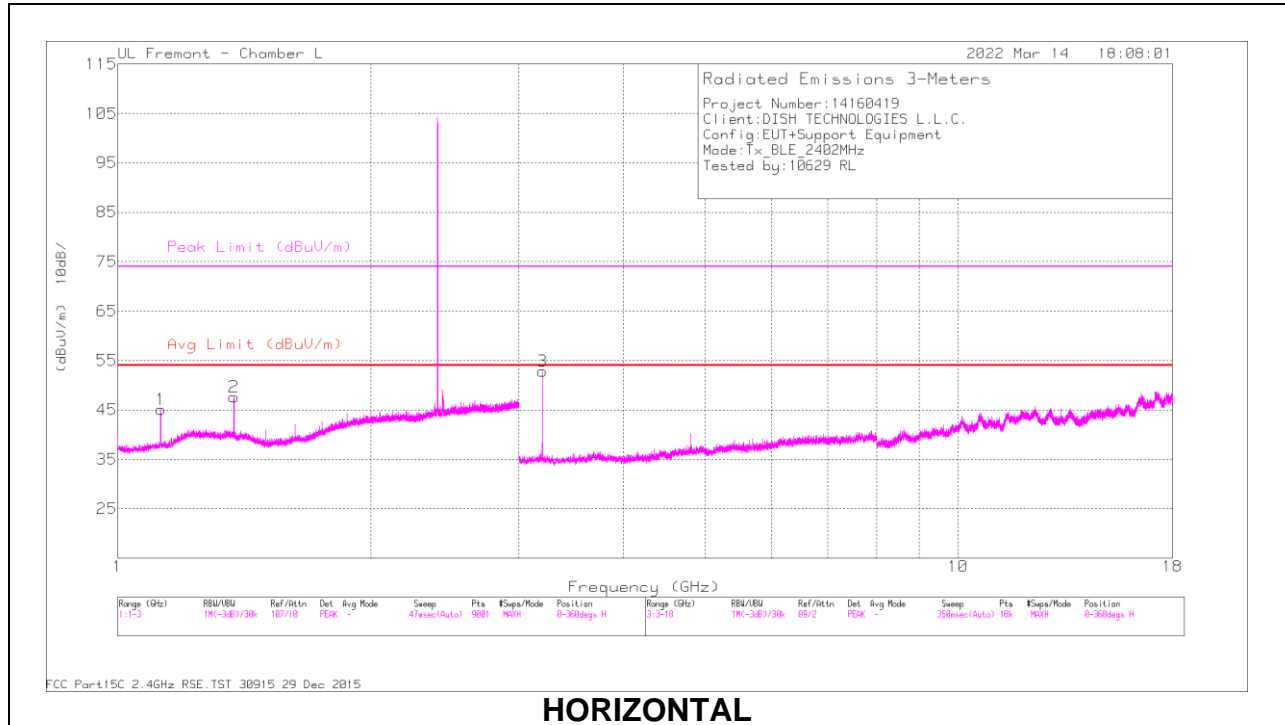

RADIATED EMISSIONS

Marker	Frequency (GHz)	Meter Reading (dBuV)	Det	AF T119 (dB/m)	Amp/Cbl/Fitr/Pad (dB)	Corrected Reading (dBuV/m)	Avg Limit (dBuV/m)	Margin (dB)	Peak Limit (dBuV/m)	PK Margin (dB)	Azimuth (Degs)	Height (cm)	Polarity
1	* 1.124726	47.28	PK2	28	-23.4	51.88	-	-	74	-22.12	263	156	H
	* 1.124986	37.11	MAv1	28	-23.4	41.71	54	-12.29	-	-	263	156	H
2	* 1.374809	46.12	PK2	29.4	-22.6	52.92	-	-	74	-21.08	291	101	H
	* 1.37502	38.33	MAv1	29.4	-22.6	45.13	54	-8.87	-	-	291	101	H
4	* 1.124889	46.84	PK2	28	-23.4	51.44	-	-	74	-22.56	327	196	V
	* 1.125033	36.38	MAv1	28	-23.4	40.98	54	-13.02	-	-	327	196	V
5	* 1.37502	45.6	PK2	29.4	-22.6	52.4	-	-	74	-21.6	314	106	V
	* 1.37494	37.52	MAv1	29.4	-22.6	44.32	54	-9.68	-	-	314	106	V
3	3.202703	50.07	PK2	32.9	-26.6	56.37	-	-	-	-	154	101	H
	3.202703	47.39	MAv1	32.9	-26.6	53.69	-	-	-	-	154	101	H
6	3.202719	48.43	PK2	32.9	-26.6	54.73	-	-	-	-	254	101	V
	3.202667	44.82	MAv1	32.9	-26.6	51.12	-	-	-	-	254	101	V

* - indicates frequency in CFR47 Pt 15 / IC RSS-Restricted Band
 PK2 - KDB558074 Method: Maximum Peak
 MAv1 - KDB558074 Option 1 Maximum RMS Average

MID CHANNEL RESULTS

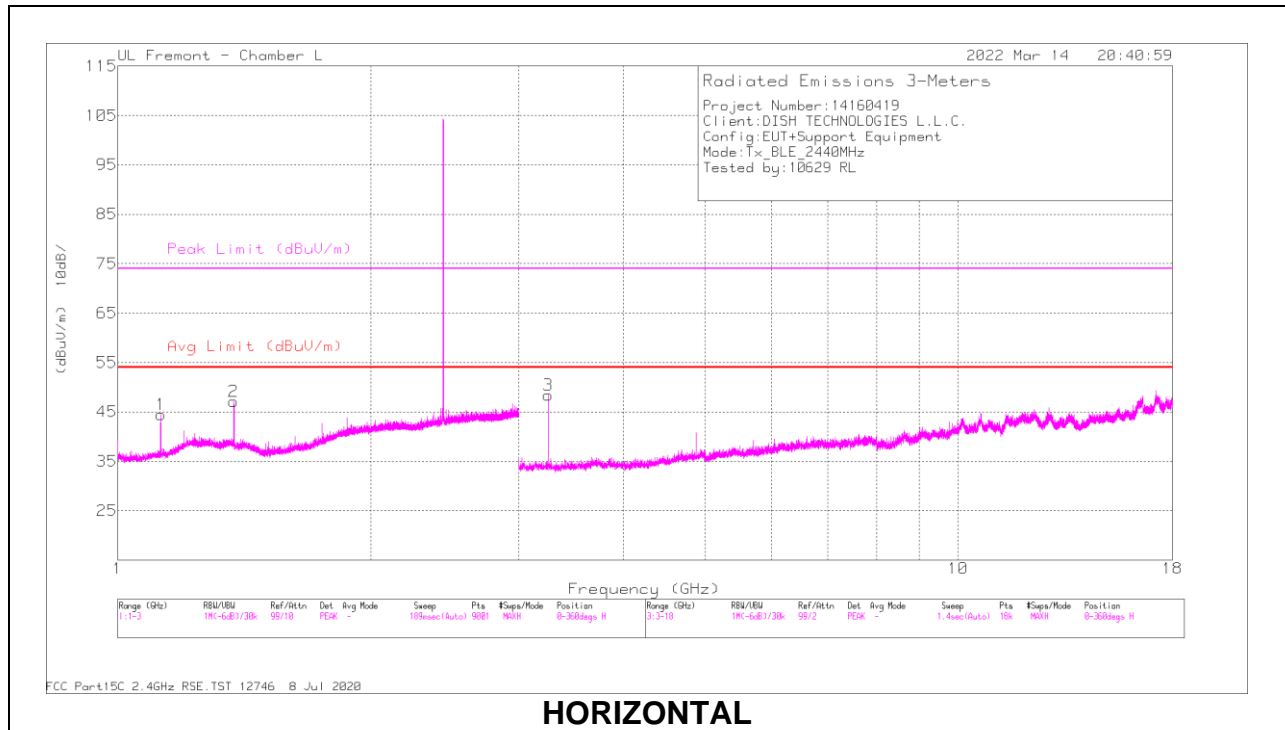

HORIZONTAL

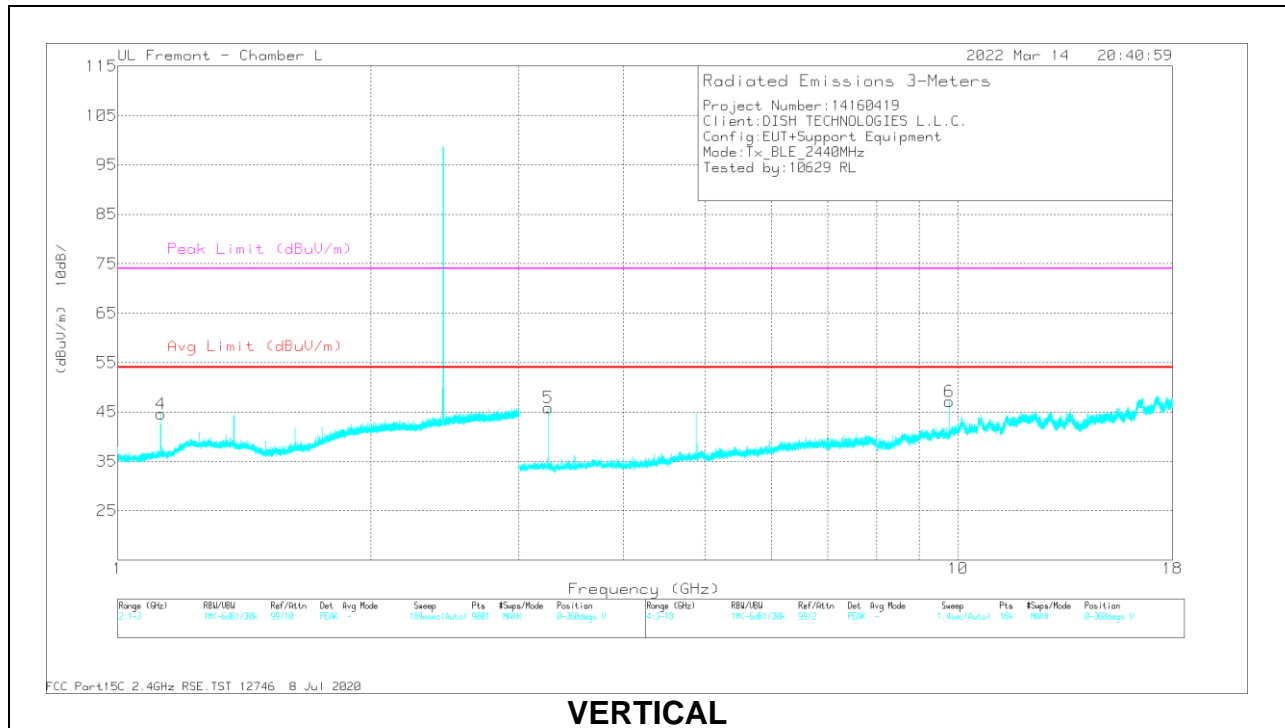

VERTICAL

RADIATED EMISSIONS

Marker	Frequency (GHz)	Meter Reading (dBuV)	Det	AF T119 (dB/m)	Amp/Cbl/Fitr/Pad (dB)	Corrected Reading (dBuV/m)	Avg Limit (dBuV/m)	Margin (dB)	Peak Limit (dBuV/m)	PK Margin (dB)	Azimuth (Degs)	Height (cm)	Polarity
1	* 1.125119	43.3	PK2	28	-23.4	47.9	-	-	74	-26.1	261	156	H
	* 1.125019	33.1	MAv1	28	-23.4	37.7	54	-16.3	-	-	261	156	H
2	* 1.37024	42.25	PK2	29.6	-22.6	49.25	-	-	74	-24.75	292	101	H
	* 1.375106	31.99	MAv1	29.4	-22.6	38.79	54	-15.21	-	-	292	101	H
4	* 1.125119	43.16	PK2	28	-23.4	47.76	-	-	74	-26.24	178	103	V
	* 1.124939	33.3	MAv1	28	-23.4	37.9	54	-16.1	-	-	178	103	V
3	3.253238	46.88	PK2	33	-26.9	52.98	-	-	-	-	155	101	H
	3.253308	43.49	MAv1	33	-26.9	49.59	-	-	-	-	155	101	H
5	3.253283	45.19	PK2	33	-26.9	51.29	-	-	-	-	254	101	V
	3.253323	40.76	MAv1	33	-26.9	46.86	-	-	-	-	254	101	V
6	9.759725	35.74	PK2	37	-17.1	55.64	-	-	-	-	91	102	V
	9.760045	29.41	MAv1	37	-17.1	49.31	-	-	-	-	91	102	V

* - indicates frequency in CFR47 Pt 15 / IC RSS-Restricted Band
 PK2 - KDB558074 Method: Maximum Peak
 MAv1 - KDB558074 Option 1 Maximum RMS Average

HIGH CHANNEL RESULTS

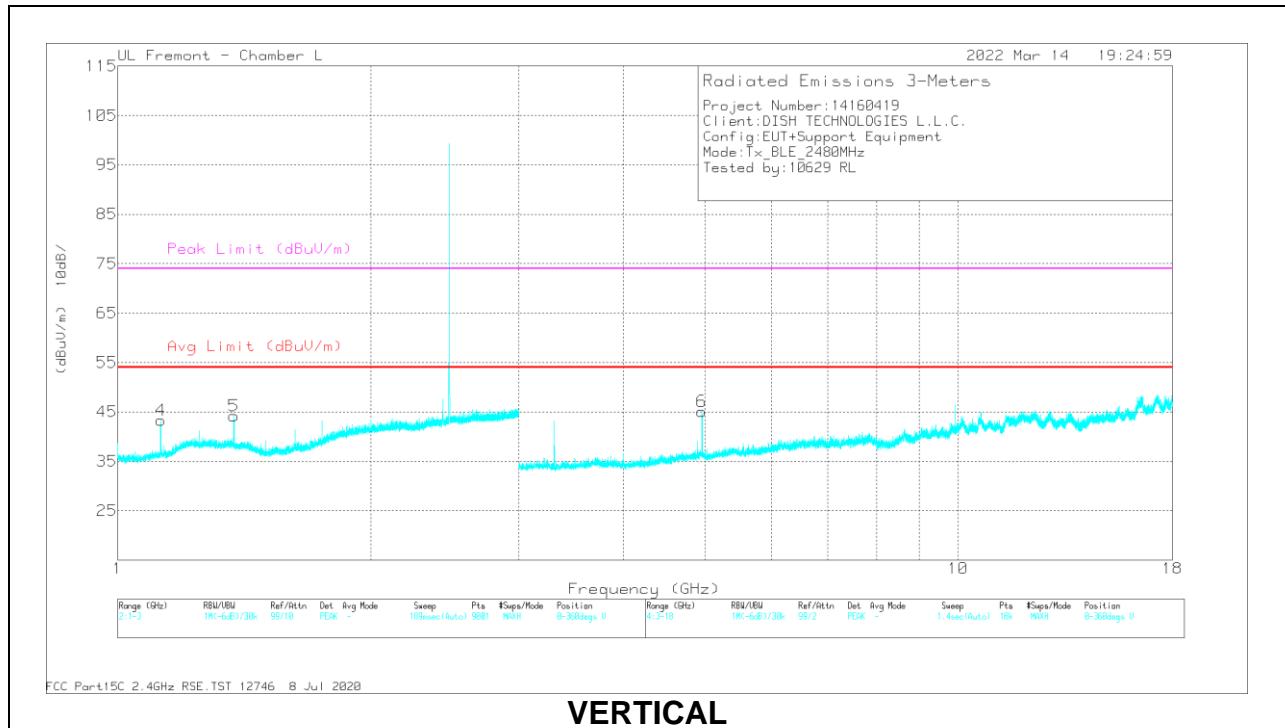
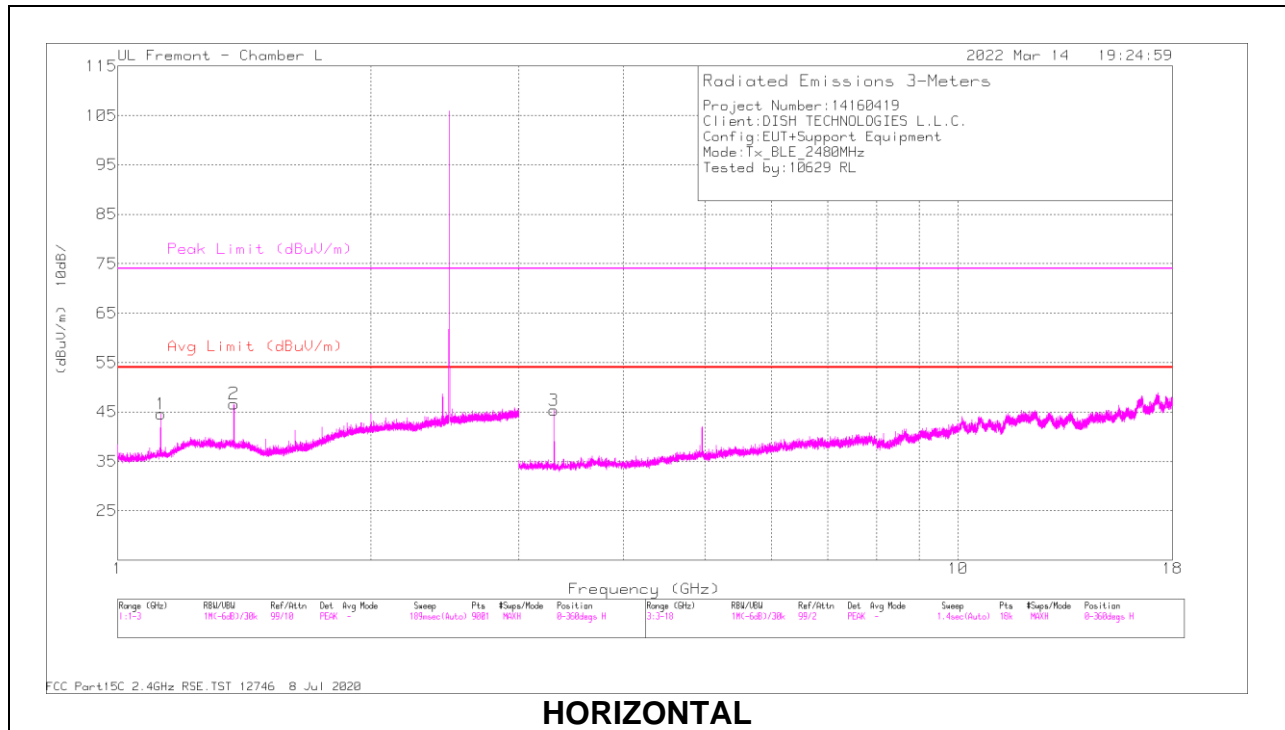

RADIATED EMISSIONS

Marker	Frequency (GHz)	Meter Reading (dBuV)	Det	AF T119 (dB/m)	Amp/Cbl/Filtr/Pad (dB)	Corrected Reading (dBuV/m)	Avg Limit (dBuV/m)	Margin (dB)	Peak Limit (dBuV/m)	PK Margin (dB)	Azimuth (Degs)	Height (cm)	Polarity
1	* 1.125003	46.4	PK2	28	-23.4	51	-	-	74	-23	263	101	H
	* 1.124991	38.56	MAv1	28	-23.4	43.16	54	-10.84	-	-	263	101	H
2	* 1.374968	45.5	PK2	29.4	-22.6	52.3	-	-	74	-21.7	293	101	H
	* 1.374952	38.64	MAv1	29.4	-22.6	45.44	54	-8.56	-	-	293	101	H
4	* 1.124921	45.16	PK2	28	-23.4	49.76	-	-	74	-24.24	317	102	V
	* 1.125013	36.78	MAv1	28	-23.4	41.38	54	-12.62	-	-	317	102	V
5	* 1.37494	44.36	PK2	29.4	-22.6	51.16	-	-	74	-22.84	285	108	V
	* 1.374937	36.45	MAv1	29.4	-22.6	43.25	54	-10.75	-	-	285	108	V
3	3.306679	42.91	PK2	32.5	-26.5	48.91	-	-	-	-	206	123	H
	3.306659	38.43	MAv1	32.5	-26.5	44.43	-	-	-	-	206	123	H
6	* 4.960175	42.28	PK2	34.2	-23.2	53.28	-	-	74	-20.72	213	109	V
	* 4.959776	34.03	MAv1	34.2	-23.2	45.03	54	-8.97	-	-	213	109	V

* - indicates frequency in CFR47 Pt 15 / IC RSS-Restricted Band
 PK2 - KDB558074 Method: Maximum Peak
 MAv1 - KDB558074 Option 1 Maximum RMS Average

10.3. WORST CASE BELOW 30MHZ

SPURIOUS EMISSIONS BELOW 30 MHz (WORST-CASE CONFIGURATION)

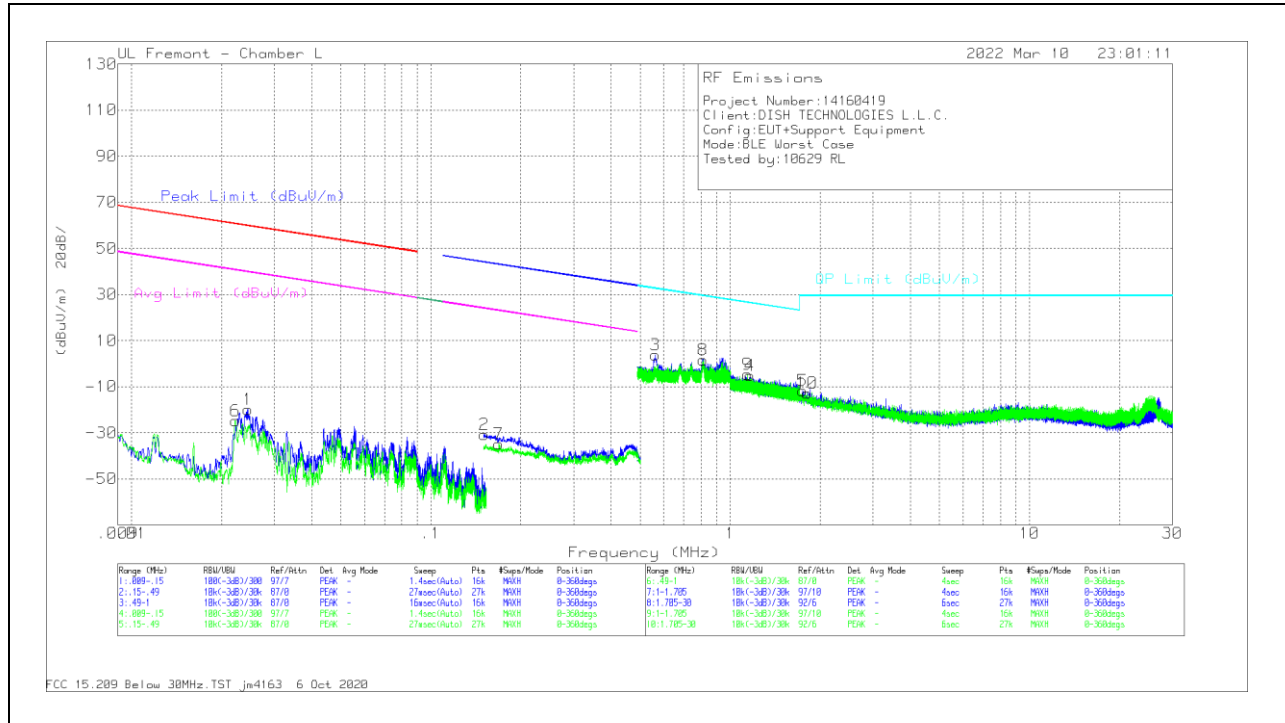

Below 30MHz Data

Marker	Frequency (MHz)	Meter Reading (dBuV)	Det	Loop Antenna (ACF)	Amp/Cbl (dB)	Dist Corr 300m	Corrected Reading (dBuV/m)	Peak Limit (dBuV/m)	Margin (dB)	Avg Limit (dBuV/m)	Margin (dB)	Azimuth (Degs)
1	.0245	33.05	Pk	58.6	-31.4	-80	-19.75	59.82	-79.57	39.82	-59.57	0-360
2	.1512	25.29	Pk	56	-32	-80	-30.71	44.03	-74.74	24.03	-54.74	0-360
6	.0222	27.66	Pk	58.8	-31.2	-80	-24.74	60.65	-85.39	40.65	-65.39	0-360
7	.1689	20.97	Pk	56.1	-32	-80	-34.93	43.07	-78	23.07	-58	0-360

Pk - Peak detector

Marker	Frequency (MHz)	Meter Reading (dBuV)	Det	Loop Antenna (ACF)	Amp/Cbl (dB)	Dist Corr 30m (dB) 40Log	Corrected Reading (dBuV/m)	QP Limit (dBuV/m)	Margin (dB)	Azimuth (Degs)
3	.5628	19.44	Pk	56.2	-31.9	-40	3.74	32.6	-28.86	0-360
8	.8106	17.14	Pk	56.3	-31.9	-40	1.54	29.44	-27.9	0-360
4	1.162	20.62	Pk	46	-31.9	-40	-5.28	26.32	-31.6	0-360
5	1.748	17.13	Pk	42.9	-31.8	-40	-11.77	29.5	-41.27	0-360
9	1.1437	21.25	Pk	46.1	-31.9	-40	-4.55	26.46	-31.01	0-360
10	1.8025	16.47	Pk	42.6	-31.9	-40	-12.83	29.5	-42.33	0-360

Pk - Peak detector

10.4. WORST CASE BELOW 1 GHZ

SPURIOUS EMISSIONS 30 TO 1000 MHz (WORST-CASE CONFIGURATION)

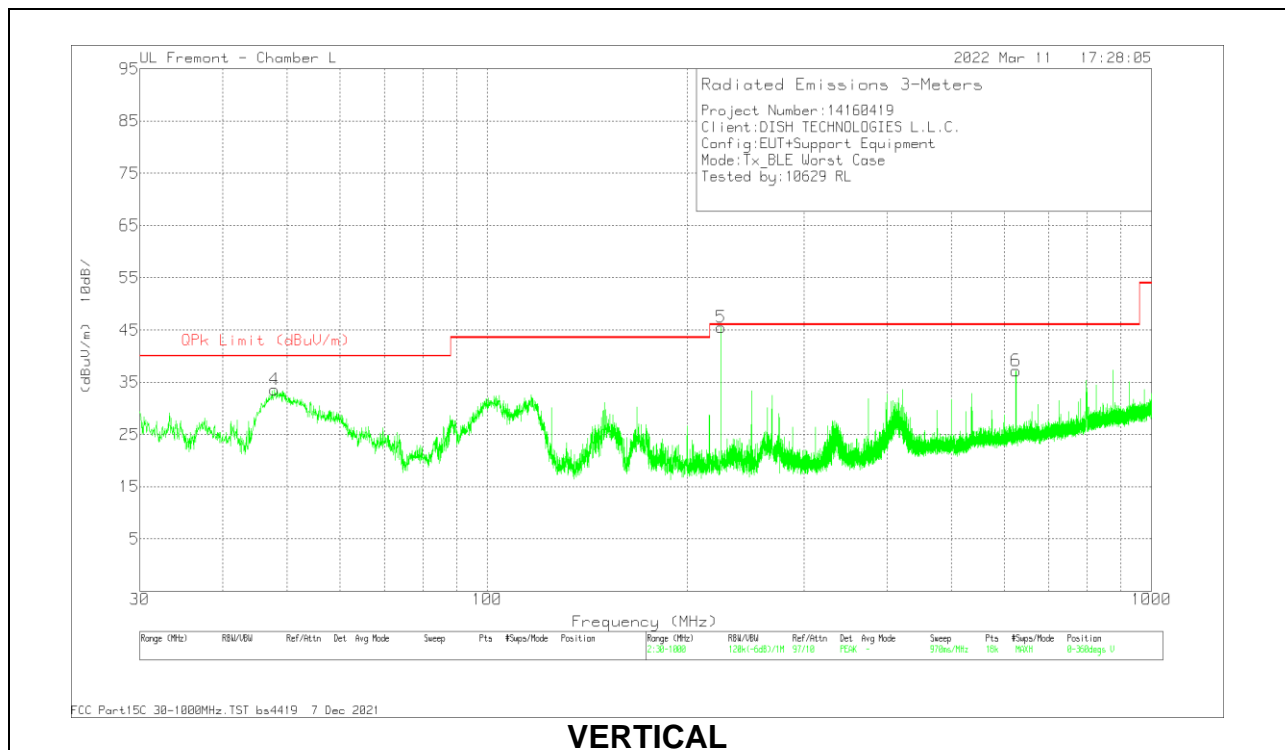
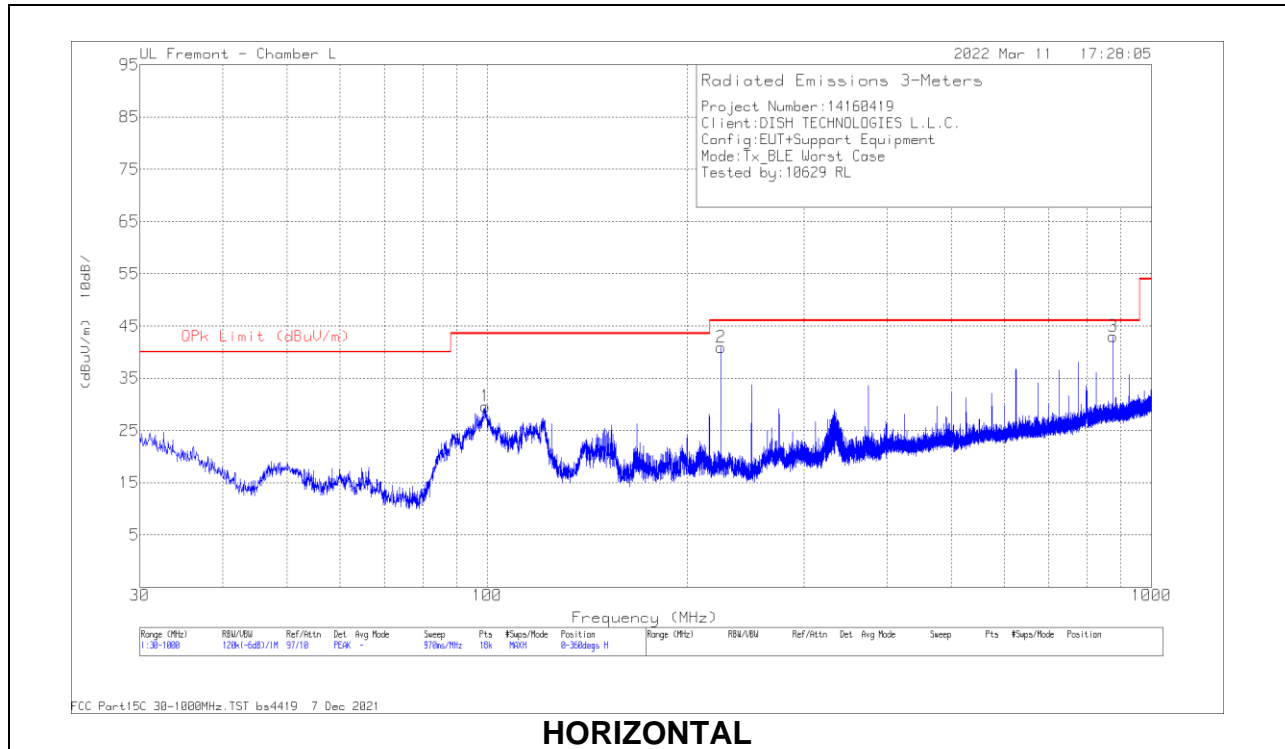

Below 1GHz Data

Marker	Frequency (MHz)	Meter Reading (dBuV)	Det	171862 ACF (dB)	Amp/Cbl (dB)	Corrected Reading (dBuV/m)	QPk Limit (dBuV/m)	Margin (dB)	Azimuth (Degs)	Height (cm)	Polarity
1	99.3013	44.25	Pk	16	-30.7	29.55	43.52	-13.97	0-360	299	H
2	224.97	54.2	Pk	16.6	-29.9	40.9	46.02	-5.12	0-360	199	H
	224.995	53.86	Qp	16.6	-29.9	40.56	46.02	-5.46	71	200	H
3	875.033	42.66	Pk	27.8	-27.4	43.06	46.02	-2.96	0-360	99	H
	875	41.28	Qp	27.8	-27.4	41.68	46.02	-4.34	33	102	H
4	47.8373	50.18	Pk	14.6	-31.2	33.58	40	-6.42	0-360	101	V
5	224.97	58.78	Pk	16.6	-29.9	45.48	46.02	-5.4	0-360	101	V
	225.005	58.61	Qp	16.6	-30	45.21	46.02	-8.1	158	101	V
6	625.042	40.33	Pk	25.2	-28.4	37.13	46.02	-8.89	0-360	101	V

Pk - Peak detector
 Qp - Quasi-Peak detector

10.5. WORST CASE 18-26 GHZ

SPURIOUS EMISSIONS 18-26 GHZ (WORST-CASE CONFIGURATION)

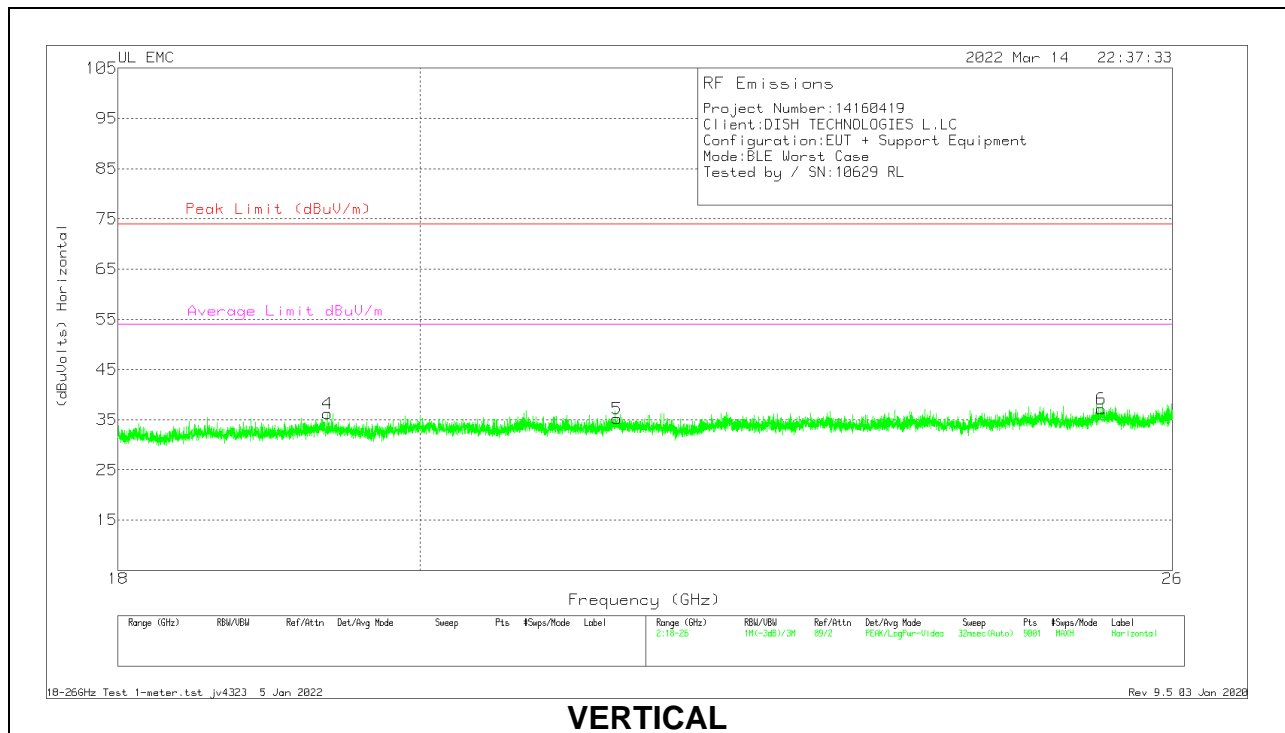
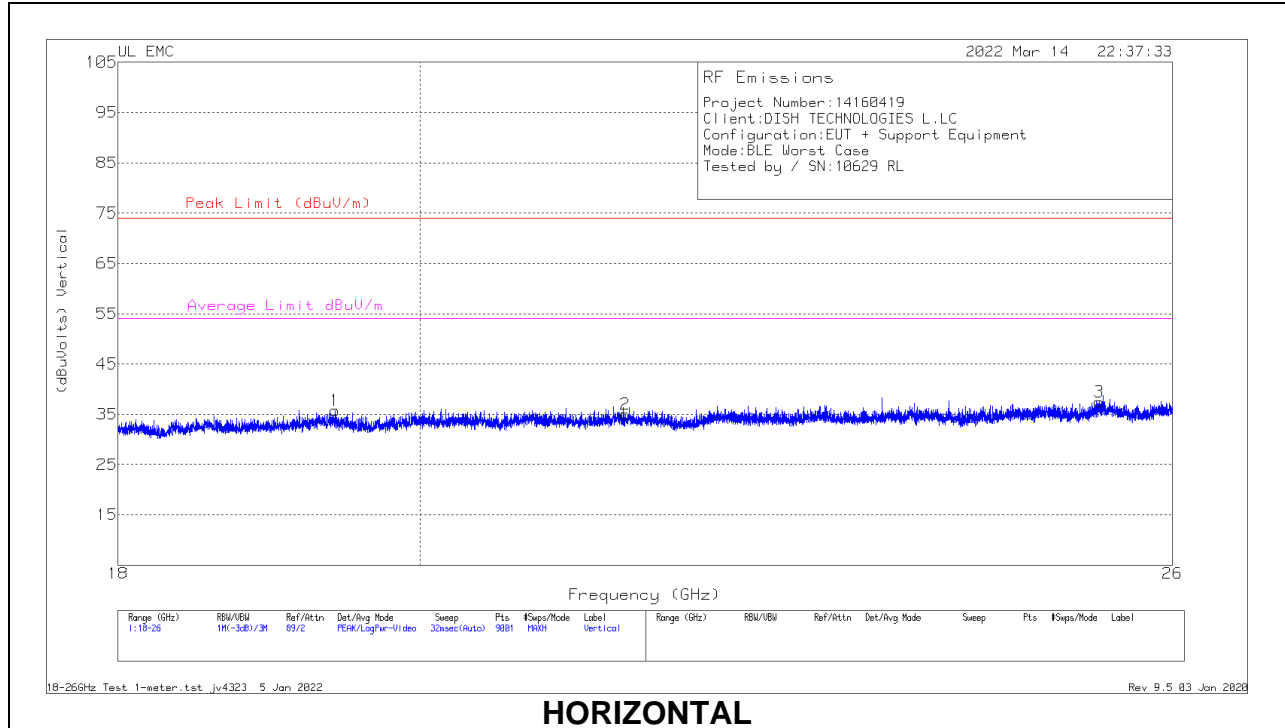

18 – 26GHz Data

Marker	Frequency (GHz)	Meter Reading (dBuV)	Det	AF 81139 (dB/m)	Amp/Cbl (dB)	Dist Corr (dB)	Corrected Reading (dBuVolts)	Peak Limit (dBuV/m)	PK Margin (dB)	Average Limit dBuV/m	Margin (dB)
1	19.41511	68.86	Pk	33.4	-57	-9.5	35.76	74	-38.24	54	-18.24
2	21.48267	67.65	Pk	33.9	-57.1	-9.5	34.95	74	-39.05	54	-19.05
3	25.34311	67.26	Pk	35	-55.3	-9.5	37.46	74	-36.54	54	-16.54
4	19.36533	69.52	Pk	33.4	-57.2	-9.5	36.22	74	-37.78	54	-17.78
5	21.42311	67.82	Pk	33.8	-56.9	-9.5	35.22	74	-38.78	54	-18.78
6	25.36178	66.92	Pk	35	-55.3	-9.5	37.12	74	-36.88	54	-16.88

Pk - Peak detector

11. AC POWER LINE CONDUCTED EMISSIONS

LIMITS

FCC §15.207 (a)

Frequency of Emission (MHz)	Conducted Limit (dB μ V)	
	Quasi-peak	Average
0.15-0.5	66 to 56 *	56 to 46 *
0.5-5	56	46
5-30	60	50

*Decreases with the logarithm of the frequency.

TEST PROCEDURE

The EUT is placed on a non-conducting table 40 cm from the vertical ground plane and 80 cm above the horizontal ground plane. The EUT is configured in accordance with ANSI C63.10.

The receiver is set to a resolution bandwidth of 9 kHz. Peak detection is used unless otherwise noted as quasi-peak or average.

Line conducted data is recorded for both NEUTRAL and HOT lines.

RESULTS

LINE 1 RESULTS

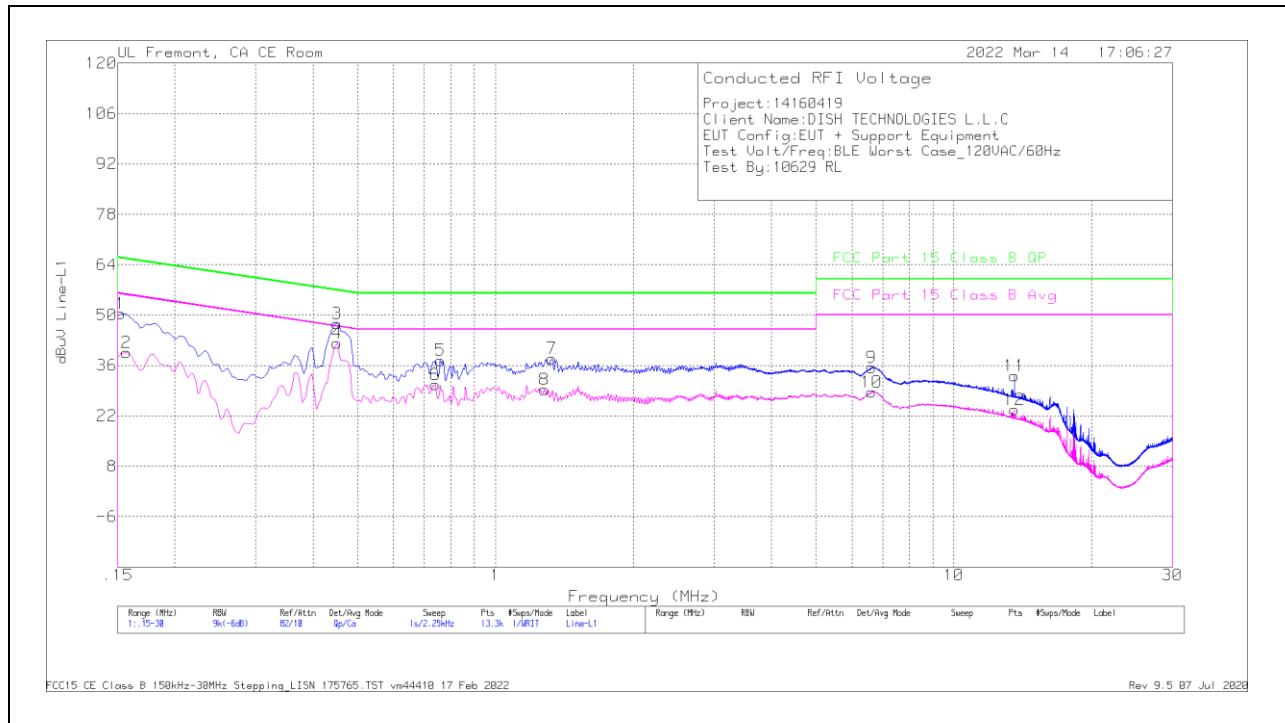

Range 1: Line-L1 .15 - 30MHz											
Marker	Frequency (MHz)	Meter Reading (dBuV)	Det	175765 LISN L1	C1&C3 cable	TekBox Limiter TBFL1 Model 207	Corrected Reading dBuV	FCC Part 15 Class B QP	QP Margin (dB)	FCC Part 15 Class B Avg	Av(CISPR)Margin (dB)
2	.15675	30.04	Ca	.1	0	9.4	39.54	-	-	55.63	-16.09
4	.4515	32.91	Ca	0	0	9.3	42.21	-	-	46.85	-4.64
6	.7395	21.28	Ca	0	.1	9.3	30.68	-	-	46	-15.32
8	1.2795	19.92	Ca	0	.1	9.3	29.32	-	-	46	-16.68
10	6.62325	19.16	Ca	0	.1	9.3	28.56	-	-	50	-21.44
12	13.56	14.12	Ca	.1	.2	9.3	23.72	-	-	50	-26.28
1	.15225	41	Qp	.1	0	9.4	50.5	65.88	-15.38	-	-
3	.4515	38.37	Qp	0	0	9.3	47.67	56.85	-9.18	-	-
5	.75975	28.03	Qp	0	.1	9.3	37.43	56	-18.57	-	-
7	1.329	28.55	Qp	0	.1	9.3	37.95	56	-18.05	-	-
9	6.62325	25.95	Qp	0	.1	9.3	35.35	60	-24.65	-	-
11	13.56	23.55	Qp	.1	.2	9.3	33.15	60	-26.85	-	-

Qp - Quasi-Peak detector
 Ca - CISPR average detection

LINE 2 RESULTS

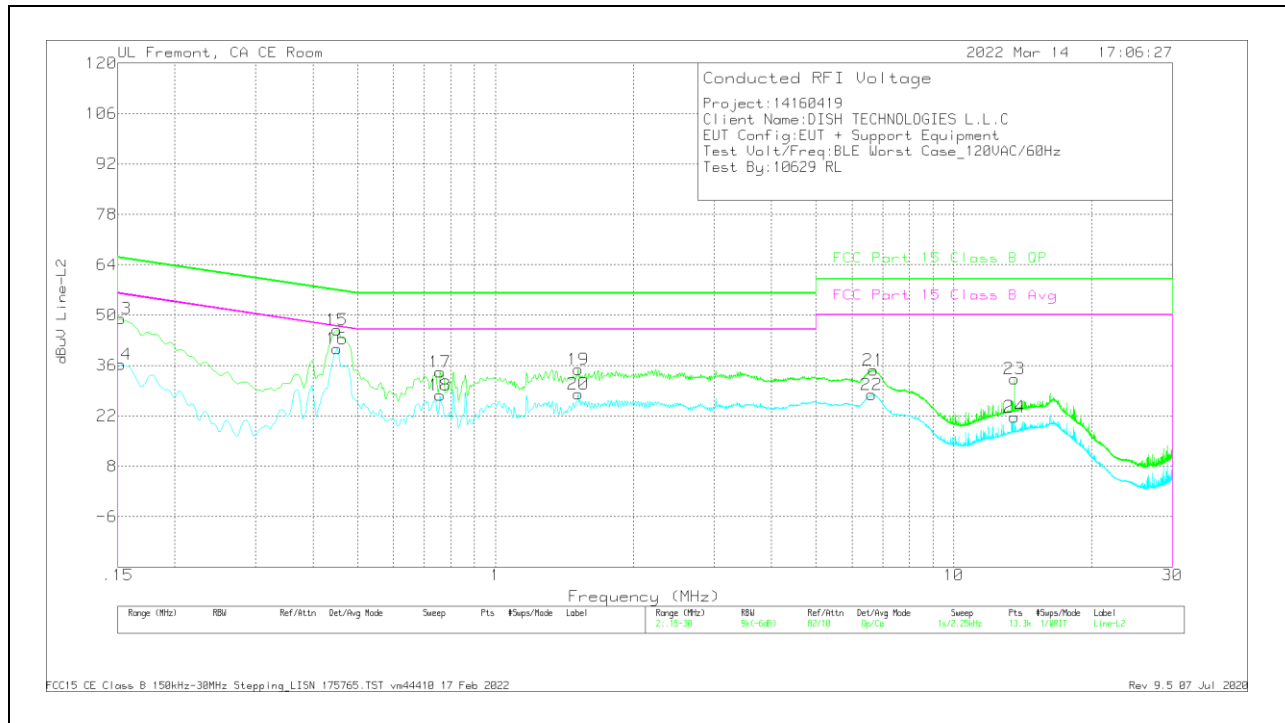

Range 2: Line-L2 .15 - 30MHz											
Marker	Frequency (MHz)	Meter Reading (dBuV)	Det	175765 LISN L2	C2&C3 cable	TekBox Limiter TBFL1 Model 207	Corrected Reading dBuV	FCC Part 15 Class B QP	QP Margin (dB)	FCC Part 15 Class B Avg	Av(CISPR)Margin (dB)
14	.15225	26.73	Ca	.1	0	9.4	36.23	-	-	55.88	-19.65
16	.4515	31.42	Ca	0	0	9.3	40.72	-	-	46.85	-6.13
18	.7575	18.3	Ca	0	.1	9.3	27.7	-	-	46	-18.3
20	1.51575	18.66	Ca	0	.1	9.3	28.06	-	-	46	-17.94
22	6.62775	18.49	Ca	0	.1	9.3	27.89	-	-	50	-22.11
24	13.56	12.12	Ca	.1	.2	9.3	21.72	-	-	50	-28.28
13	.15225	39.6	Qp	.1	0	9.4	49.1	65.88	-16.78	-	-
15	.4515	36.64	Qp	0	0	9.3	45.94	56.85	-10.91	-	-
17	.7575	24.75	Qp	0	.1	9.3	34.15	56	-21.85	-	-
19	1.51575	25.44	Qp	0	.1	9.3	34.84	56	-21.16	-	-
21	6.67275	25.27	Qp	0	.1	9.3	34.67	60	-25.33	-	-
23	13.56	22.63	Qp	.1	.2	9.3	32.23	60	-27.77	-	-

Qp - Quasi-Peak detector
 Ca - CISPR average detection