



CERTIFICATION TEST REPORT

Report Number. : 12875712-E2V2

Applicant : DISH TECHNOLOGIES LLC
9601 MERIDIAN BLVD
ENGLEWOOD, CO 80112

Model : AIRTV 3

FCC ID : DKN-ATV3

EUT Description : OVER THE AIR TV STREAMING DEVICE

Test Standard(s) : FCC 47 CFR PART 15 SUBPART E

Date Of Issue:
August 27, 2019

Prepared by:
UL Verification Services Inc.
47173 Benicia Street
Fremont, CA 94538 U.S.A.
TEL: (510) 319-4000
FAX: (510) 661-0888



NVLAP Lab code: 200065-0

REPORT REVISION HISTORY

Rev.	Issue Date	Revisions	Revised By
V1	8/23/2019	Initial Issue	
V2	8/27/2019	Updated Equipment list, antenna names, OFS statement	Tri Pham

TABLE OF CONTENTS

REPORT REVISION HISTORY	2
TABLE OF CONTENTS	3
1. ATTESTATION OF TEST RESULTS	5
2. TEST METHODOLOGY	6
3. FACILITIES AND ACCREDITATION	6
4. CALIBRATION AND UNCERTAINTY	7
4.1. <i>MEASURING INSTRUMENT CALIBRATION</i>	<i>7</i>
4.2. <i>SAMPLE CALCULATION</i>	<i>7</i>
4.3. <i>MEASUREMENT UNCERTAINTY.....</i>	<i>7</i>
5. EQUIPMENT UNDER TEST	8
5.1. <i>EUT DESCRIPTION</i>	<i>8</i>
5.2. <i>MAXIMUM OUTPUT POWER.....</i>	<i>8</i>
5.3. <i>DESCRIPTION OF AVAILABLE ANTENNAS</i>	<i>9</i>
5.4. <i>SOFTWARE AND FIRMWARE.....</i>	<i>9</i>
5.5. <i>WORST-CASE CONFIGURATION AND MODE.....</i>	<i>9</i>
5.6. <i>DESCRIPTION OF TEST SETUP.....</i>	<i>10</i>
6. MEASUREMENT METHOD.....	13
7. TEST AND MEASUREMENT EQUIPMENT	14
8. ANTENNA PORT TEST RESULTS	15
8.1. <i>ON TIME AND DUTY CYCLE.....</i>	<i>15</i>
8.2. <i>26 dB BANDWIDTH.....</i>	<i>17</i>
8.2.1. <i>802.11n HT20 MODE IN THE 5.2 GHz BAND</i>	<i>18</i>
8.2.2. <i>802.11n HT40 MODE IN THE 5.2 GHz BAND</i>	<i>23</i>
8.2.3. <i>802.11ac VHT80 MODE IN THE 5.2 GHz BAND</i>	<i>27</i>
8.2.4. <i>802.11n HT20 MODE IN THE 5.8 GHz BAND</i>	<i>30</i>
8.2.5. <i>802.11n HT40 MODE IN THE 5.8 GHz BAND</i>	<i>35</i>
8.2.6. <i>802.11ac VHT80 MODE IN THE 5.8 GHz BAND</i>	<i>39</i>
8.3. <i>99% BANDWIDTH.....</i>	<i>42</i>
8.3.1. <i>802.11n HT20 MODE IN THE 5.2 GHz BAND</i>	<i>43</i>
8.3.2. <i>802.11n HT40 MODE IN THE 5.2 GHz BAND</i>	<i>48</i>
8.3.3. <i>802.11ac VHT80 MODE IN THE 5.2 GHz BAND</i>	<i>52</i>
8.3.4. <i>802.11n HT20 MODE IN THE 5.8 GHz BAND</i>	<i>55</i>
8.3.5. <i>802.11n HT40 MODE IN THE 5.8 GHz BAND</i>	<i>60</i>
8.3.6. <i>802.11ac VHT80 MODE IN THE 5.8 GHz BAND</i>	<i>64</i>

8.4.	6 dB BANDWIDTH.....	67
8.4.1.	802.11n HT20 MODE IN THE 5.8 GHz BAND	68
8.4.2.	802.11n HT40 MODE IN THE 5.8 GHz BAND	72
8.4.3.	802.11ac VHT80 MODE IN THE 5.8 GHz BAND	75
8.5.	OUTPUT POWER AND PSD.....	78
8.5.1.	802.11n HT20 MODE IN THE 5.2 GHz BAND	82
8.5.2.	802.11n HT40 MODE IN THE 5.2 GHz BAND	90
8.5.3.	802.11ac VHT80 MODE IN THE 5.2 GHz BAND	96
8.5.4.	802.11n HT20 MODE IN THE 5.8 GHz BAND	102
8.5.5.	802.11n HT40 MODE IN THE 5.8 GHz BAND	109
8.5.6.	802.11ac VHT80 MODE IN THE 5.8 GHz BAND	115
9.	RADIATED TEST RESULTS.....	121
9.1.	TRANSMITTER ABOVE 1 GHZ.....	123
9.1.1.	TX ABOVE 1 GHz 802.11n HT20 MODE IN THE 5.2 GHz BAND.....	123
9.1.2.	TX ABOVE 1 GHz 802.11n HT40 MODE IN THE 5.2 GHz BAND.....	135
9.1.3.	TX ABOVE 1 GHz 802.11ac VHT80 MODE IN THE 5.2 GHz BAND	145
9.1.4.	TX ABOVE 1 GHz 802.11n HT20 MODE IN THE 5.8 GHz BAND.....	153
9.1.5.	TX ABOVE 1 GHz 802.11n HT40 MODE IN THE 5.8 GHz BAND.....	171
9.1.6.	TX ABOVE 1 GHz 802.11ac VHT80 MODE IN THE 5.8 GHz BAND	187
9.2.	WORST CASE BELOW 30MHZ	201
9.3.	WORST CASE BELOW 1 GHZ.....	203
9.4.	WORST CASE 18-26 GHZ	205
9.5.	WORST CASE 26-40 GHZ	207
10.	AC POWER LINE CONDUCTED EMISSIONS.....	209
10.1.1.	AC Power Line Norm	210
11.	SETUP PHOTOS.....	212

1. ATTESTATION OF TEST RESULTS

COMPANY NAME: DISH TECHNOLOGIES LLC
9601 MERIDIAN BLVD
ENGLEWOOD, CO 80112

EUT DESCRIPTION: OVER THE AIR TV STREAMING DEVICE

MODEL: AIRTV 3

SERIAL NUMBER: Conducted: P2-B127
Radiated: P2-B136

DATE TESTED: AUGUST 5, 2019 – AUGUST 19, 2019

APPLICABLE STANDARDS	
STANDARD	TEST RESULTS
CFR 47 Part 15 Subpart E	Complies

UL Verification Services Inc. tested the above equipment in accordance with the requirements set forth in the above standards. The test results show that the equipment tested is capable of demonstrating compliance with the requirements as documented in this report.

The results documented in this report apply only to the tested sample, under the conditions and modes of operation as described herein. It is the manufacturer's responsibility to assure that additional production units of this model are manufactured with identical electrical and mechanical components. All samples tested were in good operating condition throughout the entire test program. Measurement Uncertainties are published for informational purposes only and were not taken into account unless noted otherwise.

This document may not be altered or revised in any way unless done so by UL Verification Services Inc. and all revisions are duly noted in the revisions section. Any alteration of this document not carried out by UL Verification Services Inc. will constitute fraud and shall nullify the document. This report must not be used by the client to claim product certification, approval, or endorsement by NVLAP, NIST, any agency of the Federal Government, or any agency of the U.S. government.

Approved & Released For
UL Verification Services Inc. By:



Frank Ibrahim
Operations Leader
Consumer Technology Division
UL Verification Services Inc.

Prepared By:



TRI PHAM
Project Engineer
Consumer Technology Division
UL Verification Services Inc.

2. TEST METHODOLOGY

The tests documented in this report were performed in accordance with FCC CFR 47 Part 2, FCC CFR 47 Part 15, FCC 14-30, FCC KDB 662911 D01 v02r01, FCC KDB 905462 D02 v02/D03 v01r02/D06 v02, FCC KDB 789033 D02 v02r01, ANSI C63.10-2013, FCC 06-96.

3. FACILITIES AND ACCREDITATION

The test sites and measurement facilities used to collect data are located at 47173 and 47266 Benicia Street, and 47658 Kato Road, Fremont, California, USA. Line conducted emissions are measured only at the 47173 address. The following table identifies which facilities were utilized for radiated emission measurements documented in this report. Specific facilities are also identified in the test results sections.

47173 Benicia Street	47266 Benicia Street	47658 Kato Rd
<input checked="" type="checkbox"/> Chamber A	<input type="checkbox"/> Chamber D	<input checked="" type="checkbox"/> Chamber I
<input type="checkbox"/> Chamber B	<input checked="" type="checkbox"/> Chamber E	<input type="checkbox"/> Chamber J
<input type="checkbox"/> Chamber C	<input type="checkbox"/> Chamber F	<input type="checkbox"/> Chamber K
	<input type="checkbox"/> Chamber G	<input type="checkbox"/> Chamber L
	<input type="checkbox"/> Chamber H	<input type="checkbox"/> Chamber M

The above test sites and facilities are covered under FCC Test Firm Registration # 208313. Chambers above are covered under Industry Canada company address and respective code: 2324A.

UL Verification Services Inc. is accredited by NVLAP, Laboratory Code 200065-0

4. CALIBRATION AND UNCERTAINTY

4.1. MEASURING INSTRUMENT CALIBRATION

The measuring equipment utilized to perform the tests documented in this report has been calibrated in accordance with the manufacturer's recommendations, and is traceable to recognized national standards.

4.2. SAMPLE CALCULATION

RADIATED EMISSIONS

Where relevant, the following sample calculation is provided:

Field Strength (dBuV/m) = Measured Voltage (dBuV) + Antenna Factor (dB/m) + Cable Loss (dB) – Preamp Gain (dB)

$$36.5 \text{ dBuV} + 18.7 \text{ dB/m} + 0.6 \text{ dB} - 26.9 \text{ dB} = 28.9 \text{ dBuV/m}$$

MAINS CONDUCTED EMISSIONS

Where relevant, the following sample calculation is provided:

Final Voltage (dBuV) = Measured Voltage (dBuV) + Cable Loss (dB) + Limiter Factor (dB) + LISN Insertion Loss.

$$36.5 \text{ dBuV} + 0 \text{ dB} + 10.1 \text{ dB} + 0 \text{ dB} = 46.6 \text{ dBuV}$$

4.3. MEASUREMENT UNCERTAINTY

Where relevant, the following measurement uncertainty levels have been estimated for tests performed on the apparatus:

PARAMETER	UNCERTAINTY
Worst Case Conducted Disturbance, 9KHz to 0.15 MHz	3.84 dB
Worst Case Conducted Disturbance, 0.15 to 30 MHz	3.65 dB
Worst Case Radiated Disturbance, 9KHz to 30 MHz	2.52 dB
Worst Case Radiated Disturbance, 30 to 1000 MHz	4.88 dB
Worst Case Radiated Disturbance, 1000 to 18000 MHz	4.24 dB
Worst Case Radiated Disturbance, 18000 to 26000 MHz	4.37 dB
Worst Case Radiated Disturbance, 26000 to 40000 MHz	5.17 dB

Uncertainty figures are valid to a confidence level of 95%.

5. EQUIPMENT UNDER TEST

5.1. EUT DESCRIPTION

The EUT is an over the air tv streaming device.

5.2. MAXIMUM OUTPUT POWER

The transmitter has a maximum conducted output power as follows:

5.2 GHz BAND (FCC)

Frequency Range (MHz)	Mode	Output Power (dBm)	Output Power (mW)
5.2 GHz band, 1TX			
5180-5240	802.11n HT20	12.95	19.72
5190-5230	802.11n HT40	12.86	19.32
5210	802.11ac VHT80	10.94	12.42
5.2 GHz band, 2TX			
5180-5240	802.11n HT20 CDD	15.67	36.90
5190-5230	802.11n HT40 CDD	15.55	35.89
5210	802.11ac VHT80 CDD	13.81	24.04

5.8 GHz BAND (FCC)

Frequency Range (MHz)	Mode	Output Power (dBm)	Output Power (mW)
5.8 GHz band, 1TX			
5745-5825	802.11n HT20	9.94	9.86
5755-5795	802.11n HT40	9.76	9.46
5775	802.11ac VHT80	9.93	9.84
5.8 GHz band, 2TX			
5745-5825	802.11n HT20 CDD	12.78	18.97
5755-5795	802.11n HT40 CDD	12.59	18.16
5775	802.11ac VHT80 CDD	12.73	18.75

5.3. DESCRIPTION OF AVAILABLE ANTENNAS

The radio utilizes an embedded antenna, with a maximum gain of 3.6 dBi.

5.4. SOFTWARE AND FIRMWARE

The EUT firmware installed during testing was WCA 3.0.

The test utility software used during testing was the Marvel Labtool.

5.5. WORST-CASE CONFIGURATION AND MODE

Radiated emissions below 1GHz, above 18GHz, and power line conducted emission were performed with the EUT set to transmit at the channel with highest output power as worst-case scenario.

Band edge and radiated emissions between 1GHz and 18GHz were performed with the EUT set to transmit at the highest power on low, middle and high channels.

The fundamental of the EUT was tested at normal operation on the Y-axis position.

For 11n HT20, 11n HT40, and 11ac VHT80, radiated harmonics spurious were performed with the EUT set at the 2TX CDD mode with power setting equal or higher than SISO modes as the worst-case scenario. 11a mode covered by 11n HT20 mode since it has the same power as 11n HT20.

Worst-case data rates as provided by the client were:

802.11n HT20 1Tx mode: MCS0
802.11n HT40 1Tx mode: MCS0
802.11ac VHT80 1Tx mode: MCS0
802.11n HT20 2Tx mode: MCS8
802.11n HT40 2Tx mode: MCS8
802.11ac VHT80 2Tx mode: MCS0

5.6. DESCRIPTION OF TEST SETUP

SUPPORT EQUIPMENT

Support Equipment List				
Description	Manufacturer	Model	Serial Number	FCC ID
Laptop	Hewlett-Packard	EliteBook 8470P	CNU342CL9Z	n/a
Laptop AC-DC power supply	Hewlett-Packard	PA-1650-32HJ	ETC1806006544	n/a
AC-DC Power supply	LITE-ON	PB-1300-1ES1	ETC1806006544	n/a

I/O CABLES

I/O Cable List						
Cable No	Port	# of identical ports	Connector Type	Cable Type	Cable Length (m)	Remarks
1	Ethernet	1	Ethernet	Un-shielded	2	Laptop to EUT
2	AC	1	AC	Un-shielded	1.5	
3	Coaxial	1	Coaxial	shielded	2	EUT to 50 Ohm load

CONDCUTED TEST SETUP DIAGRAM

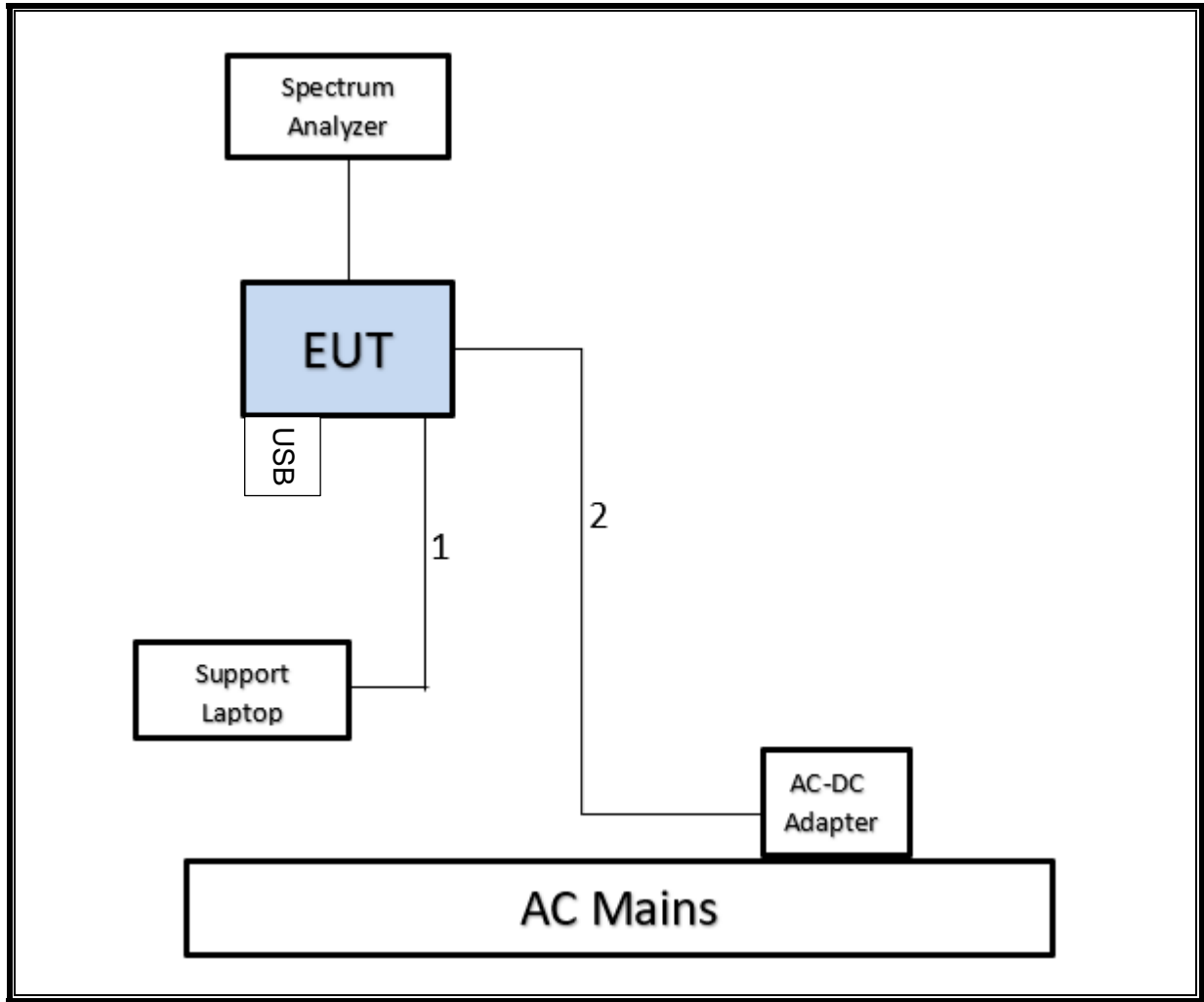

TEST SETUP

For conducted tests, the EUT was connected to a laptop. The test software exercises the radio.

RADIATED AND AC LINE CONDUCTED EMISSIONS SETUP DIAGRAM

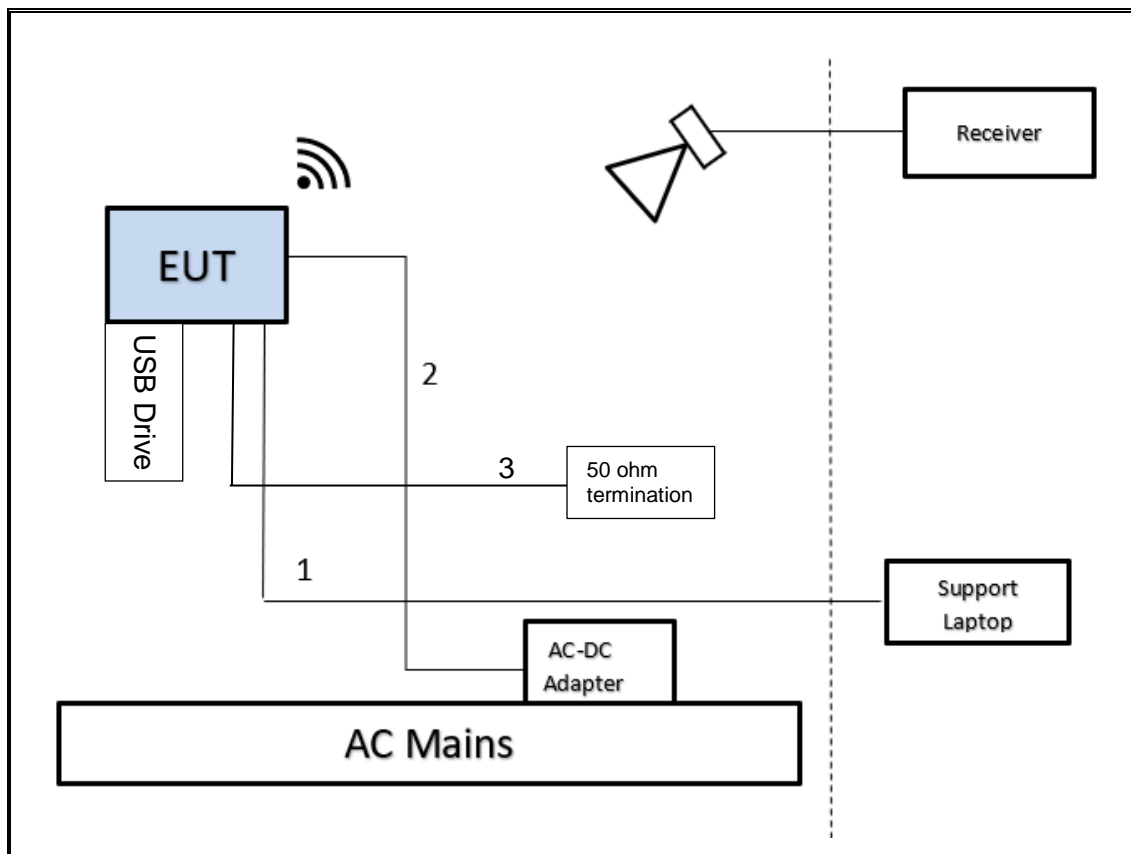

TEST SETUP

For radiated tests: EUT is connected to a laptop. The test software exercises the radio.

6. MEASUREMENT METHOD

On Time and Duty Cycle: KDB 789033 D02 v02r01, Section B.

6 dB Emission BW: KDB 789033 D02 v02r01, Section C.2

26 dB Emission BW: KDB 789033 D02 v02r01, Section C.1

99% Occupied BW: KDB 789033 D02 v02r01, Section D.

Conducted Output Power: KDB 789033 D02 v02r01, Section E.3.b (Method PM-G) and KDB 789033 D02 v02r01, Section E.2.b (Method SA-1)

Power Spectral Density: KDB 789033 D02 v02r01, Section F

Unwanted emissions in restricted bands: KDB 789033 D02 v02r01, Sections G.3, G.4, G.5, and G.6.

Unwanted emissions in non-restricted bands: KDB 789033 D02 v02r01, Sections G.3, G.4, and G.5.

AC Power Line Conducted Emissions: ANSI C63.10-2013, Section 6.2.

Radiated Spurious Emissions Below 30MHz: ANSI C63.10-2013 Section 6.4

7. TEST AND MEASUREMENT EQUIPMENT

The following test and measurement equipment was utilized for the tests documented in this report:

TEST EQUIPMENT LIST					
Description	Manufacturer	Model	ID Num	Cal Due	Last Cal
3 Port rf switch	DOW-KEY MICROWAVE	401-2308	172937	09/15/2019	09/15/2018
6 Port rf switch	NARDA	SEM163	172935	09/15/2019	09/15/2018
6 Port rf switch	Pasternack	PE7165	172936	09/17/2019	09/17/2018
Amplifier 1-8GHz 30dB gain	L3 Narda	AMF-4D-01000800-30-29P	167492	05/24/2020	06/24/2019
Amplifier, 1 to 18GHz, 35dB	AMPLICAL	AMP1G18-35	138301	09/15/2019	09/15/2018
Amplifier, 1 to 8GHz, 35dB	Miteq Inc.	AMF-4D-01000800-30-29P	T1573	12/01/2019	12/01/2018
Amplifier, 1 to 8GHz, 35dB	MITEQ	AMF-4D-01000800-30-29P	T1169	09/15/2019	09/15/2018
Amplifier, 100KHz to 1GHz, 32dB	Agilent (Keysight) Technologies	8447D	T15	10/20/2019	10/20/2018
Amplifier, 10KHz to 1GHz, 32dB	SONOMA INSTRUMENT	310	T285	06/06/2020	07/06/2019
Amplifier, 9KHz to 1GHz, 32dB	SONOMA INSTRUMENT	310	PRE0180175	05/29/2020	06/29/2019
Antenna, Broadband Hybrid, 30MHz to 2000MHz	Sunol Sciences Corp.	JB1	T130	08/09/2020	08/09/2019
Antenna, Horn 1-18GHz	ETS-Lindgren	3117	T119	03/22/2020	03/22/2019
Antenna, BroadBand Hybrid, 30MHz to 3GHz	Sunol Sciences Corp.	JB3	PRE0184971	11/13/2019	11/13/2018
EMI TEST RECEIVER	Rohde & Schwarz	ESW44	PRE0179376	02/14/2020	02/14/2019
RF Amplifier, 1-18GHz	MITEQ	AFS42-00101800-25-S-42	T1165	05/24/2020	06/24/2019
RF Filter Box	UL (IN HOUSE)		172938	09/15/2019	09/15/2018
RF Filter Box, 1-18GHz	UL (IN HOUSE)		168534	05/24/2020	06/24/2019
RF SWITCH	Pasternack	PE7159	T1274	05/24/2020	06/24/2019
RF SWITCH	DOW-KEY MICROWAVE	401-2308	T729	05/24/2020	06/24/2019
Semianechoic Chamber A	TDK RF SOLUTIONS INC.	N/A	T1199	01/18/2021	01/18/2019
Spectrum Analyzer, PXA, 3Hz to 44GHz	Agilent (Keysight) Technologies	N9030A	T908	01/24/2020	01/24/2019
Spectrum Analyzer, PXA, 3Hz to 44GHz	Agilent (Keysight) Technologies	N9030A	T1466	01/23/2020	01/23/2019
Thermometer	Control Company	14-650-118, 15557603	T1820	02/26/2020	02/26/2019

Test Software List			
Description	Manufacturer	Model	Version
Radiated Software	UL	UL EMC	Ver 9.5, June 24, 2015
Conducted Software	UL	UL EMC	Ver 9.5, May 26, 2015
Antenna Port Software	UL	UL RF	Ver 3.9.1, Dec 28, 2015

8. ANTENNA PORT TEST RESULTS

8.1. ON TIME AND DUTY CYCLE

LIMITS

None; for reporting purposes only.

PROCEDURE

KDB 558074 Zero-Span Spectrum Analyzer Method.

ON TIME AND DUTY CYCLE RESULTS

Mode	ON Time B (msec)	Period (msec)	Duty Cycle x (linear)	Duty Cycle (%)	Duty Cycle Correction Factor (dB)	1/B Minimum VBW (kHz)
802.11n HT20 1TX	4.760	4.870	0.977	97.74%	0.10	0.210
802.11n HT20 CDD	2.408	2.512	0.959	95.86%	0.18	0.415
802.11n HT40 1TX	2.315	2.420	0.957	95.66%	0.19	0.432
802.11n HT40 CDD	1.1780	1.2760	0.923	92.32%	0.35	0.849
802.11ac VHT80 1TX	1.095	1.200	0.913	91.25%	0.40	0.913
802.11ac VHT80 CDD	1.564	1.666	0.939	93.88%	0.27	0.639



DUTY CYCLE 802.11n HT20 1TX MODE

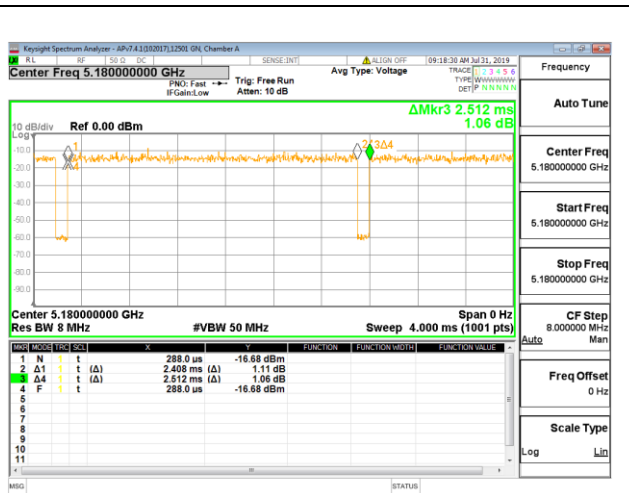

DUTY CYCLE 802.11n HT20 CDD MODE



DUTY CYCLE 802.11n HT40 1TX MODE

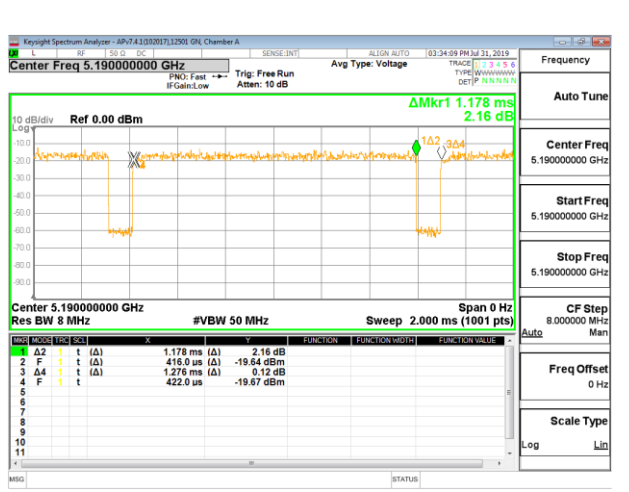

DUTY CYCLE 802.11n HT40 CDD MODE

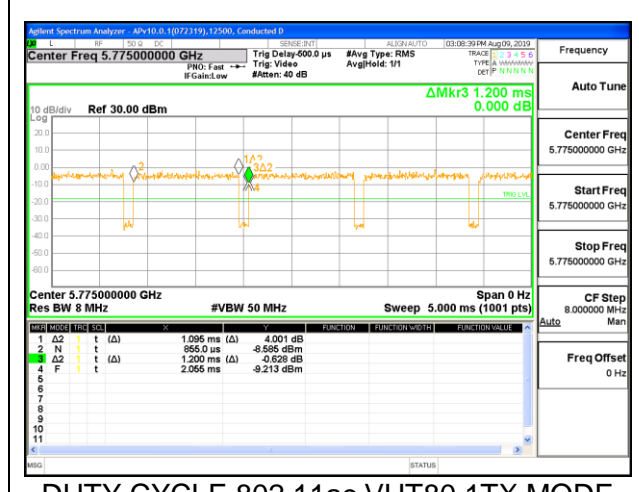

DUTY CYCLE 802.11ac VHT80 1TX MODE

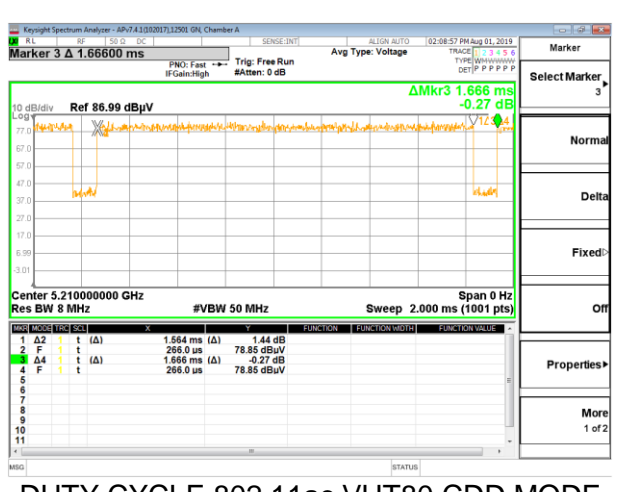

DUTY CYCLE 802.11ac VHT80 CDD MODE

8.2. 26 dB BANDWIDTH

LIMITS

None; for reporting purposes only.

RESULTS

8.2.1. 802.11n HT20 MODE IN THE 5.2 GHz BAND

1TX Antenna 1 MODE

Channel	Frequency (MHz)	26 dB Bandwidth (MHz)
Low	5180	21.05
Mid	5200	21.20
High	5240	21.30

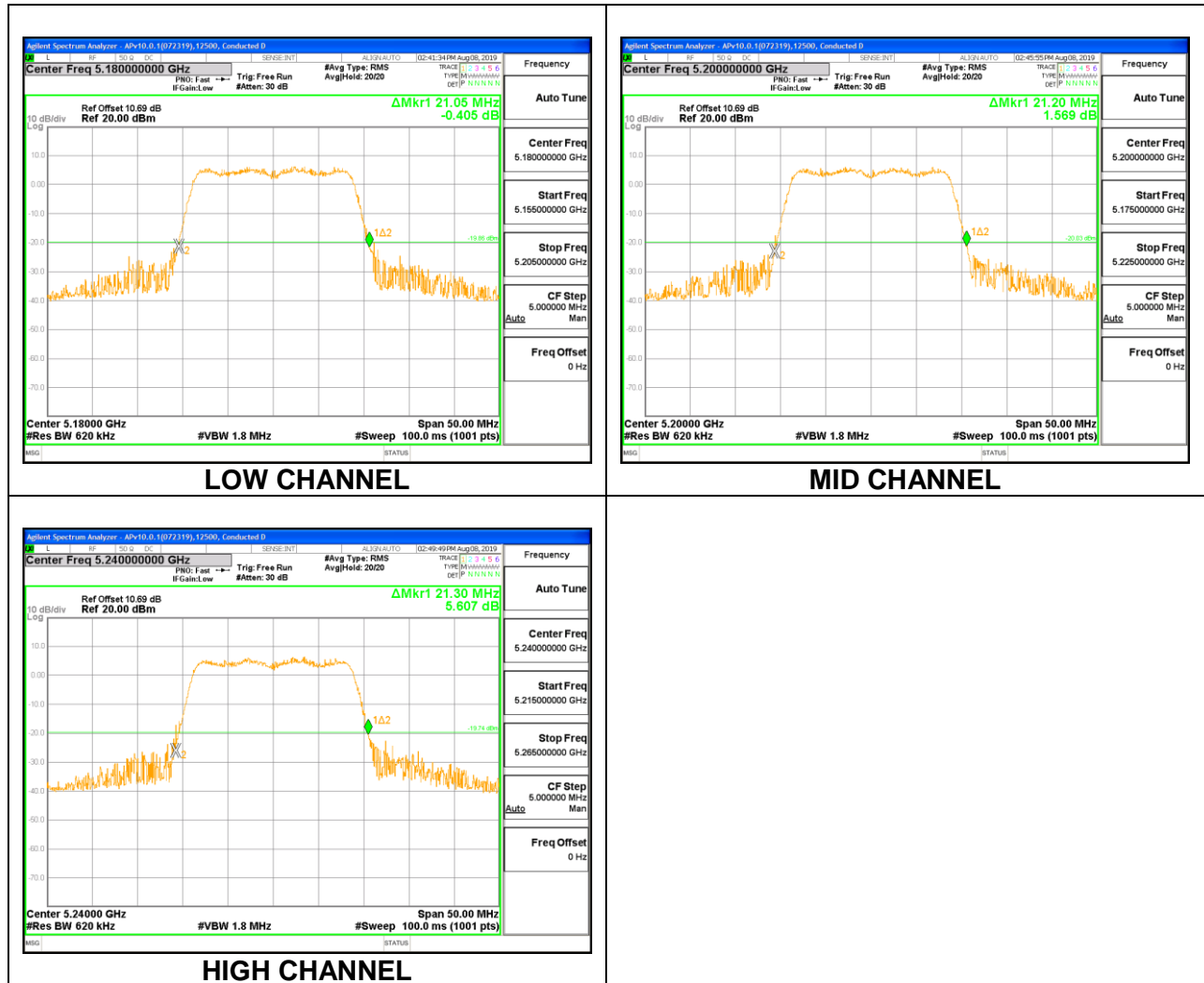

1TX Antenna 2 MODE

Channel	Frequency (MHz)	26 dB Bandwidth (MHz)
Low	5180	21.00
Mid	5200	21.25
High	5240	21.20

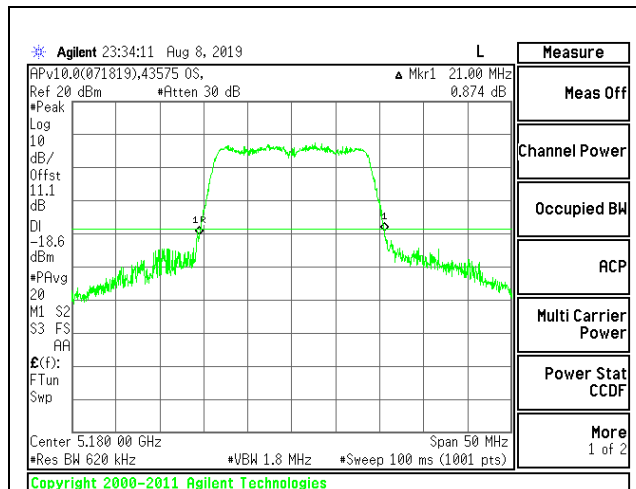

LOW CHANNEL

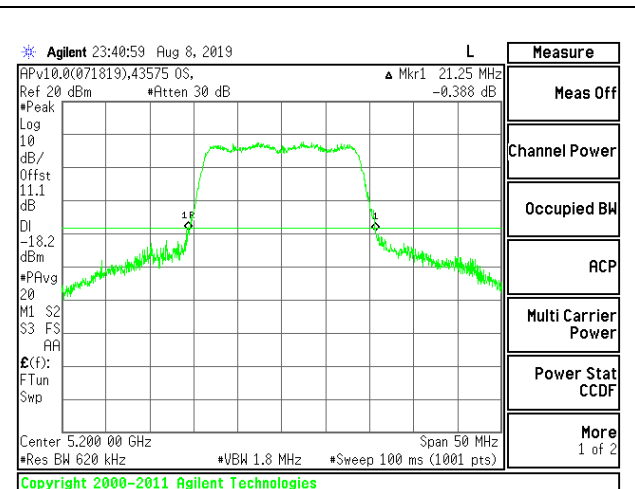

MID CHANNEL

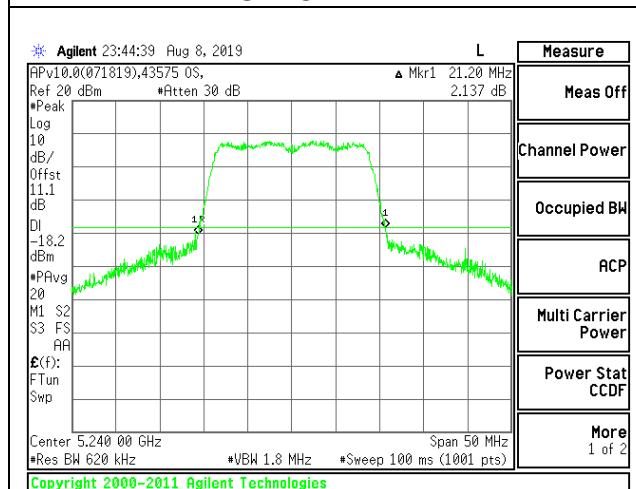

HIGH CHANNEL

2TX Antenna 1 + Antenna 2 CDD MODE

Channel	Frequency (MHz)	26 dB Bandwidth Antenna 1 (MHz)	26 dB Bandwidth Antenna 2 (MHz)
Low	5180	21.45	21.05
Mid	5200	21.25	21.25
High	5240	21.05	20.95

LOW CHANNEL

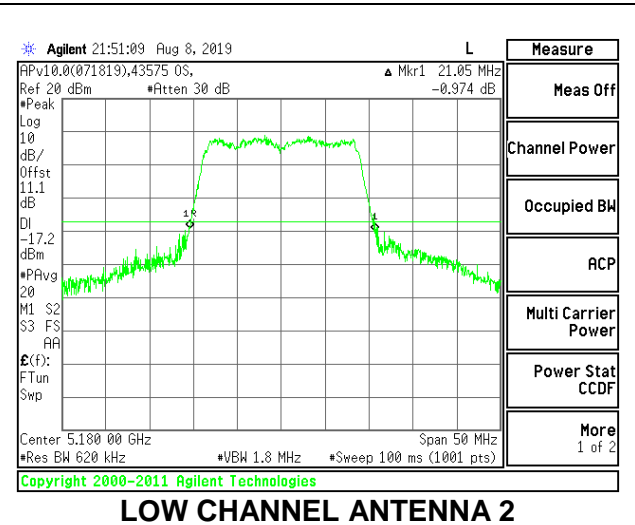
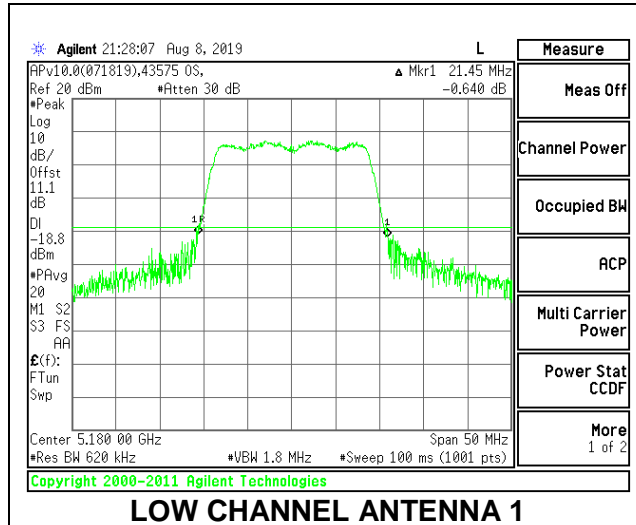

MID CHANNEL

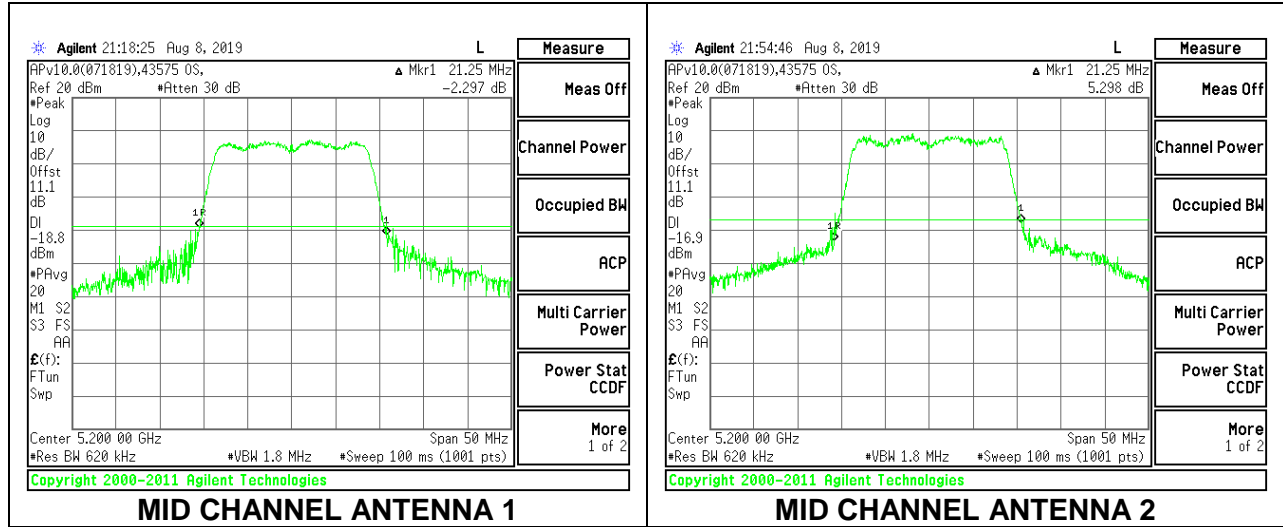

HIGH CHANNEL

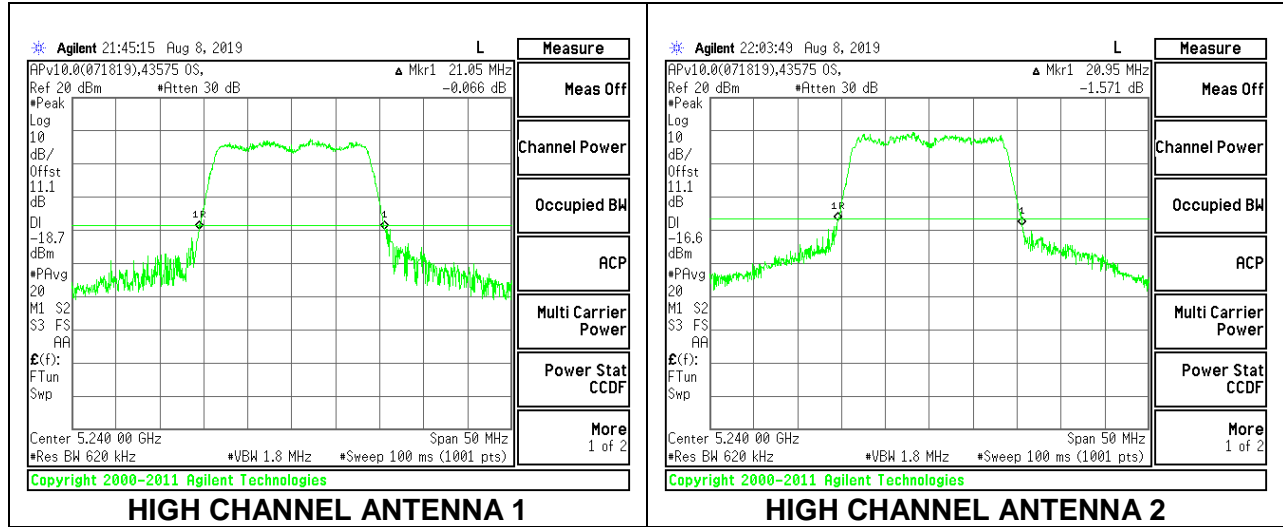

HIGH CHANNEL ANTENNA 1

HIGH CHANNEL ANTENNA 2

8.2.2. 802.11n HT40 MODE IN THE 5.2 GHz BAND

1TX Antenna 1 MODE

Channel	Frequency (MHz)	26dB Bandwidth (MHz)
Low	5190	43.40
High	5230	43.30

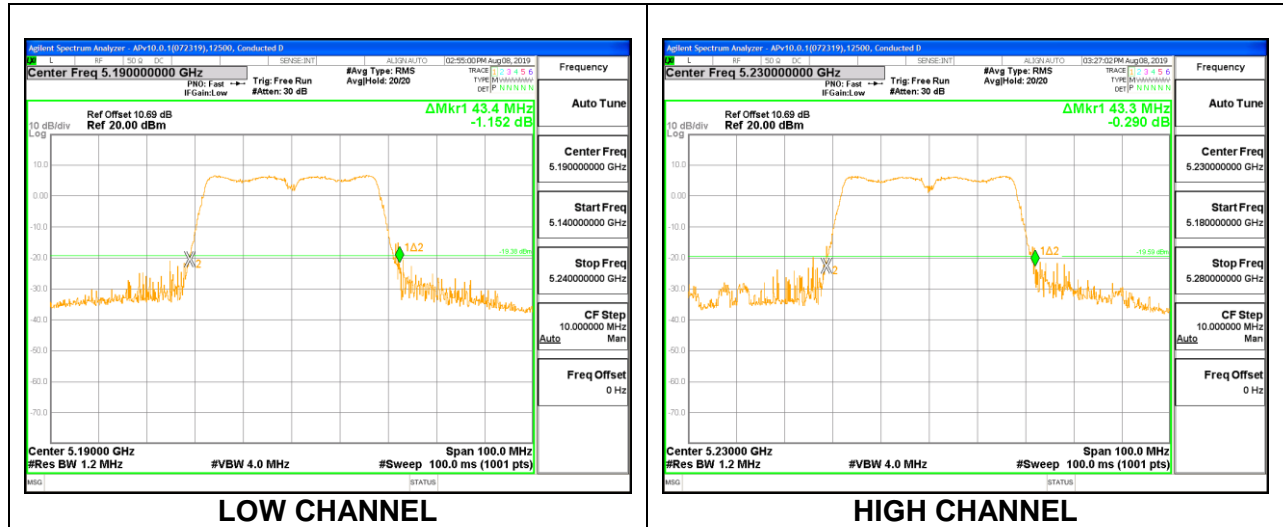

1TX Antenna 2 MODE

Channel	Frequency (MHz)	26dB Bandwidth (MHz)
Low	5190	42.50
High	5230	44.50

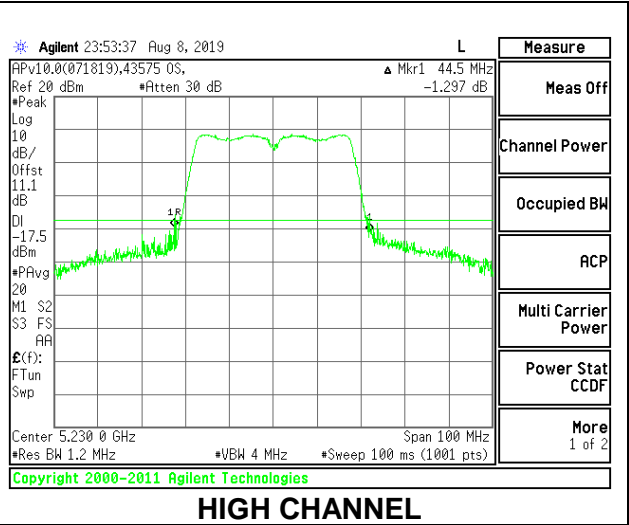
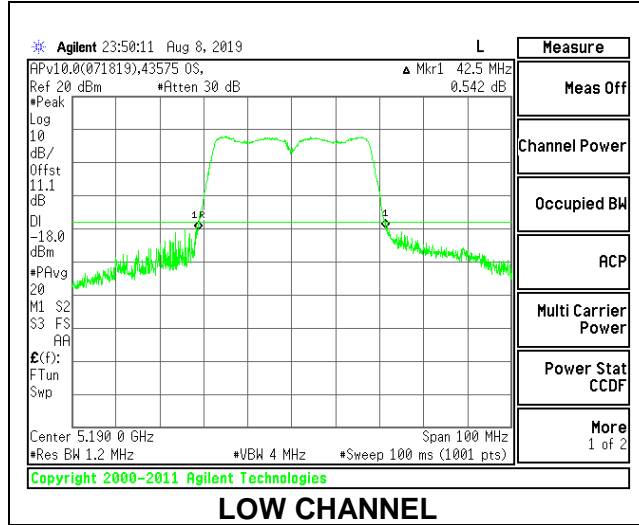

2TX Antenna 1 + Antenna 2 CDD MODE

Channel	Frequency (MHz)	26 dB Bandwidth Antenna 1 (MHz)	26 dB Bandwidth Antenna 2 (MHz)
Low	5190	44.00	42.80
High	5230	43.20	43.80

LOW CHANNEL

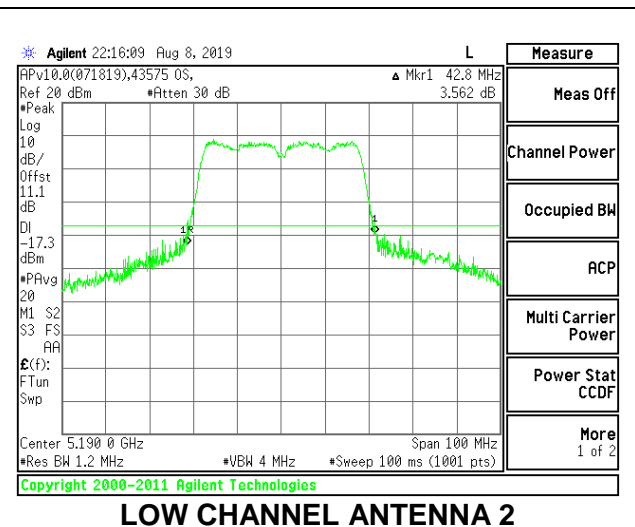
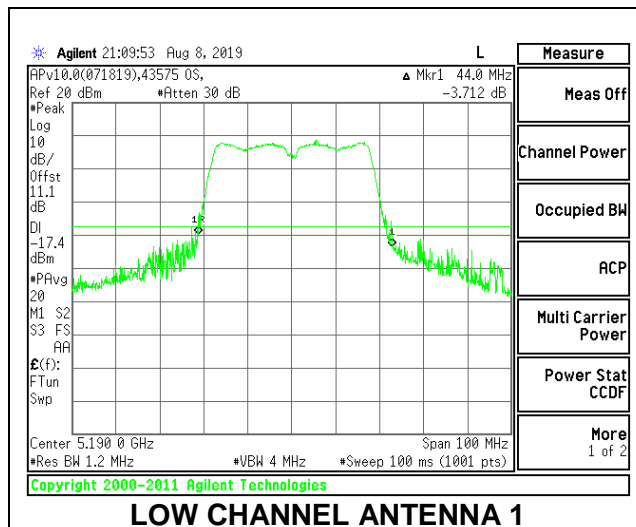

HIGH CHANNEL

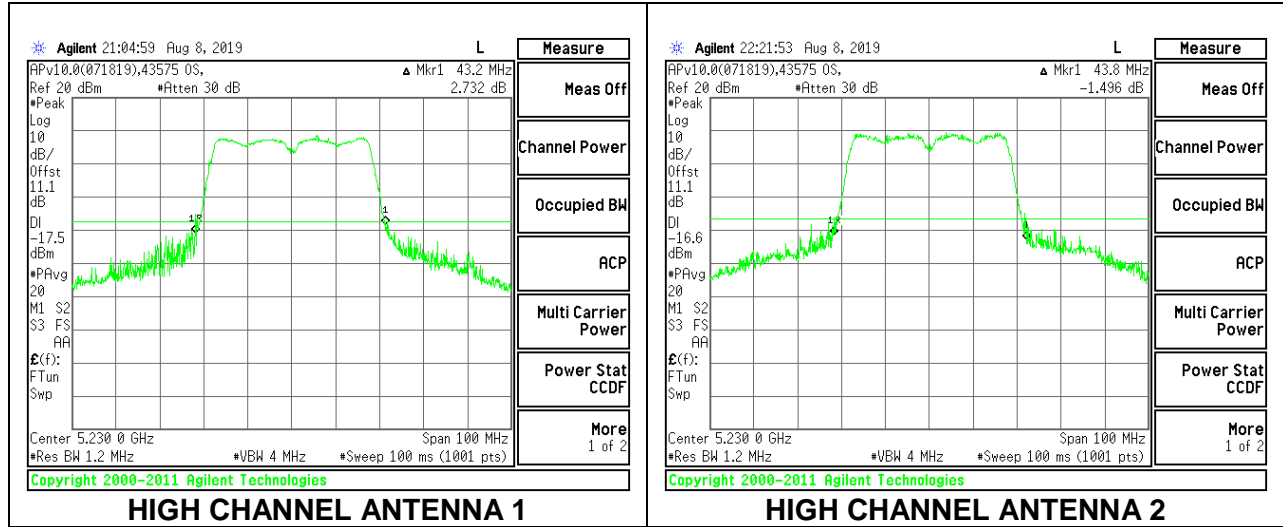

8.2.3. 802.11ac VHT80 MODE IN THE 5.2 GHz BAND

1TX Antenna 1 MODE

Channel	Frequency (MHz)	26 dB Bandwidth (MHz)
Mid	5210	85.20

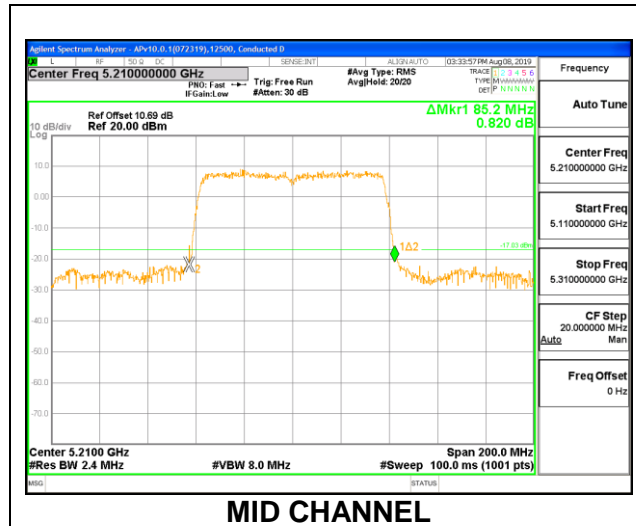

1TX Antenna 2 MODE

Channel	Frequency (MHz)	26 dB Bandwidth (MHz)
Mid	5210	85.20

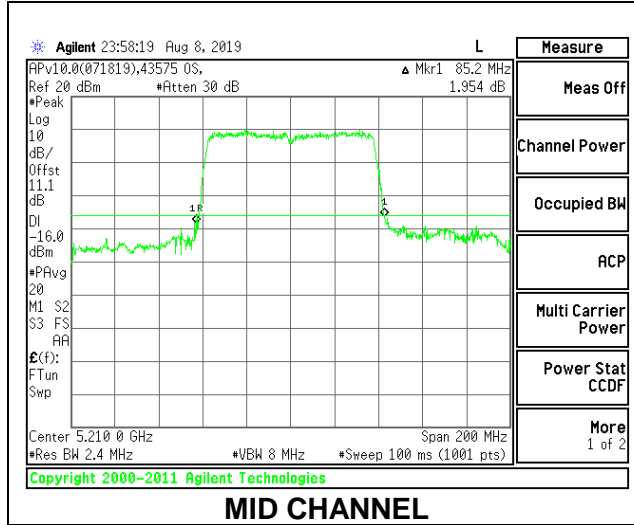

2TX Antenna 1 + Antenna 2 CDD MODE

Channel	Frequency (MHz)	26 dB Bandwidth Antenna 1 (MHz)	26 dB Bandwidth Antenna 2 (MHz)
Mid	5210	84.40	84.20

MID CHANNEL

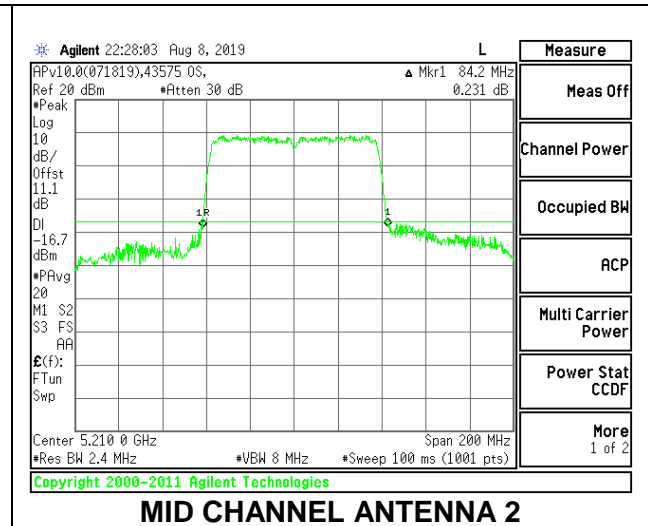
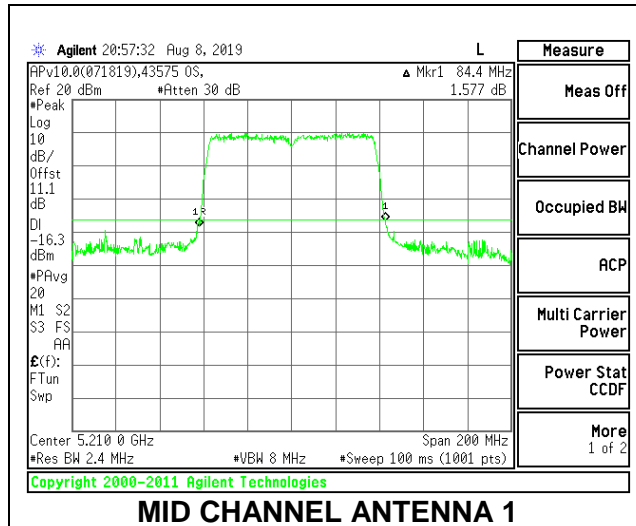

8.2.4. 802.11n HT20 MODE IN THE 5.8 GHz BAND

1TX Antenna 1 MODE

Channel	Frequency (MHz)	26 dB Bandwidth (MHz)
Low	5745	21.00
Mid	5785	21.25
High	5825	21.55



1TX Antenna 2 MODE

Channel	Frequency (MHz)	26 dB Bandwidth (MHz)
Low	5745	21.25
Mid	5785	21.25
High	5825	21.40

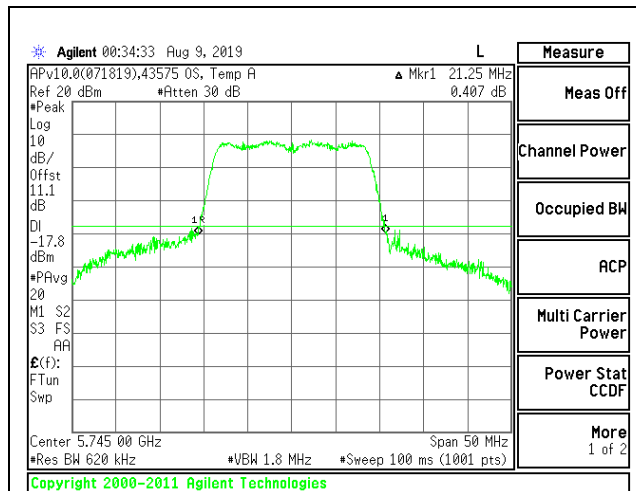

LOW CHANNEL

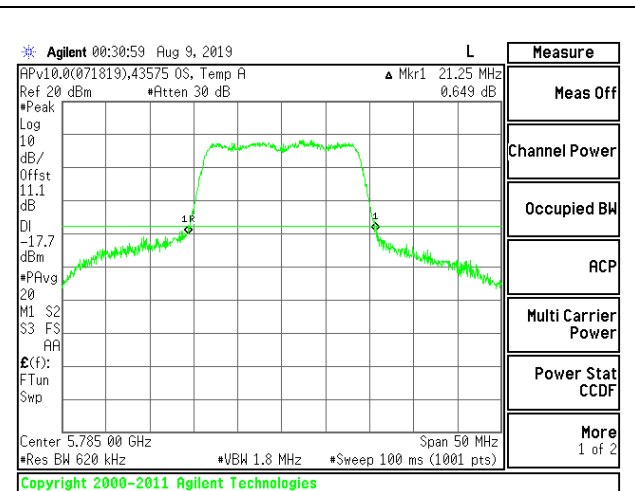

MID CHANNEL

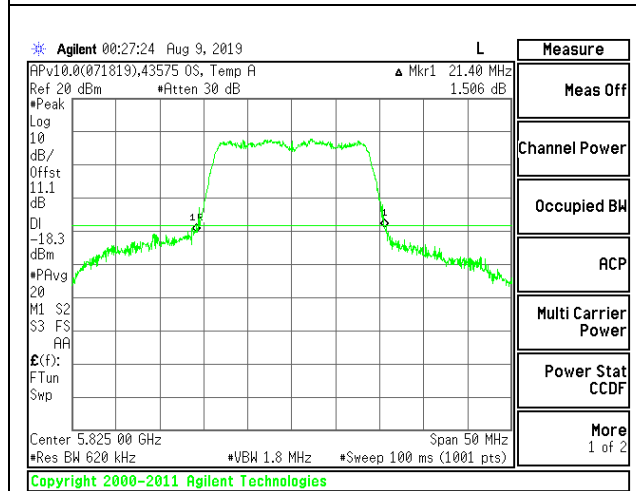

HIGH CHANNEL

2TX Antenna 1 + Antenna 2 CDD MODE

Channel	Frequency (MHz)	26 dB Bandwidth Antenna 1 (MHz)	26 dB Bandwidth Antenna 2 (MHz)
Low	5745	26.70	20.95
Mid	5785	26.45	20.95
High	5825	26.50	20.90

LOW CHANNEL

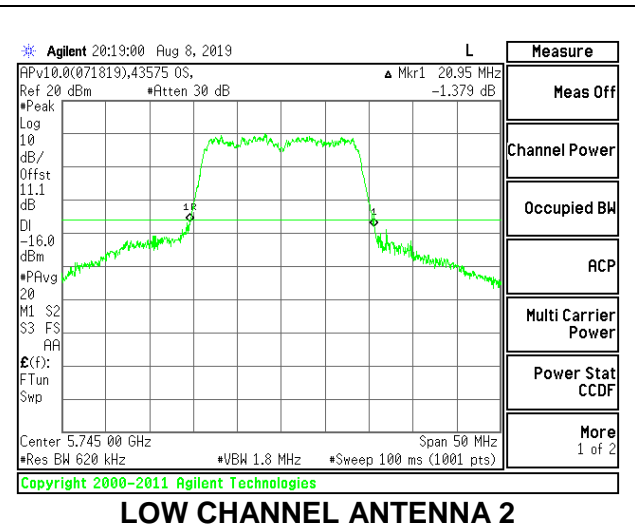
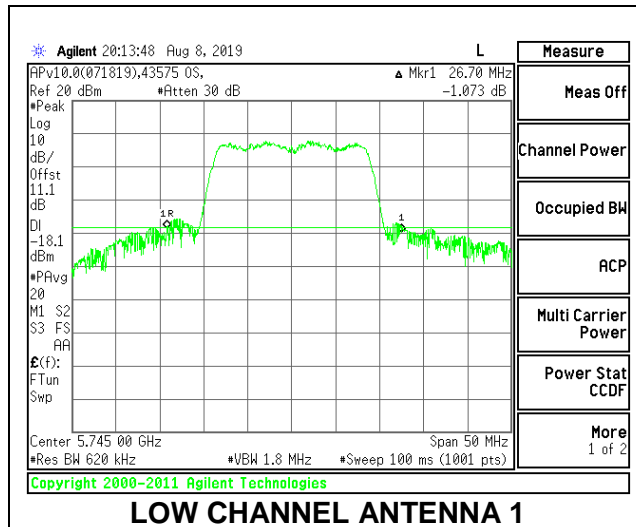

MID CHANNEL

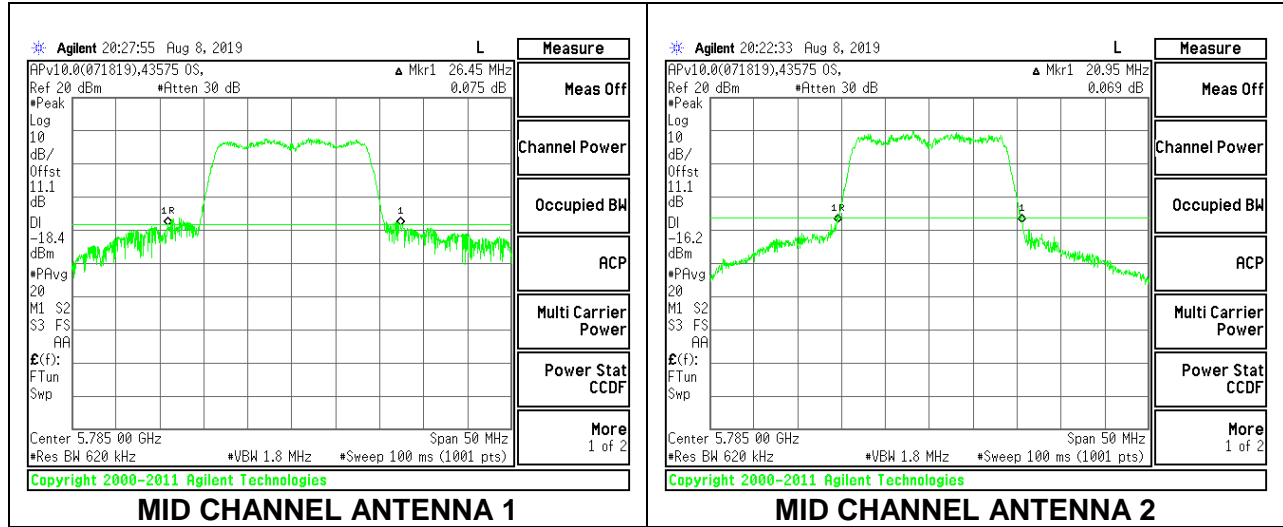

HIGH CHANNEL

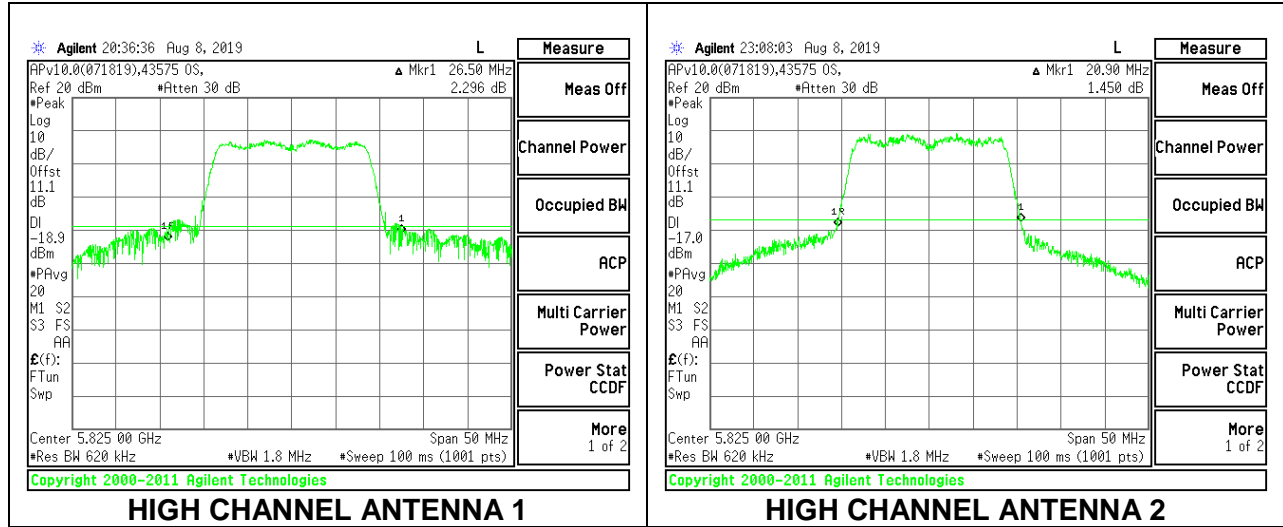

8.2.5. 802.11n HT40 MODE IN THE 5.8 GHz BAND

1TX Antenna 1 MODE

Channel	Frequency (MHz)	26dB Bandwidth (MHz)
Low	5755	43.90
High	5795	45.00

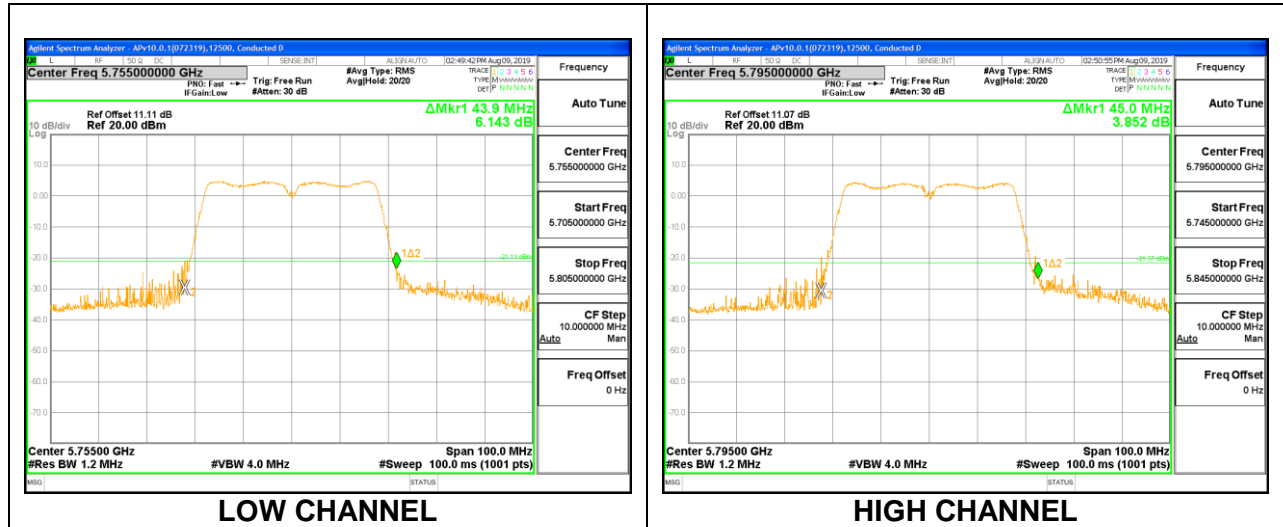

1TX Antenna 2 MODE

Channel	Frequency (MHz)	26dB Bandwidth (MHz)
Low	5755	43.20
High	5795	46.00

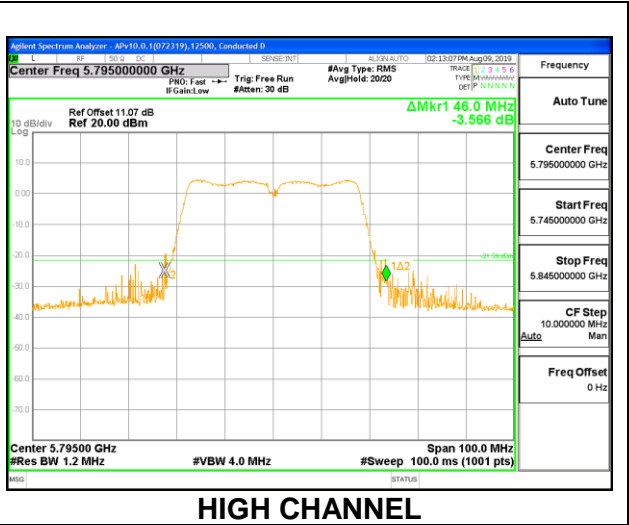
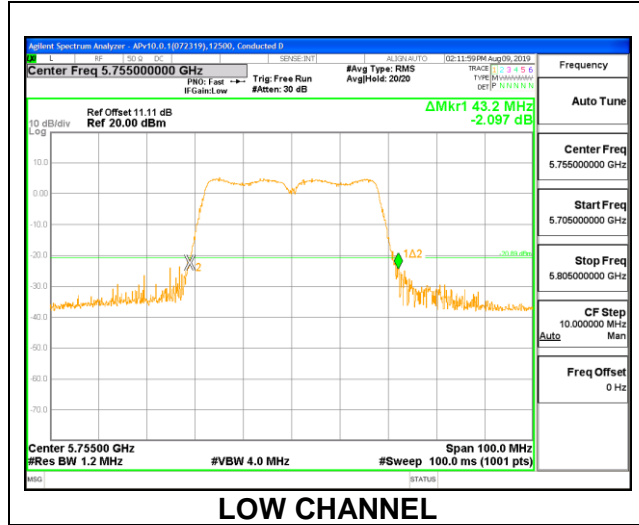

2TX Antenna 1 + Antenna 2 CDD MODE

Channel	Frequency (MHz)	26 dB Bandwidth Antenna 1 (MHz)	26 dB Bandwidth Antenna 2 (MHz)
Low	5755	43.90	42.80
High	5795	43.50	42.70

LOW CHANNEL

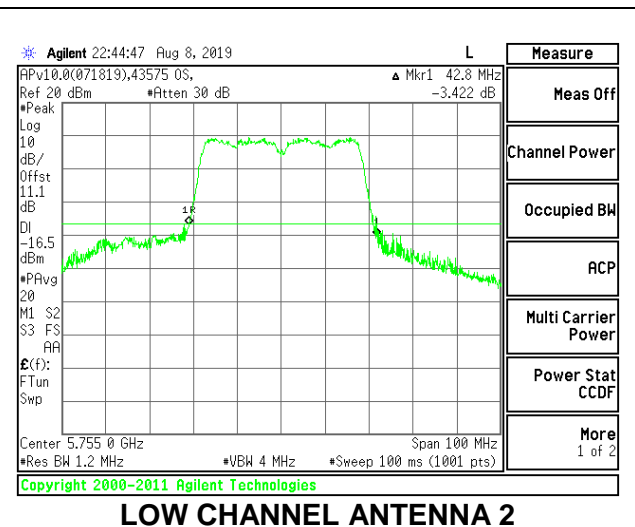
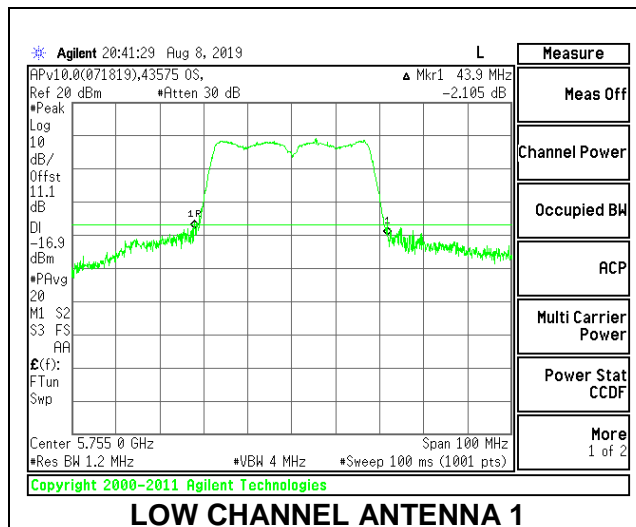

HIGH CHANNEL

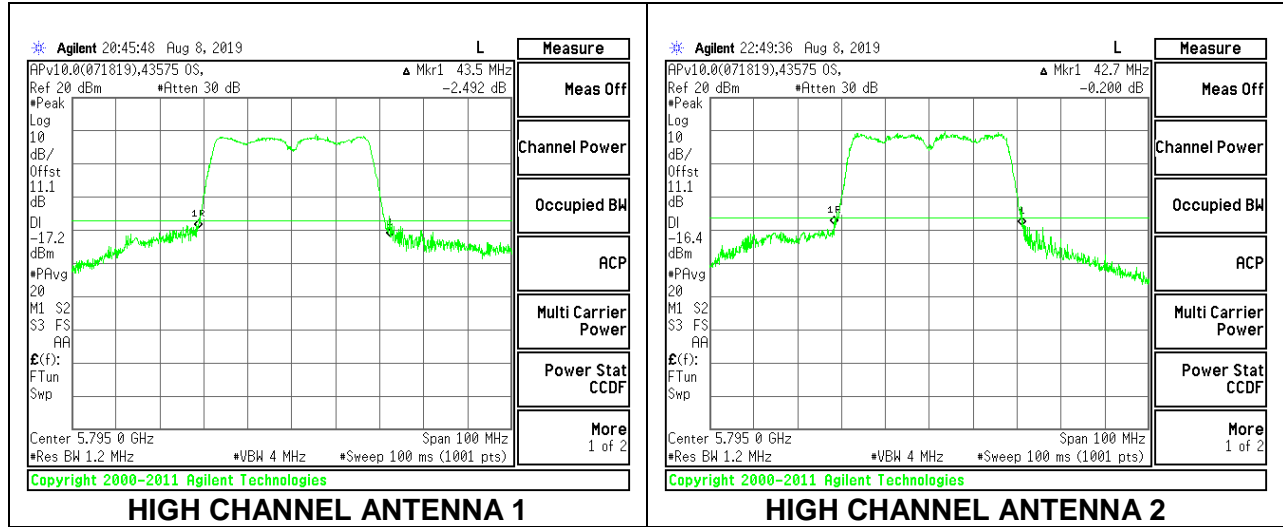

8.2.6. 802.11ac VHT80 MODE IN THE 5.8 GHz BAND

1TX Antenna 1 MODE

Channel	Frequency (MHz)	26 dB Bandwidth (MHz)
Mid	5775	84.40

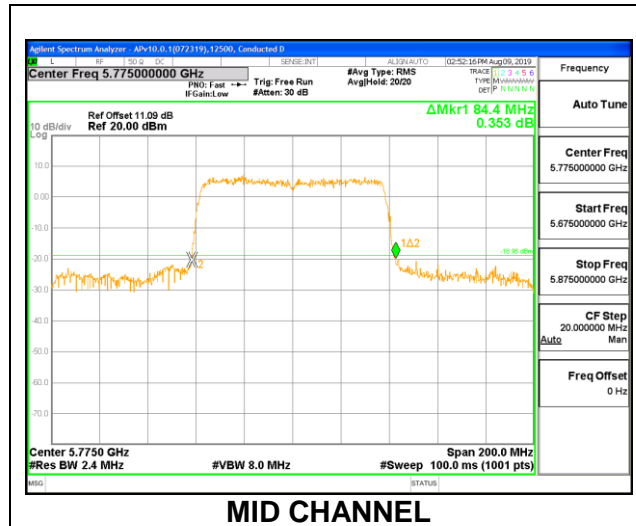

1TX Antenna 2 MODE

Channel	Frequency (MHz)	26 dB Bandwidth (MHz)
Mid	5775	84.80

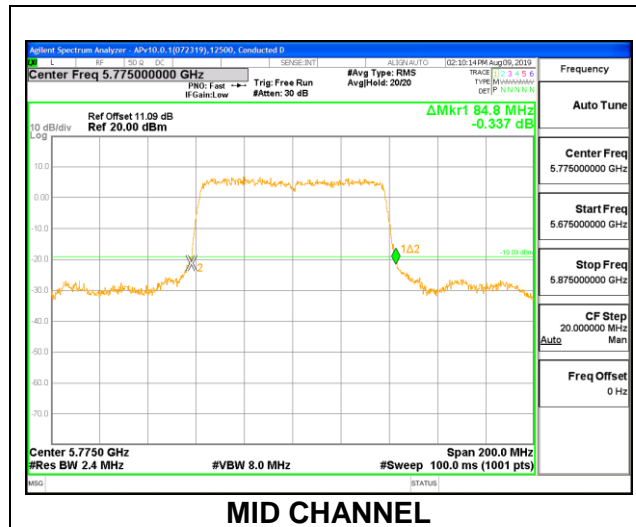

2TX Antenna 1 + Antenna 2 CDD MODE

Channel	Frequency (MHz)	26 dB Bandwidth Antenna 1 (MHz)	26 dB Bandwidth Antenna 2 (MHz)
Mid	5775	84.40	84.40

MID CHANNEL

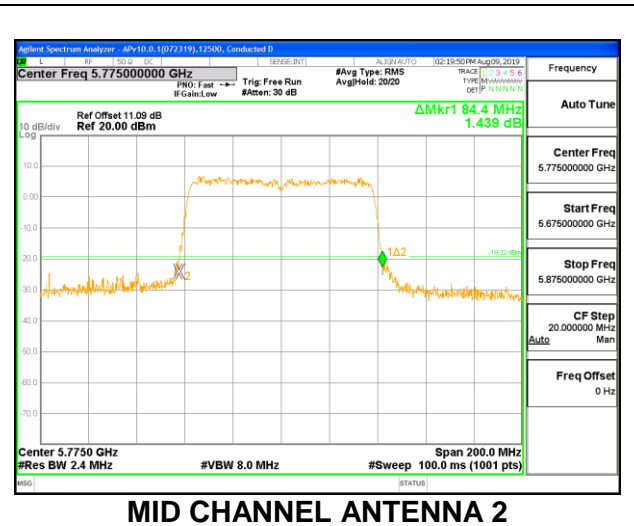
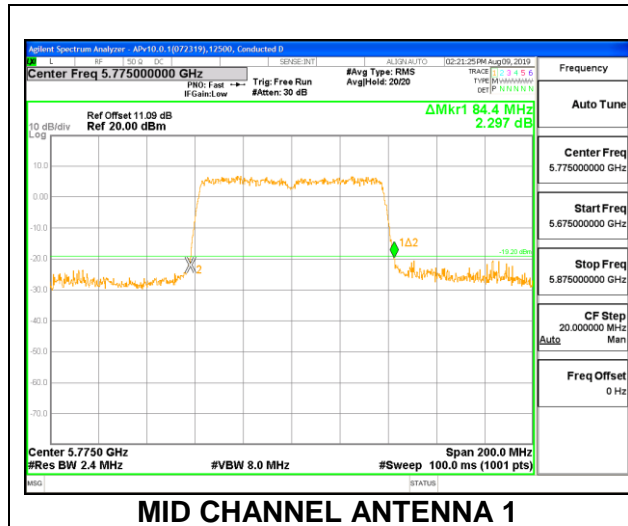

8.3. 99% BANDWIDTH

LIMITS

None; for reporting purposes only.

RESULTS

8.3.1. 802.11n HT20 MODE IN THE 5.2 GHz BAND

1TX Antenna 1 MODE

Channel	Frequency (MHz)	99% Bandwidth (MHz)
Low	5180	17.6730
Mid	5200	17.6850
High	5240	17.6890

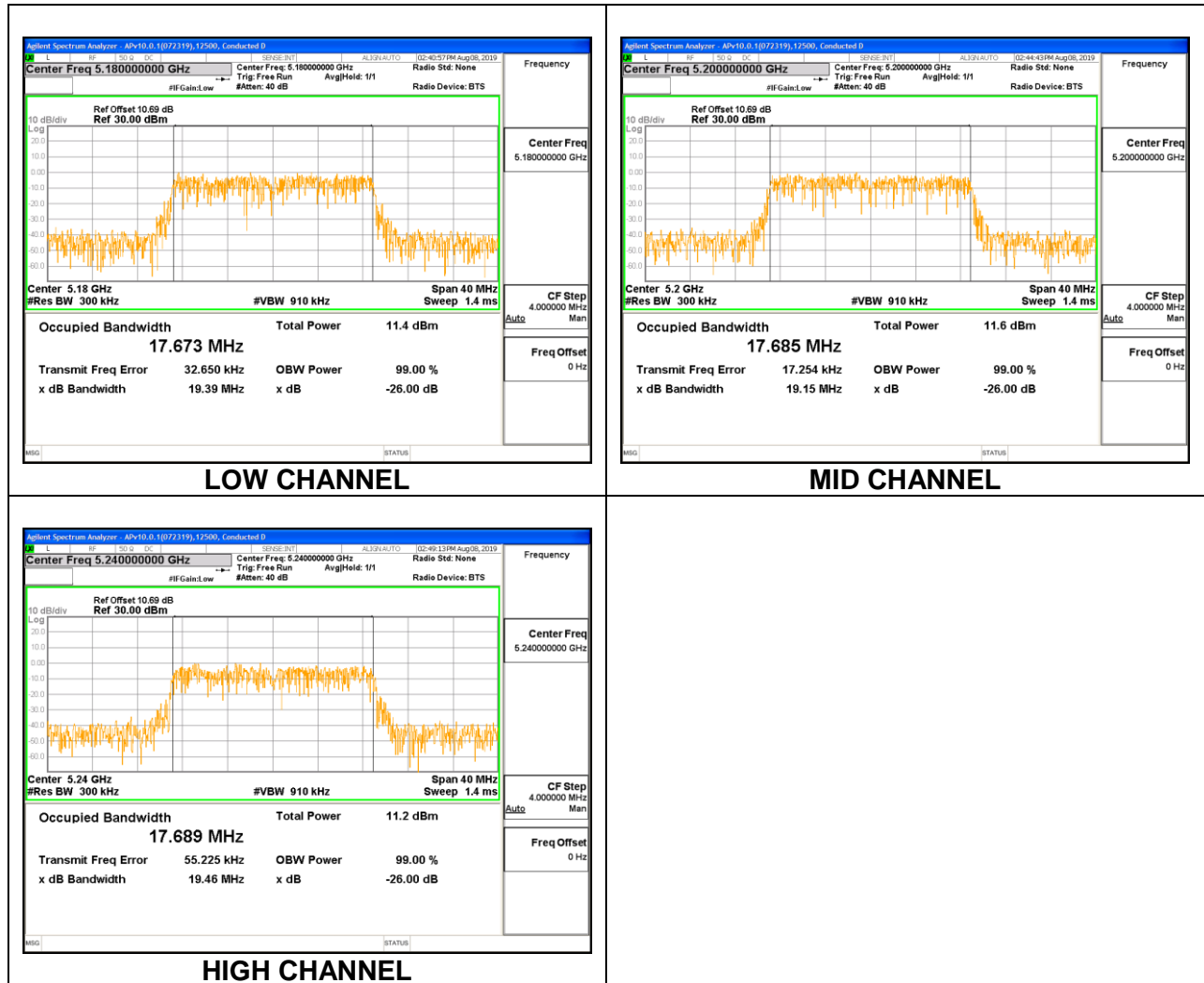

1TX Antenna 2 MODE

Channel	Frequency (MHz)	99% Bandwidth (MHz)
Low	5180	17.6640
Mid	5200	17.7130
High	5240	17.7520

<p>* Agilent 23:32:31 Aug 8, 2019</p> <p>Ch Freq 5.18 GHz Trig Free</p> <p>Occupied Bandwidth Averages: 1</p> <p>APV10.0(071819),43575 OS, Ref 30 dBm *Atten 40 dB</p> <p>Center 5.180 00 GHz Span 40 MHz *Res BW 300 kHz *VBW 910 kHz Sweep 1.399 ms (1000 pts)</p> <p>Occupied Bandwidth 17.6636 MHz Occ BW % Pwr 99.00 % x dB -26.00 dB</p> <p>Transmit Freq Error -14.550 kHz x dB Bandwidth 19.235 MHz*</p> <p>Copyright 2000-2011 Agilent Technologies</p> <p>LOW CHANNEL</p>	<p>* Agilent 23:40:33 Aug 8, 2019</p> <p>Ch Freq 5.2 GHz Trig Free</p> <p>Occupied Bandwidth Averages: 1</p> <p>APV10.0(071819),43575 OS, Ref 30 dBm *Atten 40 dB</p> <p>Center 5.200 00 GHz Span 40 MHz *Res BW 300 kHz *VBW 910 kHz Sweep 1.399 ms (1000 pts)</p> <p>Occupied Bandwidth 17.7130 MHz Occ BW % Pwr 99.00 % x dB -26.00 dB</p> <p>Transmit Freq Error 40.791 kHz x dB Bandwidth 19.701 MHz*</p> <p>Copyright 2000-2011 Agilent Technologies</p> <p>MID CHANNEL</p>
<p>* Agilent 23:44:13 Aug 8, 2019</p> <p>Ch Freq 5.24 GHz Trig Free</p> <p>Occupied Bandwidth Averages: 1</p> <p>APV10.0(071819),43575 OS, Ref 30 dBm *Atten 40 dB</p> <p>Center 5.240 00 GHz Span 40 MHz *Res BW 300 kHz *VBW 910 kHz Sweep 1.399 ms (1000 pts)</p> <p>Occupied Bandwidth 17.7519 MHz Occ BW % Pwr 99.00 % x dB -26.00 dB</p> <p>Transmit Freq Error 72.763 kHz x dB Bandwidth 19.712 MHz*</p> <p>Copyright 2000-2011 Agilent Technologies</p> <p>HIGH CHANNEL</p>	

2TX Antenna 1 + Antenna 2 CDD MODE

Channel	Frequency (MHz)	99% Bandwidth Antenna 1 (MHz)	99% Bandwidth Antenna 2 (MHz)
Low	5180	17.5840	17.6230
Mid	5200	17.6600	17.6430
High	5240	17.6070	17.6200

LOW CHANNEL

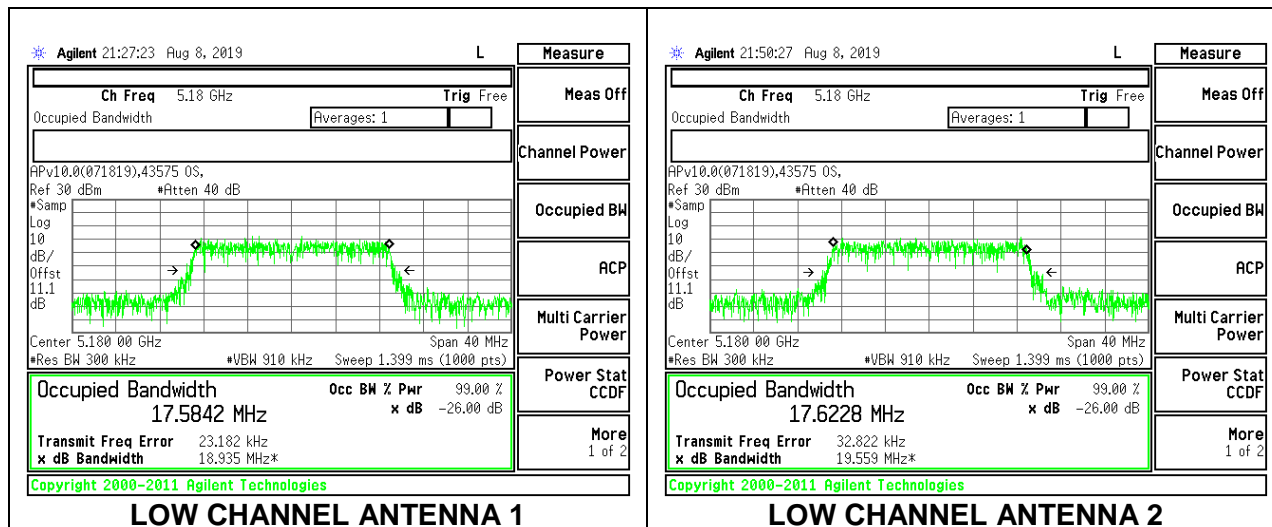

MID CHANNEL

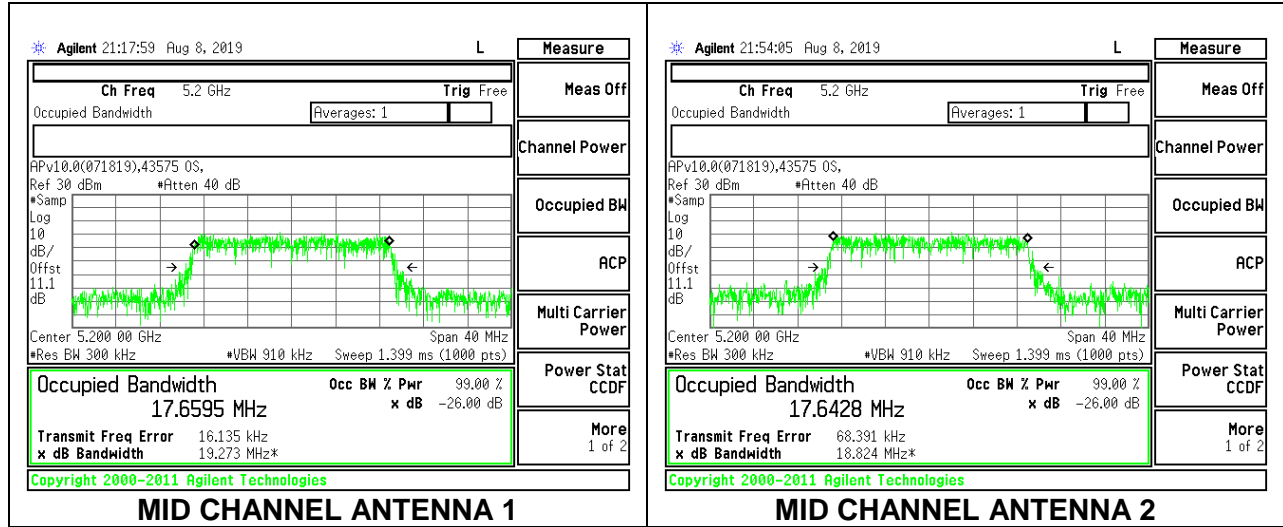

HIGH CHANNEL

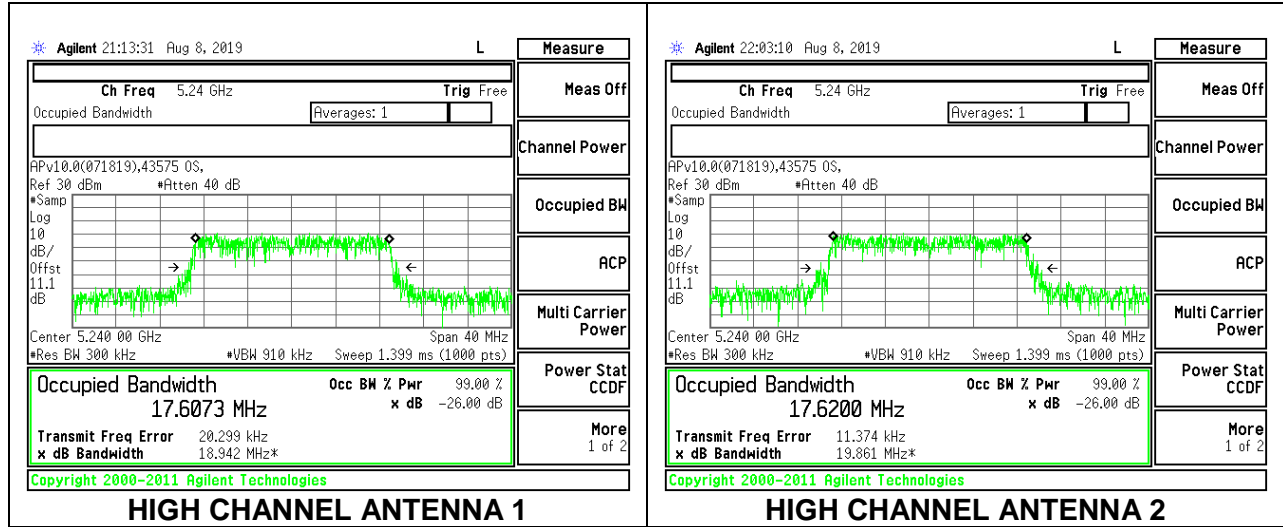

8.3.2. 802.11n HT40 MODE IN THE 5.2 GHz BAND

1TX Antenna 1 MODE

Channel	Frequency (MHz)	99% Bandwidth (MHz)
Low	5190	36.2800
High	5230	36.1230

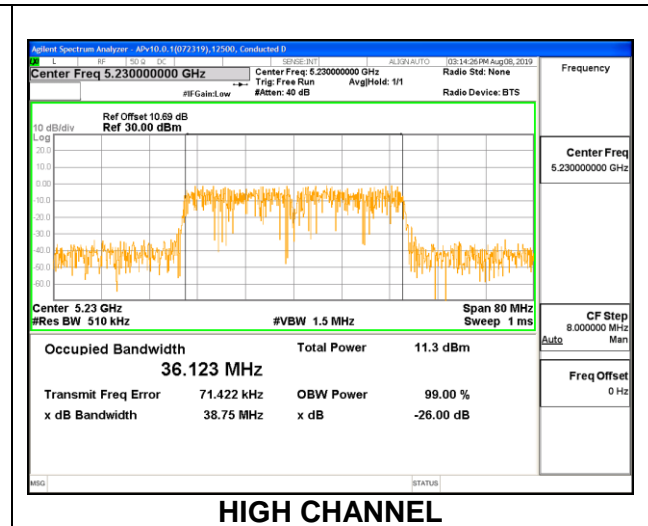
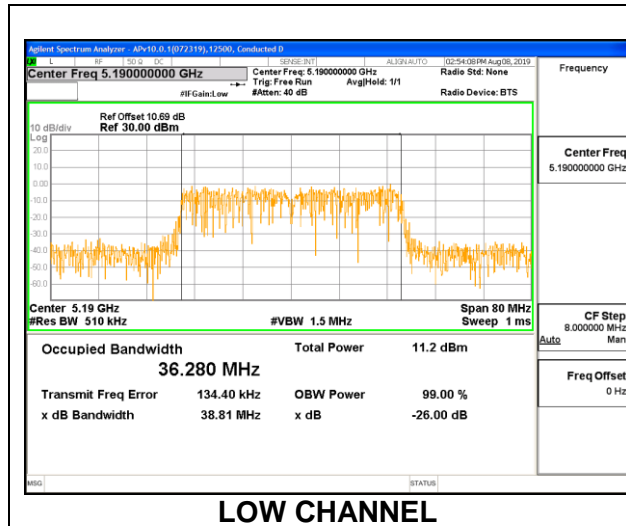

1TX Antenna 2 MODE

Channel	Frequency (MHz)	99% Bandwidth (MHz)
Low	5190	36.2620
High	5230	36.2660

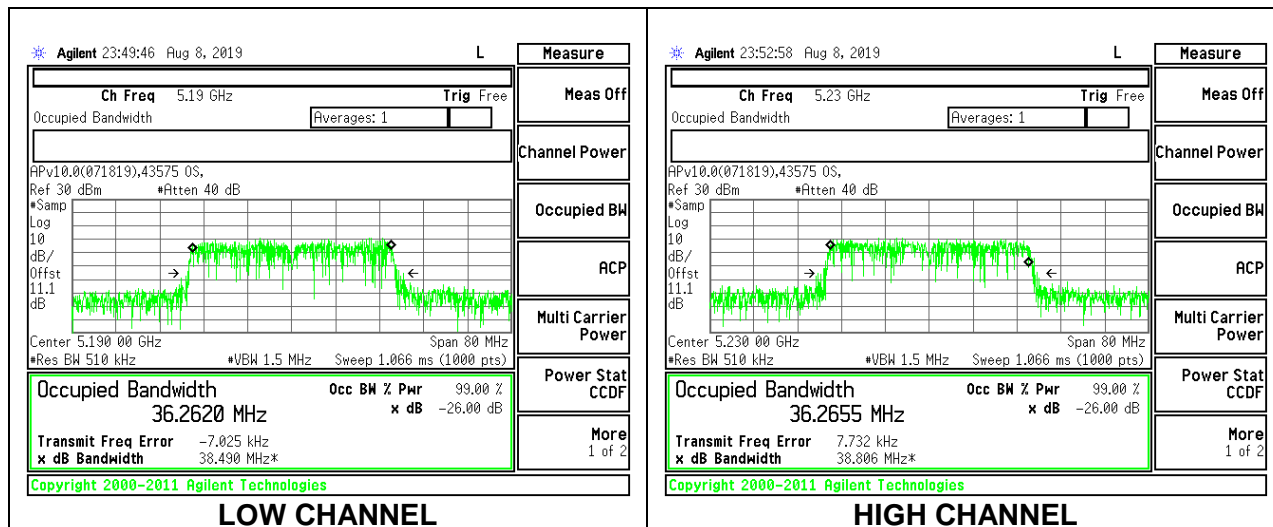

2TX Antenna 1 + Antenna 2 CDD MODE

Channel	Frequency (MHz)	99% Bandwidth Antenna 1 (MHz)	99% Bandwidth Antenna 2 (MHz)
Low	5190	36.1930	35.9910
High	5230	36.2720	36.1320

LOW CHANNEL

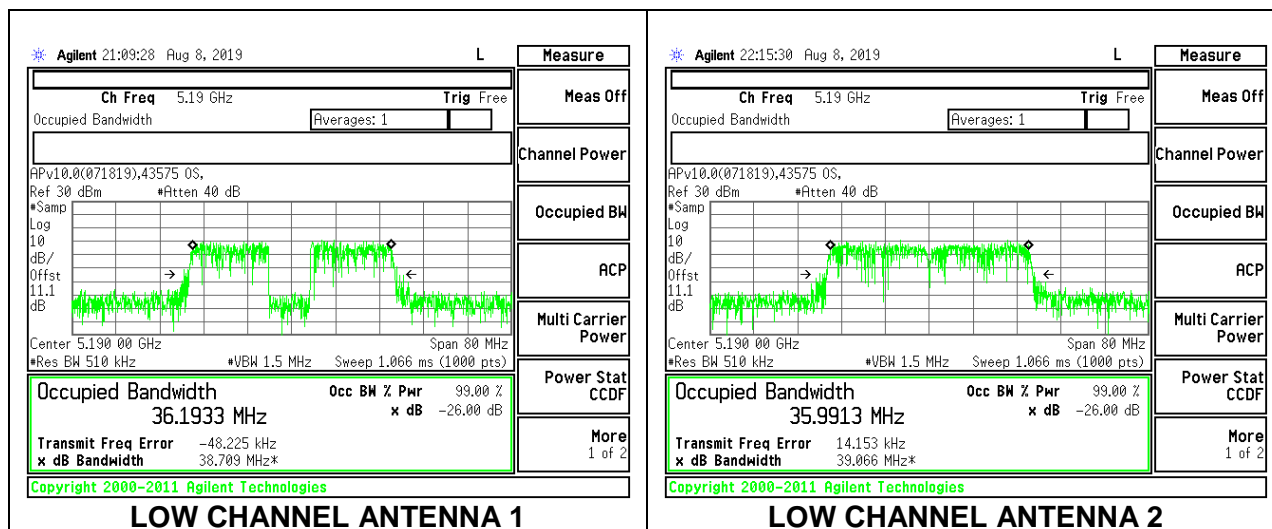

HIGH CHANNEL

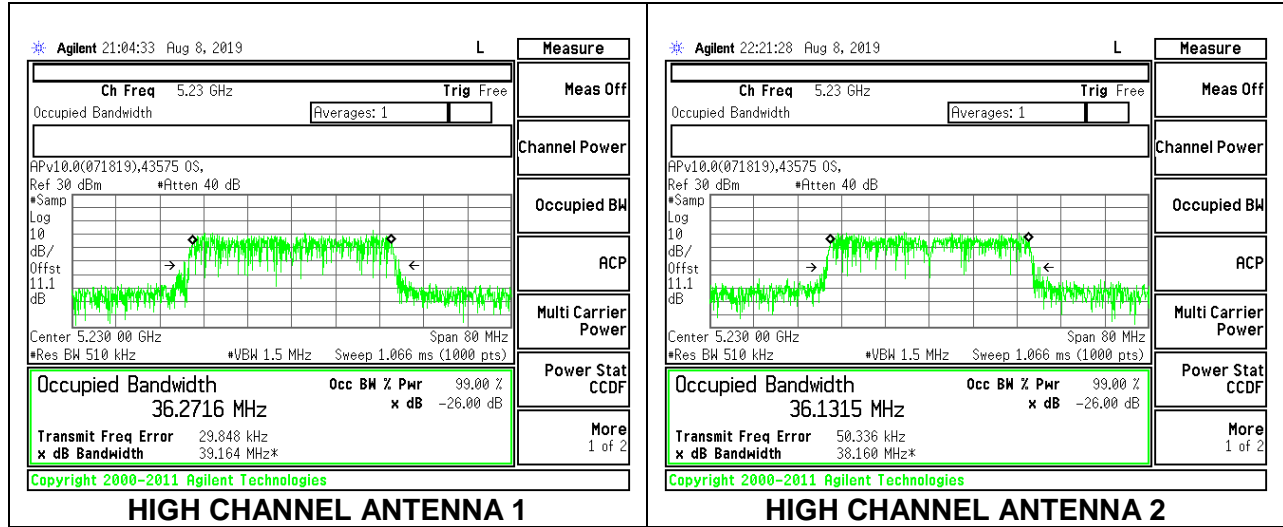

8.3.3. 802.11ac VHT80 MODE IN THE 5.2 GHz BAND

1TX Antenna 1 MODE

Channel	Frequency (MHz)	99% Bandwidth (MHz)
Mid	5210	76.0080

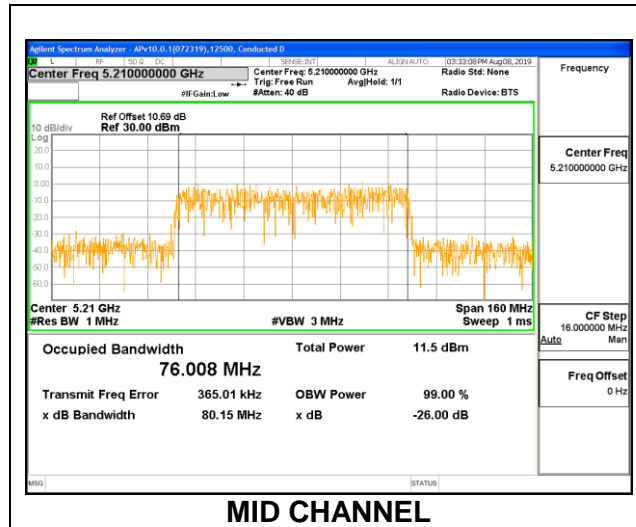

1TX Antenna 2 MODE

Channel	Frequency	99% Bandwidth
	(MHz)	(MHz)
Mid	5210	75.9800

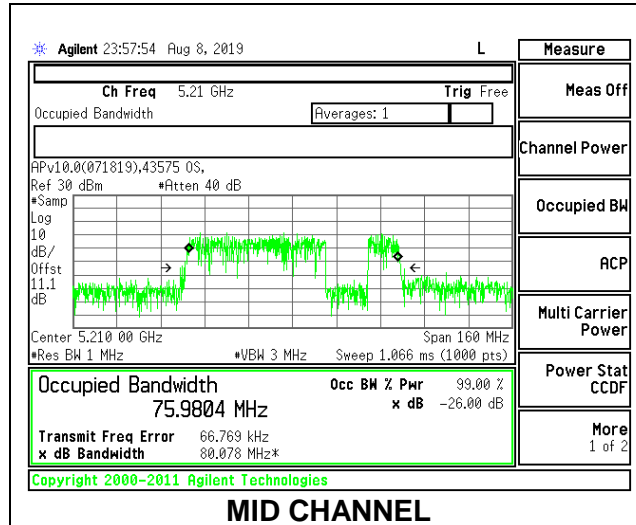

2TX Antenna 1 + Antenna 2 CDD MODE

Channel	Frequency (MHz)	99% Bandwidth Antenna 1 (MHz)	99% Bandwidth Antenna 2 (MHz)
Mid	5210	75.9130	76.0800

MID CHANNEL

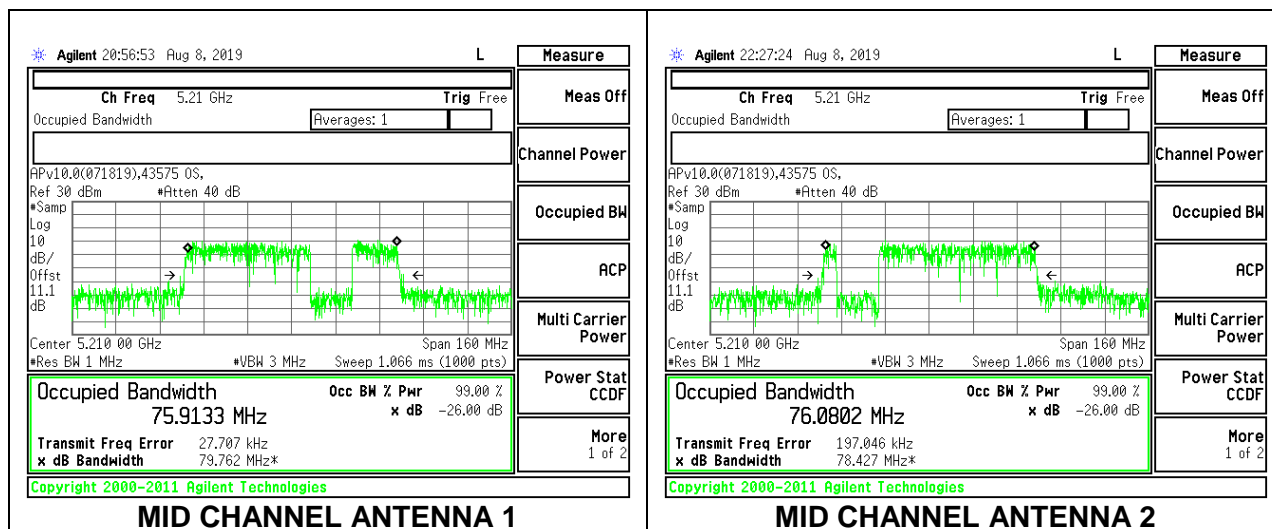

8.3.4. 802.11n HT20 MODE IN THE 5.8 GHz BAND

1TX Antenna 1 MODE

Channel	Frequency (MHz)	99% Bandwidth (MHz)
Low	5745	17.6520
Mid	5785	17.7880
High	5825	17.6690

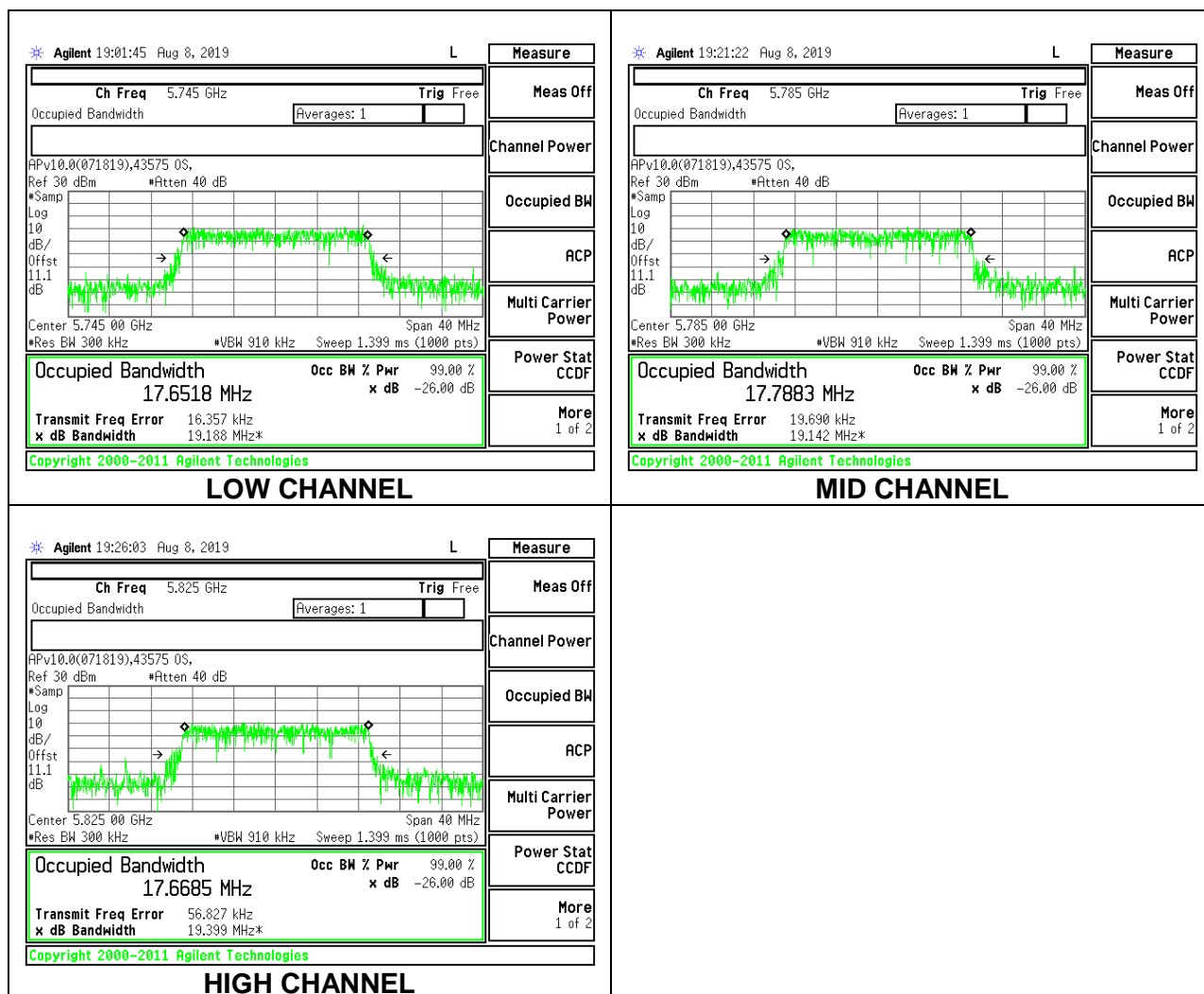

1TX Antenna 2 MODE

Channel	Frequency (MHz)	99% Bandwidth (MHz)
Low	5745	17.7350
Mid	5785	17.6370
High	5825	17.7360

<p>* Agilent 00:40:39 Aug 9, 2019</p> <p>Ch Freq 5.745 GHz Trig Free</p> <p>Occupied Bandwidth Averages: 1</p> <p>APV10.0(071819),43575 OS, Temp A Ref 30 dBm *Atten 40 dB</p> <p>Center 5.745 00 GHz Span 40 MHz *Res BW 300 kHz *VBW 910 kHz Sweep 1.399 ms (1000 pts)</p> <p>Occupied Bandwidth 17.7355 MHz Occ BW % Pwr 99.00 % x dB -26.00 dB</p> <p>Transmit Freq Error 28.305 kHz x dB Bandwidth 19.508 MHz*</p> <p>Copyright 2000-2011 Agilent Technologies</p> <p style="text-align: center;">LOW CHANNEL</p>	<p>* Agilent 00:30:32 Aug 9, 2019</p> <p>Ch Freq 5.785 GHz Trig Free</p> <p>Occupied Bandwidth Averages: 1</p> <p>APV10.0(071819),43575 OS, Temp A Ref 30 dBm *Atten 40 dB</p> <p>Center 5.785 00 GHz Span 40 MHz *Res BW 300 kHz *VBW 910 kHz Sweep 1.399 ms (1000 pts)</p> <p>Occupied Bandwidth 17.6367 MHz Occ BW % Pwr 99.00 % x dB -26.00 dB</p> <p>Transmit Freq Error 1.185 kHz x dB Bandwidth 19.933 MHz*</p> <p>Copyright 2000-2011 Agilent Technologies</p> <p style="text-align: center;">MID CHANNEL</p>
<p>* Agilent 00:26:59 Aug 9, 2019</p> <p>Ch Freq 5.825 GHz Trig Free</p> <p>Occupied Bandwidth Averages: 1</p> <p>APV10.0(071819),43575 OS, Temp A Ref 30 dBm *Atten 40 dB</p> <p>Center 5.825 00 GHz Span 40 MHz *Res BW 300 kHz *VBW 910 kHz Sweep 1.399 ms (1000 pts)</p> <p>Occupied Bandwidth 17.7362 MHz Occ BW % Pwr 99.00 % x dB -26.00 dB</p> <p>Transmit Freq Error 3.371 kHz x dB Bandwidth 19.710 MHz*</p> <p>Copyright 2000-2011 Agilent Technologies</p> <p style="text-align: center;">HIGH CHANNEL</p>	<p>Measure</p> <p>Meas Off</p> <p>Channel Power</p> <p>Occupied BW</p> <p>ACP</p> <p>Multi Carrier Power</p> <p>Power Stat CCDF</p> <p>More 1 of 2</p>

2TX Antenna 1 + Antenna 2 CDD MODE

Channel	Frequency (MHz)	99% Bandwidth Antenna 1 (MHz)	99% Bandwidth Antenna 2 (MHz)
Low	5745	17.6280	17.7210
Mid	5785	17.6690	17.6320
High	5825	17.7290	17.7230

LOW CHANNEL

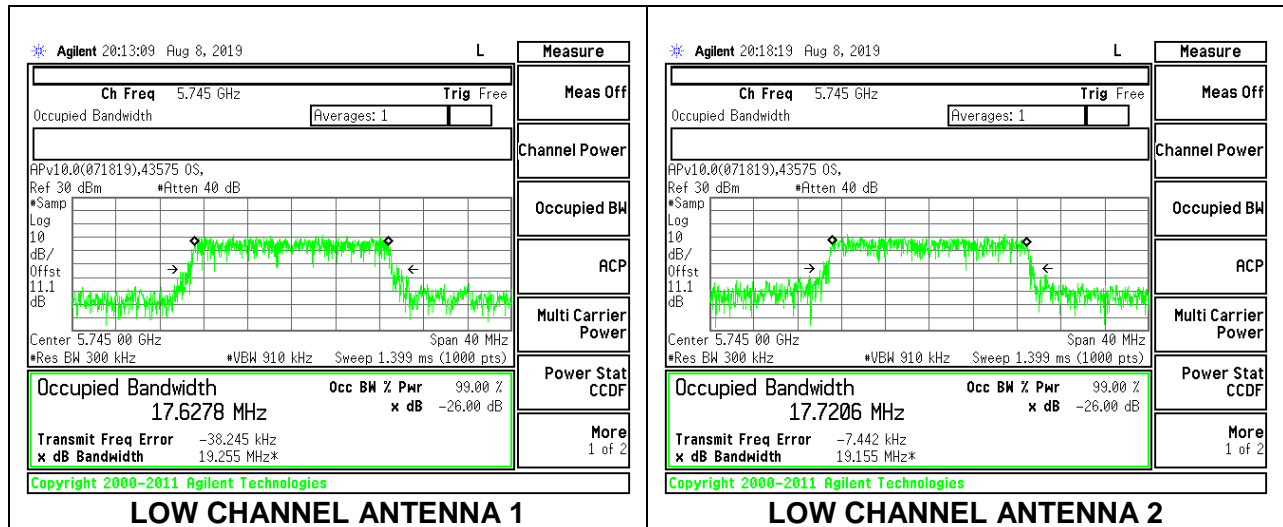

MID CHANNEL

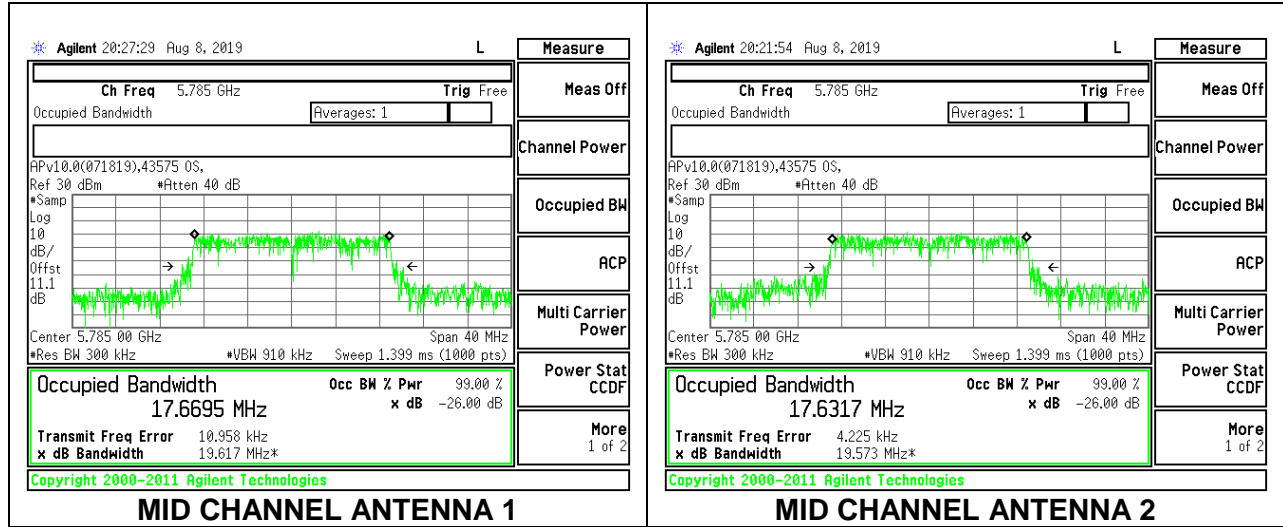

HIGH CHANNEL

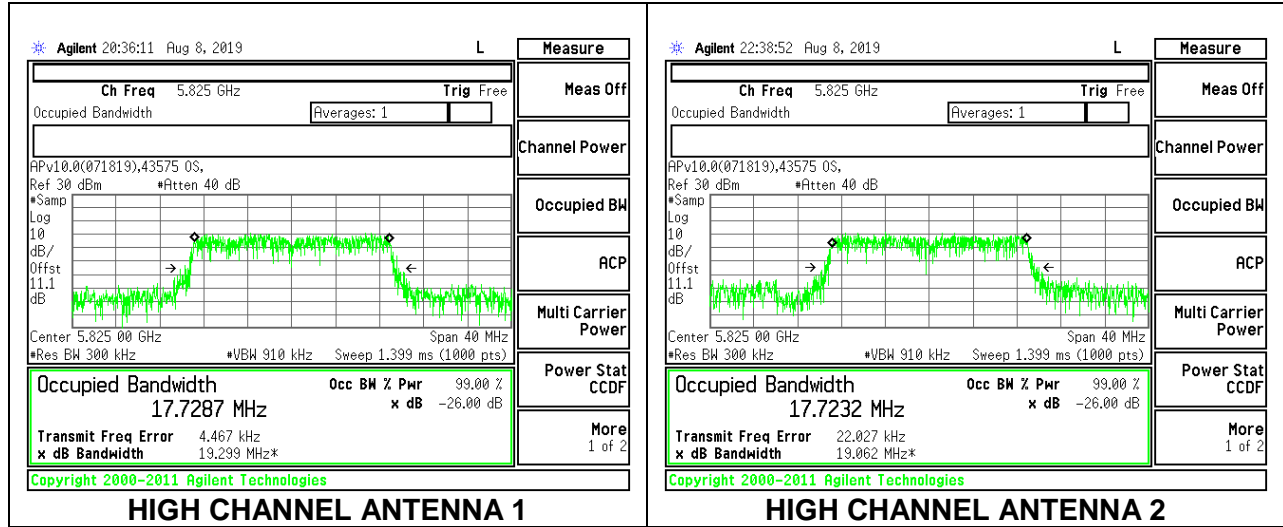

8.3.5. 802.11n HT40 MODE IN THE 5.8 GHz BAND

1TX Antenna 1 MODE

Channel	Frequency (MHz)	99% Bandwidth (MHz)
Low	5755	36.0080
High	5795	36.2350

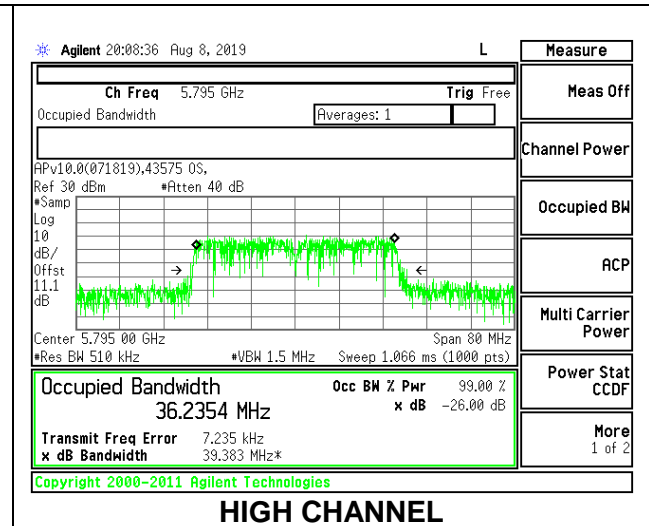
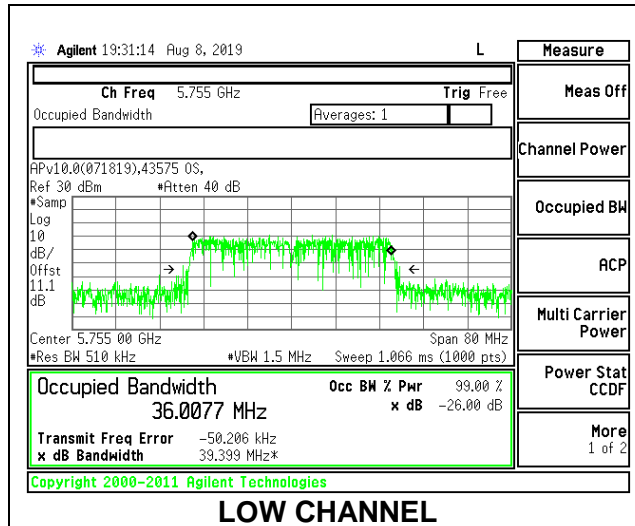

1TX Antenna 2 MODE

Channel	Frequency (MHz)	99% Bandwidth (MHz)
Low	5755	36.3190
High	5795	36.2290

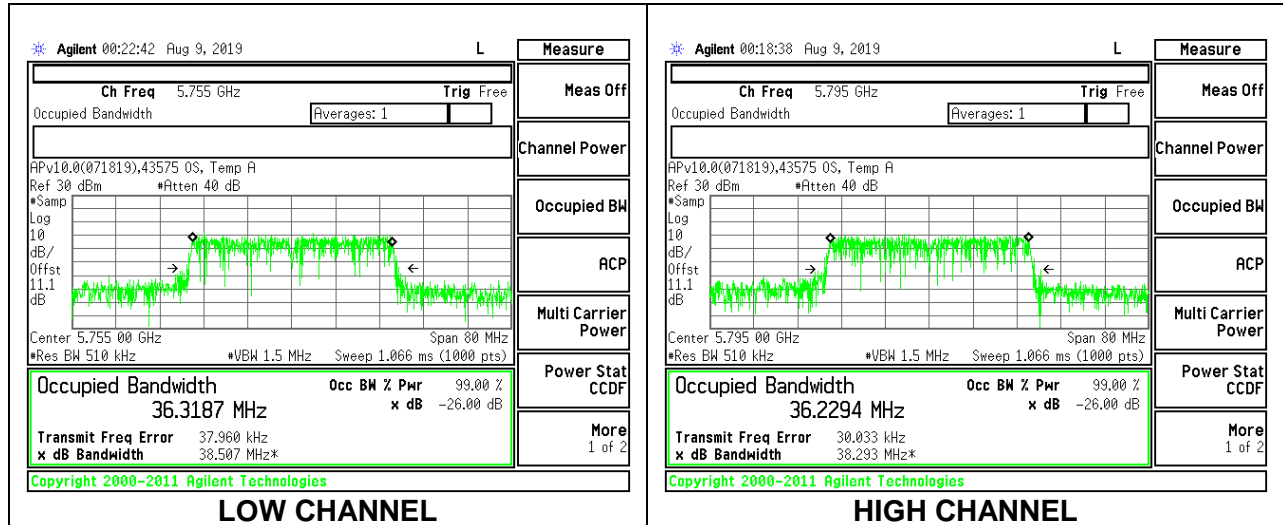

2TX Antenna 1 + Antenna 2 CDD MODE

Channel	Frequency (MHz)	99% Bandwidth Antenna 1 (MHz)	99% Bandwidth Antenna 2 (MHz)
Low	5755	35.9530	36.1490
High	5795	36.0370	36.1560

LOW CHANNEL

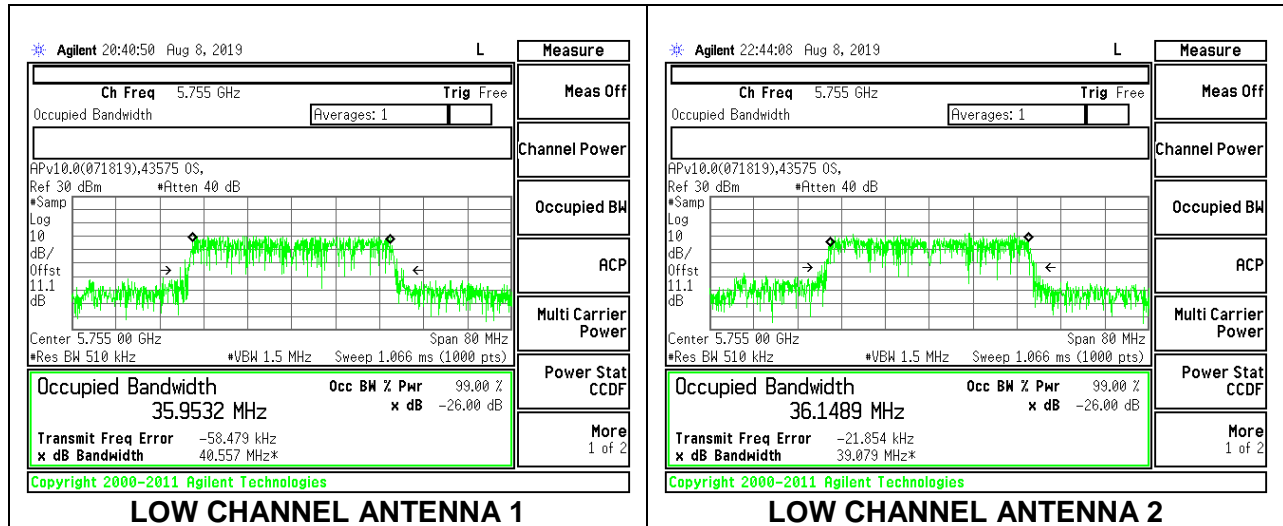

HIGH CHANNEL

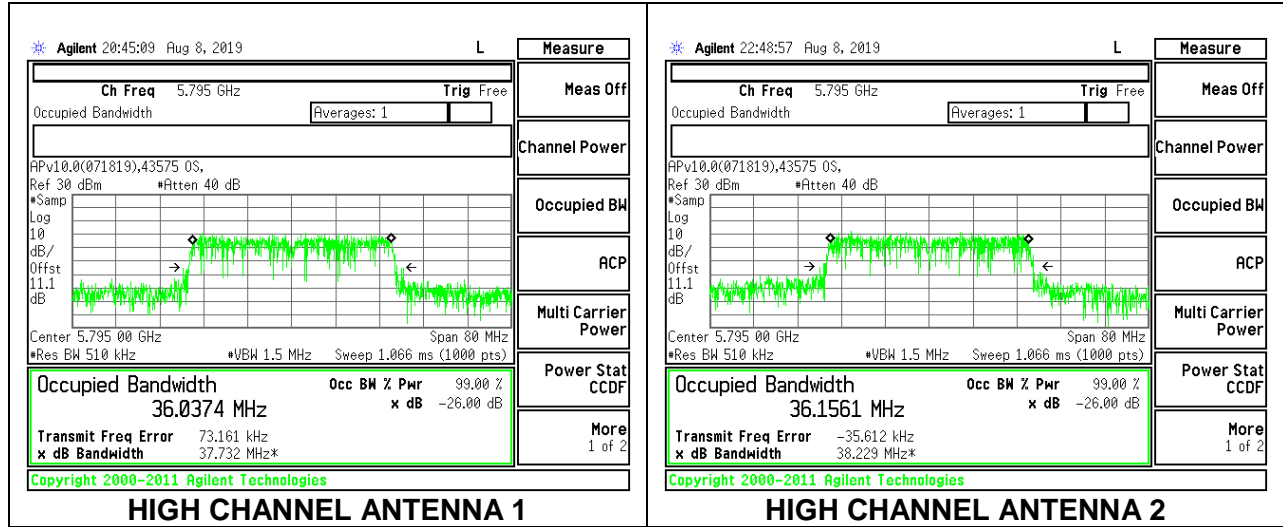

8.3.6. 802.11ac VHT80 MODE IN THE 5.8 GHz BAND

1TX Antenna 1 MODE

Channel	Frequency (MHz)	99% Bandwidth (MHz)
Mid	5775	76.0400

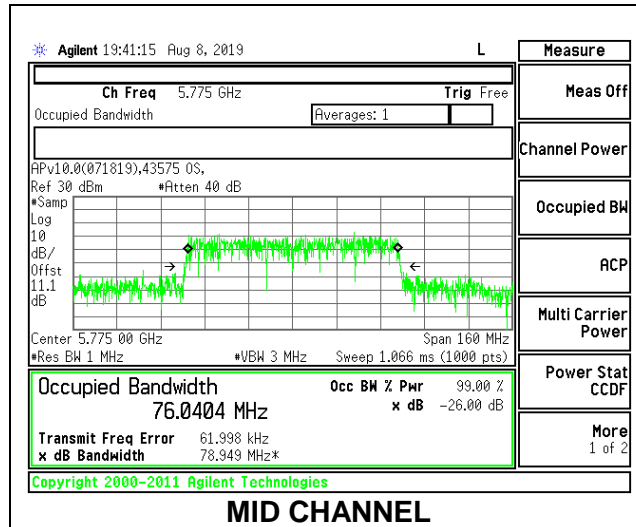

1TX Antenna 2 MODE

Channel	Frequency	99% Bandwidth
	(MHz)	(MHz)
Mid	5775	75.4540

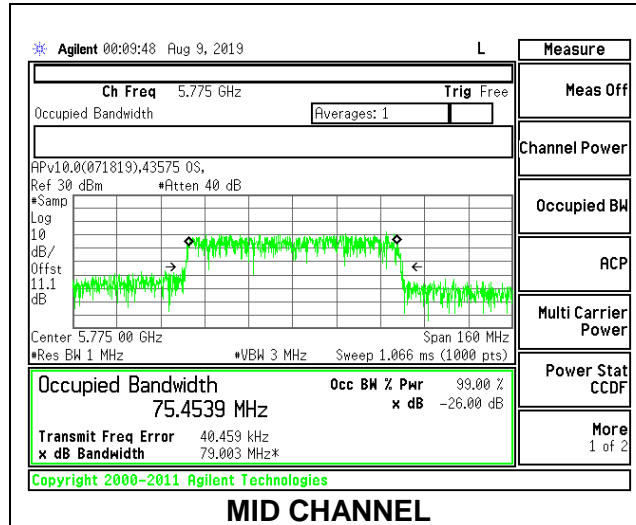

2TX Antenna 1 + Antenna 2 CDD MODE

Channel	Frequency (MHz)	99% Bandwidth Antenna 1 (MHz)	99% Bandwidth Antenna 2 (MHz)
Mid	5775	76.0620	76.0510

MID CHANNEL

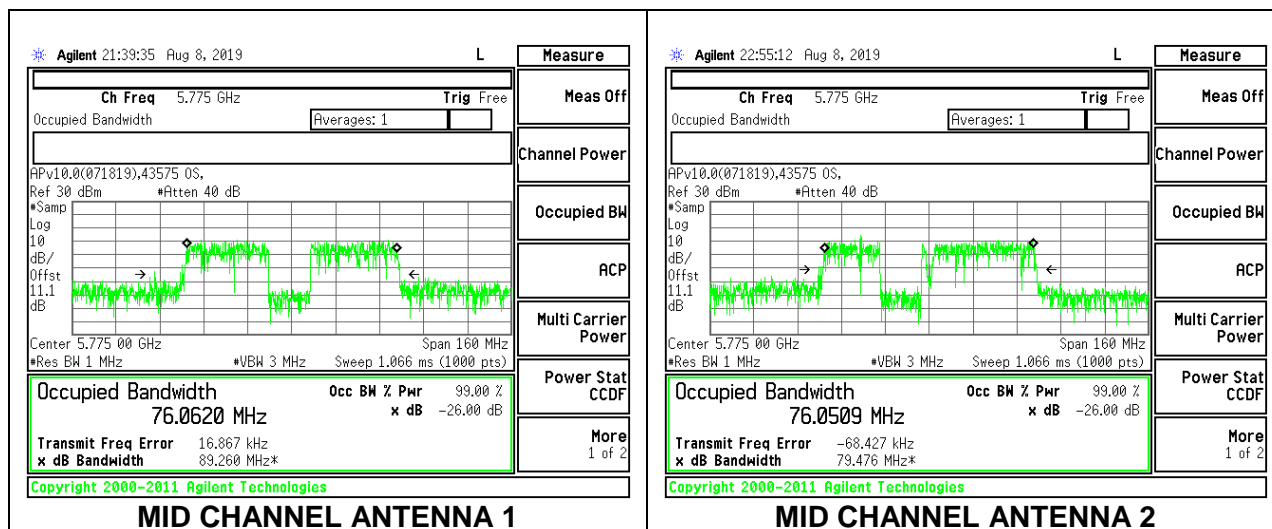

8.4. 6 dB BANDWIDTH

LIMITS

FCC §15.407 (e)

The minimum 6 dB bandwidth shall be at least 500 kHz.

RESULTS

8.4.1. 802.11n HT20 MODE IN THE 5.8 GHz BAND

1TX Antenna 1 MODE

Channel	Frequency (MHz)	6 dB Bandwidth (MHz)	Minimum Limit (MHz)
Low	5745	17.7760	0.5
Mid	5785	17.7760	0.5
High	5825	17.6050	0.5

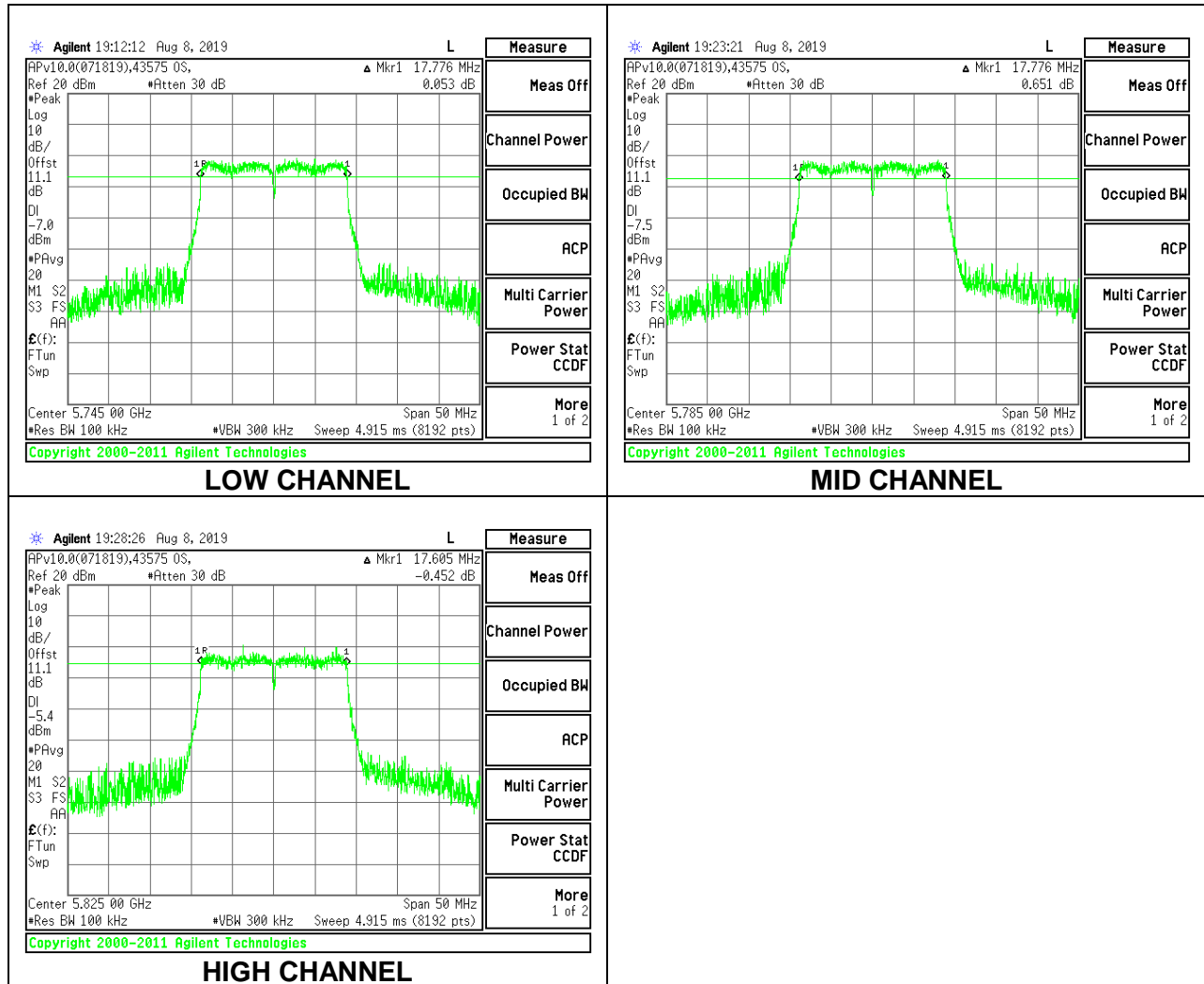

1TX Antenna 2 MODE

Channel	Frequency (MHz)	6 dB Bandwidth (MHz)	Minimum Limit (MHz)
Low	5745	17.6290	0.5
Mid	5785	17.5920	0.5
High	5825	17.6780	0.5

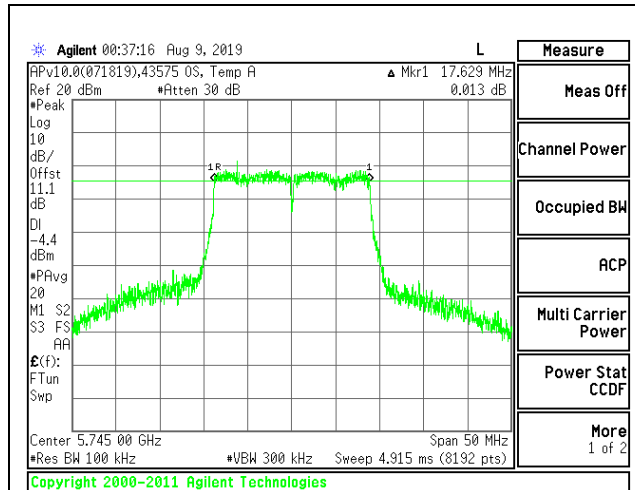

LOW CHANNEL

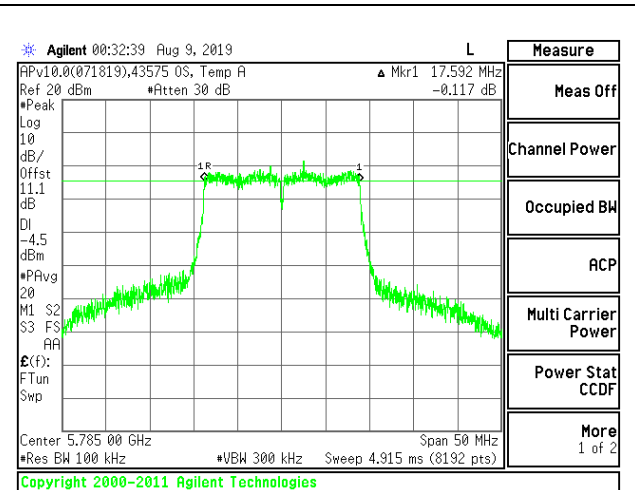

MID CHANNEL

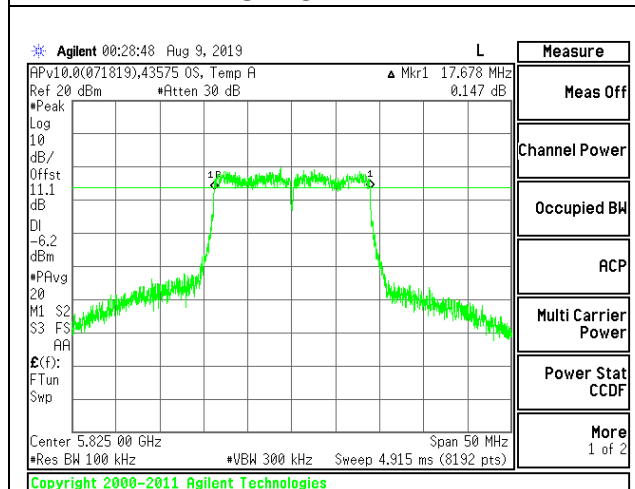

HIGH CHANNEL

2TX Antenna 1 + Antenna 2 CDD MODE

Channel	Frequency (MHz)	6 dB BW	6 dB BW	Minimum Limit (MHz)
		Antenna 1 (MHz)	Antenna 2 (MHz)	
Low	5745	17.6350	17.6960	0.5
Mid	5785	17.7080	17.7150	0.5
High	5825	17.3300	17.6110	0.5

LOW CHANNEL

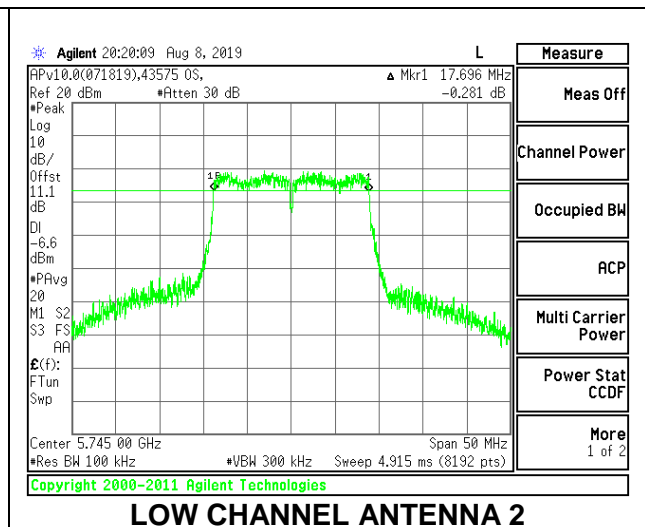
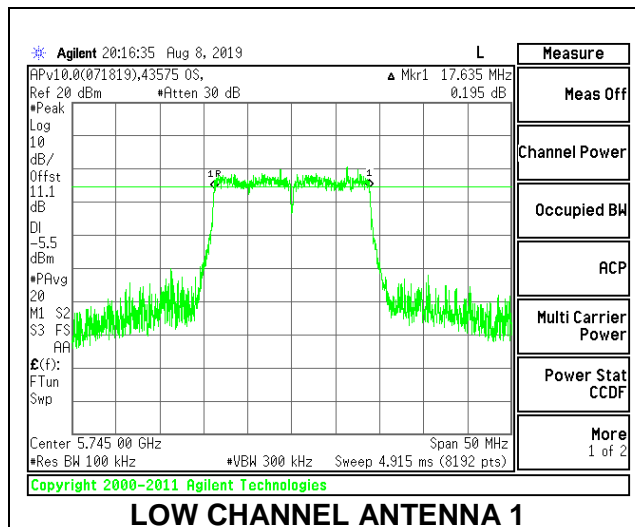

MID CHANNEL

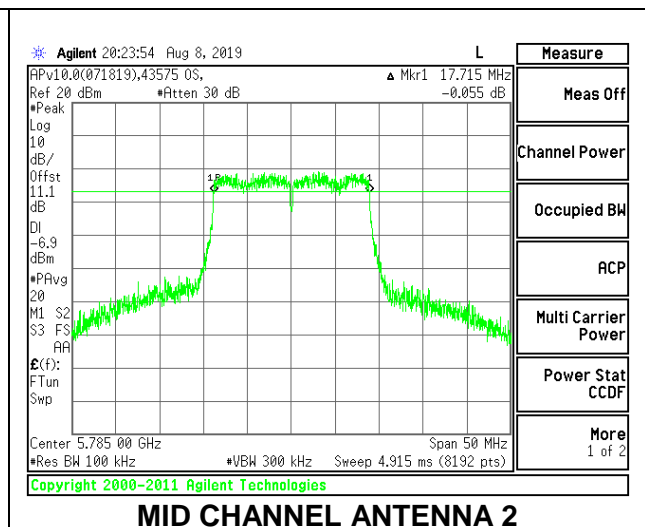
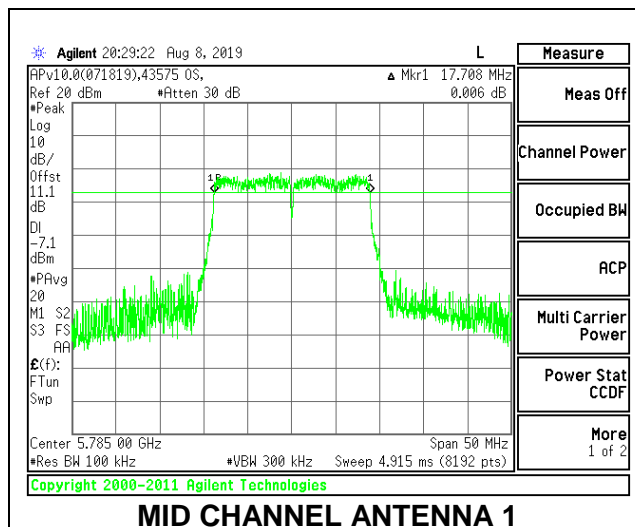

HIGH CHANNEL

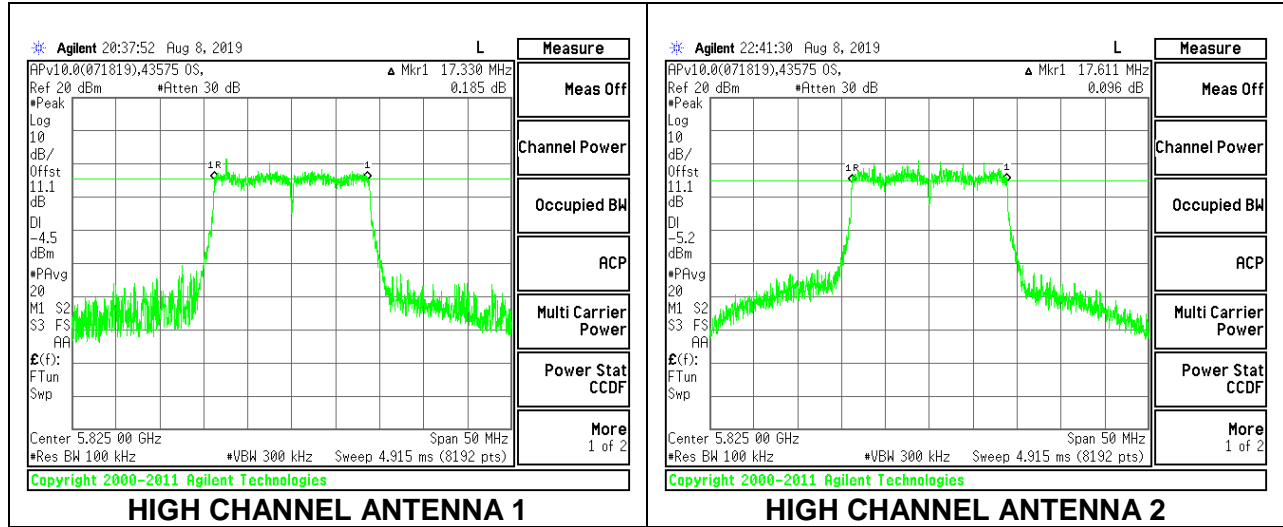

8.4.2. 802.11n HT40 MODE IN THE 5.8 GHz BAND

1TX Antenna 1 MODE

Channel	Frequency (MHz)	6 dB Bandwidth (MHz)	Minimum Limit (MHz)
Low	5755	35.6730	0.5
High	5795	36.0400	0.5

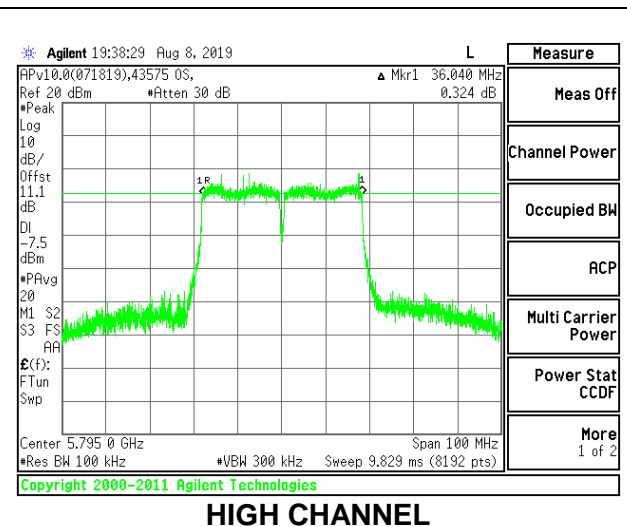
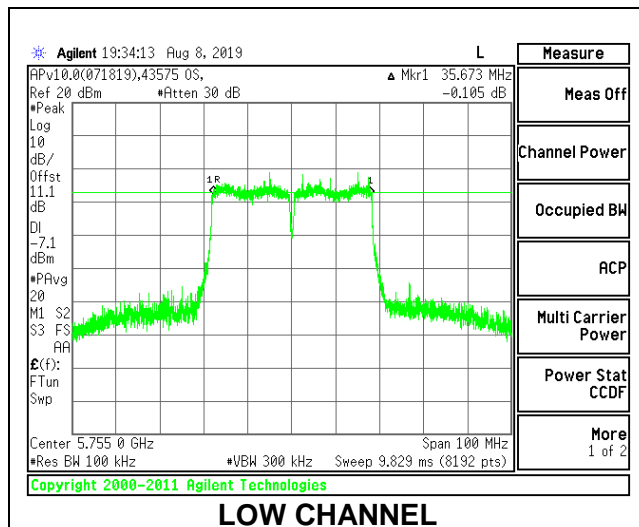

1TX Antenna 2 MODE

Channel	Frequency (MHz)	6 dB Bandwidth (MHz)	Minimum Limit (MHz)
Low	5755	35.1360	0.5
High	5795	36.3200	0.5

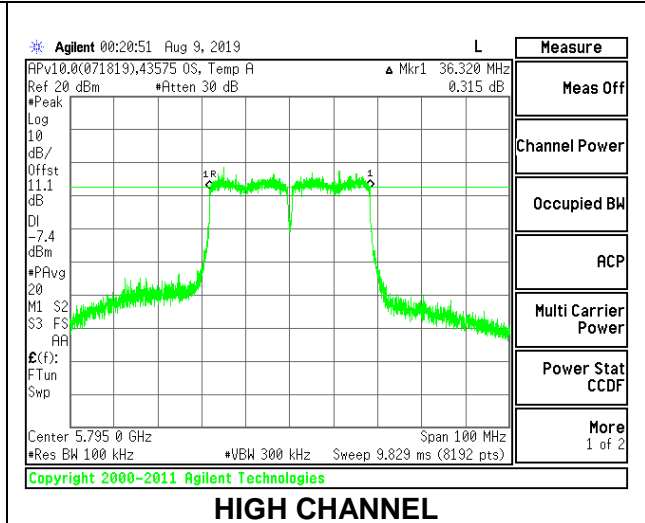
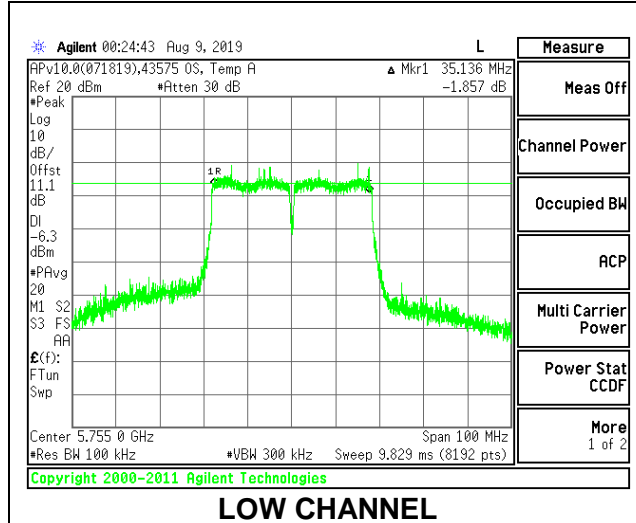

2TX Antenna 1 + Antenna 2 CDD MODE

Channel	Frequency (MHz)	6 dB BW	6 dB BW	Minimum Limit (MHz)
		Antenna 1 (MHz)	Antenna 2 (MHz)	
Low	5755	35.4900	35.5630	0.5
High	5795	36.2840	35.7340	0.5

LOW CHANNEL

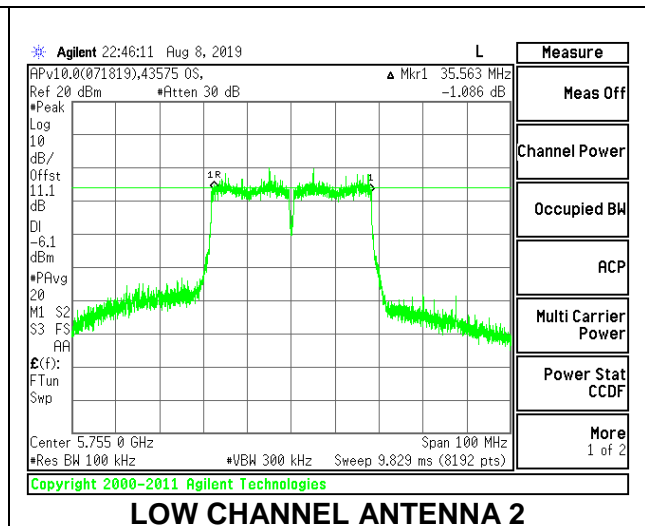
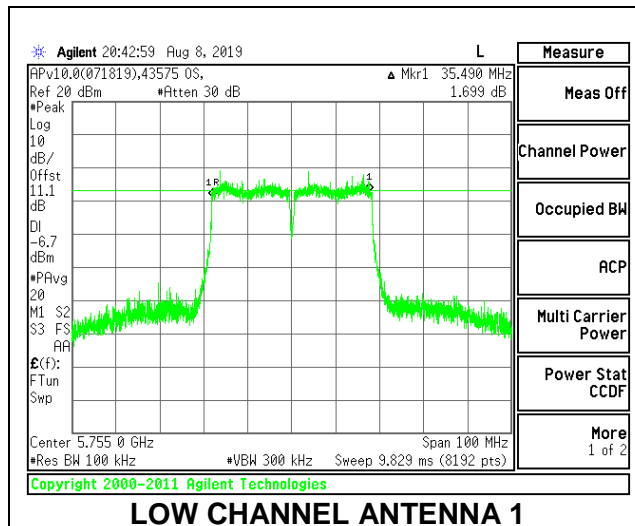

HIGH CHANNEL

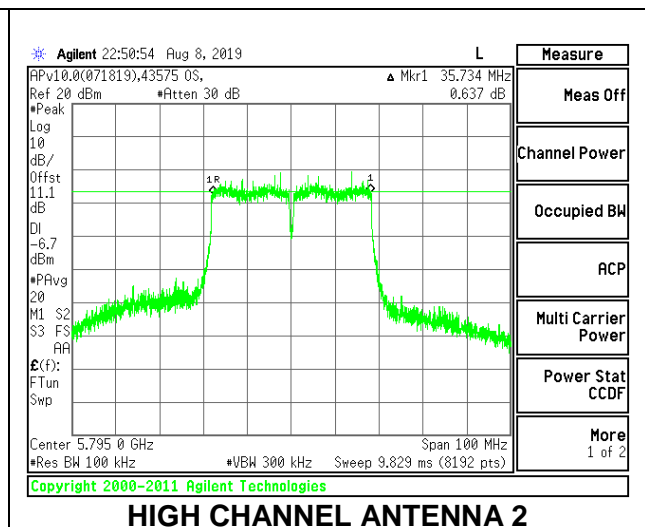
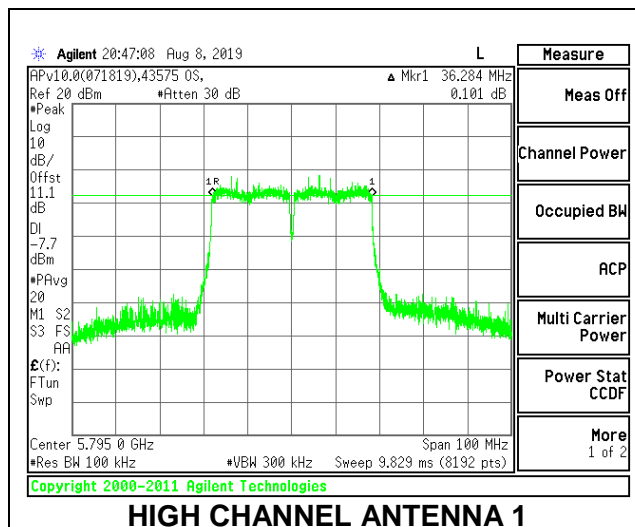

8.4.3. 802.11ac VHT80 MODE IN THE 5.8 GHz BAND

1TX Antenna 1 MODE

Channel	Frequency (MHz)	6 dB Bandwidth (MHz)	Minimum Limit (MHz)
Mid	5775	76.3520	0.5

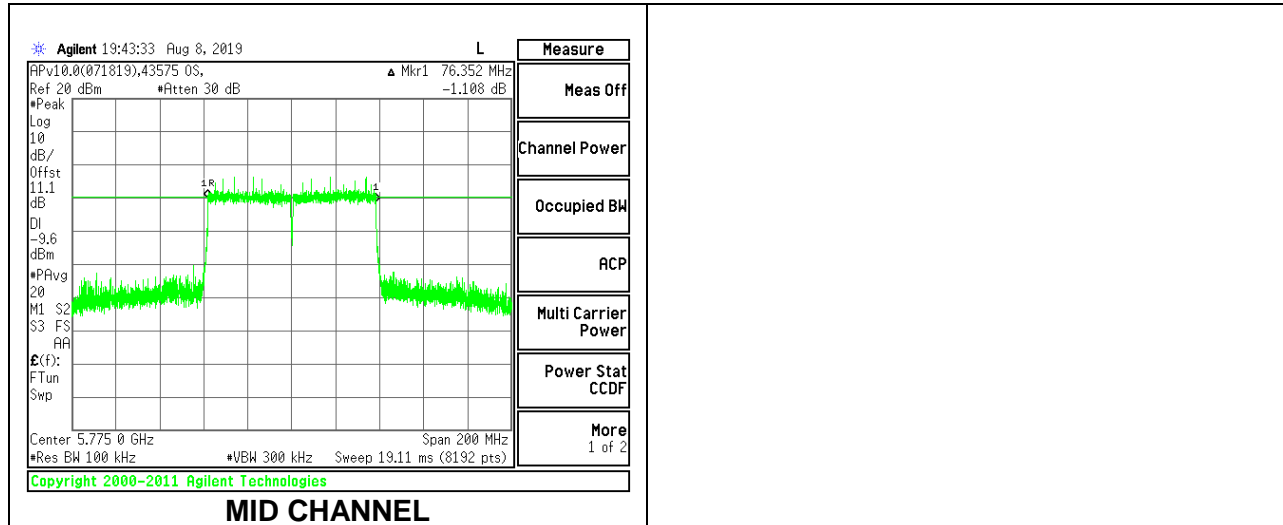

1TX Antenna 2 MODE

Channel	Frequency (MHz)	6 dB Bandwidth (MHz)	Minimum Limit (MHz)
Mid	5775	76.0590	0.5

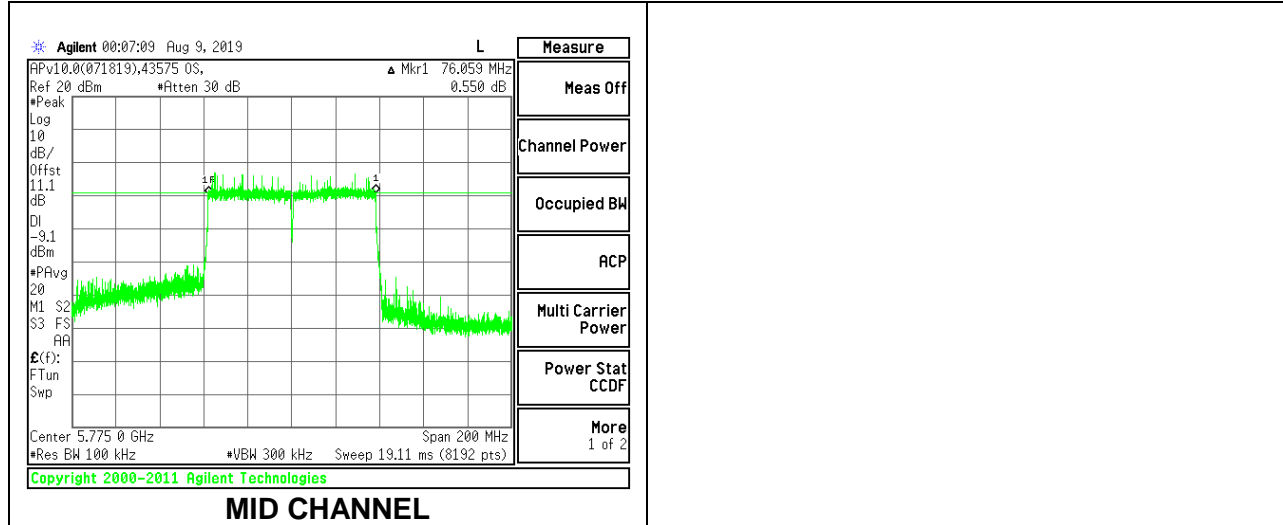

2TX Antenna 1 + Antenna 2 CDD MODE

Channel	Frequency (MHz)	6 dB BW	6 dB BW	Minimum Limit (MHz)
		Antenna 1 (MHz)	Antenna 2 (MHz)	
Mid	5775	76.1080	75.7170	0.5

MID CHANNEL

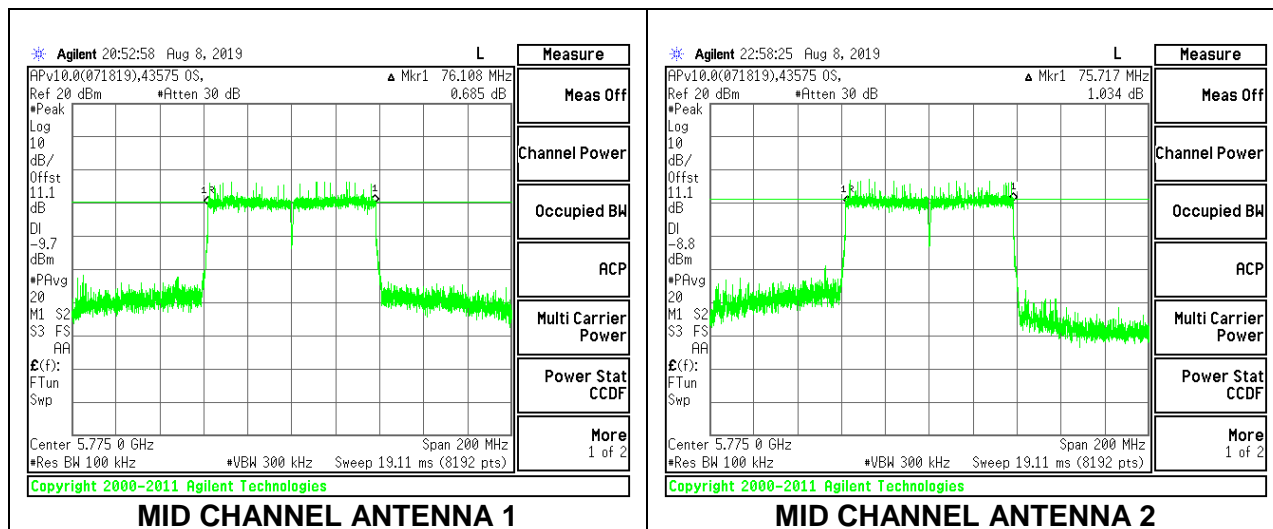

8.5. OUTPUT POWER AND PSD

LIMITS

FCC §15.407

Band 5.15–5.25 GHz

(i) For an outdoor access point operating in the band 5.15-5.25 GHz, the maximum conducted output power over the frequency band of operation shall not exceed 1 W provided the maximum antenna gain does not exceed 6 dBi. In addition, the maximum power spectral density shall not exceed 17 dBm in any 1 megahertz band. If transmitting antennas of directional gain greater than 6 dBi are used, both the maximum conducted output power and the maximum power spectral density shall be reduced by the amount in dB that the directional gain of the antenna exceeds 6 dBi. The maximum e.i.r.p. at any elevation angle above 30 degrees as measured from the horizon must not exceed 125 mW (21 dBm).

(ii) For an indoor access point operating in the band 5.15-5.25 GHz, the maximum conducted output power over the frequency band of operation shall not exceed 1 W provided the maximum antenna gain does not exceed 6 dBi. In addition, the maximum power spectral density shall not exceed 17 dBm in any 1 megahertz band. If transmitting antennas of directional gain greater than 6 dBi are used, both the maximum conducted output power and the maximum power spectral density shall be reduced by the amount in dB that the directional gain of the antenna exceeds 6 dBi.

(iii) For fixed point-to-point access points operating in the band 5.15-5.25 GHz, the maximum conducted output power over the frequency band of operation shall not exceed 1 W. In addition, the maximum power spectral density shall not exceed 17 dBm in any 1 megahertz band. Fixed point-to-point U-NII devices may employ antennas with directional gain up to 23 dBi without any corresponding reduction in the maximum conducted output power or maximum power spectral density. For fixed point-to-point transmitters that employ a directional antenna gain greater than 23 dBi, a 1 dB reduction in maximum conducted output power and maximum power spectral density is required for each 1 dB of antenna gain in excess of 23 dBi. Fixed, point-to-point operations exclude the use of point-to-multipoint systems, omnidirectional applications, and multiple collocated transmitters transmitting the same information.

(iv) For mobile and portable client devices in the 5.15-5.25 GHz band, the maximum conducted output power over the frequency band of operation shall not exceed 250 mW provided the maximum antenna gain does not exceed 6 dBi. In addition, the maximum power spectral density shall not exceed 11 dBm in any 1 megahertz band. If transmitting antennas of directional gain greater than 6 dBi are used, both the maximum conducted output power and the maximum power spectral density shall be reduced by the amount in dB that the directional gain of the antenna exceeds 6 dBi.

Band 5.725-5.85 GHz

The maximum conducted output power over the frequency band of operation shall not exceed 1 W. In addition, the maximum power spectral density shall not exceed 30 dBm in any 500-kHz band. If transmitting antennas of directional gain greater than 6 dBi are used, both the maximum conducted output power and the maximum power spectral density shall be reduced by the

amount in dB that the directional gain of the antenna exceeds 6 dBi. However, fixed point-to-point U-NII devices operating in this band may employ transmitting antennas with directional gain greater than 6 dBi without any corresponding reduction in transmitter conducted power. Fixed, point-to-point operations exclude the use of point-to-multipoint systems, omnidirectional applications, and multiple collocated transmitters transmitting the same information.

TEST PROCEDURE

The measurement method used for output power is KDB 789033 D02 v02r01, Section E.3.b (Method PM-G) and for straddles channels KDB 789033 D02 v02r01, Section E.2.b (Method SA-1) was used.

The measurement method used for power spectral density is KDB 789033 D02 v02r01, Section F

DIRECTIONAL ANTENNA GAIN

Tx chains are uncorrelated for power and correlated for PSD due to the device supporting CDD in all MIMO modes. The directional gains are as follows:

Band (GHz)	Antenna 1 Antenna Gain (dBi)	Antenna 2 Antenna Gain (dBi)	Uncorrelated Chains Directional Gain (dBi)	Correlated Chains Directional Gain (dBi)
5.2	3.60	3.60	3.60	6.61
5.8	2.7	2.7	2.70	5.71

RESULTS

8.5.1. 802.11n HT20 MODE IN THE 5.2 GHz BAND

1TX Antenna 1 MODE (FCC) MOBILE

Antenna Gain and Limits

Channel	Frequency (MHz)	Directional Gain (dBi)	Power Limit (dBm)	PSD Limit (dBm/ 1MHz)
Low	5180	3.60	24.00	11.00
Mid	5200	3.60	24.00	11.00
High	5240	3.60	24.00	11.00

Duty Cycle CF (dB)	0.10	Included in Calculations of Corr'd PSD
---------------------------	------	---

Output Power Results

Channel	Frequency (MHz)	Meas Power (dBm)	Total Corr'd Power (dBm)	Power Limit (dBm)	Power Margin (dB)
Low	5180	12.57	12.57	24.00	-11.43
Mid	5200	11.90	11.90	24.00	-12.10
High	5240	11.08	11.08	24.00	-12.92

PSD Results

Channel	Frequency (MHz)	Meas PSD (dBm/1MHz)	Total Corr'd PSD (dBm/1MHz)	PSD Limit (dBm/ 1MHz)	PSD Margin (dB)
Low	5180	0.23	0.33	11.00	-10.67
Mid	5200	0.07	0.17	11.00	-10.83
High	5240	-0.27	-0.17	11.00	-11.17

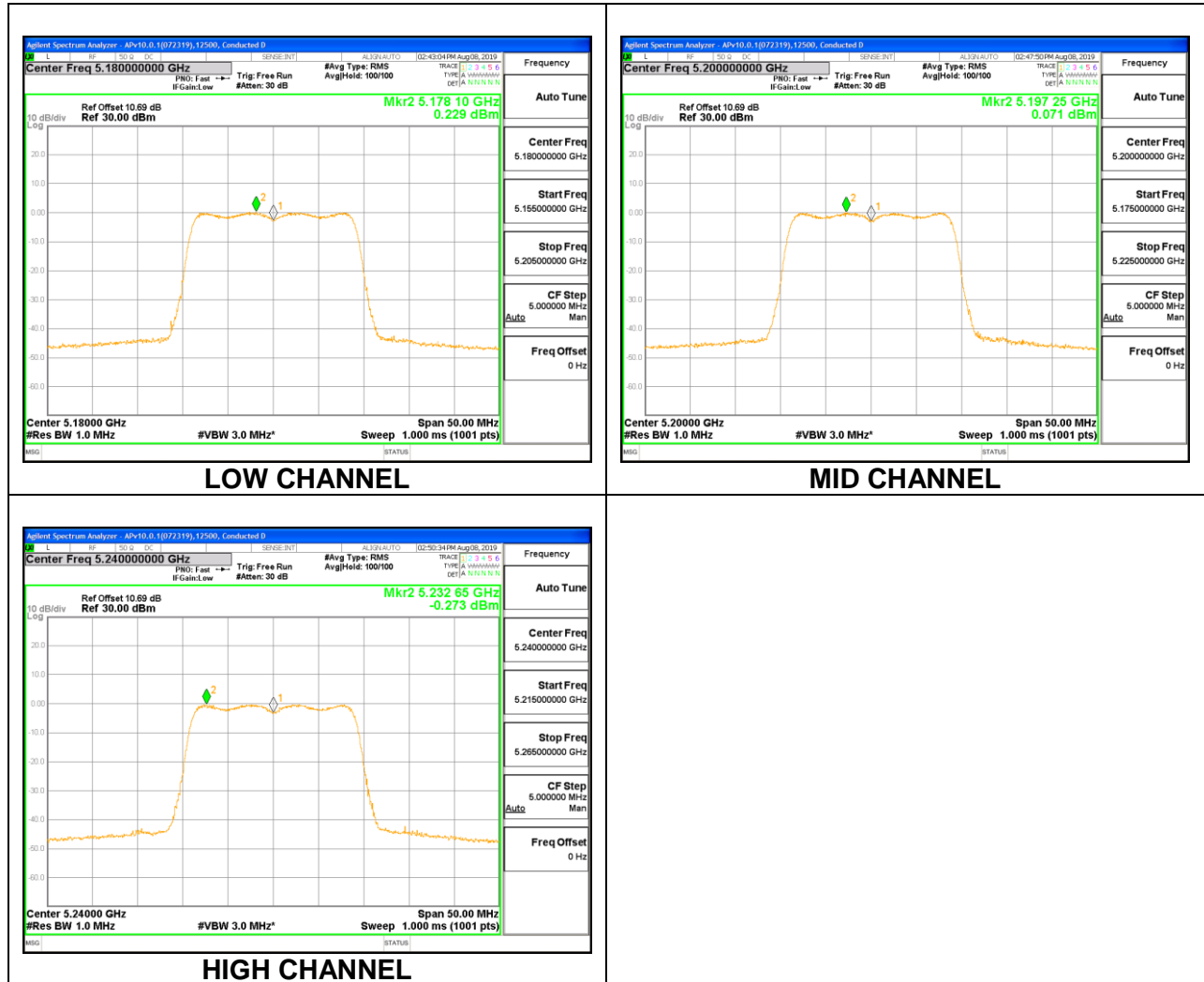

1TX Antenna 2 MODE (FCC) MOBILE

Antenna Gain and Limits

Channel	Frequency (MHz)	Directional Gain (dBi)	Power Limit (dBm)	PSD Limit (dBm/ 1MHz)
Low	5180	3.60	24.00	11.00
Mid	5200	3.60	24.00	11.00
High	5240	3.60	24.00	11.00

Duty Cycle CF (dB)	0.10	Included in Calculations of Corr'd PSD
---------------------------	------	---

Output Power Results

Channel	Frequency (MHz)	Meas Power (dBm)	Total Corr'd Power (dBm)	Power Limit (dBm)	Power Margin (dB)
Low	5180	12.64	12.64	24.00	-11.36
Mid	5200	12.95	12.95	24.00	-11.05
High	5240	12.93	12.93	24.00	-11.07

PSD Results

Channel	Frequency (MHz)	Meas PSD (dBm/1MHz)	Total Corr'd PSD (dBm/1MHz)	PSD Limit (dBm/ 1MHz)	PSD Margin (dB)
Low	5180	1.45	1.55	11.00	-9.45
Mid	5200	1.64	1.74	11.00	-9.26
High	5240	1.94	2.04	11.00	-8.96

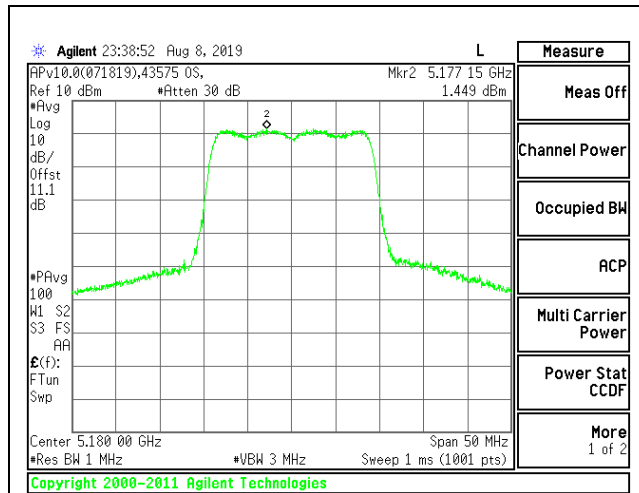

LOW CHANNEL

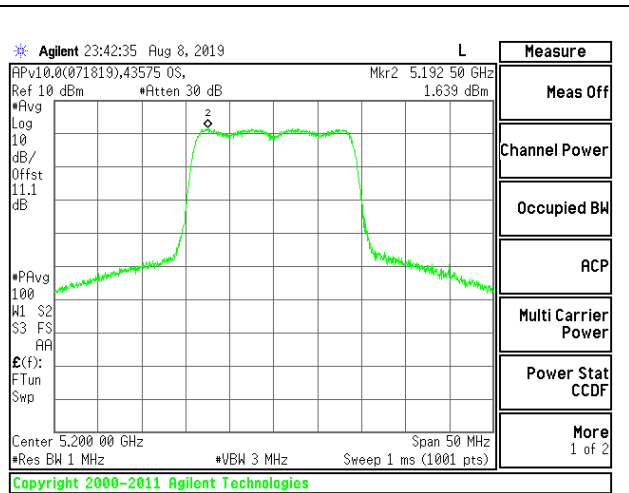

MID CHANNEL

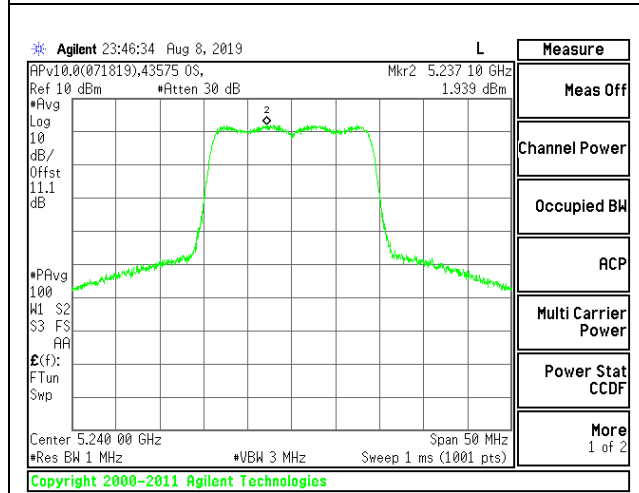

HIGH CHANNEL