



RCSTEB

Thermostatic On/Off and Blower Remote Control– 120VAC INSTALLATION AND OPERATING INSTRUCTIONS

This remote control system provides a safe, reliable and user-friendly remote control for millivolt valve gas appliances and blower speed adjustment. The system can be manually or thermostatically turned on and off with the transmitter. Always check the appliance home owner's manual for additional information, or warnings regarding accessory installation before connecting this remote control system.

Carefully inspect the contents for shipping damage. If any parts are missing or damaged, immediately contact the dealer from whom you purchased the kit or Ambient Technologies Technical Support at 1 800 398 6195. Do not attempt to install any part of the kit unless all parts are in good condition. Please keep this booklet for future reference.

CONTENTS OF KIT

Description	Qty
Transmitter	1
Battery Alkaline AAA (for Transmitter)	3
Receiver (Assembly) consists of :	1
Receiver Box	
AC Adaptor for Receiver	
Slide Button-Black (On/RS/Off)	1
Wall Cover Plate-Black	1
Wire Nuts	2
Plug-In Wiring Assembly – 22” Inches	1
Velcro (Loop and Hook)	1
Installation Instructions	1
Screws (for fireplace system control covers)	2

FEATURES/SPECIFICATIONS

- Easy Access Thermostatic Control
- Battery Powered Transmitter
- Low battery Indication for Transmitter
- Compact 120 VAC Adapter with 30” wire
- Three Speed Control for Blower
- Programmable Timer to turn blower on and off
- Child Proof Lock-out
- 16 Security Codes
- 6 hour Shut Down (Optional)
- Quick Disconnect Wiring Assembly
- Reset Button

WARNING
Important Safety Information

- Read this manual thoroughly prior to installing, programming or operating any remote control.
- This remote control system is designed for use with a millivolt gas valve system with blower. Do not use this remote control system on applications with voltages above 24 Volts AC/DC and 1 amp current.
- This remote control system requires three (3) "AAA" alkaline batteries to power the transmitter. The receiver is powered by external AC Adapter.
- Wiring must conform to appliance requirement and building codes/ordinances as required by local and national code authorities having jurisdiction.
- Do not short (or jumper) across the gas valve terminals to test the remote control installation. This could damage the unit and void the warranty.
- This remote control system should only be used as described in this manual. Any other use is not recommended and will void the warranty.

NOTE

Due to the sensitive temperature monitoring components in the transmitter, it is necessary to allow the transmitter to stabilize to room temperature before accurate room temperatures are displayed. If the transmitter is activated from a severe cold condition, allow 15 minutes for accurate temperature readings to appear on the LCD.

WARNING

Turn appliance OFF and allow to cool before installing or servicing. **DO NOT** connect 110-120 VAC wiring to the milli-volt gas control valve. The remote operator must be installed exactly as outlined in these instructions. Read all instructions completely before attempting installation. Follow instructions carefully during installation. Any modification of components will void the warranty and may cause a fire hazard.

WARNING

Turn appliance OFF (at the appliance or remote receiver) if you are away from your house for an extended period of time. Never leave anything on top of the surface of the transmitter.

INSTALLATIONS

Remote Receiver:

The remote receiver may be installed in the appliance per the appliance homeowner's manual. **Refer to the Homeowner's Manual for special installation instructions.** Failure to follow the installation instructions found in the appropriate Homeowner's Manual will void the warranty and may cause a fire hazard.

This system comes with an 22 inch wire assembly labeled “MV VALVE”. Insert the white terminal into the back of the receiver. The terminal wire block can only be installed one way and do not force the terminal plug into the receiver.

Connect the wiring terminal two (2) 1/4" female spade terminals to the appliance valve. Refer to the appropriate Homeowner's Manual for proper wiring connections to the appliance. Your appliance may have other options to connect wiring from receiver. For applications longer than 22 inches, use 18 gauge wire, 105°C rated, with no splices. Connect to the two (2) 1/4" female spade wiring terminals and wire can be no longer than 20 feet.

WARNING	<p>Speed control module and thermal sensor must be removed before installing receiver and applying the AC power. Failure to do so may cause the part damage and void the warranty. Without removing the control module and thermal sensor, they and RCSTEB both will try to operate the blower at the same and may cause unexpected blower operation or damage.</p>
----------------	--

Before connecting the blower with the receiver, always DISCONNECT SPEED CONTROL MODULE AND THERMAL SENSOR from your fireplace if they exist as displayed in following diagram:

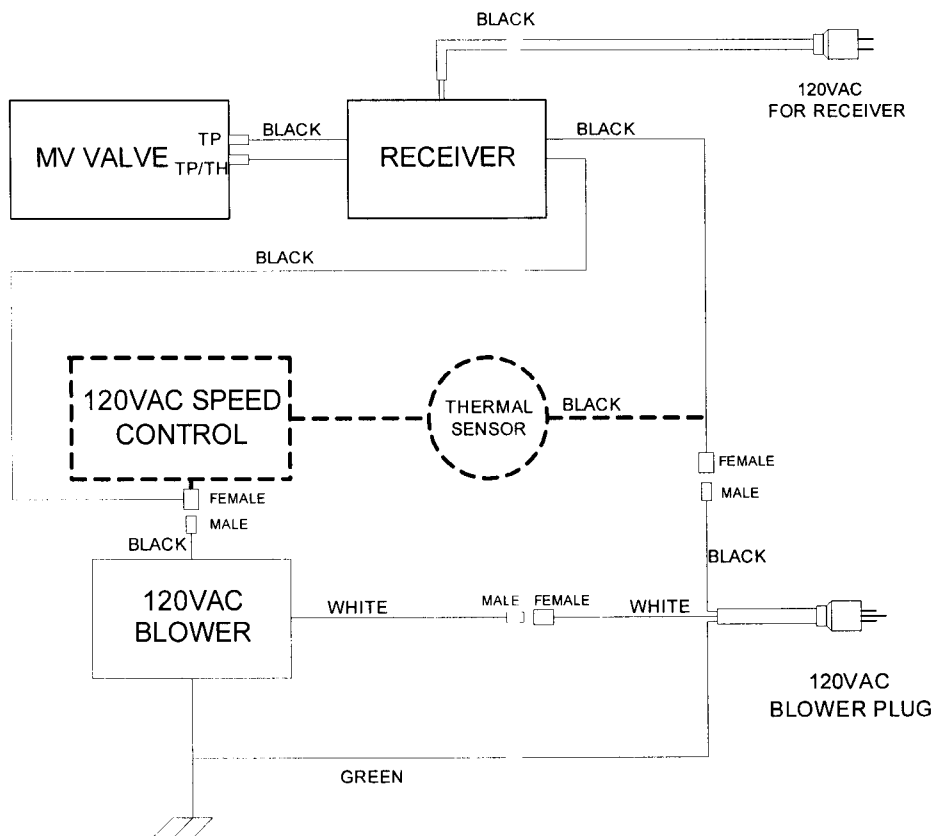

Connect the two 30" long 18AWG wires labeled “110VAC FAN ONLY” between receiver and blower as shown in the following diagram as well.

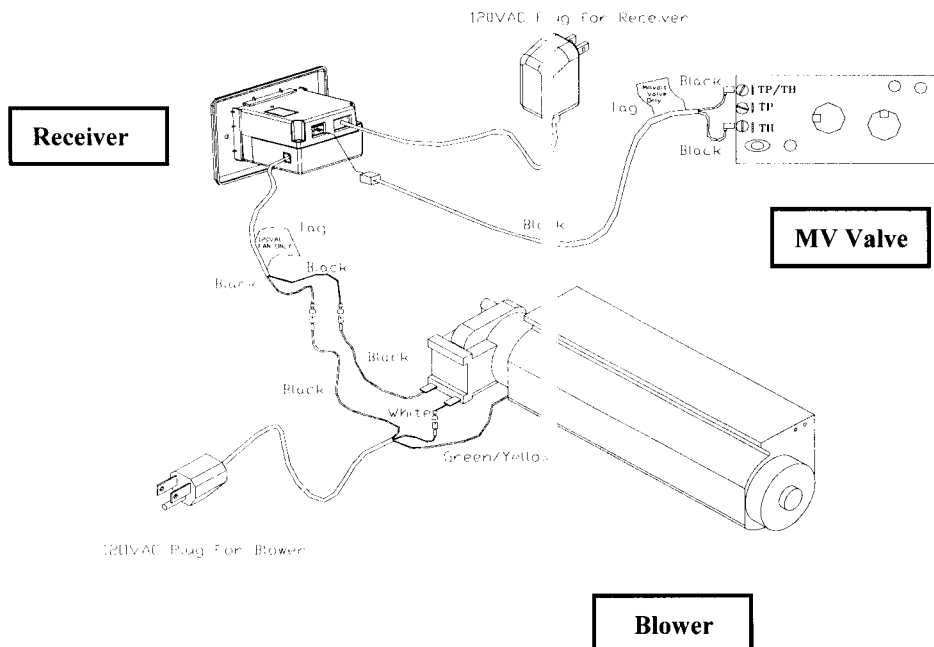

WARNING

STOP: Make sure 120VAC fan and MV valve are correct. If not wired correctly, this could cause damage to receiver.

Make sure that the wires do not contact the appliances any place other than at the terminals. Exposure to temperatures higher than 105C (250°F) may cause the receiver to malfunction and cause possible fire hazard.

Remote Transmitter:

Installing Batteries:

The remote transmitter uses three (3) "AAA"- size batteries. To install batteries,

1. Press down the battery door tab and pull out to remove the battery door.
2. Install the batteries as indicated on transmitter.
3. Close the battery door by snapping in place.
4. When three batteries are installed, the transmitter will initialize for 10 seconds and then is ready for use.
5. The batteries should be replaced at least once every 6 months or when the low battery icon indicator is displayed.

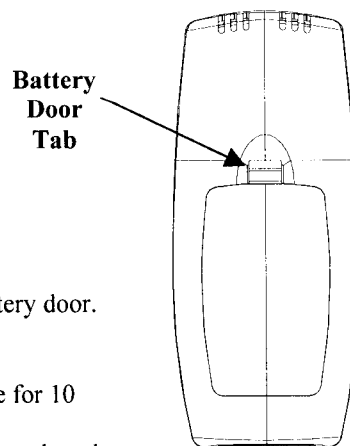

Back of the Transmitter

Setting Privacy (DIP) Switch on Receiver and Transmitter:

The remote receiver and transmitter privacy (DIP) switches are preset at the factory. In the event of activation or interference from other nearby transmissions, reset the code using the following procedure:

1. Slide the code switches on the transmitter and receiver to your choice of ON or OFF position. Switches #1, #2, #3 and #4 are preset to "ON" for both the transmitter and receiver.
2. The switches on the transmitter and receiver must match in order for the system to work.
3. To check, press either the On or Off button on the transmitter and the receiver indicator light will blink. If not repeat step 2.
4. The system is now ready to operate.

NOTE See optional auto shutdown on page 8 of 10.

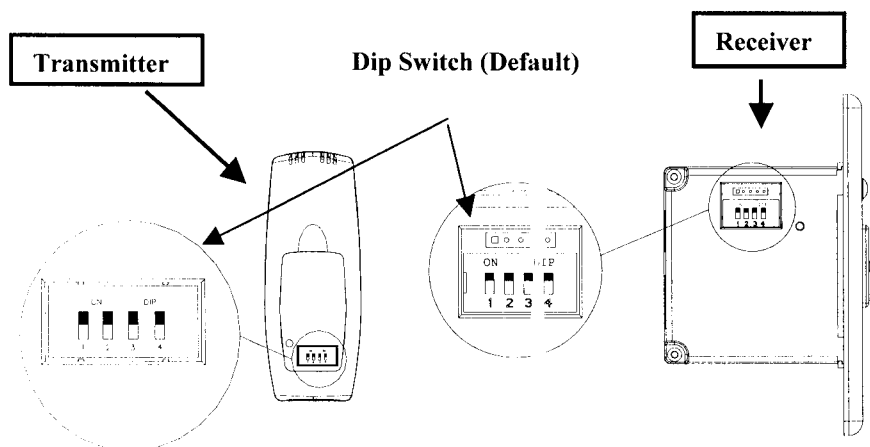

WARNING

Do not use two (2) or more remote control systems in the same area with the same dip switch settings, as they will communicate with each other. This may cause the appliances to malfunction.

Reset Button:

1. The reset button can be used to reset the transmitter if transmitter is not working properly. The reset button is located behind the battery door cover in the lower left corner of battery compartment. Using a paper clip, press the reset button and the transmitter will reset and initialize for 10 seconds before it can be used.

OPERATIONS

Transmitter:

General:

The RCSTEB Remote Control has two (2) operating modes: Manual and Thermostatic. The control system can be set to temperature ranges between 45°F and 90°F. The blower speed can be adjusted in either the manual and thermostatic mode.

The transmitter will operate the remote receiver from 1 foot to a maximum of 30 feet. The distance is reduced when batteries are low or when the receiver is inside a metal enclosure.

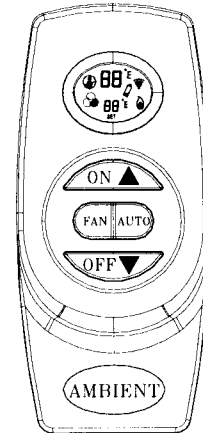

Initial start up:

1. After initial power up or when RESET button is pressed, the transmitter is reset. The reset button is located behind the battery door of transmitter.
2. During system reset, all features of the LCD will be visible. After one second, the LCD will be initialized. A typical reset display is shown above. Note that the temperature scale is degree F.
3. Press On button to select between °C and °F display. It will exit setting mode automatically after 10 seconds if no key is pressed. The transmitter will send an Off signal after reset.
4. After reset, the transmitter is operating in manual mode. The room temperature is shown as above.

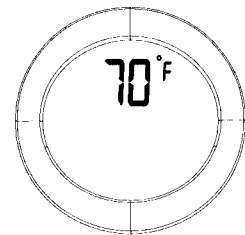

Manual Mode:

1. Press the ON button once to turn on the appliance. Press the OFF button to turn it off.

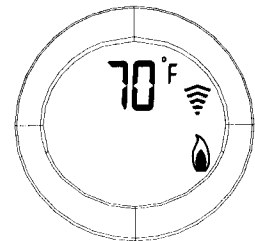

Thermostatic mode:

1. Press the AUTO button to enter the thermostatic mode.
2. In thermostatic mode, press the ON / Δ button or OFF / ∇ button to set the desired set temperature.
3. Once the setting is completed, the transmitter will automatically turn on the fireplace when the room temperature is below the set temperature and turn off the appliance when the room temperature is above the set temperature within 1 degree.
4. There will be a slight delay in the response of the unit (on/off) to a temperature. Room temperature is monitored every 3 minutes.
5. Press the Auto button to exit the thermostatic mode (Return to Manual Mode). The transmitter will be in the manual on/off mode and receiver / transmitter will maintain the previous settings of Fan speed & blower Delay on & Delay off time.

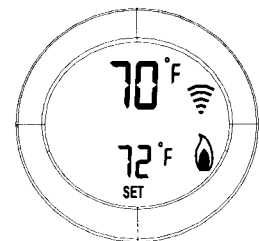

3-Speed Bower Control:

1. Press FAN button once to enter blower speed setup mode at low speed initially and one of the three blade icon will display darken on LCD.
2. Continue to press FAN button to set up the blower speed you desire.
3. If there is no input within 3 seconds, the new setting will be transmitted to receiver. If fireplace is on, the blower speed will take effect right away; if fireplace is off, the receiver will remember this setting and blower is still off.
4. If you continue to press FAN button while fire is on or off the FAN icon will disappear and turn the blower off.

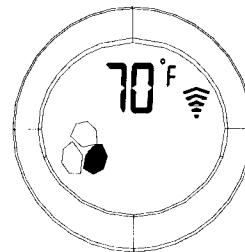

Blower On Delay Time and Off Delay Time Setting:

1. Hold FAN button for 5 second and two numbers will show up in LCD screen. The upper one is On Delay Time and the bottom is Off Delay Time.
2. Use the ON / Δ button to set the desired On Delay Time from 0 to 15 min.
3. Use the OFF / ∇ button to set the desired Off Delay Time from 0 to 15 min.
4. If there is no input within 3 seconds, the new setting will be transmitted to receiver.
5. The default settings for both transmitter and receiver are 5 minutes for On Delay Time and 8 minutes for Off Delay Time, as shown in this picture.

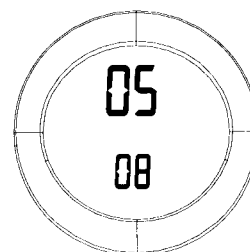

NOTE The most efficient setting for your fireplace blower is when blower comes on and off, it is blowing warm air only not hot air. Giving the fireplace as much time to discharge as much warm air as possible before turning off.

Low-battery detection:

1. Battery voltage is checked once a minute. When the battery voltage drops to a certain level, the low-battery icon will display on LCD, and the transmitter **will turn off the appliance**. The transmitter will not function anymore until fresh batteries are installed.
2. When the batteries are low, the LCD displays a low battery indicator. The low battery indicator will be displayed in any mode.
3. The transmitter will not operate with low batteries. Change the batteries before the batteries are too weak for normal operation. **TURN THE UNIT OFF BEFORE REPLACING BATTERIES.**

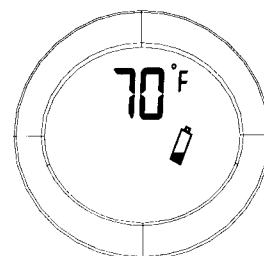

Child-proof protection:

1. Press and hold the ON and OFF buttons simultaneously for 3 seconds to enter childproof mode as shown in this picture.
2. The transmitter will not send a signal again until childproof mode is deactivated by pressing the ON and OFF buttons simultaneously for 3 seconds to exit childproof mode and the Childproof indicator disappears from LCD.

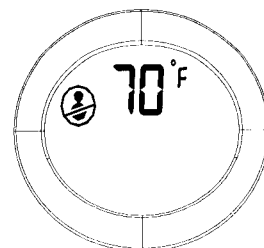

Transmitter Thermal Shutdown:

1. If transmitter measures a room temperature exceeding 99 degrees Fahrenheit, the LCD will display "HI" and the transmitter will turn off the appliance.
2. Transmitter will not function until the room temperature has dropped below 99 degree Fahrenheit. If transmitter measures a room temperature less than 40 degrees Fahrenheit, the LCD will display "LO" and **NO SIGNAL will be sent to turn on the appliance.**

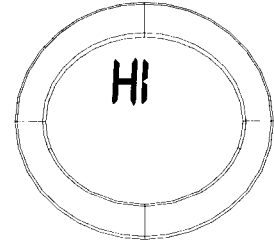

Receiver:

Slide Switch:

1. ON position: the main burner will ignite and blower will come on when Blower on Delay Time is reached and fan speed has been enabled; otherwise just burner will ignite until the slide switch is placed in the OFF or RS position to turn burner off.
2. RS position: the system will only operate if the remote receiver receives a signal from the transmitter.
3. OFF position, the system is off. If fan speed has been enabled blower will continue to operate until Off Delay Time expires. **The slide switch should be placed in the OFF position if you will be away for an extended period of time.** If the remote receiver is mounted out of children's reach, the OFF position also functions as a safety device by both turning the system off and rendering the receiver inoperable.

Optional Auto Shutdown:

1. The receiver comes preset from the factory with a 6 hour shutdown from its last ON operation. This is done to prevent the appliance from continuing to run if unattended.
2. You may disable this feature if you wish. To disable, change the receiver privacy (DIP) switch #1 ONLY to the OFF position. Make sure the receiver privacy (DIP) switches are set the same. Follow the instructions on how to set the privacy (DIP) switch setting.
3. **By disabling this feature, your appliance may continue to run unattended.**

Optional Wall Cover Plate:

1. Receiver snaps into wall cover plate. The wall plate is mounted by using 2 screws provided.

TESTING YOUR NEW REMOTE CONTROL SYSTEM

1. Light your gas appliance following the appliance lighting instructions that came with the appliance. Confirm that the pilot light is on; it must be in operation for the remote control to operate the main gas valve and blower. Appliance control knob must be in the ON position, and appliance ON/OFF switch must be in OFF position.
2. Slide the 3 position button on the remote receiver to the ON position and the main gas flame should ignite.
3. Slide the button to OFF and the main gas flame should extinguish, but the pilot light will remain on.
4. Slide the button to RS (the center position), then press the ON button on transmitter to turn the system ON. The main gas flame should ignite and blower should come on after the On Delay Time is reached and fan speed you desire is selected.
5. Press the OFF button on transmitter to turn the system to OFF. The flame should extinguish (the pilot light will remain on) and blower should be off after the Off Delay Time you set.

TROUBLESHOOTING

Symptom	Causes	Action
1. Battery icon on LCD on transmitter. 2. LCD display is blank 3. LCD display shows "funny" display	1. Low Battery	1. Replace batteries. Change batteries every 6 months. 2. Check battery installation or replace batteries. 3. Press Reset button at the back of the transmitter.
4. Appliance does not come on.	1. Wiring / Electrical Connections	1. Slide the switch to ON, if appliance comes ON, wiring is not the cause. 2. If appliance does not come on, check wiring connections.
	2. Privacy (DIP) switch setting on transmitter does not match receiver	1. Make sure the transmitter and receiver have the same DIP switch settings.
	3. Transmitter measures temperature exceeding 99 degrees Fahrenheit and shows "HI" on LCD	1. Move transmitter to a cooler place and wait until temperature drops below 99 degree.
	4. Distance between the transmitter and receiver is more than 30 feet	1. Make sure the operating distance is less than 30 feet
5. Receiver cannot receive signal.	1. Receiver is installed in an enclosure	1. Make sure the receiver is not located inside to tight of an enclosure.
6. Blower is not on after the fireplace is turned on	1. Blower setting is off 2. Blower delay setting is set too high	1. Press FAN key to select Fan speed you desire. 2. Press and hold FAN key to set desired ON/OFF delays. This is done in minutes.

WARNING: Changes or modifications to this unit not expressly approved by the party responsible for compliance could void the user's authority to operate the equipment.

NOTE: This equipment has been tested and found to comply with the limits for a Class B digital device, pursuant to Part 15 of the FCC Rules. These limits are designed to provide reasonable protection against harmful interference in a residential installation. This equipment generates uses and can radiate radio frequency energy and, if not installed and used in accordance with instructions, may cause harmful interference to radio communications. However, there is no guarantee that interference will not occur in a particular installation. If this equipment does cause harmful interference to radio or television reception, which can be determined by turning the equipment off and on, the user is encouraged to try to correct the interference by one or more of the following measures:

- Reorient or relocate the receiving antenna.
- Increase the separation between the equipment and receiver.
- Connect the equipment into an outlet on a circuit different from that to which the receiver is connected.
- Consult the dealer or an experienced radio/TV technician for help.

WARRANTY

This warranty gives you specific legal rights and you may also have other rights that vary from state to state or province to province. Answers to any questions regarding our limited warranty may be obtained by writing our corporate offices.

Ambient Technologies warrants each new Ambient Technologies remote control against any defects that are due to faulty material or workmanship to the original owner, for a period of five years after the original date of purchase. This warranty and our liability does not apply to batteries, nor does it include damage to merchandise or the remote control resulting from accident, alteration, neglect, misuse, improper installation or any other failure to follow Ambient Technologies installation and operating instructions.

After contacting Ambient Technologies Tech Service to receive a return authorization number, we agree to repair or replace at our option any Ambient Technologies remote control under warranty. Provided it is returned postage prepaid to our warranty facility in a padded carton within the warranty period, with proof of the original date of purchase and a brief description of the malfunction. This limited warranty does not include the cost of removal or re-installation.

Ambient Technologies
149 Cleveland Drive
Paris KY 40361

**FOR TECHNICAL SUPPORT
CALL 800-398-6195**

Standard Thermostatic On/Off Remote Control INSTALLATION AND OPERATING INSTRUCTIONS

This wireless thermostatic on/off remote control – system provides a safe, reliable, and user-friendly remote control for millivolt valve gas appliances. The system can be thermostatically or manually turned on and off with the transmitter. Always check the appliance home owner's manual for additional information, or warnings regarding accessory installation before connecting this remote control system.

Carefully inspect the contents for shipping damage. If any parts are missing or damaged, immediately contact the dealer from whom you purchased the kit. Do not attempt to install any part of the kit unless all parts are in good condition. Please keep this booklet for future reference.

CONTENTS OF KIT

Description	Qty
Transmitter	1
Battery Alkaline AAA (for Transmitter)	3
Battery Alkaline AA (for receiver)	4
Receiver (Assembly) consists of:	1
Receiver Box	
Slide Button-Black (On/RS/Off)	
L-Bracket (Floor Mount)	
Wall Cover Plate-Black	1
Wall Cover Plate-White	1
Slide Button-White (On/RS/Off)	1
Screws (for Wall Cover Plate)	2
Plug-In Wiring Assembly – 18" Inches	1
Velcro (Loop and Hook)	1
Installation Instructions	1
Screws (for fireplace system control covers)	2

FEATURES/SPECIFICATIONS

- Easy Access Thermostatic Control
- Battery Powered Transmitter and Receiver
- Low Battery Indication
- Child Proof Lock-out
- 16 Security Codes
- 6 hour Shut Down (Optional)
- Quick Disconnect Wiring Assembly
- Reset Button

WARNING Important Safety Information

- Read this manual thoroughly prior to installing, programming or operating any remote control.
- This remote control system is designed for use with a millivolt gas valve system. Do not use this remote control system on applications with voltages above 24 Volts AC/DC and 1 amp current.
- This remote control system requires three (3) "AAA" and four (4) "AA" alkaline batteries to power the transmitter and receiver. Wiring must conform to appliance requirement and building codes/ordinances as required by local and national code authorities having jurisdiction.
- Wiring must conform to appliance requirement and building codes/ordinances as required by local and national code authorities having jurisdiction.
- Do not short (or jumper) across the gas valve terminals to test the remote control installation. This could damage the unit and void the warranty.
- This remote control system should only be used as described in this manual. Any other use is not recommended and will void the warranty.

NOTE

Due to the sensitive temperature monitoring components in the transmitter, it is necessary to allow the transmitter to stabilize to room temperature before accurate room temperatures are displayed. If the transmitter is activated from a severe cold condition, allow 15 minutes for accurate temperature readings to appear on the LCD.

WARNING

Turn appliance OFF and allow to cool before installing or servicing. **DO NOT** connect 110-120 VAC wiring to the milli-volt gas control valve. The remote operator must be installed exactly as outlined in these instructions. Read all instructions completely before attempting installation. Follow instructions carefully during installation. Any modification of components will void the warranty and may cause a fire hazard.

WARNING

Turn appliance OFF (at the appliance or remote receiver) if you are away from your house for a period of time. Never leave anything on top of the surface on the transmitter.

INSTALLATIONS

Remote Receiver:

The remote receiver may be wall mounted or installed in the appliance per the appliance homeowner's manual. Refer to the Homeowner's Manual for special installation instructions. If wall mounted, the remote receiver must be installed in a junction box with cover plate provided. Failure to follow the installation instructions found in the appropriate Homeowner's Manual will void the warranty and may cause a fire hazard.

Installing Batteries:

The remote receiver uses four (4) "AA" - size batteries. To install batteries,

1. Remove the slide switch by gently pulling straight out.
2. Use your thumb and index finger to gently pull down the L-bracket.
3. Open the battery door by pressing the two tabs located on the door.
4. Install the batteries as indicated in the receiver cover.
5. Close the battery door until the door tab snaps in place.
6. To install the receiver into a wall junction box, install the receiver with the screws provided.
7. If you decided to install the receiver into the appliance, reinstall the L-bracket.
8. Gently, install the slide switch back to the receiver stem.
9. The batteries should be replaced at least once every 6 months or when the battery indicator flashes.

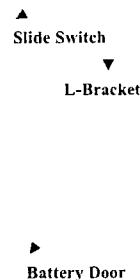

Connecting the Receiver to your appliance:

This system comes with an 18 inch wire assembly. Insert the white terminal to the back of the receiver. The terminal wire block can only be installed one way. Do not force the terminal plug onto the receiver.

Connect the wiring terminal two (2) 1/4" female spade terminals to the appliance. Refer to the appropriate Homeowner's Manual for proper wiring connections to the appliance. Your appliance may have other options to connect wiring from receiver. For applications longer than 18 inches, use 18 gauge wire, 105°C rated, with no splices. Connect to the two (2) 1/4" female spade wiring terminals. Wire can be no longer than 20 feet.

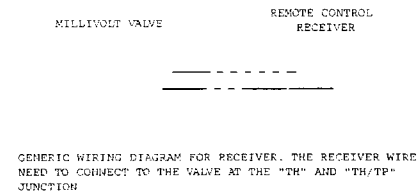

WARNING

Make sure that the wires do not contact the appliances any place other than at the terminals. Exposure to temperatures higher than 105°C (250°F) may cause the receiver to malfunction or fire hazard.

Remote Transmitter:

Installing Batteries:

The remote transmitter uses three (3) "AAA" - size batteries. To install batteries,

1. Press down the battery door tab and lift up and remove the battery door.
2. Install the batteries as indicated on transmitter.
3. Close the battery door by snapping in place.
4. The batteries should be replaced at least once every 6 months or when the battery indicator flashes.
5. Press down the battery door tab and lift up and remove the battery door.
6. When both batteries are installed, the transmitter will initialize for 10 seconds and then is ready for use.
7. The batteries should be replaced at least once every 6 months or when the battery icon indicator flashes.

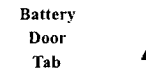

Back of the Transmitter

Setting Privacy (DIP) Switch on Receiver and Transmitter:

The remote receiver and transmitter privacy (DIP) switches are preset at the factory. In the event of activation or interference from other nearby transmissions, reset the code using the following procedure:

1. Slide the code switches on the transmitter or receiver to your choice of ON or OFF position. Switches #1, #3 and #4 are preset to "ON", and #2 is preset to "OFF" for both the transmitter and receiver.
2. The switches on the transmitter and receiver must match in order for the system to work.
3. To check, touch either the On or Off button on the transmitter and the receiver indicator light will blink. If not repeat step 2.
4. The system is now ready to operate.

Dip Switch (Default)



WARNING

Do not use two (2) or more remote control systems in the same area with the same dip switch settings, as they will communicate with each other. This may cause the appliances to malfunction.

Optional Auto Shutdown:

1. The transmitter comes preset from the factory with a 6 hour shutdown from its last ON operation. This is done to prevent the appliance from continuing to run if unattended.
2. You may disable this feature if you wish. To disable, change the transmitter privacy (DIP) switch #1 ONLY to the OFF position (by sliding the switch towards the battery door.) Make sure the receiver privacy (DIP) switches are set the same. Follow the instructions on how to set the privacy (DIP) switch setting.
3. By disabling this feature, your appliance may continue to run unattended.

Reset Button:

1. The reset button can be used to reset the transmitter if transmitter is not working properly. The reset button is located behind the battery door cover. Using a paper clip, press the reset button and the transmitter will reset and initialize for 10 seconds before it can be used.

OPERATIONS:

Transmitter:

General:

The RCST Remote Control has two (2) operating modes: Manual and Thermostatic. The control system can be set to temperature ranges between 45°F and 90°F.

The transmitter will operate the remote receiver from 1 foot to a maximum of 30 feet. The distance is reduced when batteries are low or when the receiver is inside a metal enclosure.

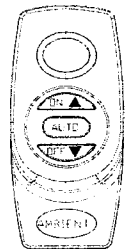

Initial start up:

1. After initial power up or when RESET button is pressed, the transmitter is reset. The reset button is located inside the battery door.
2. During system reset, all features of the LCD will be visible. After one second, the LCD will be initialized. A typical reset display is shown above. Note that the temperature scale is degree F.
3. Press On button to select between °C and °F display. It will exit setting mode automatically after 10 seconds if no key is pressed. The transmitter will send an Off signal after reset.
4. After reset the transmitter is operating in manual mode. The room temperature are shown as above.



Manual Mode:

1. Press the ON button once to turn on the appliance. Press the OFF button to turn it off.
2. In manual mode, the transmitter will not turn the appliance off even if the room temperature is above the target temperature.

Thermostatic mode:

1. Press the AUTO button to enter the thermostatic mode. "SET" temp icon will appear on the lower LCD screen
2. In thermostatic mode, press the ON/AUTO button or OFF/▽ button to set the desired set temperature.



- Once the setting is completed, the transmitter will automatically turn on the fireplace when the room temperature is below the set temperature and turn off the appliance when the room temperature is above the set temperature within 1 degree.
- There will be a slight delay in the response of the unit (on/off) to a temperature. Room temperature is monitored every 3 minutes.
- Press the Auto button to exit the thermostatic mode (Return to Manual Mode). The "SET" temp icon will disappear on the lower LCD display. The transmitter will be in the manual on/off mode.

Low-battery detection:

- Battery voltage is checked once a minute. When the battery voltage drops to a certain level, the low-battery warning will come on, and the transmitter will turn off the appliance. The transmitter will not function anymore until fresh batteries are installed.
- When the batteries are low, the LCD shows a low battery indicator. The low battery warning will be displayed in any mode.
- The transmitter will not operate with low batteries. Change the battery before the battery is too weak for normal operation. **TURN THE UNIT OFF BEFORE REPLACING BATTERIES.**



Child-proof protection:

- Press and hold ON and OFF buttons simultaneously for 3 seconds to enter child-proof mode.
- The transmitter will not work mode until child-proof mode is deactivated by pressing the ON and OFF buttons simultaneously for 3 seconds again to exit child-proof mode.



Transmitter Thermal Shutdown:

- If transmitter measures a room temperature exceeding 99 degrees Fahrenheit, the LCD will display "HI" and the transmitter will turn off the appliance.
- Transmitter will not function until the room temperature has dropped below 99 degree Fahrenheit.
- If transmitter measures a room temperature less than 40 degrees Fahrenheit, the LCD will display "LO" and **NO SIGNAL will be sent to turn on the appliance.**



Touch Light Transmitter Thermal Shutdown:

- If transmitter measures a room temperature exceeding 99 degrees Fahrenheit, the LCD will display "HI", emit three (3) beeps and send an off signal to turn off the appliance.
- Transmitter will not function until the room temperature has dropped below 99 degree Fahrenheit.
- If transmitter measures a room temperature less than 40 degrees Fahrenheit, the LCD will display "LO", and **no signals will be sent to turn on the appliance.**

Receiver:

Slide Switch:

- ON position: the system will remain on until the slide switch is placed in the OFF or RS position.
- RS position: the system will only operate if the remote receiver receives a signal from the transmitter.
- OFF position, the system is off. **The slide switch should be placed in the OFF position if you will be away for an extended period of time.** If the remote receiver is mounted out of children's reach, the OFF position also functions as a safety device by both turning the system off and rendering the receiver inoperable.

TESTING YOUR NEW REMOTE CONTROL SYSTEM

- Light your gas appliance following the appliance lighting instructions that came with the appliance. Confirm that the pilot light is on; it must be in operation for the remote control to operate the main gas valve. Appliance control knob must be in the ON position. Appliance ON/OFF switch must be in OFF position.
- Slide the 3 position button on the remote receiver to the ON position. The main gas flame should ignite.
- Slide the button to OFF. The flame should extinguish (the pilot light will remain on).
- Slide the button to RS (the center position), then touch the transmitter to turn the system to ON. The main gas flame should ignite.
- Press the transmitter to turn the system to OFF. The flame should extinguish (the pilot light will remain on).

TROUBLESHOOTING

Symptom	Causes	Action
1. LED light on receiver blinking or battery icon on LCD on transmitter. 2. LCD display is blank 3. LCD display shows "funny" display	1. Low Battery	1. Replace batteries. Change batteries every 6 months. 2. Check battery installation and replace batteries. 3. Press Reset button at the back of the transmitter.
4. Appliance does not come on.	1. Wiring / Electrical Connections 2. Privacy (DIP) switch setting on transmitter does not match receiver 3. Transmitter measures temperature exceeding 99 degrees Fahrenheit and shows "HI" on LCD 4. Distance between the transmitter and receiver is more than 20 feet	1. Slide the switch to ON, if appliance comes ON, wiring is not the cause. 2. If appliance does not come on, check wiring connections. 1. Make sure the transmitter and receiver have the same DIP switch settings. 1. Move transmitter to a cooler place and wait until temperature drops below 99 degree. 1. Make sure the operating distance is less than 20 feet
5. Receiver cannot receive signal.	1. Receiver is installed in an enclosure	1. Make sure the receiver is not located inside an enclosure.

WARNING: Changes or modifications to this unit not expressly approved by the party responsible for compliance could void the user's authority to operate the equipment.

NOTE: This equipment has been tested and found to comply with the limits for a Class B digital device, pursuant to Part 15 of the FCC Rules. These limits are designed to provide reasonable protection against harmful interference in a residential installation. This equipment generates, uses and can radiate radio frequency energy and, if not installed and used in accordance with instructions, may cause harmful interference to radio communications. However, there is no guarantee that interference will not occur in a particular installation. If this equipment does cause harmful interference to radio or television reception, which can be determined by turning the equipment off and on, the user is encouraged to try to correct the interference by one or more of the following measures:

- Reorient or relocate the receiving antenna.
- Increase the separation between the equipment and receiver.
- Connect the equipment into an outlet on a circuit different from that to which the receiver is connected.
- Consult the dealer or an experienced radio/TV technician for help

WARRANTY

This warranty gives you specific legal rights and you may also have other rights that vary from state to state or province to province. Answers to any questions regarding our limited warranty may be obtained by writing our corporate offices. Ambient Technologies warrants each new Ambient Technologies remote control against any defects that are due to faulty material or workmanship to the original owner, for a period of five years after the original date of purchase. This warranty and our liability does not apply to batteries, nor does it include damage to merchandise or the remote control resulting from accident, alteration, neglect, misuse, improper installation or any other failure to follow Ambient Technologies installation and operating instructions. Ambient Technologies agrees to repair or replace at its option any Ambient Technologies remote control under warranty provided it is returned postage prepaid to our warranty facility in a padded carton within the warranty period, with proof of the original date of purchase and a brief description of the malfunction. This limited warranty does not include the cost of removal or re-installation.

Ambient Technologies
149 Cleveland Drive
Paris KY 40361

FOR TECHNICAL SUPPORT
CALL 800-398-6195

50D0095 Rev 1 May 2005