



# RCSITEA

## Thermostatic On/Off, Flame Height Adjustment and Blower Remote Control– 120VAC

### INSTALLATION AND OPERATING INSTRUCTIONS

**CAUTION: The RCSITEA is only certified to be used on vented heater rated equipment.**

This remote control system provides a safe, reliable and user-friendly remote control for millivolt valve gas appliances, blower speed and flame height adjustment. The system can be manually or thermostatically turned on and off with the transmitter. Always check the appliance home owner's manual for additional information, or warnings regarding accessory installation before connecting this remote control system.

Carefully inspect the contents for shipping damage. If any parts are missing or damaged, immediately contact the dealer from whom you purchased the kit or Ambient Technologies Technical Support at 1 800 398 6195. Do not attempt to install any part of the kit unless all parts are in good condition. Please keep this booklet for future reference.

Please check the gas type of the unit to match the current

#### CONTENTS OF KIT

Description	Qty
Transmitter	1
Battery Alkaline AAA (for Transmitter)	3
Receiver (Assembly) consists of :	1
Receiver Box	
AC Adaptor for Receiver	
SIT Stepper Motor	1
Slide Button-Black (On/RS/Off)	1
Wall Cover Plate-Black	1
Wire Nuts	2
Plug-In Wiring Assembly for SIT mV Valve– 22” Inches	1
Plug-In Wiring Assembly for SIT Hi/Lo Regulator – 10” Inches	1
Velcro (Loop and Hook)	1
Installation Instructions	1
#8 Screw for sheet metal, Black	2

#### FEATURES/SPECIFICATIONS

- Easy Access Thermostatic Control
- Battery Powered Transmitter
- Low battery Indication for Transmitter
- Compact 120 VAC Adapter with 30” Wire
- Three Speed Control for Blower with Blower Type Selection
- Three Flame Height Settings
- Programmable Timer to Turn Blower on and Off
- Child Proof Lock-out
- 16 Security Codes
- 6 hour Shut Down (Optional) on Receiver

- Quick Disconnect Wiring Assembly
- Reset Button for transmitter

**WARNING**  
**Important Safety Information**

- Read this manual thoroughly prior to installing, programming or operating any remote control.
- This remote control system is designed for use with a millivolt gas valve system with blower. Do not use this remote control system on applications with voltages above 24 Volts AC/DC and 1 amp current.
- This remote control system requires three (3) “AAA” alkaline batteries to power the transmitter. The receiver is powered by external AC Adapter.
- Wiring must conform to appliance requirement and building codes/ordinances as required by local and national code authorities having jurisdiction.
- Do not short (or jumper) across the gas valve terminals to test the remote control installation. This could damage the unit and void the warranty.
- This remote control system should only be used as described in this manual. Any other use is not recommended and will void the warranty.

**NOTE**

**Due to the sensitive temperature monitoring components in the transmitter, it is necessary to allow the transmitter to stabilize to room temperature before accurate room temperatures are displayed. If the transmitter is activated from a severe cold condition, allow 15 minutes for accurate temperature readings to appear on the LCD display.**

**WARNING**

**Turn appliance OFF and allow to cool before installing or servicing. DO NOT connect 110-120 VAC wiring to the milli-volt gas control valve. The remote operator must be installed exactly as outlined in these instructions. Read all instructions completely before attempting installation. Follow instructions carefully during installation. Any modification of components will void the warranty and may cause a fire hazard.**

**WARNING**

**Turn appliance OFF (at the appliance or remote receiver) if you are away from your house for an extended period of time. Never leave anything on top of the surface of the transmitter.**

## INSTALLATIONS

### ***Remote Receiver:***

The remote receiver may be installed in the appliance per the appliance homeowner’s manual. **Refer to the Homeowner’s Manual for special installation instructions.** Failure to follow the installation instructions found in the appropriate Homeowner’s Manual will void the warranty and may cause a fire hazard.

This system comes with an 22 inch two-wire assembly labled “FOR MILLVOLT VALVE ONLY, TP/TH” and an 10 inch four-wire assembly labled “SIT VALVE ONLY”. Insert the white terminals into the back of the receiver. The terminal wire blocks can only be installed one way and do not force the terminal plugs into the receiver.

Connect the wiring terminal two (2) ¼” female spade terminals to the appliance valve and four-pin connector to SIT valve. Refer to the appropriate Homeowner’s Manual for proper wiring connections to the appliance. Your appliance may have other options to connect wiring from receiver. For applications longer than 22 inches, use 18 gauge wire, 105°C rated, with no splices. Connect to the two (2) ¼” female spade wiring terminals and wire can be no longer than 20 feet.

<b>WARNING</b>	<p><b>Speed control module and thermal sensor must be removed before installing receiver and applying the AC power. Failure to do so may cause the part damage and void the warranty. Without removing the control module and thermal sensor, they and RCSTEB both will try to operate the blower at the same and may cause unexpected blower operation or damage.</b></p>
----------------	--

Before connecting the blower with the receiver, always DISCONNECT SPEED CONTROL MODULE AND THERMAL SENSOR from your fireplace if they exist as displayed in following diagram:

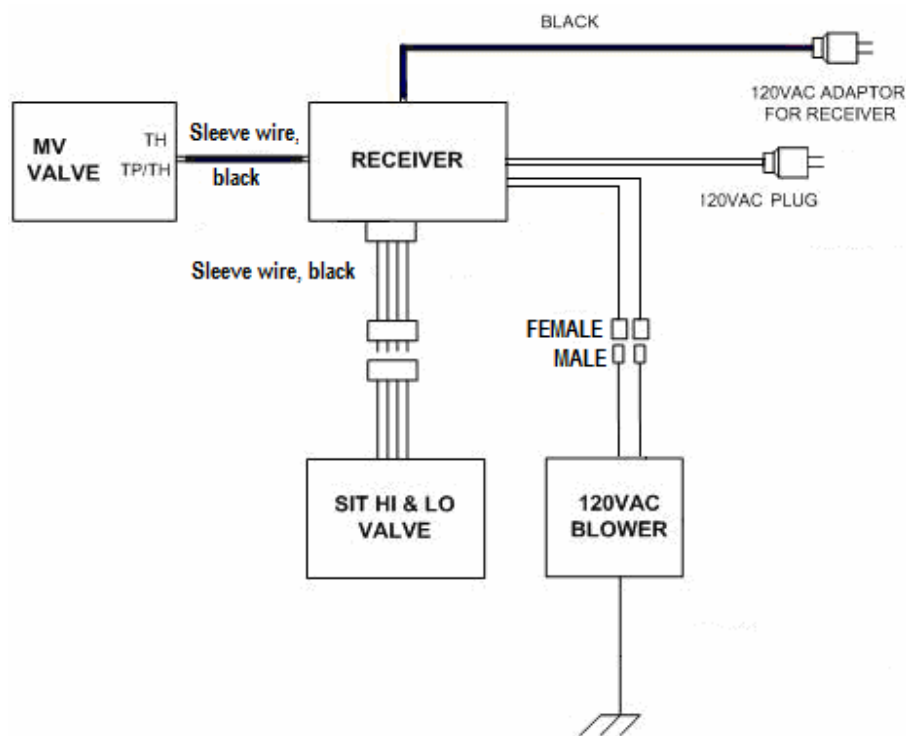

Connect the 30” long 18AWG wires labled “120VAC FAN ONLY” between receiver and blower as shown in the following diagram as well.

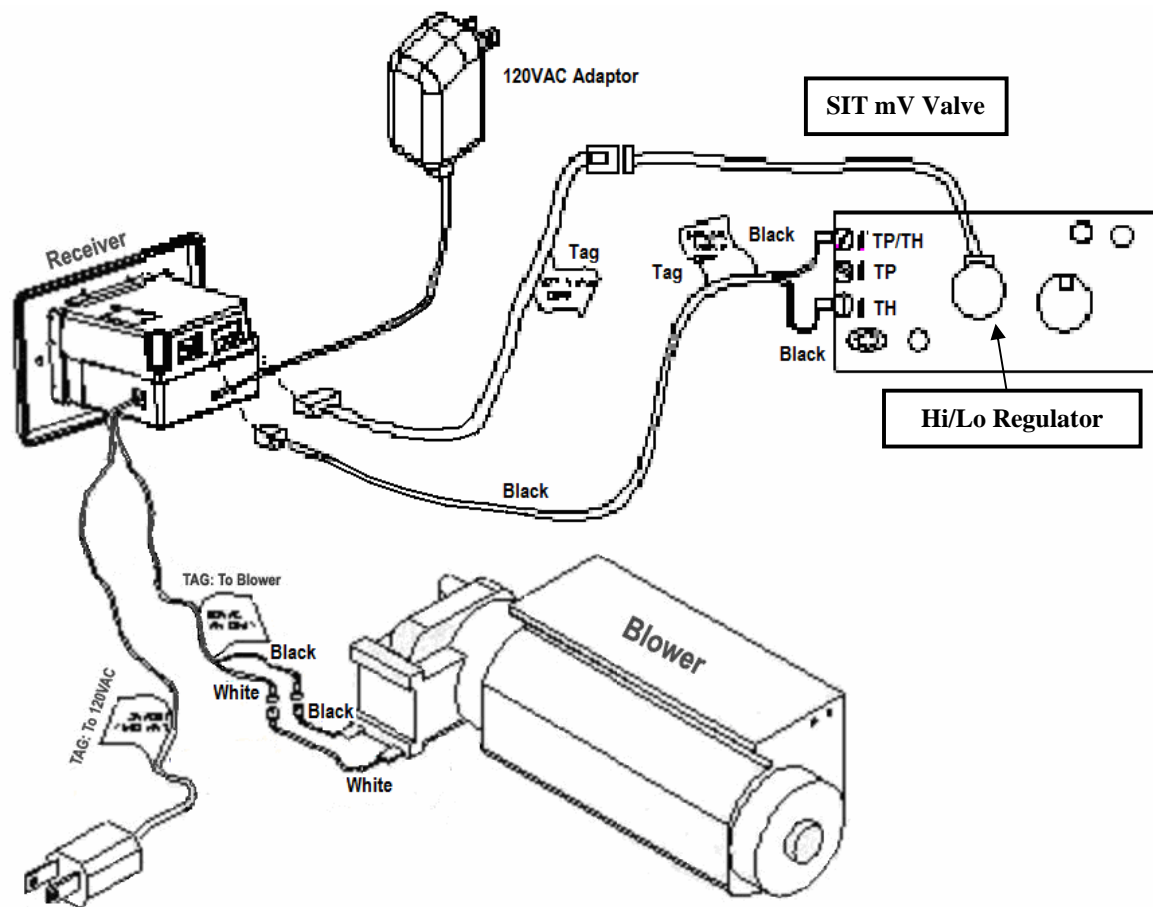

**WARNING**

**STOP: Make sure 120VAC fan and SIT valve are correct. If not wired correctly, this could cause damage to receiver.**

**Make sure that the wires do not contact the appliances any place other than at the terminals. Exposure to temperatures higher than 105C (250°F) may cause the receiver to malfunction and cause possible fire hazard.**

## Remote Transmitter:

### Installing Batteries:

The remote transmitter uses three (3) “AAA” batteries.  
To install batteries,

1. Press down the battery door tab and pull out to remove the battery door.
2. Install the batteries as indicated on transmitter.
3. Close the battery door by snapping in place.
4. When three batteries are installed, the transmitter will initialize for 10 seconds and then is ready for use.
5. The batteries should be replaced at least once every 6 months or when the low battery icon indicator is displayed.

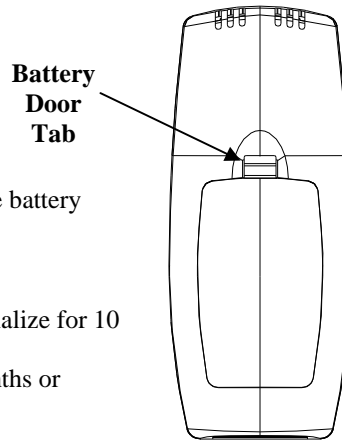

Back of the Transmitter

### Setting Privacy (DIP) Switch on Receiver and Transmitter:

The remote receiver and transmitter privacy (DIP) switches are preset at the factory. In the event of activation or interference from other nearby transmissions, reset the code using the following procedures:

1. There are four switches on the transmitter and seven switches on the receiver (see figure below). Switches #1, #2, #3 and #4 on both transmitter and receiver are privacy switches and #5, #6, #7 on the receiver are blower switches.
2. Slide the privacy code switches (#1, #2, #3 and #4) on the transmitter and receiver to your choice of ON or OFF position. All switches are preset to “ON” for both the transmitter and receiver.
3. The privacy code switches(#1, #2, #3 and #4) on the transmitter and on the receiver must match in order for the system to work.
4. To check, press either the On or Off button on the transmitter and the receiver indicator light will blink. If not repeat step 2.
5. The system is now ready to operate.

**NOTE** See the optional 6 hour shutdown section and the blower type selection section.

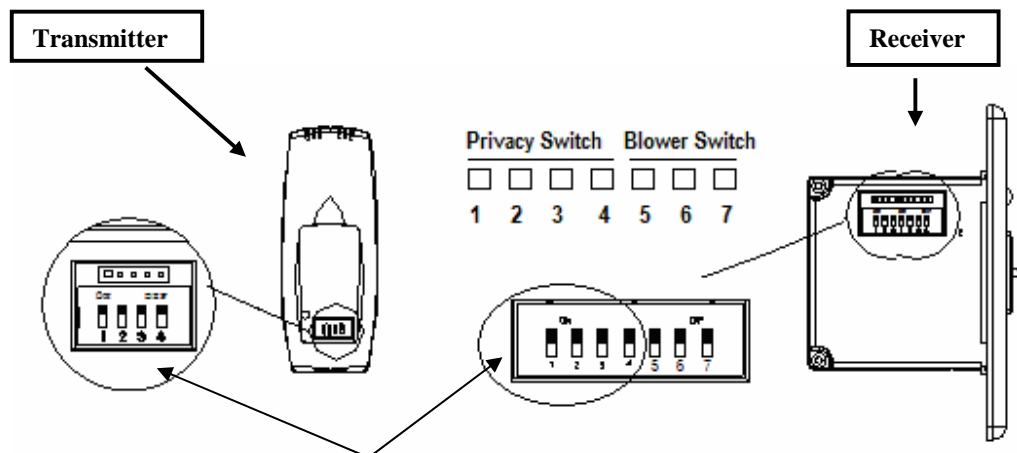

**WARNING**

**Do not use two (2) or more remote control systems in the same area with the same dip switch settings, as they will communicate with each other. This may cause the appliances to malfunction.**

Reset Button:

1. The reset button can be used to reset the transmitter if transmitter is not working properly. The reset button is located behind the battery door cover in the lower left corner of battery compartment. Using a paper clip, press the reset button and the transmitter will reset and initialize for 10 seconds before it can be used.

**OPERATIONS**

***Transmitter:***

General:

The RCSITEA Remote Control has two (2) operating modes: Manual and Thermostatic. The control system can be set to temperature ranges between 45°F and 90°F. The blower speed and flame height can be adjusted in either the manual and thermostatic mode.

The transmitter will operate the remote receiver from 1foot to a maximum of 30 feet. The distance is reduced when batteries are low or when the receiver is inside a metal enclosure.

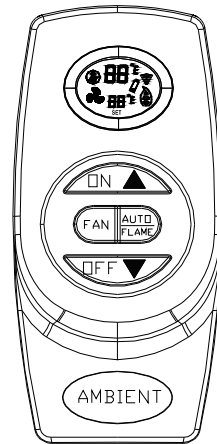

Initial Start-up:

1. After initial power up or when RESET button is pressed, the transmitter is reset. The reset button is located behind the battery door of transmitter.
2. During system reset, all features of the LCD DISPLAY will be visible. After one second, the LCD will be initialized. A typical reset display is shown above. Note that the temperature scale is degree F.
3. Press On button to select between °C and °F display. It will exit setting mode automatically after 10 seconds if no key is pressed. The transmitter will send an Off signal after reset.
4. After reset, the transmitter is operating in manual mode. The room temperature is shown as above.

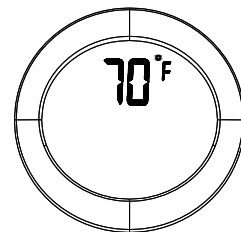

### Manual Mode:

1. Press the ON button once to turn on the appliance with max flame height.
2. Press the OFF button to decrease flame height. The first two pressing will decrease flame height to lower level. The third pressing will turn fireplace off.
3. If holding on OFF button for more than 3 second, fireplace will be shut off.

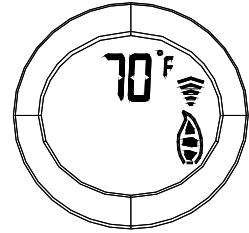

### Thermostatic Mode:

1. Press the AUTO/FLAME button to enter the thermostatic mode.
2. In thermostatic mode, press the ON / Δ button or OFF / ▽ button to set the desired set temperature.
3. Once the setting is completed, the transmitter will automatically turn on the fireplace when the room temperature is below the set temperature and turn off the appliance when the room temperature is above the set temperature within 1 degree.
4. There will be a slight delay in the response of the unit (on/off) to a temperature. Room temperature is monitored every 3 minutes.
5. Press the AUTO/FLAME button to exit the thermostatic mode. The transmitter will be in the manual off mode and the fireplace will be shut off.

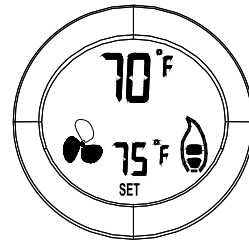

### 3-Speed Bower Control:

1. Press FAN button once to enter blower speed setup mode at low speed initially and one of the three blade icon will display darken on LCD display.
2. Continue to press FAN button to set up the blower speed you desire.
3. If there is no input within 3 seconds, the new setting will be transmitted to receiver. If fireplace is on, the blower speed will take effect right away; if fireplace is off, the receiver will remember this setting and blower is still off.
4. If you continue to press FAN button to the position that all blade is gone, the FAN icon will disappear and turn the blower off.

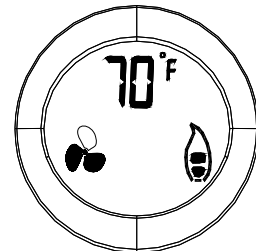

### Blower On Delay Time and Off Delay Time Setting:

1. Hold FAN button for 5 second and two numbers will show up in LCD screen. The upper one is On Delay Time and the bottom is Off Delay Time.
2. Use the ON / Δ button to set the desired On Delay Time from 0 to 15 min.
3. Use the OFF / ▽ button to set the desired Off Delay Time from 0 to 15 min.
4. If there is no input within 3 seconds, the new setting will be transmitted to receiver.
5. The default settings for both transmitter and receiver are 5 minutes for On Delay Time and 8 minutes for Off Delay Time, as shown in this picture.

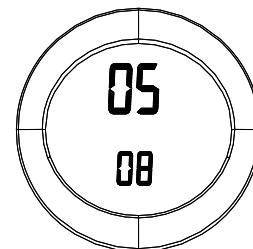

**NOTE** The most efficient setting for your fireplace blower is when blower comes on and off, it is blowing warm air only not hot air. Giving the fireplace as much time to discharge as much warm air as possible before turning off.

Flame Height Setting for Thermostatic Mode:

1. Hold AUTO/FLAME button for 5 second and one number and flame icon will show up in LCD screen, as show in the right figure.
2. Use the ON /  $\Delta$  or OFF /  $\nabla$  button to set the desired flame height to 1 (Min), 2 (Medium) and 3 (Max)
3. If there is no input within 3 seconds, the new setting will be transmitted to receiver. This setting only affects auto mode operation.
4. The default setting for transmitter is 2 (Medium), as shown in left picture.

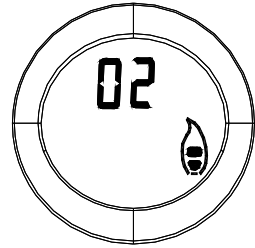

Low Battery Detection:

1. Battery voltage is checked once a minute. When the battery voltage drops to a certain level, the low-battery icon will display on LCD, and the transmitter **will turn off the appliance**. The transmitter will not function anymore until fresh batteries are installed.
2. When the batteries are low, the LCD displays a low battery indicator. The low battery indicator will be displayed in any mode.
3. The transmitter will not operate with low batteries. Change the batteries before the batteries are too weak for normal operation. **TURN THE UNIT OFF BEFORE REPLACING BATTERIES.**

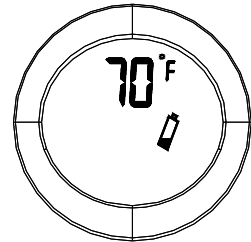

Child-Proof Protection:

1. Press and hold the ON and OFF buttons simultaneously for 3 seconds to enter childproof mode as shown in this picture.
2. The transmitter will not send a signal again until childproof mode is deactivated by pressing the ON and OFF buttons simultaneously for 3 seconds to exit childproof mode and the Childproof indicator disappears from LCD.

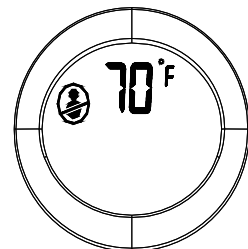

Transmitter Thermal Shutdown:

1. If transmitter measures a room temperature exceeding 99 degrees Fahrenheit, the LCD will display "HI" and the transmitter will turn off the appliance.
2. Transmitter will not function until the room temperature has dropped below 99 degree Fahrenheit. If transmitter measures a room temperature less than 40 degrees Fahrenheit, the LCD will display "LO" and **NO SIGNAL will be sent to turn on the appliance.**

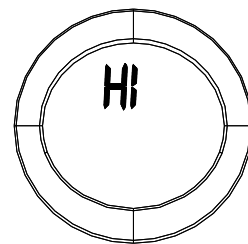

**Receiver:**

Slide Switch:

1. ON position: the main burner will ignite and blower will come on when Blower on Delay Time is reached and fan speed has been enabled, the flame height is max; otherwise just burner will ignite until the slide switch is placed in the OFF or RS position to turn burner off.
2. RS position: the system will only operate if the remote receiver receives a signal from the transmitter.



3. OFF position, the system is off. If fan speed has been enabled blower will continue to operate until Off Delay Time expires. **The slide switch should be placed in the OFF position if you will be away for an extended period of time.** If the remote receiver is mounted out of children's reach, the OFF position also functions as a safety device by both turning the system off and rendering the receiver inoperable.

#### Blower Type Selection:

1. The remote control can work with different type/size of blowers. The three levels of blower speeds (High/Medium/Low) can be fine tuned using the blower switches. See figure in the Setting Privacy (DIP) Switch section.
2. In the event that the blower runs too slow or too fast on Low or Medium, change the blower switch setting to achieve desired speed levels.
3. Turn on the blower at Low speed with the transmitter and follow the following sequence to set up the blower switches. The blower speed will decrease when going through this sequence.
  - (Switch 5) OFF/(Switch 6) OFF/(Switch 7) ON
  - (Switch 5) **OFF**/(Switch 6) ON/(Switch 7) ON
  - (Switch 5) ON/(Switch 6) **OFF**/(Switch 7) ON (same effect as the preset ON/ON/ON)
  - (Switch 5) ON/(Switch 6) ON/(Switch 7) **OFF**

#### **WARNING**

**To avoid overheating the blower when the blower runs too slow, always start from higher speed when adjusting speed levels using the blower switches. And stop trying the rest settings when desired speed level of Low is achieved.**

#### Optional 6 Hour Shutdown:

4. The receiver comes preset from the factory with a 6 hour shutdown from its last ON or flamer lower operation. This is done to prevent the appliance from continuing to run if unattended.
5. You may disable this feature if you wish. To disable, change the receiver privacy (DIP) switch #1 to the OFF position. Make sure the transmitter privacy (DIP) switches are set the same as the receiver. Follow the instructions on how to set the privacy (DIP) switch setting.
6. **By disabling this feature, your appliance may continue to run unattended.**

#### Optional Wall Cover Plate:

1. Receiver snaps into wall cover plate. The wall plate is mounted by using 2 screws provided.

### **TESTING YOUR NEW REMOTE CONTROL SYSTEM**

1. Light your gas appliance following the appliance lighting instructions that came with the appliance. Confirm that the pilot light is on; it must be in operation for the remote control to operate the main gas valve and blower. Appliance control knob must be in the ON position, and appliance ON/OFF switch must be in OFF position.
2. Slide the 3 position button on the remote receiver to the ON position and the main gas flame should ignite.
3. Slide the button to OFF and the main gas flame should extinguish, but the pilot light will remain on.
4. Slide the button to RS (the center position), then press the ON button on transmitter to turn the system ON. The main gas flame should ignite and blower should come on after the On Delay Time is reached and fan speed you desire is selected.
5. Press the OFF button on transmitter to turn the system to OFF. The flame should extinguish (the pilot light will remain on) and blower should be off after the Off Delay Time you set.

## TROUBLESHOOTING

Symptom	Causes	Action
1. Battery icon on LCD on transmitter. 2. LCD display is blank 3. LCD display shows “funny” display	1. Low Battery	1. Replace batteries. Change batteries every 6 months. 2. Check battery installation or replace batteries. 3. Press Reset button at the back of the transmitter.
4. Appliance does not come on.	1. Wiring / Electrical Connections	1. Slide the switch to ON, if appliance comes ON, wiring is not the cause. 2. If appliance does not come on, check wiring connections.
	2. Privacy (DIP) switch setting on transmitter does not match receiver	1. Make sure the transmitter and receiver have the same DIP switch settings.
	3. Transmitter measures temperature exceeding 99 degrees Fahrenheit and shows “HI” on LCD	1. Move transmitter to a cooler place and wait until temperature drops below 99 degree.
	4. Distance between the transmitter and receiver is more than 30 feet	1. Make sure the operating distance is less than 30 feet
5. Receiver cannot receive signal.	1. Receiver is installed in an enclosure	1. Make sure the receiver is not located inside to tight of an enclosure.
6. Blower is not on after the fireplace is turned on	1. Blower setting is off 2. Blower delay setting is set too high	1. Press FAN key to select Fan speed you desire. 2. Press and hold FAN key to set desired ON/OFF delays. This is done in minutes.

**WARNING:** Changes or modifications to this unit not expressly approved by the party responsible for compliance could void the user’s authority to operate the equipment.

**NOTE:** This equipment has been tested and found to comply with the limits for a Class B digital device, pursuant to Part 15 of the FCC Rules. These limits are designed to provide reasonable protection against harmful interference in a residential installation. This equipment generates uses and can radiate radio frequency energy and, if not installed and used in accordance with instructions, may cause harmful interference to radio communications. However, there is no guarantee that interference will not occur in a particular installation. If this equipment does cause harmful interference to radio or television reception, which can be determined by turning the equipment off and on, the user is encouraged to try to correct the interference by one or more of the following measures:

- Reorient or relocate the receiving antenna.
- Increase the separation between the equipment and receiver.
- Connect the equipment into an outlet on a circuit different from that to which the receiver is connected.
- Consult the dealer or an experienced radio/TV technician for help.

## **WARRANTY**

This warranty gives you specific legal rights and you may also have other rights that vary from state to state or province to province. Answers to any questions regarding our limited warranty may be obtained by writing our corporate offices.

Ambient Technologies warrants each new Ambient Technologies remote control against any defects that are due to faulty material or workmanship to the original owner, for a period of five years after the original date of purchase. This warranty and our liability does not apply to batteries, nor does it include damage to merchandise or the remote control resulting from accident, alteration, neglect, misuse, improper installation or any other failure to follow Ambient Technologies installation and operating instructions.

After contacting Ambient Technologies Tech Service to receive a return authorization number, we agree to repair or replace at our option any Ambient Technologies remote control under warranty. Provided it is returned postage prepaid to our warranty facility in a padded carton within the warranty period, with proof of the original date of purchase and a brief description of the malfunction. This limited warranty does not include the cost of removal or re-installation.

Ambient Technologies  
149 Cleveland Drive  
Paris KY 40361

**FOR TECHNICAL SUPPORT  
CALL 800-398-6195**