

FCC PART 15 SUBPART C TEST REPORT

FCC PART 15.247

Report Reference No.....: **WE10100017**

FCC ID.....: **D12AEP3081**

Compiled by

(position+printed name+signature)..: File administrators Wenliang Li

Supervised by

(position+printed name+signature)..: Test Engineer Eric Zhang

Approved by

(position+printed name+signature)..: Manager Jimmy Li

Date of issue.....: Nov 11, 2010

Testing Laboratory Name: **Shenzhen Huatongwei International Inspection Co., Ltd**

Address: Keji Nan No.12 Road, Hi-tech Park, Shenzhen, China

Applicant's name: **Computime Ltd.**

Address: 17/F, Great Eagle Centre, 23 Harbour Road, Wanchai, Hong Kong

Test specification:

Standard: **FCC Part 15.247: Operation within the bands 920-928 MHz, 2400-2483.5 MHz and 5725-5850 MHz Direct Sequence System**

TRF Originator.....: Shenzhen Huatongwei International Inspection CO., Ltd

Master TRF.....: Dated 2006-06

Shenzhen Huatongwei International Inspection Co., Ltd. All rights reserved.

This publication may be reproduced in whole or in part for non-commercial purposes as long as the Shenzhen Huatongwei International Inspection Co., Ltd is acknowledged as copyright owner and source of the material. Shenzhen Huatongwei International Inspection Co., Ltd takes no responsibility for and will not assume liability for damages resulting from the reader's interpretation of the reproduced material due to its placement and context.

Test item description: In Home Display

Trade Mark: /

Model/Type reference.....: AEP3081

Listed Models: /

Result.....: **Positive**

TEST REPORT

Test Report No. :	WE10100017	Nov 11, 2010
		Date of issue

Equipment under Test : In Home Display

Model /Type : AEP3081

Listed Models : /

Applicant : **Computime Ltd.**

Address : 17/F, Great Eagle Centre, 23 Harbour Road, Wanchai,
Hong Kong

Manufacturer : **Computime Ltd.**

Address : Computime Technology Park. Dan Zhu Tou Cun,BuJi
Longgang Region ShenZhen,GuangDong

Test Result according to the standards on page 4:	Positive
--	-----------------

The test report merely corresponds to the test sample.
It is not permitted to copy extracts of these test result without the written permission of the test laboratory.

Contents

1.	<u>TEST STANDARDS</u>	<u>4</u>
2.	<u>SUMMARY</u>	<u>5</u>
2.1.	General Remarks	5
2.2.	Equipment Under Test	5
2.3.	Short description of the Equipment under Test (EUT)	5
2.4.	EUT operation mode	5
2.5.	EUT configuration	6
2.6.	Related Submittal(s) / Grant (s)	6
2.7.	Modifications	6
2.8.	NOTE	6
3.	<u>TEST ENVIRONMENT.....</u>	<u>6</u>
3.1.	Address of the test laboratory	7
3.2.	Test Facility	7
3.3.	Environmental conditions	8
3.4.	Configuration of Tested System	8
3.5.	Test Description	8
3.6.	Statement of the measurement uncertainty	9
3.7.	Equipments Used during the Test	9
4.	<u>TEST CONDITIONS AND RESULTS.....</u>	<u>11</u>
4.1.	AC Power Conducted Emission	11
4.2.	Radiated Emission	14
4.3.	Maximum Peak Output Power	21
4.4.	Power Spectral Density	22
4.5.	Band Edge Compliance of RF Emission	25
4.6.	Spurious RF Conducted Emission	30
4.7.	6dB Bandwidth	33
4.8.	Antenna Requirement	37
5.	<u>TEST SETUP PHOTOS OF THE EUT</u>	<u>38</u>
6.	<u>EXTERNAL AND INTERNAL PHOTOS OF THE EUT</u>	<u>39</u>

1. TEST STANDARDS

The tests were performed according to following standards:

[FCC Rules Part 15.247](#): Frequency Hopping, Direct Spread Spectrum and Hybrid Systems that are in operation within the bands of 902-928 MHz, 2400-2483.5 MHz, and 5725-5850 MHz.

[ANSI C63.4-2009](#): American National Standard for Methods of Measurement of Radio-Noise Emissions From Low Voltage Electrical and Electronic Equipment in the Range of 9kHz to 40GHz.

[ANSI C63.10-2009](#): American National Standard for Testing Unlicensed Wireless Devices

2. SUMMARY

2.1. General Remarks

Date of receipt of test sample : Oct 26, 2010

Testing commenced on : Nov 05, 2010

Testing concluded on : Nov 11, 2010

2.2. Equipment Under Test

Power supply system utilised

Power supply voltage : 120V / 60 Hz 115V / 60Hz
 12 V DC 24 V DC
 Other (specified in blank below)

DC 5V from AC Adapter

2.3. Short description of the Equipment under Test (EUT)

2.4GHz (In Home Display (AEP3081)) For more details, refer to the user's manual of the EUT.

Serial number: Prototype

2.4. EUT operation mode

The EUT has been tested under typical operating condition. The Applicant provides AT command to control the EUT for staying in continuous transmitting and receiving mode for testing. There are sixteen channels of EUT, and the test carried out at the channel 11(lowest), channel 18(middle) and channel 26 (highest) channels.

Channel	Frequency	Channel	Frequency
11	2405 MHz	19	2445 MHz
12	2410 MHz	20	2450 MHz
13	2415 MHz	21	2455 MHz
14	2420 MHz	22	2460 MHz
15	2425 MHz	23	2465 MHz
16	2430 MHz	24	2470 MHz
17	2435 MHz	25	2475 MHz
18	2440 MHz	26	2480 MHz

3. TEST ENVIRONMENT

3.1. Address of the test laboratory

Shenzhen Huatongwei International Inspection Co., Ltd
Keji Nan No.12 Road, Hi-tech Park, Shenzhen, China
Phone: 86-755-26715686 Fax: 86-755-26748089

The sites are constructed in conformance with the requirements of ANSI C63.7, ANSI C63.4 (2009) and CISPR Publication 22.

3.2. Test Facility

The test facility is recognized, certified, or accredited by the following organizations:

CNAS-Lab Code: L1225

Shenzhen Huatongwei International Inspection Co., Ltd has been assessed and proved to be in compliance with CNAS-CL01 Accreditation Criteria for Testing and Calibration Laboratories (identical to ISO/IEC 17025: 2005 General Requirements) for the Competence of Testing and Calibration Laboratories, Date of Registration: August 02, 2007. Valid time is until March 29, 2012.

A2LA-Lab Cert. No. 2243.01

Shenzhen Huatongwei International Inspection Co., Ltd, EMC Laboratory has been accredited by A2LA for technical competence in the field of electrical testing, and proved to be in compliance with ISO/IEC 17025: 2005 General Requirements for the Competence of Testing and Calibration Laboratories and any additional program requirements in the identified field of testing. Valid time is from Aug 24, 2005 to Oct 31, 2009.

FCC-Registration No.: 662850

Shenzhen Huatongwei International Inspection Co., Ltd, EMC Laboratory has been registered and fully described in a report filed with the FCC (Federal Communications Commission). The acceptance letter from the FCC is maintained in our files. Registration 662850, Renewal date July 01, 2009.

IC-Registration No.: 5377

The 3m Alternate Test Site of Shenzhen Huatongwei International Inspection Co., Ltd has been registered by Certification and Engineering Bureau of Industry Canada for the performance of radiated measurements with Registration No. 5377 on February 13th, 2011.

ACA

Shenzhen Huatongwei International Inspection Co., Ltd, EMC Laboratory can also perform testing for the Australian C-Tick mark as a result of our A2LA accreditation.

NEMKO-Aut. No.: ELA125

Shenzhen Huatongwei International Inspection Co., Ltd has been assessed the quality assurance system, the testing facilities, qualifications and testing practices of the relevant parts of the organization. The quality assurance system of the Laboratory has been validated against ISO/IEC 17025:2005 or equivalent. The laboratory also fulfils the conditions described in Nemko Document NLA-10, the Authorization is valid through April 25, 2009.

VCCI

The 3m Semi-anechoic chamber (12.2m×7.95m×6.7m) and Shielded Room (8m×4m×3m) of Shenzhen Huatongwei International Inspection Co., Ltd has been registered in accordance with the Regulations for Voluntary Control Measures with Registration No.: R-2484. Date of Registration: December 20, 2006. Valid time is until December 19, 2009.

Main Ports Conducted Interference Measurement of Shenzhen Huatongwei International Inspection Co., Ltd has been registered in accordance with the Regulations for Voluntary Control Measures with Registration No.: C-2726. Date of Registration: December 20, 2006. Valid time is until December 19, 2009.

DNV

Shenzhen Huatongwei International Inspection Co Ltd has been found to comply with the requirements of DNV towards subcontractor of EMC and safety testing services in conjunction with the EMC and Low voltage Directives and in the voluntary field. The acceptance is based on a formal quality Audit and follow-ups according to relevant parts of ISO/IEC Guide 17025(2005), in accordance with the requirements of the DNV Laboratory Quality Manual towards subcontractors. Valid time is until 24 Aug, 2013.

3.3. Environmental conditions

During the measurement the environmental conditions were within the listed ranges:

Temperature:	<u>15-35 ° C</u>
Humidity:	<u>30-60 %</u>
Atmospheric pressure:	<u>950-1050mbar</u>

3.4. Configuration of Tested System

Fig. 2-1 Configuration of Tested System

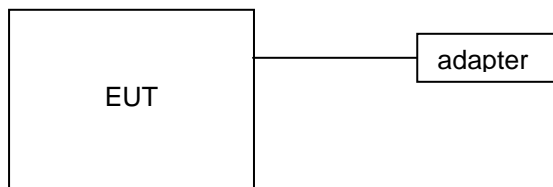

3.5. Test Description

FCC PART 15		
FCC Part 15.207	AC Power Conducted Emission	PASS
FCC Part 15.247(a)(2)	6dB Bandwidth	PASS
FCC Part 15.247(d)	Spurious RF Conducted Emission	PASS
FCC Part 15.247(b)	Maximum Peak Output Power	PASS
FCC Part 15.247(e)	Power Spectral Density	PASS
FCC Part 15.109/ 15.205/ 15.209	Radiated Emissions	PASS
FCC Part 15.247(d)	Band Edge Compliance of RF Emission	PASS
FCC Part 15.203/15.247 (b)	Antenna Requirement	PASS
FCC Part 1.1307 (b)	MPE Evaluation	PASS

Remark: The measurement uncertainty is not included in the test result.

Preliminary tests were performed in different data rate to find the worst radiated emission. The data rate shown in the table below is the worst-case rate with respect to the specific test item. Investigation has been done on all the possible configurations for searching the worst cases. The following table is a list of the test modes shown in this test report.

Test Items	Mode	Channel
Maximum Peak Conducted Output Power Power Spectral Density 6dB Spectrum Bandwidth Spurious RF conducted emissions	Zigbee	11/18/26
Radiated Emissions 9kHz~1GHz	Zigbee	11/18/26
Radiated Emissions 1GHz~10th Harmonic	Zigbee	11/18/26
Band Edge Emissions	Zigbee	11/26

3.6. Statement of the measurement uncertainty

The data and results referenced in this document are true and accurate. The reader is cautioned that there may be errors within the calibration limits of the equipment and facilities. The measurement uncertainty was calculated for all measurements listed in this test report acc. to CISPR 16 - 4 „Specification for radio disturbance and immunity measuring apparatus and methods – Part 4: Uncertainty in EMC Measurements“ and is documented in the Shenzhen Huatongwei International Inspection Co., Ltd quality system acc. to DIN EN ISO/IEC 17025. Furthermore, component and process variability of devices similar to that tested may result in additional deviation. The manufacturer has the sole responsibility of continued compliance of the device.

Hereafter the best measurement capability for Shenzhen Huatongwei laboratory is reported:

Test	Range	Measurement Uncertainty	Notes
Radiated Emission	30~1000MHz	4.24 dB	(1)
Radiated Emission	1~18GHz	5.16 dB	(1)
Radiated Emission	18-40GHz	5.54 dB	(1)
Conducted Disturbance	0.15~30MHz	3.39 dB	(1)

(1) This uncertainty represents an expanded uncertainty expressed at approximately the 95% confidence level using a coverage factor of k=2.

3.7. Equipments Used during the Test

Radiated Emission					
Item	Test Equipment	Manufacturer	Model No.	Serial No.	Last Cal.
1	ULTRA-BROADBAND ANTENNA	ROHDE & SCHWARZ	HL562	100015	2010/05/30
2	EMI TEST RECEIVER	ROHDE & SCHWARZ	ESI 26	100009	2010/10/24
3	RF TEST PANEL	ROHDE & SCHWARZ	TS / RSP	335015/ 0017	2010/10/24
4	TURNTABLE	ETS	2088	2149	2010/10/24
5	ANTENNA MAST	ETS	2075	2346	2010/10/24
6	EMI TEST SOFTWARE	ROHDE & SCHWARZ	ESK1	N/A	2010/10/24
7	HORN ANTENNA	ROHDE &SCHWARZ	HF906	100039	2010/11/01
8	Amplifier	Sonoma	310N	E009-13	2010/10/24
9	JS amplifier	ROHDE &SCHWARZ	JS4-00101800-28-5A	F201504	2010/11/01
10	High pass filter	Compliance Direction systems	BSU-6	34202	2010/03/28

Maximum Peak Output Power / Power Spectral Density / 6dB Bandwidth / Spurious RF Conducted Emission					
Item	Test Equipment	Manufacturer	Model No.	Serial No.	Last Cal.
1	EMI TEST RECEIVER	ROHDE & SCHWARZ	ESI 26	100009	2010/10/24
2	Power Meter	Anritsu	ML2487A	6K00001568	2010/11/01
3	Power Meter Sensor	Anritsu	ML2491A	0630989	2010/11/01

Conducted emission					
Item	Test Equipment	Manufacturer	Model No.	Serial No.	Last Cal.
1	EMI Test Receiver	Rohde&Schwarz	ESCI	100106	2010/10/24
2	Artificial Mains	Rohde&Schwarz	ESH2-Z5	100028	2010/10/24
3	Pulse Limiter	Rohde&Schwarz	ESHSZ2	100044	2010/10/24
4	EMI Test Software	Rohde&Schwarz	ESK1	N/A	2010/10/24
5	Single Balanced Telecom Pair ISN	FCC	FCC-TLISN-T2-02	20371	2010/10/24
6	Two Balanced Telecom Pairs ISN	FCC	FCC-TLISN-T4-02	20373	2010/10/24

4. TEST CONDITIONS AND RESULTS

4.1. AC Power Conducted Emission

TEST CONFIGURATION

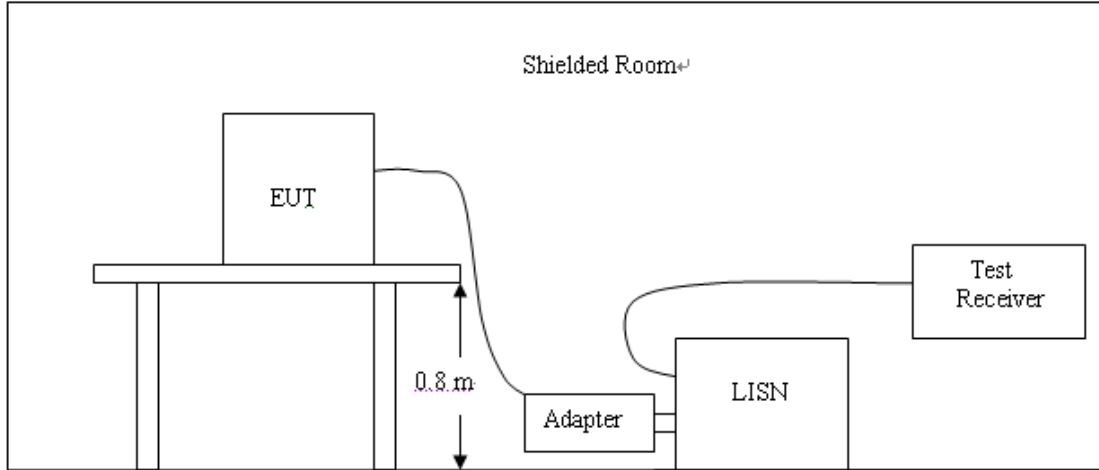

TEST PROCEDURE

- 1 The equipment was set up as per the test configuration to simulate typical actual usage per the user's manual. The EUT is a tabletop system, a wooden table with a height of 0.8 meters is used and is placed on the ground plane as per ANSI C63.4-2009.
- 2 Support equipment, if needed, was placed as per ANSI C63.4-2009
- 3 All I/O cables were positioned to simulate typical actual usage as per ANSI C63.4-2009
- 4 The EUT received DC 5V power from the adapter, the adapter received AC120V/60Hz power through a Line Impedance Stabilization Network (LISN) which supplied power source and was grounded to the ground plane.
- 5 All support equipments received AC power from a second LISN, if any.
- 6 The EUT test program was started. Emissions were measured on each current carrying line of the EUT using a spectrum Analyzer / Receiver connected to the LISN powering the EUT. The LISN has two monitoring points: Line 1 (Hot Side) and Line 2 (Neutral Side). Two scans were taken: one with Line 1 connected to Analyzer / Receiver and Line 2 connected to a 50 ohm load; the second scan had Line 1 connected to a 50 ohm load and Line 2 connected to the Analyzer / Receiver.
- 7 Analyzer / Receiver scanned from 150 KHz to 30MHz for emissions in each of the test modes.
- 8 During the above scans, the emissions were maximized by cable manipulation.

AC Power Conducted Emission Limit

For intentional device, according to § 15.207(a) AC Power Conducted Emission Limits is as following :

Frequency (MHz)	Maximum RF Line Voltage (dBµV)			
	CLASS A		CLASS B	
	Q.P.	Ave.	Q.P.	Ave.
0.15 - 0.50	79	66	66-56*	56-46*
0.50 - 5.00	73	60	56	46
5.00 - 30.0	73	60	60	50

* Decreasing linearly with the logarithm of the frequency

TEST RESULTS

SCAN TABLE: "Voltage (9K-30M)FIN"

Short Description: 150K-30M Voltage

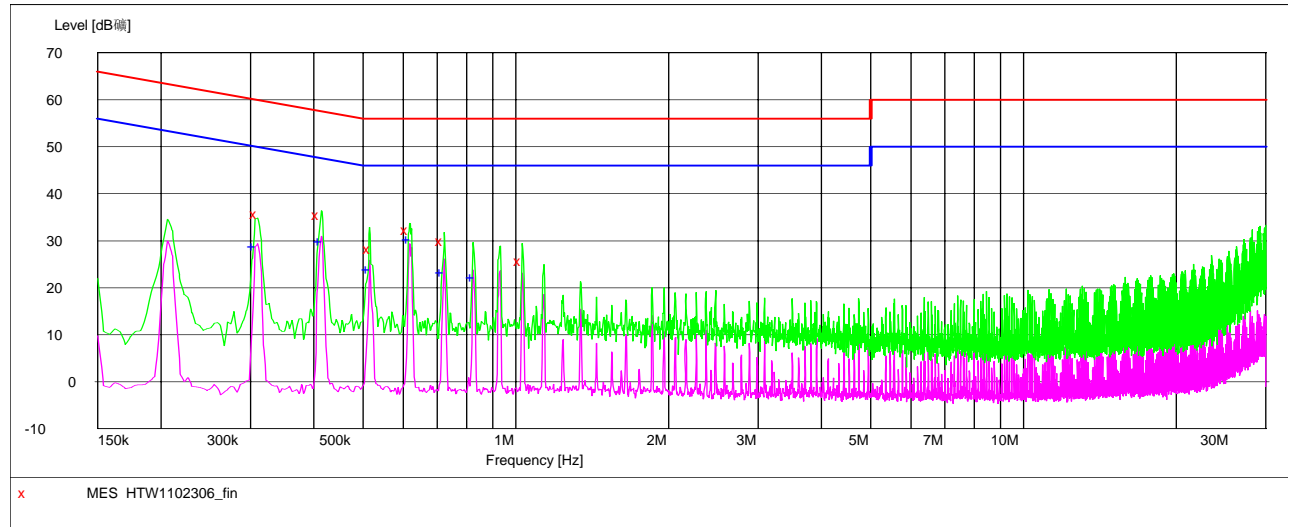

MEASUREMENT RESULT: "HTW1102306_fin"

11/2/2010 8:56AM

Frequency MHz	Level dBμV	Transd dB	Limit dBμV	Margin dB	Detector	Line	PE
0.310000	35.70	10.5	60	24.3	QP	L1	GND
0.410000	35.50	10.4	58	22.1	QP	L1	GND
0.518000	28.20	10.4	56	27.8	QP	L1	GND
0.614000	32.20	10.4	56	23.8	QP	L1	GND
0.718000	29.90	10.4	56	26.1	QP	L1	GND
1.026000	25.60	10.5	56	30.4	QP	L1	GND

MEASUREMENT RESULT: "HTW1102306_fin2"

11/2/2010 8:56AM

Frequency MHz	Level dBμV	Transd dB	Limit dBμV	Margin dB	Detector	Line	PE
0.306000	28.90	10.5	50	21.2	AV	L1	GND
0.414000	29.80	10.4	48	17.8	AV	L1	GND
0.514000	24.00	10.4	46	22.0	AV	L1	GND
0.618000	30.40	10.4	46	15.6	AV	L1	GND
0.718000	23.40	10.4	46	22.6	AV	L1	GND
0.826000	22.20	10.4	46	23.8	AV	L1	GND

SCAN TABLE: "Voltage (9K-30M)FIN"

Short Description: 150K-30M Voltage

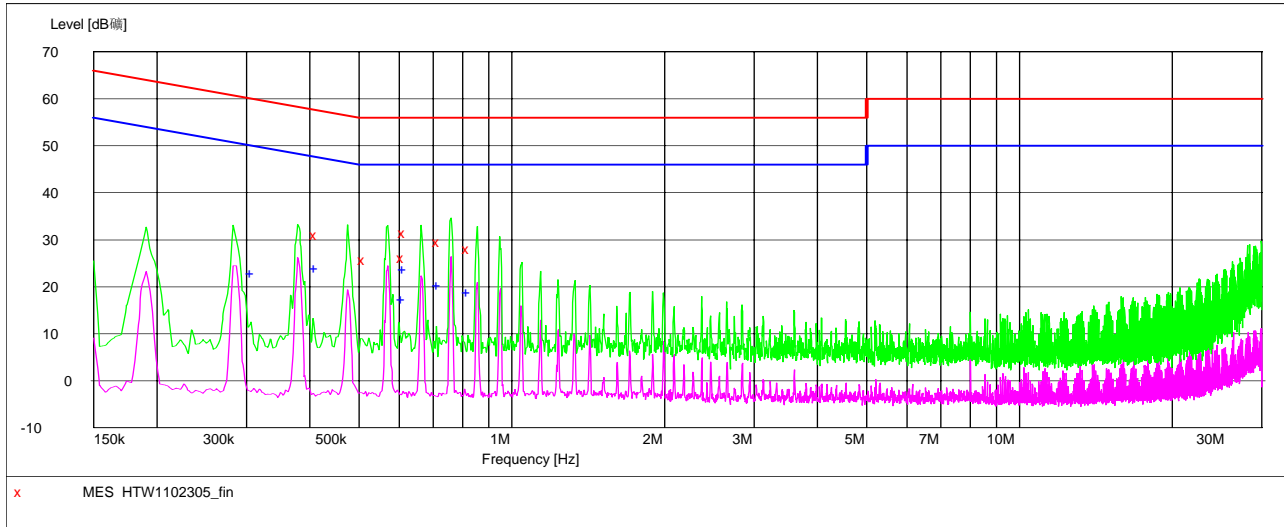

MEASUREMENT RESULT: "HTW1102305_fin"

11/2/2010 8:53AM

Frequency MHz	Level dBμV	Transd dB	Limit dBμV	Margin dB	Detector	Line	PE
0.414000	31.00	10.4	58	26.6	QP	N	GND
0.514000	25.70	10.4	56	30.3	QP	N	GND
0.614000	26.20	10.4	56	29.8	QP	N	GND
0.618000	31.40	10.4	56	24.6	QP	N	GND
0.722000	29.40	10.4	56	26.6	QP	N	GND
0.826000	28.10	10.4	56	27.9	QP	N	GND

MEASUREMENT RESULT: "HTW1102305_fin2"

11/2/2010 8:53AM

Frequency MHz	Level dBμV	Transd dB	Limit dBμV	Margin dB	Detector	Line	PE
0.310000	23.00	10.5	50	27.0	AV	N	GND
0.414000	24.00	10.4	48	23.6	AV	N	GND
0.614000	17.50	10.4	46	28.5	AV	N	GND
0.618000	23.70	10.4	46	22.3	AV	N	GND
0.722000	20.40	10.4	46	25.6	AV	N	GND
0.826000	18.80	10.4	46	27.2	AV	N	GND

4.2. Radiated Emission

TEST CONFIGURATION

(a) Radiated Emission Test Set-Up, Frequency below 1000MHz

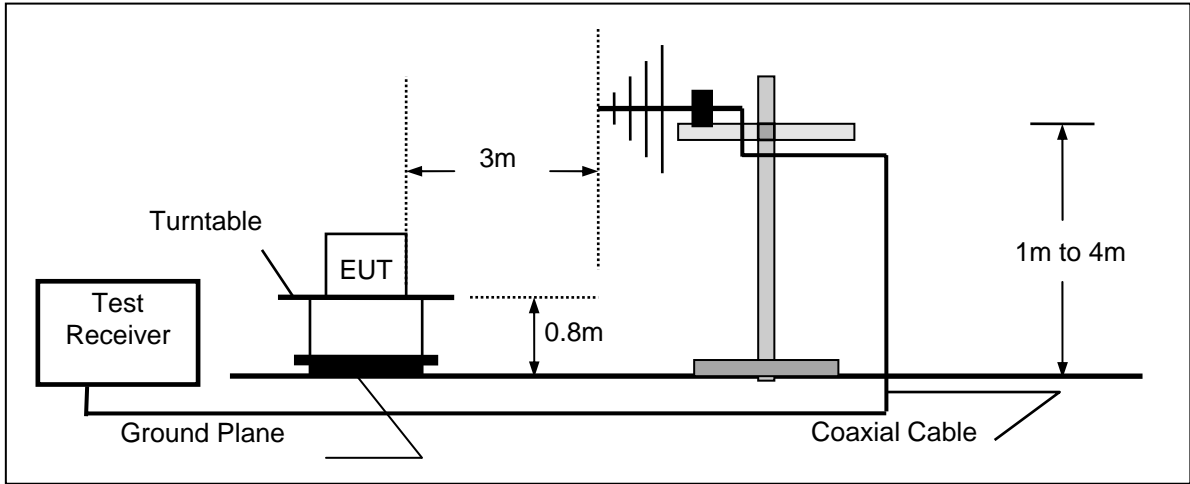

(b) Radiated Emission Test Set-Up, Frequency above 1000MHz

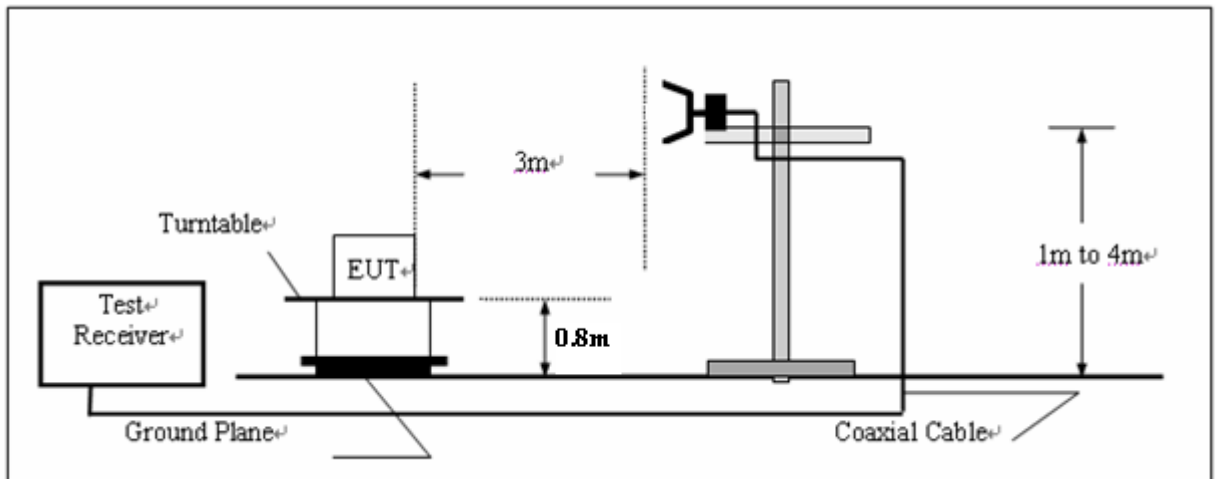

TEST PROCEDURE

- 1 The EUT was placed on a turn table which is 0.8m above ground plane.
- 2 Maximum procedure was performed by raising the receiving antenna from 1m to 4m and rotating the turn table from 0° to 360° to acquire the highest emissions from EUT
3. And also, each emission was to be maximized by changing the polarization of receiving antenna both horizontal and vertical.
4. Repeat above procedures until all frequency measurements have been completed.

Field Strength Calculation

The field strength is calculated by adding the Antenna Factor and Cable Factor and subtracting the Amplifier Gain and Duty Cycle Correction Factor(if any) from the measured reading. The basic equation with a sample calculation is as follows:

$$FS = RA + AF + CL - AG$$

Where FS = Field Strength	CL = Cable Attenuation Factor (Cable Loss)
RA = Reading Amplitude	AG = Amplifier Gain
AF = Antenna Factor	

RADIATION LIMIT

For intentional device, according to § 15.209(a), the general requirement of field strength of radiated emission from intentional radiators at a distance of 3 meters shall not exceed the following table. According to § 15.247(d), in any 100kHz bandwidth outside the frequency band in which the EUT is operating, the radio frequency power that is produced by the intentional radiator shall be at least 20dB below that in the 100kHz bandwidth within the band that contains the highest level of desired power.

Frequency (MHz)	Distance (Meters)	Radiated (dBµV/m)	Radiated (µV/m)
30-88	3	40.0	100
88-216	3	43.5	150
216-960	3	46.0	200
Above 960	3	54.0	500

TEST RESULTS

For 30MHz to 1000MHz

SCAN TABLE: "test Field(30M-1G)QP"

Short Description:			Field Strength(30M-1G)			
Start	Stop	Step	Detector	Meas. Time	IF Bandw.	Transducer
Frequency	Frequency	Width				
30.0 MHz	1.0 GHz	60.0 kHz	QuasiPeak	1.0 s	120 kHz	HL562 09

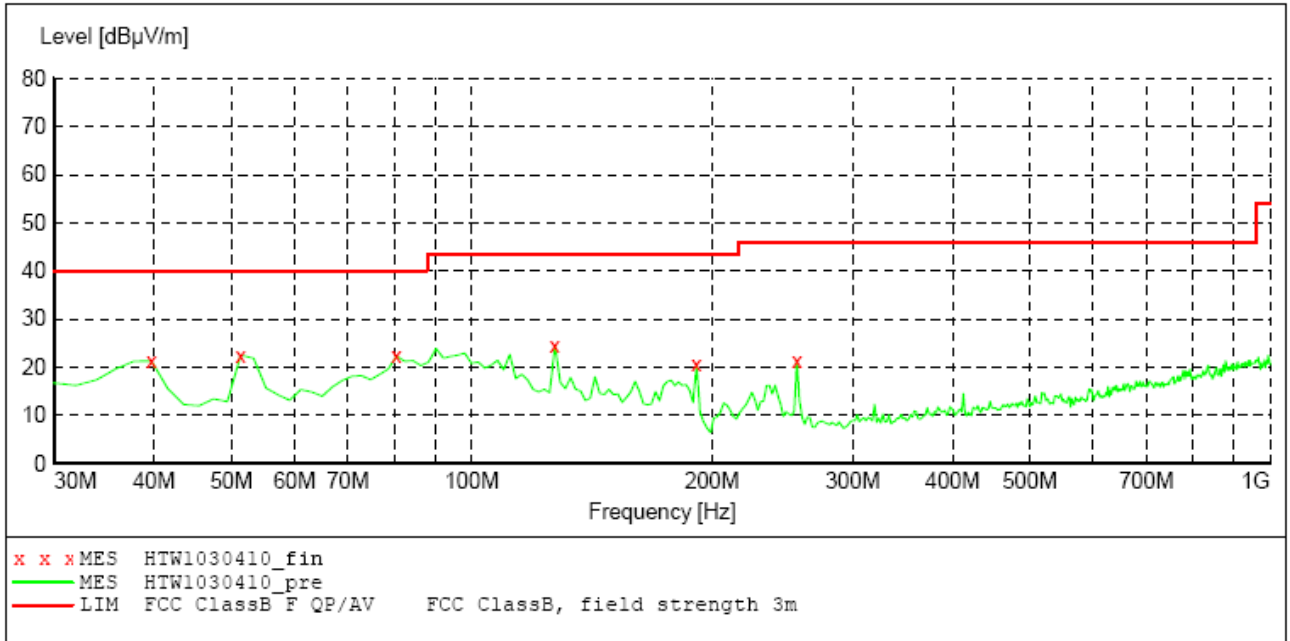

MEASUREMENT RESULT: "HTW1030410_fin"

10/31/2010 10:28AM

Frequency MHz	Level dBµV/m	Transd dB	Limit dBµV/m	Margin dB	Det.	Height cm	Azimuth deg	Polarization
39.719439	21.30	-15.9	40.0	18.7	QP	100.0	53.00	VERTICAL
51.382766	22.50	-21.7	40.0	17.5	QP	100.0	173.00	VERTICAL
80.541082	22.30	-22.3	40.0	17.7	QP	100.0	167.00	VERTICAL
127.194389	24.60	-18.9	43.5	18.9	QP	100.0	204.00	VERTICAL
191.342685	20.60	-21.8	43.5	22.9	QP	100.0	29.00	VERTICAL
255.490982	21.50	-19.7	46.0	24.5	QP	100.0	173.00	VERTICAL

REMARKS :

- *Undetectable
- The IF bandwidth of EMI Test Receiver was 120KHz for measuring from 30 MHz to 1 GHz and 1 MHz for measuring above 1 GHz
- The Transd=Cabel loss +Antenna factor -pre-amplifier factor

SCAN TABLE: "test Field(30M-1G)QP"

Short Description:		Field Strength(30M-1G)				
Start	Stop	Step	Detector	Meas.	IF	Transducer
Frequency	Frequency	Width		Time	Bandw.	
30.0 MHz	1.0 GHz	60.0 kHz	QuasiPeak	1.0 s	120 kHz	HL562 09

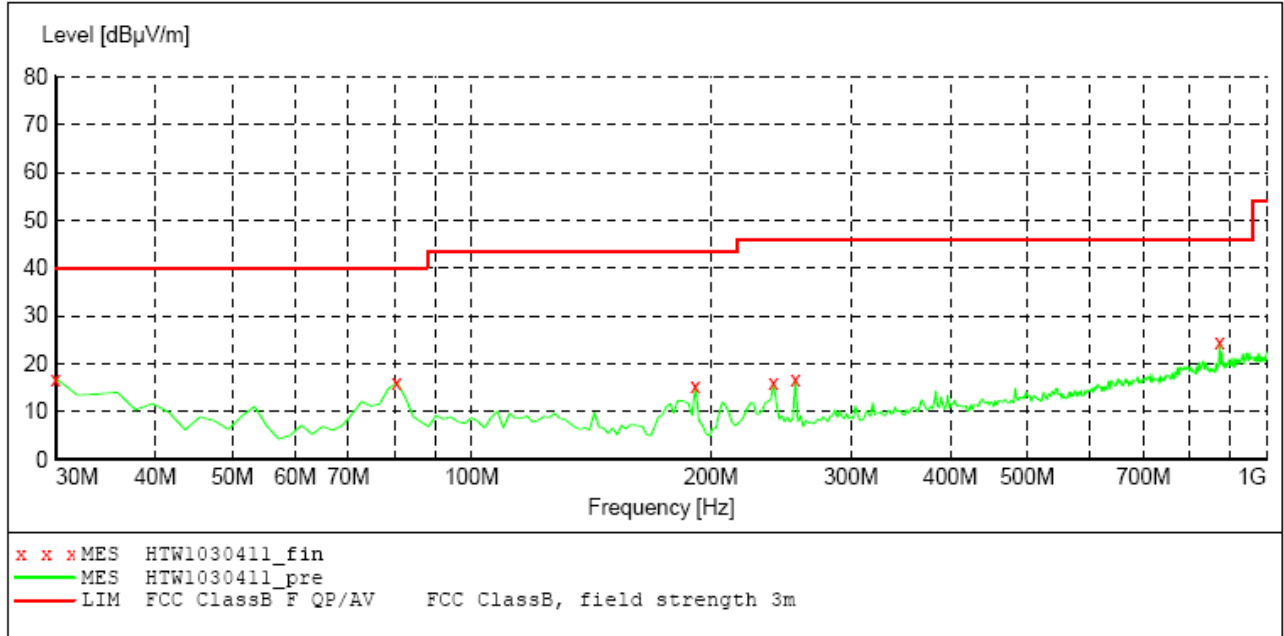

MEASUREMENT RESULT: "HTW1030411_fin"

10/31/2010 10:31AM

Frequency	Level	Transd	Limit	Margin	Det.	Height	Azimuth	Polarization
MHz	dBµV/m	dB	dBµV/m	dB		cm	deg	
30.000000	16.90	-10.1	40.0	23.1	QP	300.0	139.00	HORIZONTAL
80.541082	16.00	-22.3	40.0	24.0	QP	300.0	193.00	HORIZONTAL
191.342685	15.40	-21.8	43.5	28.1	QP	100.0	224.00	HORIZONTAL
239.939880	16.00	-19.9	46.0	30.0	QP	100.0	161.00	HORIZONTAL
255.490982	16.80	-19.7	46.0	29.2	QP	100.0	326.00	HORIZONTAL
873.647295	24.70	-7.5	46.0	21.3	QP	300.0	267.00	HORIZONTAL

REMARKS :

1. *Undetectable
2. The IF bandwidth of EMI Test Receiver was 120KHz for measuring from 30 MHz to 1 GHz and 1 MHz for measuring above 1 GHz
3. The Transd=Cabel loss +Antenna factor -pre-amplifier factor

Above 1G

The frequency spectrum above 1 GHz for Transmitter was investigated. All emission not reported are much lower than the prescribed limits. Set the RBW=1MHz,VBW=3MHz for Peak Detector while the RBW=1MHz,VBW=10Hz for Average Detector,Readings are both peak and average values.

Company	Computime Ltd.	Test Date	11/07/2010
Test Mode	Channel 11	Detector Function	Peak(PK)/Average(AV)
Product Name	In Home Display	Test By	Eric Zhang
Model Name	AEP3081	TEMP&Humidity	25°C, 55%

ANTENNA POLARITY & TEST DISTANCE: HORIZONTAL AT 3 M

No.	Frequency (MHz)	Emission Level (dBuV/m)		Limit (dBuV/m)	Margin (dB)	Antenna Height (m)	Table Angle (Degree)	Raw Value (dBuV)	Antenna Factor (dB/m)	Cable Factor (dB)	Pre-amplifier (dB)	Correction Factor (dB/m)
1	*2405.00	107.79	PK			1.00	360	111.19	28.3	4.90	36.6	-3.40
1	*2405.00	100.74	AV			1.00	360	104.14	28.3	4.90	36.6	-3.40
2	4810.00	62.14	PK	74.00	11.86	1.00	359	58.94	32.7	7.00	36.5	3.20
2	4810.00	47.21	AV	54.00	6.79	1.00	359	44.01	32.7	7.00	36.5	3.20
3	7215.00	64.03	PK	74.00	9.97	1.00	152	54.63	35.8	8.90	35.3	9.40
3	7215.00	49.05	AV	54.00	4.95	1.00	152	39.65	35.8	8.90	35.3	9.40
4	9620.00	65.59	PK	74.00	8.41	1.00	140	52.99	37.2	10.20	34.8	12.60
4	9620.00	49.68	AV	54.00	4.32	1.00	140	37.08	37.2	10.20	34.8	12.60

ANTENNA POLARITY & TEST DISTANCE: VERTICAL AT 3 M

No.	Frequency (MHz)	Emission Level (dBuV/m)		Limit (dBuV/m)	Margin (dB)	Antenna Height (m)	Table Angle (Degree)	Raw Value (dBuV)	Antenna Factor (dB/m)	Cable Factor (dB)	Pre-amplifier (dB)	Correction Factor (dB/m)
1	*2405.00	105.72	PK			1.0	124	109.12	28.3	4.90	36.6	-3.40
1	*2405.00	100.12	AV			1.0	124	103.52	28.3	4.90	36.6	-3.40
2	4810.00	61.02	PK	74.00	12.98	1.0	339	57.82	32.7	7.00	36.5	3.20
2	4810.00	46.26	AV	54.00	7.74	1.0	339	43.06	32.7	7.00	36.5	3.20
3	7215.00	63.25	PK	74.00	10.75	1.0	340	53.85	35.8	8.90	35.3	9.40
3	7215.00	48.52	AV	54.00	5.48	1.0	340	39.12	35.8	8.90	35.3	9.40
4	9620.00	64.00	PK	74.00	10.00	1.0	20	51.4	37.2	10.20	34.8	12.60
4	9620.00	49.00	AV	54.00	5.0	1.0	20	36.4	37.2	10.20	34.8	12.60

REMARKS:

1. Emission level (dBuV/m) =Raw Value (dBuV) + Correction Factor (dB/m)
2. Correction Factor (dB/m) = Antenna Factor (dB/m) + Cable Factor (dB) - Pre-amplifier Factor
3. The other emission levels were very low against the limit.
4. Margin value = Limit value- Emission level.
5. The limit value is defined as per 15.247
6. “* “: Fundamental frequency

Company	Computime Ltd.	Test Date	11/07/2010
Test Mode	Channel 18	Detector Function	Peak(PK)/Average(AV)
Product Name	In Home Display	Test By	Eric Zhang
Model Name	AEP3081	TEMP&Humidity	25°C, 55%

ANTENNA POLARITY & TEST DISTANCE: HORIZONTAL AT 3 M

No.	Frequency (MHz)	Emission Level (dBuV/m)		Limit (dBuV/m)	Margin (dB)	Antenna Height (m)	Table Angle (Degree)	Raw Value (dBuV)	Antenna Factor (dB/m)	Cable Factor (dB)	Pre-amplifier (dB)	Correction Factor (dB/m)
1	*2440.00	110.21	PK			1.00 H	153	113.41	28.3	5.10	36.6	-3.20
1	*2440.00	106.25	AV			1.00 H	153	109.45	28.3	5.10	36.6	-3.20
2	4880.00	64.25	PK	74.00	9.75	1.00 H	202	60.85	32.3	7.60	36.5	3.40
2	4880.00	49.86	AV	54.00	4.14	1.00 H	202	46.46	32.3	7.60	36.5	3.40
3	7320.00	67.52	PK	74.00	6.48	1.00 H	355	58.12	36.1	8.60	35.3	9.40
3	7320.00	51.62	AV	54.00	2.38	1.00 H	355	42.22	36.1	8.60	35.3	9.40
4	9760.00	70.23	PK	74.00	3.77	1.00 H	28	57.63	37.2	10.20	34.8	12.60
4	9760.00	52.63	AV	54.00	1.37	1.00 H	28	40.03	37.2	10.20	34.8	12.60

ANTENNA POLARITY & TEST DISTANCE: VERTICAL AT 3 M

No.	Frequency (MHz)	Emission Level (dBuV/m)		Limit (dBuV/m)	Margin (dB)	Antenna Height (m)	Table Angle (Degree)	Raw Value (dBuV)	Antenna Factor (dB/m)	Cable Factor (dB)	Pre-amplifier (dB)	Correction Factor (dB/m)
1	*2440.00	108.52	PK			1.00 V	121	111.72	28.3	5.10	36.6	-3.20
1	*2440.00	104.69	AV			1.00 V	121	107.89	28.3	5.10	36.6	-3.20
2	4880.00	62.45	PK	74.00	11.55	1.00 V	97	59.05	32.3	7.60	36.5	3.40
2	4880.00	47.34	AV	54.00	6.66	1.00 V	97	43.94	32.3	7.60	36.5	3.40
3	7320.00	65.58	PK	74.00	8.42	1.00 V	288	56.18	36.1	8.60	35.3	9.40
3	7320.00	50.00	AV	54.00	4.00	1.00 V	288	40.60	36.1	8.60	35.3	9.40
4	9760.00	69.85	PK	74.00	4.15	1.00 V	89	57.25	37.2	10.20	34.8	12.60
4	9760.00	52.10	AV	54.00	1.90	1.00 V	89	39.50	37.2	10.20	34.8	12.60

- REMARKS:**
1. Emission level (dBuV/m)=Raw Value(dBuV) + Correction Factor(dB/m)
 2. Correction Factor (dB/m) = Antenna Factor (dB/m) + Cable Factor (dB) - Pre-amplifier Factor
 3. The other emission levels were very low against the limit.
 4. Margin value = Limit value- Emission level.
 5. The limit value is defined as per 15.247
 6. "*" : Fundamental frequency

Company	Computime Ltd.	Test Date	11/07/2010
Test Mode	Channel 26	Detector Function	Peak(PK)/Average(AV)
Product Name	In Home Display	Test By	Eric Zhang
Model Name	AEP3081	TEMP&Humidity	25°C, 55%

ANTENNA POLARITY & TEST DISTANCE: HORIZONTAL AT 3 M

No.	Frequency (MHz)	Emission Level (dBuV/m)		Limit (dBuV/m)	Margin (dB)	Antenna Height (m)	Table Angle (Degree)	Raw Value (dBuV)	Antenna Factor (dB/m)	Cable Factor (dB)	Pre-amplifier (dB)	Correction Factor (dB/m)
1	*2480.00	98.96	PK			1.00 H	156	102.26	28.2	5.10	36.6	-3.30
1	*2480.00	89.76	AV			1.00 H	156	93.06	28.2	5.10	36.6	-3.30
2	4960.00	59.26	PK	74.00	14.74	1.00 H	198	55.46	33.0	7.00	36.2	3.80
2	4960.00	42.36	AV	54.00	11.64	1.00 H	198	38.56	33.0	7.00	36.2	3.80
3	7340.00	63.25	PK	74.00	10.75	1.00 H	90	53.85	36.2	8.50	35.3	9.40
3	7340.00	48.12	AV	54.00	5.88	1.00 H	90	38.72	36.2	8.50	35.3	9.40
4	9920.00	65.15	PK	74.00	8.85	1.00 H	124	52.45	37.4	10.10	34.8	12.70
4	9920.00	49.25	AV	54.00	4.75	1.00 H	124	36.55	37.4	10.10	34.8	12.70

ANTENNA POLARITY & TEST DISTANCE: VERTICAL AT 3 M

No.	Frequency (MHz)	Emission Level (dBuV/m)		Limit (dBuV/m)	Margin (dB)	Antenna Height (m)	Table Angle (Degree)	Raw Value (dBuV)	Antenna Factor (dB/m)	Cable Factor (dB)	Pre-amplifier (dB)	Correction Factor (dB/m)
1	*2480.00	96.00	PK			1.0	125	99.3	28.2	5.10	36.6	-3.30
1	*2480.00	87.59	AV			1.0	125	90.89	28.2	5.10	36.6	-3.30
2	4960.00	53.16	PK	74.00	20.84	1.0	96	49.36	36.2	8.50	35.3	3.80
2	4960.00	38.56	AV	54.00	15.44	1.0	96	34.76	36.2	8.50	35.3	3.80
3	7340.00	61.20	PK	74.00	12.8	1.0	35	51.8	37.4	10.10	34.8	9.40
3	7340.00	47.68	AV	54.00	6.32	1.0	35	38.28	37.4	10.10	34.8	9.40
4	9920.00	64.03	PK	74.00	9.97	1.0	37	51.33	28.2	5.10	36.6	12.70
4	9920.00	48.93	AV	54.00	5.07	1.0	37	36.23	28.2	5.10	36.6	12.70

- REMARKS:**
1. Emission level (dBuV/m) = Raw Value (dBuV) + Correction Factor (dB/m)
 2. Correction Factor (dB/m) = Antenna Factor (dB/m) + Cable Factor (dB) - Pre-amplifier Factor
 3. The other emission levels were very low against the limit.
 4. Margin value = Limit value - Emission level.
 5. The limit value is defined as per 15.247
 6. " * " : Fundamental frequency

4.3. Maximum Peak Output Power

TEST CONFIGURATION

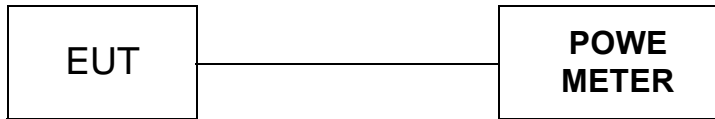

TEST PROCEDURE

The EUT was directly connected to the power meter and antenna output port as show in the block diagram as TEST CONFIGURATION shows.

LIMIT

The Maximum Peak Output Power Measurement is 30dBm.

TEST RESULTS

Company	Computime Ltd.	Test Date	11/07/2010
Product Name	In Home Display	Test By	Eric Zhang
Model Name	AEP3081	TEMP&Humidity	25°C, 55%

Channel Number	Channel Frequency (MHz)	Peak Power Output (dBm)	Peak Power Limit (dBm)	Pass / Fail
11	2405	14.69	30	PASS
18	2440	18.79	30	PASS
26	2480	6.97	30	PASS

Note: The test results including the cable lose.

4.4. Power Spectral Density

TEST CONFIGURATION

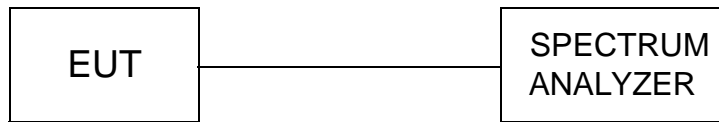

TEST PROCEDURE

1. Set CENTER FREQUENCY = Frequency from Power Spectral Density Test Matrix
2. Set SPAN = 20 MHz (For devices with a nominal 40 MHz BW, 50 MHz span will be needed)
3. Set REFERENCE LEVEL = 20 dBm
4. Set ATTENUATION = 0 dB (add internal attenuation, if necessary)
5. Set SWEEP TIME = Coupled
6. Set RBW = 3 kHz
7. Set VBW = 10 kHz
8. Set DETECTOR = Peak
9. Set MKR = Center Frequency
10. Set TRACE = CLEAR WRITE

Place the radio in continuous transmit mode. Set the TRACE to MAX HOLD, and after the trace stabilizes, the TRACE to VIEW. Set the marker on the peak of the signal and then adjust the center frequency of the spectrum analyzer to the marker frequency. After viewing the EUT waveform on the spectrum analyzer, perform the following spectrum analyzer functions to capture the trace:

11. Set SPAN = 300 kHz
12. Set SWEEP TIME = 100 s
13. Set TRACE = MAX HOLD
14. Set MKR = PEAK SEARCH
15. Record the marker level for the particular mode. Repeat these steps for other device modes.

LIMIT

For digitally modulated systems, the power spectral density conducted from the intentional radiator to the antenna shall not be greater than 8 dBm in any 3 kHz band during any time interval of continuous transmission.

TEST RESULTS

Company	Computime Ltd.	Test Date	11/07/2010
Product Name	In Home Display	Test By	Eric Zhang
Model Name	AEP3081	TEMP&Humidity	25°C, 55%

CHANNEL NUMBER	CHANNEL FREQUENCY (MHz)	RF POWER LEVEL IN 3 KHz BW (dBm)	MAXIMUM LIMIT (dBm)	PASS/FAIL
11	2405	-0.37	8	PASS
18	2440	5.10	8	PASS
20	2480	-8.14	8	PASS

Note: The test results including the cable lose.

Photos of Power Spectral Density Measurement

Channel 11

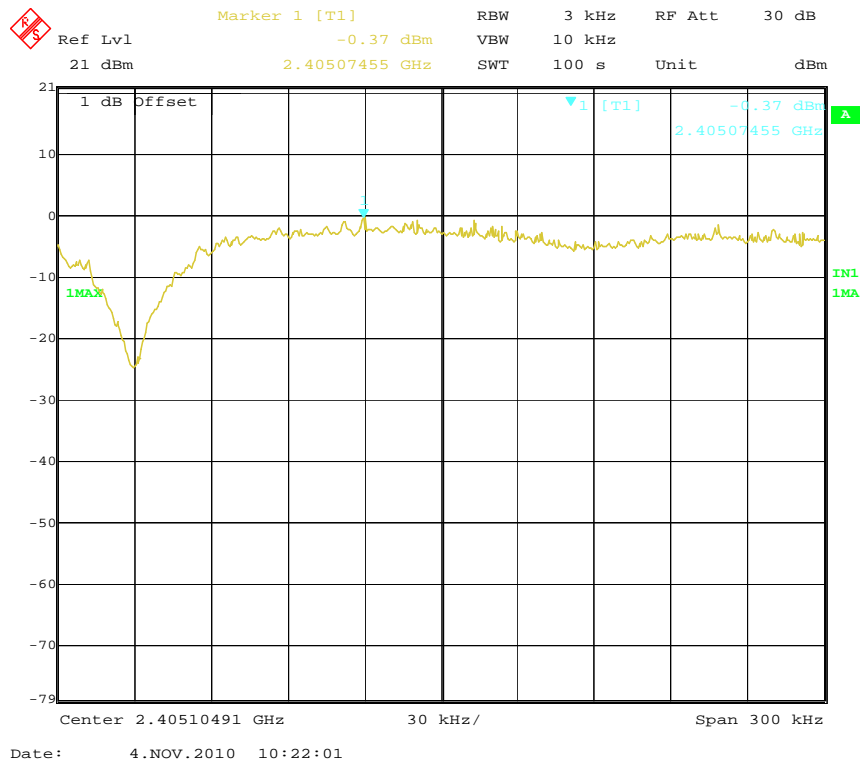

Channel 18

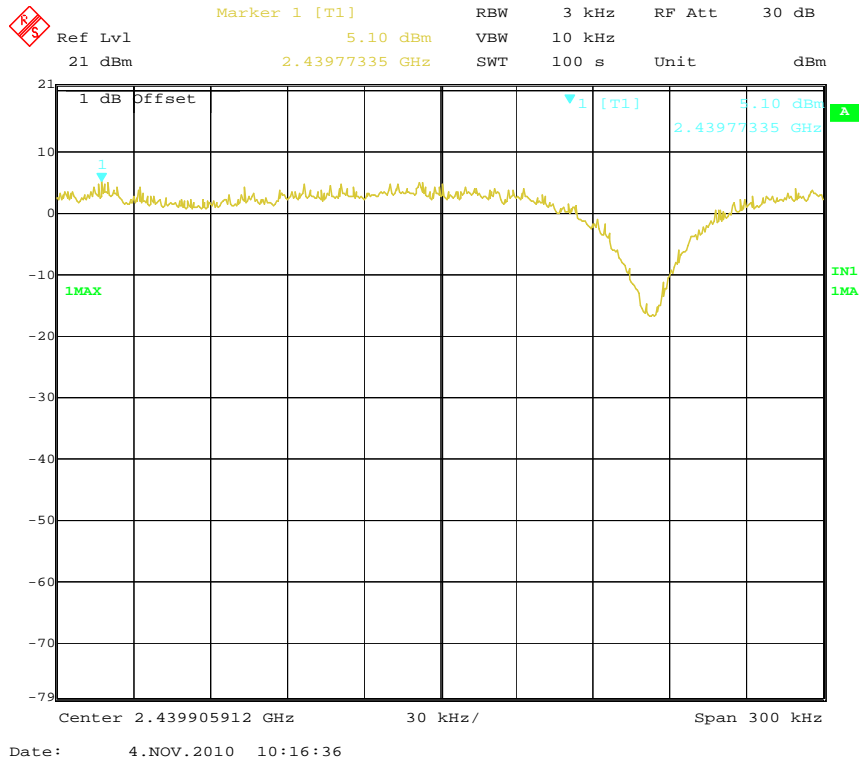

Channel 26

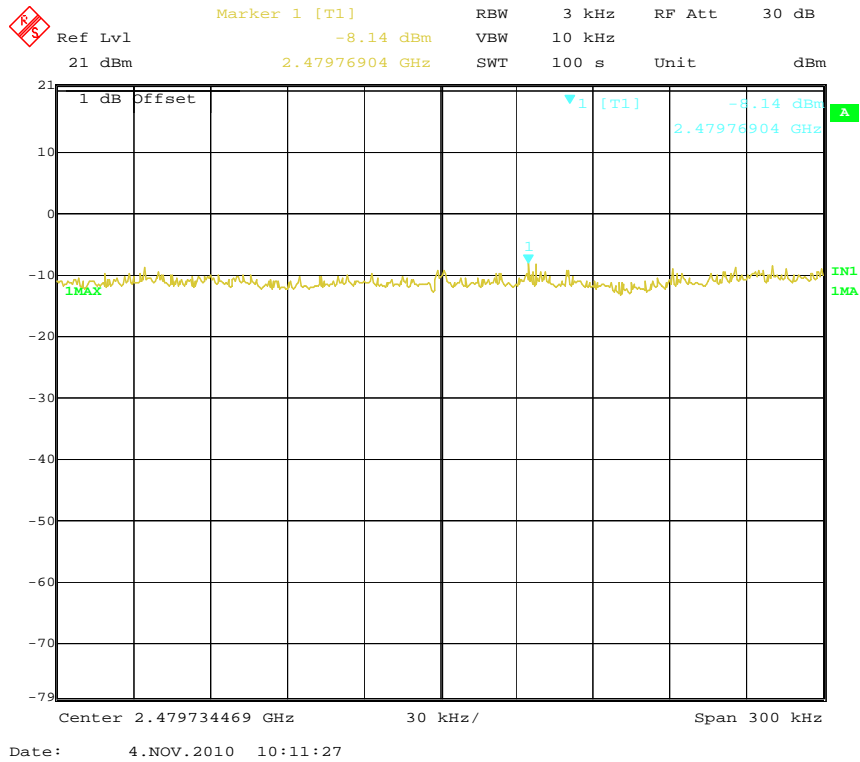

4.5. Band Edge Compliance of RF Emission

TEST CONFIGURATION

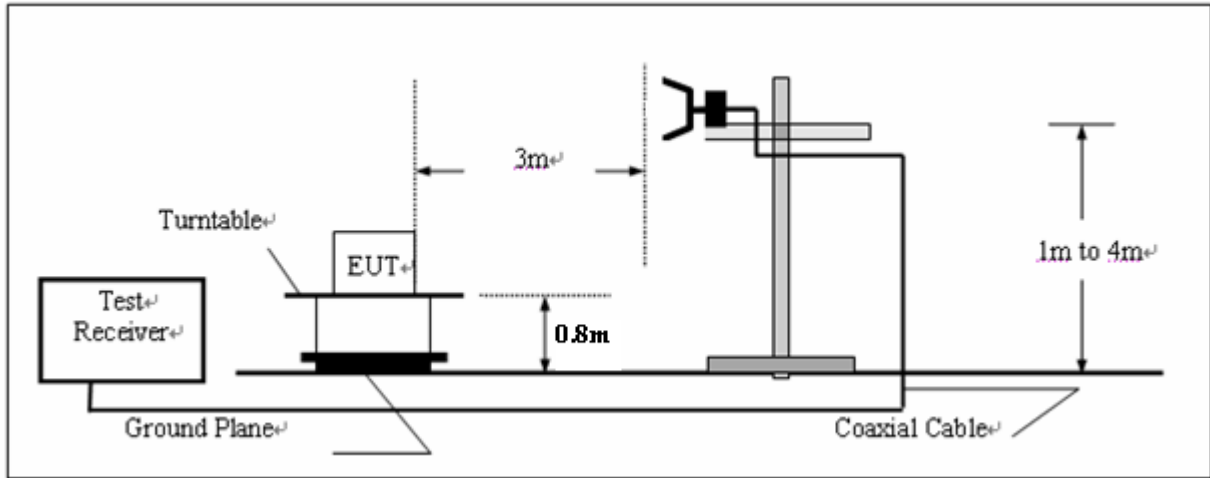

TEST PROCEDURE

The band edge compliance of RF radiated emission should be measured by following the guidance in ANSI C63.4:2009 with respect to maximizing the emission by rotating the EUT, measuring the emission while the EUT is situated in three orthogonal planes (if appropriate), adjusting the measurement antenna height and polarization etc. Set RBW=1MHz and VBM= 3MHz to measure the peak field strength and set RBW to 1MHz and VBW to 10Hz to measure the average radiated field strength.

LIMIT

Fall in the restricted bands listed in section 15.205. The maximum permitted average field strength is listed in section 15.209(see Section 15.205(c)).

Frequency (MHz)	Limit Average (dBuv/m)	Limit Peak (dBuv/m)
Below 2390 or Above 2483.5	54	74

TEST RESULTS

Photos of Band Edge Measurement

Channel 11 Polarity: Ver.

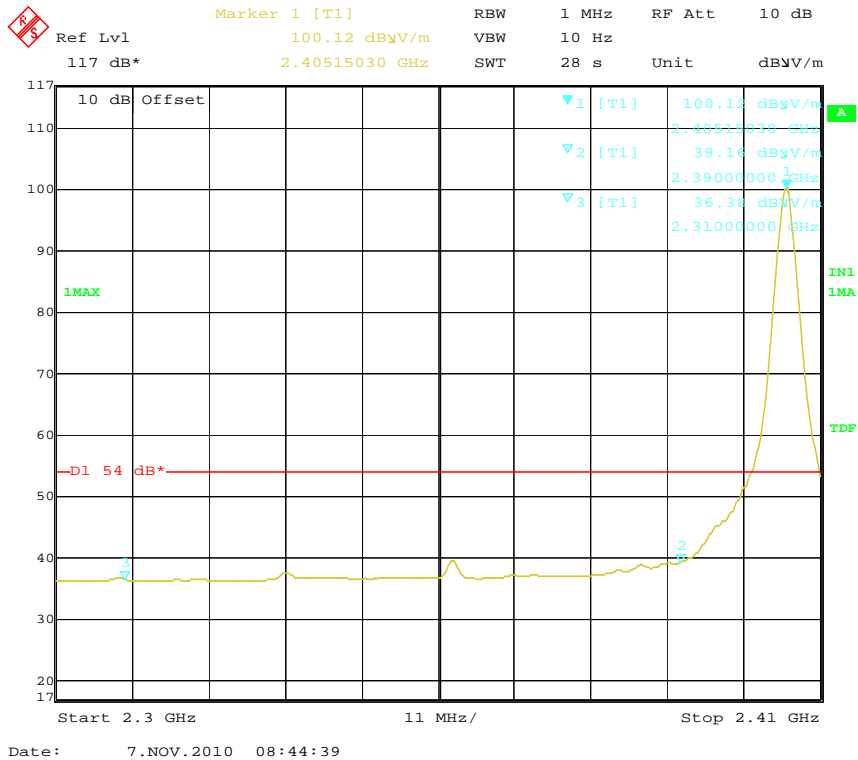
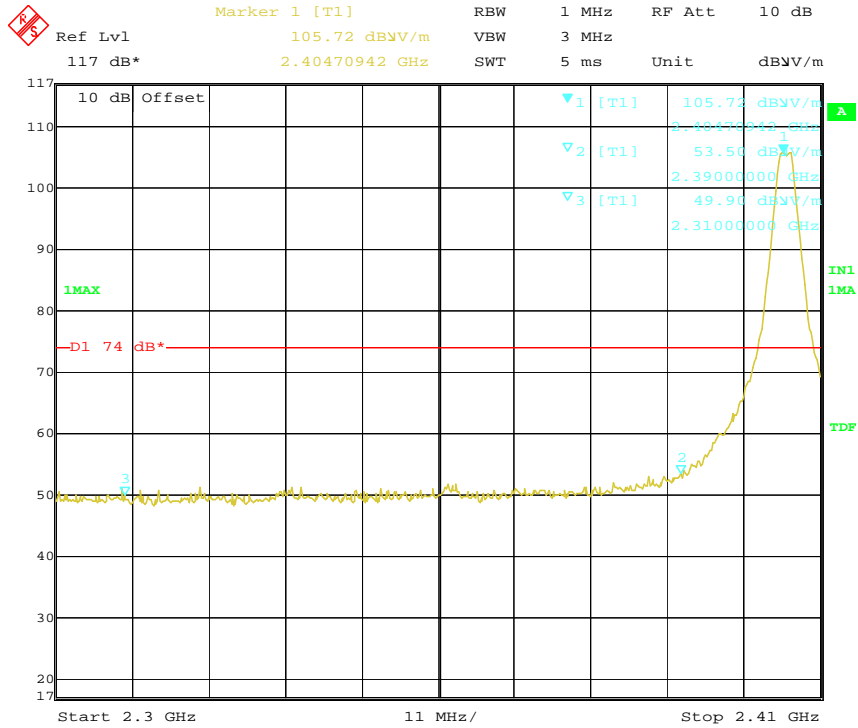

Channel 11 Polarity: Hor.

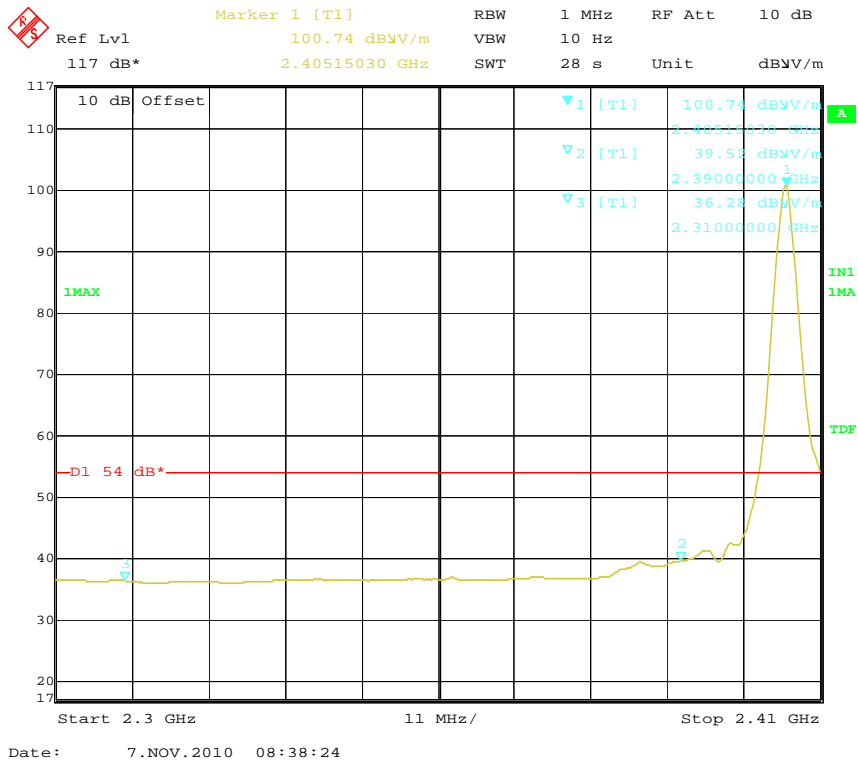
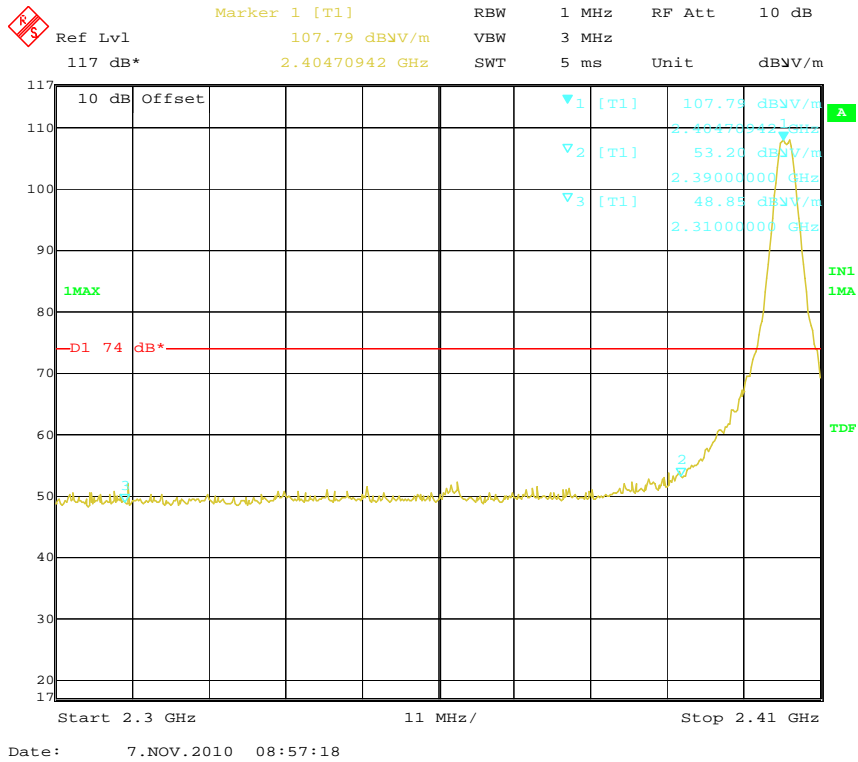

Channel 26 Polarity: Hor.

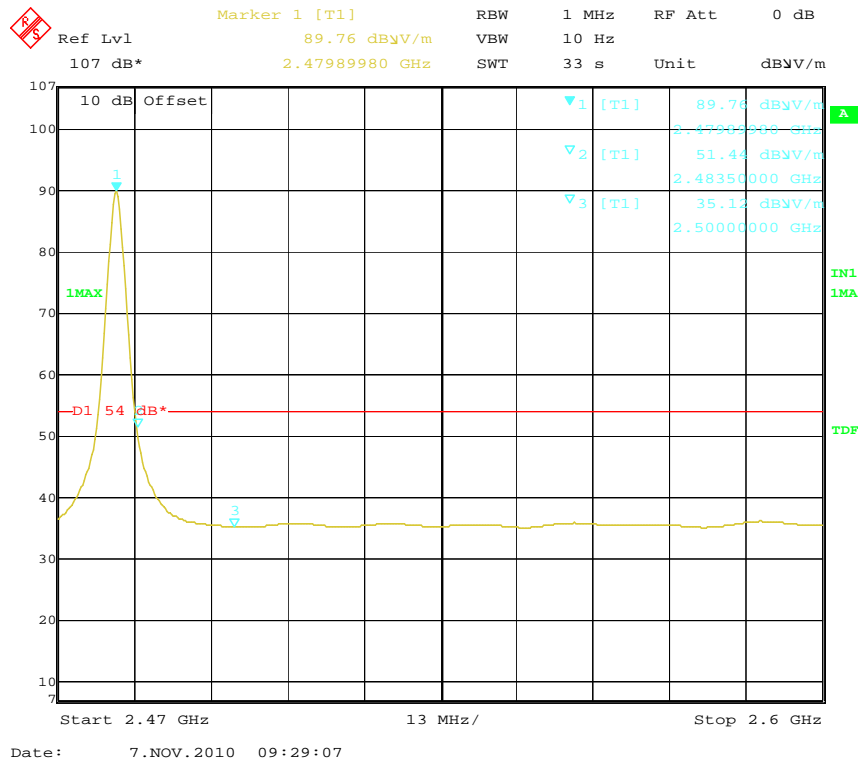
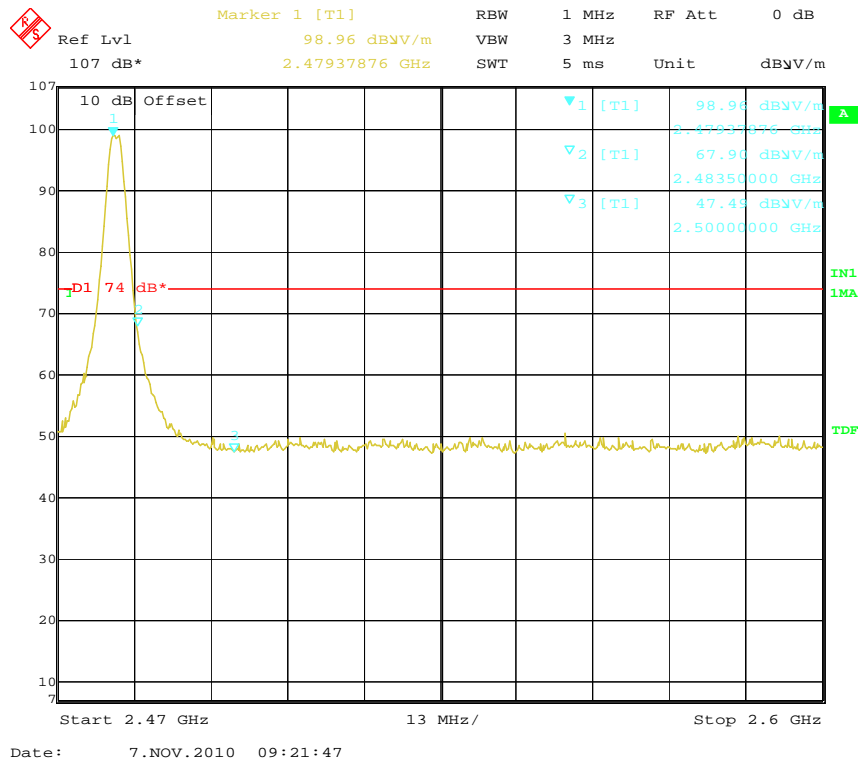

Channel 26 Polarity: Ver.

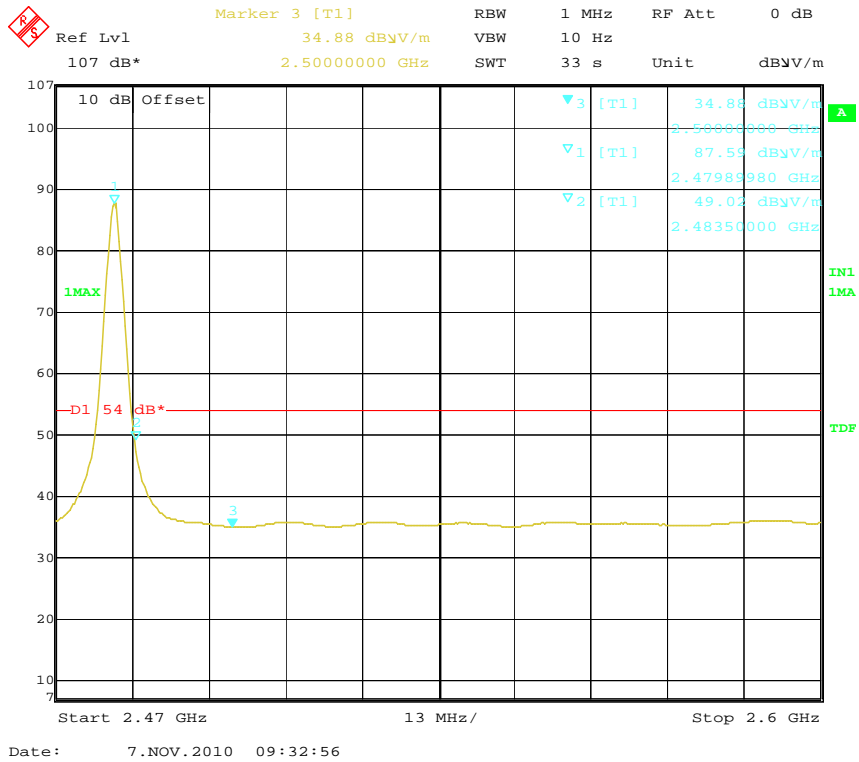

4.6. Spurious RF Conducted Emission

TEST CONFIGURATION

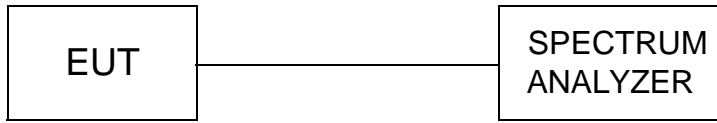

TEST PROCEDURE

The unlicensed wireless device antenna port connected to the spectrum analyzer, If a second antenna port is available, it shall be tested at one frequency to verify it has similar output characteristics as the fully-tested port. Set the spectrum RBW=100KHz, RBW=300KHz.

LIMIT

- 1. Below -20dB of the highest emission level in operating band.
- 2. Fall in the restricted bands listed in section 15.205. The maximum permitted average field strength is listed in section 15.209.

TEST RESULTS

Photo of Spurious RF Conducted Emission Measurement

Channel 11

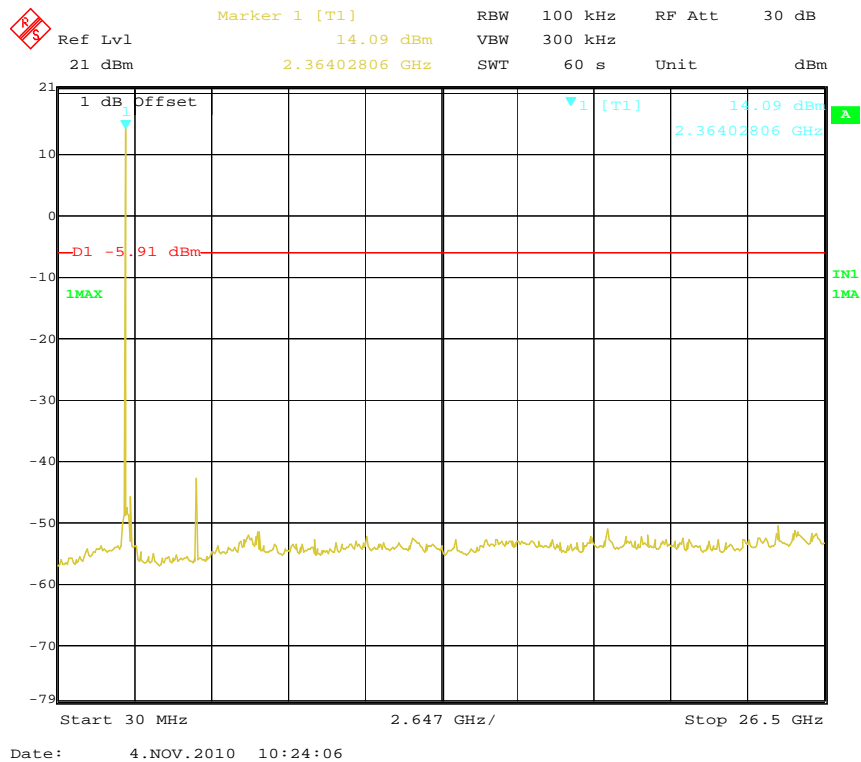

Channel 18

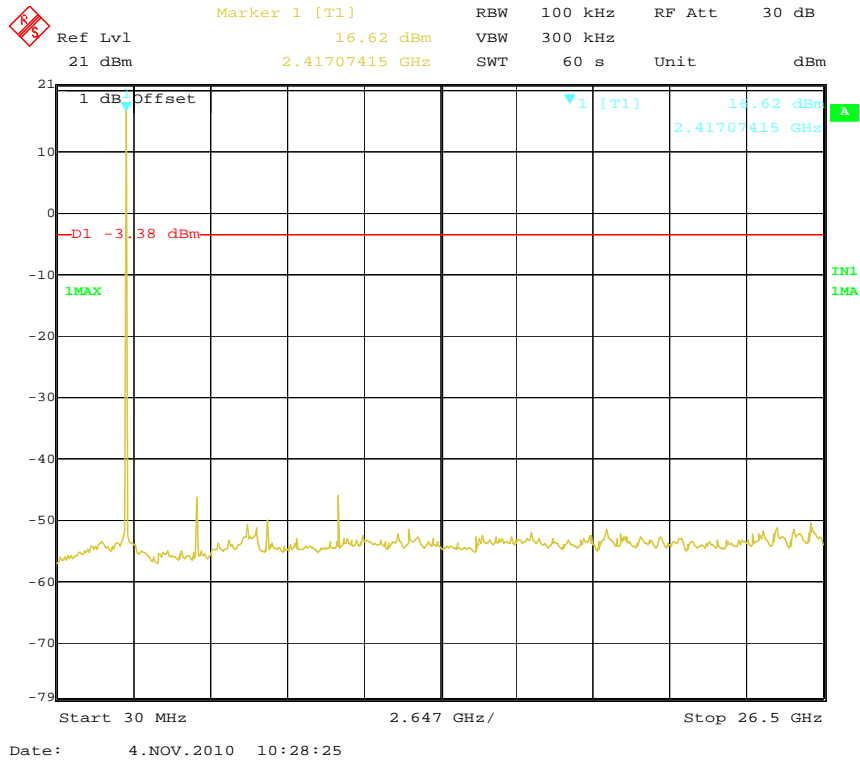

Channel 26

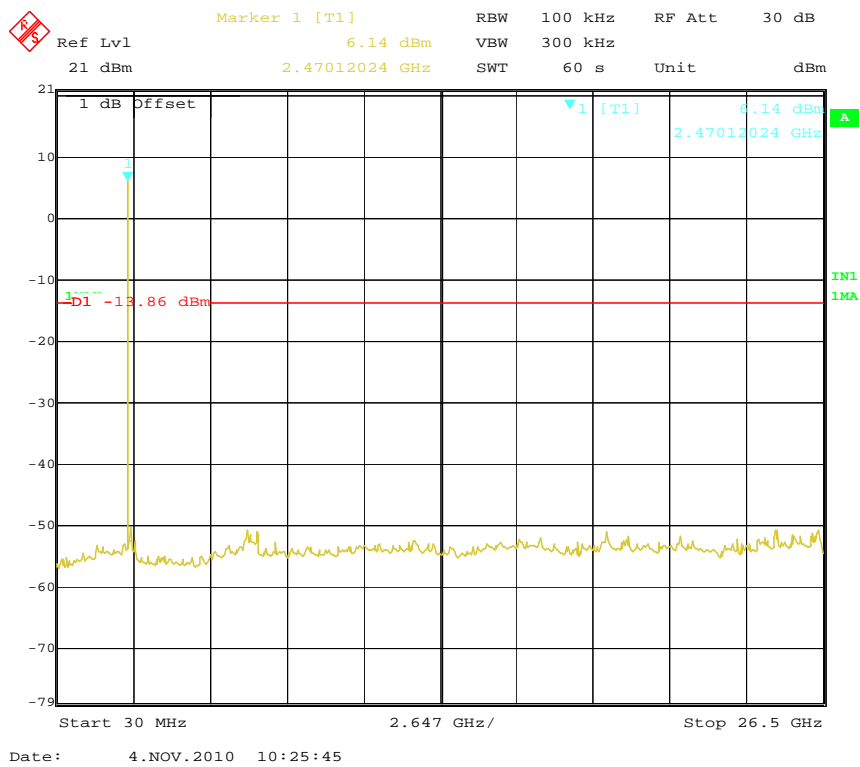

Frequency	Delta peak to band emission	Limit(dBc)
2400MHz	42.46	20
2483.5MHz	45.86	20

Channel 11

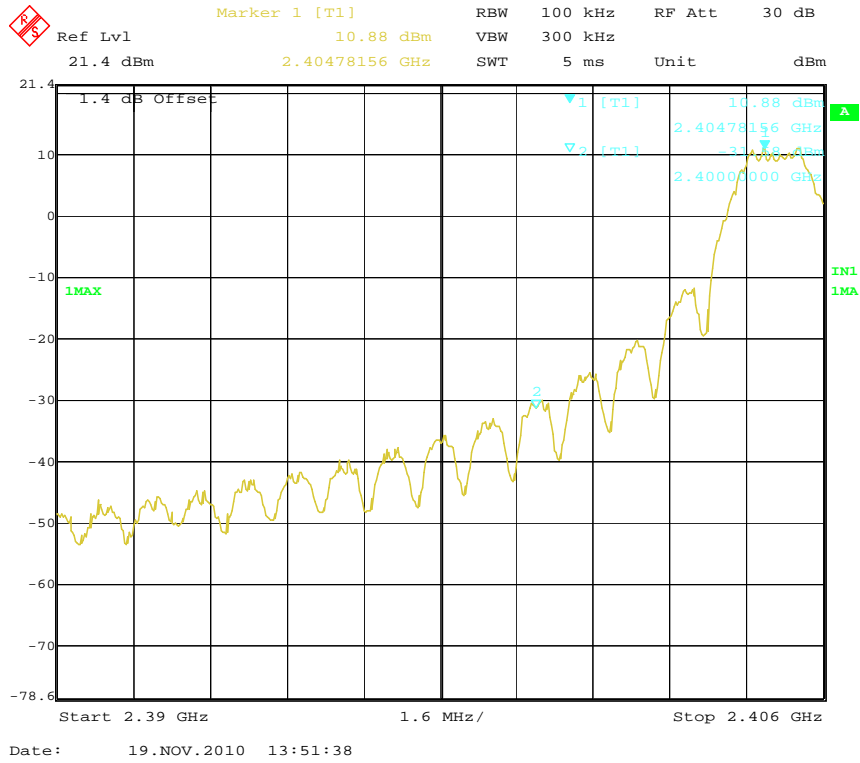

Channel 26

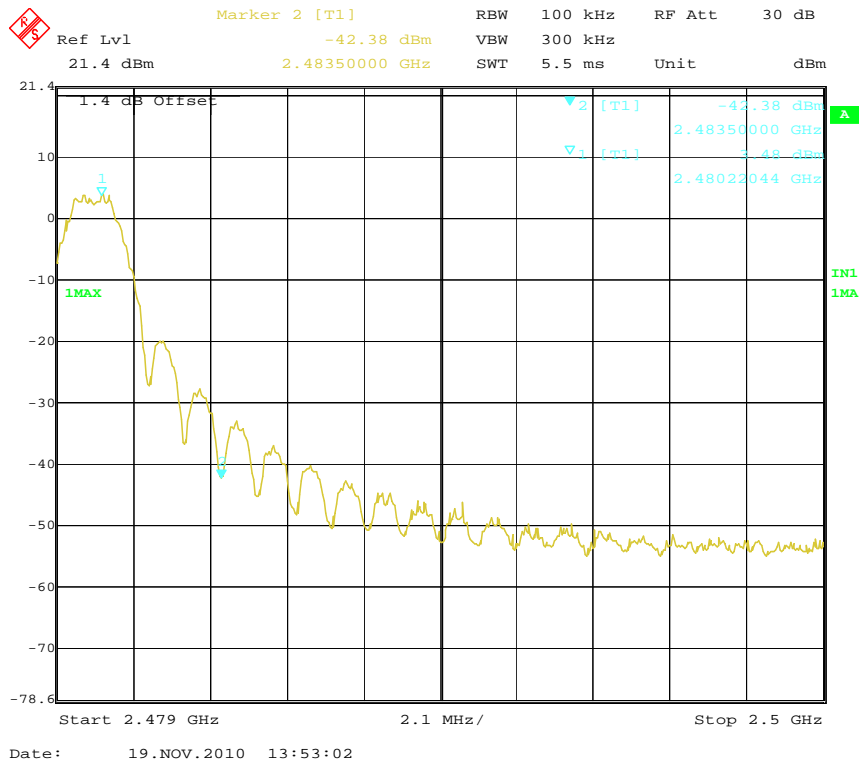

4.7. 6dB Bandwidth

TEST CONFIGURATION

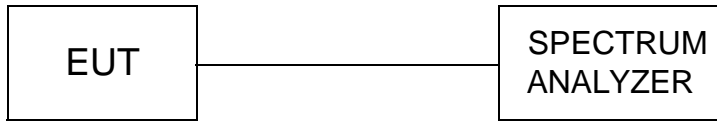

TEST PROCEDURE

The transmitter output was connected to the spectrum analyzer through an attenuator. The bandwidth of the fundamental frequency was measured by spectrum analyzer with 100 KHz RBW and 300KHz VBW.

The 6dB bandwidth is defined as the total spectrum the power of which is higher than peak power minus 6dB.

LIMIT

For digital modulation systems, the minimum 6 dB bandwidth shall be at least 500 kHz.

TEST RESULTS

Company	Computime Ltd.	Test Date	11/07/2010
Product Name	In Home Display	Test By	Eric Zhang
Model Name	AEP3081	TEMP&Humidity	25°C, 55%

CHANNEL	CHANNEL FREQUENCY (MHz)	6 dB BANDWIDTH (MHz)	99%Bandwidth (MHz)	MINIMUM LIMIT (MHz)	PASS/FAIL
11	2405	1.613	2.385	0.5	PASS
18	2440	1.593	2.355	0.5	PASS
26	2480	1.583	2.335	0.5	PASS

Photos of 6dB Bandwidth Measurement and 99% Occupied Bandwidth

Channel 11

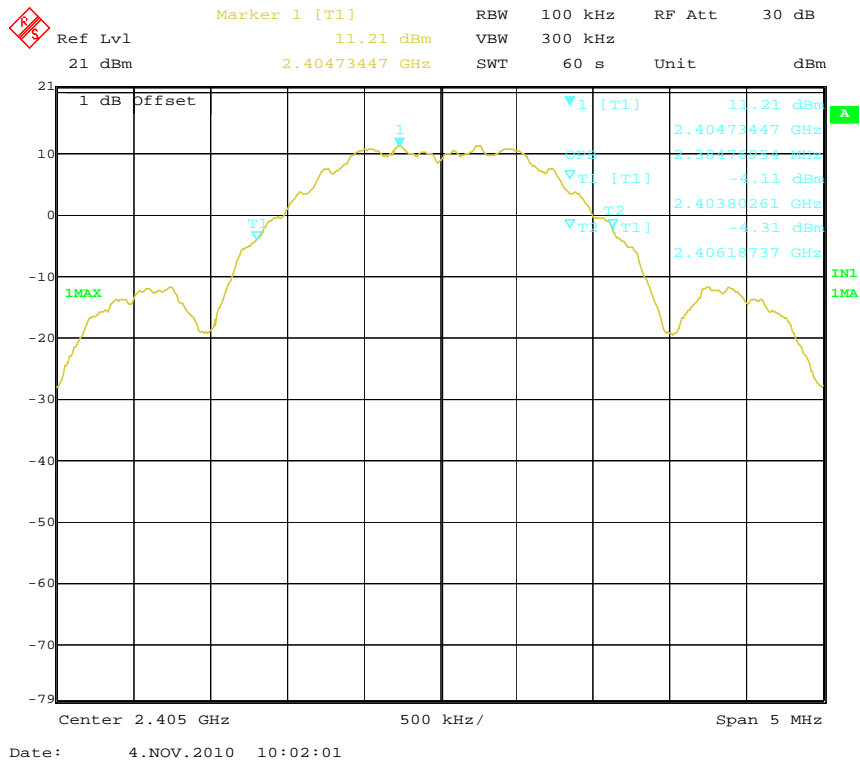
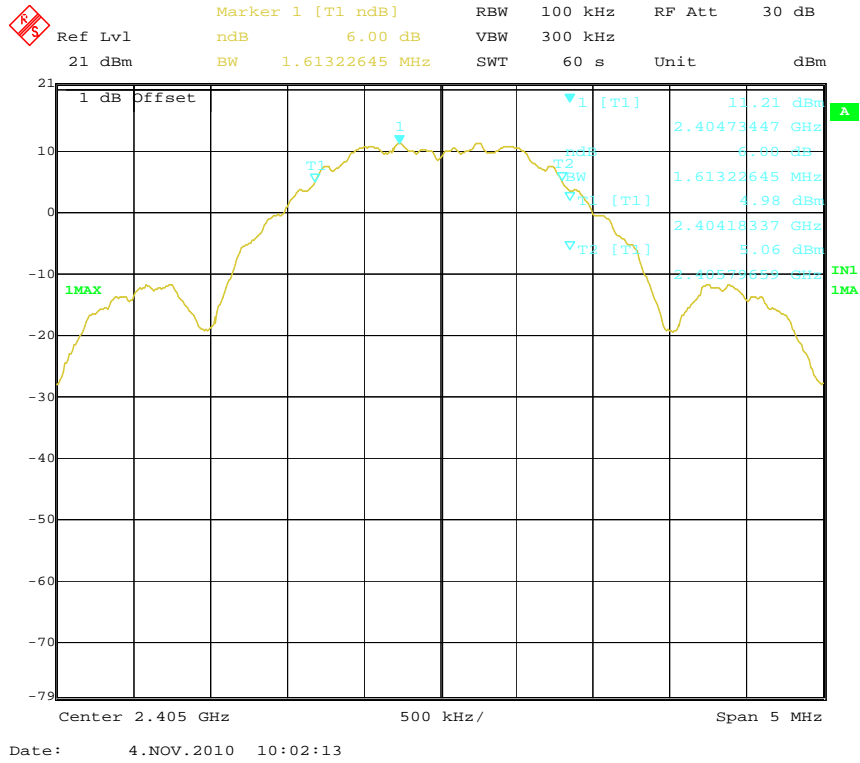

Channel 18

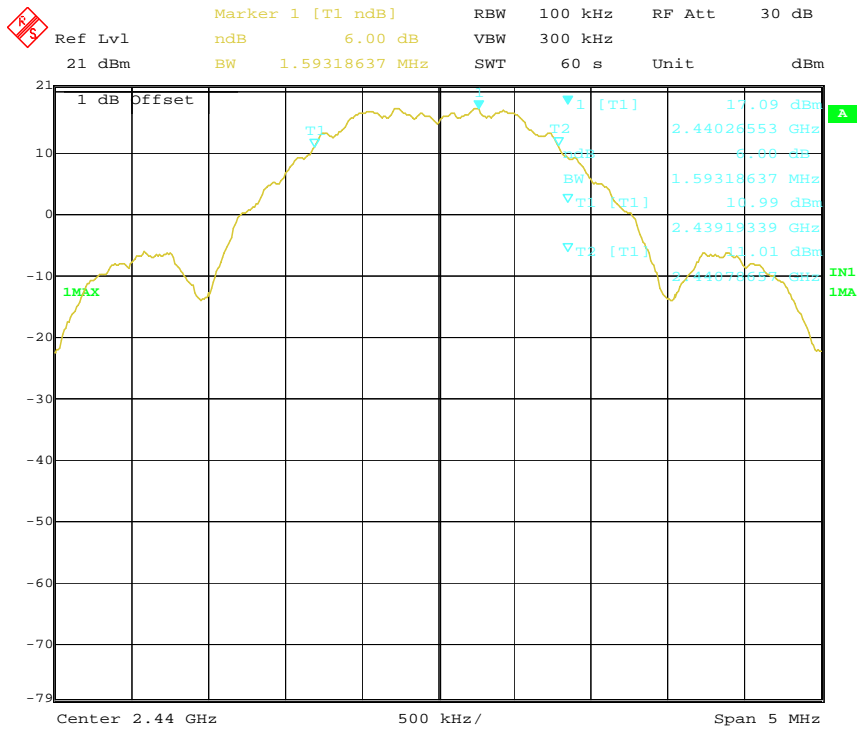

Date: 4.NOV.2010 10:06:48

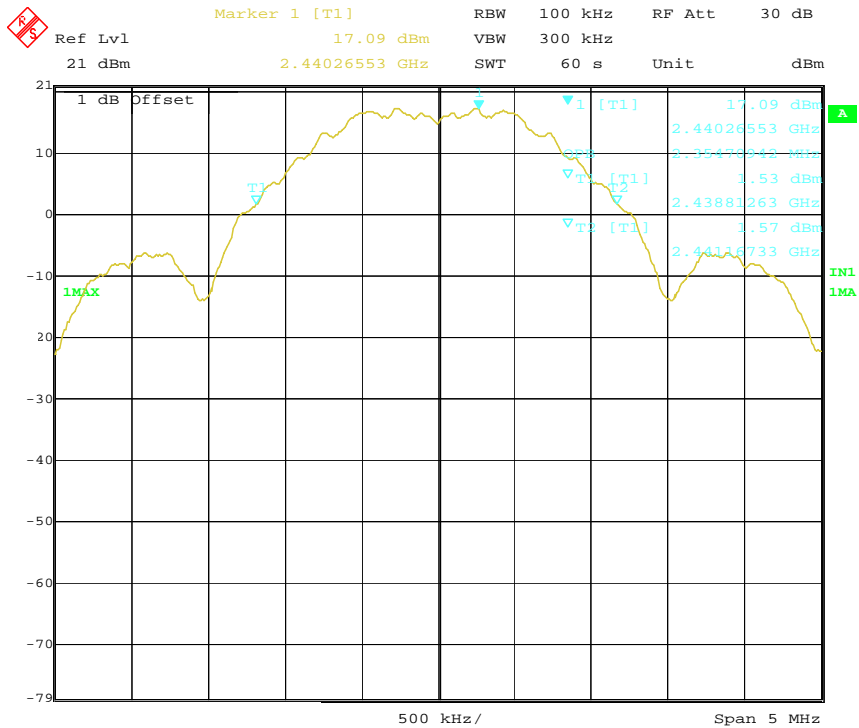

Date: 4.NOV.2010 10:06:31

Channel 26

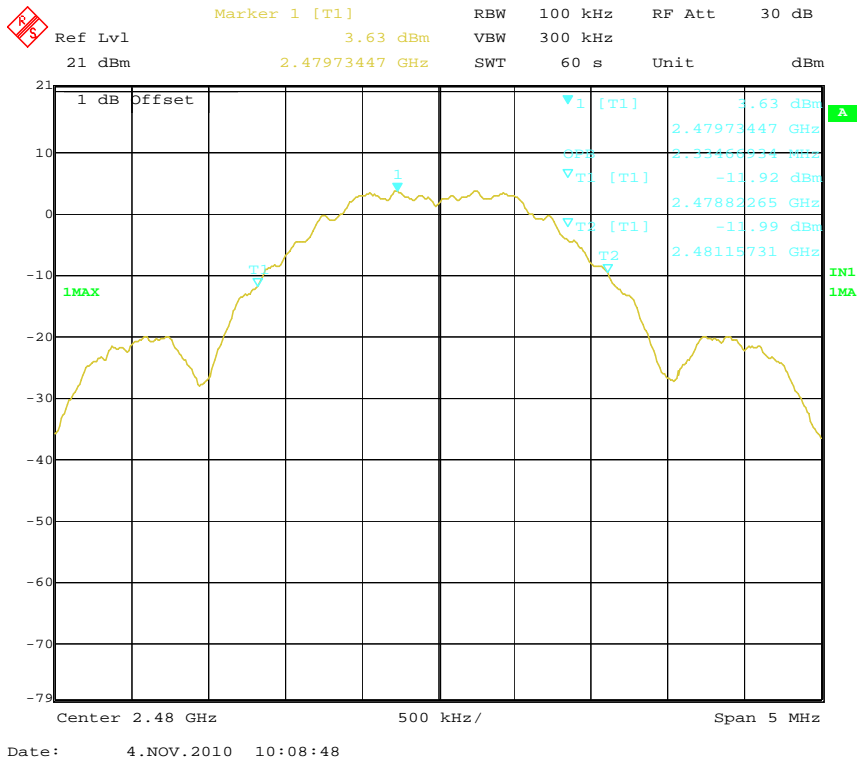
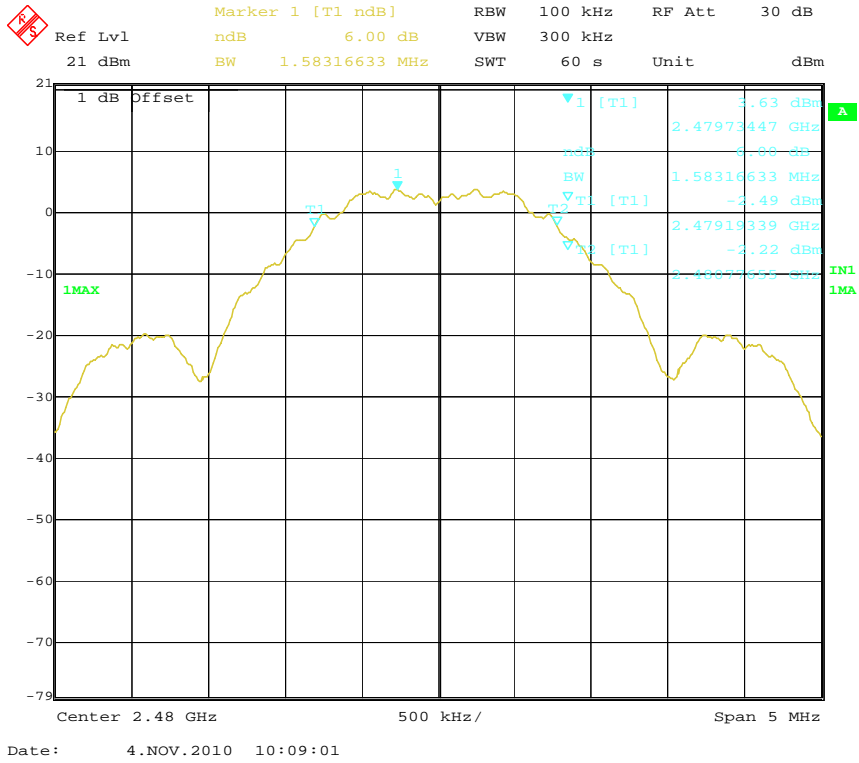

4.8. Antenna Requirement

Standard Applicable

For intentional device, according to FCC 47 CFR Section 15.203, an intentional radiator shall be designed to ensure that no antenna other than that furnished by the responsible party shall be used with the device.

And according to FCC 47 CFR Section 15.247 (c), if transmitting antennas of directional gain greater than 6dBi are used, the power shall be reduced by the amount in dB that the directional gain of the antenna exceeds 6dBi.

Refer to statement below for compliance.

The manufacturer may design the unit so that the user can replace a broken antenna, but the use of a standard antenna jack or electrical connector is prohibited. Further, this requirement does not apply to intentional radiators that must be professionally installed.

Antenna Connected Construction

The antenna used in this product is a PCB Antenna .The maximum Gain of the antenna only -0.32dBi. Detail please see the photos as following:

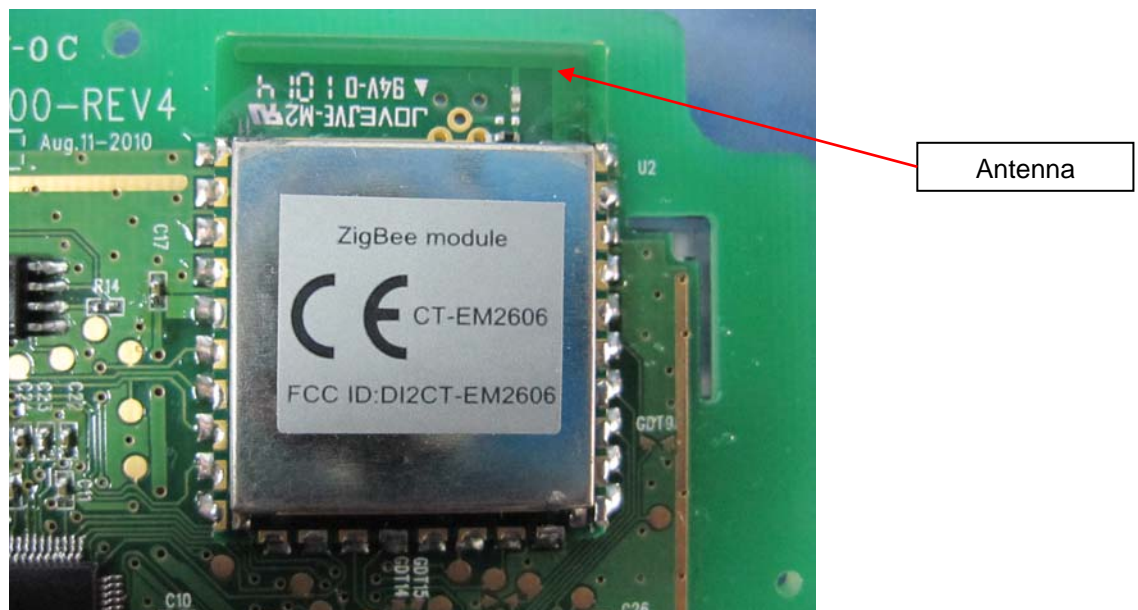

5. Test Setup Photos of the EUT

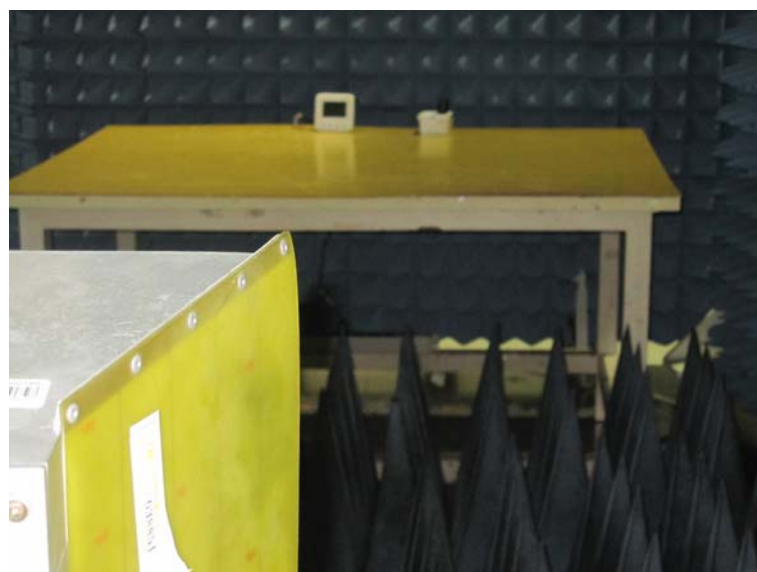
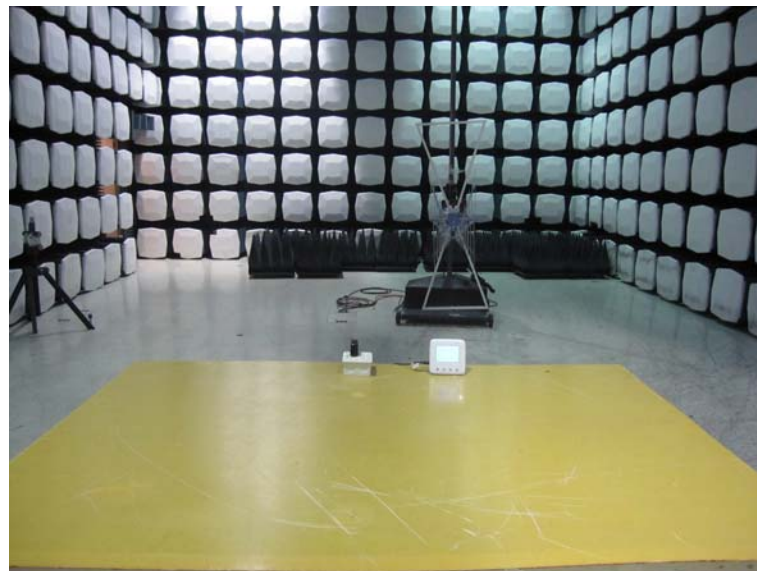

6. External and Internal Photos of the EUT

External Photos







Internal Photos

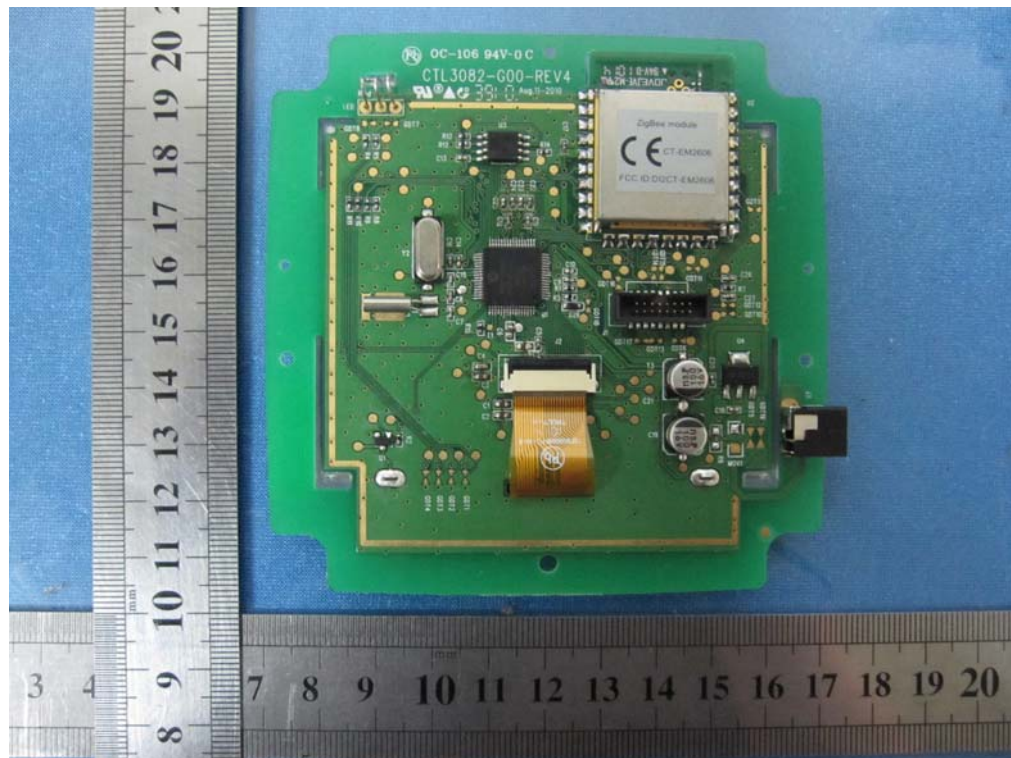

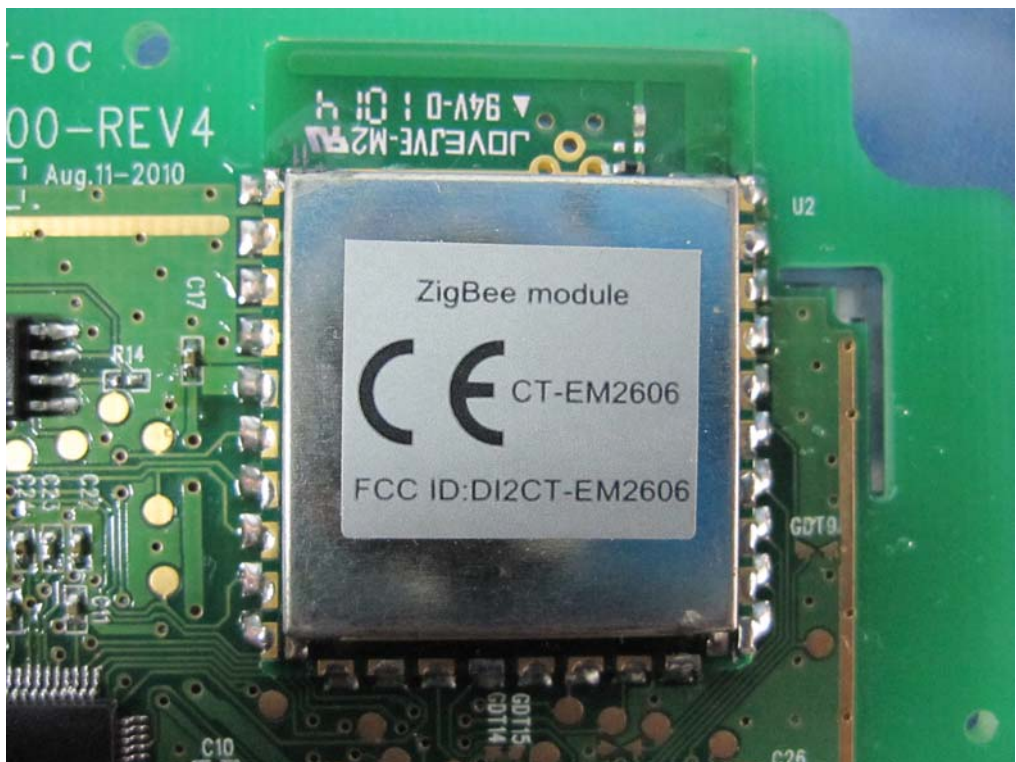
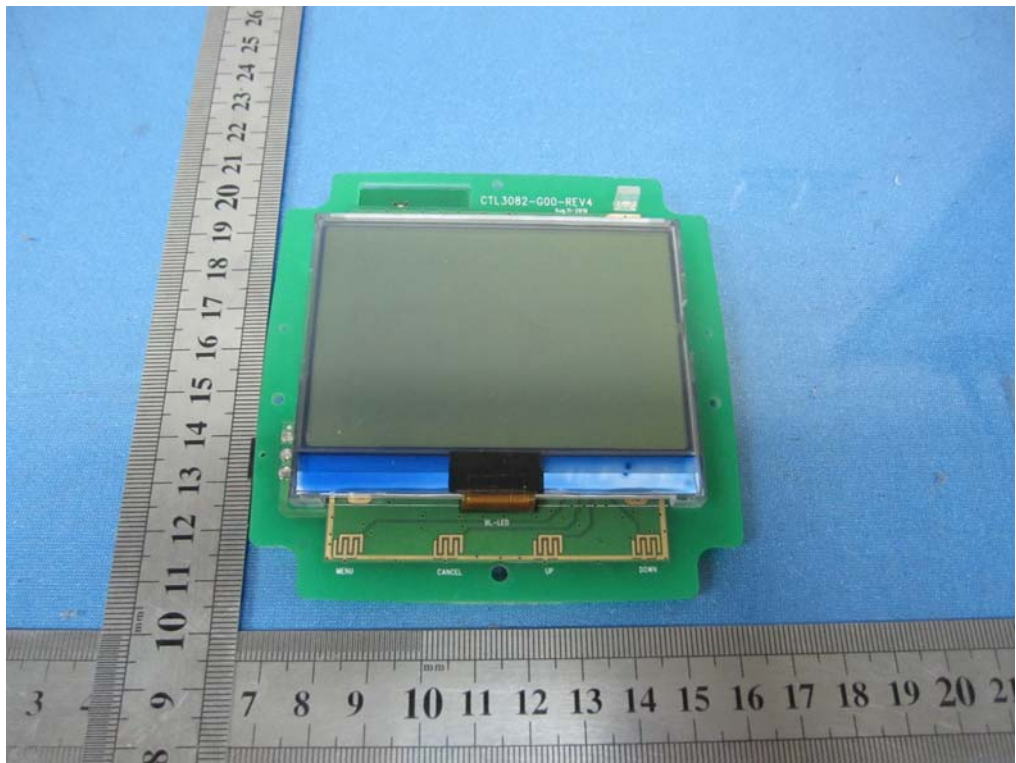

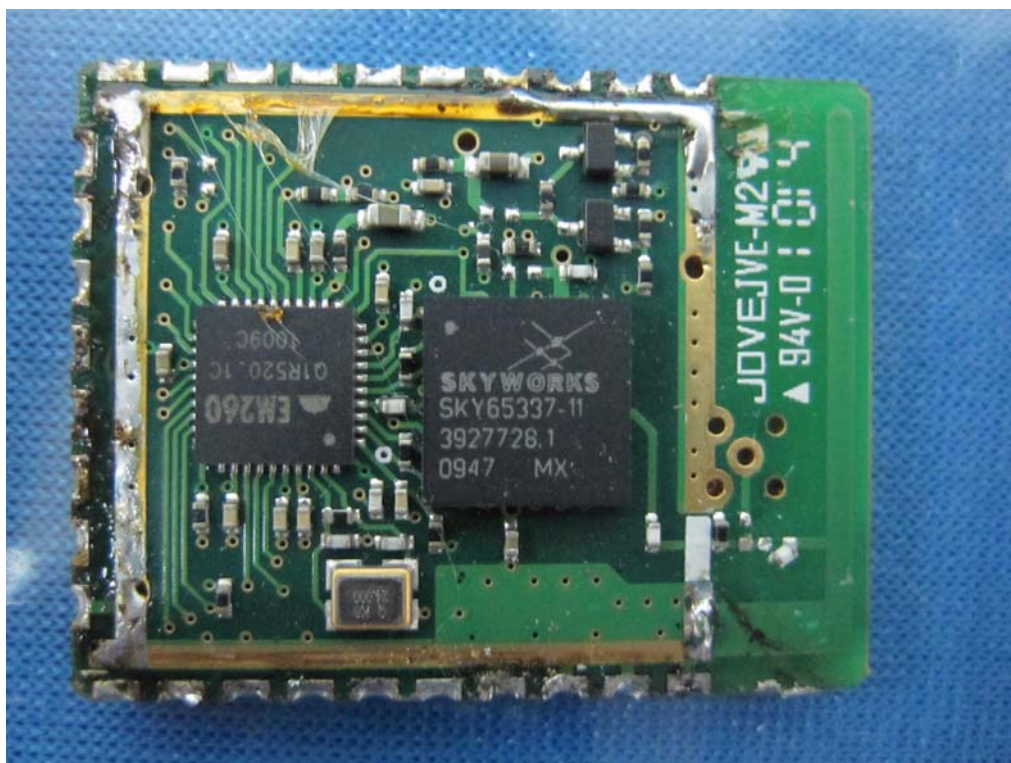

.....End of Report.....