

ONE
FOR ALL *home* **Producer™** 8

**Universal IR/RF Remote Control
System Instruction Manual**



CONTENTS

INSTALLING THE BATTERIES3

USING YOUR HOME PRODUCER™4

 Features and Functions4

SETTING THE CLOCK.....7

QUICK SET UP8

SETTING UP INDIVIDUAL HOME ENTERTAINMENT COMPONENTS10

 To Set Up Your Television10

 To Set Up Your VCR or TV/VCR Combinations12

 To Set Up Your Cable Box15

 To Set Up Your DSS or Satellite Receiver16

 To Set Up Your Laser Disc Player18

 To Set Up Your CD Player19

 To Set Up Your Tuner/Receiver21

 To Set Up Your Amplifier22

SETTING UP ADDITIONAL HOME ENTERTAINMENT COMPONENTS24

 Re-Assigning Device Keys25

SEARCHING FOR YOUR CODE27

 Finding Out Your Code28

SETTING UP THE HOME THEATER MODE KEY29

 Power Key Macro.....31

LEARNING FUNCTIONS ONTO THE L1 THROUGH L6 KEYS.....32

 Deleting Features From The L Keys34

SETTING UP TIMED SEQUENCES35

 To Delete a Timed Sequence37

REPEATING A SERIES OF KEY PRESSES (AUD AND VID KEYS)38

HOW TO USE THE SHIFT KEY39

HOW TO USE THE SLEEP KEY40

 Sleep Lock40

VOLUME LOCK41

KEYMOVER43

CLEAR ALL44

SETTING UP AND USING THE IR/RF COMMAND CENTER.....45

COMPLIANCE WITH THE FCC RULES AND REGULATIONS.....48

SPECIFICATIONS48

TROUBLESHOOTING49

ERROR MESSAGES51

KEY INDEX

 TV Functions52

 VCR Functions54

 Cable Functions56

 Laser Disc/Cassette/DVD Functions58

 DSS & Satellite Functions60

 Receiver/Tuner Functions.....60

 Amplifier Functions.....61

 CD Functions63

 Home Automation Functions64

WARRANTY65

INSTALLING THE BATTERIES

Your *Home Producer* requires four (4) new AAA alkaline batteries. To install the batteries:

1

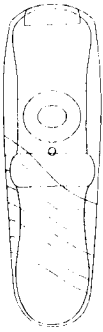

On the back of the *Home Producer*, press down on the black battery cover near the indentation where the black and silver sections meet and push/slide the cover off (see illustration).

2

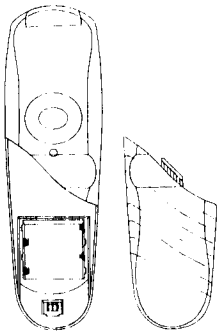

Match the + and - marks on the batteries to the + and - marks in the battery case, then insert the batteries.

3

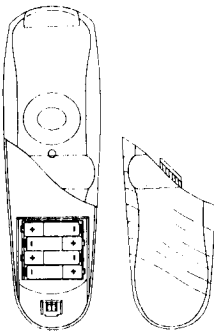

Slide the battery cover back into place.

4



Test the unit by pressing **POWER**. If the batteries are inserted correctly, the red light will blink.

NOTE: After inserting the batteries, the LCD screen will enter a test mode, which tests each segment of the LCD screen. This process will last for 10 seconds or until any key is pressed, whichever occurs first.

4

USING YOUR HOME PRODUCER

Features and Functions

The illustration below and the chart on the next two pages describe the features and the functions of the *Home Producer's* keypad. The following keys will always have the same function, regardless of which component you are controlling. For an explanation of what each key does by component type, please use the index at the rear of the manual (pages 52 to 64).

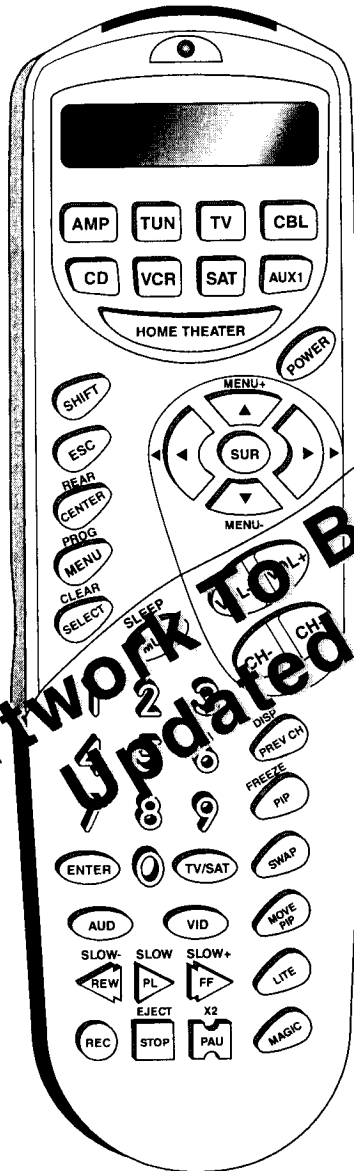

Feature Function



The **MAGIC** key is used to access the menu and program your *Home Producer*.



The **TV, VCR, CBL, SAT, AMP, TUN, CD,** and **DVD/LD** keys are used to select the home entertainment component you want to control. If your component does not respond when you press a key on the remote control, press the **TV, VCR, CBL, SAT, AMP, TUN, CD,** or **DVD/LD** key to tell the remote control which component you would like to operate.



The **HOME THEATER** key is used to select the Home Theater mode of the Home Producer.



The **ESC** (Escape) key is used to exit the LCD Screen menu.



The **LITE** key is used to turn ON and OFF the *Home Producer's* backlit keypad and LCD screen. Press the **LITE** key once to turn ON the backlight. The *Home Producer's* backlight will stay on for 10 seconds after the last key press and re-activates with the press of a key. To de-activate the backlight, press the **LITE** key again.



The **POWER** key controls power ON and OFF.



The **VOL +** (Volume Up), **VOL -** (Volume Down) and **MUTE** keys control the volume the same as the Volume Up and Down and Mute keys on your original remote.



6

Feature	Function
---------	----------



The **CH +** (Channel Up) and **CH -** (Channel Down) keys change channels the same as the Channel Up and Down keys on your original remote.



The **AUD** and **VID** macro keys memorize up to 15 keystrokes that can be accessed in sequence at the press of a single key. **These keys are not mode specific.**











The **SHIFT** key accesses advanced features that are mapped under the following keys: **CENTER, MENU, SELECT, MUTE, PREV CH, PIP, REW, PLAY, FF, STOP, and PAUSE.**

NOTE: For a detailed explanation of what function each key will perform by device type (e.g., TV, VCR CBL, etc.), please refer to pages 52 through 64.

SETTING THE CLOCK

To set up the CLOCK/TIME on the display screen:

- 1  Press and hold **MAGIC** until the display screen changes from [DEVICE and the TIME] to [TIMED SEQ].
- 2  **x2** Press the **MENU -** key twice, the display will change to [CONFIGURE]. Press **SELECT**, the display will change to [THEATR SEL].

- 3  Press **MENU -** one time, the display will change to [TIME SETUP]. Press **SELECT** again.

- 4 **0 - 9** The display will change to [TIME] and the first digit in the time will blink. Enter either a **0** or a **1**, then the next digit in the time will begin to blink, continue entering the time until all four digits of the time have been set.
- 5  After the time has been set, AM/PM will then blink. Press **MENU -** to toggle between AM and PM, once AM or PM is selected, press **SELECT**.

- 6  The display will then change to the day of the week (MON, TUE, WED, THU, FRI, SAT or SUN). Use **MENU -** to toggle through the days until the proper day of the week is displayed on the screen, then press **SELECT**. The display will return to the [DEVICE and the TIME] screen with the correct time on the display.











NOTE: After changing the batteries, you will have to reprogram the clock.

8

QUICK SET-UP

To Quickly Set Up the Home Producer to Operate Your Home Entertainment Components

NOTE: If the four-digit code for your device begins with a "0", only the last three numbers of your code will be displayed.

- 1 Turn on all of the components that you will be setting up.
- 2  Press and release the **TV** key.
- 3  Press and hold **MAGIC** until the display screen changes from [TV and the TIME] to [TIMED SEQ].
- 4  Press the **MENU** – key one time. The display screen will change to [CODE SET UP]. Press **SELECT**. The display will change to [DEV SETUP]. Press **SELECT**. The display will change to [TV].

- 5  Enter the first TV code listed for your brand in the "Set Up Codes for TVs" on pages 10-12, then press **SELECT**. Point the remote control at the TV and press **POWER**. Your Television should turn OFF. If your TV does not turn OFF, enter the next code in the code list then press **SELECT** followed by **POWER** again. Once your TV turns OFF, press **VCR**. You will now enter your VCR code.

- 6  Enter the first VCR code listed for your brand in the "Set Up Codes for VCRs" on pages 13-14, then press **SELECT**. Point the remote control at the VCR and press **POWER**. Your VCR should turn OFF. If your VCR does not turn OFF, enter the next code in the code list then press **SELECT** followed by **POWER** again. Once your VCR turns OFF, press **CBL**. You will now enter your Cable Box code.



7



Continue to enter your codes as illustrated in Steps 5 and 6 until the *Home Producer* is operating all of your home entertainment components. Once you have finished setting up your components, press **ESC** to return to the [DEVICE and TIME] display.









If you would like to setup each of your components individually, or if you purchase a component after you have set up the A/V Producer, set the "SETTING UP INDIVIDUAL HOME ENTERTAINMENT COMPONENTS" section on pages 10 to 23 in this manual.

Set Up Codes for TVsPage 10
 Set Up Codes for VCRsPage 13
 Set Up Codes for Cable BoxesPage 16
 Set Up Codes for DSS and
 Satellite ReceiversPage 17
 Set Up Codes for DVD or LD PlayersPage 19
 Set Up Codes for CD PlayersPage 20
 Set Up Codes for Tuner/Receivers.....Page 22
 Set Up Codes for Amplifiers.....Page 23

SETTING UP INDIVIDUAL HOME ENTERTAINMENT COMPONENTS

To Set Up Your Television:

NOTE: If the four-digit code for your device begins with a "0", only the last three numbers of your code will be displayed.

- 1 Turn on your TV.
- 2  Press and release the **TV** key.
- 3  Press and hold **MAGIC** until the display screen changes from [TV and the TIME] to [TIMED SEQ].
- 4  Press the **MENU** – key one time. The display screen will change to [CODE SET UP]. Press **SELECT**.
 The display will change to [DEV SET UP].
- 5  Press **SELECT** and the display screen will change to [TV].
- 6  Enter the first TV code listed for your brand in the "Set Up Codes for TVs" on pages 10-12, then press **SELECT**.
- 7  Aim the remote control at the TV and press **POWER**. Your TV should turn OFF. Press **ESC** to return the display to [TV and the TIME]. If your TV does not turn OFF, enter the next code in the code list then press **SELECT** followed by **POWER** again. Once the correct code is entered, press **ESC** to return the display to [TV and TIME].

For a detailed explanation of what function each key will perform in the TV mode, please refer to page 52.

Set Up Codes for TVs

A-Mark	0003	Ambassador	0177
AOC	0030, 0019, 0003, 0052	Ampro	0751
	0185	Anam	0180
Abex	0032	Anam National	0055
Admiral	0093	Archer	0003
Adventura	0046	Audiovox	0451, 0180, 0003, 0092, 0623
Aiko	0092		
Akai	0030	Aumark	0060
Alaron	0179	Baysonic	0180
Allegro	0720, 0774	Belcor	0019

Set Up Codes for TVs (cont.)





Bell & Howell	0154, 0016	Kenwood	0030, 0019
Bradford	0180	Kloss	0024, 0046
Brockwood	0019	LG	0056
Broksonic	0236, 0463, 0003	LXI	0047, 0054, 0017, 0154, 0156, 0178, 1347
CCE	0217	Logik	0016
CXC	0180	Luxman	0056
Candle	0030, 0056, 0046, 0186	MEI	0185
Capehart	0052	MGA	0150, 0030, 0178, 0019
Carnivale	0030	MTC	0060, 0030, 0019, 0056, 0185
Carver	0054	Magnavox	0054, 0030, 0179, 0020, 0024, 0096, 0186, 0187, 0386
Celebrity	0000	Majestic	0016
Cineral	0451, 0092	Marantz	0054, 0030
Citizen	0060, 0030, 0056, 0039, 0046, 0092, 0186, 0280	Matsushita	0051, 0250
Clairtone	0185	Megatron	0178, 0145, 0003
Concerto	0056	Memorex	0154, 0250, 0150, 0060, 0178, 0056, 0016
Contec	0180, 0157, 0185	Midland	0047, 0017, 0051, 0039, 0032, 0135
Craig	0180	Minutz	0021
Crosley	0054	Mitsubishi	0093, 0150, 0178, 0019
Crown	0180, 0039	Motorola	0093, 0055
Curtis Mathes	0047, 0054, 0154, 0051, 0451, 0093, 0060, 0030, 0145, 0056, 0016, 0039, 0166, 0466, 1147, 1347	Multitech	0180, 0217
Daewoo	0451, 0019, 0039, 0092, 0623, 0624	NAD	0156, 0178, 0166
Daytron	0019, 0039	NEC	0030, 0019, 0056, 0497
Denon	0145	NTC	0092
Dumont	0017, 0019	Nikko	0047, 0017, 0154, 0156, 0030, 0178, 0092, 1347
Dwin	0720, 0774	Noshi	0018
Dynatech	0217	Onwa	0180
Electroband	0000, 0185	Optimus	0154, 0250, 0166
Electrohome	0381	Optonica	0093, 0165
Emerson	0154, 0236, 0463, 0180, 0282, 0178, 0019, 0179, 0039, 0038, 0177, 0185, 0280, 0623, 0624	Orion	0236, 0463, 0179
Envision	0030	Panasonic	0047, 0054, 0154, 0156, 0051, 0250, 0093, 0165, 0150, 0060, 0053, 0178, 0145, 0055, 0001, 1347
Fisher	0154, 0159	Penney	0047, 0156, 0051, 0060, 0030, 0178, 0021, 0019, 0018, 0056, 0039, 0003, 0027, 0032, 0135, 1347
Fujitsu	0179	Philco	0054, 0463, 0030, 0145, 0019, 0020, 0024, 0096, 0186, 0187
Funai	0180, 0179, 0171	Philips	0054, 0017, 0000, 0021, 0019, 0018, 0039, 0020, 0024, 0027, 0052
Futuretech	0180	Pilot	0030, 0019, 0039
GE	0047, 0051, 0451, 0093, 0282, 0178, 0021, 0055, 0027, 0135, 1147, 1347	Pioneer	0038, 0166
Gibraltar	0017, 0030, 0019	Portland	0019, 0039, 0092
Go Video	0060	Prism	0051
GoldStar	0030, 0178, 0019, 0056, 0039, 0001, 0032	Proscan	0047, 0030, 1347
Gradiente	0053, 0056	Proton	0178, 0003, 0052, 0466
Grunpy	0180, 0179	Pulsar	0017, 0019
Hallmark	0178	Quasar	0051, 0250, 0165, 0055
Harley Davidson	0179	RCA	0047, 0051, 0093, 0019, 0018, 0038, 0090, 0135, 1047, 1147, 1247, 1347
Harman/Kardon	0054	Radio Shack	0047, 0154, 0165, 0180, 0030, 0178, 0019, 0056, 0039, 0032
Harvard	0180	Realistic	0154, 0165, 0180, 0030, 0178, 0019, 0056, 0039, 0032
Hitachi	0145, 0056, 0032, 0038, 0151	Rhapsody	0185
Infinity	0054		
Inteq	0017		
JBL	0054		
JCB	0000		
JVC	0053		
Janeil	0046		
KEC	0180		
KTV	0180, 0030, 0039, 0185, 0217, 0280		
Kaypani	0052		

Set Up Codes for TVs (cont.):

Runco	0017, 0030, 0497, 0603	TMK	0178, 0056, 0177
SSS	0180, 0019	Tandy	0093
Sampo	0030, 0039, 0032, 0052	Tatung	0055, 0003
Samsung	0060, 0030, 0178, 0019, 0056, 0039, 0032	Technics	0047, 0017, 0051, 0250, 1347
Samsux	0039	Technol Ace	0179
Sansei	0451	Techwood	0051, 0056, 0003
Sansui	0463	Teknika	0054, 0180, 0150, 0060, 0019, 0179, 0056, 0016, 0039, 0092, 0186
Sanyo	0154, 0146, 0159	Telefunken	0056
Scimitsu	0019	Toshiba	0154, 0156, 0060
Scotch	0178	Tosonic	0185
Scott	0236, 0180, 0178, 0019, 0179	Totevision	0039
Sears	0047, 0054, 0154, 0156, 0178, 0179, 0056, 0146, 0159, 0171	Trical	0157
Semivox	0180	Universal	0021, 0027
Semp	0156	Vector Research	0030
Sharp	0093, 0165, 0039, 0157, 0386	Victor	0053
Shogun	0019	Vidikron	0054
Signature	0016	Vidtech	0178, 0019
Simpson	0186, 0187	Viking	0046
Sony	0000, 0080, 0111	Wards	0054, 0156, 0165, 0030, 0178, 0021, 0019, 0179, 0056, 0016, 0020, 0027, 0080, 0096, 0111, 0135, 0187
Soundesign	0180, 0178, 0179, 0186	White	
Spectricon	0003	Westinghouse	0623, 0624
Squareview	0171	Yamaha	0030, 0019
Starlite	0180	Zenith	0017, 0016, 0092, 0146
Supre-Macy	0046	Zonda	0003
Supreme	0000		
Sylvania	0054, 0030, 0020, 0024, 0096, 0186, 0187, 0381		
Symphonic	0171		

To Set Up Your VCR or TV/VCR Combinations:

NOTE: If the four-digit code for your device begins with a "0", only the last three numbers of your code will be displayed.

- 1 Turn on your VCR and insert a tape.
- 2  Press and release the **VCR** key.
- 3  Press and hold **MAGIC** until the display screen changes from [VCR and the TIME] to [TIMED SEQ].
- 4  Press the **MENU** – key one time. The display screen will change to [CODE SET UP]. Press **SELECT**.
 The display will change to [DEV SET UP].
- 5  Press **SELECT** and the display screen will change to [VCR].



Enter the first VCR code listed for your brand in the "Set Up Codes for VCRs" below or "Set Up Codes for TV/VCR Combinations" on the next page, then press **SELECT**. Aim the remote control at the VCR and press **POWER** or **PLAY**. Your VCR should turn OFF or start to play. Press the **ESC** key to return the display to [VCR and the TIME]. If your VCR does not turn OFF or start to play, enter the next code in the code list then press **SELECT** followed by **POWER** or **PLAY** again. Once the correct code is entered, press the **ESC** key to return the display to [VCR and the TIME].

For a detailed explanation of what function each key will perform in the VCR mode, please refer to page 54 in the "Key Index".

Set Up Codes For VCRs

Admiral	0048	Garrard	0000
Adventura	0000	Go Video	0432, 0526
Aiko	0278	GoldStar	0037, 0038
Aiwa	0037, 0000, 0307	Gradiente	0000, 0008
Akai	0041, 0061, 0106	Hi-Q	0047
American High	0035	Harley Davidson	0000
Asha	0240	Harman/Kardon	0081, 0038
Audiovox	0037	Harwood	0072, 0068
Beaumont	0240	Headquarter	0046
Bell & Howell	0104	Hitachi	0000, 0042, 0041, 0105
Broksonic	0184, 0121, 0209, 0002, 0295, 0479	JVC	0067, 0041, 0008
CCE	0072, 0278	Jensen	0041
Calix	0037	KEC	0037, 0278
Canon	0035	KLH	0072
Capehart	0020	Kenwood	0067, 0041, 0038, 0046
Carver	0081	Kodak	0035, 0037
Cineral	0278	LXI	0037
Citizen	0037, 0278	Lloyd's	0000, 0208
Colt	0072	Logik	0072
Craig	0037, 0047, 0240, 0072, 0271	MEI	0035
Curtis Mathes	0060, 0035, 0041, 0162	MGA	0240, 0043, 0061
Cybernex	0240	MGN Technology	0240
Daewoo	0045, 0278, 0020, 0561	MTC	0240, 0000
Daytron	0020	Magnasonic	0278, 0593
Denon	0042	Magnavox	0035, 0039, 0081, 0000, 0149, 0110
Dynatech	0000	Magnin	0240
Electrohome	0037	Marantz	0035, 0081, 0038
Electrophonic	0037	Marta	0037
Emerex	0032	Matsushita	0035, 0162, 0454
Emerson	0037, 0184, 0000, 0121, 0043, 0209, 0002, 0278, 0036, 0061, 0068, 0208, 0212, 0295, 0479, 0561	Memorex	0035, 0037, 0048, 0039, 0047, 0240, 0000, 0104, 0046, 0307, 1037, 1162, 1262
Fisher	0047, 0104, 0054, 0066	Minolta	0042, 0105
Fuji	0035, 0033	Mitsubishi	0048, 0067, 0043, 0061
Funai	0000	Motorola	0035, 0048
GE	0060, 0035, 0048, 0240, 0202	Multitech	0000, 0072
		NAP	0035, 0037, 0039, 0042, 0033, 0034, 0066, 0105

14









Set Up Codes For VCRs (Cont.)

NEC	0104, 0067, 0041, 0038, 0040	Sanyo	0047, 0240, 0104, 0046
Nikko	0037	Scott	0184, 0045, 0121, 0043, 0210, 0212
Nikon	0034, 0253	Sears	0035, 0037, 0047, 0000, 0042, 0104, 0046, 0054, 0066, 0105
Noblex	0240	Semp	0045
Olympus	0035	Sharp	0048, 0062
Optimus	0037, 0048, 0104, 0162, 0432, 0454, 0593, 1048, 1062, 1162, 1262	Shintom	0072
Optonica	0062	Shogun	0240
Orion	0184, 0002, 0295, 0479	Signature	0035
Panasonic	0035, 0162, 0077, 0225, 0454, 1162	Singer	0072
Penney	0035, 0037, 0240, 0042, 0038, 0040, 0054	Sony	0035, 0032, 0000, 0033, 0034, 0253
Pentax	0042, 0105	Sunpak	0253
Philco	0035, 0209, 0479	Sylvania	0035, 0081, 0000, 0043, 0110
Philips	0035, 0081, 0062, 0110	Symphonic	0000, 0593
Pilot	0037	TMK	0240, 0036, 0208
Pioneer	0067	Tatung	0041
Portland	0020	Teac	0000, 0041
Profitronic	0240	Technics	0060, 0035, 0039, 0162, 0202
Proscan	0060, 0202	Teknika	0035, 0037, 0000
Protec	0072	Thomas	0000
Pulsar	0039	Toshiba	0045, 0043, 0066, 0210, 0212
Quarter	0046	Totevision	0037, 0240
Quartz	0046	Unitech	0240
Quasar	0035, 0162, 0077, 0454, 1162	Vector	0045
RCA	0060, 0035, 0048, 0240, 0042, 0149, 0077, 0105, 0106, 0202	Vector Research	0038, 0040
Radio Shack	0000, 1037	Video Concepts	0045, 0040, 0061
Radix	0037	Videosonic	0240
Randex	0037	Wards	0060, 0035, 0048, 0047, 0081, 0240, 0045, 0000, 0042, 0072, 0149, 0062, 0212
Realistic	0035, 0037, 0048, 0047, 0000, 0104, 0062, 0046, 0066	White	
Ricoh	0034, 0253	Westinghouse	0278
Runco	0039	XR-1000	0035, 0000, 0072
STS	0042	Yamaha	0041, 0038
Samsung	0240, 0045	Zenith	0039, 0000, 0033, 0034, 0479
Sanky	0048, 0039		
Sansui	0000, 0067, 0041, 0271, 0479		

Set Up Codes for TV/VCR Combinations:

To Set Up Your Cable Box:

NOTE: If the four-digit code for your device begins with a "0", only the last three numbers of your code will be displayed.

- 1 Turn on your Cable Box.
- 2  Press and release the **CBL** key.
- 3  Press and hold **MAGIC** until the display screen changes from [CABLE and the TIME] to [TIMED SEQ].
- 4  Press the **MENU** – key one time. The display screen will change to [CODE SET UP]. Press **SELECT**.
 The display will change to [DEV SET UP].
- 5  Press **SELECT** and the display screen will change to [CABLE].
- 6  Enter the first Cable Box code listed for your brand in the "Set Up Codes for Cable Boxes" on page 16, the press **SELECT**.
- 7  Point the remote control at the Cable Box and press **POWER**. Your Cable Box should turn OFF. If your Cable Box turns OFF, press the **ESC** key to return the display to [CABLE and the TIME]. If your Cable Box does not turn OFF, enter the next code in the code list then press **SELECT** followed by **POWER** again. Once the correct code is entered, press the **ESC** key to return the display to [CABLE and the TIME].

NOTE: If your original Scientific Atlanta remote control does not have an "ON" key, press **CH+** or one of the digit keys on the Home Producer to turn your Cable Box on.



For a detailed explanation of what function each key will perform in the Cable mode, please refer to page 56 in the "Key Index".







Set Up Codes For Cable Boxes

ABC	0003, 0008, 0014, 0017, 0007, 0011, 0001, 0013	Philips	0153, 0025, 0027, 0031
Allegro	0153, 0315	Pioneer	0144, 0023, 0533
Antronix	0022, 0207	Popular	
Archer	0153, 0022, 0207, 0797	Mechanics	0400
Belcor	0056	Proscan	0021
Bell & Howell	0014	Pulsar	0000
Cable Star	0056	Quasar	0000
Cabletenna	0022	RCA	0021
Cableview	0022	Radio Shack	0015, 0315, 0797, 0883
Century	0153	Realistic	0207
Citizen	0153, 0315	Recoton	0400
Colour Voice	0025, 0031	Regal	0020, 0259
Comtronics	0040	Regency	0002
Contec	0019	Rembrandt	0011
Digi	0637	Runco	0000
Eastern	0002	SL Marx	0040
Emerson	0797	Samsung	0144, 0040
Everquest	0015, 0040	Scientific	
Focus	0400	Atlanta	0008, 0477, 0017
GC Electronics	0056, 0207	Seam	0510
Garrard	0153	Signal	0015, 0040
Gemini	0015	Signature	0011
General		Sprucer	0021
Instrument	0476, 0276, 0011, 0810	Starcom	0003, 0015
GoldStar	0144, 0040	Stargate	0015, 0040, 0797
Goodmind	0797	Starquest	0015
Hamlin	0020, 0259, 0009, 0034	Sylvania	0001
Hitachi	0011	TFC	0310
Hytex	0007	TV86	0063
Jasco	0015, 0153, 0315	Tandy	0258
Jerrold	0003, 0012, 0476, 0276, 0014, 0015, 0011, 0810	Teleview	0040
Linsay	0440	Texscan	0001
Magnavox	0014, 0027	Timeless	0418
Memorex	0000	Tocom	0012, 0013
Movie Time	0063, 0156	Toshiba	0000
NAP	0007	Tusa	0015
NSC	0063, 0156	Unika	0153, 0022, 0207
Novaplex	0618	United Artists	0007
Oak	0019, 0007	Universal	0153, 0022, 0056, 0191, 0207
Optimus	0021	Videoway	0250
Panasonic	0000, 0107, 0021	Viewstar	0063, 0027, 0258
Panther	0637	Zenith	0008, 0000, 0015, 0207, 0525
Paragon	0000	Zentek	0400

To Set Up Your DSS or Satellite Receiver:

NOTE: If the four-digit code for your device begins with a "0", only the last three numbers of your code will be displayed.

- 1 Turn on your DSS or Satellite Receiver.
- 2  Press and release the **SAT** key.
- 3  Press and hold **MAGIC** until the display screen changes from [SAT and the TIME] to [TIMED SEQ].

- 4  Press the **MENU -** key. The display screen will change to [CODE SET UP]. Press **SELECT**. The display will change to [DEV SET UP].

- 5  Press **SELECT** and the display screen will change to [SAT].
- 6  Enter the first Satellite code listed for your brand in the "Set Up Codes for Satellites" on page 17, then press **SELECT**. Point the remote control at the Satellite and press **POWER**. Your Satellite should turn OFF. If your Satellite turns OFF, press the **ESC** key to return the display to [SAT and the TIME]. If your Satellite does not turn OFF, enter the next code in the code list then press **SELECT** followed by **POWER** again. Once the correct code is entered, press the **ESC** key to return the display to [SAT and the TIME].



For a detailed explanation of what function each key will perform in the Satellite mode, please refer to page 59 in the "Key Index".









Set Up Codes for DSS and Satellite Receivers

AlphaStar	0772	Jerrold	0627, 0361
Astro Industries	0095	Legend	0269
BSR	0095	Macom	0018
Capetronic	0095	Magnavox	0724, 0722
Channel Master	0018, 0212	Memorex	0724, 0269
Chaparral	0053, 0209, 0216	Next Level	0869
DX Antenn	0041	Panasonic	0701, 0152
Drake	0018, 0064, 0149, 0245	Philips	0724, 0722, 0200
Echosta	0775, 0148, 0159, 0269, 0280	President	0074
Expressvu	0775	Primestar	0627, 0361
General		Proscan	0566
Instrument	0627, 0361, 0869	RCA	0566, 0143, 0392, 0855
HTS	0775	Radio Shack	0566, 0869
Hitachi	0819	Realistic	0052
Homecable	0238	STS	0041, 0210
Hughes		Sony	0639
Network Sys.	0749	Star Choice	0869
HYTEK	0095	Star Trak	0180
IQ	0210	Toshiba	0790, 0082
IQ Prism	0210	Uniden	0724, 0722, 0052, 0074, 0076, 0238, 0370
JVC	0775	Zenith	0064, 0245, 0856
Janeil	0152		

18

To Set Up Your DVD or LD Player:

NOTE: If the four-digit code for your device begins with a "0", only the last three numbers of your code will be displayed.

- 1 Turn on your DVD or LD Player and insert a disc.
 - 2  Press and release the **DVD/LD** key.
 - 3  Press and hold **MAGIC** until the display screen changes from [DVD/LDP and the TIME] to [TIMED SEQ].
 - 4  Press the **MENU** – key one time. The display screen will change to [CODE SET UP]. Press **SELECT**. The display will change to [DEV SET UP].
 - 5  Press **SELECT** and the display screen will change to [DVD/LDP].
 - 6  Enter the first DVD or LD code listed for your brand in the "Set Up Codes for DVD Players" or "Set Up Codes for LD Players" on the next page, then press **SELECT**. Aim the remote control at the DVD or LD player and press **POWER** or **PLAY**. Your player should turn OFF or start to play your disc. Press the **ESC** key to return the display to [DVD/LDP and the TIME]. If your player does not turn OFF or start to play your disc, enter the next code in the code list then press **SELECT** followed by **POWER** or **PLAY** again. Once the correct code is entered, press the **ESC** key to return the display to [DVD/LDP and the TIME].
-  **POWER** or  **PL**
-  **ESC**

For a detailed explanation of what function each key will perform in the DVD/LDP mode, please refer to page 58 in the "Key Index".

Set Up Codes for DVD Players





Harman/Kardon	0582	Proscan	0522
JVC	0558	RCA	0522
Kenwood	0534	Samsung	0573
Magnavox	0503	Sony	0533
Mitsubishi	0521	Technics	0490
Onkyo	503	Theta Digital	0571
Optimus	0525	Toshiba	0503
Panasonic	0490	Yamaha	0490, 0545
Philips	0503, 0539	Zenith	0503, 0591
Pioneer	0525, 0571		

Set Up Codes for LD Players

Aiwa	0203	Panasonic	0204
Carver	0064, 0194, 0323	Philips	0064, 0194
Denon	0059, 0172	Pioneer	0059, 0023
Disco Vision	0023	Quasar	0204
Funai	0203	Realistic	0203
Harman/Kardon	0194	Samsung	0323
Hitachi	0023	Sega	0023
Magnavox	0194, 0217	Sony	0193, 0201
Marantz	0064, 0194	Technics	0204
Mitsubishi	0059	Theta Digital	0194
NAD	0059	Yamaha	0217

To Set Up Your CD Player:

NOTE: If the four-digit code for your device begins with a "0", only the last three numbers of your code will be displayed.

- 1 Turn on your CD Player and insert a disc.
- 2  Press and release the **CD** key.
- 3  Press and hold **MAGIC** until the display screen changes from [CD and the TIME] to [TIMED SEQ].
- 4  Press the **MENU** – key one time. The display screen will change to [CODE SET UP]. Press **SELECT**. The display will change to [DEV SET UP].
- 5  Press **SELECT** and the display screen will change to [CD].
- 6  Enter the first CD code listed for your brand in the "Set Up Codes for CD Players" on the next page, then press **SELECT**.

20

To Set Up Your CD Player (cont.):

7



or



Aim the remote control at the CD player and press **POWER** or **PLAY**. Your CD player should turn OFF or start to play your disc. Press the **ESC** key to return the display to [CD and the TIME]. If your CD player does not turn OFF or start to play your disc, enter the next code in the code list then press **SELECT** followed by **POWER** or **PLAY** again. Once the correct code is entered, press the **ESC** key to return the display to [CD and the TIME].

For a detailed explanation of what function each key will perform in the CD mode, please refer to page 63 in the "Key Index".

Set Up Codes for CD Players







ADC	0018	Magnavox	0157, 0305
Adcom	0155, 0234	Marantz	0029, 0157, 0180
Aiwa	0157, 0012, 0124	McIntosh	0287
Akai	0156	Mission	0157
Audio Alchemy	0194	NEC	0043, 0234
Audio-Technica	0170	NSM	0157
BSR	0194, 0245	Nakamichi	0147
Bang & Olufsen	0212	Nikko	0164, 0170, 0174
Burmester	0420	Onkyo	0101, 0868
California		Optimus	000, 0032, 0179, 0305, 0037, 0420, 0145, 0468, 0087, 0175, 0194, 0196, 0280, 0342, 0426, 0437
Audio Labs	0029		
Carrera	0194	Panasonic	0029, 0303, 0367, 0752
Carver	0157, 0179, 0437	Parasound	0420, 0194
Crown	0122	Philips	0157, 0287, 0626
Curtis Mathes	0029	Pioneer	0032, 0305, 0468, 0244
DAK	0245	Proscan	0053
DBX	0254	Proton	0157
DKK	0000	QED	0157
Denon	0003, 0873	Quasar	0029
Emerson	0305, 0155, 0164, 0469	RCA	0179, 0305, 0053, 0009, 0155, 0764
Fisher	0179, 0088, 0174, 0342		
GE	0009	Realistic	0179, 0420, 0155, 0164, 0175, 0180
Garrard	0420, 0393, 0245, 0280, 0425	Rotel	0157, 0420
Genexxa	0032, 0305, 0164	SAE	0157
GoldStar	0417	STS	0018
Harman/Kardon	0157, 0173, 0426	Sansui	0157, 0305, 0202
Hitachi	0032, 0155	Sanyo	0179, 0087
JVC	0072, 0655, 0658	Scott	0305, 0155, 0164
Kenwood	0028, 0037, 0190, 0826, 0681	Sears	0305
Kodak	0287	Sharp	0037, 0180, 0861
Krell	0157	Sherwood	0180, 0196, 0426
Kyocera	0018	Shure	0043
LXI	0305	Sony	0000, 0185, 0490, 0604, 0605
Linn	0157		
Luxman	0093	Soundesign	0145, 0425
MCS	0029, 0043	Sylvania	0157
MTC	0420		

Set Up Codes for CD Players (cont.)

Tascam	0420	Victor	0072
Teac	0420, 0393, 0174, 0180	Wards	0157, 0053
Technics	0029, 0207, 0303	Yamaha	0036, 0170, 0187
Vector		Yorx	0461
Research	0194, 0417		

To Set Up Your Tuner/Receiver:

NOTE: If the four-digit code for your device begins with a "0", only the last three numbers of your code will be displayed.

- 1 Turn on your Tuner/Receiver.
- 2  Press and release the **TUN** key.
- 3  Press and hold **MAGIC** until the display screen changes from [TUN and the TIME] to [TIMED SEQ].
- 4  Press the **MENU** – key one time. The display screen will change to [CODE SET UP]. Press **SELECT**. The display will change to [DEV SET UP].
- 5  Press **SELECT** and the display screen will change to [TUNER].
- 6  Enter the first Tuner code listed for your brand in the "Set Up Codes for Tuner/Receivers" on the next page, then press **SELECT**. Aim the remote control at the Tuner/Receiver and press **POWER**. Your Tuner/Receiver should turn OFF. Press the **ESC** key to return the display to [TUN and the TIME]. If your Tuner/Receiver does not turn OFF, enter the next code in the code list then press **SELECT** followed by **POWER**. Once the correct code is entered, press the **ESC** key to return the display to [TUN and the TIME].









For a detailed explanation of what function each key will perform in the Tuner mode, please refer to page 60 in the "Key Index".

Set Up Codes For Tuner/Receivers



ADC	0531	Nakamichi	0097, 0347
Adcom	0616	Onkyo	0135, 0100, 0380
Aiwa	0158, 0189, 0121, 0405	Optimus	0531, 0670, 0186, 0042, 0177, 0181, 0219, 0738, 0801, 1023
Akai	0076, 0224	Panasonic	0039, 0309, 0518
Bang & Olufsen	0898	Penney	0195
Capetronic	0531, 0195	Phillips	0189, 0391
Carver	0189, 0008, 0042, 0360	Pioneer	0531, 0014, 0150, 0630, 0080, 1023
Casio	0195	Proscan	0054
Clarinette	0195	Quasar	0039
Curtis Mathes	0039, 0080	RCA	0531, 0054, 0346, 0360, 0530
Denon	0004, 0273, 0771	Realistic	0195, 0163, 0181
Emerson	0424	Sansui	0189, 0193, 0346
Fisher	0042, 0219, 0360, 0801	Sanyo	0219, 0801
Garrard	0463, 0424	Scott	0163, 0322
Harman/Kardon	0110, 0189, 0891	Sharp	0186
Inkel	0062	Sherwood	0491, 0062, 0502
JBL	0110	Siemens	0424
JVC	0074	Sony	0158, 0168, 0474
Kenwood	0027, 0186, 0042, 0077, 0313, 0314	Soundesign	0670
Koss	0424	Teac	0463, 0163
LXI	0181	Technics	0039, 0309, 0208, 0518
Linn	0189	Victor	0074
Lloyd's	0195	Wards	0158, 0014, 0189, 0080, 0042, 0054
MCS	0039, 0346	Yamaha	0176, 0186
Magnavox	0531, 0189, 0195, 0128, 0391	Yorx	0195
Marantz	0039, 0189, 0128	Zenith	0857
Modulaire	0195		
NAD	0320		
NEC	0235		

To Set Up Your Amplifier:

NOTE: If the four-digit code for your device begins with a "0", only the last three numbers of your code will be displayed.

- 1 Turn on your Amplifier.
- 2  Press and release the **AMP** key.
- 3  Press and hold **MAGIC** until the display screen changes from [AMP and the TIME] to [TIMED SEQ].
- 4  Press the **MENU** – key one time. The display screen will change to [CODE SET UP]. Press **SELECT**.
 The display will change to [DEV SET UP].
- 5  Press **SELECT** and the display screen will change to [AMP].
- 6  Enter the first Amplifier code listed for your brand in the "Set Up Codes for Amplifiers" on the next page, then press **SELECT**.

To Set Up Your Amplifier (cont.):

- 7  Aim the remote control at the Amplifier and press **POWER**. Your Amplifier should turn OFF. Press the **ESC** key to return the display to [AMP and the TIME]. If your Amplifier does not turn OFF, enter the next code in the code list then press **SELECT** followed by **POWER**. Once the correct code is entered, press the **ESC** key to return the display to [AMP and the TIME].
- 

For a detailed explanation of what function each key will perform in the Amplifier mode, please refer to page 61 in the "Key Index".

Set Up Codes for Amplifiers

Aiwa	0406	Optimus	0395
Bose	0674	Panasonic	0308
Carver	0269	Parasound	0246
Curtis Mathes	0300	Philips	0269, 0892
Denon	0160	Pioneer	0013, 0300
GE	0078	Realistic	0395
Harman/Kardon	0892	Sansui	0321
JVC	0331	Shure	0264
Kenwood	0356	Sony	0220, 0689
Linn	0269	Soundesign	0078, 0211
Luxman	0165	Technics	0308, 0521
Magnavox	0269	Victor	0331
Marantz	0269, 0321, 0892	Wards	0013, 0078, 0211
NEC	0264	Yamaha	0354, 0133, 0143, 0504
Nakamichi	0321		

SETTING UP ADDITIONAL HOME ENTERTAINMENT COMPONENTS

Besides the device keys that are already labeled (TV, VCR, CBL, etc.), the *Home Producer* can also operate the following components: Cassette Decks, Home Automation, Digital Audio Tape, Phonographs, Video Accessories, and Miscellaneous Audio Components (e.g., Graphic Equalizers and Digital Music Service Boxes).





The Set Up codes for these devices can be accessed under the following device keys:

Cassette Decks:	Use the DVD/LD Key
Home Automation:	Use the CD Key
Digital Audio Tape:	Use the DVD/LD Key
Phonographs:	Use the CD Key
Video Accessories:	Use the CBL Key
Miscellaneous Audio:	Use the AMP Key

NOTE: Each device (TV, VCR, CBL, etc.) can only operate one component at a time. If you have already set up a component on a key, then assigning a second component on the same key will erase the code for the first component you set up. For example, if you set up a DVD Player on **DVD/LD** and then set up a Cassette Deck on **DVD/LD**, the Home Producer will only operate the Cassette Deck.

For example, to set up a Cassette Deck on the **DVD/LD** key:

NOTE: If the four-digit code for your device begins with a "0", only the last three numbers of your code will be displayed.

- 1 Turn on your Cassette Deck.
- 2  Press and release the **DVD/LD** key.
- 3  Press and hold **MAGIC** until the display screen changes from [DVD/LDP and the TIME] to [TIMED SEQ].
- 4  Press the **MENU** – key one time. The display screen will change to [CODE SET UP]. Press **SELECT**.
 The display will change to [DEV SET UP].
- 5  Press **SELECT** and the display screen will change to [DVD/LDP].

6



Press **MENU –** to toggle between [DVDP], [LDP], [TAPE], and [DAT]. Once [TAPE] is on the display screen, enter the first Cassette Deck code listed for your brand in the “Set Up Codes for Cassette Decks” on the next page, then press **SELECT**.



7



Point the remote control at the Cassette Deck and press **POWER**. Your Cassette Deck should turn OFF. Then press the **ESC** key to return the display to [TAPE and the TIME]. If your Cassette Deck does not turn OFF, enter the next code in the code list then press **SELECT** followed by **POWER** again. Once the correct code is entered, press the **ESC** key to return the display to [TAPE and the TIME].



Re-assigning Device Keys

You can use the *Home Producer* to operate a second TV or a second VCR or any combination of eight devices. To do this, you must re-assign one of the device keys (i.e., **AMP**, **TUN**, **TV**, **CBL**, **CD**, **VCR**, **SAT**, or **DVD/LD**) to operate your second device. For example, to re-assign one of the device keys to support your other components:

1



Press and hold **MAGIC** until the display screen changes from [DVD/LDP and the TIME] to [TIMED SEQ].

2



x2 Press the **MENU –** key twice. The display screen will change to [CONFIGURE]. Press **SELECT**. The display will change to [THEATER SEL].



3



x3 Press the **MENU –** key three times. The display screen will change to [MODE MAP]. Press **SELECT**. The display will change to [SOURCE].



26

Re-assigning Device Keys (cont.)

4 (Device Key) Press the device key you would like to move. The display screen will change to [COPY TO]. Press the unused device key you would like to replace. The display will change to [DEVICE2 and the TIME]. Proceed with programming the re-assigned device key with the appropriate code.

Set Up Codes for Cassette Decks

Aiwa	0029, 0197, 0200	Optimus	0027, 0220, 0337, 0439
Akai	0283	Panasonic	0229
Bang & Olufsen	0219	Philips	0029
Carver	0029	Pioneer	0027, 0220, 0099
Denon	0076	Revox	0190
Fisher	0074	Sansui	0029, 0009
Garrard	0308, 0439	Sherwood	0337
Harman/Kardon	0182, 0029	Sony	0243, 0170, 0291
JVC	0244, 0273	Teac	0308
Kenwood	0070, 0071	Technics	0229
Magnavox	0029	Victor	0273
Marantz	0029, 0009	Wards	0027
Mitsubishi	0283	Yamaha	0097, 0094
Onkyo	0135, 0136, 0282		

Set Up Codes for Home Automation

GE	0240	Radio Shack	0240
LiteTouch	0084	Security System	0167
Lutron	0318	Universal X10	0167
One For All	0167	X10	0167

Set Up Codes for Digital Audio Tape

Carver	0158	Marantz	0158
Denon	0031	Philips	0158
Harman/Kardon	0158	Sony	0093
Magnavox	0158		

Set Up Codes for Turntables

Aiwa	0188	Marantz	0188
Carver	0188	Philips	0188
Magnavox	0188	Sony	0348

Set Up Codes for Video Accessories







Archer	0160	Rabbit	0081
GC Electronics	0160	Radio Shack	0160
Jebsee	0160	Sony	0850
Magnavox	0818	TeleCaption	0171
Philips	0818		

Set Up Codes for Miscellaneous Audio



Aiwa	0010, 0159, 0404	RCA	0056
Fisher	0052	SSI	0317
Harman/Kardon	0477	Schneider	0376
JBL	0477	Scientific Atlanta	0460
JVC	0073	Sony	0010, 0159
Jerrold	0459, 0520	Soundesign	0376
Nikko	0376	Starcom	0459
Paramount Pict	0317	Yorx	0376

SEARCHING FOR YOUR CODE

If your components do not respond to the *Home Producer* after trying all of the codes listed for your brand, or if your brand is not listed at all, try searching for your code. For example, after trying all of the codes for your brand of TV, you still cannot get the *Home Producer* to operate your TV, then:

- 1  Press and release the **TV** key.
- 2  Press and hold **MAGIC** until the display screen changes from [TV and the TIME] to [TIMED SEQ].
- 3  Press the **MENU -** key one time. The display screen will change to [CODE SET UP]. Press **SELECT**.
 The display will change to [DEV SET UP].
- 4  Press the **MENU -** key another time. The display screen will change to [DEV SEARCH]. Press **SELECT**.
 The display will change to [TV and XXX].







NOTE: XXX represents the last three-digit code that was entered prior to starting the search.

- 5  Press **POWER**. If your TV turns OFF, press **SELECT** to lock in your code and return the display to [TV and the TIME]. If your TV does not turn OFF, press **MENU -**. The next available code will appear on the display screen, then press **POWER** again. Continue to press **POWER** then **MENU -** until your TV turns OFF. Once your TV turns OFF, press **SELECT** to lock in your code and return the display to [TV and the TIME].
 or

NOTE: If you are searching for your VCR, CD Player, DVD Player, or LD Player code, use **PLAY** instead of **POWER**. Once your component begins to play the tape or disc, press **SELECT** to lock in the code.

Finding Out Your Code





After you have set up your components using the search, you may need to find out which four-digit code is operating your components. For example, to find out what four-digit code is operating your TV:

- 1  Press and release the **TV** key.
- 2  Press and hold **MAGIC** until the display screen changes from [TV and the TIME] to [TIMED SEQ].
- 3  Press the **MENU** – key one time. The display screen will change to [CODE SET UP]. Press **SELECT**. The display will change to [DEV SET UP].

- 4  **x2** Press **MENU** – twice. The display will change to [DEV NUMBER]. Press **SELECT**. The display will then change to [TV and your code]. Write down the code in the below boxes and press **ESC** to return the display to [TV and the TIME].

TV code:	<input type="text"/>	<input type="text"/>	<input type="text"/>	<input type="text"/>
VCR Code:	<input type="text"/>	<input type="text"/>	<input type="text"/>	<input type="text"/>
Cable Code:	<input type="text"/>	<input type="text"/>	<input type="text"/>	<input type="text"/>
Satellite Code:	<input type="text"/>	<input type="text"/>	<input type="text"/>	<input type="text"/>
Tuner Code:	<input type="text"/>	<input type="text"/>	<input type="text"/>	<input type="text"/>
Amplifier Code:	<input type="text"/>	<input type="text"/>	<input type="text"/>	<input type="text"/>
CD Player Code:	<input type="text"/>	<input type="text"/>	<input type="text"/>	<input type="text"/>
DVD/LD Player Code:	<input type="text"/>	<input type="text"/>	<input type="text"/>	<input type="text"/>

SETTING UP THE HOME THEATER KEY

The HOME THEATER mode key brings all of the most commonly used home theater functions into one mode of the *Home Producer*. When setting up this key, you will choose which components will control your volume, channel changing, playback, Picture-in-Picture and menu functions.





- 1  Press and release the **HOME THEATER** mode key.
- 2  Press and hold **MAGIC** until the display screen changes from [THEATER and the TIME] to [TIMED SEQ].
- 3  **x2** Press the **MENU** – key twice, the display will change to [CONFIGURE]. Press **SELECT**, the display will change to [THEATR SEL], press **SELECT**. The display will change to [AUDIO].
- 4  **x2** Press **SELECT**. This will change the display to [AMP] or, if you have redefined the **AMP** key, the display would read [TV2], [DVD2], [SAT2] and so on. At this screen you will select the device that will control your Volume in the Home Theater Mode. Use the device keys **AMP**, **TUN**, **TV**, **CBL**, **SAT** or **DVD/LD** to choose your AUDIO selection. Once you choose the AUDIO source, press **SELECT**. For example, if your Tuner will control your volume in the Home Theater Mode, press **TUN + SELECT**. The display will change to [CHANNEL]. This will allow you to choose the device that will control your channel changing.

(Device Key)









(continued on next page)



SETTING UP THE HOME THEATER KEY (cont.)

- 5  Press **SELECT**. This will change the display to [SAT]. Use the device keys **(Device Key) TV, VCR, SAT, CBL** or **DVD/LD** to choose your CHANNEL source, then press **SELECT**. For example, if your Satellite will control channel changing in the Home Theater Mode, press **SAT + SELECT**. The display will change to [PLAYBACK]. This will allow you to choose the device that will control the transport keys (PLAY, REW, FF, PAUSE, STOP and REC).
- 6  Press **SELECT**. This will change the display to [VCR]. Use the device keys **(Device Key) CD, VCR,** or **DVD/LD** to choose your PLAYBACK source, then press **SELECT**. For example, if your DVD Player will control playback in the Home Theater Mode, press **DVD/LD + SELECT**. The display will change to [PIP]. This will allow you to select the device that will control your Picture-in-Picture features.
- 7  Press **SELECT**. This will change the display to [TV]. Use the device keys **(Device Key) TV, CBL,** or **VCR** to choose your PICTURE-IN-PICTURE source, then press **SELECT**. For example, if your VCR will control Picture-in-Picture features in the Home Theater Mode, press **VCR + SELECT**. The display will change to [MENU]. This will allow you to select the device that will control your Menu features.
- 8  Press **SELECT**. This will change the display to [SAT]. Use the device keys **(Device Key) TV, CBL, SAT, VCR, TUN,** or **DVD/LD** to choose your MENU source, then press **SELECT**. For example, if your DSS will control your Menu features in the Home Theater Mode, press **SAT + SELECT**. The display will then return to the [DEVICE and the TIME] screen.

After setting up the **HOME THEATER** Mode key, you can then set up a macro sequence on the **POWER** key in the Home Theater Mode. This macro will allow you to power ON all of your components in the Home Theater mode with the press of one key.

Power Key Macro - Powering ON Your Home Theater Components with One Key Press

- 1  Press and release the **HOME THEATER** Mode key, then press and hold **MAGIC** until the display screen changes from [THEATER and the TIME] to [TIMED SEQ].

 x2 Press the **MENU** – key twice, the display will change to [CONFIGURE]. Press **SELECT**, the display will change to [THEATR SEL].

- 2  x4 Press **MENU** – four times until the display reads [KEY MACRO]. Press **SELECT**. The display will read [SEL MACKKEY].

- 3  Press the **POWER** key to assign the macro to POWER. Enter the macro sequence that will power “ON” your home theater, for example:

(Sequence) **TUN + POWER + TV + POWER + VCR + POWER + etc.**, until you have added all of your home theater components.
- 4  When your macro sequence is concluded, press **ESC** to save. The display will then return to the [THEATER and the TIME] screen.
- 5  To activate the Home Theater Power macro, the LCD screen must read [THEATER], and you must press **POWER**.

NOTE: The AUD or VID macro keys cannot be used in your Home Theater Power key macro.



LEARNING FUNCTIONS ONTO THE L1 THROUGH L6 KEYS

The **L1**, **L2**, **L3**, **L4**, **L5**, and **L6** keys can be used to customize those functions that are unique to your home entertainment needs. For example, the *Home Producer* does not offer Tracking Up or Down for a VCR. However, with the learning feature, you can add these as well as many other functions to the *Home Producer*.

NOTE: Please have your original remote controls handy before performing learning.

1 (Device Key) Press and release the Device key (e.g., VCR) where you want *Home Producer* to learn new feature(s).

2  Press and hold **MAGIC** until the display screen changes from the device you selected [e.g., VCR and the TIME] to [TIMED SEQ].

3  **x2** Press **MENU** – twice, the display will change to [CONFIGURE]. Press **SELECT**, the display will change to [THEATER SEL]. Press  **x2** change to [IR LEARNER].

4  **x2** Press **SELECT**, the display screen will change to [IR LEARN]. Press **SELECT** again.

5 The display screen will change from [IR LEARN] to [VCR].

Home Producer is now ready to learn new features.

NOTE: At this point, you can press a different device key (e.g., TV) to learn features in a different mode.

6 (Device Key) Press and release the Device key (e.g., TV) for the component you want to be learned.

NOTE: Steps 7 through 9 need to be completed within 10 seconds. Please read the next three steps before proceeding.

7 Press and release the **L(1~6)** key where you want to assign a component's feature. The *Home Producer's* red light will flash rapidly.

9 Place your original remote control about 2 inches apart (nose-to-nose) from the *Home Producer*.

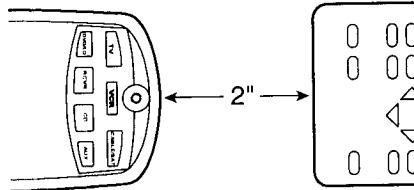

10 On your original remote control, press and hold the key (feature) you want learned until the red light on the *Home Producer* blinks twice and the display will read [SUCCESS]. If the red light on the *Home Producer* does not blink twice or the display reads [ERROR], stop and repeat steps 9 and 10.

NOTE: You can now repeat steps 6 through 10 to learn additional functions on the other **L(1~6)** keys and in different modes.

11  Once the *Home Producer* has learned all desired features, press and release **ESC** to exit out of learning mode.

12 To test a new feature, press and release a desired device key, followed by the **L(1~6)** key where a corresponding feature was learned.

34

Deleting Features from the L keys:

1 (Device Key) Press and release the Device key (e.g., VCR) where you want *Home Producer* to learn new feature(s).

2  Press and hold **MAGIC** until the display screen changes from the device you selected [e.g., VCR and the TIME] to [TIMED SEQ].

3  **x2** Press **MENU -** twice, the display will change to [CONFIGURE]. Press **SELECT**, the display will change to [THEATER SEL]. Press **MENU +** twice, the display will change to [IR LEARNER].



4  **x2** Press **SELECT**, the display screen will change to [IR LEARN]. Press **MENU +** once and the screen will change to [IR DELETE]. Press and release **SELECT**.











5  The display screen will now change to [KEY/MODE]. Press and release **SELECT**.

6 (Device Key) Press and release the Device key which holds the learned feature you want to delete (e.g., TV). Then press and release the **L (1~6)** key you want to delete. The Display will read [DELETED].

7 You can now repeat steps 5 and 6 to continue deleting any and all learned features.

SETTING UP TIMED SEQUENCES - RECORDING WHEN YOU ARE NOT HOME

The *Home Producer* is equipped with a special feature that lets you set up a sequence of key-strokes that can be played back at a specified time, up to seven days in advance. You can use this feature to record from your DSS satellite, turn on your infrared home automation lighting system when you are not home, or any other series of keystrokes that you would like to play back at a later time. The *Home Producer* You can store up ten sequences in the memory with each sequence having a maximum of 15 keystrokes. For example, to set up the remote to record a program off of your DSS receiver:

- 1  Press and hold **MAGIC** until the play screen changes from [DEVICE and the TIME] to [TIMED SEQ].
-  x2 Press **SELECT**. The display will change to [ADD MACRO]. Press **SELECT** again.
- 2 **0** or **1**  The display will change to [START and the TIME], with the first digit of the TIME blinking. Enter either a **0** or a **1**, then the next digit in the time will begin to blink, continue entering the time until all four digits of the time have been set. Next, [AM/PM] will blink. Press **MENU** – to toggle between AM and PM. Choose one and press **SELECT**.

- 3  The display will change to [ONCE]. Use **MENU** – to toggle through [ONCE], [DAILY], or [WEEKLY], depending on when and how often you want the sequence to play. Choose one and press **SELECT**.

- 4  The display will change to the day of the week on which the sequence will begin. Use **MENU** – to toggle through the days of the week until a desired day is displayed. Press **SELECT**. The display will change to [ENTER SEQ].

36

NOTE: When setting up your sequence, you will need to include any keystrokes that would normally be required during regular usage, such as pressing **ENTER** after entering a channel number when changing channels.

For example, enter a sequence that will start your VCR recording your DSS channel as follows:

**SAT + POWER + SAT + 2 + 7 + 5 +
VCR + POWER + VCR + RECORD.**

This sequence will turn on the DSS, change the channel to 275, and turn on the VCR and start it recording.

5







Once a sequence has been set up, press the **ESC** key to return to the [DEVICE and the TIME] display screen. Below the [TIME], a CLOCK (⌚) symbol will appear to show that there is a timed sequence in the memory.

NOTE: If, at any time during the set up of your timed sequence, a mistake is made, press the **ESC** key to return to the main display [DEVICE and the TIME]. Then delete the sequence that was incorrect and restart your timed sequence.

After you have set up a timed sequence, you may want to set up a second sequence that turns everything off after your initial sequence. For the example above, after recording the program from your DSS, you can set up a second sequence to power OFF your DSS and VCR. Just repeat steps 1 through 5 to set up a sequence to power OFF your components.



To Delete a Timed Sequence



-  Press and hold **MAGIC** until the display screen changes from [DEVICE and the TIME] to [TIMED SEQ]. Press **SELECT**. The display will change to [ADD MACRO].
 Press **MENU** – one time. The display will change to [DEL MACRO].
 Press **SELECT**.

-  The display will then change to [DEL (the DAY or D for Daily or W for WEEKLY) and (the TIME of the Sequence)]. If this is the timed sequence you would like to delete, press **SELECT**. The display will change to [DELETED] then return to [DEVICE and the TIME].

NOTE: If you have more than one timed sequence saved in the memory of the Home Producer, use the **MENU** – key to scroll through your saved timed sequences until you see the sequence you would like to delete. Once the sequence is displayed on the screen, press **SELECT**. The display will change to [DELETED] then return to the next available sequence to be deleted. If there are no other sequences to be deleted, then the display will return to [DEVICE and the TIME].

REPEATING A SERIES OF KEY PRESSES USING THE AUD AND VID KEYS

The *Home Producer* has two Macro keys (**AUD** and **VID**) that will play back a series of key strokes at any time with the press of one key. Each sequence can have up to a maximum of 15 keystrokes. These keys are not mode specific and can be accessed in any mode. For example, to set up a sequence that will turn on devices and turn them to the proper inputs:

- 1  Press and hold **MAGIC** until the display screen changes from [DEVICE and the TIME] to [TIMED SEQ].
 x2 Press **MENU** – twice until the display reads [CONFIGURE], then press
 **SELECT**. The display will then read [THEATR SEL].

- 2  x4 Press **MENU** – four times until the display reads [KEY MACRO]. Press
 **SELECT**. The display will read [SEL MACKKEY]. Press either the
 **AUD** or **VID** sequence key. This will be the key that will play back the series of keystrokes assigned to that key. The display will then read [SELECT SEQ]. Begin entering the sequence of keystrokes, up to 15.

NOTE: When setting up your sequence, you will need to include any keystrokes that would normally be required during regular usage, such as pressing ENTER after entering a channel number when changing channels.

For example:
 (sequence) **TUN + POWER + TV + POWER + TV/SAT** (to change the input on the TV to VIDEO 1) + **SAT + POWER**.

- 3  When your macro sequence is concluded, press **ESC** to save.

When the sequence key is pressed, the Tuner will power ON, the TV will power ON and change its input to VIDEO 1, and then the Satellite will power ON.

Repeat these steps 1 to 3 to setup another sequence key (either **AUD** or **VID**) for your needs.

*NOTE: If you make a mistake during the setup of a macro sequence, press **ESC** to return to the main display screen and begin the setup of your sequence again.*

HOW TO USE THE SHIFT KEY

The *Home Producer* has additional features that can be accessed by using the **SHIFT** key. They are listed above the keys that they are mapped to.

For example, on the transport keys **PLAY**, **REW**, **FF**, **STOP**, and **PAUSE**, there are the following features: **SLOW**, **SLOW+**, **SLOW-**, **X2**, and **EJECT**.

If you want to eject a tape from your VCR, press:

SHIFT + STOP

This will eject your tape, as long as your original remote supported this feature.

NOTE: Once you have pressed the **SHIFT** key, *Home Producer* will remain in the "Shift" mode, as indicated by an [S] on the LCD screen, for 5 seconds after the last key press or until the **SHIFT** key is pressed again.

The following keys have functions that are shifted:

CENTER:	SHIFT + CENTER = REAR
MENU:	SHIFT + MENU = PROGRAM
SELECT:	SHIFT + SELECT = CLEAR
MUTE:	SHIFT + MUTE = SLEEP
PREV CH:	SHIFT + PREV CH = DISPLAY
PIP:	SHIFT + PIP = FREEZE PIP
REW:	SHIFT + REW = SLOW-
PLAY:	SHIFT + PLAY = SLOW
FF:	SHIFT + FF = SLOW +
STOP:	SHIFT + STOP = EJECT
PAUSE:	SHIFT + PAUSE = X2

IMPORTANT: For a more detailed explanation of what function each shifted key performs by device type (e.g., TV, VCR, etc.), please refer to pages 52 through 64.

HOW TO USE THE SLEEP KEY





The *Home Producer* has a **SLEEP** key that either operates your component's sleep timer or, if your component does not have a sleep timer, it activates the *Home Producer's* built-in sleep timer, after you activate SLEEP LOCK (see below). To use the *Home Producer's* **SLEEP** key, press **SLEEP** (i.e., **SHIFT + MUTE**).



If your component does not have a sleep timer, the *Home Producer* will access its own built-in timer. To activate it, press **SLEEP** (i.e., **SHIFT + MUTE**). The display will change to [SLEEP 15]. To add time to the sleep timer, press **MENU -**. Each press of **MENU -** will add 15 minutes to the sleep timer, up to a total of 60 minutes. Once the desired time is displayed on the LCD screen, press **SELECT**. The display screen will change to [SLEEP and the TIME].

Sleep Lock

If you would like *Home Producer* to use its built-in sleep timer on all of your components, you can lock the SLEEP mode, as follows:

- 1  Press and hold **MAGIC** until the display screen changes from [DEVICE and the TIME] to [TIMED SEQ].







- 2  **x2** Press the **MENU -** key twice, the display will change to [CONFIGURE]. Press **SELECT**, the display will change to [THEATR SEL].
 Press **MENU +** twice, the display will read [SLEEP LOCK]. Press **SELECT**, the display will change to [DISABLE].
 **x2**

- 3  Press **MENU -** once to change the display to [ENABLE], then press **SELECT**. The display will return to [DEVICE and the TIME]. Now, whenever you press **SLEEP** (i.e., **SHIFT + MUTE**), *Home Producer* will use its own built-in sleep timer.

*NOTE: When using the built-in sleep timer, pressing **POWER** will cancel the sleep function.*

VOLUME LOCK

With the *Home Producer*, you can choose which home entertainment component controls your volume. When you originally set up the *Home Producer*, each individual component operates its own volume, provided the component has volume control. You can change this setting so that one component controls the volume, whether *Home Producer* is in the TV, VCR, CBL, or SAT mode. For example, to set-up the *Home Producer* to always control the volume through your Amplifier in the TV, VCR, CBL or SAT mode:

- 1  Press and hold **MAGIC** until the display screen changes from [DEVICE and the TIME] to [TIMED SEQ].
- 2  **x2** Press the **MENU** – key twice, the display will change to [CONFIGURE]. Press **SELECT**, the display will change to [THEATR SEL].

- 3  **x2** Press **MENU** – two more times, the display will read [VOL LOCK]. Press **SELECT**, the display will change to [UNLOCK].

- 4  Press **MENU** – one time to change the display to [LOCK] then press **SELECT**. Now press the key for the component that will control your volume. For example, to control the volume through your amplifier, press **AMP**. Press **SELECT**. The display will return to [DEVICE and the TIME].

Now, when you use the volume keys on your *Home Producer*, the volume will be controlled by the specified component.







To return volume control to a component:

- 1  Press and hold **MAGIC** until the display screen changes from [DEVICE and the TIME] to [TIMED SEQ].

(continued on next page)

42









To return volume control to a component (cont.):

- 2  **x2** Press the **MENU** – key twice, the display will change to [CONFIG-URE]. Press **SELECT**, the display will change to [THEATR SEL].

- 3  **x2** Press **MENU** – two more times, the display will read [VOL LOCK]. Press **SELECT**, the display will change to [LOCK].

- 4  Press **MENU** – one time to change the display to [UNLOCK] then press **SELECT**. The display will return to [DEVICE and the TIME].

Now, when you use the volume keys on your *Home Producer*, each component will control its own volume, as long as that component originally had volume control.







KEYMOVER

Keymover allows you to map features from one device mode to another. For example, if your VCR does not have volume control, you can map the volume keys in the TV mode to the VCR mode. This will allow you to control the volume of your TV while in the VCR mode. To Keymove features from one mode to another:

- 1  Press and hold **MAGIC** until the display screen changes from [DEVICE and the TIME] to [TIMED SEQ].
- 2  **x2** Press the **MENU -** key twice, the display will change to [CONFIGURE]. Press **SELECT**, the display will change to [THEATR SEL].

- 3  **x3** Press **MENU +** three times, the display will read [KEY MOVER]. Press **SELECT**, the display will change to [FROM].

- 4 (Device Key) Press the device key (e.g., **TV**, **VCR**, **CBL**, etc.) that contains the feature you want to move. For the example above, to move the TV's volume, you would press **TV**. The display will show [TV].
- 5  Press the key for the feature you want to move. For the example, above, press **VOL +**. The display will change to [TO]. Press the device key (Device Key) (i.e., **TV**, **VCR**, **CBL**, etc.) where you would like to place the feature. For the example above, you would press **VCR**. The display will show [VCR].
- 6  Now press the key that will control the feature you are moving. For the example above, press **VOL +**. The display will return to [DEVICE and the TIME]. In the VCR mode, your *Home Producer* will now operate volume up on your TV. Now, to complete the example above, repeat this sequence to move **VOL -** and **MUTE** from the TV mode to the VCR mode.

CLEAR ALL

If you would like to reset the *Home Producer* of all advanced functions, use the CLEAR ALL feature. The CLEAR ALL feature will erase the following functions from the memory of the *Home Producer*: Macro Sequences, Timed Macro Sequences, Volume Lock and Keymovers. CLEAR ALL will not erase your set-up codes. To clear the memory using the CLEAR ALL feature:

- 1  Press and hold **MAGIC** until the display screen changes from [DEVICE and the TIME] to [TIMED SEQ].
- 2  **x2** Press the **MENU -** key twice, the display will change to [CONFIG-URE]. Press **SELECT**, the display will change to [THEATR SEL].

- 3  Press **MENU +** one time, the display will read [CLEAR ALL]. Press **SELECT**, the display will change to [CLR ALL].

- 4  **x2** Press **SELECT**, the display will change to [CONFIRM]. Press **SELECT** once more and the display will return to [DEVICE and the TIME]. Your *Home Producer* is now reset.

SETTING UP AND USING THE IR/RF COMMAND CENTER

The *Home Producer* comes with an IR/RF Command Center which receives Radio Frequency (RF) signals from your *Home Producer*, anywhere in your home, up to 100 feet away. The Command Center then converts the RF signal into an Infrared signal to control your home theater components. To setup the Command Center:

- 1 Find a location approximately 8 feet in front of your home theater components.

NOTE: The location should have access to both your equipment (line-of-sight) and an outlet to plug in the Command Center.

- 2 Plug in the Command Center's Power Cord and raise the telescoping antenna.

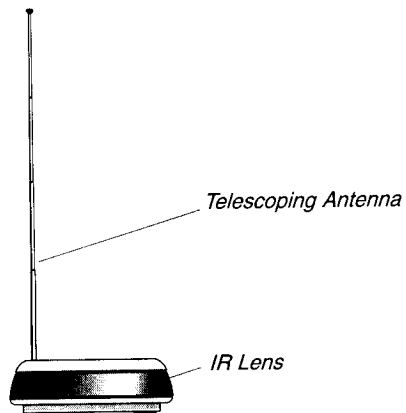

- 3 Position the Command Center so the black IR lens is aimed at your home theater components.
- 4 Test the Command Center by pressing the **POWER** key on the *Home Producer*. Your components should operate from any room in your home, up to 100 feet away.

NOTE: The *Home Producer* transmits both an IR and an RF signal simultaneously. When you are testing the Command Center with *Home Producer*, make sure that the remote control is not aimed at your equipment.

46

SETTING UP AND USING THE IR/RF COMMAND CENTER (cont.)

The Command Center also includes an additional IR signal extension cord for use with a component that is not in direct line-of-sight of the Command Center. If you have a component that is not in the line-of-sight of the Command Center:



- 1 Plug the 4-foot IR signal extension cord into the back of the Command Center.

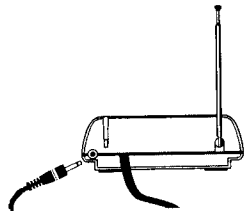

- 2 Run the IR signal extension cord to the component that is not in the line of sight of the Command Center.
- 3 Using the supplied double-sided tape, attach the IR signal extension cord so that the LED is over or next to the IR sensor of your home theater component.

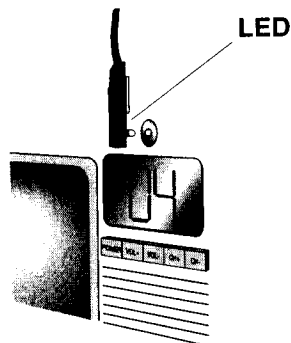

- 4 Test the *Home Producer*. The Command Center will convert the RF signal from the Home Producer into an IR signal and transmit that signal to your component through the IR signal extension cord.

NOTE: If the IR signal extension cord does not control the component that is not in the line of sight of the Command Center, reposition the LED until the component is able to be controlled, then re-attach the LED.

Here is a list of adjustments that can maximize the operation of your Command Center. For optimal operation of the *Home Producer's* Command Center:

- 1 Aim the *Home Producer* toward the room where the Command Center is located.
- 2 Do not position the Command Center near metal (such as heat ducts). Metal can absorb RF signals.
- 3 Make sure the batteries in the *Home Producer* are fully charged. Weak batteries will affect the range of the Home Producer.
- 4 Make sure that the range of the *Home Producer* is not being affected by other radio frequency transmissions.

NOTE: The tests for range limits of the *Home Producer* and the Command Center were conducted in open-air distance tests. Actual distance of the signal will be based on the construction of the building the unit is being used in as well as other factors such as outside interference.

COMPLIANCE WITH THE FCC RULES AND REGULATIONS

This equipment has been tested and found to comply with the limits for a class B digital device, pursuant to part 15 of the FCC Rules. These limits are designed to provide reasonable protection against harmful interference in a residential installation. This equipment generates, uses and radiates radio frequency energy and if not installed and used in accordance with the instructions, may cause harmful interference to radio communications. However, there is no guarantee that interference will not occur in a particular installation. If this equipment does cause harmful interference to radio or television reception, which can be determined by turning the equipment off and on, the user is encouraged to try and correct the interference by one or more of the following measures:

- Reorient or relocate the receiver antenna
- Increase the separation between the equipment and the receiver
- Connect the equipment into an outlet that is different from that to which the receiver is connected
- Consult the dealer or an experienced radio/television technician for help

The user is cautioned that changes and modifications made to the equipment without the approval of the manufacturer could void the user's authority to operate his equipment.

FCC authorization Label

This device complies with part 15 of the FCC Rules. Operation is subject to the following two conditions:

1. This device may not cause harmful interference and
2. This device must accept any interference received, including interference that may cause undesired operation.

FCC ID #:

Home Producer: MG3N868629

Command Center: MG3-15-1925R

SPECIFICATIONS

Remote Power.....	4 AAA Batteries
RF Command Console Power	120 Volts AC
Remote to RF Command Console Range	100 Feet (30.48m)
RF Command Console to Device Range	25 Feet (7.62m) ±30°
Remote Dimensions (HWD)	9 3/8 x 2 7/8 x 1 3/8 4 in.
RF Command Console	
Dimensions (HWD)	1 9/16 x 5 1/16 x 4 in.
Remote Weight (without Batteries)	8 oz. (220g)
RF Command Console Weight	10.4 oz (300g)

Specifications are typical. Individual units might vary. Specifications are subject to change and improvement without notice.

TROUBLESHOOTING

Problem:	Solution
LCD screen begins to fade, does not appear or the red light blinks five times when you press a key?	Replace the batteries with four (4) new AAA alkaline batteries.
The <i>Home Producer</i> does not operate your home entertainment component?	Try all of the codes listed for your brand of home entertainment component in the "Set-Up Codes" section. If this does not work, try searching for your code. Make sure the home entertainment component you are setting up is able to be operated with an infrared remote control.
The <i>Home Producer</i> is not performing commands properly?	Try all of the codes listed for your brand of home entertainment component in the "Set-Up Codes" section. Many set-up codes may allow some degree of operation. However, only one set-up code will work correctly with your home entertainment component.
You make a mistake when setting up your <i>Home Producer</i> ?	During any set up procedure, except for Macros and Timed Sequences, pressing ESC will return you to [DEVICE and the TIME] screen without saving. If you make a mistake programming a Timed Sequence, return to the Timed Sequence menu and delete it. If you make a mistake when saving a macro, erase it by re-saving a new macro on the same key.
VCR not recording?	As a safety feature on the <i>Home Producer</i> , you must press the REC key twice.

TROUBLESHOOTING (cont.)

Problem:	Solution
CH +/- and PREV CH not working for your RCA TV?	Due to RCA design (1983-1987), only the original remote control will operate these functions.
Problems changing channels?	If your original remote control required an ENTER keystroke when changing channels, press the ENTER key on the Home Producer after you enter the channel number.
The red light blinks when you press a key but you receive no response from your home entertainment component?	Make sure you are aiming your <i>Home Producer</i> at your home entertainment component and that you are within 15 feet before using your remote control.
Your audio components turn on and off and control volume but do not change preset channels?	Some audio components may need both a Tuner/Receiver code and an Audio Amplifier code to control all of the features of your audio component.
Your DSS satellite receiver does not respond to the codes listed in the manual?	The codes listed in this manual are set up to operate your DSS receiver on the 1st or 2nd addresses only. Make sure the DSS Receiver can be operated with an infrared remote control and is not set up to only receive Radio Frequency.
The Home Producer is not operating your Bang & Olufsen equipment?	Some Bang & Olufsen products, as well as some other manufacturer's equipment operate at a frequency higher than 100 kHz and will not work with the <i>Home Producer</i> .

ERROR MESSAGES

Error	Meaning
MEM FULL	Maximum memory capacity has been reached.
BATTERY LO	Replace batteries with four new "AAA" Alkaline batteries.
TOO LONG	Macro sequence being entered exceeds 15 keystrokes.
LIST END	You have reached the end of all valid codes using the Step-N-Set sequence.
INVALID	Displayed when trying to specify a key that is not valid for the sequence being entered. For example, when selecting a Device Key (e.g., TV) for a Macro sequence.
NOT FOUND	Displayed when you enter in a code that is not valid for the device being programmed.
ERROR	Displayed when an error has occurred in the learning sequence.

Consumer Help Line: **1-330-405-8553**World Wide Web: **<http://www.oneforall.com>**

KEY INDEX

TV Functions

0 - 9 The Digit keys (**0-9**) control direct channel access the same as the Digit keys on your original remote.

NOTE: If your original remote control required you to use an Enter key to change channels, use the **ENTER** key on the Home Producer after entering your channel number.



The **ENTER** key operates the same as the Enter key on your original TV remote control.



The **TV/SAT** key operates the same as the TV/VIDEO or INPUT key on your original TV remote control.



The **PREV CH** (Previous Channel) key operates the same as the LAST CHANNEL or RECALL key on your original TV remote control.

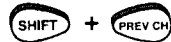

The **DISPLAY** key (**SHIFT + PREV CH**) operates the display on your TV.



The **PIP** key accesses your TV's Picture-in-Picture feature.

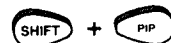

The **FREEZE** key (**SHIFT + PIP**) freezes your Picture-In-Picture window.



The **SWAP** key swaps the Picture-in-Picture window and the main picture.



The **MOVE PIP** key moves the Picture-in-Picture window around your TV screen.

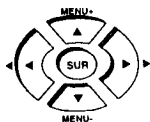

The **MENU** key operates the same as the MENU or OSD (On Screen Display) key on your original remote. Use the **MENU + (Up)**, **MENU - (Down)**, **◀ (Left)** and **(Right) ▶** to navigate through your menus. If your original remote control had a Select/Enter key for use in your menu, use **SELECT** or **ENTER**.

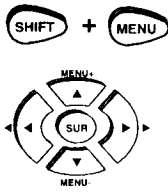

The **PROG** key (**SHIFT + MENU**) operates your secondary menus. Use the **MENU +** (Up), **MENU -** (Down), **◀** (Left) and **(Right) ▶** to navigate through your menus. If your original remote control had a Select/Enter key for use in your menu, use **SELECT** or **ENTER**.



The **SELECT** key is used to make selections in the LCD Screen menu. It is also used to make selections in your on-screen TV menus.

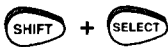

The **CLEAR** key (**SHIFT + SELECT**) is used to exit or cancel selections in your on-screen TV menus.

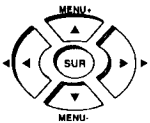

The **MENU +** (Up), **MENU -** (Down), **◀** (Left) and **(Right) ▶** are used to navigate through your on-screen menus. **MENU +** and **MENU -** are also used to navigate through the LCD Screen menu.

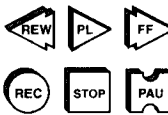

The VCR transport keys (i.e., **PLAY**, **REW**, **FF**, **STOP**, **PAU**, and **REC**) access the features of your VCR.

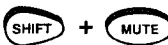

The **SLEEP** key (**SHIFT + MUTE**) accesses the sleep timer on your TV. Even if your TV does not have a sleep timer, the *Home Producer* can access its own built-in sleep timer.



The **CENTER** and **REAR** (**SHIFT + CENTER**) keys function the same as the **ADD** and **DELETE** keys on your original TV remote control.

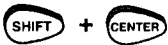

KEY INDEX (cont.)

VCR Functions

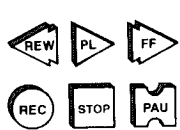

 The VCR transport keys (i.e., **PLAY**, **REW**, **FF**, **STOP**, **PAU** and **REC**) access the features of your VCR. As a safety feature on the *Home Producer*, you must press the **REC** key twice.

*NOTE: The **SHIFT** key accesses advanced features that are mapped under the VCR keys: **SHIFT + PLAY = SLOW**, **SHIFT + REW = SLOW -**, **SHIFT + FF = SLOW +**, **SHIFT + STOP = EJECT** and **SHIFT + PAUSE = X2**.*

0 - 9 The Digit keys (**0-9**) control direct channel access the same as the Digit keys on your original remote.

*NOTE: If your original remote control required you to use an Enter key to change channels, use the **ENTER** key on the Home Producer after entering your channel number.*



 The **ENTER** key operates the same as the Enter key on your original VCR remote control.

 The **TV/SAT** key operates the same as the TV/VCR key on your original VCR remote control.

 The **PREV CH** (Previous Channel) key operates the same as the LAST CHANNEL or RECALL key on your original VCR remote control.

 The **DISPLAY** key (**SHIFT + PREV CH**) operates the display on your VCR.

 The **PIP** key accesses your VCR's Picture-in-Picture feature.

 The **FREEZE** key (**SHIFT + PIP**) freezes your Picture-In-Picture window.



 The **SWAP** key swaps the Picture-in-Picture window and the main picture.



The **MOVE PIP** key moves the Picture-in-Picture window around your TV screen.

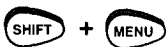
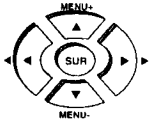

The **MENU** key operates the same as the MENU or OSD (On Screen Display) key on your original remote. Use the **MENU +** (Up), **MENU -** (Down), **◀** (Left) and **▶** (Right) to navigate through your menus. If your original remote control had a Select/Enter key for use in your menu, use **SELECT** or **ENTER**.



The **PROG** key (**SHIFT + MENU**) operates your secondary menus. Use the **MENU +** (Up), **MENU -** (Down), **◀** (Left) and **▶** (Right) to navigate through your menus. If your original remote control had a Select/Enter key for use in your menu, use **SELECT** or **ENTER**.

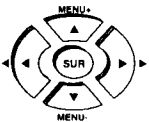

The **SELECT** key is used to make selections in the LCD Screen menu. It is also used to make selections in your on-screen VCR menus.

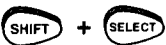

The **CLEAR** key (**SHIFT + SELECT**) is used to exit or cancel selections in your on-screen VCR menus.

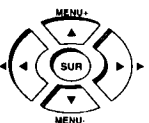

The **MENU +** (Up), **MENU -** (Down), **◀** (Left) and **▶** (Right) are used to navigate through your on-screen menus. **MENU +** and **MENU -** are also used to navigate through the LCD Screen menu.



The **CENTER** and **REAR** (**SHIFT + CENTER**) keys function the same as the ADD and DELETE keys on your original VCR remote control.

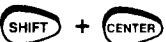

KEY INDEX (cont.)

Cable Functions

0 - 9 The Digit keys (**0-9**) control direct channel access the same as the Digit keys on your original remote.

***NOTE:** If your original remote control required you to use an Enter key to change channels, use the **ENTER** key on the Home Producer after entering your channel number.*



The **ENTER** key operates the same as the Enter key on your original Cable Box remote control.



The **TV/SAT** key operates the same as the A/B key on your original Cable Box remote control.



The **PREV CH** (Previous Channel) key operates the same as the LAST CHANNEL or RECALL key on your original Cable Box remote control.

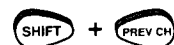

The **DISPLAY** key (**SHIFT + PREV CH**) operates the display on your Cable Box.



The **PIP** key accesses your Picture-in-Picture features.

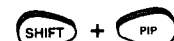

The **FREEZE** key (**SHIFT + PIP**) freezes the Picture-In-Picture window.



The **SWAP** key swaps the Picture-in-Picture window and the main picture.



The **MOVE PIP** key moves the Picture-in-Picture window around your TV screen.

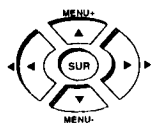

The **MENU** key operates the same as the MENU or OSD (On Screen Display) key on your original remote. Use the **MENU + (Up)**, **MENU - (Down)**, **◀ (Left)** and **(Right) ▶** to navigate through your menus. If your original remote control had a Select/Enter key for use in your menu, use **SELECT** or **ENTER**.

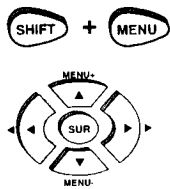

The **PROG** key (**SHIFT + MENU**) operates your secondary menus. Use the **MENU +** (Up), **MENU -** (Down), **◀** (Left) and **(Right) ▶** to navigate through your menus. If your original remote control had a Select/Enter key for use in your menu, use **SELECT** or **ENTER**.



The **SELECT** key is used to make selections in the LCD Screen menu. It is also used to make selections in your on-screen menus.

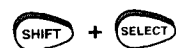

The **CLEAR** key (**SHIFT + SELECT**) is used to exit or cancel selections in your on-screen menus.

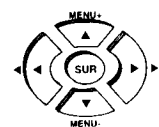

The **MENU +** (Up), **MENU -** (Down), **◀** (Left) and **(Right) ▶** are used to navigate through your on-screen menus. **MENU +** and **MENU -** are also used to navigate through the LCD Screen menu.

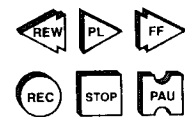

The VCR transport keys (i.e., **PLAY**, **REW**, **FF**, **STOP**, **PAU**, and **REC**) access the features of your VCR.

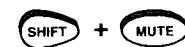

The **SLEEP** key (**SHIFT + MUTE**) accesses the sleep timer on your TV. Even if your TV does not have a sleep timer, the *Home Producer* can access its own built-in sleep timer.



The **CENTER** and **REAR** (**SHIFT + CENTER**) keys function the same as **ADD** and **DELETE** keys on your original Cable Box remote control.

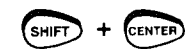

The **SUR** (Surround) key functions the same as the **FC** or **FAV** (Favorite Channel) key on your original Cable Box remote control.

KEY INDEX (cont.)

Laser Disc/Cassette/DVD Functions

 The VCR transport keys (i.e., **PLAY**, **REW**, **FF**, **STOP**, **PAU** and **REC**) access the features of your Cassette Deck or LD/DVD Player.



NOTE: The **SHIFT** key accesses advanced features that are mapped under the VCR keys: **SHIFT + PLAY = SLOW**, **SHIFT + REW = SLOW -**, **SHIFT + FF = SLOW +**, **SHIFT + STOP = EJECT** and **SHIFT + PAUSE = X2**.

0 - 9 The Digit keys (**0-9**) control direct channel access the same as the Digit keys on your original remote.

NOTE: If your original remote control required you to use an Enter key to change channels, use the **ENTER** key on the Home Producer after entering your channel number.

 The **ENTER** key operates the same as the Enter key on your original remote control.

 The **DVD/LD** key operates the same as the DVD/LD key on your original LD or DVD Player remote control.



 The **DISPLAY** key (**SHIFT + PREV CH**) operates the display on your LD or DVD Player.

 The **MENU** key operates the same as the Menu or Program key on your original remote.

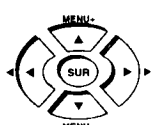

 The **SELECT** key operates the same as the CHAPTER button on your original DVD or LD Player remote control.

 The **MENU** key operates the same as the MENU or OSD (On Screen Display) key on your original remote. Use the **MENU + (Up)**, **MENU - (Down)**, **◀ (Left)** and **(Right) ▶** to navigate through the LCD screen menu.



 +  The **CLEAR** key (**SHIFT + SELECT**) is used to exit or cancel selections in your Programming Menu.

 The **CENTER** and **REAR (SHIFT + CENTER)** keys function the same as DISC A and DISC B keys on your original remote control.

 + 

 The **SUR** (Surround) key functions the same as the DISC key on your original remote control.

DSS & Satellite Functions



0 - 9 The Digit keys (**0-9**) control direct channel access the same as the Digit keys on your original remote.

***NOTE:** If your original remote control required you to use an Enter key to change channels, use the **ENTER** key on the Home Producer after entering your channel number.*

 The **ENTER** key operates the same as the Enter key on your original Satellite remote control.

 The **TV/SAT** key operates the same as the TV/SAT key on your original Satellite remote control.

 The **PREV CH** (Previous Channel) key operates the same as the LAST CHANNEL or RECALL key on your original Satellite remote control.

 +  The **DISPLAY** key (**SHIFT + PREV CH**) operates the display on your Satellite receiver.

 The **PIP** key operates the same as the VIEW key on your original Satellite remote control.

 The **MOVE PIP** key operates the same as the NEXT key on your original Satellite remote control.

KEY INDEX (cont.)

DSS & Satellite Functions (cont.)



The **MENU** key operates the same as the MENU or OSD (On Screen Display) key on your original remote. Use the **MENU +** (Up), **MENU -** (Down), **◀** (Left) and **▶** (Right) to navigate through your menus. If your original remote control had a Select/Enter key for use in your menu, use **SELECT** or **ENTER**.

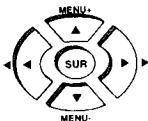

Receiver/Tuner Functions

0 - 9

The Digit keys (**0 - 9**) access the different inputs of your Receiver.



The **TV/SAT** key operates the same as the INPUT key on your original Receiver remote control.



The **PREV CH** (Previous Channel) key operates the same as the RANDOM (CD function) key on your original remote control.

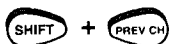

The **DISPLAY** key (**SHIFT + PREV CH**) operates the display on your Receiver.



The **MENU** key operates the same as the PROGRAM key on your original remote control.



The **SELECT** key operates the TAPE MON function on your original Receiver remote control.

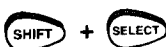

The **CLEAR** key (**SHIFT + SELECT**) is used to exit or cancel selections in your on-screen menus.



The transport keys (i.e., **PLAY**, **REW**, **FF**, **STOP**, **PAU** and **REC**)



access the features of your CD Player.

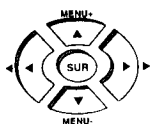

The **MENU +** (Up) and **MENU -** (Down) keys access **REAR LEVEL +** and **REAR LEVEL -** respectively. **MENU <** (Left) and **MENU >** (Right) access **BALANCE LEFT** and **BALANCE RIGHT**.

NOTE: The **SHIFT** key accesses advanced features that are mapped under the **MENU** keys: **SHIFT + MENU + = CENTER LEVEL +**, **SHIFT + MENU - = CENTER LEVEL -**, **SHIFT + MENU < = DELAY -**, and **SHIFT + MENU > = DELAY +**.

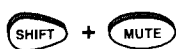

The **SLEEP** key (**SHIFT + MUTE**) accesses the sleep timer on your Receiver. Even if your Receiver does not have a sleep timer, the *Home Producer* can access its own built-in sleep timer.



The **SUR** (Surround) key functions the same as the Surround Mode key on your original remote control.

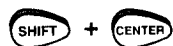

The **CENTER** and **REAR (SHIFT + CENTER)** keys function the same as the Center Mode and Rear Mode keys on your original Receiver remote control.

Amplifier Functions

0 - 9

The Digit keys (**0 - 9**) access the different inputs of your Amplifier.



The **TV/SAT** key operates the same as the **INPUT** key on your original Amplifier remote control.

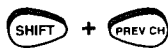

The **DISPLAY** key (**SHIFT + PREV CH**) operates the display on your Amplifier.



The **SELECT** key operates the **TAPE MON** function on your original Amplifier remote control.

(continued on next page)

KEY INDEX (cont.)

Amplifier Functions (cont.)

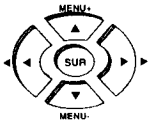

The **MENU +** (Up) and **MENU -** (Down) keys access REAR LEVEL + and REAR LEVEL - respectively. **MENU <** (Left) and **MENU >** (Right) access BALANCE LEFT and BALANCE RIGHT.

NOTE: The **SHIFT** key accesses advanced features that are mapped under the **MENU** keys: **SHIFT + MENU + = CENTER LEVEL +**, **SHIFT + MENU - = CENTER LEVEL -**, **SHIFT + MENU < = DELAY -**, and **SHIFT + MENU > = DELAY +**.

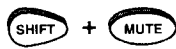

The **SLEEP** key (**SHIFT + MUTE**) accesses the sleep timer on your Amplifier. Even if your Amplifier does not have a sleep timer, the *Home Producer* can access its own built-in sleep timer.



The **SUR** (Surround) key functions the same as the Surround Mode key on your original remote control.



The **CENTER** and **REAR (SHIFT + CENTER)** keys function the same as the Center Mode and Rear Mode keys on your original Amplifier remote control.

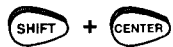

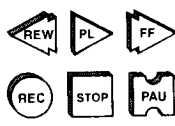

CD Functions



 The transport keys (i.e., **PLAY**, **REW**, **FF**, **STOP**, **PAU** and **REC**) access the features of your CD Player.

***NOTE:** The **SHIFT** key accesses advanced features that are mapped under the VCR keys: e.g., **SHIFT** + **STOP** = **EJECT**.*

0 - 9 The Digit keys (**0 - 9**) control direct track access the same as the digit keys on your original remote control.

 The **ENTER** key operates the same as the Enter key on your original CD Player remote.



 The **TV/SAT** key operates the same as the A/B key on your original CD Player remote control.



 The **PREV CH** (Previous Channel) key operates the same as the RANDOM key on your original CD Player remote control.

 The **DISPLAY** key (**SHIFT** + **PREV CH**) operates the display on your CD Player.

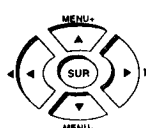
 The **MENU** key operates the same as the PROGRAM key on your original remote control.

 The **SELECT** key operates the DISK SELECT function on your original CD Player remote control.

 The **MENU +** (Up) and **MENU -** (Down) keys access TRACK + and TRACK - respectively. **MENU ◀** (Left) and **MENU ▶** (Right) access DISK - and DISK + respectively.

 The **SUR** (Surround) key functions the same as the 10+ key on your original remote control.

KEY INDEX (cont.)

Home Automation Functions



The **POWER** key operates the same as the ALL ON key of your original remote.

0 - 9

The Digit keys (**0 - 9**) control direct track access the same as the digit keys on your original remote control.



The **VOL +/-** keys operate the same as the BRIGHT and DIM keys on your original remote control.



The **CH +/-** keys operate the same as ON and OFF keys respectively.



The **MUTE** key operates the same as the ALL OFF key on your original remote control.

WARRANTY

One For All PRODUCTS Limited Warranty

Universal Electronics Inc. ("UEI") warrants, to the original purchaser only, that this product will be free from defects in materials and workmanship, under normal use, for ninety (90) days from the date of original purchase.

This warranty does not cover damage or failures caused by products or services not supplied by UEI, or which result from accident, misuse, abuse, neglect, mishandling, misapplication, faulty installation, set-up adjustment, improper maintenance, alteration, maladjustment of consumer controls, modifications, commercial use, or that is attributable to acts of God.

There are no express warranties except as listed above. UEI SHALL NOT BE LIABLE FOR INCIDENTAL OR CONSEQUENTIAL DAMAGES RESULTING FROM THE USE OF THIS PRODUCT OR ARISING OUT OF ANY BREACH OF WARRANTY. ALL EXPRESS AND IMPLIED WARRANTIES, INCLUDING THE WARRANTIES OF MERCHANTABILITY AND FITNESS FOR A PARTICULAR PURPOSE, ARE LIMITED TO THE WARRANTY PERIOD SET FORTH ABOVE. Some states do not allow the exclusion or limitation of incidental or consequential damages, or limitations on how long an implied warranty lasts, so the above exclusions or limitations may not apply to you. This warranty gives you specific legal rights and you may also have other rights which vary from state to state.

To obtain warranty service for a defective product during the warranty period, please return the product, preferably in the original carton, along with your purchase receipt, to the store of original purchase. A note detailing the complaint would be helpful. The store, at its option, will replace or repair this product if found to be defective.

Universal Electronics Inc.
(330)-405-8655

66

One For All® and Home Producer are trademarks of Universal Electronics Inc.

Copyright 1999 by Universal Electronics Inc. No part of this publication may be reproduced, transmitted, transcribed, stored in any retrieval system, or translated to any language, in any form or by any means, electronic, mechanical, magnetic, optical, manual, or otherwise, without the prior written permission of Universal Electronics Inc.

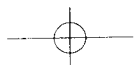



URC-9000 REV A
Home Producer
M????

7/99