

## Nemko Korea Co., Ltd.

67-1 &amp; 300-2, Osan-Ri, Mohyeon-Myeon, Cheoin-Gu, Yongin-City, Gyeonggi-Do, KOREA

TEL:+82 31 330 1700

FAX:+82 31 322 2332

### FCC/IC EVALUATION REPORT FOR CERTIFICATION

**Applicant :**

Telit Communications S.p.A.

Viale Stazione di Prosecco 5/B, 34010 Sgonico

Trieste, Italy

Dates of Issue : July 27, 2012

Test Report No. : NK-12-R-098

Test Site : Nemko Korea Co., Ltd.

FCC ID

IC ID

Brand Name



CONTACT PERSON

**RI7CE910-DUAL  
5131A-CE910DUAL****Telit****Telit Communications S.p.A.  
Viale Stazione di Prosecco 5/B, 34010  
Sgonico, Trieste, Italy  
Brian Tucker  
Telephone No. : +919-439-7977**

Applied Standard: FCC 47 CFR Part 2, 22, 24  
Classification: Licensed Transmitter(PCB)  
EUT Type: DUAL BAND CDMA Module

The device bearing the brand name and model specified above has been shown to comply with the applicable technical standards as indicated in the measurement report and was tested in accordance with the measurement procedures specified in ANSI C63.4-2003. The client should not use it to claim product endorsement by TAF or any government agencies. The test results in the report only apply to the tested sample.

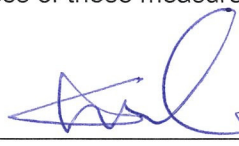
I attest to the accuracy of data and all measurements reported herein were performed by me or were made under my supervision and are correct to the best of my knowledge and belief. I assume full responsibility for the completeness of these measurements and vouch for the qualifications of all persons taking them.

  
July 27, 2012Tested By : Minchul. Shin  
Engineer  
July 27, 2012Reviewed By : Deokha Ryu  
Technical Manager

Telit Communications S.p.A.

Page 1 of 52

FCC ID: RI7CE910-DUAL / IC: 5131A-CE910DUAL

# TABLE OF CONTENTS

---

<b>1. Scope</b>	<b>4</b>
<b>2. Introduction (Site Description)</b>	<b>5</b>
2.1 Test facility	5
2.2 Accreditation and listing	6
<b>3. Test Conditions &amp; EUT Information</b>	<b>7</b>
3.1 Operating During Test	7
3.2 Environmental Conditions	7
3.3 Description of EUT	7
<b>4. Measuring Instrument Calibration</b>	<b>8</b>
<b>5. Summary of Test Results</b>	<b>9</b>
<b>6. Recommendation / Conclusion</b>	<b>9</b>
<b>7. Description of Test</b>	<b>10</b>
7.1 Effective Radiated Power / Equivalent Isotropic Radiated Power	10
7.2 Radiated Spurious & Harmonic Emission	11
7.3 Conducted Output Power	12
7.4 Conducted Spurious Emission	13
7.5 Frequency Stability / Temperature Variation	15
7.6 Conducted Output Power	16
<b>8. Test Data</b>	<b>17</b>
8.1 Conducted Output Power	17
8.2 Effective Radiated Power (ERP)	18
8.3 Equivalent Isotropic Radiated Power (EIRP)	19
8.4 Occupied Bandwidth / 26 dB Emission Bandwidth	20
8.5 Radiated Spurious & Harmonic Emission (Cellular)	21
8.6 Radiated Spurious & Harmonic Emission (PCS)	23
8.7 Frequency Stability / Temperature Variation (Cellular)	25
8.8 Frequency Stability / Temperature Variation (PCS)	26
8.9 Receiver Spurious Emissions	27

<b>9. Accuracy of Measurement</b>	<b>28</b>
<b>10. Test Plots (Cellular)</b>	<b>30</b>
<b>11. Test Plots (PCS)</b>	<b>37</b>
<b>12. Test Equipment List</b>	<b>44</b>
<b>Appendix A: Labelling Requirement</b>	<b>45</b>
<b>Appendix B: Photographs of Test Set-up</b>	<b>46</b>
<b>Appendix C: EUT Photographs</b>	<b>47</b>

# 1. Scope

---

Measurement and determination of electromagnetic emissions (EME) of radio frequency devices including intentional and/or unintentional radiators for compliance with the technical rules and regulations of the Federal Communications Commission under FCC Part 2 & Part 22 & 24 and Industrie Canada under RSS-Gen & 132 & 133.

<b>Responsible Party :</b>	Telit Communications S.p.A.
<b>Contact Person :</b>	Brian Tucker Tel No. : +919 439 7977
<b>Manufacturer :</b>	Telit Communications S.p.A. Viale Stazione di Prosecco 5/B, 34010 Sgonico, Trieste, Italy

- FCC ID: RI7CE910-DUAL
- IC 5131A-CE910DUAL
- Model: CE910-DUAL
- Brand Name: Telit
- EUT Type: DUAL BAND CDMA Module
- Classification: Licensed Potable Transmitter(PCB)
- Applied Standard: FCC 47 CFR Part & 2, 22, 24  
RSS-Gen, 132,133
- Test Procedure(s): ANSI C63.4 (2003)
- Dates of Test: June 18, 2012 ~ July 25, 2012
- Place of Tests: Nemko Korea Co., Ltd.

## 2. Introduction (Site Description)

### 2.1 Test facility

The measurement procedure described in American National Standard for Methods of Measurement of Radio-Noise Emissions from Low-Voltage Electrical and Electronic Equipment in the Range of 9 kHz to 40 GHz (ANSI C63.4-2003) was used in determining radiated and conducted emissions emanating from **Telit Communications S.p.A.**

**FCC ID : R17CE910-DUAL and IC: 5131A-CE910DUAL**

These measurement tests were conducted at **Nemko Korea Co., Ltd.**

The site address is 300-2, Osan-Ri, Mohyeon-Myeon, Cheoin-Gu, Yongin-Si, Gyeonggi-Do, KOREA

The area of Nemko Korea Corporation Ltd. Test site is located in a mountain area at 80 kilometers (48 miles) southeast and Incheon International Airport (Incheon Airport), 30 kilometers (18miles) south-southeast from central Seoul.

It is located in the valley surrounded by mountains in all directions where ambient radio signal conditions are quiet and a favorable area to measure the radio frequency interference on open field test site for the computing and ISM devices manufactures.







The detailed description of the measurement facility was found to be in compliance with the requirements of § 2.948 according to ANSI C63.4 2003.



Nemko Korea Co., Ltd.  
67-1 & 300-2, Osan-Ri, Mohyeon-Myeon, Cheoin-Gu, Yongin-Si, Gyeonggi-Do, KOREA 449-852  
Tel) +82-31-322-1700  
Fax) +82-31-322-2332

Fig. 1. The map above shows the Seoul in Korea vicinity area.  
The map also shows Nemko Korea Corporation Ltd. and Incheon Airport.

## 2.2 Accreditation and listing

	Accreditation type	Accreditation number
	FCC part 15/18 Filing site	Registration No. 97992
	CAB Accreditation for DOC	Designation No. KR0026
	KOLAS Accredited Lab. (Korea Laboratory Accreditation Scheme)	Registration No. 155
	Canada IC Registered site	Site No. 2040E
	VCCI registration site(RE/CE/Telecom CE)	Member No. 2118
	EMC CBTL	-
	KCC(RRL)Designated Lab.	Registration No. KR0026
	SASO registered Lab and Certification Body	Registration No. 2008-15

### 3. Test Conditions & EUT Information

#### 3.1 Operating During Test

The EUT was tested at the lowest channel, middle channel and the highest channel with maximum RF power and all data were recorded in the report.

#### 3.2 Environmental Conditions

Temperature	24°C ~ 28°C
Relative Humidity	30% ~ 55%

#### 3.3 Description of EUT

Frequency Band	Tx	824.70 MHz ~ 848.31 MHz 1851.25 MHz ~ 1908.75 MHz
	Rx	869.70 MHz ~ 893.31 MHz 1931.25 MHz ~ 1988.75 MHz
Output Power (Conducted power)	Cellular CDMA : 0.292 W(24.65 dBm) PCS CDMA : 0.278 W(24.44 dBm)	
Emission Designator	1M28F9W	
Antenna Type	Magnet Mount Antennas	
Antenna Gain	5.12 dBi for Cellular, 6.12 dBi for PCS	
Dimensions	28.2 mm(W) x 28.2 mm(D) x 2.4 mm(H)	
Weight	Approx. 4.7 g	
Operating Temperature	-30°C ~ +85 °C	

## 4. Measuring Instrument Calibration

---

All measurements were made with instruments calibrated according to the recommendation by manufacturer. Measurement of radiated emissions and conducted emissions were made with instruments conforming to American National Standards Institute, ANSI C63.4-2003.

The calibration of measuring instrument, including any accessories that may affect test results, were performed according to the recommendation by manufacturer.

- End of page -



## 5. Summary of Test Results

The EUT has been tested according to the following specification:

Description of Test	FCC Rule	IC Rule	Result
ERP / EIRP Measurement	§22.913(a)(2) §24.232(c)	RSS-132(4.4) [SRSP503(5.1.3)] RSS-133(6.4)	Complies
Conducted Output Power	§2.1046	RSS-132(4.4) RSS-133(4.1)	Complies
Occupied Bandwidth / 26dB Emission Bandwidth	§2.1049 §22.917(a) §24.238(a)	RSS-Gen(4.6.1) RSS-133(2.3)	Complies
Conducted Spurious Emission / Band Edge	§2.1051 §22.917(a) §24.238(a)	RSS-132(4.5.1) RSS-133(6.5.1)	Complies
Peak-Average Ratio	§24.232(d)	RSS-133(6.4)	Complies
Radiated Spurious & Harmonic Emission	§2.1053 §22.917(a) §24.238(a)	RSS-132(4.5.1) RSS-133(6.5.1)	Complies
Frequency Stability / Temperature Variation	§2.1055 §22.355 §24.235	RSS-132(4.3) RSS-133(6.3)	Complies
Receiver Spurious Emissions	-	RSS-Gen(6.1) RSS-132(4.6) RSS-133(6.6)	Complies

## 6. Recommendation / Conclusion

The data collected shows that the **Telit Communications S.p.A. DUAL BAND CDMA Module FCC ID: RI7CE910-DUAL/ IC: 5131A-CE910DUAL** is in compliance with Part 2, 22, 24 of the FCC Rules and RSS-Gen, 132, 133 of the IC Rules.

## 7. Description of Tests

### 7.1 Effective Radiated Power / Equivalent Isotropic Radiated Power

#### Test Set-up:

Effective Radiated Power Output and Equivalent Isotropic Radiated Power output Measurements by Substitution Method according to ANSI/TIA/EIA-603-A-2003.

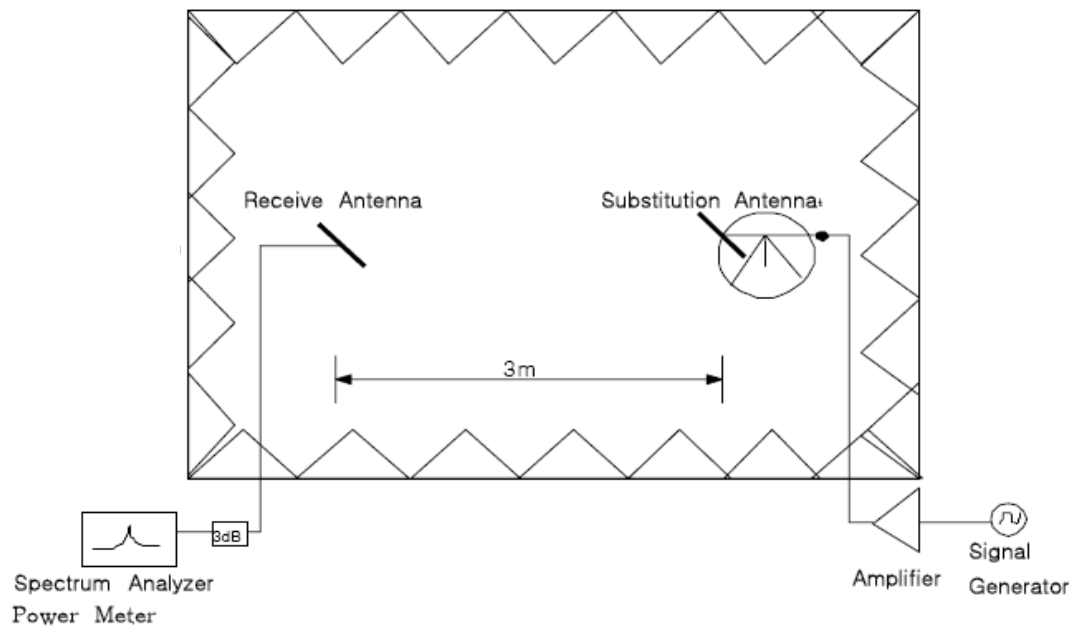

Diagram of ERP/EIRP test Set-up

The EUT was set on a non-conductive turntable in a semi anechoic chamber. In the corner of the chamber there was a communication antenna, which was connected to the BS simulator located outside the chamber. The radiated power from the EUT was measured with an antenna fixed to a antenna tower. The tower and turn table were remotely controlled to turn the EUT and change the antenna polarization. The measured signal was routed from the measuring antenna to the spectrum analyzer. The BS simulator was used to set the TX channel and power level and modulate the TX signal with different bit patterns.

#### Test Method:

1. The maximum power level was searched by moving the turn table and measuring antenna and manipulating the EUT. This level ( $P_{EUT}$ ) was recorded.
2. Spectrum analyzer was set to RBW 3 MHz, VBW 3 MHz, peak detection mode.
3. Replace the EUT with a substituting antenna and feed the substitution antenna at the EUT end with a signal generator connected to the antenna.
4. Adjust the level of the signal generator output until the previously recorded maximum reading for this set of conditions is obtained ( $P_{EUT}$ ).
5. Calculate the EIRP, in dBm, by the power loss in the cable between the generator and antenna, corrected for the gain of the substitution antenna.

## 7.2 Radiated Spurious & Harmonic Emission

### Test Set-up:

Effective Radiated Power Output and Equivalent Isotropic Radiated Power output Measurements by Substitution Method according to ANSI/TIA/EIA-603-A-2003.

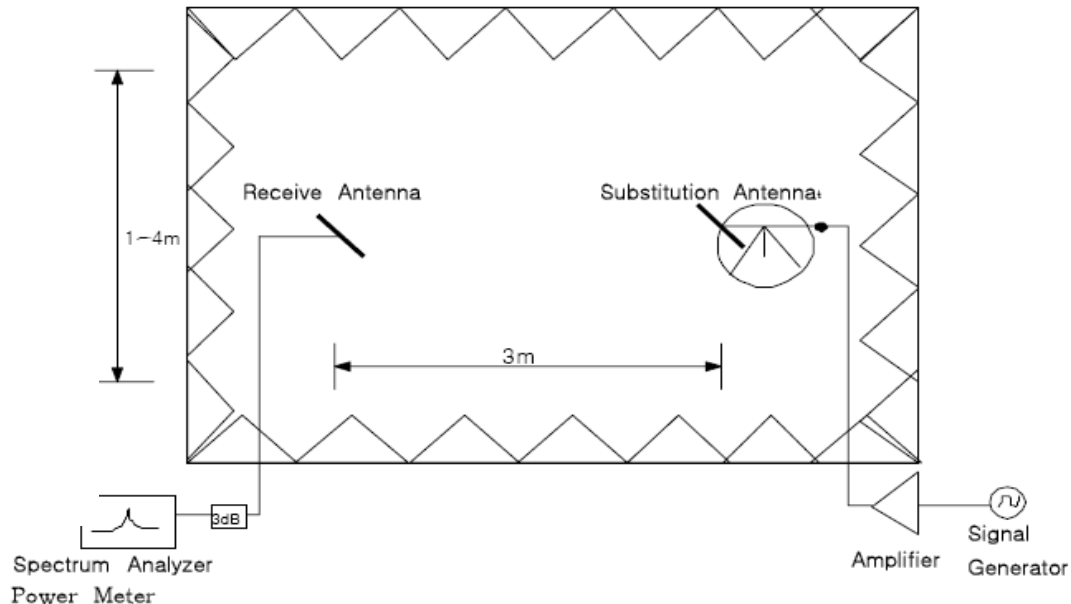

Diagram of Radiated Spurious & Harmonic test Set-up

The EUT was set on a non-conductive turntable in a semi anechoic chamber. In the corner of the chamber there was a communication antenna, which was connected to the BS simulator located outside the chamber. The radiated power from the EUT was measured with an antenna fixed to an antenna tower.

The tower and turn table were remotely controlled to turn the EUT and change the antenna polarization. The measured signal was routed from the measuring antenna to the spectrum analyzer. The BS simulator was used to set the TX channel and power level and modulate the TX signal with different bit patterns.

The radiated spurious and harmonic emission were measured up to 10<sup>th</sup> harmonic of the fundamental frequency of operation.

### Test Method:

1. The maximum power level was searched by moving the turn table and measuring antenna and manipulating the EUT. This level ( $P_{EUT}$ ) was recorded.
2. For measurements the resolution bandwidth and video bandwidth were set to 100 kHz for emissions below 1GHz and 1 MHz for emissions over 1GHz.
3. Replace the EUT with a substituting antenna and feed the substitution antenna at the EUT end with a signal generator connected to the antenna.
4. Adjust the level of the signal generator output until the previously recorded maximum reading for this set of conditions is obtained ( $P_{EUT}$ ).
5. Calculate the ERP, in dBm, by the power loss in the cable between the generator and antenna, corrected for the gain of the substitution antenna.

### 7.3 Occupied Bandwidth / 26dB Emission Bandwidth

#### Test Set-up:

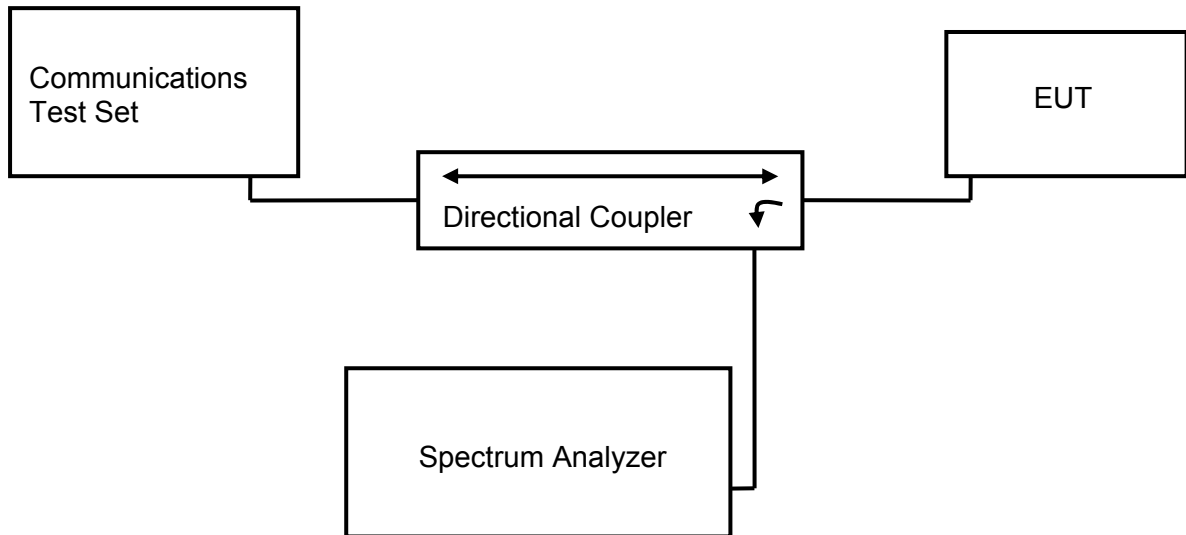

#### Test Method:

##### Occupied Bandwidth

The EUT was setup to maximum output power at its lowest channel. The occupied bandwidth was measured using a spectrum analyzer. The measurements are repeated for the highest and a middle channel.

The EUT's occupied bandwidth was measured as the width of the signal between two points, one below the carrier center frequency and one above the carrier frequency, outside of which all emissions are attenuated at least 26 dB below the transmitter power.

##### 26dB Emission Bandwidth

The transmitter output was connected to the spectrum analyzer.

The RBW of spectrum analyzer was set to approximately 1% of the emission bandwidth and peak detection was used. The emission bandwidth is defined as the total spectrum over which the power is higher than the peak power minus 26 dB.

## 7.4 Conducted Spurious Emission

### Test Set-up:

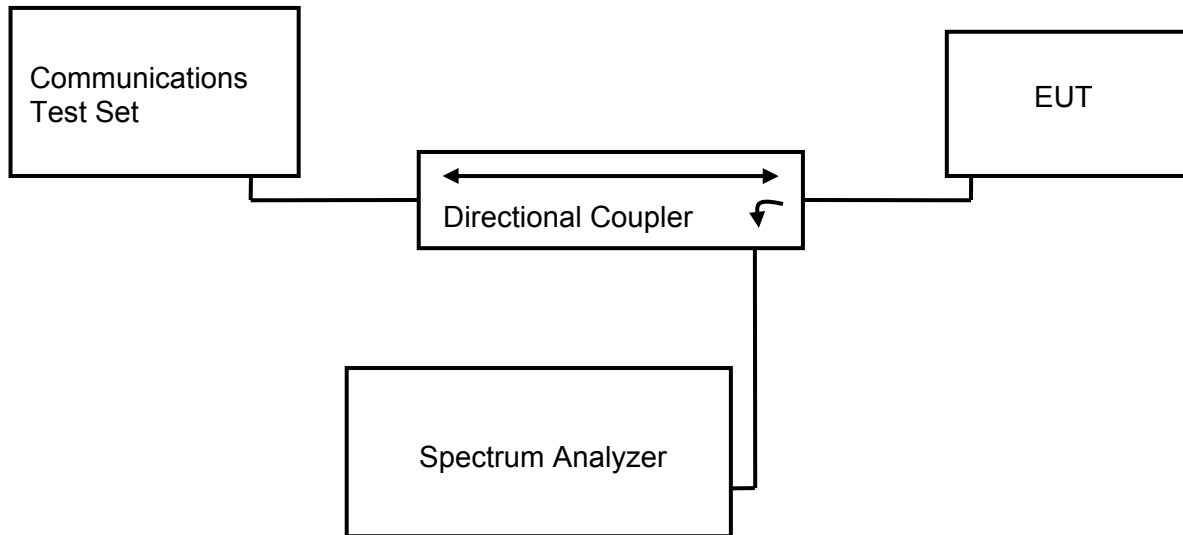

### Minimum standard:

On any frequency outside a license frequency block, the power of any emission shall be attenuated below the transmitter power (P) by at least  $43+10\log(P)$  dB. Limit equivalent to -13 dBm, calculation shown below.

$$43 + 10\log(0.912 \text{ W}) = 42.6 \text{ dB}$$
$$29.6 \text{ dBm} - 42.6 \text{ dB} = -13 \text{ dBm}$$

Compliance with the out-of-band emissions requirement is based on test being performed with an analyzer resolution bandwidth of 1 MHz. However in the 1 MHz band immediately outside and adjacent to the frequency block a resolution bandwidth of at least 1 % of the fundamental emissions bandwidth may be employed.

### Test Procedure:

The EUT was setup to maximum output power at its lowest channel.

The Resolution BW of the analyzer is set to 1 % of the emission bandwidth to show compliance with the -13 dBm limit, in the 1 MHz bands immediately outside and adjacent to the edge of the frequency block.

The measurements were repeated for the EUT's highest channel. For the Out-of-Band measurements a 1 MHz RBW, VBW and peak detection was used to scan from 10 MHz to 20 GHz. A display line was placed at -13 dBm to show compliance. The high, lowest and middle channels were tested for out of band measurements.

**Frequency Bands:**

<b>BLOCK</b>	<b>Frequency Range (MHz) Transmitter (Tx)</b>	<b>Frequency Range (MHz) Receiver (Rx)</b>
A* Low +A	824 ~ 835	869 ~ 880
B	835 ~ 845	880 ~ 890
A* High	845 ~ 846.5	890 ~ 891.5
B*	846.5 ~ 849	891.5 ~ 894

**Cellular Service Frequency Blocks**

<b>BLOCK</b>	<b>Frequency Range (MHz) Transmitter (Tx)</b>	<b>Frequency Range (MHz) Receiver (Rx)</b>
A	1850 ~ 1865	1930 ~ 1975
B	1870 ~ 1885	1950 ~ 1965
C	1895 ~ 1910	1975 ~ 1990
D	1865 ~ 1870	1945 ~ 1950
E	1885 ~ 1890	1965 ~ 1970
F	1890 ~ 1895	1970 ~ 1975

**PCS Service Frequency Blocks**

## 7.5 Frequency Stability / Temperature Variation

### Test Set-up:

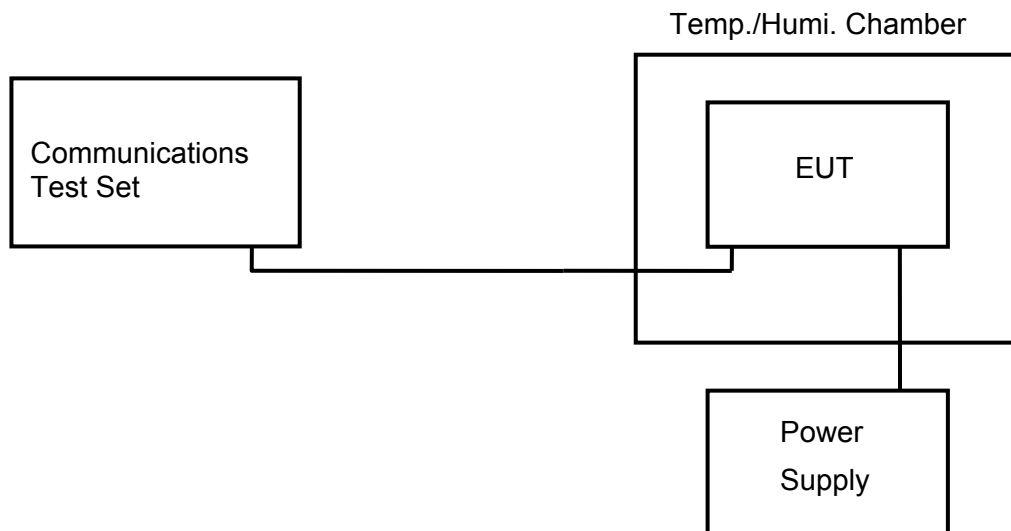

### Specification :

The frequency stability shall be sufficient to ensure that the fundamental emission stays within the authorized frequency block. The frequency stability of the transmitter shall be maintained within  $\pm 0.00025\%$  ( $\pm 2.5\text{ppm}$ ) of the center frequency.

### Test Method :

1. The carrier frequency of the transmitter and the individual oscillators is measured at room temperature (20 °C to 25 °C to provide a reference).
2. The equipment is subjected to an overnight "soak" at -30 °C without any power applied.
3. After the overnight "soak" at -30 °C (Usually 14 ~ 16 hours), the equipment is turned on in a "standby" condition for one minute before applying power to the transmitter. Measurement of the carrier frequency of the transmitter and the individual oscillators is made within a three minute interval after applying power to the transmitter.
4. Frequency measurements are made at 10 °C interval up to room temperature. At least a period of one and one half-hour is provided to allow stabilization of the equipment at each temperature level.
5. Again the transmitter carrier frequency and the individual oscillators is measured at room temperature to begin measurement of the upper temperature levels.
6. Frequency measurements are at 10 intervals starting at - 30 °C up to + 60 °C allowing at least two hours at each temperature for stabilization. In all measurements the frequency is measured within three minutes after re-applying power to the transmitter.
7. The artificial load is mounted external to the temperature chamber.

## 7.6 Conducted Output Power

### Test Set-up:

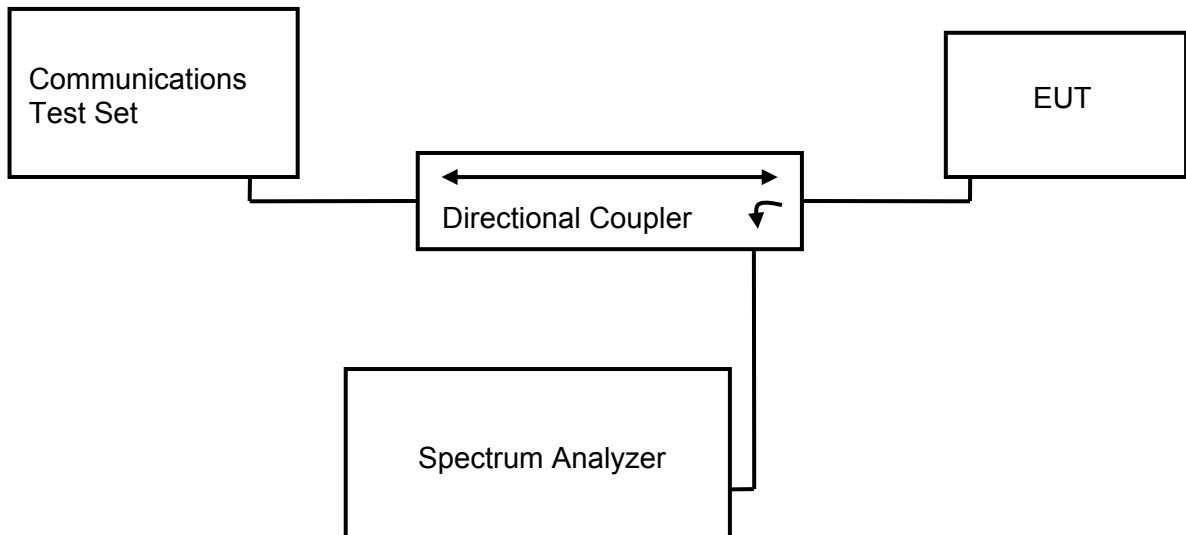

### Test Method :

For conducted power measurement, connected the EUT to Communications Test Set (E5515C) through the Directional Coupler. Set the EUT transmit the maximum power at the wanted channel by controlled E5515C. The test was performed using the Spectrum Analyzer with 3 MHz RBW, VBW under all configurations then, the highest power was recorded.



## 8. Test Data

### 8.1 Conducted Output Power

FCC §2.1046, RSS-132(4.4), RSS-133(4.1)

Measurement Results : Cellular and PCS

Mode : 1x RTT only

Band	Channel	Output Power (dBm)	
		Average	Peak
Cellular	1013	<b><u>24.65</u></b>	29.05
	384	24.49	29.22
	777	24.10	28.88
PCS	25	24.08	27.33
	600	24.29	27.85
	1175	<b><u>24.44</u></b>	28.47

Note: This device was tested under all R.C.s and S.O.s. The worst case is reported with RC1/SO55 with 'All Up' power control bits.

## 8.2 Effective Radiated Power (ERP)

FCC §22.913(a)(2), RSS-132(4.4)/SRSP503(5.1.3)

Measurement Results : Cellular

Mode : 1x RTT only

Frequency (MHz)	Ant*. Pol.	Reading (dBm)	Level at Antenna Terminal (dBm)	Antenna Gain (dBd)	ERP (dBm)	Limit (dBm)	Margin (dB)
824.70	V	-9.2	24.1	0	24.1	38.45	14.35
836.52	V	-9.0	24.6	0	24.6	38.45	13.85
848.31	V	-8.9	25.0	0	25.0	38.45	13.45

Radiated Measurements at 3meters

Note: Effective Radiated Power Output Measurements by Substitution Method according to ANSI/TIA/EIA-603-C-2..4, Aug. 17, 2004.

This device was tested under all R.C.s and S.O.s. The worst case is reported with RC1/SO55 with 'All Up' power control bits.

ERP(dB) =Level at Antenna Terminal(dBm) + Antenna Gain(dBd)

### 8.3 Equivalent Isotropic Radiated Power (EIRP)

FCC §24.232(c), RSS-133(6.4)

Measurement Results : PCS

Mode : 1x RTT only

Frequency (MHz)	Ant*. Pol.	Reading (dBm)	Level at Antenna Terminal (dBm)	Antenna Gain (dBi)	EIRP (dBm)	Limit (dBm)	Margin (dB)
1851.25	V	-20.9	13.3	7.70	21.0	33	12.0
1880.00	V	-19.0	16.1	7.70	23.8	33	9.2
1908.75	V	-16.4	19.0	7.70	26.7	33	6.3

Radiated Measurements at 3meters

Note: Effective Radiated Power Output Measurements by Substitution Method according to ANSI/TIA/EIA-603-C-2..4, Aug. 17, 2004.

This device was tested under all R.C.s and S.O.s. The worst case is reported with RC1/SO55 with 'All Up' power control bits.

$EIRP(dB) = Level\ at\ Antenna\ Terminal(dBm) + Antenna\ Gain(dBi)$

## **8.4 Occupied Bandwidth / 26 dB Emission Bandwidth**

**FCC §2.1049, RSS-133(2.3), RSS-Gen(4.6.1)**

**Measurement Results : Cellular and PCS**

**Measurement Results : Cellular**

<b>Channel</b>	<b>Frequency (MHz)</b>	<b>Occupied BW (MHz)</b>	<b>26dB Emission BW (MHz)</b>
1013	824.70	1.273	1.430
384	836.52	1.278	1.434
777	848.31	1.274	1.427

**Measurement Results : PCS**

<b>Channel</b>	<b>Frequency (MHz)</b>	<b>Occupied BW (MHz)</b>	<b>26dB Emission BW (MHz)</b>
25	1851.25	1.283	1.445
600	1880.00	1.281	1.449
1175	1908.75	1.279	1.438

### 8.5 Radiated Spurious & Harmonic Emission (Cellular)

#### FCC §2.1053, §22.917(a), RSS-132(4.5.1)

##### CH 1013 (824.70 MHz)

Frequency (MHz)	Ant*. Pol.	Reading (dBm)	Level at Antenna Terminal (dBm)	Antenna Gain (dBd)	ERP (dBm)	Limit (dBm)	Margin (dB)
1236.90	V	-57.7	-57.0	5.53	-51.5	-13	38.5
3298.50	V	-63.5	-57.9	7.01	-50.9	-13	37.9

Radiated Measurements at 3meters

##### CH 384 (836.52 MHz)

Frequency (MHz)	Ant*. Pol.	Reading (dBm)	Level at Antenna Terminal (dBm)	Antenna Gain (dBd)	ERP (dBm)	Limit (dBm)	Margin (dB)
1660.35	V	-64.1	-64.2	5.54	-58.7	-13	45.7
2542.80	V	-64.7	-60.4	6.31	-54.1	-13	41.1
3355.50	V	-65.2	-59.7	7.02	-52.7	-13	39.7

Radiated Measurements at 3meters

**CH 777 (848.31 MHz)**

Frequency (MHz)	Ant*. Pol.	Reading (dBm)	Level at Antenna Terminal (dBm)	Antenna Gain (dBd)	ERP (dBm)	Limit (dBm)	Margin (dB)
1697.70	V	-65.2	-65.3	5.54	-59.8	-13	46.8
2473.50	V	-65.3	-60.8	6.21	-54.6	-13	41.6
2637.75	V	-66.0	-61.1	6.44	-54.7	-13	41.7
3417.75	V	-64.9	-58.9	7.03	-51.9	-13	38.9

Radiated Measurements at 3meters

Note: Radiated Spurious Emission Measurements by Substitution Method according to ANSI/TIA/EIA-603-C-2..4, Aug. 17, 2004.

This device was tested under all R.C.s and S.O.s. The worst case is reported with RC1/SO55 with 'All Up' power control bits.

ERP(dB) =Level at Antenna Terminal(dBm) + Antenna Gain(dBd)

1. \*Ant Pol. H =Horizontal V=Vertical
2. For measurements the resolution bandwidth is set to 1 MHz, and then the video bandwidth is set to 1 MHz with peak measurements
3. The spectrum is measured to 10th harmonic and the worst-case emissions are reported. No significant emissions were found beyond the fifth harmonic for this device.

### 8.6 Radiated Spurious & Harmonic Emission (PCS)

FCC §2.1053, §24.238(a), RSS-133(6.5.1)

#### CH25 (1851.25 MHz)

Frequency (MHz)	Ant*. Pol.	Reading (dBm)	Level at Antenna Terminal (dBm)	Antenna Gain (dBd)	ERP (dBm)	Limit (dBm)	Margin (dB)
3701.88	V	-64.3	-57.2	7.09	-50.1	-13	37.1
5553.75	V	-66.1	-55.2	8.33	-46.9	-13	33.9

**Radiated Measurements at 3meters**

#### CH 600 (1880.00 MHz)

Frequency (MHz)	Ant*. Pol.	Reading (dBm)	Level at Antenna Terminal (dBm)	Antenna Gain (dBd)	ERP (dBm)	Limit (dBm)	Margin (dB)
3760.00	V	-64.4	-56.6	7.10	-49.5	-13	36.5
5640.63	V	-66.8	-55.8	8.42	-47.4	-13	34.4
7520.00	V	-65.9	-50.0	10.03	-40.0	-13	27.0

**Radiated Measurements at 3meters**

**CH 1175 (1908.75 MHz)**

Frequency (MHz)	Ant*. Pol.	Reading (dBm)	Level at Antenna Terminal (dBm)	Antenna Gain (dBd)	ERP (dBm)	Limit (dBm)	Margin (dB)
3816.25	V	-63.0	-55.0	7.11	-47.9	-13	34.9
5726.88	V	-66.1	-55.4	8.52	-46.9	-13	33.9
7635.00	V	-65.4	-50.4	10.62	-39.8	-13	26.8

**Radiated Measurements at 3meters**

Note: Radiated Spurious Emission Measurements by Substitution Method according to ANSI/TIA/EIA-603-C-2..4, Aug. 17, 2004.

This device was tested under all R.C.s and S.O.s. The worst case is reported with RC1/SO55 with 'All Up' power control bits.

ERP(dB) =Level at Antenna Terminal(dBm) + Antenna Gain(dBd)

1. \*Ant Pol. H =Horizontal V=Vertical
2. For measurements the resolution bandwidth is set to 1 MHz, and then the video bandwidth is set to 1 MHz with peak measurements
3. The spectrum is measured to 10th harmonic and the worst-case emissions are reported. No significant emissions were found beyond the fifth harmonic for this device.



### 8.7 Frequency Stability / Temperature Variation (Cellular)

**Test channel : Middle channel (836.52 MHz)**

**Standard test voltage : 3.8 Vdc**

**Deviation Limit :  $\pm 2.5$  ppm**

**Measurement Result :**

Voltage (%)	Power (Vdc)	Temp. (°C)	Frequency (Hz)	Frequency Error (Hz)	ppm
100%	3.8	+23(Ref.)	836,519,991	-9	-0.0108
100%		-30	836,519,992	-8	-0.0096
100%		-20	836,519,993	-7	-0.0084
100%		-10	836,519,967	-33	-0.0394
100%		0	836,519,968	-32	-0.0383
100%		10	836,519,968	-32	-0.0383
100%		20	836,519,983	-17	-0.0203
100%		30	836,519,994	-6	-0.0072
100%		40	836,519,991	-9	-0.0108
100%		50	836,519,985	-15	-0.0179
100%		60	836,519,985	-15	-0.0179
85%		3.23	23	836,519,992	-8
115%	4.37	23	836,519,990	-10	-0.0120

**\*The temperature is varied from -30°C to +60°C using an environmental chamber.**

### 8.8 Frequency Stability / Temperature Variation (PCS)

Test channel : Middle channel (1880.00 MHz)

Standard test voltage : 3.8 Vdc

Deviation Limit :  $\pm 2.5$  ppm

#### Measurement Result :

Voltage (%)	Power (Vdc)	Temp. (°C)	Frequency (Hz)	Frequency Error (Hz)	ppm
100%	3.8	+23(Ref.)	1,880,000,021	21	0.0112
100%		-30	1,880,000,027	27	0.0144
100%		-20	1,880,000,032	32	0.0170
100%		-10	1,880,000,029	29	0.0154
100%		0	1,879,999,975	-25	-0.0133
100%		10	1,880,000,021	21	0.0112
100%		20	1,880,000,020	20	0.0106
100%		30	1,880,000,021	21	0.0112
100%		40	1,880,000,017	17	0.0090
100%		50	1,879,999,978	-22	-0.0117
100%		60	1,879,999,979	-21	-0.0112
85%		3.23	23	1,879,999,981	-19
115%	4.37	23	1,880,000,021	21	0.0112

\*The temperature is varied from -30°C to +60°C using an environmental chamber.

### 8.9 Receiver Spurious Emissions

#### RSS-Gen(6.1), RSS-132(4.6), RSS-133(6.6)

Frequency (MHz)	Reading (dB $\mu$ V/m)	Pol* (H/V)	AF+CL+Amp (dB)**	Result (dB $\mu$ V/m)	Limit (dB $\mu$ V/m)	Margin (dB)
156.59	49.1	H	-21.1	28.0	43.5	15.5
159.01	49.1	V	-21.1	28.0	43.5	15.5
474.75	46.7	V	-16.4	30.3	46.0	15.7
688.15	45.4	H	-11.1	34.3	46.0	11.7
697.85	44.8	H	-11.1	33.7	46.0	12.3
959.75	46.3	V	-7.8	38.5	46.0	7.5

#### Radiated Measurements at 3 meters

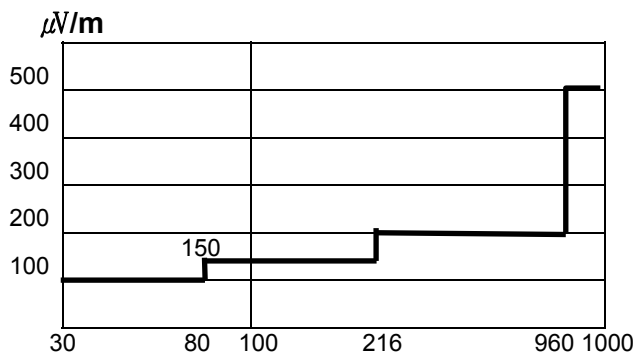

Fig. 5. Limits at 3 meters

Notes:

1. All modes were measured and the worst-case emission was reported.
- 2 The radiated limits are shown on Figure 5. Above 1 GHz the limit is 500  $\mu$ V/m.

MHz

Notes:

1. \*Pol. H = Horizontal, V = Vertical
2. \*\*AF + CL + Amp. = Antenna Factor + Cable Loss + Amplifier.
3. Measurements using CISPR quasi-peak mode.
4. The limit is on the IC RSS GEN Clause 6.1.

## 9. ACCURACY OF MEASUREMENT

The Measurement Uncertainties stated were calculated in accordance with the requirements of measurement uncertainty contained in CISPR 16-4-2 with the confidence level of 95%

### 1. Conducted Uncertainty Calculation

Source of Uncertainty	$X_i$	Uncertainty of $X_i$		Coverage factor $k$	$u(X_i)$ (dB)	$C_i$	$C_i u(X_i)$ (dB)
		Value (dB)	Probability Distribution				
Receiver reading	<b>RI</b>	± 0.1	normal 1	1.000	0.1	1	0.1
Attenuation AMN-Receiver	<b>LC</b>	± 0.08	normal 2	2.000	0.04	1	0.04
AMN Voltage division factor	<b>LAMN</b>	± 0.8	normal 2	2.000	0.4	1	0.4
Sine wave voltage	<b>dVSW</b>	± 2.00	normal 2	2.000	1.00	1	1.00
Pulse amplitude response	<b>dVPA</b>	± 1.50	rectangular	1.732	0.87	1	0.87
Pulse repetition rate response	<b>dVPR</b>	± 1.50	rectangular	1.732	0.87	1	0.87
Noise floor proximity	<b>dVNF</b>	± 0.00	-	-	0.00	1	0.00
AMN Impedance	<b>dZ</b>	± 1.80	triangular	2.449	0.73	1	0.73
Ⓐ Mismatch	<b>M</b>	+ 0.70	U-Shaped	1.414	0.49	1	0.49
Ⓑ Mismatch	<b>M</b>	- 0.80	U-Shaped	1.414	- 0.56	1	- 0.56
Measurement System Repeatability	<b>RS</b>	0.05	normal 1	1.000	0.05	1	0.05
Remark	Ⓐ: AMN-Receiver Mismatch : + Ⓑ: AMN-Receiver Mismatch : -						
Combined Standard Uncertainty	Normal			± 1.88			
Expanded Uncertainty U	Normal ( $k = 2$ )			± 3.76			

## 2. Radiation Uncertainty Calculation

Source of Uncertainty	$X_i$	Uncertainty of $X_i$		Coverage factor $k$	$u(X_i)$ (dB)	$C_i$	$C_i u(X_i)$ (dB)
		Value (dB)	Probability Distribution				
Receiver reading	<b>RI</b>	± 0.10	normal 1	1.000	0.10	1	0.10
Sine wave voltage	<b>dVsw</b>	± 2.00	normal 2	2.000	1.00	1	1.00
Pulse amplitude response	<b>dVpa</b>	± 1.50	rectangular	1.732	0.87	1	0.87
Pulse repetition rate response	<b>dVpr</b>	± 1.50	rectangular	1.732	0.87	1	0.87
Noise floor proximity	<b>dVnf</b>	± 0.50	normal 2	2.000	0.25	1	0.25
Antenna Factor Calibration	<b>AF</b>	± 1.50	normal 2	2.000	0.75	1	0.75
Attenuation Antenna-receiver	<b>CL</b>	± 0.52	normal 2	2.000	0.26	1	0.26
Antenna Directivity	<b>AD</b>	± 1.00	rectangular	1.732	0.58	1	0.58
Antenna Factor Height Dependence	<b>AH</b>	± 0.50	rectangular	1.732	0.29	1	0.29
Antenna Phase Centre Variation	<b>AP</b>	± 0.30	rectangular	1.732	0.17	1	0.17
Antenna Factor Frequency Interpolation	<b>AI</b>	± 0.30	rectangular	1.732	0.17	1	0.17
Site Imperfections	<b>SI</b>	± 4.00	triangular	2.449	1.63	1	1.63
Measurement Distance Variation	<b>DV</b>	± 0.10	rectangular	1.732	0.06	1	0.06
Antenna Balance	<b>Dbal</b>	± 0.90	rectangular	1.732	0.52	1	0.52
Cross Polarisation	<b>DCross</b>	± 0.90	rectangular	1.732	0.52	1	0.52
Ⓐ Mismatch	<b>M</b>	+ 0.25	U-Shaped	1.414	0.18	1	0.18
Ⓑ Mismatch	<b>M</b>	- 0.26	U-Shaped	1.414	- 0.18	1	- 0.18
Ⓒ Mismatch	<b>M</b>	+ 0.98	U-Shaped	1.414	0.69	1	0.69
Ⓓ Mismatch	<b>M</b>	- 1.11	U-Shaped	1.414	- 0.79	1	- 0.79
Measurement System Repeatability	<b>RS</b>	0.09	normal 1	1.000	0.09	1	0.09
Remark	Ⓐ: Biconical Antenna-receiver Mismatch : + (< 200 MHz) Ⓑ: Biconical Antenna-receiver Mismatch : - (< 200 MHz) Ⓒ: Log Periodic Antenna-receiver Mismatch : + (≥ 200 MHz) Ⓓ: Log Periodic Antenna-receiver Mismatch : - (≥ 200 MHz)						
Combined Standard Uncertainty	Normal			± 2.63 (< 200 MHz) ± 2.74 (≥ 200 MHz)			
Expanded Uncertainty U	Normal ( $k = 2$ )			± 5.26 (< 200 MHz) ± 5.48 (≥ 200 MHz)			

# 10. Test Plots (Cellular)

## ● Occupied Bandwidth / 26dB Bandwidth

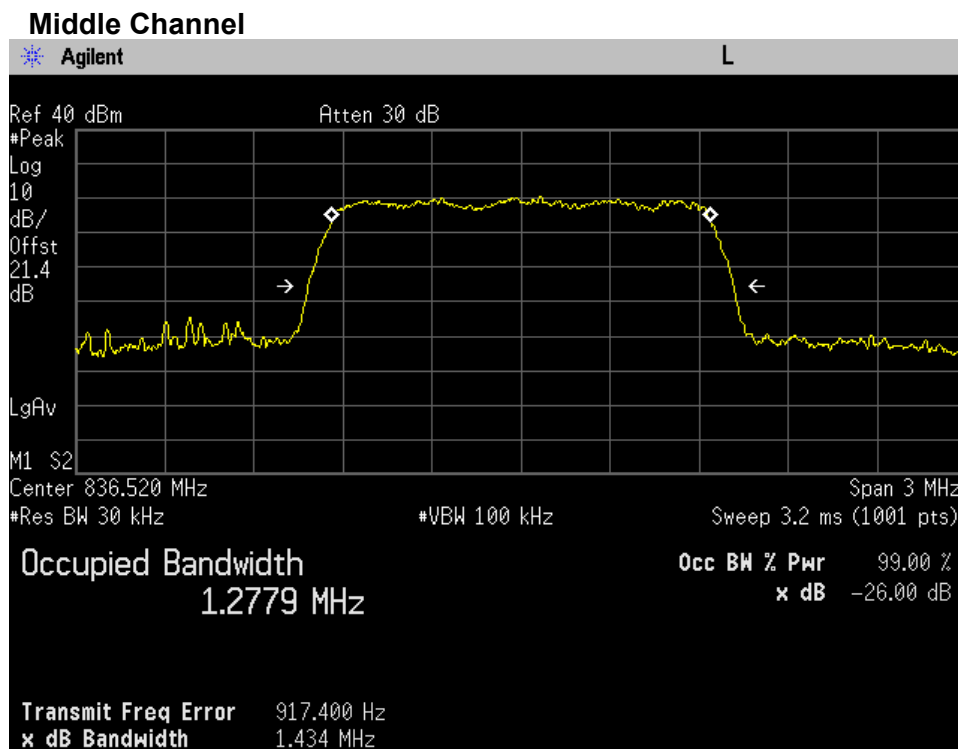
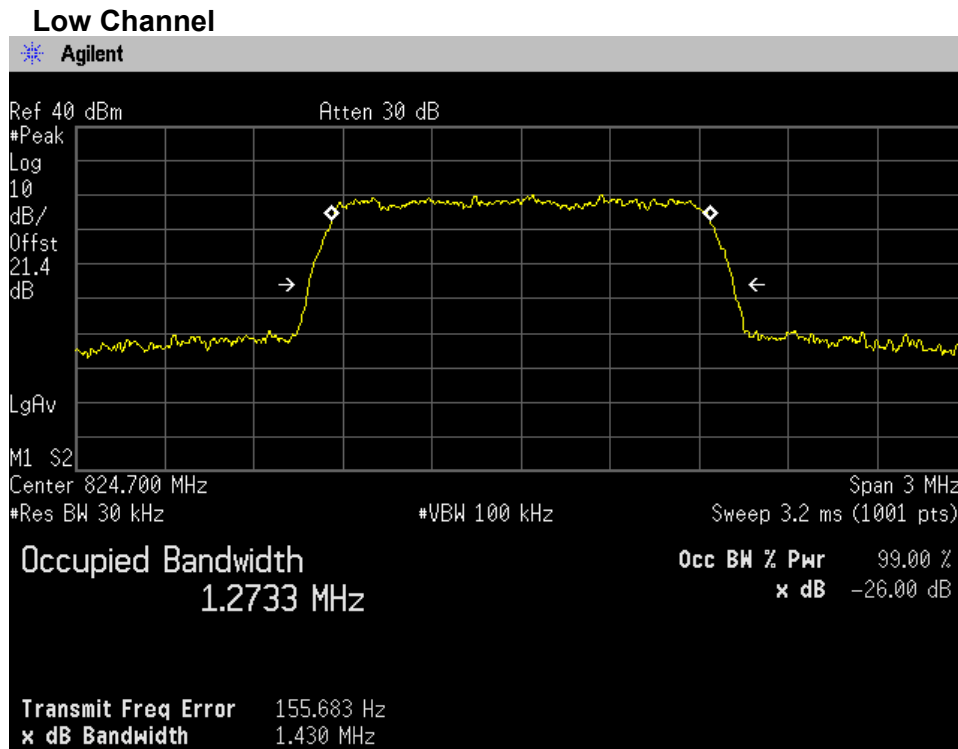

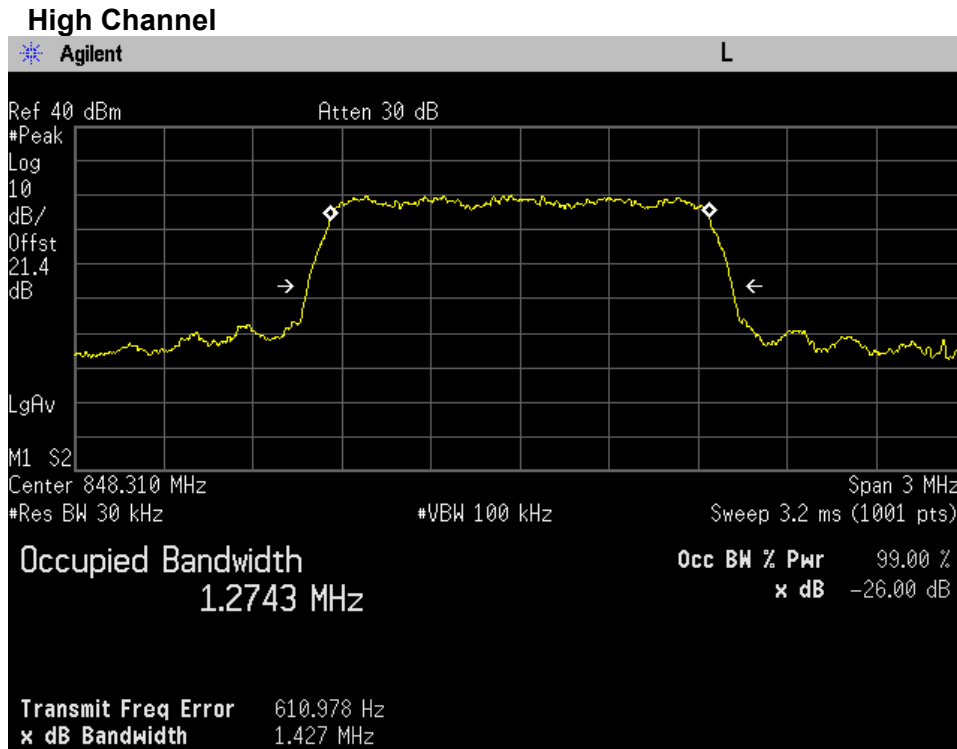

● **Spurious Emission at antenna Terminals**

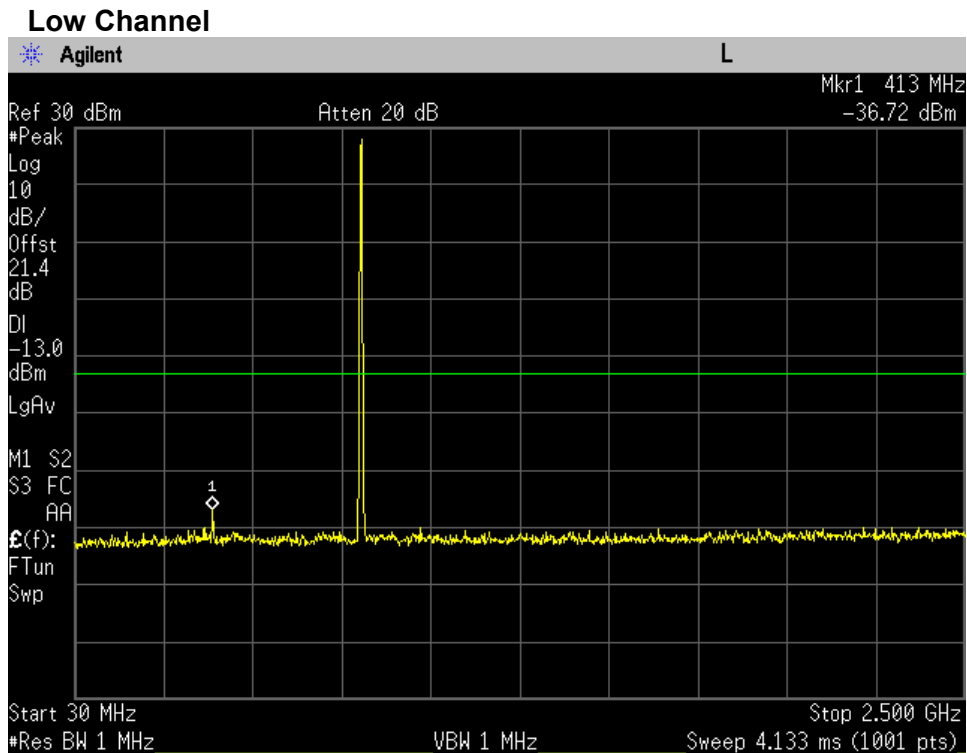

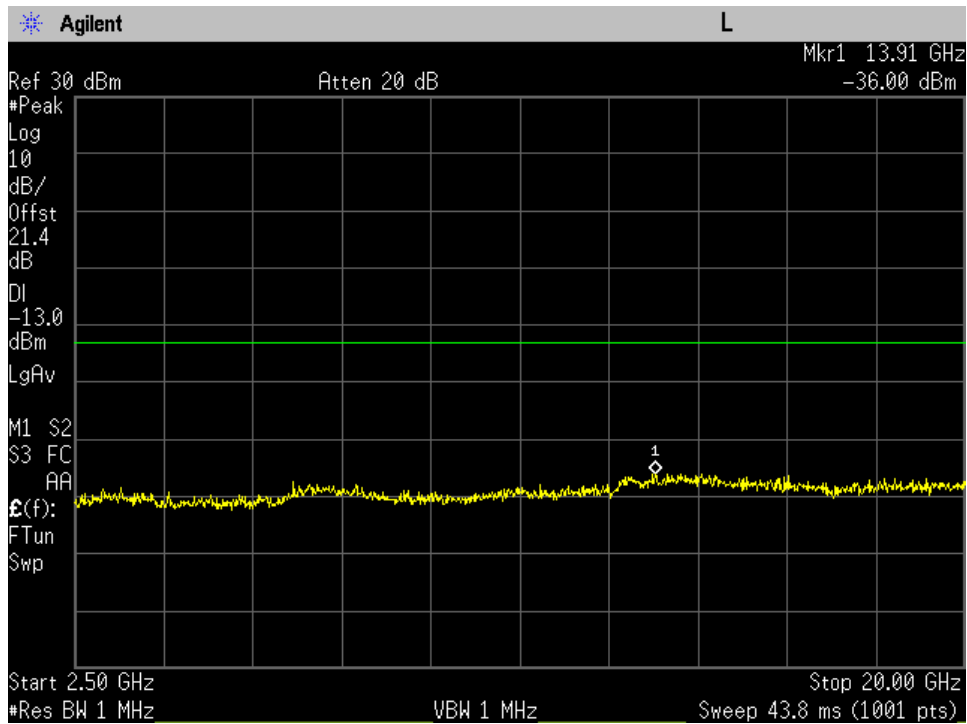

**Middle Channel**

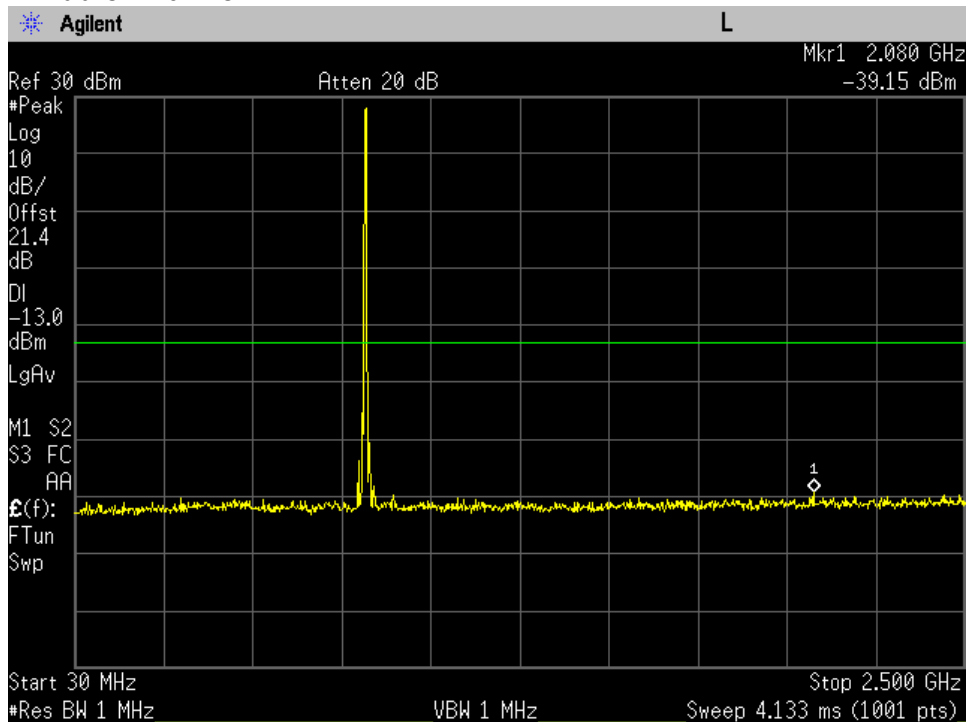



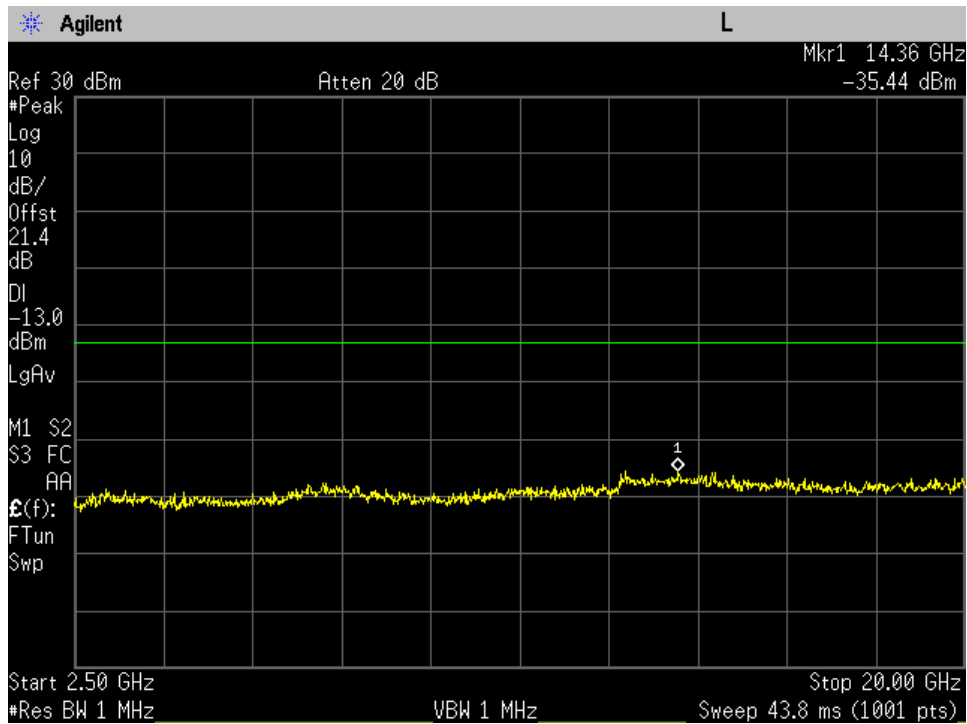

**High Channel**

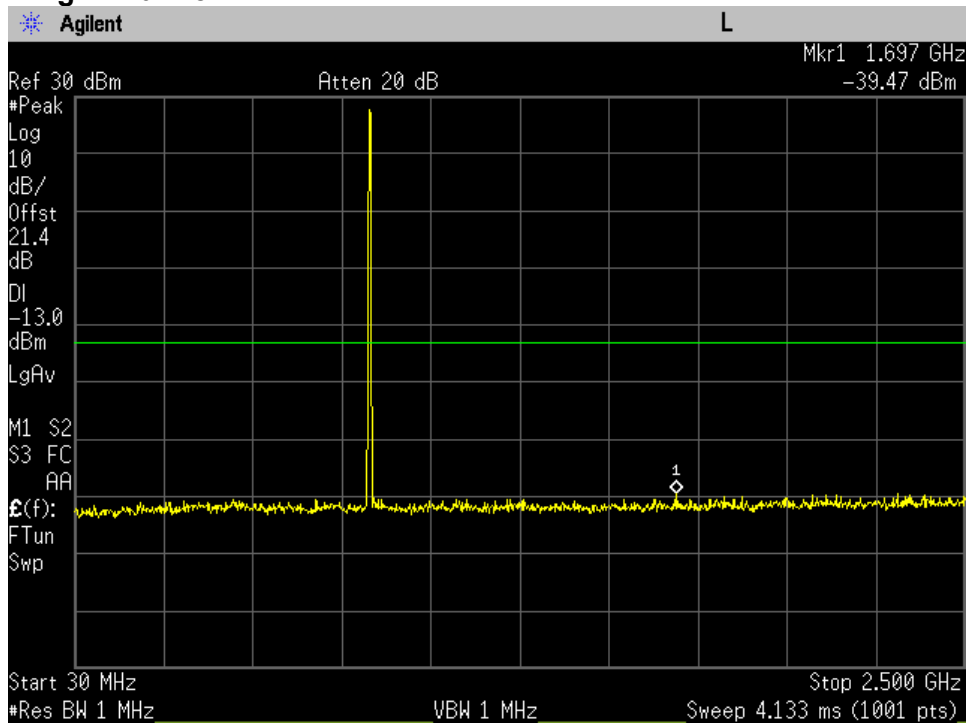

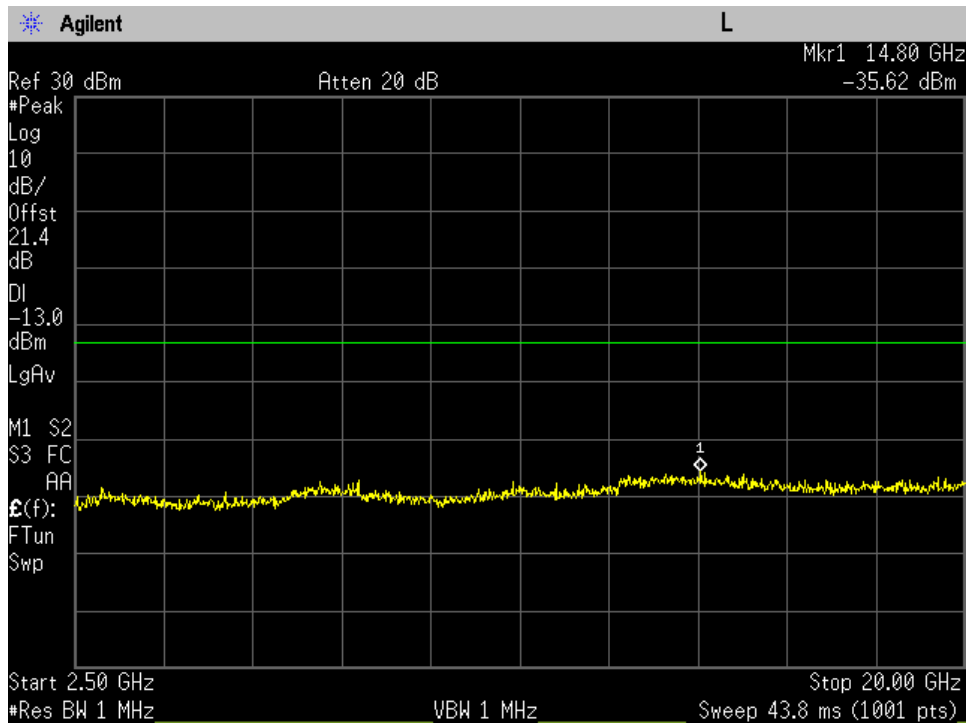

● **Band Edge**

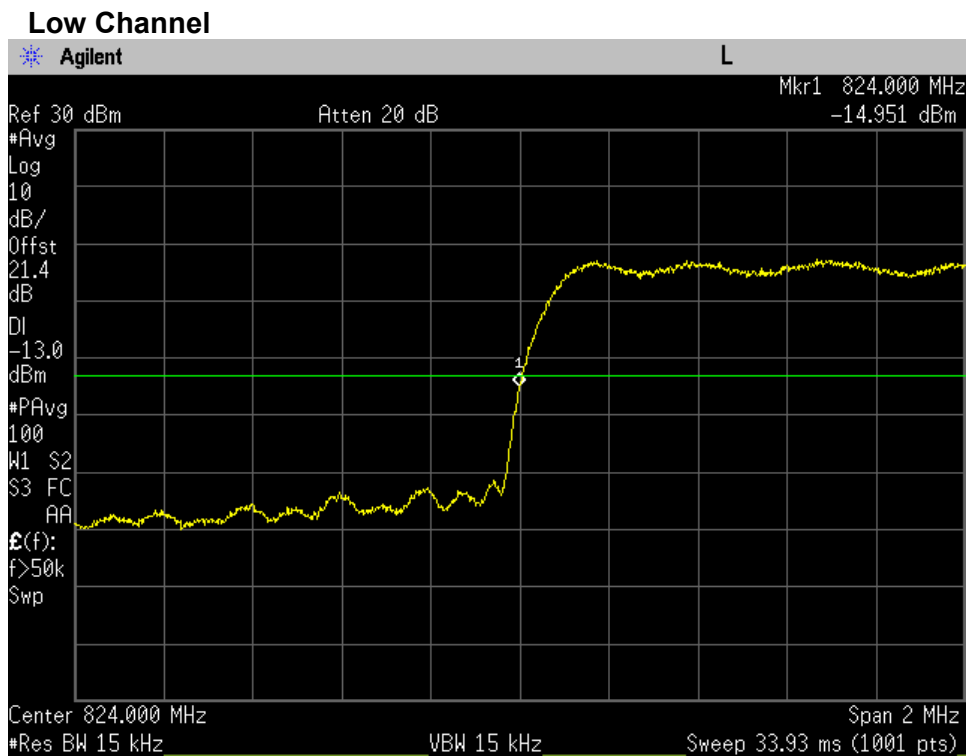

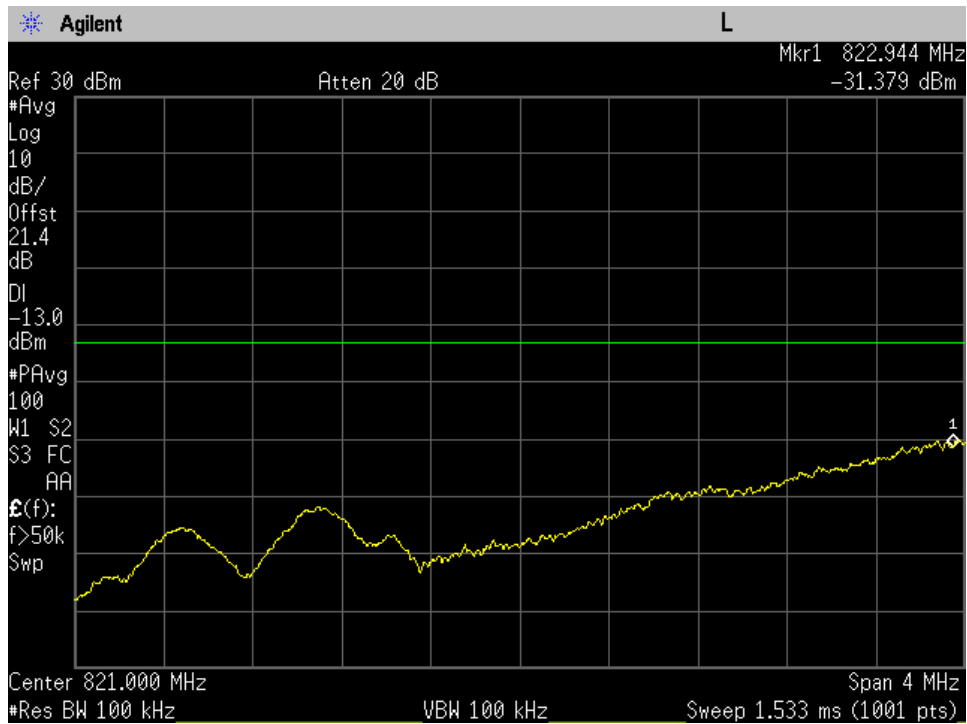

**High Channel**

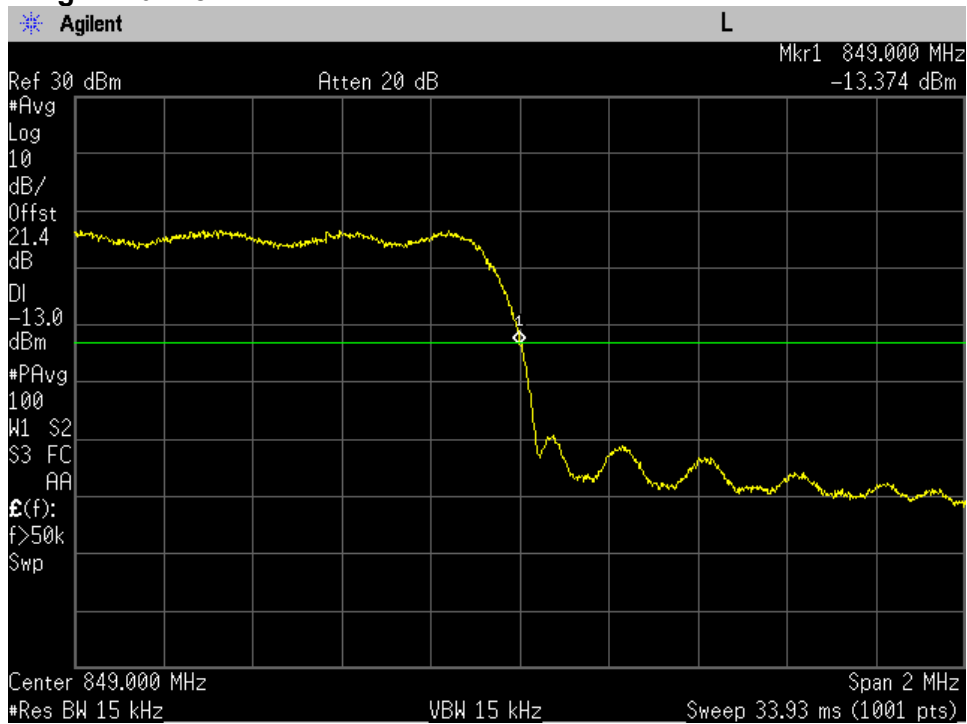

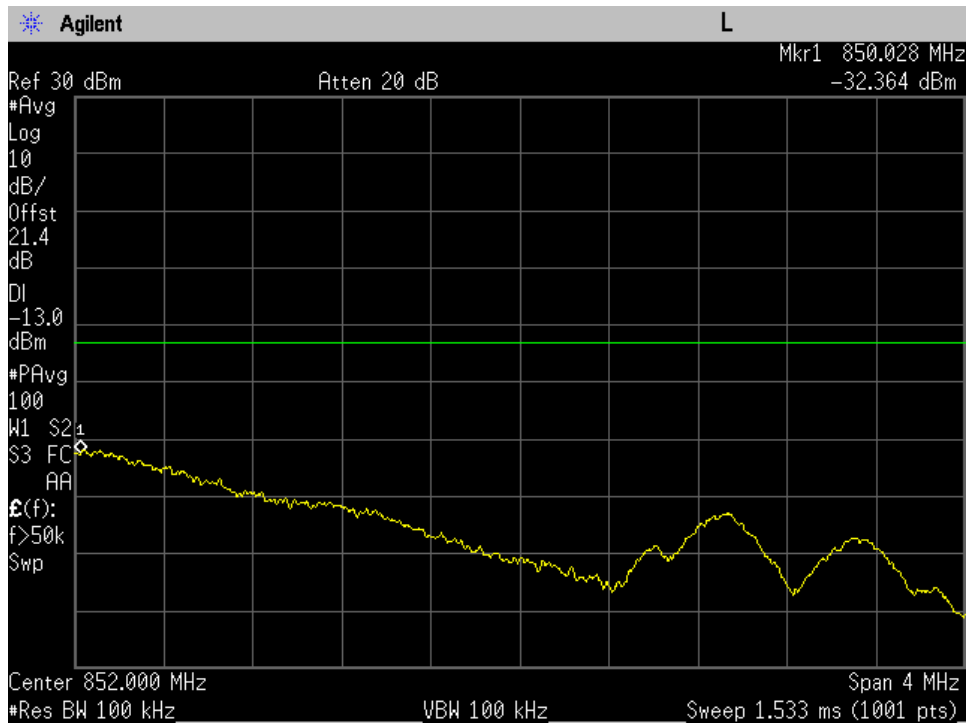

# 11. Test Plots (PCS)

## ● Occupied Bandwidth / 26dB Bandwidth

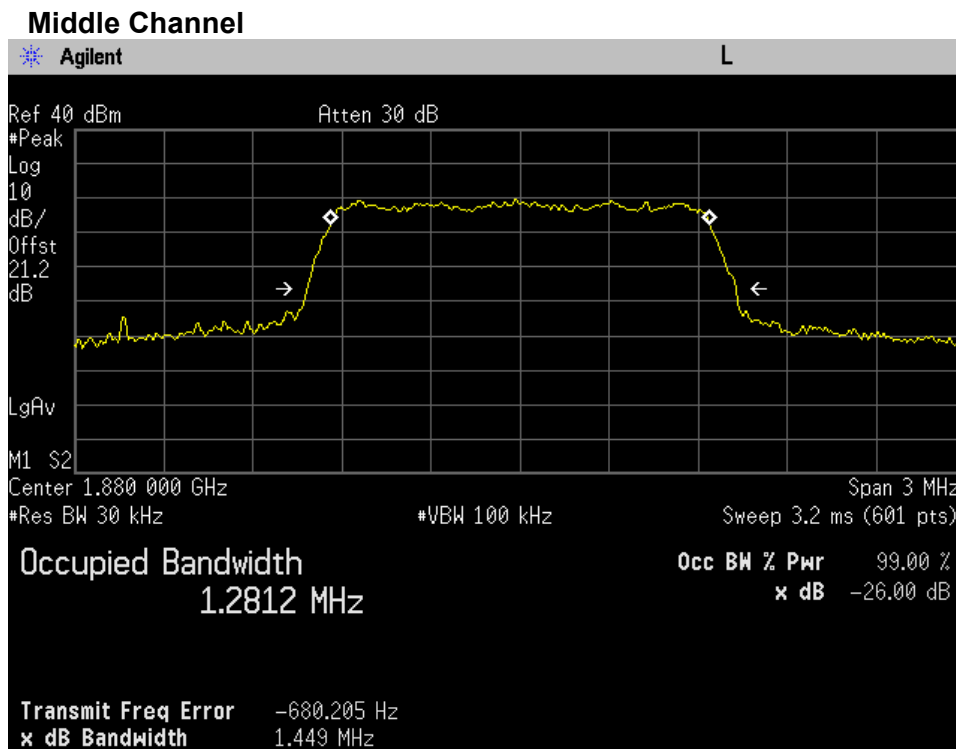
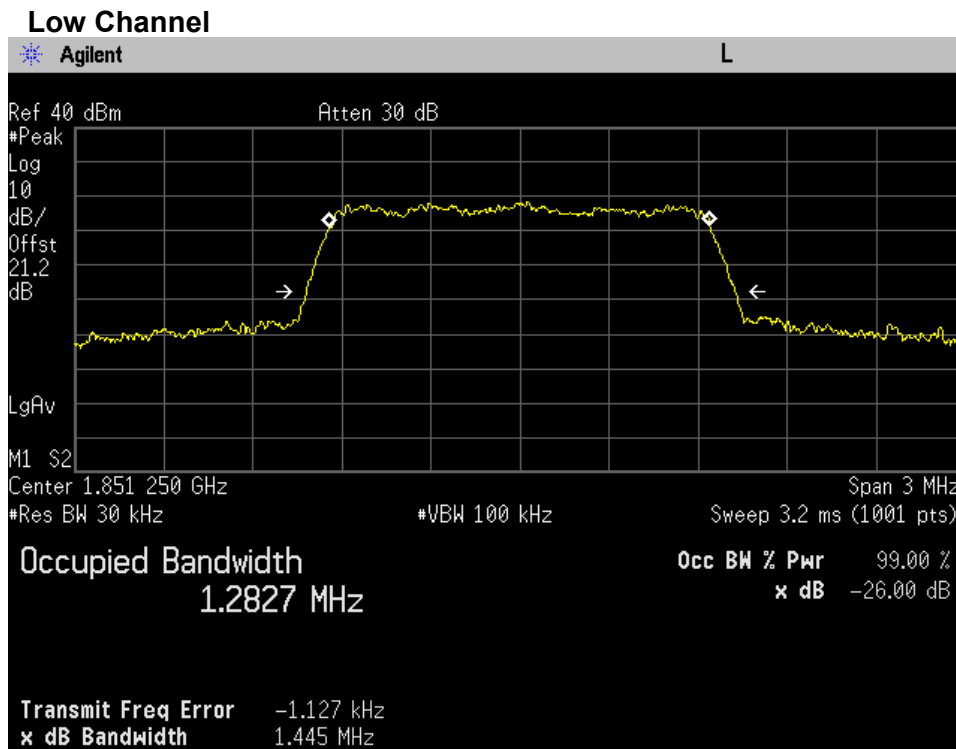

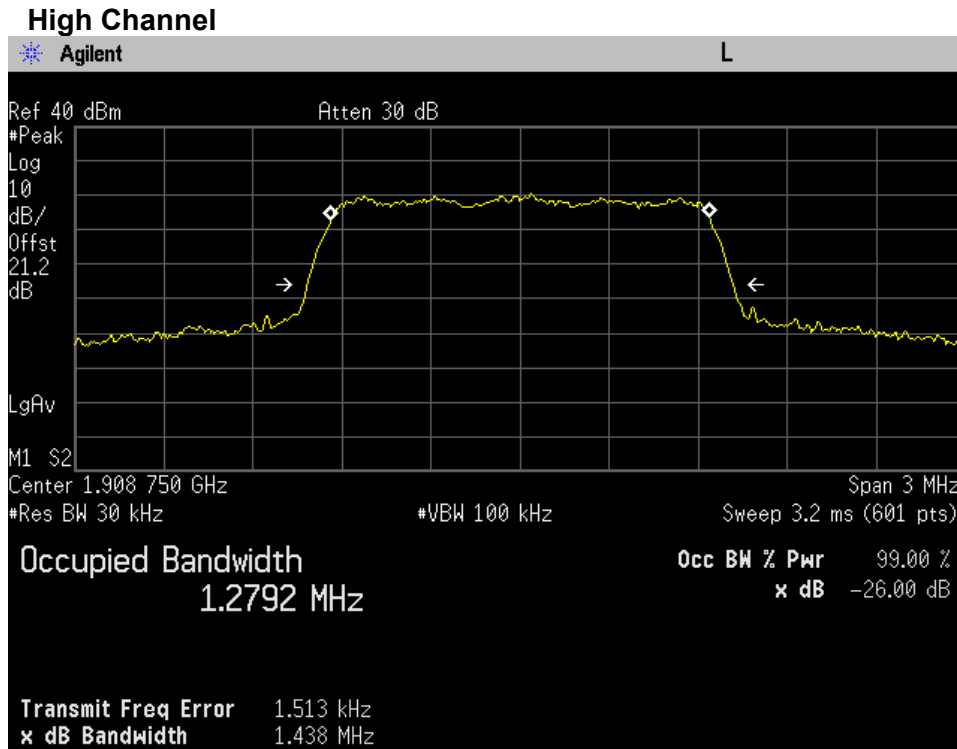

● **Spurious Emission at antenna Terminals**

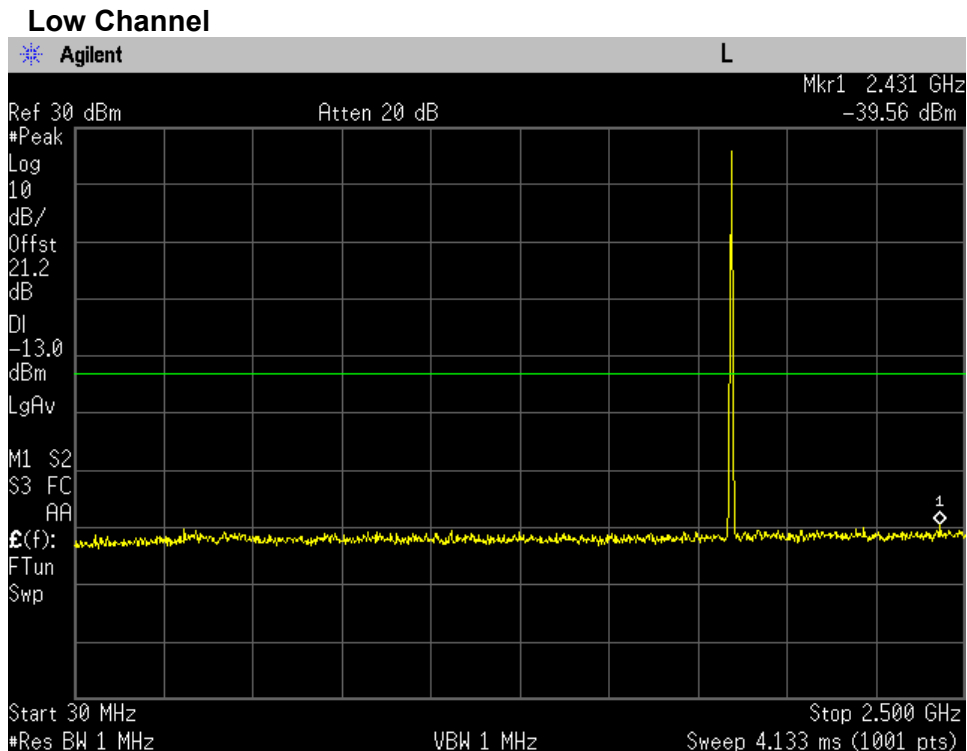

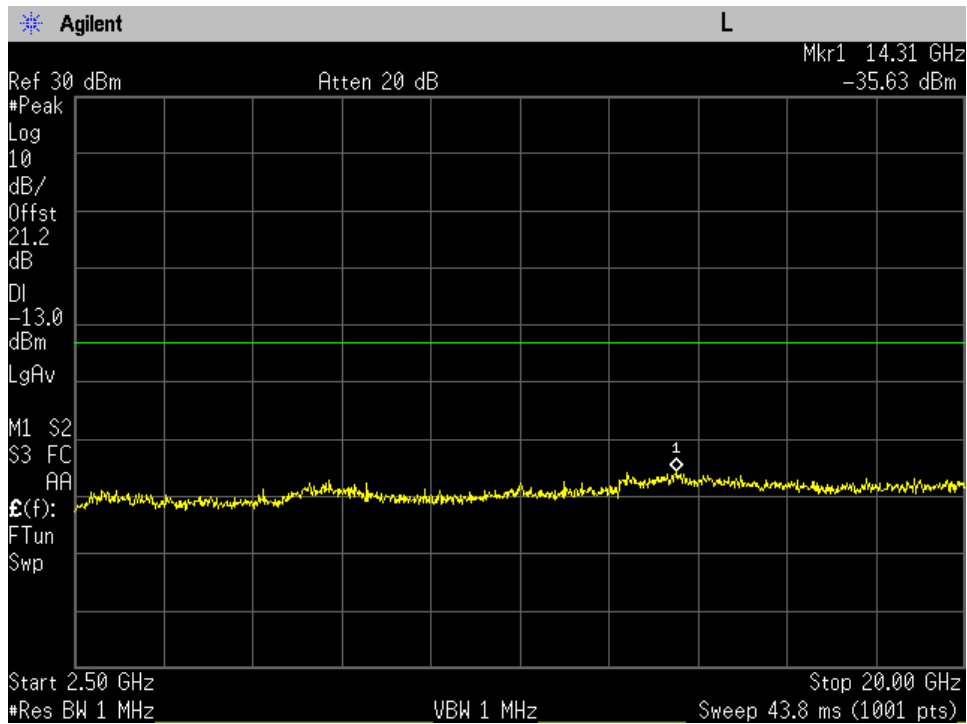

**Middle Channel**

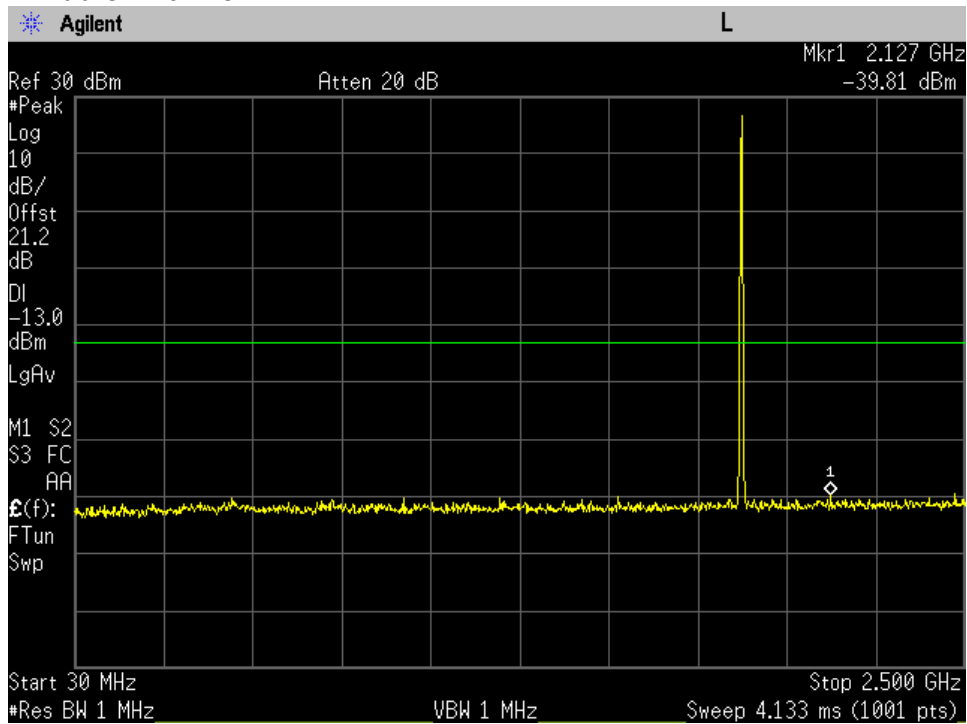

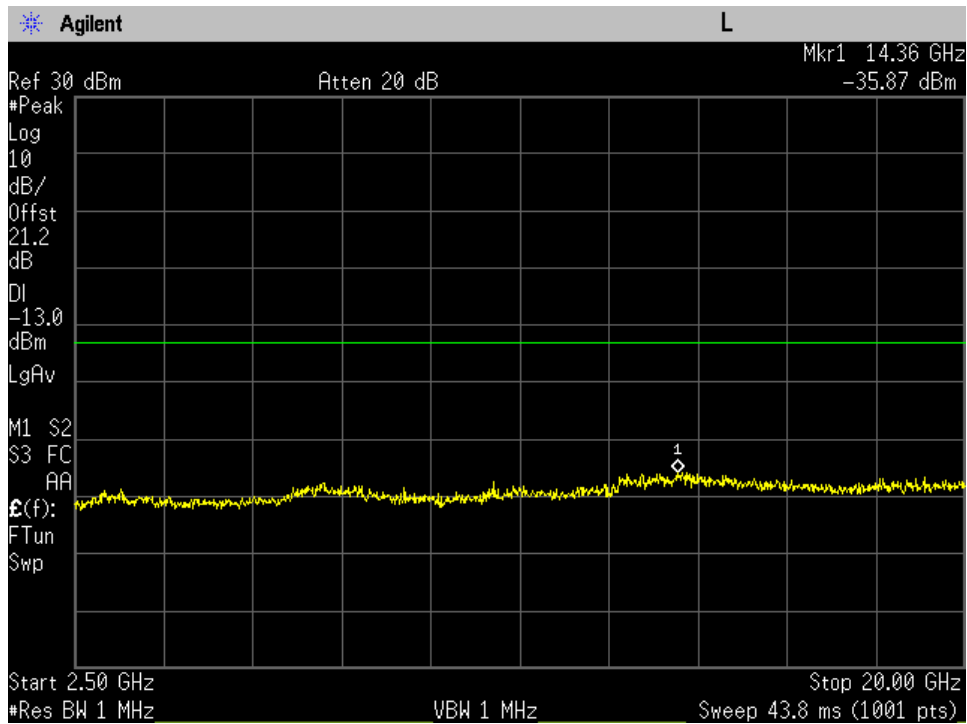

### High Channel

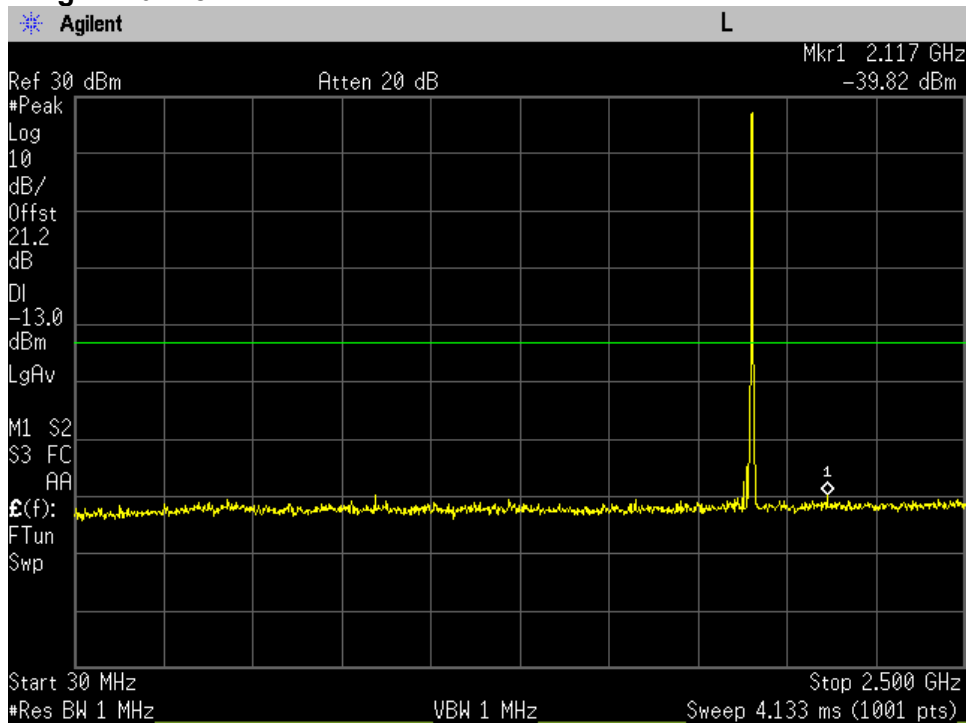



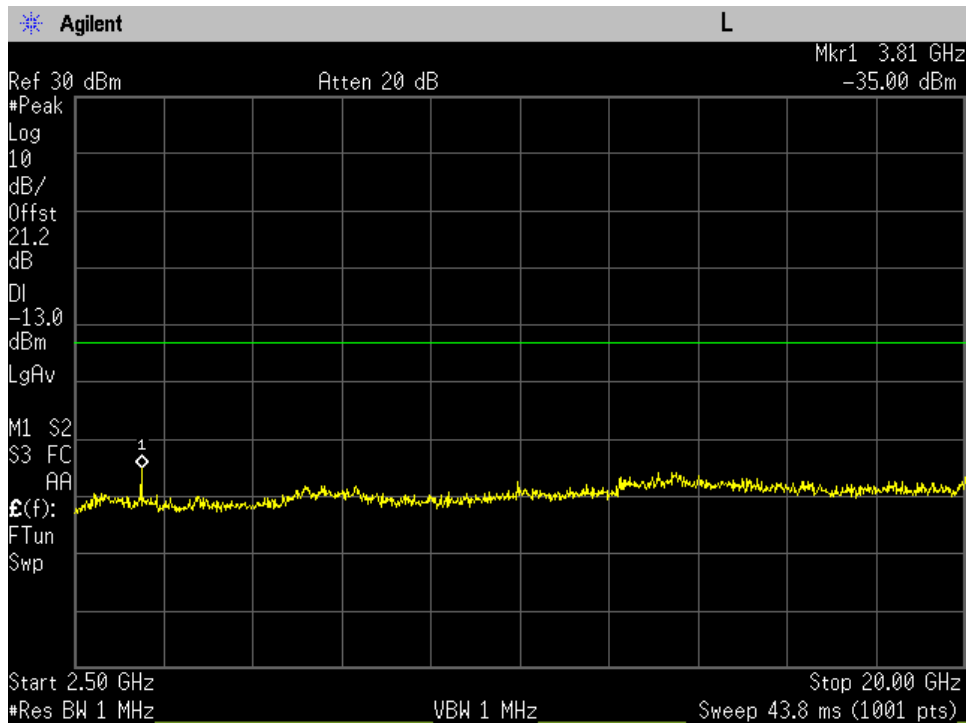

● **Band Edge**

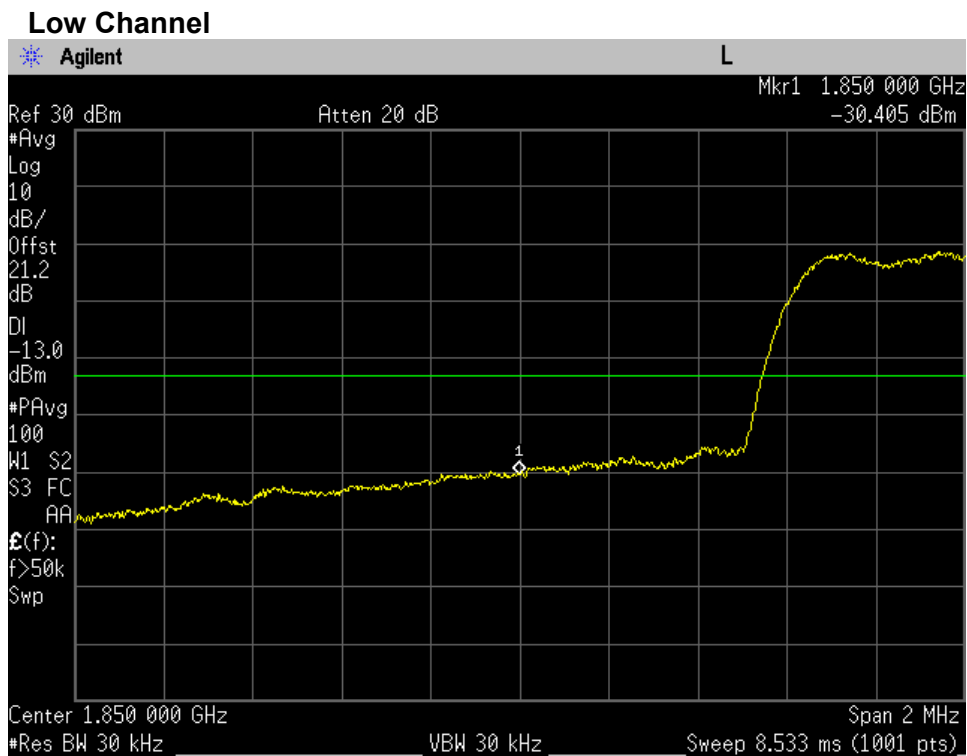

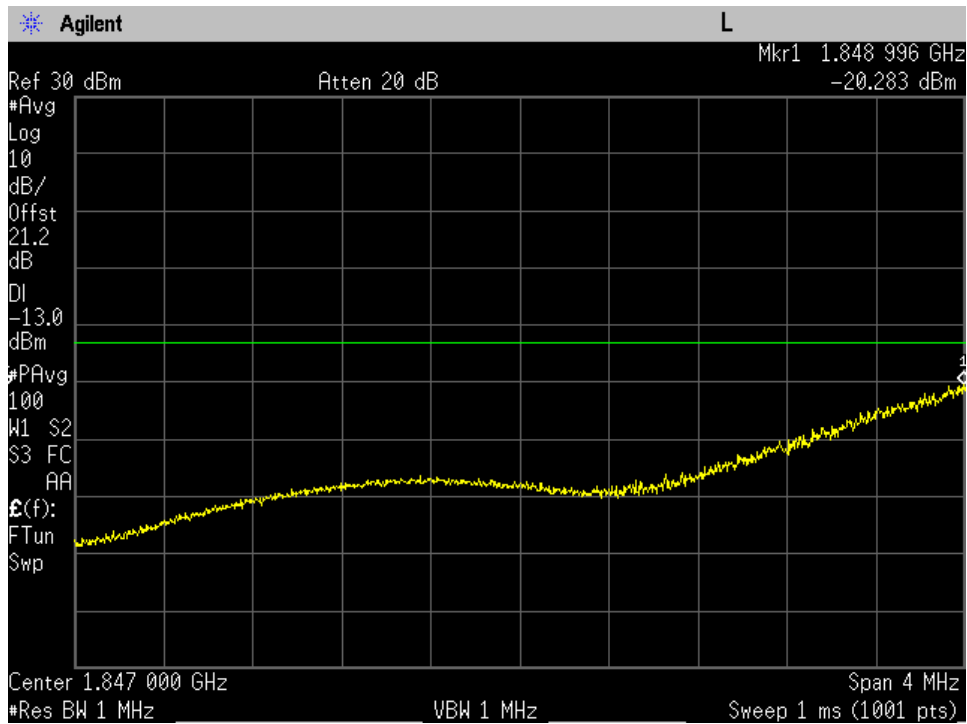

**High Channel**

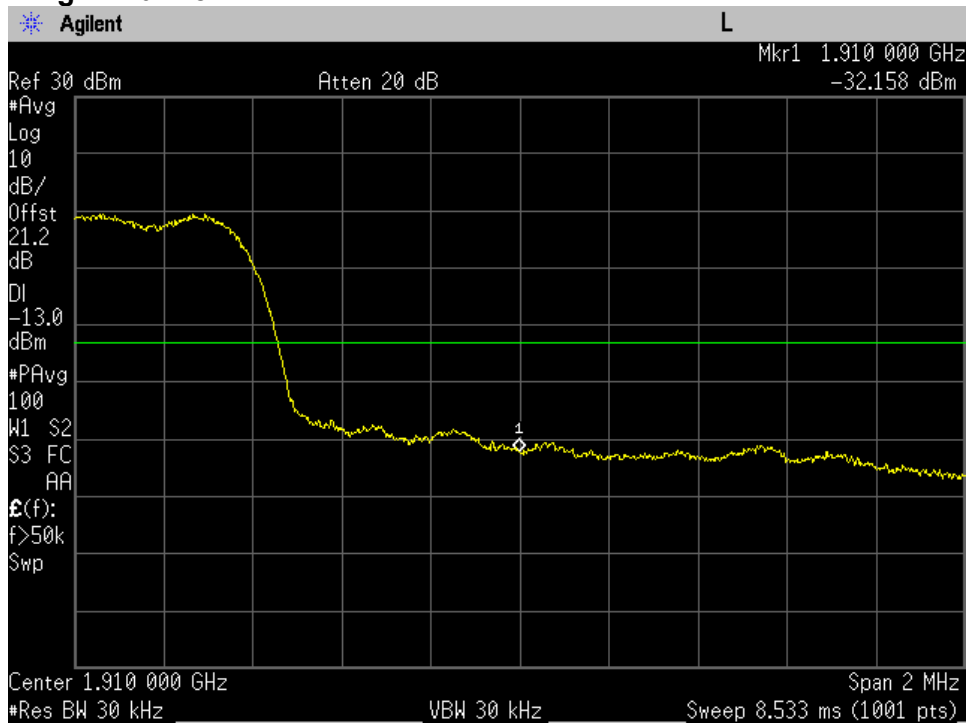

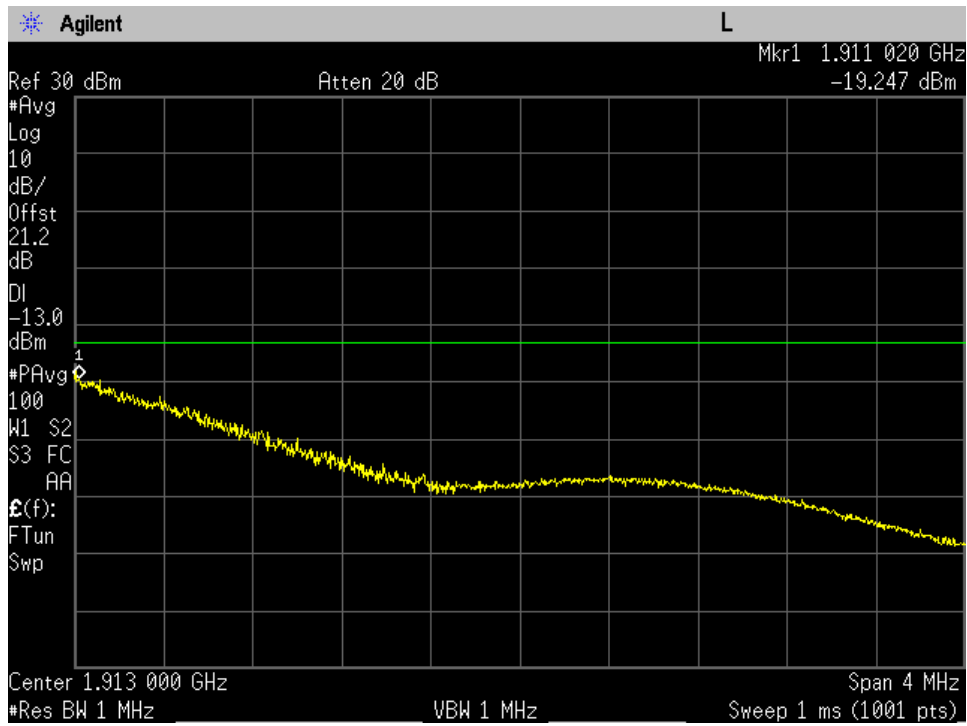

## 12. Test Equipment List

No.	Instrument	Manufacturer	Model	Serial No.	Calibration Date	Calibration Interval
1	*Test Receiver	R & S	ESCS 30	833364/020	Jan. 12 2012	1 year
2	Test Receiver	R & S	ESCS 30	100302	Oct. 12 2011	1 year
3	*Amplifier	HP	8447F	2805A03427	Jul. 16 2012	1 year
4	*Amplifier	Sonoma Instrument	310N	291916	Jul. 16 2012	1 year
5	*Amplifier	R & S	SCU-26	10011	Jun. 01 2012	1 year
6	*Pre Amplifier	HP	8449B	3008A00107	Jan. 13 2012	1 year
7	*Pre Amplifier	HP	8447F	2805A03351	Oct. 06 2011	1 year
8	*Wireless Communication Test Set	Agilent	E5515C	MY48360948	Jan. 12 2012	1 year
9	*Signal Generator	R & S	SMP02	833286/003	Jul. 16 2012	1 year
10	*Spectrum Analyzer	R & S	N9020A	MY51110087	Jul. 16 2012	1 year
11	*Spectrum Analyzer	R & S	FSP40	100361	Jul. 17 2012	1 year
12	*Loop Antenna	R & S	HFH2-Z2	100279	Feb. 21 2012	2 year
13	*Biconical Log Antenna	ARA	LPB-2520/A	1209	Dec. 21 2010	2 year
14	*Horn Antenna	SCHWARZBECK	BBHA9120D	9120D-508	Dec. 24 2010	2 year
15	*Horn Antenna	SCHWARZBECK	HF907	100197	Mar. 22 2011	2 year
16	*Horn Antenna	Q-par Angus	QSH20S20	8179	Mar. 28 2011	2 year
17	*Trilog-Broadband Antenna	SCHWARZBECK	VULB 9163	9163-454	Feb. 24 2012	2 year
18	*Trilog-Broadband Antenna	SCHWARZBECK	VULB 9168	9168-257	Apr. 26 2012	2 year
19	*Directional Coupler	HP	778D	15550	Jan. 13 2012	1 year
20	LISN	R & S	ESH3-Z5	833874/006	Oct. 12 2011	1 year
21	LISN	R & S	ESH2-Z5	100227	Apr. 04 2012	1 year
22	*Position Controller	DAEIL EMC	N/A	N/A	N/A	N/A
23	*Turn Table	DAEIL EMC	N/A	N/A	N/A	N/A
24	*Antenna Mast	DAEIL EMC	N/A	N/A	N/A	N/A
25	*Anechoic Chamber	EM Eng.	N/A	N/A	N/A	N/A
26	*Shielded Room	EM Eng.	N/A	N/A	N/A	N/A
27	*Position Controller	Seo-Young EMC	N/A	N/A	N/A	N/A
28	*Turn Table	Seo-Young EMC	N/A	N/A	N/A	N/A
29	*Antenna Mast	Seo-Young EMC	N/A	N/A	N/A	N/A
30	*Anechoic Chamber	Seo-Young EMC	N/A	N/A	N/A	N/A
31	*Shielded Room	Seo-Young EMC	N/A	N/A	N/A	N/A