







Safety Label Locations

Model 700
 12 VDC
 300 mA
 S/N: 700XXXX
 3M Library Systems
 St. Paul, Minnesota 55144

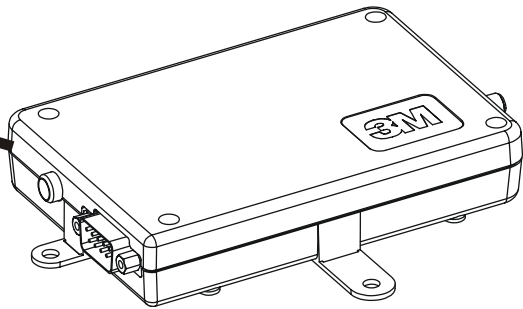





Model 770
 12 VDC
 300 mA
 3.6 W
 S/N: 770XXXX
 3M Security Systems
 St. Paul, Minnesota 55144

FCC ID: DGF-SSD770
 Canada: _____
 LTE LISTED 4P24

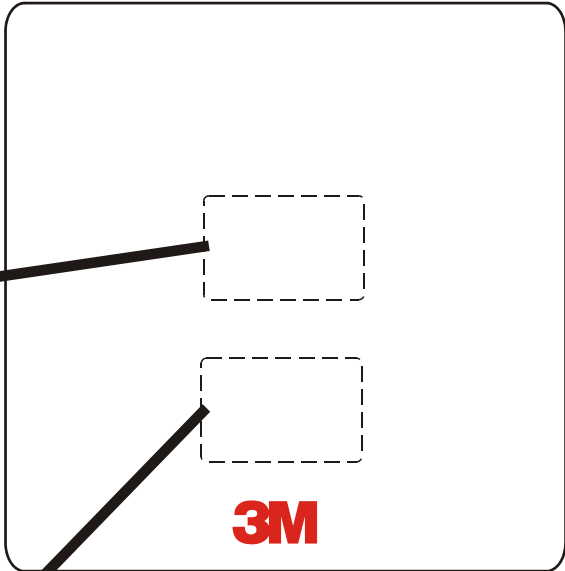

This device complies with part 15 of the FCC Rules. Operation is subject to the following two conditions:
 (1) This device may not cause harmful interference, and
 (2) This device must accept any interference received, including interference that may cause undesired operation.

This Class A digital apparatus also meets all requirements of the Canadian Interference-Causing Equipment Regulations.

Cet appareil numérique de la classe A respecte toutes les exigences du Règlement sur le matériel brouilleur du Canada.

770_OM_001