

# TEST REPORT

**Applicant:** 3M Company  
**Address:** 3M Center, Saint Paul, Minnesota United States  
55144  
**Equipment Type:** WorkTunes Connect, WorkTunes Connect with Gel  
Rings  
**Model Name:** 90570 (refer to section 2.3)  
**Brand Name:** 3M  
**FCC ID:** DGF-90570  
**Test Standard:** 47 CFR Part 15 Subpart C  
(refer to section 3.1)  
**Sample Arrival Date:** Jan. 26, 2024  
**Test Date:** Feb. 02, 2024 - Feb. 07, 2024  
**Date of Issue:** Mar. 27, 2024

**ISSUED BY:**

Shenzhen BALUN Technology Co., Ltd.

**Tested by:** Si Xiao

**Checked by:** Ye Hongji

**Approved by:** Liao Jianming  
(Technical Director)

*Si Xiao*

*Ye Hongji*

*Liao Jianming*

<b>Revision History</b>		
Version	Issue Date	Revisions
<u>Rev. 01</u>	<u>Mar. 27, 2024</u>	<u>Initial Issue</u>

## TABLE OF CONTENTS

1	GENERAL INFORMATION .....	4
1.1	Test Laboratory .....	4
1.2	Test Location .....	4
2	PRODUCT INFORMATION .....	5
2.1	Applicant Information .....	5
2.2	Manufacturer Information .....	5
2.3	General Description for Equipment under Test (EUT) .....	5
2.4	Technical Information .....	6
3	SUMMARY OF TEST RESULTS .....	7
3.1	Test Standards .....	7
3.2	Test Verdict .....	7
4	GENERAL TEST CONFIGURATIONS .....	8
4.1	Test Environments .....	8
4.2	Test Equipment List .....	8
4.3	Test Software List .....	8
4.4	Measurement Uncertainty .....	9
4.5	Description of Test Setup .....	9
4.6	Measurement Results Explanation Example .....	12
5	TEST ITEMS .....	13
5.1	Antenna Requirements .....	13
5.2	Output Power .....	14
5.3	Occupied Bandwidth .....	16
5.4	Conducted Spurious Emission .....	17
5.5	Band Edge (Authorized-band band-edge) .....	19

5.6	Conducted Emission .....	21
5.7	Radiated Spurious Emission .....	22
5.8	Band Edge (Restricted-band band-edge).....	27
5.9	Power Spectral density (PSD).....	28
ANNEX A	TEST RESULT .....	29
A.1	Output Power, Duty Cycle .....	29
A.2	Occupied Bandwidth .....	31
A.3	Conducted Spurious Emissions .....	33
A.4	Band Edge (Authorized-band band-edge).....	36
A.5	Conducted Emissions.....	37
A.6	Radiated Spurious Emission .....	39
A.7	Band Edge (Restricted-band band-edge).....	47
A.8	Power Spectral Density (PSD) .....	49
ANNEX B	TEST SETUP PHOTOS .....	50
ANNEX C	EUT EXTERNAL PHOTOS .....	50
ANNEX D	EUT INTERNAL PHOTOS .....	50

# 1 GENERAL INFORMATION

## 1.1 Test Laboratory

Name	Shenzhen BALUN Technology Co., Ltd.
Address	Block B, 1/F, Baisha Science and Technology Park, Shahe Xi Road, Nanshan District, Shenzhen, Guangdong Province, P. R. China
Phone Number	+86 755 6685 0100

## 1.2 Test Location

Name	Shenzhen BALUN Technology Co., Ltd.
Location	<input checked="" type="checkbox"/> Block B, 1/F, Baisha Science and Technology Park, Shahe Xi Road, Nanshan District, Shenzhen, Guangdong Province, P. R. China
	<input type="checkbox"/> 1/F, Building B, Ganghongji High-tech Intelligent Industrial Park, No. 1008, Songbai Road, Yangguang Community, Xili Sub-district, Nanshan District, Shenzhen, Guangdong Province, P. R. China
Accreditation Certificate	The laboratory is a testing organization accredited by FCC as a accredited testing laboratory. The designation number is CN1196.

## 2 PRODUCT INFORMATION

### 2.1 Applicant Information

Applicant	3M Company
Address	3M Center, Saint Paul, Minnesota United States 55144

### 2.2 Manufacturer Information

Manufacturer	3M Company
Address	3M Center, Saint Paul, Minnesota United States 55144

### 2.3 General Description for Equipment under Test (EUT)

EUT Name	WorkTunes Connect, WorkTunes Connect with Gel Rings
Model Name Under Test	90570
Series Model Name	90571
Description of Model name differentiation	All models are same with electrical parameters and internal circuit structure, but only differ in appearance and model name. (this information provided by the applicant)
Hardware Version	R2.0
Software Version	0.13.0
Dimensions (Approx.)	N/A
Weight (Approx.)	N/A

## 2.4 Technical Information

Network and Wireless connectivity	Bluetooth (BR+EDR+BLE)
-----------------------------------	------------------------

The requirement for the following technical information of the EUT was tested in this report:

Modulation Technology	DSSS
Modulation Type	GFSK
Product Type	<input type="checkbox"/> Mobile <input checked="" type="checkbox"/> Portable <input type="checkbox"/> Fix Location
Transfer Rate	1 Mbps
Frequency Range	The frequency range used is 2400 MHz to 2483.5 MHz.
Number of Channel	40 (at intervals of 2 MHz)
Tested Channel	1 Mbps: 0 (2402 MHz), 19 (2440 MHz), 39 (2480 MHz)
Antenna Type	PCB Antenna
Antenna Gain	0 dBi
Antenna Impedance	50Ω
Antenna System (MIMO Smart Antenna)	N/A

### 3 SUMMARY OF TEST RESULTS

#### 3.1 Test Standards

No.	Identity	Document Title
1	47 CFR Part 15, Subpart C	Intentional radiators of radio frequency equipment
2	ANSI C63.10-2013	American National Standard for Testing Unlicensed Wireless Devices
3	KDB 558074 D01 15.247 Meas Guidance v05r02	Guidance for compliance measurements on digital transmission system, frequency hopping spread spectrum system, and hybrid system devices operating under section 15.247 of the FCC rules

#### 3.2 Test Verdict

No.	Description	FCC Part No.	Channel	Test Result	Verdict
1	Antenna Requirement	15.203	N/A	--	Pass <sup>Note1</sup>
2	Output Power	15.247(b)	Low/Middle/High	ANNEX A.1	Pass
3	Occupied Bandwidth	15.247(a)	Low/Middle/High	ANNEX A.2	Pass
4	Conducted Spurious Emission	15.247(d)	Low/Middle/High	ANNEX A.3	Pass
5	Band Edge(Authorized-band band-edge)	15.247(d)	Low/High	ANNEX A.4	Pass
6	Conducted Emission	15.207	Low/Middle/High	ANNEX A.5	Pass
7	Radiated Spurious Emission	15.209 15.247(d)	Low/Middle/High	ANNEX A.6	Pass
8	Band Edge(Restricted-band band-edge)	15.209 15.247(d)	Low/High	ANNEX A.7	Pass
9	Power spectral density (PSD)	15.247(e)	Low/Middle/High	ANNEX A.8	Pass

Note: The EUT has a permanently and irreplaceable attached antenna, which complies with the requirement FCC 15.203.

## 4 GENERAL TEST CONFIGURATIONS

### 4.1 Test Environments

During the measurement, the normal environmental conditions were within the listed ranges:

Relative Humidity	51% to 64%	
Atmospheric Pressure	100 kPa to 102 kPa	
Temperature	NT (Normal Temperature)	+19.1°C to +24.3°C
Working Voltage of the EUT	NV (Normal Voltage)	3.7 V

### 4.2 Test Equipment List

Description	Manufacturer	Model	Serial No.	Cal. Date	Cal. Due
Spectrum Analyzer	KEYSIGHT	N9020A	MY50330200	2023.05.16	2024.05.15
Spectrum Analyzer	KEYSIGHT	N9020A	MY50531259	2023.09.05	2024.09.04
Signaling Unit	ROHDE&SCHWARZ	CMW500	171150	2023.06.19	2024.06.18
Test Antenna-Horn	SCHWARZBECK	BBHA 9120D	02460	2021.05.20	2024.05.19
Test Antenna-Horn	A-INFO	LB-180400KF	J211060273	2021.07.02	2024.07.01
Anechoic Chamber	RAINFORD	9m*6m*6m	140	2022.02.19	2024.08.15
Amplifier	COM-MV	LSCX_LNA1-12G-01	7210214	2023.09.05	2024.09.04
Amplifier	COM-MV	XKu_LNA7-18G-01	7210209	2023.09.05	2024.09.04
EMI Receiver	ROHDE&SCHWARZ	ESRP	101036	2023.09.05	2024.09.04
Test Antenna-Bi-Log	SCHWARZBECK	VULB 9168	9168-01162	2023.08.04	2024.08.03
Test Antenna-Loop	SCHWARZBECK	FMZB 1519	1519-037	2021.04.16	2024.04.15
Amplifier	COM-MV	ZT30-1000M	B2018054558	2023.12.05	2024.12.04
Anechoic Chamber	EMC Electronic Co., Ltd	20.10*11.60*7.35m	130	2021.08.15	2024.08.14
EMI Receiver	KEYSIGHT	N9010B	MY57110309	2023.09.05	2024.09.04
LISN	SCHWARZBECK	NSLK 8127	8127-687	2023.05.16	2024.05.15
Shielded Enclosure	YiHeng Electronic Co., Ltd	3.5m*3.1m*2.8m	112	2022.02.19	2025.02.18

### 4.3 Test Software List

Description	Manufacturer	Software Version	Serial No.	Applicable test Setup
BL410R	BALUN	V2.1.1.488	N/A	The section 4.5.1
BL410E	BALUN	V22.930	N/A	The section 4.5.2&4.5.3&4.5.4&4.5.5



### 4.4 Measurement Uncertainty

The following measurement uncertainty levels have been estimated for tests performed on the EUT as specified in CISPR 16-4-2.

This uncertainty represents an expanded uncertainty expressed at approximately the 95% confidence level using a coverage factor of k=2.

Parameters	Uncertainty
Occupied Channel Bandwidth	2.8%
RF output power, conducted	1.28 dB
Power Spectral Density, conducted	1.30 dB
Unwanted Emissions, conducted	1.84 dB
All emissions, radiated	5.36 dB
Temperature	0.8°C
Humidity	4%

### 4.5 Description of Test Setup

#### 4.5.1 For Antenna Port Test

$$\text{Conducted value (dBm)} = \text{Measurement value (dBm)} + \text{cable loss (dB)}$$

For example: the measurement value is 10 dBm and the cable 0.5dBm used, then the final result of EUT:

$$\text{Conducted value (dBm)} = 10 \text{ dBm} + 0.5 \text{ dB} = 10.5 \text{ dBm}$$

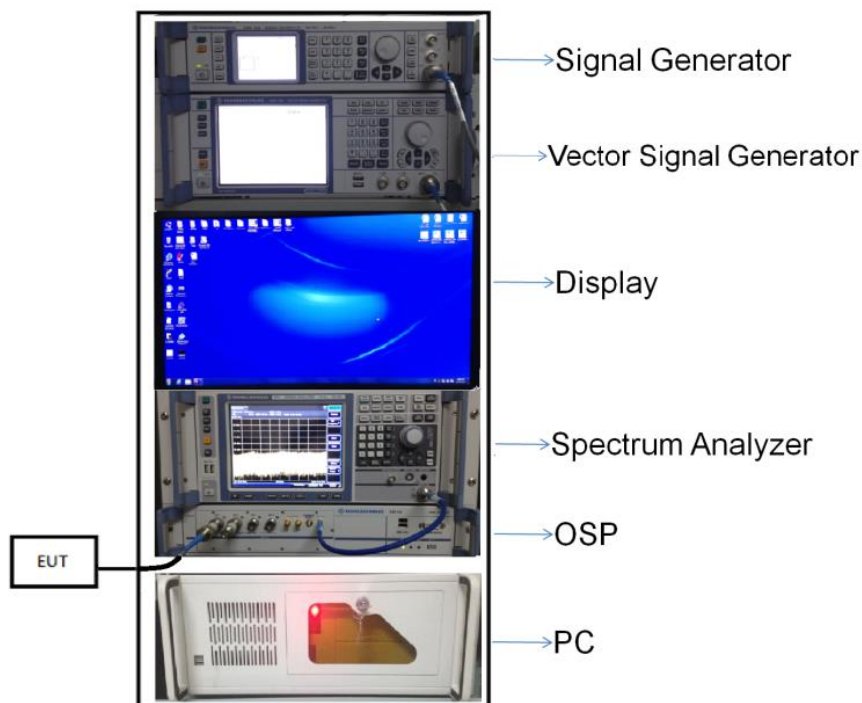

(Diagram 1)

4.5.2 For AC Power Supply Port Test

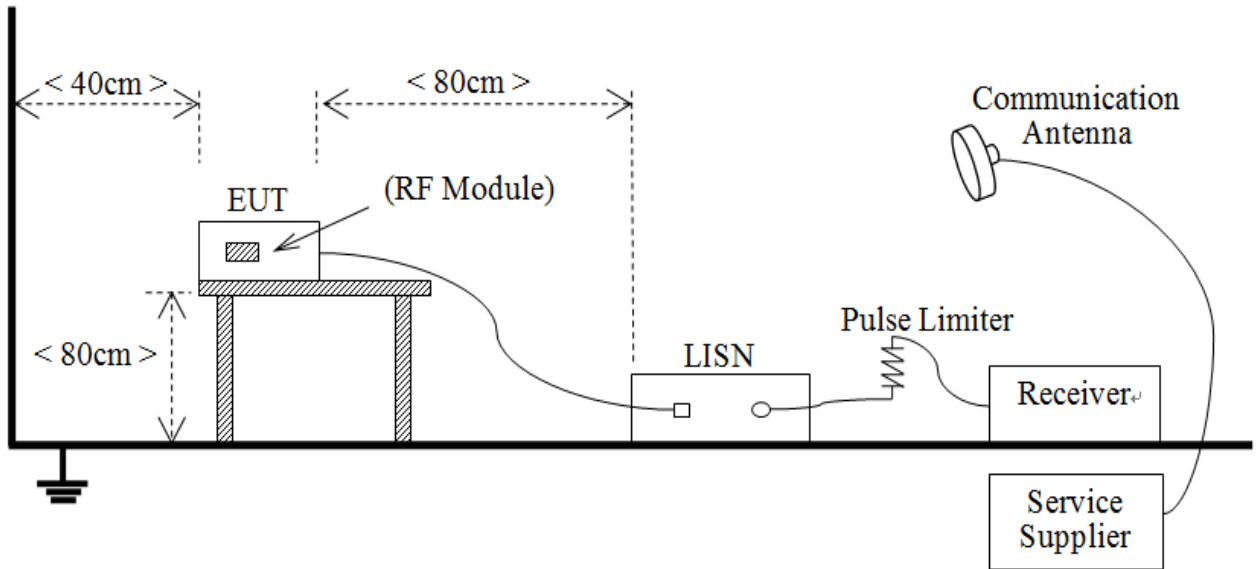

(Diagram 2)

4.5.3 For Radiated Test (Below 30 MHz)

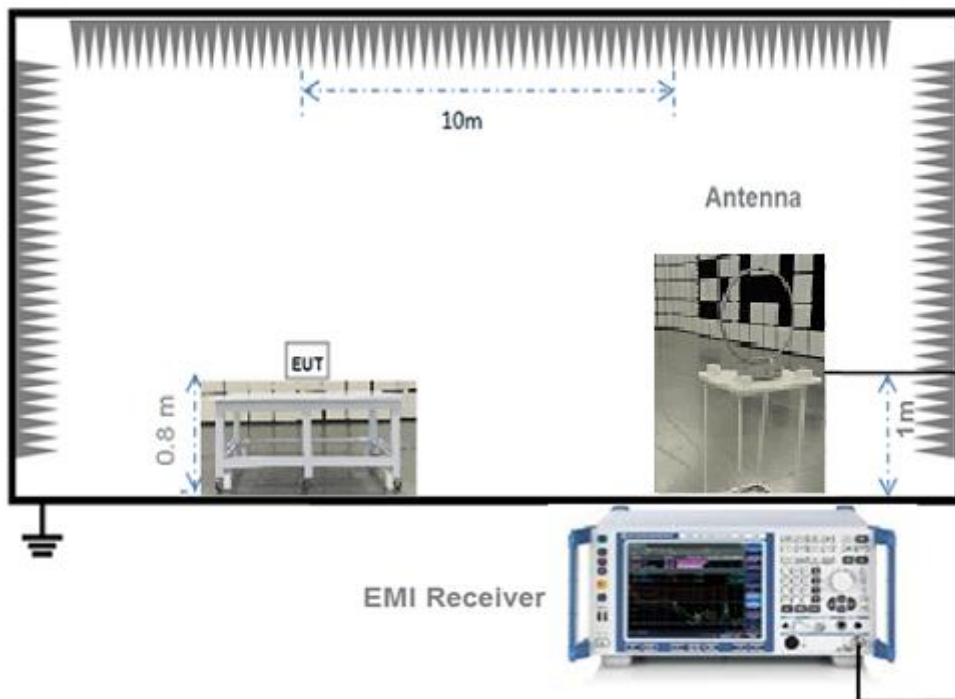

(Diagram 3)

#### 4.5.4 For Radiated Test (30 MHz-1 GHz)

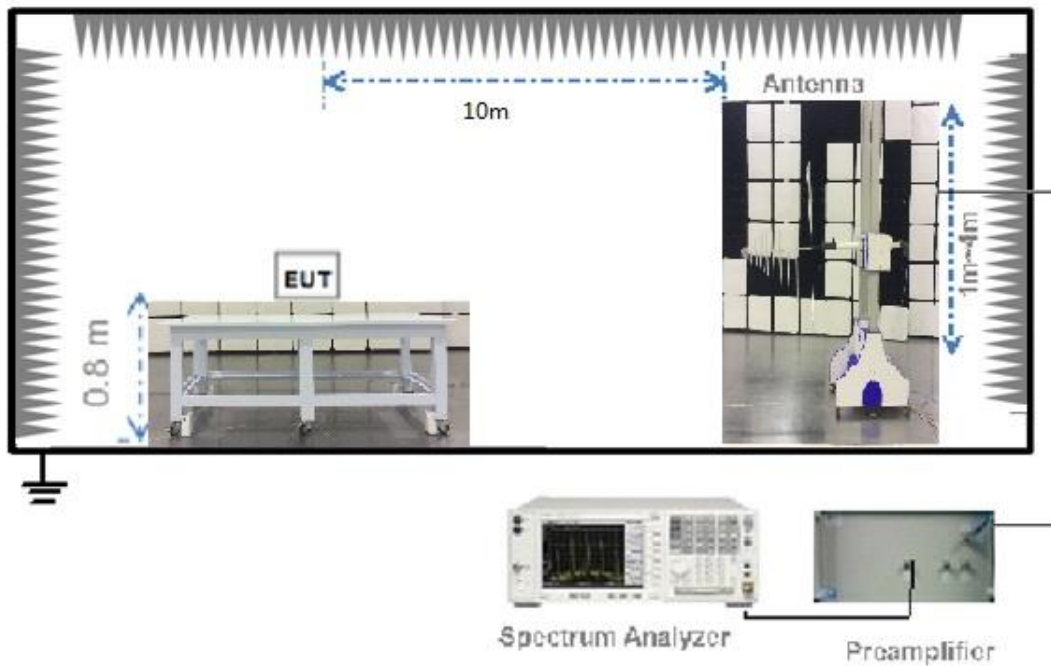

(Diagram 4)

#### 4.5.5 For Radiated Test (Above 1 GHz)

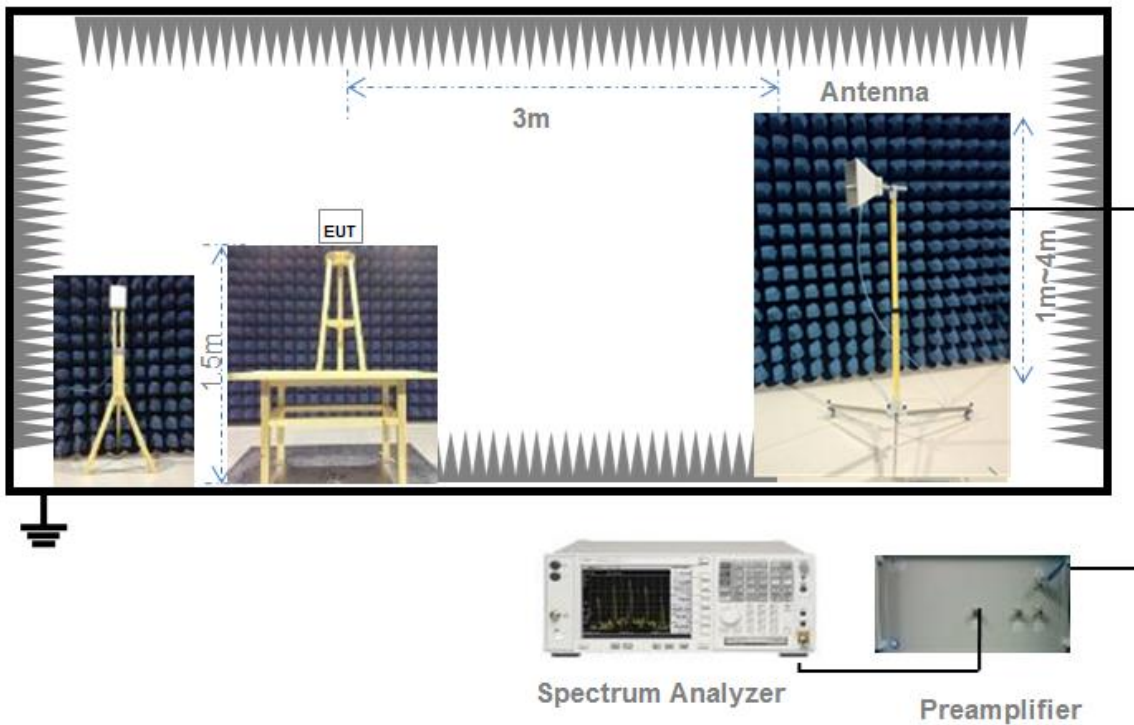

(Diagram 5)

## 4.6 Measurement Results Explanation Example

### 4.6.1 For conducted test items:

The offset level is set in the spectrum analyzer to compensate the RF cable loss and attenuator between EUT conducted output port and spectrum analyzer. With the offset compensation, the spectrum analyzer reading level is exactly the EUT RF output level.

The spectrum analyzer offset is derived from RF cable loss and attenuator factor.

Offset = RF cable loss + attenuator factor.

### 4.6.2 For radiated band edges and spurious emission test:

$$E = \text{EIRP} - 20 \log D + 104.8$$

where:

E = electric field strength in dB $\mu$ V/m,

EIRP = equivalent isotropic radiated power in dBm

D = specified measurement distance in meters.

## 5 TEST ITEMS

### 5.1 Antenna Requirements

#### 5.1.1 Relevant Standards

FCC §15.203 & 15.247(b)

An intentional radiator shall be designed to ensure that no antenna other than that furnished by the responsible party shall be used with the device. The use of a permanently attached antenna or of an antenna that uses a unique coupling to the intentional radiator shall be considered sufficient to comply with the provisions of this section. The manufacturer may design the unit so that a broken antenna can be replaced by the user, but the use of a standard antenna jack or electrical connector is prohibited. This requirement does not apply to carrier current devices or to devices operated under the provisions of § 15.211, § 15.213, § 15.217, § 15.219, or § 15.221. Further, this requirement does not apply to intentional radiators that must be professionally installed, such as perimeter protection systems and some field disturbance sensors, or to other intentional radiators which, in accordance with § 15.31(d), must be measured at the installation site. However, the installer shall be responsible for ensuring that the proper antenna is employed so that the limits in this part are not exceeded.

If directional gain of transmitting antennas is greater than 6 dBi, the power shall be reduced by the same level in dB comparing to gain minus 6 dBi. For the fixed point-to-point operation, the power shall be reduced by one dB for every 3 dB that the directional gain of the antenna exceeds 6 dBi. The use of a permanently attached antenna or of an antenna that uses a unique coupling to the intentional radiator shall be considered sufficient to comply with the FCC rule.

#### 5.1.2 Antenna Anti-Replacement Construction

The Antenna Anti-Replacement as following method:

Protected Method	Description
The antenna is embedded in the product.	An embedded-in antenna design is used.

Reference Documents	Item
Photo	Please refer to the EUT Photo documents.

#### 5.1.3 Antenna Gain

The antenna peak gain of EUT is less than 6 dBi. Therefore, it is not necessary to reduce maximum peak output power limit.

## 5.2 Output Power

### 5.2.1 Test Limit

#### FCC § 15.247(b)

For systems using digital modulation in the 902-928 MHz, 2400-2483.5 MHz, and 5725-5850 MHz bands: 1 Watt. As an alternative to a peak power measurement, compliance with the one Watt limit can be based on a measurement of the maximum conducted output power. Maximum Conducted Output Power is defined as the total transmit power delivered to all antennas and antenna elements averaged across all symbols in the signaling alphabet when the transmitter is operating at its maximum power control level. Power must be summed across all antennas and antenna elements.

### 5.2.2 Test Setup

See section 4.5.1 for test setup description for the antenna port. The photo of test setup please refer to ANNEX B.

### 5.2.3 Test Procedure

#### a) Maximum peak conducted output power

This procedure shall be used when the measurement instrument has available a resolution bandwidth that is greater than the DTS bandwidth.

Set the  $RBW \geq DTS$  bandwidth.

Set  $VBW \geq 3 \times RBW$ .

Set span  $\geq 3 \times RBW$

Sweep time = auto couple.

Detector = peak.

Trace mode = max hold.

Allow trace to fully stabilize.

Use peak marker function to determine the peak amplitude level.

#### b) Measurements of duty cycle

The zero-span mode on a spectrum analyzer or EMI receiver if the response time and spacing between bins on the sweep are sufficient to permit accurate measurements of the on and off times of the transmitted signal.

Set the center frequency of the instrument to the center frequency of the transmission.

Set  $RBW \geq OBW$  if possible; otherwise, set RBW to the largest available value.

Set  $VBW \geq RBW$ . Set detector = peak or average.

The zero-span measurement method shall not be used unless both RBW and VBW are  $> 50/T$  and the number of sweep points across duration T exceeds 100. (For example, if VBW and/or RBW are limited to 3 MHz, then the zero-span method of measuring duty cycle shall not be used if  $T \leq 16.7$  microseconds.)

## 5.2.4 Test Result

Please refer to ANNEX A.1.

## 5.3 Occupied Bandwidth

### 5.3.1 Limit

FCC §15.247(a)

Make the measurement with the spectrum analyzer's resolution bandwidth (RBW) = 100 kHz. In order to make an accurate measurement, set the span greater than RBW. The 6 dB bandwidth must be greater than 500 kHz.

### 5.3.2 Test Setup

See section 4.5.1 for test setup description for the antenna port. The photo of test setup please refer to ANNEX B.

### 5.3.3 Test Procedure

Use the following spectrum analyzer settings:

Set RBW = 100 kHz.

Set the video bandwidth (VBW)  $\geq 3$  RBW.

Detector = Peak.

Trace mode = max hold.

Sweep = auto couple.

Allow the trace to stabilize.

Measure the maximum width of the emission that is constrained by the frequencies associated with the two outermost amplitude points (upper and lower frequencies) that are attenuated by 6 dB relative to the maximum level measured in the fundamental emission.

### 5.3.4 Test Result

Please refer to ANNEX A.2.



## 5.4 Conducted Spurious Emission

### 5.4.1 Limit

FCC §15.247(d)

In any 100 kHz bandwidth outside the frequency band in which the spread spectrum or digitally modulated intentional radiator is operating, the radio frequency power that is produced by the intentional radiator shall be at least 20 dB below that in the 100 kHz bandwidth within the band that contains the highest level of the desired power, based on either an RF conducted or a radiated measurement.

### 5.4.2 Test Setup

See section 4.5.1 for test setup description for the antenna port. The photo of test setup please refer to ANNEX B.

### 5.4.3 Test Procedure

The DTS rules specify that in any 100 kHz bandwidth outside of the authorized frequency band, the power shall be attenuated according to the following conditions:

- a) If the maximum peak conducted output power procedure was used to demonstrate compliance as described in 9.1, then the peak output power measured in any 100 kHz bandwidth outside of the authorized frequency band shall be attenuated by at least 20 dB relative to the maximum in-band peak PSD level in 100 kHz (i.e., 20 dBc).
- b) If maximum conducted (average) output power was used to demonstrate compliance as described in 9.2, then the peak power in any 100 kHz bandwidth outside of the authorized frequency band shall be attenuated by at least 30 dB relative to the maximum in-band peak PSD level in 100 kHz (i.e., 30 dBc).
- c) In either case, attenuation to levels below the 15.209 general radiated emissions limits is not required.

The following procedures shall be used to demonstrate compliance to these limits. Note that these procedures can be used in either an antenna-port conducted or radiated test set-up. Radiated tests must conform to the test site requirements and utilize maximization procedures defined herein.

Reference level measurement:

Establish a reference level by using the following procedure:

Set instrument center frequency to DTS channel center frequency.

Set the span to  $\geq 1.5$  times the DTS bandwidth.

Set the RBW = 100 kHz.

Set the VBW  $\geq 3 \times$  RBW.

Detector = peak.

Sweep time = auto couple.

Trace mode = max hold.

Allow trace to fully stabilize.

Use the peak marker function to determine the maximum PSD level.

Emission level measurement:

Use the following spectrum analyzer settings:

Span = wide enough to capture the peak level of the in-band emission and all spurious emissions (e.g., harmonics) from the lowest frequency generated in the EUT up through the 10th harmonic. Typically, several plots are required to cover this entire span.

Set the RBW = 100 kHz.

Set the VBW  $\geq 3 \times$  RBW.

Detector = peak.

Sweep time = auto couple.

Trace mode = max hold.

Allow trace to fully stabilize.

Use the peak marker function to determine the maximum amplitude level.

Ensure that the amplitude of all unwanted emissions outside of the authorized frequency band (excluding restricted frequency bands) are attenuated by at least the minimum requirements specified in 11.1 a) or 11.1 b). Report the three highest emissions relative to the limit.

#### 5.4.4 Test Result

Please refer to ANNEX A.3.

## 5.5 Band Edge (Authorized-band band-edge)

### 5.5.1 Limit

#### FCC §15.247(d)

In any 100 kHz bandwidth outside the frequency band in which the spread spectrum or digitally modulated intentional radiator is operating, the radio frequency power that is produced by the intentional radiator shall be at least 20 dB below that in the 100 kHz bandwidth within the band that contains the highest level of the desired power, based on either an RF conducted or a radiated measurement.

### 5.5.2 Test Setup

See section 4.5.1 for test setup description for the antenna port. The photo of test setup please refer to ANNEX B.

### 5.5.3 Test Procedure

The following procedures may be used to determine the peak or average field strength or power of an unwanted emission that is within 2 MHz of the authorized band edge. If a peak detector is utilized, use the procedure described in 13.2.1. Use the procedure described in 13.2.2 when using an average detector and the EUT can be configured to transmit continuously (i.e., duty cycle  $\geq 98\%$ ). Use the procedure described in 13.2.3 when using an average detector and the EUT cannot be configured to transmit continuously but the duty cycle is constant (i.e., duty cycle variations are less than  $\pm 2$  percent). Use the procedure described in 13.2.4 when using an average detector for those cases where the EUT cannot be configured to transmit continuously and the duty cycle is not constant (duty cycle variations equal or exceed 2 percent).

When using a peak detector to measure unwanted emissions at or near the band edge (within 2 MHz of the authorized band), the following integration procedure can be used.

Set instrument center frequency to the frequency of the emission to be measured (must be within 2 MHz of the authorized band edge).

Set span to 2 MHz

RBW = 100 kHz.

VBW  $\geq 3 \times$  RBW.

Detector = peak.

Sweep time = auto.

Trace mode = max hold.

Allow sweep to continue until the trace stabilizes (required measurement time may increase for low duty cycle applications)

Compute the power by integrating the spectrum over 1 MHz using the analyzer's band power measurement function with band limits set equal to the emission frequency (femission)  $\pm 0.5$  MHz. If the instrument does not have a band power function, then sum the amplitude levels (in power units) at 100 kHz intervals extending across the 1 MHz spectrum defined by femission  $\pm 0.5$  MHz.

#### 5.5.4 Test Result

Please refer to ANNEX A.4.

## 5.6 Conducted Emission

### 5.6.1 Limit

FCC §15.207

For an intentional radiator that is designed to be connected to the public utility (AC) power line, the radio frequency voltage that is conducted back onto the AC power line on any frequency within the band 150 kHz to 30 MHz shall not exceed the limits in the following table, as measured using a 50 $\mu$ H/50 $\Omega$  line impedance stabilization network (LISN).

Frequency range (MHz)	Conducted Limit (dB $\mu$ V)	
	Quai-peak	Average
0.15 - 0.50	66 to 56	56 to 46
0.50 - 5	56	46
0.50 - 30	60	50

### 5.6.2 Test Setup

See section 4.5.2 for test setup description for the AC power supply port. The photo of test setup please refer to ANNEX B.

### 5.6.3 Test Procedure

The maximum conducted interference is searched using Peak (PK), if the emission levels more than the AV and QP limits, and that have narrow margins from the AV and QP limits will be re-measured with AV and QP detectors. Tests for both L phase and N phase lines of the power mains connected to the EUT are performed. Refer to recorded points and plots below.

Devices subject to Part 15 must be tested for all available U.S. voltages and frequencies (such as a nominal 120 VAC, 50/60 Hz and 240 VAC, 50/60 Hz) for which the device is capable of operation. A device rated for 50/60 Hz operation need not be tested at both frequencies provided the radiated and line conducted emissions are the same at both frequencies.

### 5.6.4 Test Result

Please refer to ANNEX A.5.

## 5.7 Radiated Spurious Emission

### 5.7.1 Limit

FCC §15.209&15.247(d)

Radiated emission outside the frequency band attenuation below the general limits specified in FCC section 15.209(a) is not required. In addition, radiated emissions which fall in the restricted bands, as defined in FCC section 15.205(a), must also comply with the radiated emission limits specified in FCC section 15.209(a).

According to FCC section 15.209 (a), except as provided elsewhere in this subpart, the emissions from an intentional radiator shall not exceed the field strength levels specified in the following table:

Frequency (MHz)	Field Strength ( $\mu\text{V}/\text{m}$ )	Measurement Distance (m)
0.009 - 0.490	2400/F(kHz)	300
0.490 - 1.705	24000/F(kHz)	30
1.705 - 30.0	30	30
30 - 88	100	3
88 - 216	150	3
216 - 960	200	3
Above 960	500	3

Note:

1. Field Strength (dB $\mu\text{V}/\text{m}$ ) = 20\*log[Field Strength ( $\mu\text{V}/\text{m}$ )].
2. In the emission tables above, the tighter limit applies at the band edges.
3. For Above 1000 MHz, the emission limit in this paragraph is based on measurement instrumentation employing an average detector, measurement using instrumentation with a peak detector function, corresponding to 20dB above the maximum permitted average limit.
4. For above 1000 MHz, limit field strength of harmonics: 54dBuV/m@3m (AV) and 74dBuV/m@3m (PK).

### 5.7.2 Test Setup

See section 4.5.3 to 4.5.5 for test setup description for the antenna port. The photo of test setup please refer to ANNEX B.

### 5.7.3 Test Procedure

Since the emission limits are specified in terms of radiated field strength levels, measurements performed to demonstrate compliance have traditionally relied on a radiated test configuration. Radiated measurements remain the principal method for demonstrating compliance to the specified limits; however antenna-port conducted measurements are also now acceptable to demonstrate compliance (see below for details). When radiated measurements are utilized, test site requirements and procedures for maximizing and measuring radiated emissions that are described in ANSI C63.10 shall be followed.

Antenna-port conducted measurements may also be used as an alternative to radiated measurements

for demonstrating compliance in the restricted frequency bands. If conducted measurements are performed, then proper impedance matching must be ensured and an additional radiated test for cabinet/case spurious emissions is required.

General Procedure for conducted measurements in restricted bands:

- a) Measure the conducted output power (in dBm) using the detector specified (see guidance regarding measurement procedures for determining quasi-peak, peak, and average conducted output power, respectively).
- b) Add the maximum transmit antenna gain (in dBi) to the measured output power level to determine the EIRP level (see guidance on determining the applicable antenna gain)
- c) Add the appropriate maximum ground reflection factor to the EIRP level (6 dB for frequencies  $\leq$  30 MHz, 4.7 dB for frequencies between 30 MHz and 1000 MHz, inclusive and 0 dB for frequencies  $>$  1000 MHz).
- d) For devices with multiple antenna-ports, measure the power of each individual chain and sum the EIRP of all chains in linear terms (e.g., Watts, mW).
- e) Convert the resultant EIRP level to an equivalent electric field strength using the following relationship:

$$E = \text{EIRP} - 20\log D + 104.8$$

where:

E = electric field strength in dB $\mu$ V/m,

EIRP = equivalent isotropic radiated power in dBm

D = specified measurement distance in meters.

- f) Compare the resultant electric field strength level to the applicable limit.
- g) Perform radiated spurious emission test.

#### Quasi-Peak measurement procedure

The specifications for measurements using the CISPR quasi-peak detector can be found in Publication 16 of the International Special Committee on Radio Frequency Interference (CISPR) of the International Electrotechnical Commission.

As an alternative to CISPR quasi-peak measurement, compliance can be demonstrated to the applicable emission limits using a peak detector.

Peak power measurement procedure:

Peak emission levels are measured by setting the instrument as follows:

- a) RBW = as specified in Table 1.
- b) VBW  $\geq$  3 x RBW.

- c) Detector = Peak.
- d) Sweep time = auto.
- e) Trace mode = max hold.
- f) Allow sweeps to continue until the trace stabilizes. (Note that the required measurement time may be longer for low duty cycle applications).

Table 1—RBW as a function of frequency

Frequency	RBW
9-150 kHz	200-300 Hz
0.15-30 MHz	9-10 kHz
30-1000 MHz	100-120 kHz
> 1000 MHz	1 MHz

If the peak-detected amplitude can be shown to comply with the average limit, then it is not necessary to perform a separate average measurement.

Trace averaging across on and off times of the EUT transmissions followed by duty cycle correction:

If continuous transmission of the EUT (i.e., duty cycle  $\geq 98$  percent) cannot be achieved and the duty cycle is constant (i.e., duty cycle variations are less than  $\pm 2$  percent), then the following procedure shall be used:

- a) The EUT shall be configured to operate at the maximum achievable duty cycle.
- b) Measure the duty cycle,  $x$ , of the transmitter output signal as described in section 6.0.
- c) RBW = 1 MHz (unless otherwise specified).
- d) VBW  $\geq 3 \times$  RBW.
- e) Detector = RMS, if  $\text{span}/(\# \text{ of points in sweep}) \leq (\text{RBW}/2)$ . Satisfying this condition may require increasing the number of points in the sweep or reducing the span. If this condition cannot be satisfied, then the detector mode shall be set to peak.
- f) Averaging type = power (i.e., RMS).
  - 1) As an alternative, the detector and averaging type may be set for linear voltage averaging.
  - 2) Some instruments require linear display mode in order to use linear voltage averaging. Log or dB averaging shall not be used.
- g) Sweep time = auto.
- h) Perform a trace average of at least 100 traces.
- i) A correction factor shall be added to the measurement results prior to comparing to the emission limit in order to compute the emission level that would have been measured had the test been performed at 100 percent duty cycle. The correction factor is computed as follows:



- 1) If power averaging (RMS) mode was used in step f), then the applicable correction factor is  $10 \log(1/x)$ , where  $x$  is the duty cycle.
- 2) If linear voltage averaging mode was used in step f), then the applicable correction factor is  $20 \log(1/x)$ , where  $x$  is the duty cycle.
- 3) If a specific emission is demonstrated to be continuous ( $\geq 98$  percent duty cycle) rather than turning on and off with the transmit cycle, then no duty cycle correction is required for that emission.

NOTE: Reduction of the measured emission amplitude levels to account for operational duty factor is not permitted. Compliance is based on emission levels occurring during transmission - not on an average across on and off times of the transmitter.

Determining the applicable transmit antenna gain:

A conducted power measurement will determine the maximum output power associated with a restricted band emission; however, in order to determine the associated EIRP level, the gain of the transmitting antenna (in dBi) must be added to the measured output power (in dBm).

Since the out-of-band characteristics of the EUT transmit antenna will often be unknown, the use of a conservative antenna gain value is necessary. Thus, when determining the EIRP based on the measured conducted power, the upper bound on antenna gain for a device with a single RF output shall be selected as the maximum in-band gain of the antenna across all operating bands, or 2 dBi, whichever is greater. However, for devices that operate in multiple frequency bands while using the same transmit antenna, the highest gain of the antenna within the operating band nearest in frequency to the restricted band emission being measured may be used in lieu of the overall highest gain when the emission is at a frequency that is within 20 percent of the nearest band edge frequency, but in no case shall a value less than 2 dBi be used.

See KDB 662911 for guidance on calculating the additional array gain term when determining the effective antenna gain for a EUT with multiple outputs occupying the same or overlapping frequency ranges in the same band.

Radiated spurious emission test:

An additional consideration when performing conducted measurements of restricted band emissions is that unwanted emissions radiating from the EUT cabinet, control circuits, power leads, or intermediate circuit elements will likely go undetected in a conducted measurement configuration. To address this concern, a radiated test shall be performed to ensure that emissions emanating from the EUT cabinet (rather than the antenna port) also comply with the applicable limits.

For these cabinet radiated spurious emission measurements the EUT transmit antenna may be replaced with a termination matching the nominal impedance of the antenna. Procedures for performing radiated measurements are specified in ANSI C63.10. All detected emissions shall comply with the applicable limits.

The measurement frequency range is from 30MHz to the 10th harmonic of the fundamental frequency. The Turn Table is actuated to turn from  $0^\circ$  to  $360^\circ$ , and both horizontal and vertical polarizations of the

Test Antenna are used to find the maximum radiated power. Mid channels on all channel bandwidth verified. Only the worst RB size/offset presented.

The power of the EUT transmitting frequency should be ignored.

All Spurious Emission tests were performed in X, Y, Z axis direction. And only the worst axis test condition was recorded in this test report.

Use the following spectrum analyzer settings:

Span = wide enough to fully capture the emission being measured

RBW = 1 MHz for  $f \geq 1$  GHz, 100 kHz for  $f < 1$  GHz

VBW  $\geq$  RBW

Sweep = auto

Detector function = peak

Trace = max hold

#### 5.7.4 Test Result

Please refer to ANNEX A.6.

## 5.8 Band Edge (Restricted-band band-edge)

### 5.8.1 Limit

FCC §15.209&15.247(d)

Radiated emission outside the frequency band attenuation below the general limits specified in FCC section 15.209(a) is not required. In addition, radiated emissions which fall in the restricted bands, as defined in FCC section 15.205(a), must also comply with the radiated emission limits specified in FCC section 15.209(a).

### 5.8.2 Test Setup

See section 4.5.3 to 4.5.5 for test setup description for the antenna port. The photo of test setup please refer to ANNEX B.

### 5.8.3 Test Procedure

The measurement frequency range is from 9 kHz to the 10th harmonic of the fundamental frequency. The Turn Table is actuated to turn from 0° to 360°, and both horizontal and vertical polarizations of the Test Antenna are used to find the maximum radiated power. Mid channels on all channel bandwidth verified. Only the worst RB size/offset presented.

The power of the EUT transmitting frequency should be ignored.

All Spurious Emission tests were performed in X, Y, Z axis direction. And only the worst axis test condition was recorded in this test report.

Use the following spectrum analyzer settings:

Span = wide enough to fully capture the emission being measured

RBW = 1 MHz for  $f \geq 1$  GHz, 100 kHz for  $f < 1$  GHz

VBW  $\geq$  RBW

Sweep = auto

Detector function = peak

Trace = max hold

For measurement below 1GHz, If the emission level of the EUT measured by the peak detector is 3 dB lower than the applicable limit, the peak emission level will be reported, Otherwise, the emission measurement will be repeated using the quasi-peak detector and reported.

For transmitters operating above 1 GHz repeat the measurement with an average detector.

### 5.8.4 Test Result

Please refer to ANNEX A.7.

## 5.9 Power Spectral density (PSD)

### 5.9.1 Limit

#### FCC §15.247(e)

The same method of determining the conducted output power shall be used to determine the power spectral density. If a peak output power is measured, then a peak power spectral density measurement is required. If an average output power is measured, then an average power spectral density measurement should be used.

The transmitter power spectral density conducted from the transmitter to the antenna shall not be greater than 8 dBm in any 3 kHz band during any time interval of continuous transmission. This power spectral density shall be determined in accordance with the provisions of Section 5.4(4), (i.e. the power spectral density shall be determined using the same method as is used to determine the conducted output power).

### 5.9.2 Test Setup

See section 4.5.1 (Diagram 1) for test setup description for the antenna port. The photo of test setup please refer to ANNEX B.

### 5.9.3 Test Procedure

Set analyzer center frequency to DTS channel center frequency.

Set the span to 1.5 times the DTS bandwidth.

Set the RBW to:  $3 \text{ kHz} \leq \text{RBW} \leq 100 \text{ kHz}$ .

Set the VBW  $\geq 3$  RBW.

Detector = peak.

Sweep time = auto couple.

Trace mode = max hold.

Allow trace to fully stabilize.

Use the peak marker function to determine the maximum amplitude level within the RBW.

If measured value exceeds limit, reduce RBW (no less than 3 kHz) and repeat.

### 5.9.4 Test Result

Please refer to ANNEX A.8.

# ANNEX A TEST RESULT

## A.1 Output Power, Duty Cycle

### Peak Power Test Data

Channel	Measured Output Peak Power		Limit		Verdict
	GFSK (BLE 1Mbps)		dBm	mW	
	dBm	mW			
Low Channel	2.03	1.60	30	1000	Pass
Middle Channel	2.91	1.95			Pass
High Channel	3.59	2.29			Pass

### Test Plots

GFSK (BLE 1Mbps) LOW CHANNEL

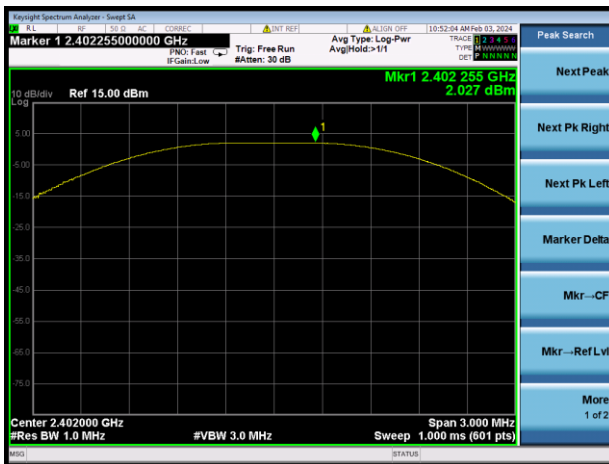

GFSK (BLE 1Mbps) MIDDLE CHANNEL

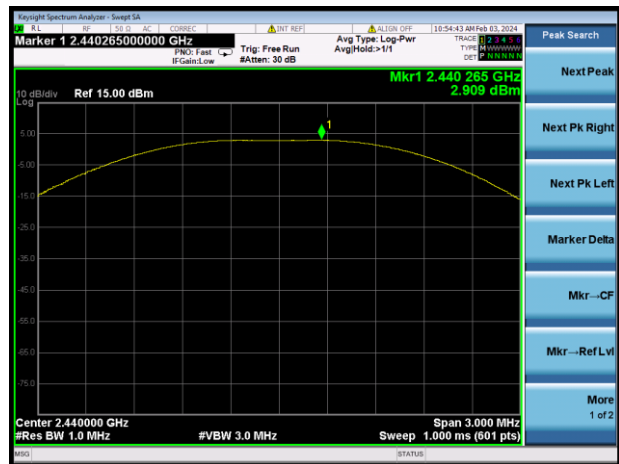

GFSK (BLE 1Mbps) HIGH CHANNEL

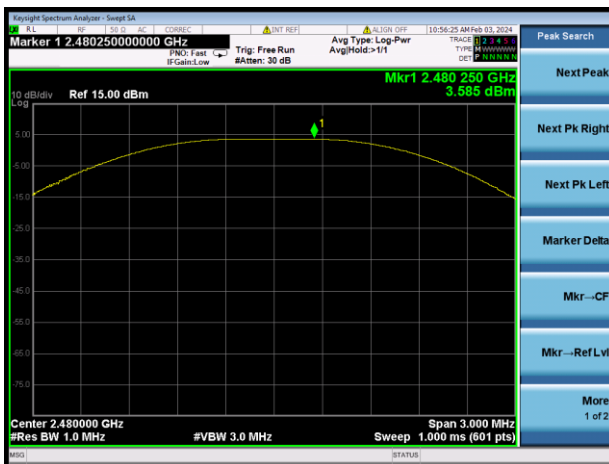

**Duty Cycle Test Data**

Band	On Time (ms)	On+Off Time (ms)	Duty Cycle (%)
GFSK (BLE 1Mbps)	0.3892	0.6244	62.33%

**Test Plot**

GFSK (BLE 1Mbps)

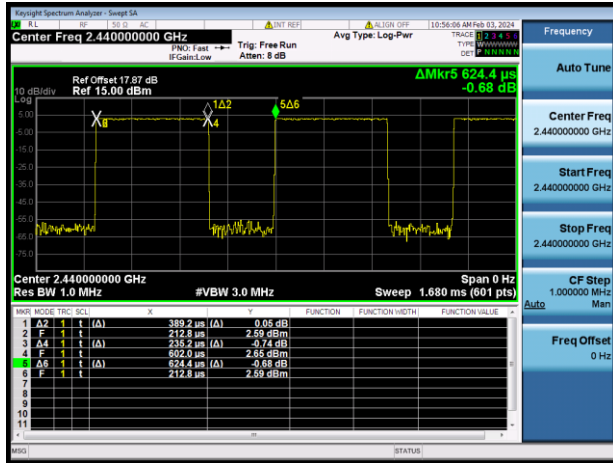

## A.2 Occupied Bandwidth

### Test Data

Test Mode	GFSK (BLE 1Mbps)		
Channel	6 dB Bandwidth (kHz)	99% Bandwidth (kHz)	6 dB Bandwidth Limits (kHz)
Low Channel	675.000	1020.600	≥500
Middle Channel	670.000	1016.100	≥500
High Channel	670.000	1028.600	≥500

### Test Plots

#### 6 dB Bandwidth

GFSK (BLE 1Mbps) LOW CHANNEL



GFSK (BLE 1Mbps) MIDDLE CHANNEL



GFSK (BLE 1Mbps) HIGH CHANNEL



99% Bandwidth

GFSK (BLE 1Mbps) LOW CHANNEL



GFSK (BLE 1Mbps) MIDDLE CHANNEL



GFSK (BLE 1Mbps) HIGH CHANNEL





## A.3 Conducted Spurious Emissions

### Test Data

GFSK (BLE 1Mbps)				
Channel	Measured Max. Out of Band Emission (dBm)	Limit (dBm)		Verdict
		Carrier Level	Calculated 20 dBc Limit	
Low Channel	-29.14	1.70	-18.30	Pass
Middle Channel	-28.07	2.70	-17.30	Pass
High Channel	-26.37	3.45	-16.55	Pass

Test Plots

GFSK (BLE 1Mbps) LOW CHANNEL, CARRIER LEVEL

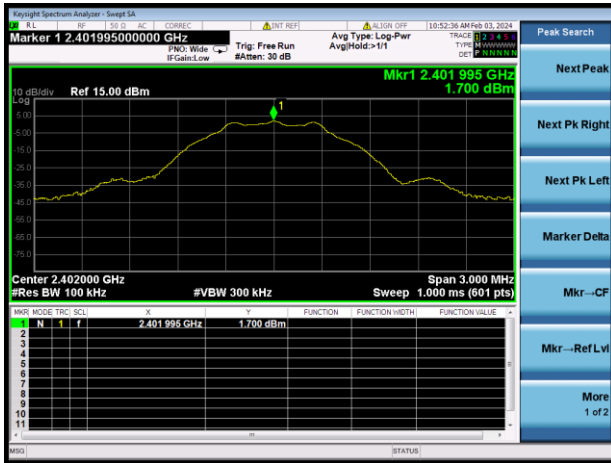

GFSK (BLE 1Mbps) LOW CHANNEL, SPURIOUS 30 MHz ~ 3 GHz

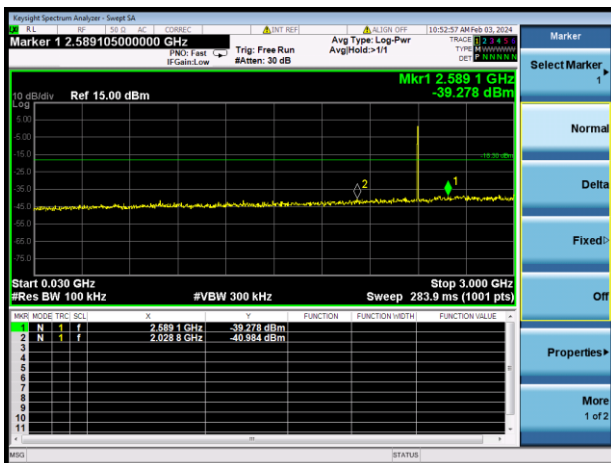

GFSK (BLE 1Mbps) LOW CHANNEL, SPURIOUS 2 GHz ~ 25 GHz



GFSK (BLE 1Mbps) MIDDLE CHANNEL, CARRIER LEVEL

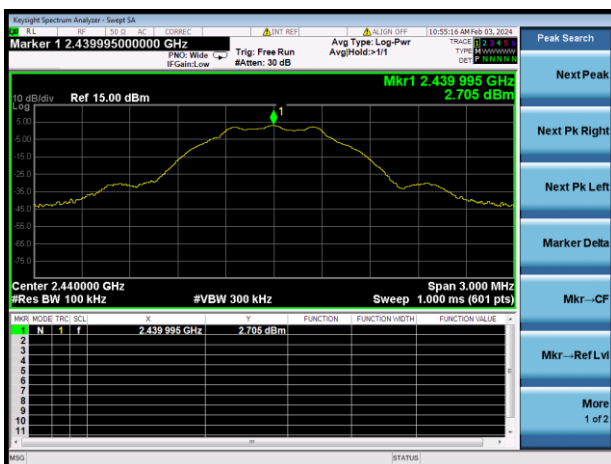

GFSK (BLE 1Mbps) MIDDLE CHANNEL,  
SPURIOUS 30 MHz ~ 3 GHz

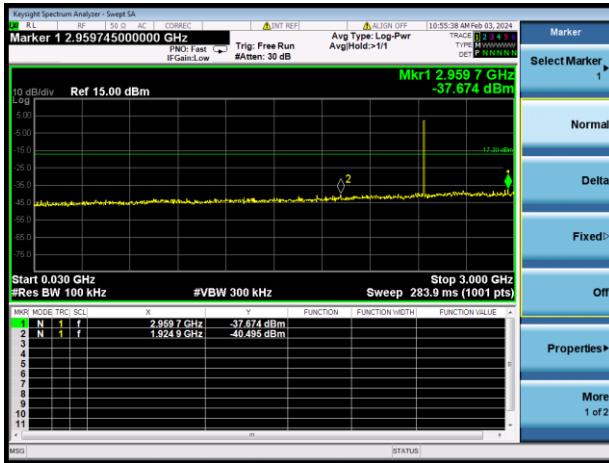

GFSK (BLE 1Mbps) MIDDLE CHANNEL,  
SPURIOUS 2 GHz ~ 25 GHz

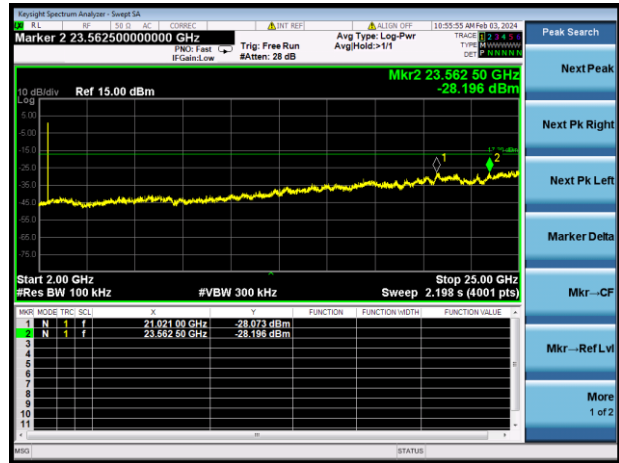

GFSK (BLE 1Mbps) HIGH CHANNEL,  
CARRIER LEVEL

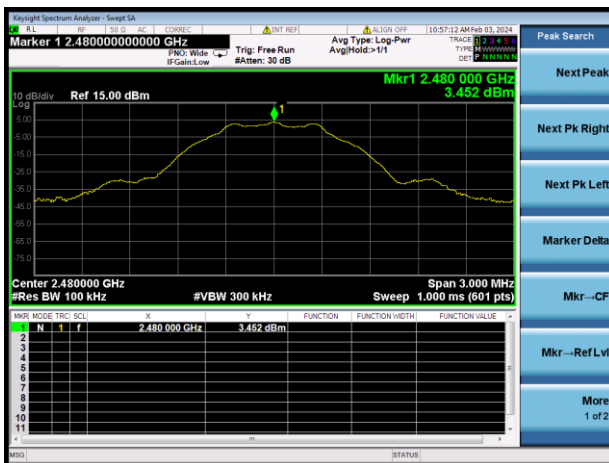

GFSK (BLE 1Mbps) HIGH CHANNEL,  
SPURIOUS 30 MHz ~ 3 GHz

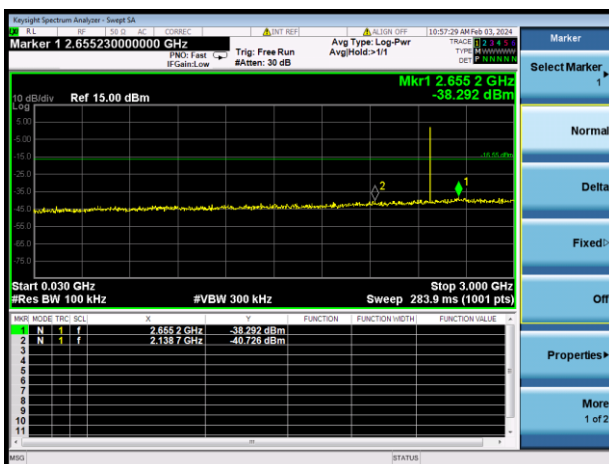

GFSK (BLE 1Mbps) HIGH CHANNEL,  
SPURIOUS 2 GHz ~ 25 GHz

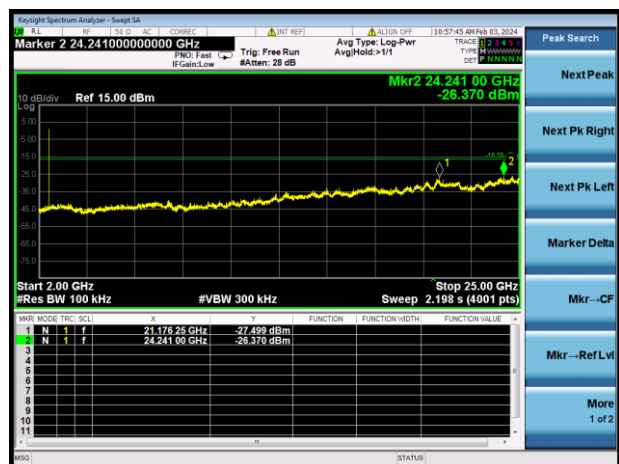

## A.4 Band Edge (Authorized-band band-edge)

Note: The lowest and highest channels are tested to verify the band edge emissions. Please refer to the following the plots for emissions values.

### Test Data

GFSK (BLE 1Mbps)				
Channel	Measured Max. Band Edge Emission (dBm)	Limit (dBm)		Verdict
		Carrier Level	Calculated 20 dBc Limit	
Low Channel	-40.63	1.70	-18.30	Pass
High Channel	-47.06	3.45	-16.55	Pass

### Test Plots

GFSK (BLE 1Mbps) LOW CHANNEL, CARRIER LEVEL

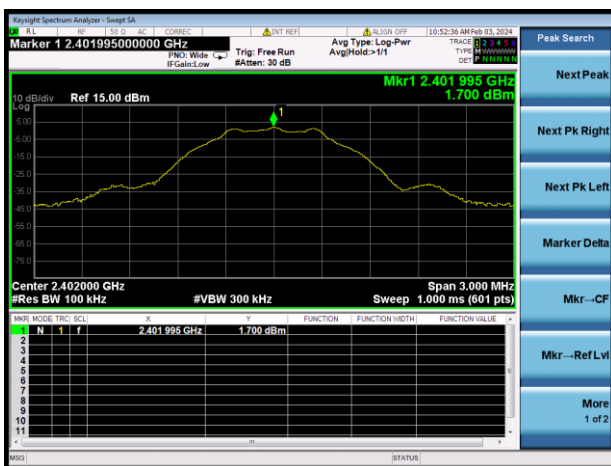

GFSK (BLE 1Mbps) LOW CHANNEL, BAND EDGE

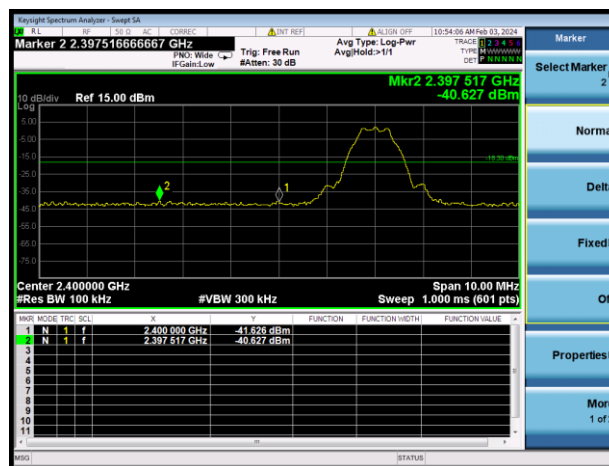

GFSK (BLE 1Mbps) HIGH CHANNEL, CARRIER LEVEL

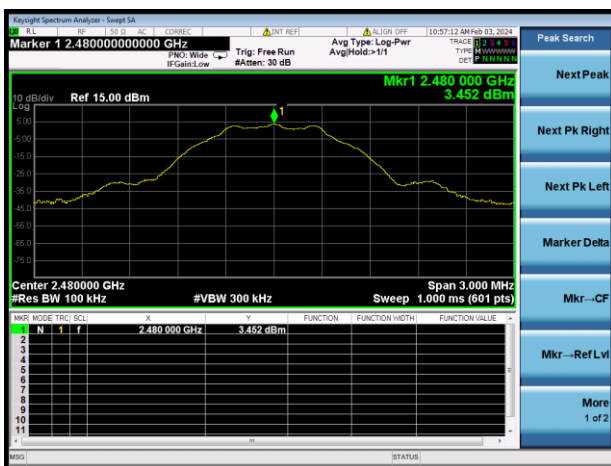

GFSK (BLE 1Mbps) HIGH CHANNEL, BAND EDGE

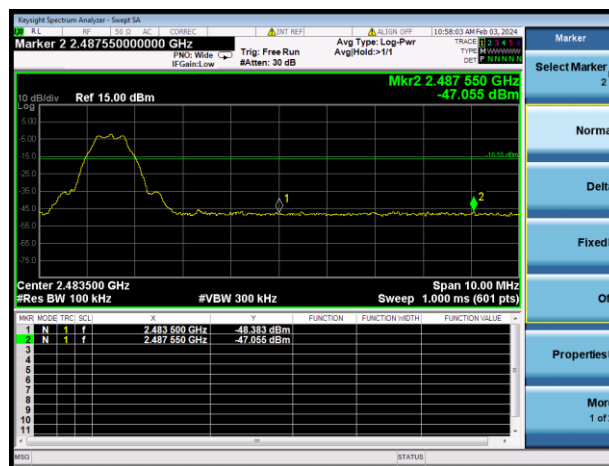

## A.5 Conducted Emissions

Note <sup>1</sup>: The EUT is working in the Normal link mode. All modes have been tested and normal link mode is worst.

Note <sup>2</sup>: Devices subject to Part 15 must be tested for all available U.S. voltages and frequencies (such as a nominal 120 VAC, 60 Hz and 240 VAC, 50 Hz) for which the device is capable of operation. So, The configuration 120 VAC, 60 Hz and 240 VAC, 50 Hz were tested respectively, but only the worst configuration (120 VAC, 60 Hz) shown here.

Note <sup>3</sup>: Results (dBuV) = Original reading level of Spectrum Analyzer (dBuV) + Factor (dB)

### Test Data and Plots

#### PHASE L

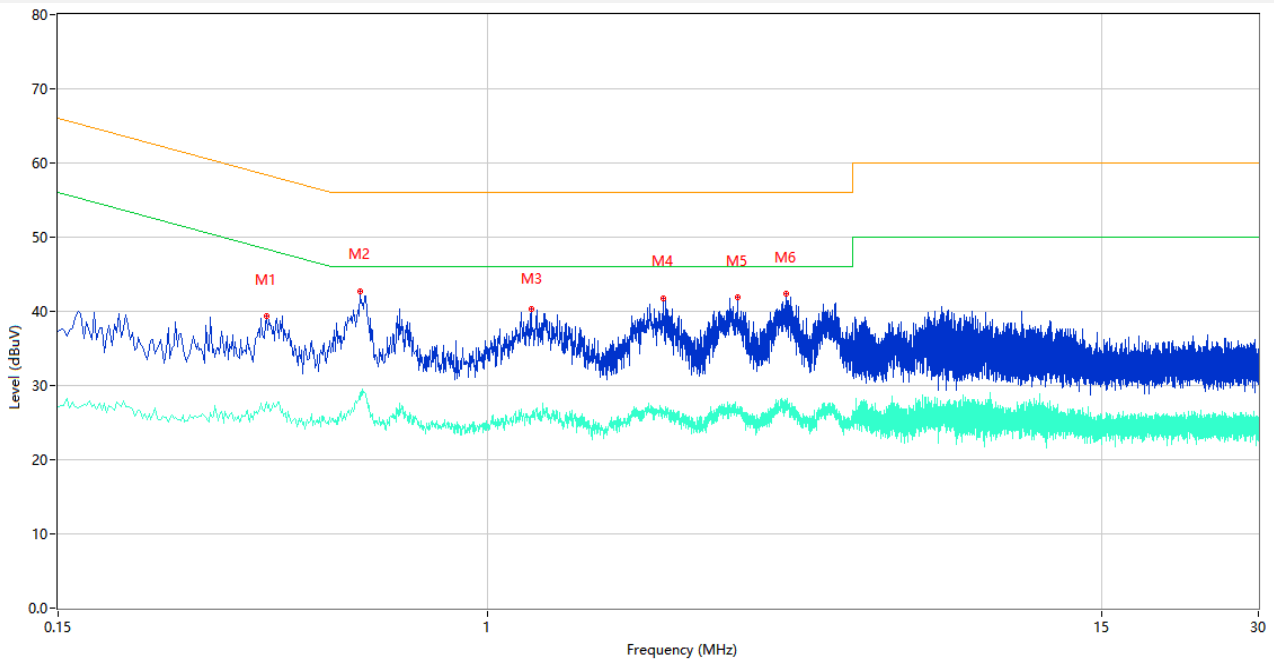

No.	Frequency (MHz)	Results (dBuV)	Factor (dB)	Limit (dBuV)	Margin (dB)	Detector	Line	Verdict
1	0.376	39.35	10.65	58.37	19.02	Peak	L	Pass
1**	0.376	27.74	10.65	48.37	20.63	AV	L	Pass
2	0.568	42.72	10.08	56.00	13.28	Peak	L	Pass
2**	0.568	29.09	10.08	46.00	16.91	AV	L	Pass
3	1.210	40.35	10.02	56.00	15.65	Peak	L	Pass
3**	1.210	25.71	10.02	46.00	20.29	AV	L	Pass
4	2.174	41.77	10.09	56.00	14.23	Peak	L	Pass
4**	2.174	26.43	10.09	46.00	19.57	AV	L	Pass
5	3.012	41.83	10.23	56.00	14.17	Peak	L	Pass
5**	3.012	26.92	10.23	46.00	19.08	AV	L	Pass
6	3.722	42.38	10.36	56.00	13.62	Peak	L	Pass
6**	3.722	26.97	10.36	46.00	19.03	AV	L	Pass

PHASE N

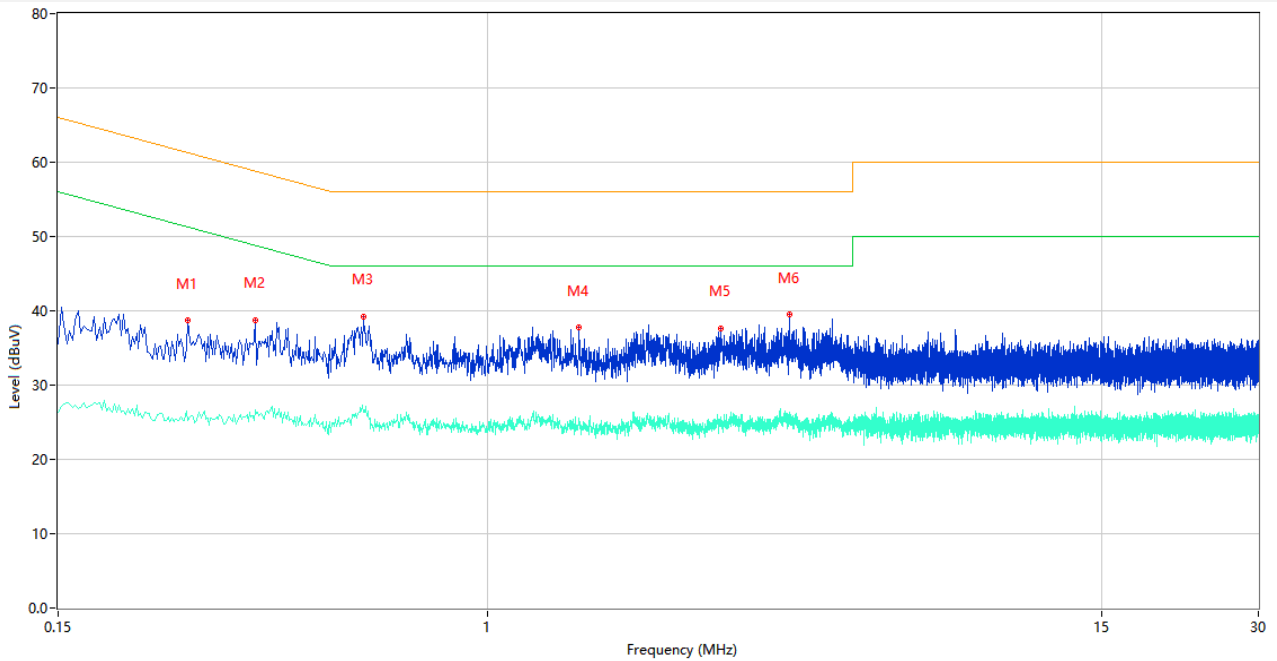

No.	Frequency (MHz)	Results (dBuV)	Factor (dB)	Limit (dBuV)	Margin (dB)	Detector	Line	Verdict
1	0.266	38.68	9.76	61.24	22.56	Peak	N	Pass
1**	0.266	25.31	9.76	51.24	25.93	AV	N	Pass
2	0.358	38.77	10.73	58.77	20.00	Peak	N	Pass
2**	0.358	26.59	10.73	48.77	22.18	AV	N	Pass
3	0.578	39.26	10.10	56.00	16.74	Peak	N	Pass
3**	0.578	26.36	10.10	46.00	19.64	AV	N	Pass
4	1.496	37.71	10.26	56.00	18.29	Peak	N	Pass
4**	1.496	24.93	10.26	46.00	21.07	AV	N	Pass
5	2.790	37.64	10.36	56.00	18.36	Peak	N	Pass
5**	2.790	24.47	10.36	46.00	21.53	AV	N	Pass
6	3.780	39.46	10.37	56.00	16.54	Peak	N	Pass
6**	3.780	24.75	10.37	46.00	21.25	AV	N	Pass

## A.6 Radiated Spurious Emission

Note <sup>1</sup>: The symbol of "--" in the table which means not application.

Note <sup>2</sup>: For the test data above 1 GHz, according the ANSI C63.4-2014, where limits are specified for both average and peak (or quasi-peak) detector functions, if the peak (or quasi-peak) measured value complies with the average limit, it is unnecessary to perform an average measurement.

Note <sup>3</sup>: The low frequency, which started from 9 kHz to 30 MHz, was pre-scanned and the result which was 20 dB lower than the limit line per 15.31(o) was not reported.

Note <sup>4</sup>: The EUT is working in the Normal link mode below 1 GHz. All modes have been tested and BLE 1M-High channel mode is the worst.

Note <sup>5</sup>: Results (dBuV/m) = Original reading level of Spectrum Analyzer (dBuV/m) + Factor (dB)

### Test Data and Plots

#### 30 MHz to 1 GHz, ANT H

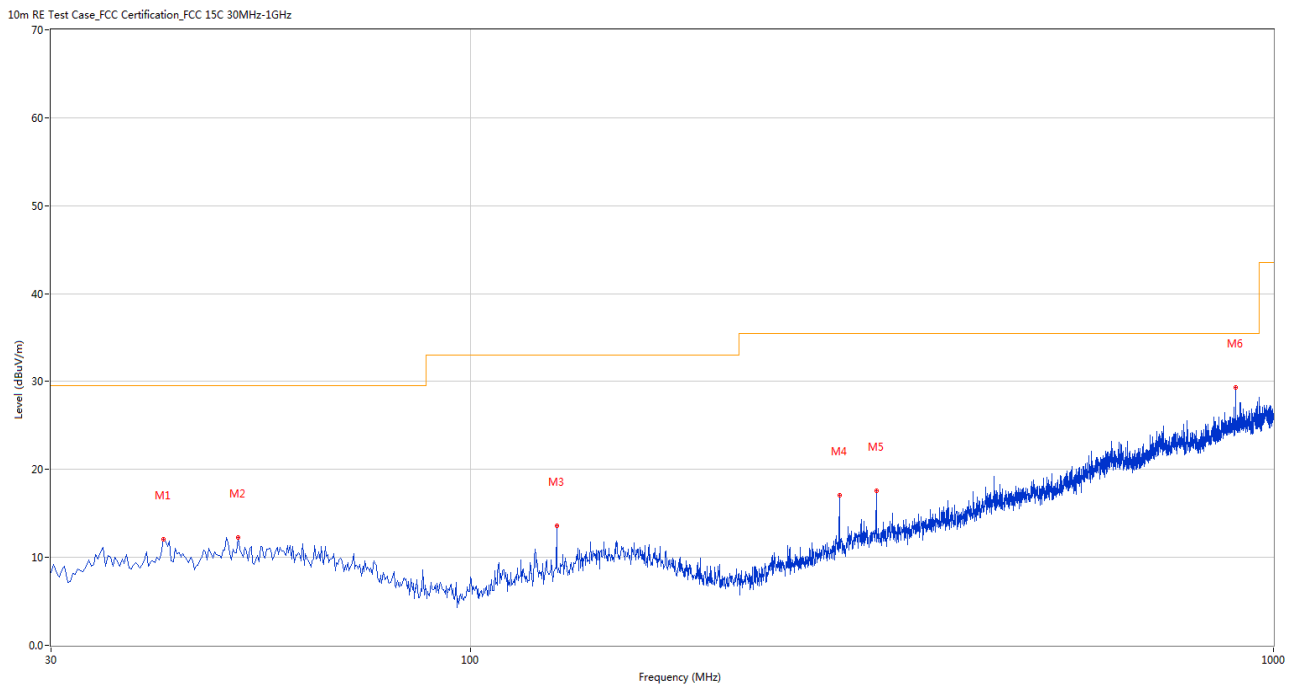

No.	Frequency (MHz)	Results (dBuV/m)	Factor (dB)	Limit (dBuV/m)	Margin (dB)	Detector	Table (Degree)	Height (cm)	Antenna	Verdict
1	41.395	12.06	-26.45	29.5	17.44	Peak	210.00	200	Horizontal	Pass
2	51.335	12.26	-25.84	29.5	17.24	Peak	215.00	200	Horizontal	Pass
3	127.946	13.55	-27.49	33.0	19.45	Peak	356.00	200	Horizontal	Pass
4	287.956	17.05	-25.01	35.5	18.45	Peak	0.00	200	Horizontal	Pass
5	319.958	17.61	-24.11	35.5	17.89	Peak	360.00	200	Horizontal	Pass
6	897.448	29.30	-10.68	35.5	6.20	Peak	128.00	100	Horizontal	Pass

30 MHz to 1 GHz, ANT V

10m RE Test Case\_FCC Certification\_FCC 15C 30MHz-1GHz

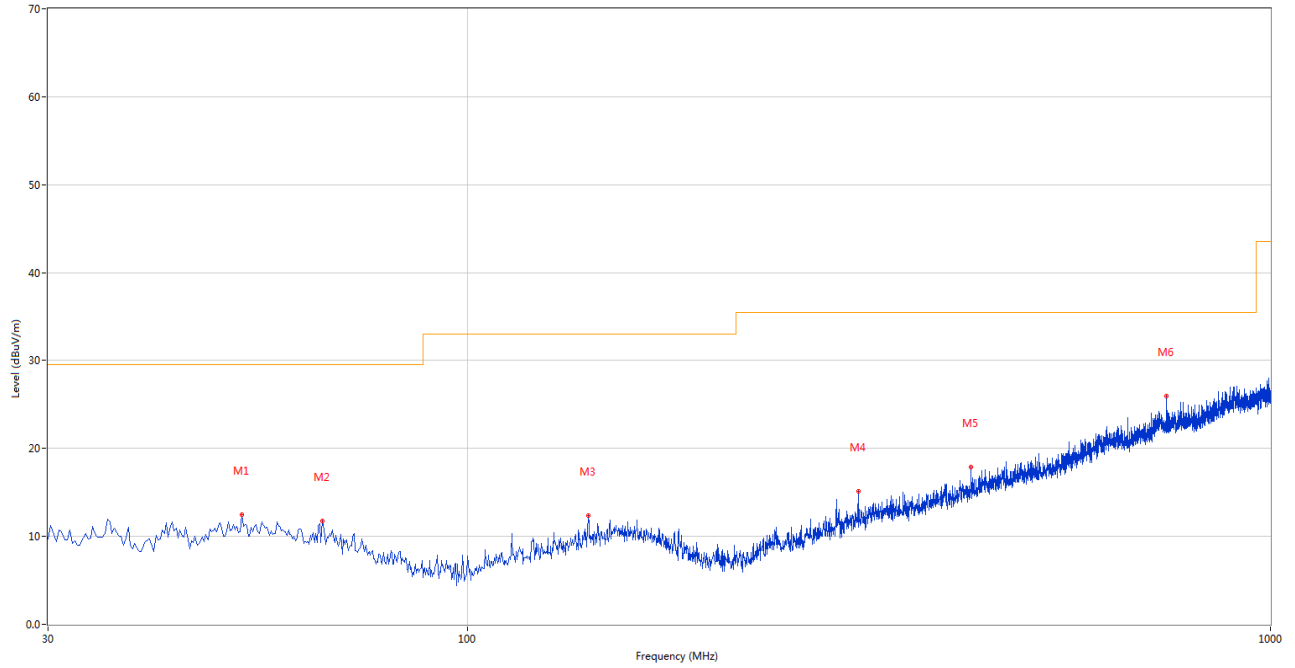

No.	Frequency (MHz)	Results (dBuV/m)	Factor (dB)	Limit (dBuV/m)	Margin (dB)	Detector	Table (Degree)	Height (cm)	Antenna	Verdict
1	52.304	12.48	-26.02	29.5	17.02	Peak	345.00	100	Vertical	Pass
2	65.881	11.73	-27.32	29.5	17.77	Peak	15.00	200	Vertical	Pass
3	141.280	12.41	-26.01	33.0	20.59	Peak	199.00	200	Vertical	Pass
4	306.623	15.08	-24.47	35.5	20.42	Peak	291.00	100	Vertical	Pass
5	423.479	17.85	-21.90	35.5	17.65	Peak	36.00	100	Vertical	Pass
6	741.560	25.99	-13.52	35.5	9.51	Peak	172.00	200	Vertical	Pass



Note 1: The marked spikes near 2400 MHz with circle should be ignored because they are Fundamental signal.

Note 2: The spurious from 18GHz-25GHz is noise only, do not show on the report.

**GFSK (BLE 1Mbps) LOW CHANNEL 1 GHz to 18 GHz, ANT H**

RE Test case\_FCC Part 15C\_FCC 15.247(2.4G)\_1GHz-18GHz

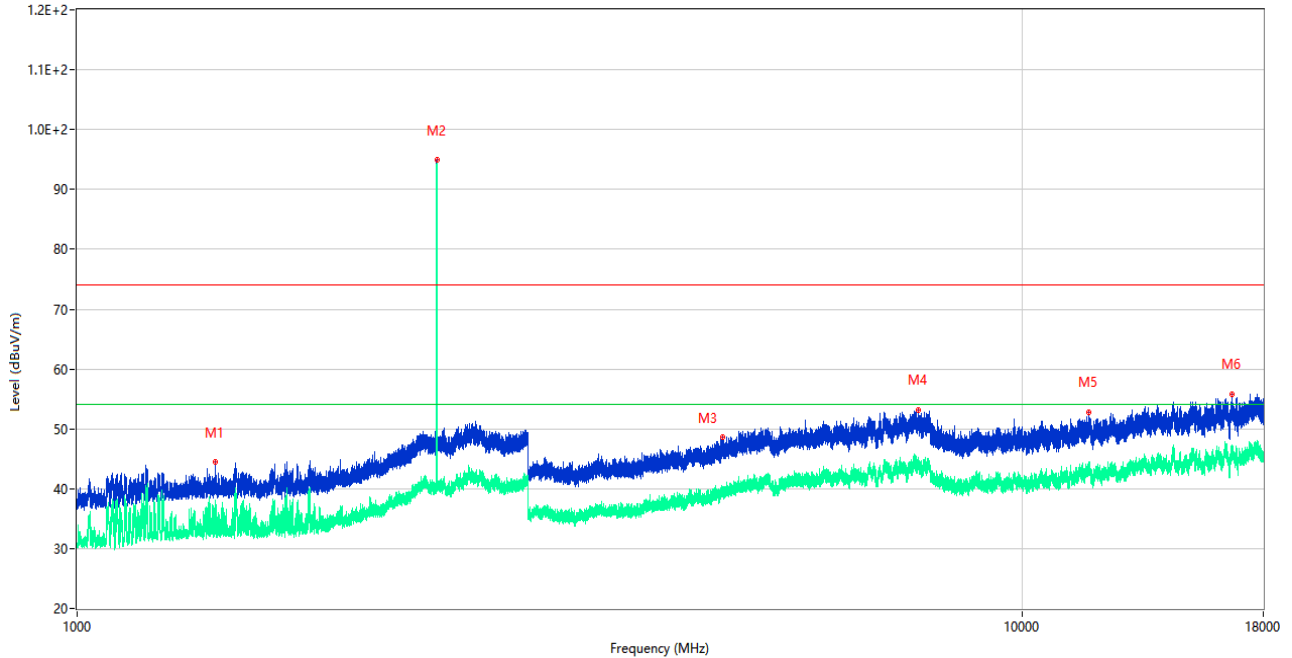

No.	Frequency (MHz)	Results (dBuV/m)	Factor (dB)	Limit (dBuV/m)	Margin (dB)	Detector	Table (Degree)	Height (cm)	Antenna	Verdict
1	1399.300	44.42	-16.95	74.0	29.58	Peak	235.00	200	Horizontal	Pass
1**	1399.300	36.25	-16.95	54.0	17.75	AV	235.00	200	Horizontal	Pass
2	2402.300	94.90	-10.58	74.0	-20.90	Peak	45.00	150	Horizontal	N/A
2**	2402.300	94.14	-10.58	54.0	-40.14	AV	45.00	150	Horizontal	N/A
3	4817.000	48.66	-2.95	74.0	25.34	Peak	14.00	200	Horizontal	Pass
3**	4817.000	39.35	-2.95	54.0	14.65	AV	14.00	200	Horizontal	Pass
4	7767.250	53.22	1.32	74.0	20.78	Peak	0.00	200	Horizontal	Pass
4**	7767.250	44.31	1.32	54.0	9.69	AV	0.00	200	Horizontal	Pass
5	11751.788	52.82	-0.19	74.0	21.18	Peak	245.00	200	Horizontal	Pass
5**	11751.788	42.58	-0.19	54.0	11.42	AV	245.00	200	Horizontal	Pass
6	16661.512	55.85	2.58	74.0	18.15	Peak	171.00	300	Horizontal	Pass
6**	16661.512	46.07	2.58	54.0	7.93	AV	171.00	300	Horizontal	Pass

GFSK (BLE 1Mbps) LOW CHANNEL 1 GHz to 18 GHz, ANT V

RE Test case\_FCC Part 15C\_FCC 15.247(2.4G)\_1GHz-18GHz

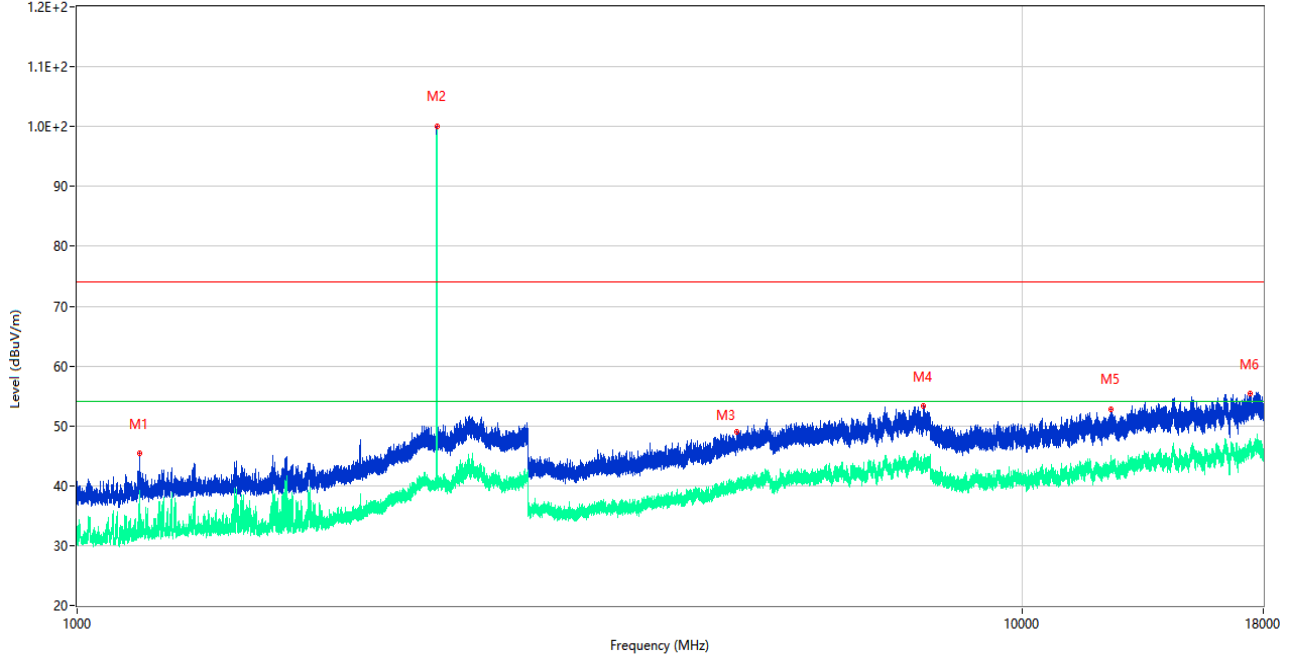

No.	Frequency (MHz)	Results (dBuV/m)	Factor (dB)	Limit (dBuV/m)	Margin (dB)	Detector	Table (Degree)	Height (cm)	Antenna	Verdict
1	1165.200	45.37	-17.50	74.0	28.63	Peak	269.00	100	Vertical	Pass
1**	1165.200	34.70	-17.50	54.0	19.30	AV	269.00	100	Vertical	Pass
2	2402.300	100.03	-10.58	74.0	-26.03	Peak	171.00	200	Vertical	N/A
2**	2402.300	99.25	-10.58	54.0	-45.25	AV	171.00	200	Vertical	N/A
3	4990.250	49.00	-3.20	74.0	25.00	Peak	145.00	150	Vertical	Pass
3**	4990.250	40.41	-3.20	54.0	13.59	AV	145.00	150	Vertical	Pass
4	7871.000	53.25	1.76	74.0	20.75	Peak	45.00	300	Vertical	Pass
4**	7871.000	43.36	1.76	54.0	10.64	AV	45.00	300	Vertical	Pass
5	12403.963	52.82	1.10	74.0	21.18	Peak	251.00	100	Vertical	Pass
5**	12403.963	44.08	1.10	54.0	9.92	AV	251.00	100	Vertical	Pass
6	17426.176	55.36	5.50	74.0	18.64	Peak	240.00	100	Vertical	Pass
6**	17426.176	46.00	5.50	54.0	8.00	AV	240.00	100	Vertical	Pass

GFSK (BLE 1Mbps) MIDDLE CHANNEL 1 GHz to 18 GHz, ANT H

RE Test case\_FCC Part 15C\_FCC 15.247(2.4G)\_1GHz-18GHz

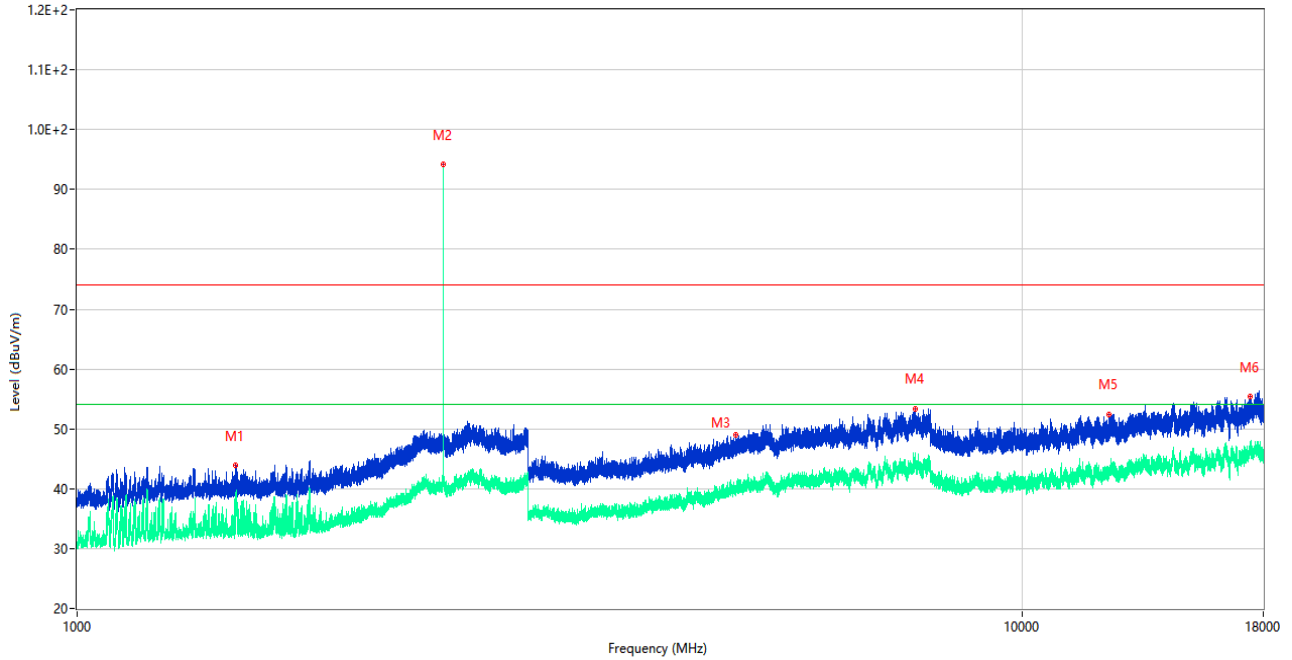

No.	Frequency (MHz)	Results (dBuV/m)	Factor (dB)	Limit (dBuV/m)	Margin (dB)	Detector	Table (Degree)	Height (cm)	Antenna	Verdict
1	1471.300	43.88	-17.03	74.0	30.12	Peak	229.00	400	Horizontal	Pass
1**	1471.300	39.18	-17.03	54.0	14.82	AV	229.00	400	Horizontal	Pass
2	2439.800	94.18	-10.27	74.0	-20.18	Peak	281.00	150	Horizontal	N/A
2**	2439.800	93.62	-10.27	54.0	-39.62	AV	281.00	150	Horizontal	N/A
3	4977.000	49.06	-3.52	74.0	24.94	Peak	67.00	150	Horizontal	Pass
3**	4977.000	40.13	-3.52	54.0	13.87	AV	67.00	150	Horizontal	Pass
4	7704.000	53.41	1.37	74.0	20.59	Peak	299.00	300	Horizontal	Pass
4**	7704.000	44.78	1.37	54.0	9.22	AV	299.00	300	Horizontal	Pass
5	12365.013	52.43	0.92	74.0	21.57	Peak	348.00	300	Horizontal	Pass
5**	12365.013	42.28	0.92	54.0	11.72	AV	348.00	300	Horizontal	Pass
6	17446.650	55.34	5.56	74.0	18.66	Peak	63.00	200	Horizontal	Pass
6**	17446.650	46.64	5.56	54.0	7.36	AV	63.00	200	Horizontal	Pass

GFSK (BLE 1Mbps) MIDDLE CHANNEL 1 GHz to 18 GHz, ANT V

RE Test case\_FCC Part 15C\_FCC 15.247(2.4G)\_1GHz-18GHz

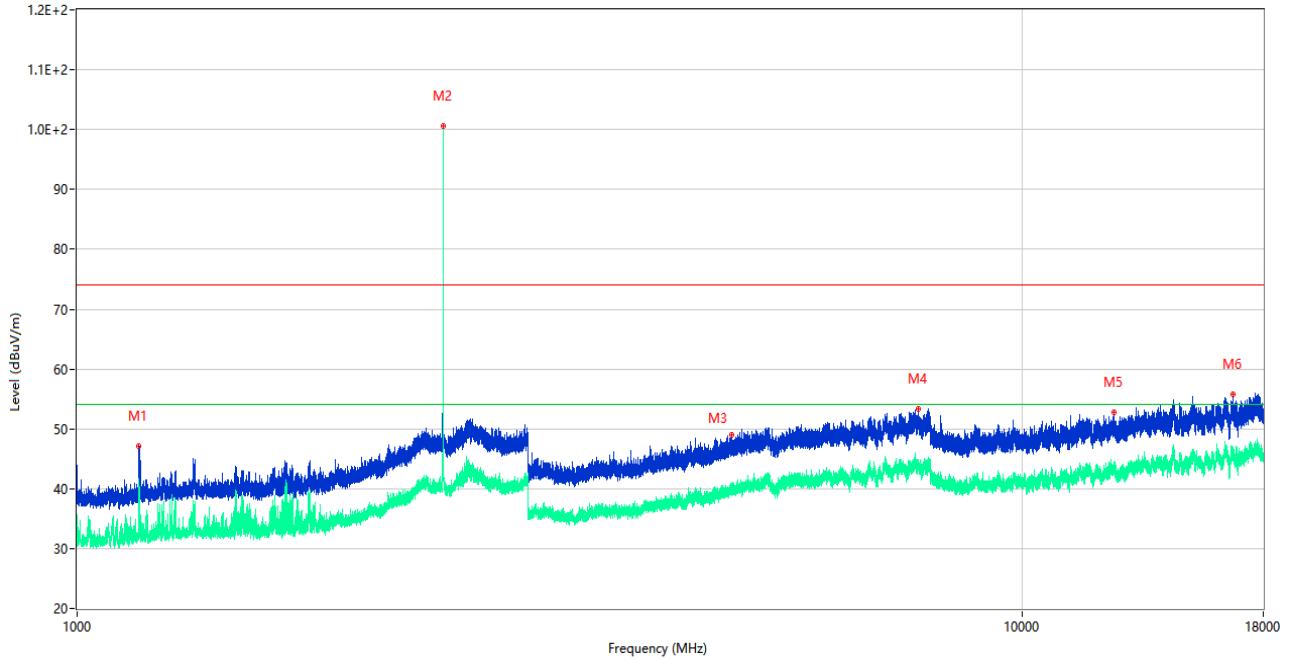

No.	Frequency (MHz)	Results (dBuV/m)	Factor (dB)	Limit (dBuV/m)	Margin (dB)	Detector	Table (Degree)	Height (cm)	Antenna	Verdict
1	1161.600	47.18	-17.73	74.0	26.82	Peak	286.00	400	Vertical	Pass
1**	1161.600	32.62	-17.73	54.0	21.38	AV	286.00	400	Vertical	Pass
2	2440.400	100.62	-9.94	74.0	-26.62	Peak	157.00	100	Vertical	N/A
2**	2440.400	100.18	-9.94	54.0	-46.18	AV	157.00	100	Vertical	N/A
3	4926.000	48.96	-3.61	74.0	25.04	Peak	277.00	150	Vertical	Pass
3**	4926.000	39.85	-3.61	54.0	14.15	AV	277.00	150	Vertical	Pass
4	7758.000	53.39	1.54	74.0	20.61	Peak	360.00	400	Vertical	Pass
4**	7758.000	44.12	1.54	54.0	9.88	AV	360.00	400	Vertical	Pass
5	12526.276	52.81	1.29	74.0	21.19	Peak	148.00	400	Vertical	Pass
5**	12526.276	42.87	1.29	54.0	11.13	AV	148.00	400	Vertical	Pass
6	16708.762	55.85	2.79	74.0	18.15	Peak	360.00	100	Vertical	Pass
6**	16708.762	45.48	2.79	54.0	8.52	AV	360.00	100	Vertical	Pass

GFSK (BLE 1Mbps) HIGH CHANNEL 1 GHz to 18 GHz, ANT H

RE Test case\_FCC Part 15C\_FCC 15.247(2.4G)\_1GHz-18GHz

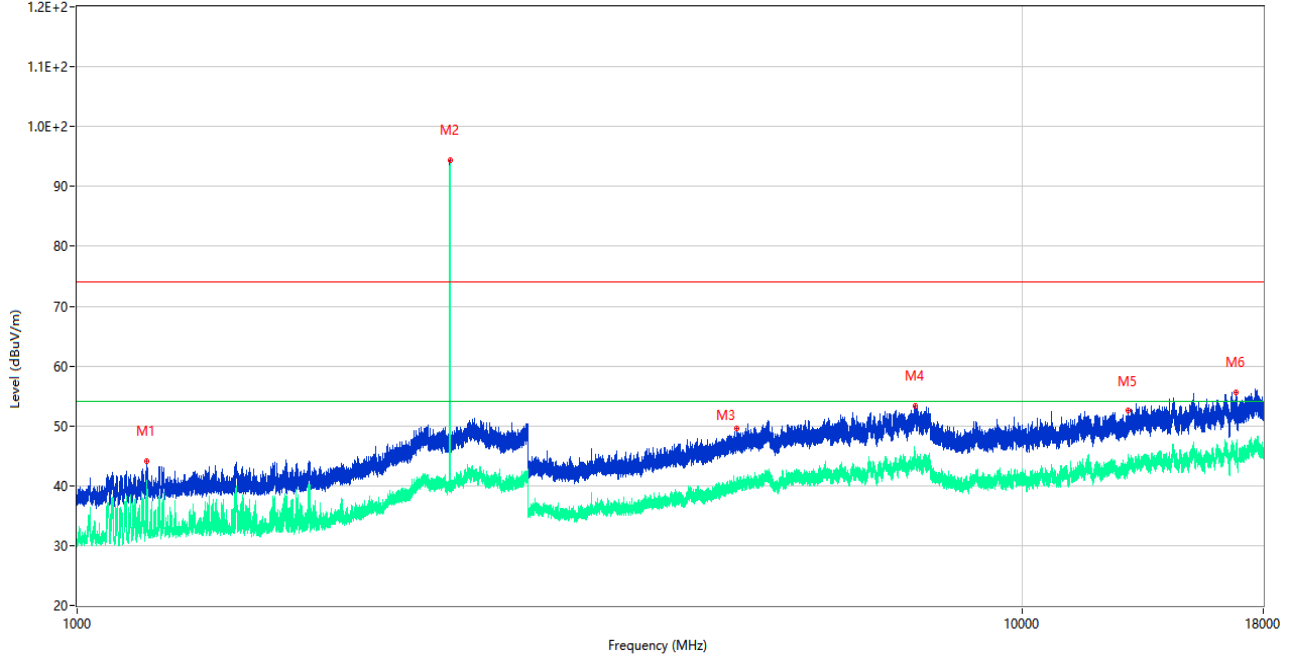

No.	Frequency (MHz)	Results (dBuV/m)	Factor (dB)	Limit (dBuV/m)	Margin (dB)	Detector	Table (Degree)	Height (cm)	Antenna	Verdict
1	1184.600	44.12	-17.56	74.0	29.88	Peak	244.00	200	Horizontal	Pass
1**	1184.600	39.96	-17.56	54.0	14.04	AV	244.00	200	Horizontal	Pass
2	2479.800	94.41	-11.14	74.0	-20.41	Peak	57.00	100	Horizontal	N/A
2**	2479.800	94.01	-11.14	54.0	-40.01	AV	57.00	100	Horizontal	N/A
3	4985.750	49.52	-3.10	74.0	24.48	Peak	240.00	100	Horizontal	Pass
3**	4985.750	39.09	-3.10	54.0	14.91	AV	240.00	100	Horizontal	Pass
4	7709.750	53.41	1.76	74.0	20.59	Peak	360.00	200	Horizontal	Pass
4**	7709.750	44.24	1.76	54.0	9.76	AV	360.00	200	Horizontal	Pass
5	12948.712	52.50	1.56	74.0	21.50	Peak	85.00	300	Horizontal	Pass
5**	12948.712	43.49	1.56	54.0	10.51	AV	85.00	300	Horizontal	Pass
6	16852.088	55.68	3.53	74.0	18.32	Peak	340.00	200	Horizontal	Pass
6**	16852.088	46.31	3.53	54.0	7.69	AV	340.00	200	Horizontal	Pass

GFSK (BLE 1Mbps) HIGH CHANNEL 1 GHz to 18 GHz, ANT V

RE Test case\_FCC Part 15C\_FCC 15.247(2.4G)\_1GHz-18GHz

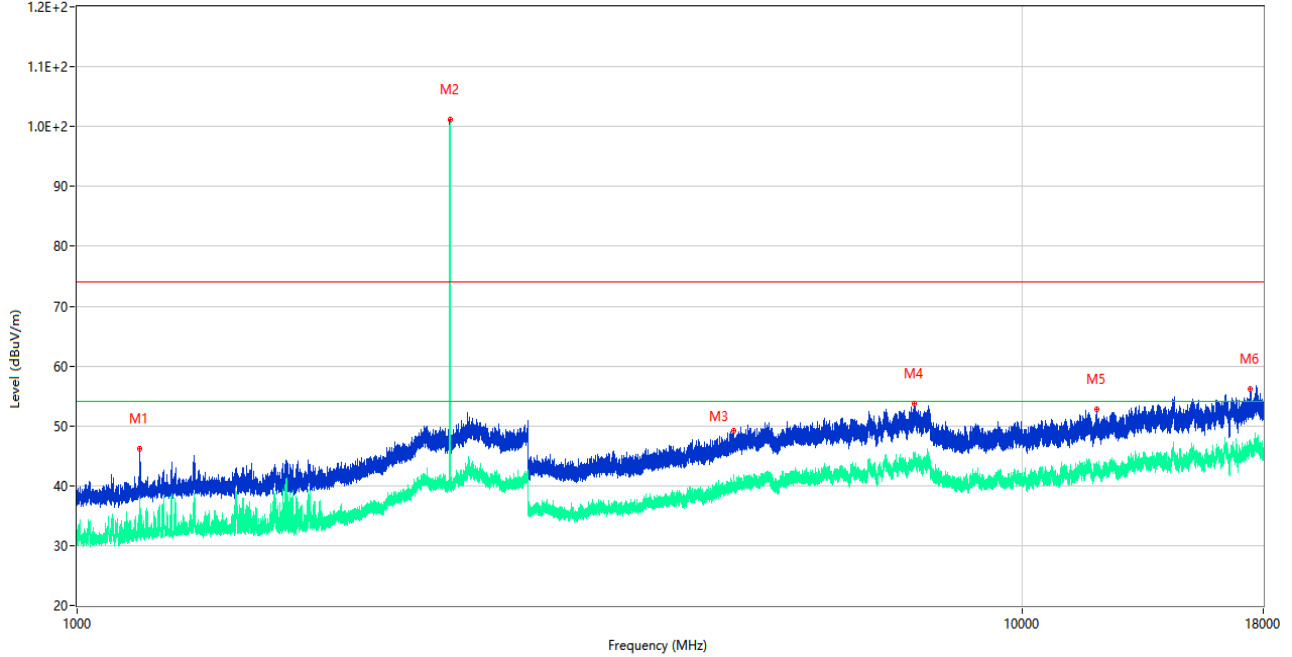

No.	Frequency (MHz)	Results (dBuV/m)	Factor (dB)	Limit (dBuV/m)	Margin (dB)	Detector	Table (Degree)	Height (cm)	Antenna	Verdict
1	1165.100	46.22	-17.51	74.0	27.78	Peak	286.00	200	Vertical	Pass
1**	1165.100	38.35	-17.51	54.0	15.65	AV	286.00	200	Vertical	Pass
2	2480.000	101.17	-11.11	74.0	-27.17	Peak	163.00	150	Vertical	N/A
2**	2480.000	100.30	-11.11	54.0	-46.30	AV	163.00	150	Vertical	N/A
3	4953.750	49.13	-3.44	74.0	24.87	Peak	360.00	200	Vertical	Pass
3**	4953.750	39.42	-3.44	54.0	14.58	AV	360.00	200	Vertical	Pass
4	7696.000	53.75	1.04	74.0	20.25	Peak	349.00	200	Vertical	Pass
4**	7696.000	43.65	1.04	54.0	10.35	AV	349.00	200	Vertical	Pass
5	11986.437	52.81	0.17	74.0	21.19	Peak	94.00	300	Vertical	Pass
5**	11986.437	42.74	0.17	54.0	11.26	AV	94.00	300	Vertical	Pass
6	17449.802	56.18	5.57	74.0	17.82	Peak	348.00	100	Vertical	Pass
6**	17449.802	46.86	5.57	54.0	7.14	AV	348.00	100	Vertical	Pass

## A.7 Band Edge (Restricted-band band-edge)

Note <sup>1</sup>: The lowest and highest channels are tested to verify the band edge emissions. Please refer to the following the plots for emissions values.

Note <sup>2</sup>: The test data all are tested in the vertical and horizontal antenna which the trace is max hold. So these plots have shown the worst case.

Note <sup>3</sup>: According the ANSI C63.10-2013, where limits are specified for both average and peak (or quasi-peak) detector functions, if the peak (or quasi-peak) measured value complies with the average limit, it is unnecessary to perform an average measurement.

Note <sup>4</sup>: The Level (dBuV/m) has been corrected by factor.

### Test Data and Plots

#### GFSK (BLE 1Mbps) LOW CHANNEL

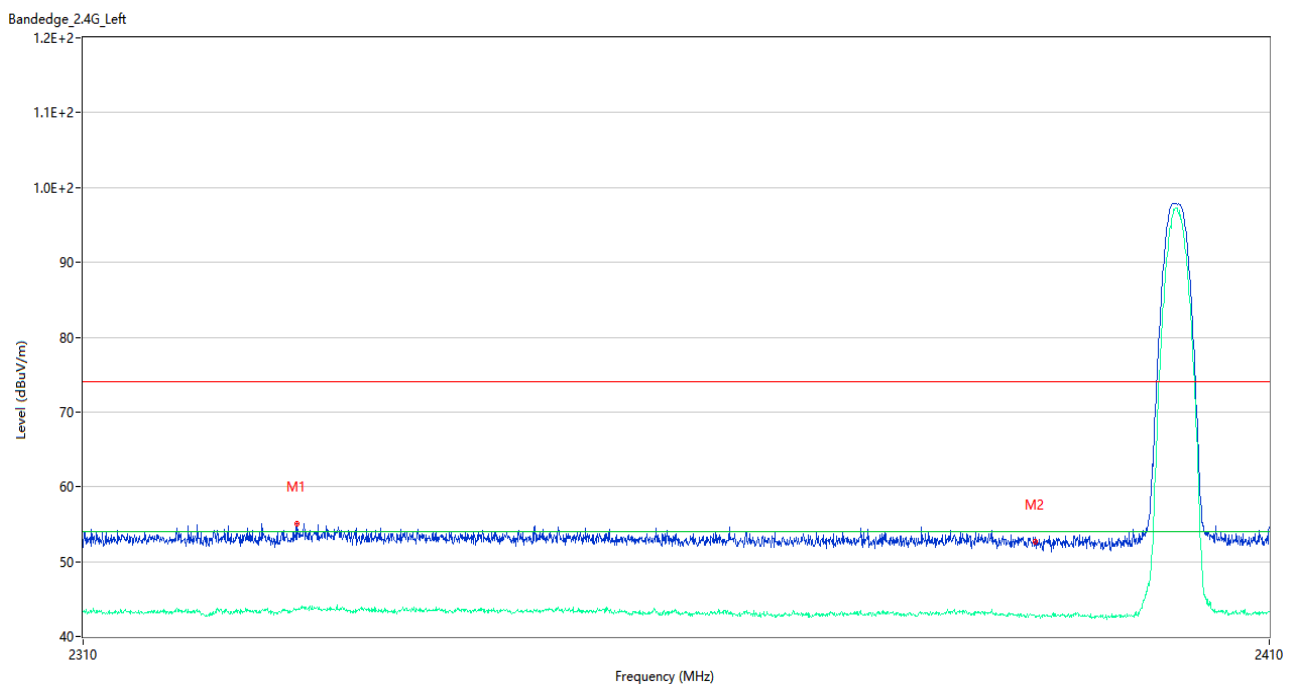

No.	Frequency (MHz)	Results (dBuV/m)	Factor (dB)	Limit (dBuV/m)	Margin (dB)	Detector	Table (Degree)	Height (cm)	Antenna	Verdict
1	2327.700	55.09	-0.84	74.0	18.91	Peak	5.00	200	Vertical	Pass
1**	2327.700	43.57	-0.84	54.0	10.43	AV	5.00	200	Vertical	Pass
2	2389.950	52.64	-1.82	74.0	21.36	Peak	208.00	150	Vertical	Pass
2**	2389.950	42.63	-1.82	54.0	11.37	AV	208.00	150	Vertical	Pass

**GFSK (BLE 1Mbps) HIGH CHANNEL**

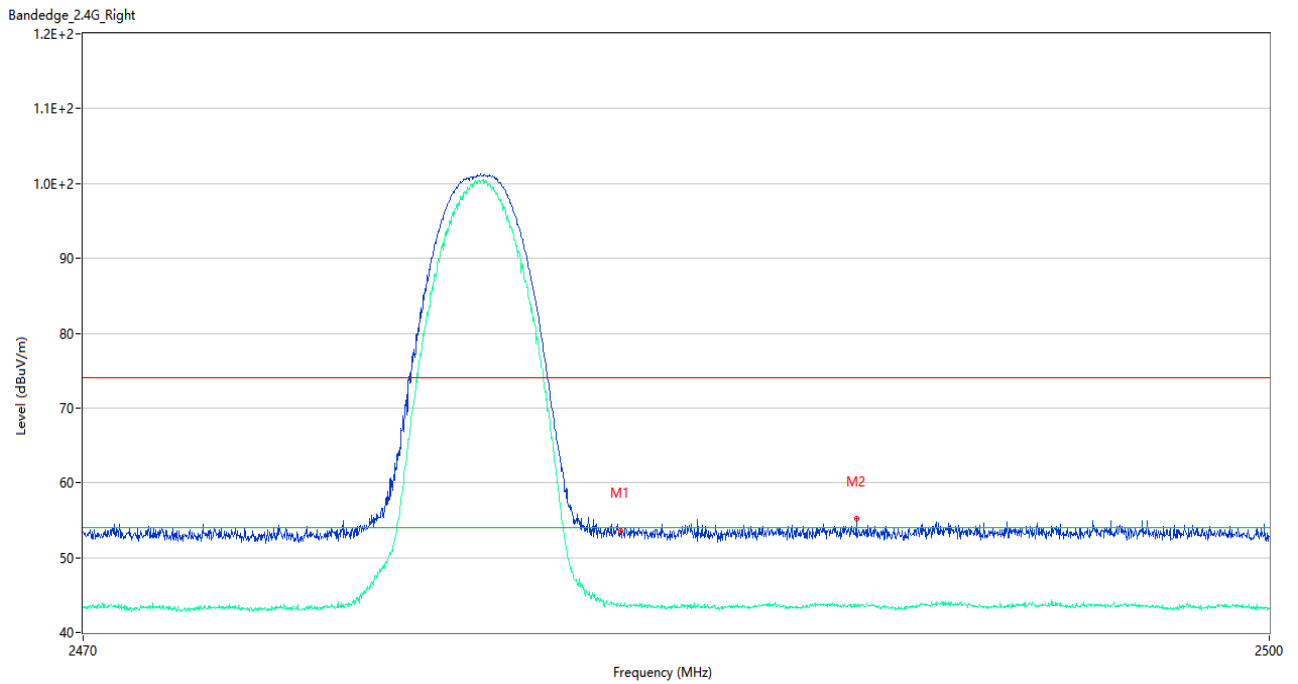

No.	Frequency (MHz)	Results (dBuV/m)	Factor (dB)	Limit (dBuV/m)	Margin (dB)	Detector	Table (Degree)	Height (cm)	Antenna	Verdict
1	2483.545	53.62	-1.09	74.0	20.38	Peak	105.00	100	Vertical	Pass
1**	2483.545	43.90	-1.09	54.0	10.10	AV	105.00	100	Vertical	Pass
2	2489.515	55.16	-0.98	74.0	18.84	Peak	169.00	150	Vertical	Pass
2**	2489.515	43.46	-0.98	54.0	10.54	AV	169.00	150	Vertical	Pass



## A.8 Power Spectral Density (PSD)

### Test Data

GFSK (BLE 1Mbps)			
Channel	Spectral power density (dBm/3kHz)	Limit (dBm/3kHz)	Verdict
Low Channel	-13.47	8	Pass
Middle Channel	-11.60	8	Pass
High Channel	-11.94	8	Pass

### Test Plots

GFSK (BLE 1Mbps) LOW CHANNEL

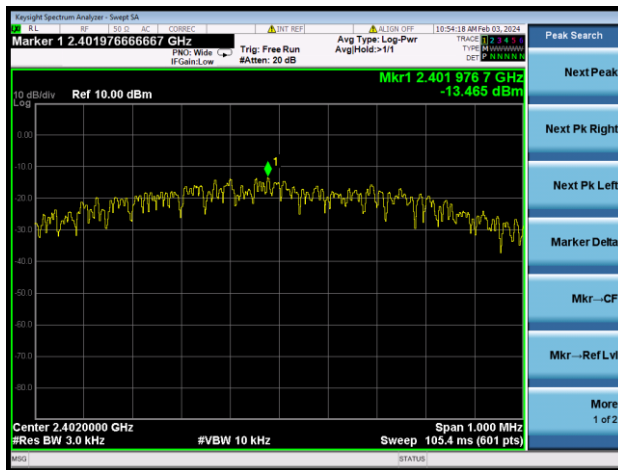

GFSK (BLE 1Mbps) MIDDLE CHANNEL

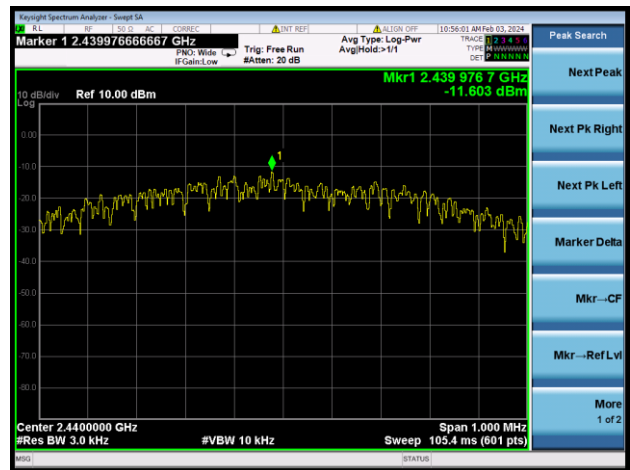

GFSK (BLE 1Mbps) HIGH CHANNEL

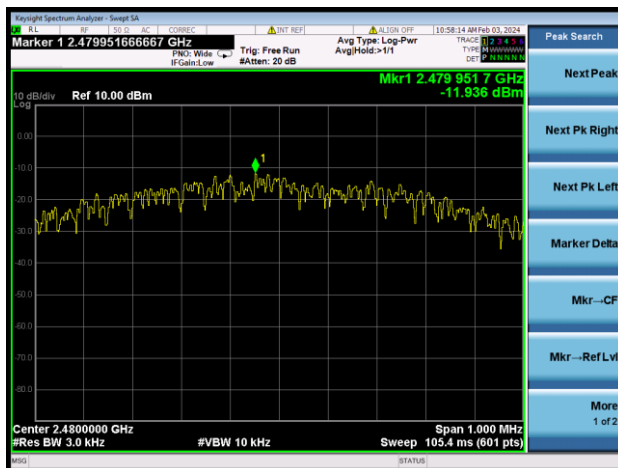

## **ANNEX B TEST SETUP PHOTOS**

Please refer the document “BL-SZ2411137-AR-1.PDF”.

## **ANNEX C EUT EXTERNAL PHOTOS**

Please refer the document “BL-SZ2411137-AW-1.PDF”.

## **ANNEX D EUT INTERNAL PHOTOS**

Please refer the document “BL-SZ2411137-AI-1.PDF”.

## Statement

1. The laboratory guarantees the scientificity, accuracy and impartiality of the test, and is responsible for all the information in the report, except the information provided by the customer. The customer is responsible for the impact of the information provided on the validity of the results.
2. The report without China inspection body and laboratory Mandatory Approval (CMA) mark has no effect of proving to the society.
3. For the report with CNAS mark or A2LA mark, the items marked with "☆" are not within the accredited scope.
4. This report is invalid if it is altered, without the signature of the testing and approval personnel, or without the "inspection and testing dedicated stamp" or test report stamp.
5. The test data and results are only valid for the tested samples provided by the customer.
6. This report shall not be partially reproduced without the written permission of the laboratory.
7. Any objection shall be raised to the laboratory within 30 days after receiving the report.

--END OF REPORT--