

Handbook for the Palm VII™ Organizer



Copyright

Copyright © 1998 3Com Corporation or its subsidiaries. All rights reserved. 3Com, the 3Com logo, Palm Computing, Palm Modem, Graffiti, and HotSync are registered trademarks, and Palm, PalmPilot, Palm III, Palm VII, Palm OS, Palm.Net, iMessenger, More Connected., the Palm Computing Platform logo, the PalmPilot logo, Palm VII logo, and the HotSync logo are trademarks of Palm Computing, Inc., 3Com Corporation or its subsidiaries. Other product and brand names may be trademarks or registered trademarks of their respective owners.

Disclaimer and Limitation of Liability

3Com Corporation and its subsidiaries assume no responsibility for any damage or loss resulting from the use of this handbook.

3Com Corporation and its subsidiaries assume no responsibility for any loss or claims by third parties which may arise through the use of this software. 3Com Corporation and its subsidiaries assume no responsibility for any damage or loss caused by deletion of data as a result of malfunction, dead battery or repairs. Be sure to make backup copies of all important data on other media to protect against data loss.

Important: Please read the 3Com End User Software License Agreement contained in this handbook before using the accompanying software program(s). Using any part of the software indicates that you accept the terms of the 3Com End User Software License Agreement.

3.5" Software Diskettes Available

Palm™ Desktop organizer software is supplied on a CD-ROM disc. If you do not have access to a CD-ROM drive for your computer, you may download the Palm Desktop software from <http://www.palm.net>. Alternatively, you can order 3.5" diskettes by completing and mailing the diskette order card supplied in the Palm VII™ connected organizer product package, or call to order the diskettes. See the *Getting Started* guide for the appropriate phone number.

P/N: 405-0406A

A/N: 423-0233

Contents

About This Book	1
Chapter 1: Introduction to Your Palm VII™ Organizer	
Getting to know your Palm VII organizer.....	3
What is a Palm VII organizer?.....	3
System requirements	4
Palm VII components	5
Installing the batteries	9
Replacing batteries.....	9
Setting up your organizer and charging the transmitter	10
Upgrade information.....	10
Palm Desktop organizer software	12
Using your organizer with another PIM	14
Palm.Net wireless features	14
Tapping and typing.....	18
Tap with the stylus to get things done.....	18
Elements of the organizer interface	19
Opening applications	20
Using menus	23
Three ways to enter data.....	25
Customizing your organizer	29
Chapter 2: Entering Data in Your Palm VII™ Organizer	
Using Graffiti writing to enter data.....	31
Writing Graffiti characters	31
Graffiti tips	33
The Graffiti alphabet.....	34
Writing capital letters	35
Writing numbers	35
Graffiti numbers	36
Writing punctuation marks	36
Additional Graffiti punctuation.....	37
Writing symbols and extended characters	37
Writing accented characters	38
Accent strokes.....	38
Additional non-English characters.....	38
Navigation strokes.....	39
Graffiti ShortCuts.....	39
Using the onscreen keyboard.....	41
Using your computer keyboard.....	41
Importing data.....	42

Chapter 3: Managing Your Applications

Using the Applications Launcher	45
Selecting applications.....	45
Switching between applications.....	45
Categorizing applications.....	45
Changing the Applications Launcher display.....	46
Choosing preferences.....	47
Installing and removing applications.....	48
Installing add-on applications	48
Installing games	50
Removing applications	51
Removing Palm Desktop software.....	52
Security.....	53
Assigning a password.....	53
Changing or deleting a password	54
Locking your organizer	54
Recovering from a forgotten password.....	55

Chapter 4: Using Your Basic Applications

Overview of basic applications	58
Date Book.....	58
Address Book	59
To Do List.....	60
Memo Pad.....	61
Calculator.....	61
Expense	62
Common tasks	63
Creating records.....	63
Editing records.....	63
Deleting records.....	65
Purging records.....	66
Exchanging and updating data: HotSync operations	67
Categorizing records.....	69
Finding records.....	73
Sorting lists of records.....	77
Making records private.....	79
Attaching notes.....	80
Choosing fonts	81

Application-specific tasks	83
Date Book	83
Address Book.....	96
To Do List	101
Memo Pad	106
Calculator	109
Expense.....	111

Chapter 5: Query Applications and the iMessenger™ Application

Your organizer is a wireless device	121
Web clipping: query applications	121
Wireless Internet messaging: the iMessenger application	124
The Palm.Net wireless communication service.....	124
Improving signal strength	127
Using query applications	128
Opening query applications	129
Working with query applications.....	130
Query application menus.....	137
Using the iMessenger application	138
The iMessenger application differs from the Mail application.....	138
Opening the iMessenger application	139
Checking for and viewing messages.....	140
Opening and reading messages.....	141
Creating messages.....	146
Rerouting replies to your messages	150
Adding a signature to your message	151
Sending messages	151
Editing an unsent message	152
Draft messages.....	153
Filing a message	154
Deleting messages.....	155
Removing a message from the Deleted folder.....	155
Purging deleted messages	155
Options for the iMessenger List screen.....	156
Your Palm.Net mailbox.....	157
The iMessenger application and HotSync operations	159
iMessenger menus	159

Chapter 6: Managing Desktop E-Mail and Beaming Information

Managing desktop E-Mail away from your desk	163
Setting up Mail on the desktop	164
Synchronizing Mail with your E-Mail application	166
Opening the Mail application on your organizer.....	166
Viewing e-mail items	166

Creating e-mail items.....	167
Looking up an address	170
Adding details to e-mail items	171
Storing e-mail to be sent later	174
Editing unsent e-mail.....	174
Draft e-mail.....	175
Filing e-mail.....	176
Deleting e-mail.....	177
Removing e-mail from the Deleted folder	177
Purging deleted e-mail.....	178
Message List options	178
HotSync options.....	180
Creating special filters	181
Truncating e-mail items.....	185
Mail menus.....	185
Beaming information	187

Chapter 7: Advanced HotSync® Operations

Selecting HotSync setup options.....	189
Customizing HotSync application settings	192
HotSync operations via a modem.....	194
Preparing your computer.....	194
Preparing your organizer	195
Selecting the conduits for a modem HotSync operation	196
Performing a HotSync operation via a modem.....	197
HotSync operations via a network.....	198
Connecting to your company's dial-in server	198
Using File Link.....	200
Creating a user profile	200

Chapter 8: Setting Preferences for Your Organizer

Viewing preferences.....	204
Buttons preferences	204
Pen preferences	205
HotSync buttons preferences	206
Digitizer preferences	207
Formats preferences.....	207
Country default.....	207
Time, date, week start, and numbers formats	208
General preferences.....	209
Auto-off delay	209
System, alarm, and game sounds.....	209
Beam Receive.....	210
Modem preferences.....	211

Network preferences and TCP/IP software	212
Selecting a service	212
Entering a user name	213
Entering a password	213
Adding telephone settings	214
Connecting to your service	217
Creating additional service templates	217
Adding detailed information to a service template	218
Creating a login script	221
Deleting a service template.....	222
Network preferences menu commands.....	222
TCP/IP troubleshooting.....	223
Owner preferences.....	224
ShortCuts preferences	225
Creating a ShortCut	225
Editing a ShortCut	226
Deleting a ShortCut	226
Wireless preferences.....	227
Proxy	227
Sending ID or location information.....	228

Appendix A: Maintaining Your Organizer

Caring for your organizer	229
About the AAA batteries	230
Automatic recharging of the transmitter.....	231
Proper use of the antenna	233
Resetting your organizer.....	235
Performing a soft reset	235
Performing a hard reset.....	236

Appendix B: Frequently Asked Questions

Software installation problems	239
Operating problems.....	240
Tapping and writing problems	241
Wireless problems.....	242
Application problems.....	243
HotSync problems.....	244
Beaming problems	248
Password problems	249
Technical support and customer care	250

Appendix C: Creating a Custom Expense Report

About mapping tables	251
Customizing existing sample templates.....	252

Determining the layout of the Expense Report.....	253
Labels.....	253
Sections.....	254
Analyzing your custom Expense Report	255
Programming the mapping table	256
Using applications other than Microsoft Excel	260
Expense file details.....	261
Appendix D: Non-ASCII Characters for Login Scripts	
Use of ^char.....	263
Carriage return and line feed.....	263
Literal characters	264
Palm.Net™ Service Agreement, Warranty, and Other Product Information	
Palm.Net service agreement	265
Limited warranty.....	273
3Com end user software license agreement	276
FCC Statement	279
Canadian RFI Statement.....	279
Index	281

About This Book

Welcome to the Palm VII™ connected organizer. This handbook describes all you need to know about how to use your Palm VII organizer and the applications that come with it. It walks you through viewing and entering data, using the features of the Palm.Net™ wireless communication service, using your Palm VII organizer with your computer, and personalizing your organizer with your own preferences.

This book is designed to help you get up and running quickly on your organizer. The beginning chapter explains the following:

- All the parts of your organizer
- The Palm VII interface
- The Palm VII wireless features
- Entering data
- Setting up security and other preferences

After you become familiar with the basic functionality, you can use the rest of this handbook as a reference for less common tasks and for maintaining your organizer, and also as a source of information if you have problems operating the organizer.

Chapter 1

Introduction to Your Palm VII™ Organizer

This chapter explains the physical buttons and controls on your Palm VII™ connected organizer, how to set up your organizer and charge the transmitter, how to use your organizer for the first time, and how to use HotSync® technology to synchronize your organizer and Palm™ Desktop organizer software. This chapter also introduces the Palm.Net™ wireless communication service and the wireless features of the Palm VII organizer.

Getting to know your Palm VII organizer

What is a Palm VII organizer?

With your Palm VII organizer you will no longer have trouble getting to meetings and appointments on time, or remembering the names and personal details of the people you connect with. It will be easy for you to remember all the items on your to do list. The organizer can help you improve your track record in all these areas, both at work and at home.

You can enter all your schedule details in Date Book so you can view them by the day, week, or month; you can even set an alarm to remind you of important meetings. Keep all your contact names, addresses, phone numbers, and other details in Address Book, so you can find them as soon as you need them. Add your tasks to To Do List, prioritize them so you don't overlook them, and assign them a due date.

Your Palm VII organizer can be easily connected to the Internet, without using a wire or an external modem, through a wireless communication service maintained by 3Com. Using applications called query applications, you can access a wide spectrum of information available on the Internet and view that information in a format that is easy to read on your organizer screen. Another application, the iMessenger™ application, gives you an Internet messaging address; so you can use your Palm VII organizer to stay

connected by wireless Internet messaging anytime, anywhere within the coverage area of the wireless communication service.

To make sure you don't lose any important information, you can synchronize your data with Palm Desktop software on your computer so you always have a backup copy. You can set different levels of security for your organizer so unauthorized eyes cannot view your data.

When you are out of the office, track your expenses for your expense reports; then transfer the data to your computer to print it out. You can write, edit, and view your e-mail, and then synchronize your e-mail with your desktop E-Mail application when you return to your office.

System requirements

To install and operate Palm Desktop software, your computer system must meet the following requirements:

Minimum requirements

- Windows 98, Windows 95, or Windows NT 4.0
- IBM-compatible 486 computer or higher
- 8 MB RAM (memory) *minimum*, 16 MB recommended (required with Windows NT 4.0)
- 20 MB available hard disk space
- VGA monitor or better (the Quick Tour requires a 256 color video display)
- CD-ROM drive (you can also download Palm Desktop software from <http://www.palm.net>, or order 3.5" diskettes from 3Com)
- Mouse
- One available serial port

See "Activating the Palm.Net wireless communication service" later in this chapter for information on what is required to activate the service.

Optional equipment

- Palm Modem[®] accessory
- Windows-compatible printer

Macintosh compatibility

You can connect your Palm VII organizer to your Macintosh using Palm™ MacPac version 2 or higher (sold separately). For more

information about Macintosh compatibility, visit the web site <http://www.palm.net>.

Palm VII components

Locating front panel controls

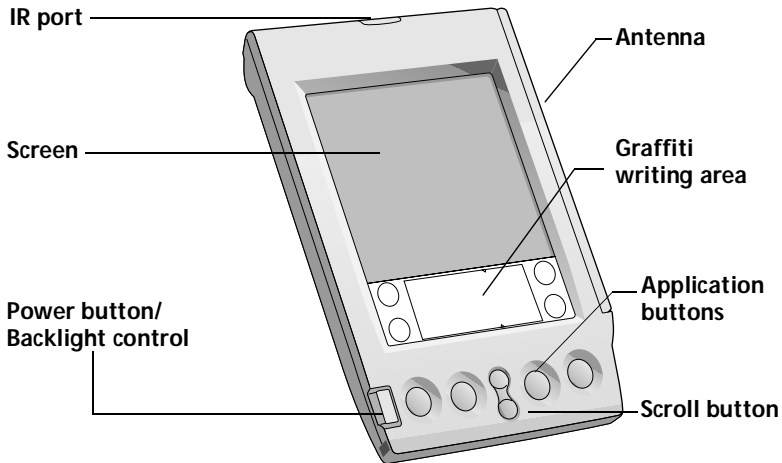

Screen Displays the applications and information stored in your organizer. It is touch-sensitive and responds to the stylus.

Graffiti® writing area The area where you write letters and numbers using the Graffiti® alphabet. See Chapter 2 to learn how to write Graffiti characters.

Application buttons Open the individual organizer applications that correspond to the icons on the buttons: Date Book, Address Book, To Do List, and Memo Pad. See “Buttons preferences” in Chapter 8 for details on reassigning these buttons to activate any application on your organizer.

Tip: If your organizer is turned off, pressing any application button activates your organizer and opens the corresponding application.

Scroll button Displays text and other information that extends beyond the area of the Palm VII organizer screen. Pressing the lower half of the scroll button scrolls down to view information below the viewing area, and pressing the upper half of the button scrolls up to view the information above the viewing area.

**Power button/
Backlight
control** Turns your organizer on or off and controls the backlight feature.
If your organizer is turned off, pressing the power button turns the organizer on and returns you to the last screen you viewed. Press the power button to turn the organizer off.

If you have difficulty seeing the information onscreen, use the backlight to illuminate the screen. Press the power button and hold it down for about two seconds to turn the backlight on or off.

You can assign the full-screen pen stroke to activate the backlight. See “Pen preferences” in Chapter 8 for more information.

IR port Uses infrared technology to transmit data to and receive data from other Palm Computing® platform devices that also have an IR port. See “Beaming information” in Chapter 6 for more information.

Antenna Gives you access to the Palm.Net service. See Chapter 5 for more information. See “Buttons preferences” in Chapter 8 to learn how to open a specific application when you raise the antenna.

Whenever you use the wireless features of your organizer, please observe the guidelines or prohibitions on the use of wireless devices in your current location. For example, when you are on an airplane, do not raise the antenna or use the wireless features at times when the Federal Aviation Administration (FAA) or airline regulations prohibit the use of cellular phones. You can, of course, use all other applications of your organizer in accordance with airline regulations for electronic devices.

Locating back panel components

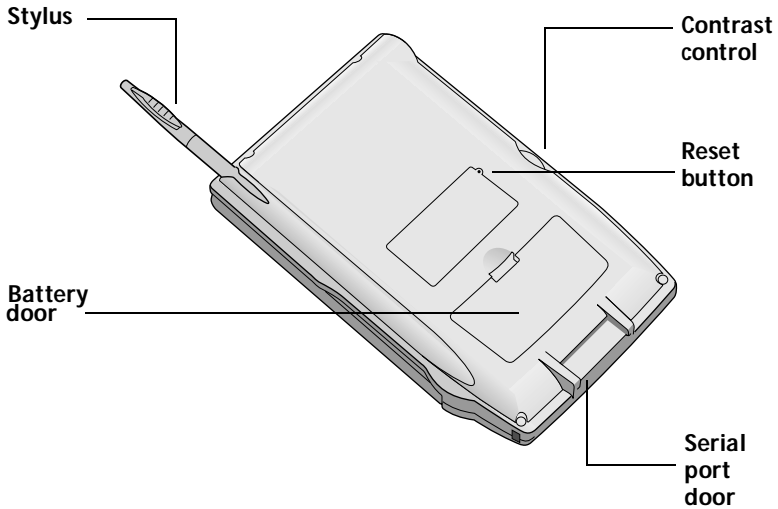

- Stylus** Slides in and out of the slot in the back panel of the organizer. To use the stylus, remove it from the slot and hold it as you would a pen or pencil. Unscrew the top of the stylus to access the reset tool.
- Reset button** Under normal use, you should not have to use the reset button. See Appendix A for information about when and how to use the reset button.
- Contrast control** Adjusts the appearance of the screen for the clearest screen display. Depending on the lighting conditions or temperature of the environment where you use your organizer, you may need to adjust the setting of the contrast control.
- Battery door** Covers the AAA batteries that power your organizer and charge the transmitter. See “Installing the batteries” later in this chapter for information on removing the battery door and installing batteries.

Serial port door Protects the serial port that fits into the connector of the organizer cradle. The door ensures that the connection surface of the serial port remains clean and clear of debris.

Note: When your organizer is in the cradle, and the cradle is connected to your computer, you can use HotSync technology to do a two-way exchange of the data on your organizer and your computer. Plug the connector of the cradle into the serial (COM) port, as shown in the following illustration.

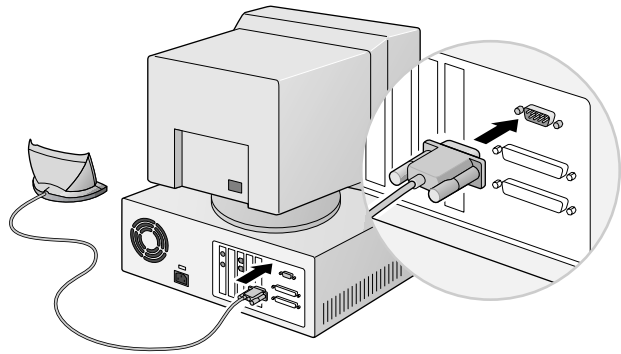

Important: Your organizer requires a dedicated port. It cannot share a port with an internal modem or other device. If you are unsure about the location of the serial port on your computer, refer to your computer's documentation.

Installing the batteries

To use your organizer, you must install two AAA alkaline batteries. The batteries fit behind the battery door on the back of the organizer.

To install the batteries:

1. Press the tab on the battery door and lift the battery door away from the organizer.

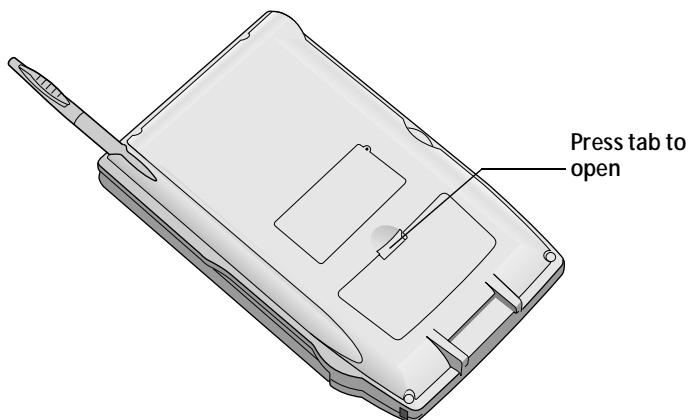

2. Install the two AAA alkaline batteries supplied with your organizer into the battery compartment.

Note: A diagram in the interior of the battery compartment shows the orientation of the positive (+) and negative (-) ends of the batteries. When correctly installed, the clips in the battery compartment secure the batteries in place.

3. Insert the battery door back into place so that it is flush with the back of the organizer and “clicks” into position.

Important: Do not force the battery door. When the batteries are correctly installed, the battery door clips smoothly into place. If you feel resistance when replacing the battery door, make sure the door is aligned with the slots on the back of your organizer, and that the batteries are firmly seated in the battery compartment.

Replacing batteries

Under normal conditions, depending on your usage pattern, the AAA batteries of your organizer should provide weeks of use. When the time comes to replace the AAA batteries, your organizer gives you ample warning.

When you replace the AAA batteries, keep these points in mind:

- Before you replace the batteries, perform a HotSync operation so that you have a backup copy of all your data on your computer.
- When you remove the old batteries, the built-in backup power of your organizer maintains memory data. Whenever you remove the batteries, replace them immediately. We recommend replacing batteries within a **period of one minute**. If you encounter any difficulties or delays while you're replacing the batteries, reinstall the original batteries and wait a few minutes for the backup power to recharge.
- When you dispose of the AAA batteries, please dispose of them without damaging the environment.

Setting up your organizer and charging the transmitter

The first time you insert the AAA batteries, your organizer automatically begins two processes:

- The batteries begin to charge the transmitter you use with the wireless communication service. **This takes about 70 minutes.** As soon as the transmitter has been charged, you can activate the service. See “Activating the Palm.Net wireless communication service” later in this chapter.
- Your organizer turns on automatically and Setup begins. Setup consists of a short series of screens that you complete to prepare your organizer for use. Setup also lists the query applications that are preloaded on your organizer. To complete Setup, follow the instructions onscreen.

As soon as you finish Setup, you can use all the basic applications of your organizer. See Chapter 4 for the list of your basic applications.

Upgrade information

If you already own a PalmPilot™ organizer or Palm III™ organizer, 3Com recommends that you install the version of Palm Desktop software that comes with your new Palm VII organizer into the same folder as your current Palm Desktop software. When you install the new version in the same folder as the previous version, all your data is preserved.

If you use another personal information manager (PIM), you still need to install Palm Desktop software in order to add HotSync Manager,

conduit software, and other features of Palm Desktop software to your computer.

You perform HotSync operations in exactly the same way, so you can quickly synchronize your old data with your new organizer.

To upgrade:

1. Read the *Getting Started* guide for an overview of the complete installation process.
2. (Optional) To ensure against any data loss, go to the folder that stores Palm Desktop software, copy your username folder, and store the copy outside the Palm Desktop software folder.
3. Synchronize your old organizer with your old Palm Desktop software.

This ensures that the latest information from your organizer is on your desktop computer.

4. Follow the installation instructions in “Installing Palm Desktop software” later in this chapter.

Be sure to install the new software in the same folder as the old software.

5. To prepare for the first HotSync operation that synchronizes your new organizer with your new Palm Desktop software, go to the HotSync Manager and choose Custom.

Note: Be sure your username appears in box at the top of the Custom dialog box. If not, select your username.

6. For all conduits, click Change and select the option Desktop overwrites handheld. Then click Done.

See “Customizing HotSync application settings” in Chapter 7 for more information.

7. Place your new organizer in the cradle and press the HotSync button.
8. If the Select User dialog box appears, select your username.
9. Return to the *Getting Started* guide and complete the activation of your organizer.

Each organizer must have a unique name

After you complete the upgrade process described above, you have two organizers with the same name. This is an undesirable situation.

Each organizer must have a unique name in order to prevent unexpected results during HotSync operations and other complications.

We strongly recommend that you perform a hard reset on your old organizer. See “Performing a hard reset” in Appendix A for details.

A hard reset not only erases all data from the old organizer; it also erases the name and makes that organizer a clean slate, ready to receive a new name. The next time you perform a HotSync operation with this old organizer, you are asked to give it a name. Be sure to give it a unique name.

Palm Desktop organizer software

Palm Desktop software extends many of the functions of your organizer to your computer and serves to back up all your data. Viewing and editing your data using Palm Desktop software is optional. However, when you use it with your organizer and the built-in HotSync technology, you can fully synchronize the information on your organizer with the information on your computer.

It is a good idea to back up your data in case something happens to the data on your organizer. Changes you make on your organizer or Palm Desktop software appear in both places after you synchronize.

With Palm Desktop software, you can do the following:

- Work with your organizer applications on your computer. Palm Desktop software duplicates the Date Book, Address Book, To Do List, and Memo Pad applications on your organizer, so you can view, enter, and modify any data stored on your organizer.
- Back up the data stored on your organizer with HotSync technology and synchronize the data on your Palm Desktop software. Synchronization is a one-step procedure that ensures your data is always safe and up-to-date. See “Exchanging and updating data: HotSync operations” in Chapter 4 for more information.
- Import and export data. See “Importing data” in Chapter 2 for more information.
- Print your Date Book, Address Book, To Do List, and Memo Pad information on any printer.

Installing Palm Desktop software

The following instructions guide you through installing Palm Desktop software. After installation, refer to the online Help in Palm Desktop software for information about how to use the software.

To ensure a safe and uninterrupted installation of Palm Desktop software, please do the following before installing:

- Turn off your computer and connect the cradle to it. **Do not** put the organizer in the cradle yet; you do that later in the process.
- If you install from diskettes, make sure the original Palm Desktop software diskettes are write-protected, and then make backup copies of them. When you finish, install using the copies.
- Do *not* simply copy the Palm Desktop software files to your computer's hard disk. You must use the installer to place the files in their proper locations and to decompress the files.

To install Palm Desktop software:

1. Exit any open programs, including those that run automatically at startup. Disable any virus-scanning software.
2. Insert the Palm Desktop software CD-ROM into the computer's CD-ROM drive (or insert the diskette labeled Setup into the diskette drive).
3. Click the Install button to begin the installation program.
4. Follow the onscreen instructions to complete the installation. During installation you will be asked to insert your organizer into the cradle.

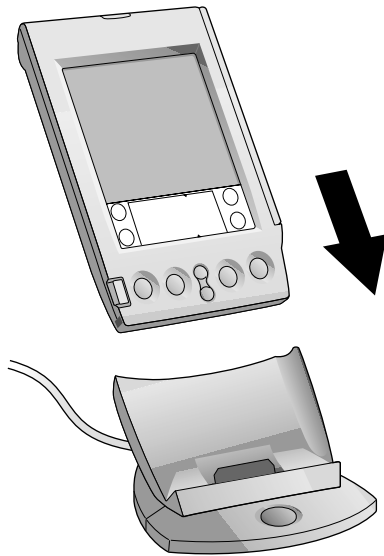

Using your organizer with another PIM

If you prefer to use another personal information manager (PIM), such as Microsoft Outlook, you still need to install Palm Desktop software in order to add HotSync Manager, connection software, and other features of Palm Desktop software to your computer. The connection software, called a conduit, lets you synchronize the data between your organizer and your PIM.

If the installation program detects that you have Microsoft Outlook on your computer, the program lets you choose between installing Palm Desktop software or installing the conduit for Outlook so that you can use that application as your PIM.

For information on the availability of conduit software for the PIM you use, contact the vendor of your PIM or visit the web site <http://www.palm.com>.

Palm.Net wireless features

Your organizer is equipped with a transmitter and an antenna that let you transmit and receive data over the airwaves. 3Com provides the Palm.Net wireless communication service, which you must subscribe to in order to gain access to wireless features.

After you activate the wireless communication service, the two new wireless features become available to you:

- Web clipping, using query applications
- Wireless Internet messaging, using the iMessenger application

Activating the Palm.Net wireless communication service

The transmitter inside your organizer contains a rechargeable battery that must be charged before you can activate the wireless communication service and use the wireless features. The AAA batteries that you install during Setup of your organizer charge the transmitter, and charging begins as soon as you insert the batteries. Charging takes about 70 minutes.

Before you activate the Palm.Net service, be sure of the following:

- You're within coverage of the network. To find detailed maps of coverage, visit the web site <http://www.palm.net>.
- You're in a location that can receive a strong radio signal. See "Wireless problems" in Appendix B for tips on eliminating obstacles to the signal.

To activate the Palm.Net service:

1. Read the brochure, *Choosing a Palm.Net Service Plan*, included in the organizer package, describing the monthly service plans. Decide on a plan. (You can switch plans at any time.)
2. Prepare to enter the following information: your name, firm, billing address, phone number, current desktop e-mail address, choice of service plan, and credit card information (or corporate account number).

During activation you are also asked to create a username and a password. You can accept one of the usernames suggested by the Activate application or create your own; it must be at least 3 characters long. Your password must be 4 to 15 characters long.

3. Read the Palm.Net service agreement, located at the back of this book.
4. When the charging of the transmitter is finished, raise the antenna on the right side of your organizer by gently rotating it upwards.

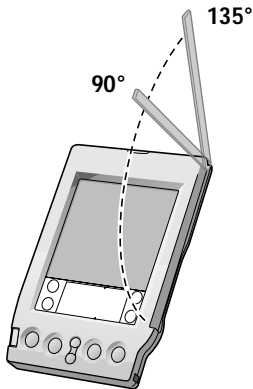

To ensure the best reception: If you are holding the organizer in your hand, raise the antenna to its position at 135°, located at the second click you feel as you raise the antenna. If the organizer is on a flat surface, raise the antenna to its position at 90°.

5. Follow the instructions onscreen to activate the wireless communication service.

Important: Be sure to record and remember the username and password you create during activation. You need them both to access information about your usage of the service and your billing information. Your username is also part of your address on the Palm.Net network — for example, `username@palm.net`.

Web clipping

Your organizer includes special kinds of applications called *query applications*. Query applications take advantage of the wireless functionality of the organizer to give you access to information on the Internet.

Query applications give you access to a wide spectrum of practical Internet information: news and business headlines, travel information, stock quotes, sports scores, restaurant reviews, movie times, and much more.

It's impractical, however, to browse the Internet from a small handheld computer and look at elaborate, animated, graphics-laden web pages on a screen the size of your organizer's. So instead of web browsing, query applications offer you a more efficient way to access the Internet, called *web clipping*.

In general, web clipping is a simple process of query-and-response. You simply request information, tap a button that transmits your request to the Internet, and within seconds, you receive a response. See Chapter 5 for more information.

Wireless Internet messaging

Like web clipping, the iMessenger application takes advantage of the wireless functionality of your organizer to give you wireless Internet messaging. Your organizer, like a cellular phone, uses a radio frequency to transmit and receive information. Your organizer is part of the Palm.Net network, which receives and stores messages sent to you at your @palm.net address, and delivers messages you send from your organizer to the recipient's Internet e-mail address.

After you activate the wireless communication service, whenever you're within the coverage area, you can communicate with anyone who has an Internet e-mail account. See Chapter 5 for more information.

Tapping and typing

Tap with the stylus to get things done

Like using a mouse to click elements on a computer screen, using the stylus to tap elements on your organizer screen is the basic action that gets things done on your organizer.

The first time you start your organizer, setup instructions appear on the screen. These instructions include a calibration screen, or digitizer. Calibration aligns the internal circuitry of your organizer with its touch-sensitive screen so that when you tap an element on the screen, the organizer can detect exactly which task you want to perform.

Important: Always use the point of the stylus for tapping or making strokes on the organizer screen. Never use an actual pen, pencil, or other sharp object to write on the organizer screen.

With your organizer turned on, you can tap the organizer screen to do many operations, such as the following:

- Open applications
- Submit queries to the Internet
- Check for and send messages in the iMessenger application
- Choose menu commands
- Initiate a global Find operation
- Select options in dialog boxes
- Open the onscreen keyboard

Just as you can drag the mouse to select text or move objects on your computer, you can also drag the stylus to select text. You can also use the stylus to drag the slider of any scroll bar.

Elements of the organizer interface

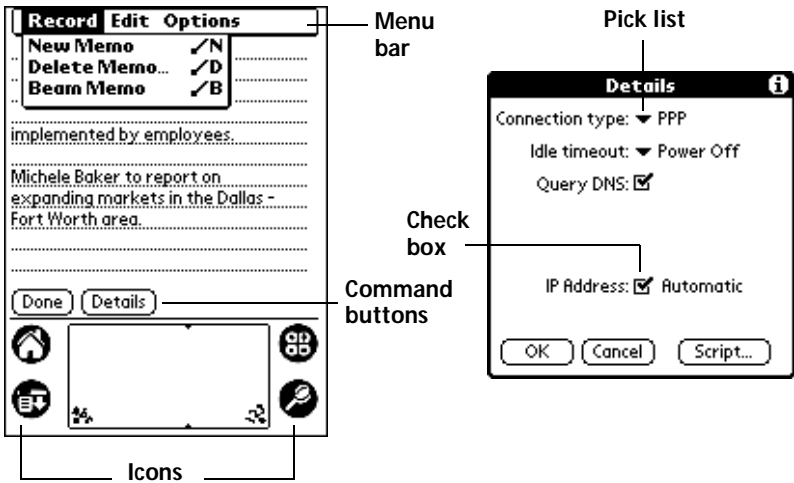

Menu bar A set of commands that are specific to the application. Not all applications have a menu bar.

Command buttons Tap a button to perform a command. Command buttons appear in dialog boxes and at the bottom of application screens. A command button that initiates a wireless transaction always displays the over-the-air icon:

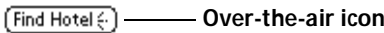

Icons Tap the icons to open applications (Home, Back, Forward, Search), menus (Menu), and Calculator (Calculator), and to find text in the data of your basic applications (Search).

abc With the cursor in an input field, tap the dot to activate the alphabetic keyboard.

123 With the cursor in an input field, tap the dot to activate the numeric keyboard.

Check box When a check mark appears in a check box, the corresponding option is active. If a check box is empty, tapping it inserts a check mark. If a check box is checked, tapping it removes the check mark.

Pick list Tap the arrow to display a list of choices, and then tap an item in the list to select it.

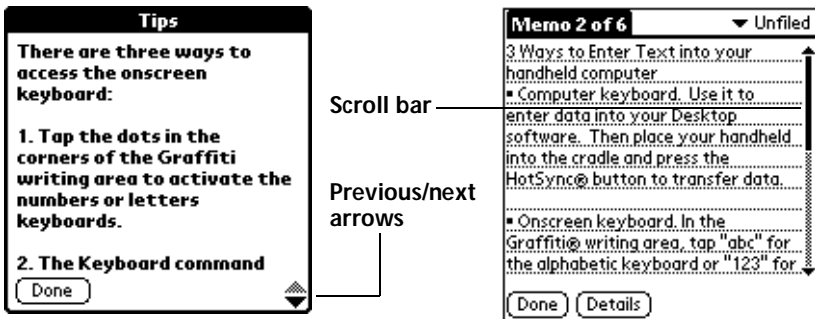

Scroll bar Drag the slider, or tap the top or bottom arrow, to scroll the display one line at a time. To scroll to the previous page, tap the scroll bar just above the slider. To scroll to the next page, tap the scroll bar just below the slider.

You can also scroll to the previous and next pages by pressing the upper and lower portions of the scroll button on the front panel of the organizer.

Previous/next arrows Tap the up and down arrows to display the previous and next page of information; tap the left and right arrows to display the previous and next record.

Opening applications

You can use the Applications Launcher to open any application installed on your organizer. You can also open the four main applications — Date Book, Address Book, To Do List, and Memo Pad — with the application buttons on the front panel of your organizer.

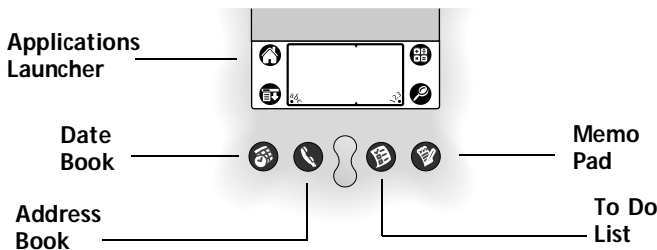

Tip: When you press an application button on the front panel, you have instant access to the selected application. You don't even need to turn on your organizer first.

In addition to providing a way for you to open applications, the Applications Launcher displays the current time, battery level, and application category.

To open an application:

1. Tap the Applications icon .
2. Tap the icon of the application that you want to open. If you have many applications installed on your organizer, tap the scroll bar to see all of your applications.



Tip: To find an application quickly, you can write the Graffiti character for the first letter of its name. The Applications Launcher scrolls to the first application with a name that begins with that letter. You can also assign applications to different categories. See “Categorizing applications” in Chapter 3.

To open an application that uses the antenna:

These applications use the antenna:

- All query applications
 - iMessenger application
 - Applications that support your use of the wireless features
1. Raise the antenna, located on the right side of your organizer.

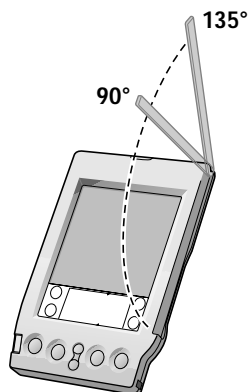

To ensure the best reception: If you are holding the organizer in your hand, raise the antenna to its position at 135°, located at the second click you feel as you raise the antenna. If the organizer is on a flat surface, raise the antenna to its position at 90°.

Raising the antenna automatically opens the Applications Launcher to the Palm.Net category. When the transmitter successfully connects to the network, your organizer beeps.

2. Tap the query application that queries the Internet for the kind of information you want.

Tip: You can set your organizer to open a specific application whenever you raise the antenna. See “Buttons preferences” in Chapter 8 for details.

When you install query applications, they appear by default in the Palm.Net category of the Applications Launcher. The icons of query applications and all applications that use the antenna are easy to recognize: They all have a dark diamond shape as their background and include the over-the-air icon:

◆ Background of all query application icons



Sample query application icon

Feel free to explore all your query applications to find out what kind of information they offer. Despite the presence of the over-the-air symbol in its icon, you can open any query application without incurring any cost.

Using menus

Menus on your organizer are easy to use. Once you have mastered them in one application, you can use them the same way in all other applications.

The menus of each application are illustrated in the section on that application in Chapter 4. The Edit menu is described in “Editing records” in Chapter 4.

To open the menu bar:

1. Open an application (such as Memo Pad).
2. Tap the Menu icon .

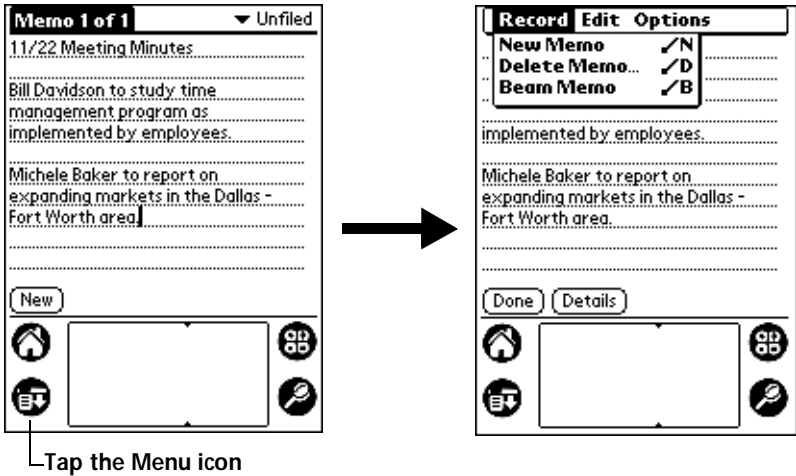

In this example, three menus are available: Record, Edit, and Options. The Record menu is selected and contains the commands New Memo, Delete Memo, and Beam Memo.

Choosing a menu

After you open the menu bar for an application, tap the menu that contains the command you want to use.

The menus and menu commands that are available depend on the application that is currently open. Also, the menus and menu commands vary depending on *which part* of the application you're currently using. For example, in Memo Pad, the menus are different for the Memo List screen and the Memo screen.

Graffiti menu commands

Most menu commands have an equivalent Graffiti Command stroke, which is similar to the keyboard shortcuts used to execute commands on computers. The command letters appear to the right of the command names.



To use the Graffiti menu commands, the menu bar must be closed. Draw the Command stroke anywhere in the Graffiti area, and immediately write the corresponding command letter in the Graffiti letter area. When you draw the Command stroke, the word “Command” appears just above the Graffiti writing area to indicate that you are in Command mode.



For example, to choose Select All in the Edit menu, draw the Command stroke, followed by the letter “s.”

Note: Command mode is active for approximately two seconds, so you must write the command letter immediately to choose the menu command.

Displaying online tips

Many of the dialog boxes that appear on your organizer contain a Tips icon in the upper-right corner. Online tips anticipate questions you have in a dialog box, provide shortcuts for using the dialog box, or give you other useful information.

To display an online tip:

1. Tap the Tips icon .
2. After you review the tip, tap Done.

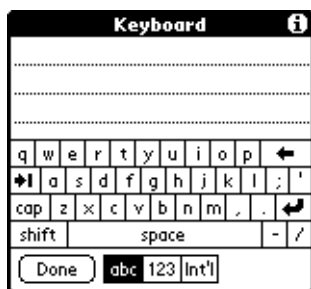

Three ways to enter data

There are three ways to enter data into your organizer:

- Using the onscreen keyboard
- Using Graffiti writing
- Entering or importing data in Palm Desktop software and then synchronizing with your organizer

Onscreen keyboard

When you create or edit a record in an application such as Address Book, you can open the onscreen alphabetic and numeric keyboards to enter data.

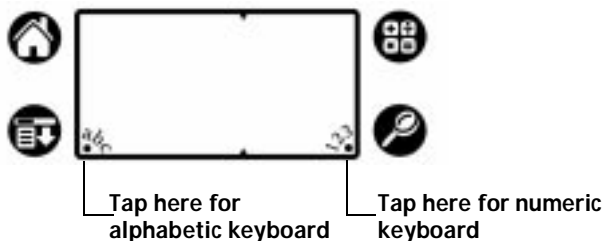

After a keyboard is open, you can tap to open any of the other keyboards, including the international keyboard. See “Using the onscreen keyboard” in Chapter 2 for more information.

Note: You cannot enter Graffiti characters while using the onscreen keyboard.

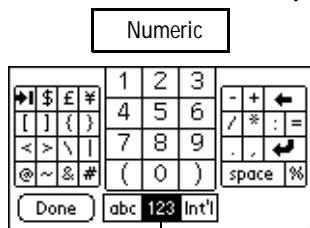
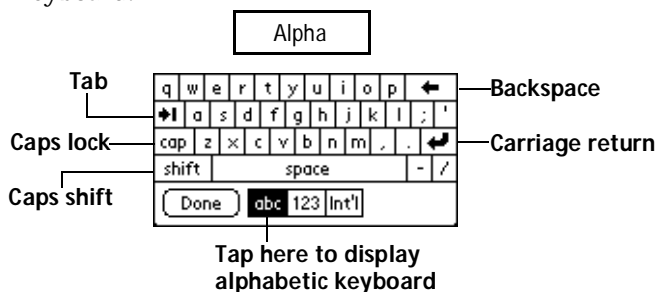

Tap here to display numeric keyboard

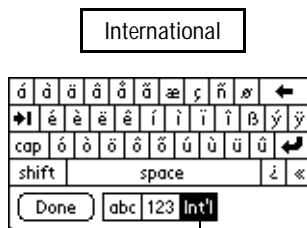

Tap here to display international keyboard

Graffiti writing

Your organizer includes Graffiti writing software as the primary system for entering text and numbers. With Graffiti writing, you write simple strokes with the stylus and they are instantly recognized as letters or numbers.

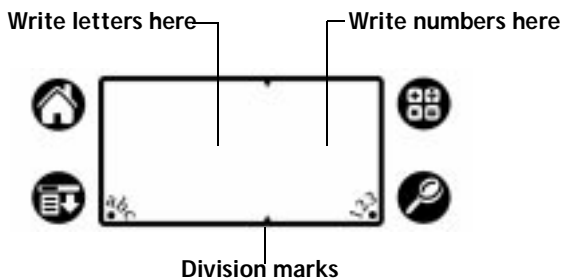

Your organizer also includes Giraffe, a game you can use to practice writing Graffiti characters. See “Installing and removing applications” in Chapter 3 for installation instructions. The Memo Pad application is ideal for practicing Graffiti writing. This section explains how to open Memo Pad and use it to practice Graffiti writing.

To open Memo Pad:

1. Press the Memo Pad application button .
2. Tap New.

Note: A blinking cursor appears on the first line of the new memo to indicate where new text will appear.

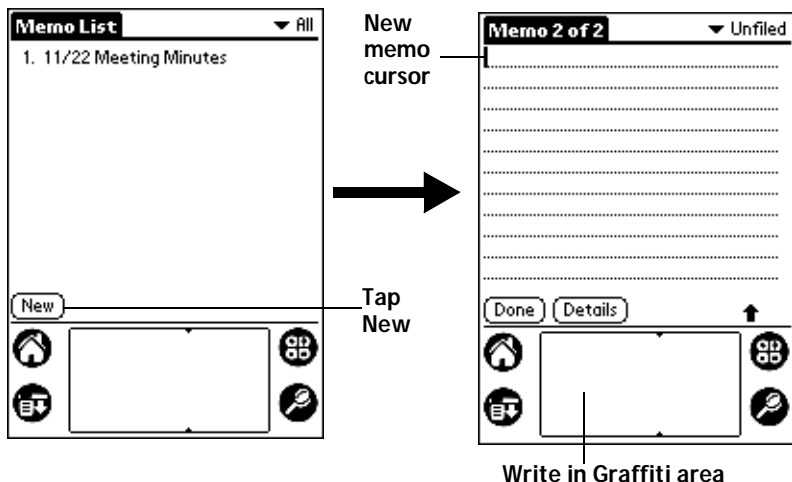

See “Using Graffiti writing to enter data” in Chapter 2 for more information.

Using Palm Desktop software

If you have new records you want to add to your organizer and prefer to use the computer keyboard rather than the onscreen keyboard, enter the data in the Palm Desktop software or the PIM you have installed to use with your organizer.

If you already have data in a database on your computer, you can import it into Palm Desktop software.

After the information is in Palm Desktop software, perform a HotSync operation to synchronize your organizer with your computer. See “Exchanging and updating data: HotSync operations” in Chapter 4 for more information.

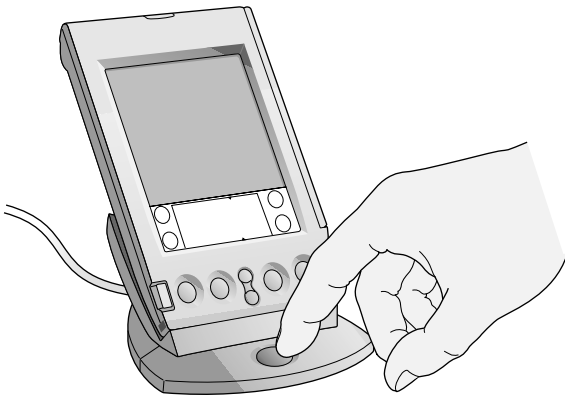



Importing data

If you have data stored in computer applications such as spreadsheets and databases, or if you want to import data from another organizer, you can transfer the records to your organizer without having to key them in manually. See “Importing data” in Chapter 2 for more information.

Customizing your organizer

You can customize your organizer by using the Preferences application. You can enter personal information such as your name and address; change the time and date, and view different date and time formats when you travel; turn off sounds; and configure your organizer to work with a modem or network. See Chapter 8 for more information on customizing your organizer.

To open the Preferences screens:

1. Tap the Applications icon .
2. Tap the Preferences (Prefs) icon .
3. Tap the category pick list in the upper-right corner of the screen.
4. Tap the Preferences category you want to view.

The following procedures for setting the time and date give you an example of how to customize your organizer.

You make changes to the time and date in General preferences.

To set the current time:

1. Tap the Set Time box.

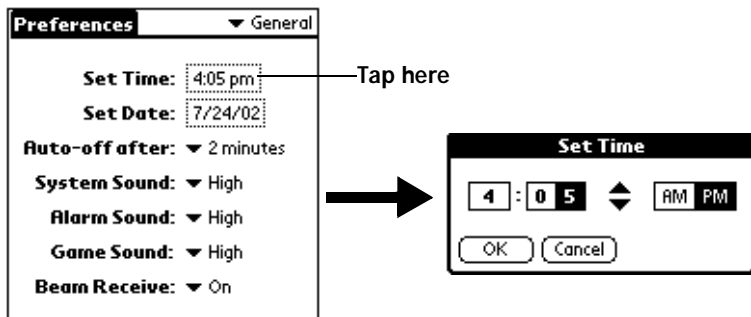

2. Tap the up or down arrows to change the hour.
3. Tap each number of the minute, and then tap the arrows to change them.
4. Tap AM or PM.

Note: Your organizer can also display time based on a 24-hour clock. See “Formats preferences” in Chapter 8 for more information.

5. Tap OK.

To set the current date:

1. Tap the Set Date box.
2. Tap the arrows to select the current year.

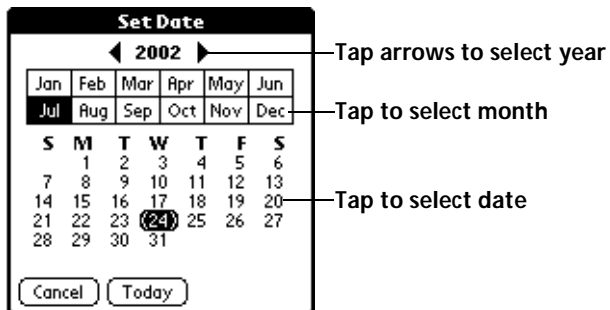

3. Tap a month.
4. Tap the current date.

Chapter 2

Entering Data in Your Palm VII™ Organizer

This chapter explains how to enter data into your Palm VII™ organizer, by writing with the stylus in the Graffiti® writing area, by using the onscreen keyboard, by using the computer keyboard, or by importing data from another application.

Using Graffiti writing to enter data

Chapter 1 introduced Graffiti writing and briefly described how to use it to enter text in your applications. In this section, you learn the procedures for creating Graffiti characters as well as some Graffiti tips and tricks.

Writing Graffiti characters

Most people find they can enter text quickly and accurately with only minutes of practice. Graffiti writing includes any character you can type on a standard keyboard. The Graffiti strokes closely resemble the uppercase letters of the regular alphabet, which makes Graffiti writing easy to learn.

There are four basic concepts for success with Graffiti writing:

- If you draw the character shape exactly as shown in the tables later in this chapter (like the shapes shown in the following diagram), you achieve 100% accuracy.



- The heavy dot on each shape shows where to begin the stroke. Certain characters have similar shapes, but different beginning and end points. Always begin the stroke at the heavy dot (you should not create the heavy dot; it is only there to show you where to begin the stroke).

- Most characters require only a single stroke. When you lift the stylus from the Graffiti writing area, your organizer recognizes and displays the text character immediately. To accomplish single strokes, some Graffiti strokes are portions of the regular alphabet equivalents.
- The Graffiti writing area is divided into two parts: one for writing the letters of the alphabet and one for writing numbers. The small marks at the top and bottom of the Graffiti writing area indicate the two areas.

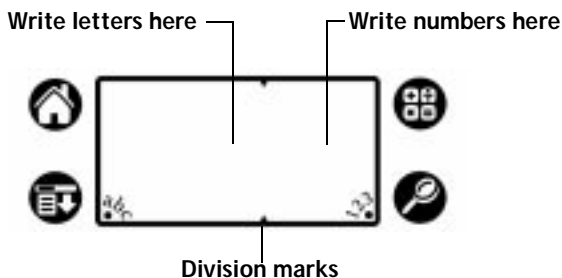

To write Graffiti letters:

1. Tap the screen where you want your text to go.

Note: You need to tap above the Graffiti writing area, and you must see a blinking cursor before you write the text.

2. Use the tables on the following pages to find the stroke shape for the letter you want to create. For example, the stroke shown below creates the letter “n.”

Note: There are two different stroke shapes available for some letters. For these letters, choose the one that’s easiest for you.

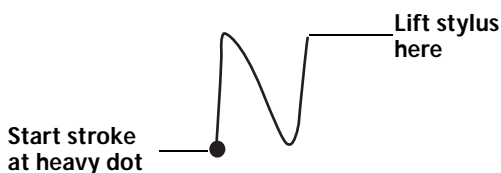

As you’ll see later, you use the same shape to create both the uppercase and lowercase version of a letter.

3. Position the stylus in the left-hand side of the Graffiti writing area.

4. Start your stroke at the heavy dot and draw the stroke shape as it appears in the tables.
5. Lift the stylus from the screen at the end of the stroke shape.

That's all there is to it! When you lift the stylus from the screen, your organizer recognizes your stroke immediately and prints the letter at the insertion point on the screen.

As soon as you lift the stylus from the screen, you can begin the stroke for the next character you want to write.

Important: You must begin the character strokes in the Graffiti writing area. If you do not make Graffiti strokes in the Graffiti writing area, your organizer does not recognize them as text characters.

Graffiti tips

When using Graffiti writing, keep these tips in mind:

- Accuracy improves when you write large characters. You should draw strokes that nearly fill the Graffiti writing area.
- Press firmly.
- To delete characters, simply set the insertion point to the right of the character you want to delete and make the backspace stroke (a line from right to left) in the Graffiti writing area.
- Write at natural speed. Writing too slowly can generate recognition errors.
- Do not write on a slant. Vertical strokes should be parallel to the sides of the Graffiti writing area.

The Graffiti alphabet

Letter	Strokes	Letter	Strokes
A		N	
B		O	
C		P	
D		Q	
E		R	
F		S	
G		T	
H		U	
I		V	
J		W	
K		X	
L		Y	
M		Z	
Space		Back Space	
Carriage Return		Period	<i>tap twice</i>

Writing capital letters

You make capital letters with the same stroke shapes as the basic alphabet characters. To make capital letters, you must first “shift” to caps — just as you press the Shift key on a keyboard — and then write the character strokes.

Note: Graffiti writing includes a feature that automatically capitalizes the first letter when you create a new sentence or a new record (by tapping New or a blank line).

To draw the first letter of a word as a capital letter:

- Use the Caps Shift stroke:



Tip: When Caps Shift is active, an “up arrow” symbol appears in the lower-right corner of the organizer screen. If you accidentally activate Caps Shift, backspace will cancel it.

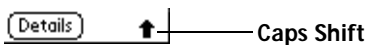

To enter only capital letters (Caps Lock):

- Use the Caps Lock stroke:



Tip: When Caps Lock is active, an underlined “up arrow” symbol appears in the lower-right corner of the organizer screen. To return to lowercase, make the Caps Shift stroke.

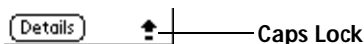

Writing numbers

Writing numbers with Graffiti writing is similar to writing letters of the alphabet, except that you make the character strokes on the right-hand side (numbers side) of the Graffiti writing area.

Graffiti numbers

Number	Strokes	Number	Strokes
0		5	
1		6	
2		7	
3		8	
4		9	

Writing punctuation marks

Graffiti writing can create any punctuation symbol that you can enter from a standard keyboard. All punctuation marks begin with a single tap on the Graffiti writing area. When you make this tap, you activate Punctuation Shift and a dot appears to show it is active. The next stroke you make with the stylus creates a punctuation mark.

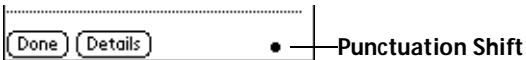

Symbol	Stroke	Symbol	Stroke
Period .		Dash —	
Comma ,		Left Paren (
Apostrophe '		Right Paren)	
Question ?		Slash /	
Exclamation !		Dollar \$	

Additional Graffiti punctuation

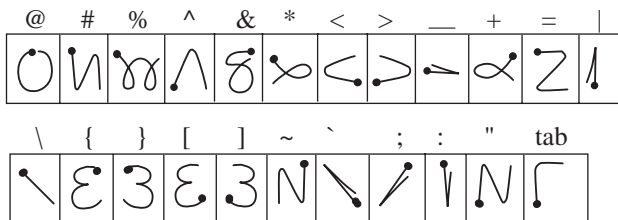

Tip: When Punctuation Shift is active, you can make a symbol stroke anywhere in the Graffiti writing area (the letters *or* numbers side).

Writing symbols and extended characters

All symbols and extended characters begin with the stroke in the Graffiti writing area of your organizer:

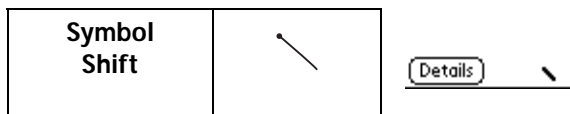

When the Symbol Shift is active, a slanted shift symbol appears in the lower-right corner of the screen. The next stroke that you make creates the symbol or extended character.

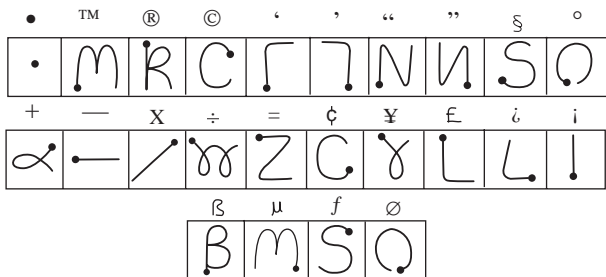
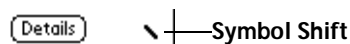

Writing accented characters

To create accented characters, draw the stroke normally used to create the letter, followed by an accent stroke. Graffiti writing then adds the accent to the letter.

For example, the following diagram shows the strokes required to draw an accented “e.”

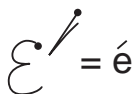

Accent strokes



Using these accent strokes, you can write the following accented letters:

à á â ã ä å è é ê ë ì í î ï ò ó ô õ ö ù ú û ü ý ÿ ñ

Additional non-English characters



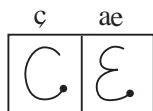

You can write the following characters without any special punctuation or shifting:



Note: You must write these non-English characters in the left side of the Graffiti writing area.

Navigation strokes

In addition to character symbols, Graffiti writing includes special strokes that you can use to navigate within text or fields in your applications.

Command	Stroke
Move cursor right	
Move cursor left	
Previous field	
Next Field	
Open Address Record (Address Book only)	

Graffiti ShortCuts

Graffiti ShortCuts make entering commonly used words or phrases quick and easy. ShortCuts are similar to the Glossary or Autotext features of some word processors.

Graffiti writing comes with several predefined ShortCuts, and you can also create your own. Each ShortCut can represent up to 45 characters. For example, you might create a ShortCut for your name, or for the header of a memo. See “ShortCuts preferences” in Chapter 8 to learn about creating your own ShortCuts.

To use a ShortCut, draw the ShortCut stroke followed by the ShortCut characters. When you draw the ShortCut stroke, the ShortCut symbol appears at the insertion point to show that you are in ShortCut mode.

ShortCut	
----------	---

Your organizer includes the following predefined Graffiti ShortCuts:

Entry	ShortCut
Date stamp	ds
Time stamp	ts
Date/time stamp	dts
Meeting	me
Breakfast	br
Lunch	lu
Dinner	di

Using the onscreen keyboard

You can open the onscreen keyboard anytime you need to enter text or numbers on your organizer. Note that you cannot enter Graffiti characters while using the onscreen keyboard.

To use the onscreen keyboard:

1. Open any application (such as Memo Pad).
2. Tap any record, or tap New.
3. Tap “abc” to open the alphabetic keyboard, or tap “123” to open the numeric keyboard.

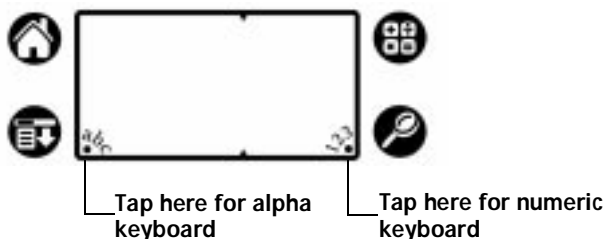

4. Tap the characters to enter text and numbers.

Note: The onscreen keyboard also includes a dialog box for international characters. You can switch among the three dialogs at any time to enter the exact text you need.

5. After you finish, tap Done to close the onscreen keyboard and place the text in the record.

Using your computer keyboard

If you have a lot of data to enter, or prefer to use the computer keyboard, you can use Palm™ Desktop software or any supported PIM to enter information. You can then perform a HotSync® operation to synchronize the information with your organizer. All the main applications on your organizer are also available in Palm Desktop software and in most PIMs, so you don't need to learn different applications.

Refer to Palm Desktop online Help for more information on entering data on your computer.

Importing data

If you have data stored in computer applications such as spreadsheets and databases, or if you want to import data from another organizer, you can transfer the data to your organizer without having to key it in manually. Save the data in one of the file formats listed below, import it into Palm Desktop software, and then perform a HotSync operation to transfer the data to your organizer.

Palm Desktop software can import data in the following file formats:

- Comma delimited (.csv, .txt): Address Book and Memo Pad only
- Tab delimited (.tab, .tsv, .txt): Address Book and Memo Pad only
- CSV (Lotus Organizer 2.x/97 Mapping): Address Book only
- Date Book archive (.dba)
- Address Book archive (.aba)
- To Do List archive (.tda)
- Memo Pad archive (.mpa)

Archive formats can only be used with Palm Desktop software. Use the archive file formats to share information with other people who use organizers based on the Palm Computing® platform.

To import data:

1. Open Palm Desktop software.
2. Click the application into which you want to import data.
3. If you are importing records that contain a field with category names, do the following:

Select All in the Category box.

Be sure that the same categories that appear in the imported file also exist in the application. If the categories do not exist, create them now; otherwise, the records are imported into the Unfiled category.

4. From the File menu, choose Import.
5. Select the file you want to import.
6. Click Open.
7. To import data into the correct Palm Desktop fields, drag fields in the left-hand column so that they are opposite the corresponding imported field on the right.

8. If you do not want to import a field, deselect the check box for that field.
9. Click OK.
The imported data is highlighted in the application.
10. To add the imported data to your organizer, perform a HotSync operation.

See Palm Desktop online Help for more information on importing and exporting data.

Chapter 3

Managing Your Applications

This chapter explains how to switch between applications on your Palm VII™ organizer, how to change application settings so they are personalized to your work methods, and how to categorize applications so you view them in related groups.

Using the Applications Launcher

To open the Applications Launcher, tap the Applications icon .

Selecting applications

Your organizer is equipped with a variety of applications. All the applications installed on your organizer appear in the Applications Launcher. See “Opening applications” in Chapter 1 for details.



Switching between applications

When working in any application, tap the Applications icon  or press an application button on the front panel of your organizer to switch to another application. Your organizer automatically saves your work in the current application and displays it when you return to that application.

Categorizing applications

The category feature enables you to manage the number of application icons that appear onscreen in the Applications Launcher. You can assign an application to a category and then display a single category or all of your applications.

To categorize an application:

1. Tap the Applications icon .
2. Tap the Menu icon .
3. Tap App, and then tap Category.
4. Tap the pick list next to each application to select a category.



Tip: To create a new category, tap Edit Categories from the pick list. Tap New, enter the category name, and then tap OK to add the category. Tap OK.

5. Tap Done.

To display applications by category:

1. Tap the Applications icon .
2. Do one of the following:



Tap the Applications icon repeatedly to cycle through all your categories.

Tap the pick list in the upper-right corner of the screen and select the category you want to display.

Changing the Applications Launcher display



By default, the Applications Launcher displays each application as an icon. As an alternative, you can choose to show a list of applications. You can also choose to view the same category of applications each time you open the Applications Launcher.

To change the Applications Launcher display:

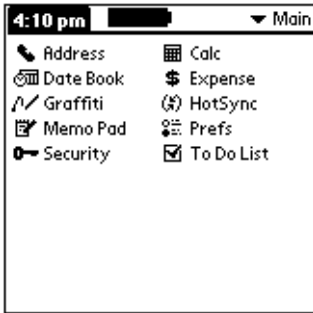
1. Tap the Applications icon .
2. Tap the Menu icon .
3. Tap Options, and then tap Preferences.
4. Tap the View By pick list and select List.
5. Tap OK.



To open the Applications Launcher to the last opened category:

1. Tap the Applications icon .
2. Tap the Menu icon .
3. Tap Options, and then tap Preferences.
4. Tap the Remember Last Category check box to select it.
5. Tap OK.

Choosing preferences

You can set options that affect an entire application in the application's Preferences dialog box.

To change preferences for an application:

1. Open an application.
2. Tap the Menu icon .
3. Tap Options, and then tap Preferences.

Note: Not all applications have a Preferences command.

4. Make changes to the settings.
5. Tap OK.

Installing and removing applications

This section explains how to install and remove applications on your organizer and how to remove Palm™ Desktop organizer software from your computer.

Installing add-on applications

Your organizer comes with the Date Book, Address Book, To Do List, Memo Pad, Expense, Calculator, and Mail applications installed and ready to use.

Your organizer also contains several built-in query applications; so after you activate the wireless communication service, you have immediate access to Internet information.

The CD-ROM containing Palm Desktop software also contains many more query applications. You can transfer these to your computer at the same time that you install the software. These query applications are stored in the Add-on folder, and you can add them to your organizer using the Install Tool.

You can also install additional applications on your organizer, such as games and other software, including more query applications. Many third-party applications are available for your organizer. The web site <http://www.palm.net> has more information about these applications.

Note: Any game or application that you install on your organizer resides in RAM memory; you can delete it at any time. See “Removing applications” later in this chapter for more information.

With the Install Tool and HotSync® technology, you can easily install software on your organizer.

To install add-on software on your organizer:

1. Using your desktop computer, copy or download the application you want to install into the Add-on folder in your Palm Desktop directory.

Note: If the software you download is compressed, you need to decompress it into this folder. If you prefer to place the application into another folder, you need to navigate to that folder before you complete step 5.

2. Double-click the Palm Desktop icon on your desktop.



3. Click Install.

Tip: You can also access the Install Tool dialog box by selecting Install Tool from the Palm Desktop program group or by double-clicking any file with a PDB, PRC, or PQA file extension.



4. In the User drop-down list, select the name that corresponds to your organizer.
5. Click Add.



To see a list of just the query applications that are on your computer, in Files of type, select the option for files with the PQA extension.

6. Select the application(s) that you want to install on your organizer.
7. Click Open.

Note: Review the list of applications you selected in the Install Tool dialog box. If you do not want to install an application, select it, and then click Remove. (This does not remove the application from your computer; it simply removes it from the list of applications to install.)

8. Perform a HotSync operation to install the application(s) you selected in step 6. See “Exchanging and updating data: HotSync operations” in Chapter 4 for details.

By default, query applications appear on your organizer in the Palm.Net category of the Applications Launcher.

Installing games

The CD-ROM also includes several games that you can install with the Install Tool:

- Giraffe
- HardBall
- MineHunt
- Puzzle
- SubHunt

During Install, these games are automatically copied to the \Add-on folder in your Palm Desktop directory on your computer.



Note: Giraffe is a fun, easy way for you to practice Graffiti® writing.

After you install and start a game, the instructions appear in the Game menu. Depending on the game, the Game menu may also contain commands to show high scores, to start a new game, or to set preferences for the game.

Removing applications

In the event that you run out of memory or decide that you no longer need an application you installed, you can remove applications from your organizer. You can remove only add-on applications, patches, and extensions that you install; you cannot remove the applications that reside in the ROM portion of your organizer.

To remove an add-on application:

1. Tap the Applications icon .
2. Tap the Menu icon .
3. Tap App, and then tap Delete.
4. Tap the application that you want to remove.



5. Tap Delete.
6. Tap Yes.
7. Tap Done.

Removing Palm Desktop software

If you no longer want to use Palm Desktop software, you can remove it from your computer.

To remove Palm Desktop software:

1. From the Windows Start menu, choose Settings, and then Control Panel.
2. Double-click the Add/Remove Programs icon.
3. On the Install/Uninstall tab, select Palm Desktop software.
4. Click Add/Remove.

Note: You need to install the HotSync Manager from the installation CD-ROM if you want to synchronize data with another PIM. In the Setup Type dialog box, select Custom; then deselect all options except the HotSync option.

Security

Your organizer comes with a Security application so that unauthorized users cannot view the entries you wish to protect.

See “Protection of your wireless transactions” in Chapter 5 for information about the security of the Palm.Net™ network.

In Security, you can do the following:

- Turn off and lock your organizer so that it does not operate until you enter the correct password.
- Hide records that you mark as private. You can hide private records with or without a password. Without a password, private records are hidden until you set the Security application to show them. With a password, you must enter the password to view the private entries. See “Making records private” in Chapter 4 for information on making records private.

Assigning a password

You can assign a password to protect your private records and to lock your organizer.

To assign a password:

1. Tap the Applications icon .
2. Tap the Security icon.
3. Tap the Password box.
4. Enter a password.

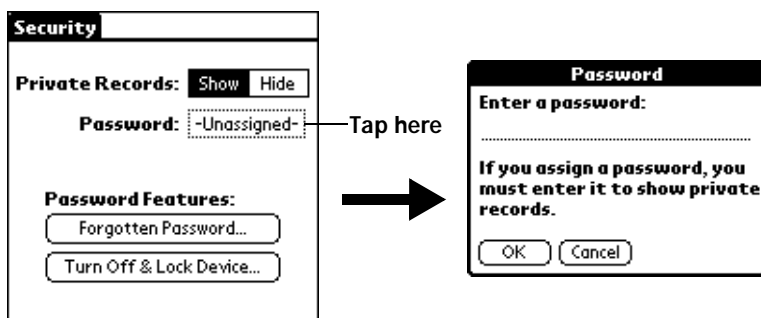

5. Tap OK.
6. Enter the *same* password a second time, and tap OK.

Changing or deleting a password

Once you define a password for your organizer, you can change or delete it at any time. You must enter the current password before you can change or delete it.

To change or delete your password:

1. Tap the Password box.
2. Enter the current password.

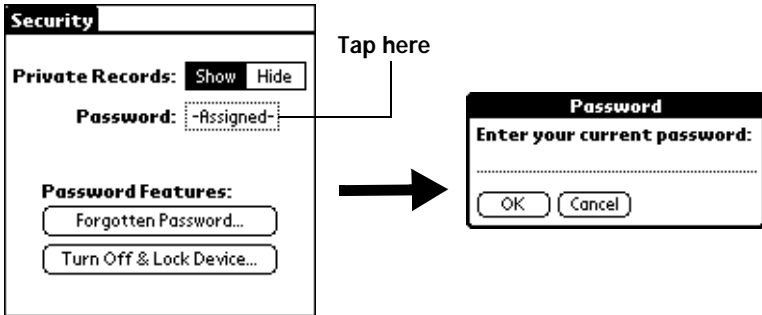

3. Tap OK.
4. Do one of the following:

To change the password, enter the new password, and tap OK.

To delete the password, tap Delete.



Locking your organizer

You can also lock your organizer so that you need to enter your password to operate it.

Important: If you lock your organizer, you must enter the exact password to re-activate your organizer. If you forget the password, you need to perform a hard reset to resume using your organizer. Performing a hard reset deletes all the records in your organizer; however, you can restore all synchronized data at the next HotSync operation. See “Performing a hard reset” in Appendix A for information about how to perform a hard reset.

To lock your organizer with a password:

1. Perform a HotSync operation to synchronize the data between your organizer and your computer. See “Exchanging and updating data: HotSync operations” in Chapter 4 for information on synchronizing your data.
2. Assign a password.
3. Tap Turn Off & Lock Device.

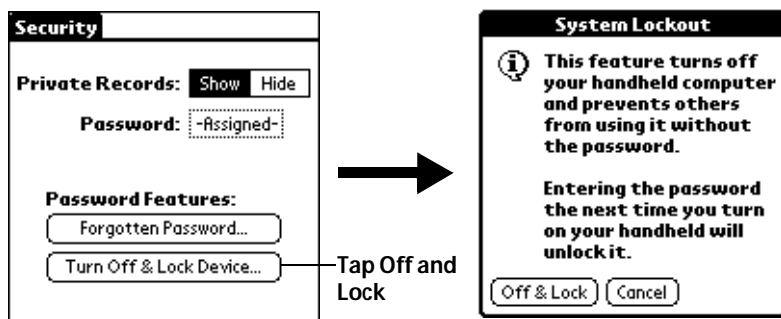

4. Tap Off & Lock.
5. To start your organizer, turn it on and then enter the password.

Recovering from a forgotten password

If you did not activate the Off & Lock feature and you forget your password, you can delete the password from your organizer. Deleting a forgotten password also deletes all entries and files marked as Private.

Important: If you synchronize with your computer before deleting a forgotten password, your organizer restores your private entries the next time you perform a HotSync operation, but it does not restore the password.

To delete a forgotten password:

1. Tap Forgotten Password.
2. Tap Yes.

Chapter 4

Using Your Basic Applications

These are the basic applications of your organizer:

- Date Book
- Address Book
- To Do List
- Memo Pad
- Calculator
- Expense

See Chapter 5 for information on query applications and the iMessenger™ application. See Chapter 6 for information on Mail.

This chapter is divided into three sections:

- “Overview of basic applications” briefly describes each application and explains how to open it.
- “Common tasks” gives instructions on how to do tasks that you can do in most or all of the basic applications. It’s easy to transfer what you learn in one application to the others because the structure and behavior of all the applications are quite similar.
- “Application-specific tasks” is organized by application and gives instructions on how to do tasks that are specific to each application.

Overview of basic applications

Date Book



Date Book lets you quickly and easily schedule appointments or any kind of activity associated with a time and date.

In Date Book, you can do the following:

- Enter a description of your appointment and assign it to a specific time and date.
- Display a chart of your appointments for an entire week. The Week View makes it easy to spot available times and any potential scheduling overlaps or conflicts.
- Display a monthly calendar to quickly spot days where you have morning, lunch, or afternoon appointments.
- Set an alarm to sound prior to the scheduled activity.
- Create reminders for events that are based on a particular date, rather than time of day. Birthdays and anniversaries are easy to track with your organizer.
- Attach notes to individual events for a description or clarification of the entry in your Date Book.

To open Date Book:

- Press the Date Book application button on the front panel of your organizer. Date Book opens to today's schedule.

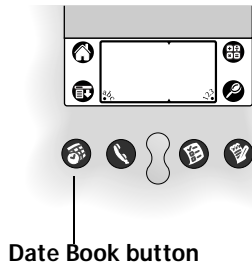

Note: Press the Date Book application button repeatedly to cycle through the Day, Week, and Month views.

Address Book



Address Book enables you to keep names, addresses, phone numbers, and other information about your personal or business contacts.

In Address Book, you can do the following:

- Quickly look up or enter names, addresses, phone numbers, and other information.
- Enter up to five phone numbers (home, work, fax, mobile, etc.) or e-mail addresses for each name.
- Define which phone number appears in the Address List for each Address Book entry.
- Attach a note to each Address Book entry, in which you can enter additional information about the entry.
- Assign Address Book entries to categories so that you can organize and view them in logical groups.

To open Address Book:

- Press the Address Book application button on the front panel of your organizer. Address Book opens to display the list of all your records.

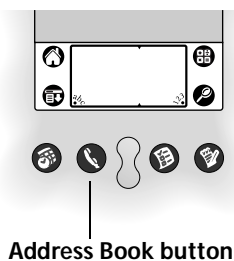

Note: Press the Address Book application button repeatedly to cycle through the categories in which you have records.

To Do List



To Do List is a convenient place to create reminders and prioritize the things that you have to do.

In To Do List, you can do the following:

- Make a quick and convenient list of things to do.
- Assign a priority level to each task.
- Assign a due date for any or all of your To Do List items.
- Assign To Do List items to categories so that you can organize and view them in logical groups.
- Sort your To Do List items either by due date, priority level, or category.
- Attach notes to individual To Do List items for a description or clarification of the task.

To open To Do List:

- Press the To Do List application button on the front panel of your organizer. To Do List opens to display the category of items you last viewed.

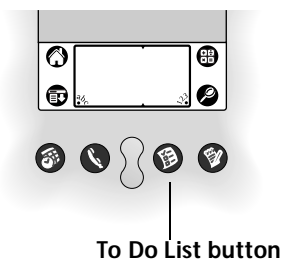

Note: Press the To Do List application button repeatedly to cycle through the categories in which you have items.

Memo Pad



Memo Pad provides a place to take notes that are not associated with records in Date Book, Address Book, or To Do List.

In Memo Pad, you can do the following:

- Take notes or write any kind of message on your organizer.
- Drag and drop memos into popular computer applications like Microsoft Word when you synchronize using Palm™ Desktop organizer software and HotSync® technology.
- Assign memos to categories so that you can organize and view them in logical groups.
- Write down phone numbers and other types of information. Later, you can copy and paste this information to other applications.

To open Memo Pad:

- Press the Memo Pad application button on the front panel of your organizer. Memo Pad opens to display the last Memo Pad screen that you viewed.

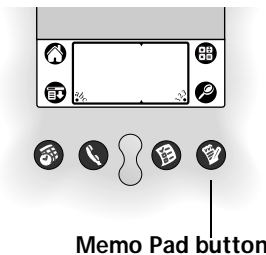

Note: Press the Memo Pad application button repeatedly to cycle through the categories in which you have memos.

Calculator



Calculator enables you to perform addition, subtraction, multiplication, and division.

In Calculator, you can do the following:

- Perform basic calculations.
- Store and retrieve values.

- Display the last series of calculations, which is useful for confirming a series of “chain” calculations.

To open Calculator:

- Tap the Calculator icon  next to the Graffiti® writing area.

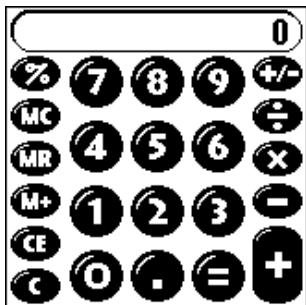

Expense

-  Expense lets you keep track of your expenses and then transfer the information to a spreadsheet on your computer.

In Expense, you can do the following:

- Record dates, types of expenses, amount spent, payment method, and other details associated with any money that you spend.
- Assign expense items to categories so that you can organize and view them in logical groups.
- Keep track of vendors (companies) and people involved with each particular expense.
- Log miles traveled for a particular date or expense category.
- Sort your expenses by date or expense type.
- Transfer your expense information to a Microsoft Excel spreadsheet (version 5.0 or later) on your computer. (Microsoft Excel is *not* included in the Palm VII™ organizer package.)

To open Expense:

1. Tap the Applications icon .
2. Tap the Expense icon .

Common tasks

The tasks described in this section use the term “records” to refer to an individual item in any of the basic applications: a single Date Book event, Address Book entry, To Do List item, Memo Pad memo, or Expense item.

Creating records

You can use the following procedure to create a new record in Date Book, Address Book, To Do List, Memo Pad, and Expense.

To create a record:

1. Select the application in which you want to create a record.
2. Tap New.
3. In Date Book only: Select start and end times for your appointment and tap OK.
4. Enter text for the record.
5. (Optional) Tap Details to select attributes for the record.
6. In Address Book and Memo Pad only: Tap Done.

There’s no need to save the record because your organizer saves it automatically.

Editing records

After you create a record, you can change, delete, or enter new text at any time. Two screen features tell you when your organizer is in editing mode:

- A blinking cursor
- One or more edit lines

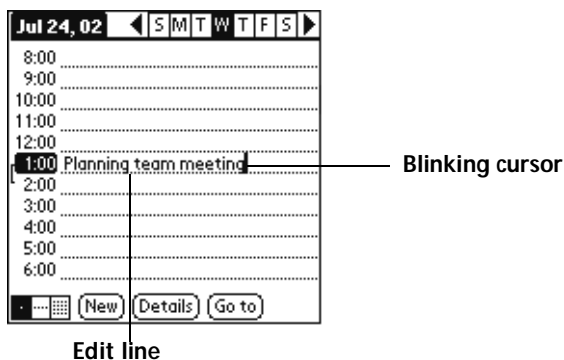

Entering text

For information on how to enter text using Graffiti writing, the onscreen keyboard, or the keyboard attached to your computer, see Chapter 2.

Edit menu

The Edit menu is available with any screen where you enter or edit text. In general, commands available in the Edit menu apply to text that you *select* in an application.

To select text in an application:

1. Tap the beginning of the text that you want to select.
2. Drag the stylus over the text to highlight it (in black).

Note: You can drag *across* the text to select additional words, or drag *down* to select a group of lines.

The following commands may appear in an Edit menu:

Undo	Reverses the action of the <i>last edit</i> command. For example, if you used Cut to remove text, Undo restores the text you removed. Undo also reverses deletions done by using backspace.
Cut	Removes the selected text and stores it temporarily in the memory of your organizer. You can paste the text you cut into another area of the current application or into a different application.
Copy	Copies the selected text and stores it temporarily in the memory of your organizer. You can paste the text that you copy into another area of the current application or into a different application.
Paste	Inserts the text that you cut or copied at the selected point in a record. The text you paste replaces any selected text. If you did not previously cut or copy text, Paste does nothing.
Select All	Selects all of the text in the current edit line, record, or screen. This enables you to cut or copy all of the text and paste it elsewhere.

Copy Page	Copies the first 4,000 bytes of a clipping or page in a query application. See “Saving information from a query application” in Chapter 5.
Keyboard	Opens the onscreen keyboard. When you finish with the onscreen keyboard, tap Done.
Graffiti Help	Opens screens that show all the Graffiti character strokes. Use this command anytime you forget a stroke for a character.

Deleting records

To delete a record in any of the basic applications:

1. Select the record you want to delete.
2. Tap the Menu icon .
3. Tap Record, and then tap the Delete command:

Date Book: Delete Event

Address Book: Delete Address

To Do List: Delete Item

Memo Pad: Delete Memo

Expense: Delete Item

A confirmation dialog box appears. If you want to save a copy of the deleted item to an archive file in Palm Desktop software, be sure that the check box is checked. If you don't want to save a copy, tap the check box to remove the check.

4. Tap OK.

If you save a copy of the item, your organizer transfers it to the archive file on your desktop the next time you perform a HotSync operation.

Other ways to delete records

You can also delete records in the following ways:

- In the Details dialog box of the application, tap Delete, and then tap OK.
- Delete the text of the record.

Note: In Date Book, if you delete the text of a repeating event, you delete all instances of that event.

Purging records

Over time, as you use Date Book, To Do List, and Expense, you'll accumulate records in these applications that have outlived their usefulness. For example, events that occurred months ago remain in the Date Book, and To Do List items that you marked as completed remain in the list, as do Expense items.

All these outdated records take up memory on your organizer, so it's a good idea to remove them by using Purge. If you think Date Book or To Do List records might prove useful later, you can purge them from your organizer and save them in an archive file.

Purging is also available in the iMessenger application (see Chapter 5) and in Mail (see Chapter 6).

Purging is not available in Address Book or Memo Pad. You must delete unneeded records from these applications.

To purge records:

1. Open the application.
2. Tap the Menu icon .
3. Tap Record, and then tap Purge.

A confirmation dialog box appears.

Date Book: Tap the pick list and select how old a record must be to be purged. Purge deletes repeating events if the last of the series ends before the date that you purge records.

Date Book, To Do List: If you want to save a copy of the purged records to an archive file on your desktop, be sure that the check box is checked. If you don't want to save a copy, tap the check box to remove the check box.

4. Tap OK.

If you chose to save a copy of the purged records, your organizer transfers them to an archive file on your desktop the next time you perform a HotSync operation.

Note: Purging does not happen automatically. You must tap the command to make it happen.

Exchanging and updating data: HotSync operations

The HotSync process automatically synchronizes — that is, exchanges and updates — the data on your organizer and Palm Desktop software. Changes made on your organizer are transferred to your Palm Desktop software, and vice versa. The first HotSync operation takes a little time, but after that, HotSync operations happen quickly because only changes are synchronized.

You can synchronize your data by connecting your organizer directly to your computer with the cradle or indirectly with a network or a Palm Modem® accessory. See Chapter 7 for information about performing HotSync operations via a modem or network.

Performing a HotSync operation for the first time

The first time you synchronize your data, you need to enter user information on both the organizer and Palm Desktop software. After you enter this information and synchronize, the HotSync Manager recognizes your organizer and doesn't ask for this information again.

If you are a System Administrator preparing organizers for a group of users, you may want to create a user profile. See “Creating a user profile” in Chapter 7 before performing the following steps.

Important: You must perform your *first* HotSync operation with a local, direct connection, rather than using a modem.

To perform a local HotSync operation:

1. Insert your organizer into the cradle.

Tip: The bottom edge of the organizer should align smoothly with the cradle when it is inserted properly.

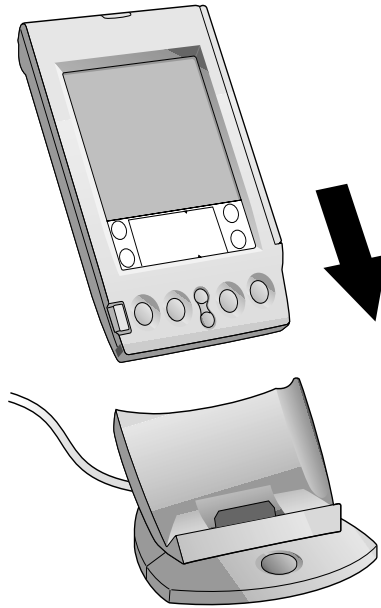

2. If the HotSync Manager is not running, start it: on the Windows desktop, click Start, and then choose Programs. Navigate to the Palm Desktop software program group and choose HotSync Manager. Alternatively, you can start the Palm Desktop software.
3. Press the HotSync button ™ on the cradle.

Note: If you are using an optional HotSync cable instead of a cradle, click the HotSync Manager icon in the Windows system tray and choose Local from the menu.



Important: The first time you perform a HotSync operation, you must select a username in the New User dialog box and choose OK. Every organizer must have a unique name. To prevent undesirable results, never try to synchronize more than one organizer to the same username.

The HotSync dialog box appears and synchronization begins.



4. Wait for a message on your organizer indicating that the process is complete.

After the HotSync process is complete, you can remove your organizer from the cradle.

Categorizing records

Categorize records in the Address Book, To Do List, Memo Pad, and Expense applications so that they are grouped logically and are easy to review. (You can also categorize applications. See "Using the Applications Launcher" in Chapter 3 for more information.)

When you create a record, your organizer automatically places it in the category that is currently displayed. If the category is All, your

organizer assigns it to the Unfiled category. You can leave an entry as Unfiled or assign it to a category at any time.

System-defined and user-defined categories

By default, your organizer includes system-defined categories, such as All and Unfiled, and user-defined categories, such as Business and Personal.

You cannot modify the system-defined categories, but you can rename and delete the user-defined categories. In addition, you can create your own user-defined categories. You can have a maximum of 15 user-defined categories in each application.

Address Book contains the QuickList user-defined category, in which you can store the names, addresses, and phone numbers you might need in emergencies (doctor, fire department, lawyer, etc.).

Expense contains two user-defined categories, New York and Paris, to show how you might sort your expenses according to different business trips.

Note: The illustrations in this section come from Address Book, but you can use these procedures in all the applications in which categorizing is available. Categorizing is not available in Date Book.

To move a record into a category:

1. Select the record you want to categorize.
2. In Address Book only: Tap Edit.
3. Tap Details.
4. Tap the Category pick list to display the list of available categories.



5. Select the category for the record.
6. Tap OK.

To display a category of records:

1. Tap the category pick list in the upper-right corner of the List screen.

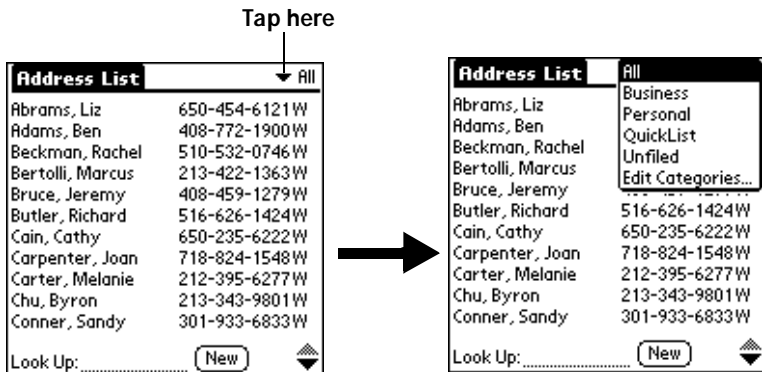

2. Select the category you want to view.

The List screen now displays only the records assigned to that category.

Tip: Pressing an application button on the front panel of the organizer toggles through all the categories of that application.

To define a new category:

1. Tap the category pick list in the upper-right corner of the screen.

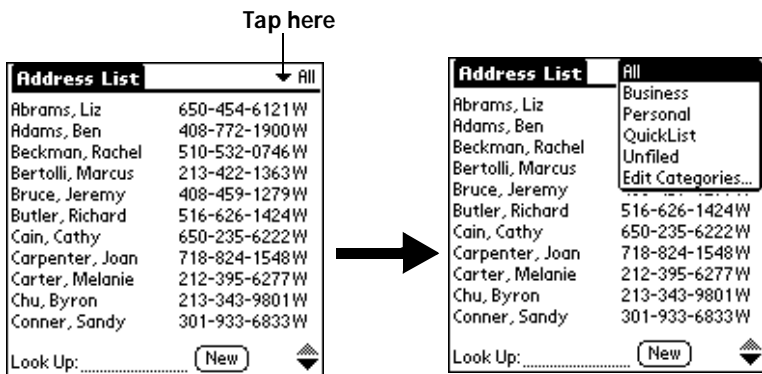

2. Tap Edit Categories.

3. Tap New.



4. Enter the name of the new category, and then tap OK.



5. Tap OK.

You can assign any of your records to the new category.

To rename a category:

1. Tap the category pick list in the upper-right corner of the screen.
2. Tap Edit Categories.
3. Select the category that you want to rename, and then tap Rename.



4. Enter the new name for the category, and then tap OK.



5. Tap OK.

Tip: You can group the records in two or more categories into one category by giving the categories the same name. For example, if you change the name of the Personal category to Business, all records formerly in the Personal category appear in the Business category.

Finding records

Your organizer offers several ways to find information quickly:

- **All applications:** Find locates any text that you specify, always starting with the current application.
- **Date Book, To Do List, Memo Pad:** Phone Lookup displays the Address List screen and lets you add the information that appears in this list to a record.
- **Address Book:** The Look Up line lets you enter the first letters of a name to scroll immediately to that name.
- **Expense:** Lookup displays the names in your Address Book that have data in the Company field. You can add these names to a list of attendees associated with an Expense record.

Looking up Address Book records

When working with Address Book, the scroll button on the front panel of the organizer makes it easy to navigate among your address entries.

- In the Address List screen, the scroll button moves up or down an entire screen of records. If you hold down the scroll button, you accelerate the scrolling and display every third screen.
- In the Address View screen, the scroll button moves to the previous or next address record.

You can also use the Address List Look Up feature to quickly scroll to any of your Address Book entries.

To look up an Address Book record:

1. Display the Address List screen.
2. Enter the first letter of the name you want to find.

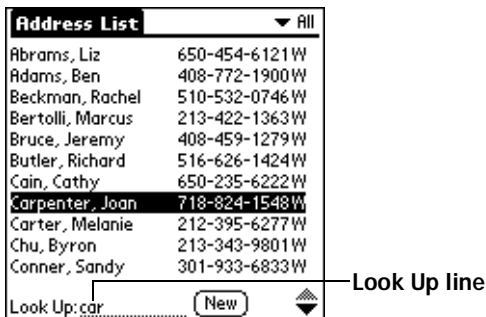

The list scrolls to the first entry that begins with that letter. If you write another letter, the list scrolls to the first entry that starts with those *two* letters. For example, writing an “s” scrolls to “Sands,” and writing “sm” scrolls further to “Smith.” If you sort the list by company name, the Look Up feature scrolls to the first letter of the company name.

3. Tap the record to view its contents.

Using Find

You can use Find to locate any text that you specify, in any application except query applications.

To use Find:

1. Tap the Find icon .

Tip: If you select text in an application before you tap Find, the selected text automatically appears in the Find dialog box.

2. Enter the text that you want to find.

Find is *not* case-sensitive. For example, searching for the name “davidson” also finds “Davidson.”

Find locates any words that begin with the text you enter. For example, searching for “plane” finds “planet,” but not “air-plane.”

3. Tap OK.

Find searches for the text in all records and all notes.

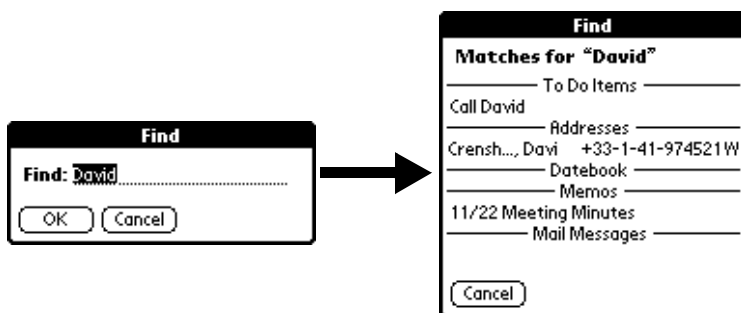

During the search, you can tap Stop at any time. You may want to do this if the entry you want appears before your organizer finishes the search. To continue the search after you tap Stop, tap Find More.

4. Tap the text that you want to review.

Using Phone Lookup

Phone Lookup displays the Address List screen and lets you add information from that list to a record.

To use Phone Lookup:

1. Display the record in which you want to insert a phone number. The record can be in Date Book, To Do List, or Memo Pad.
2. Tap the Menu icon .
3. Tap Options, and then tap Phone Lookup.
4. Spell the last name of the name you want to find.



The list scrolls to the first record in the list that starts with the first letter you enter. Continue to spell the name you're looking for, or when you see the name, tap it.

5. Tap Add.

The name you selected, along with the other information associated with it, is pasted into the record you selected in step 1.

Phone Lookup tips

Write the Graffiti Command stroke /L to activate the Phone Lookup feature. You can also activate it in the following circumstances:

- **While entering text:** For example, to insert the full name and phone number for someone with the last name "Williams," write the Graffiti characters for "Wi" and then the Phone Lookup Command stroke /L.

Assuming you have only one Address Book record that begins with "Wi," your organizer inserts the full name "Williams" (and its associated information). If you have more than one name that begins with "Wi," the Phone Lookup screen appears and highlights the first record that begins with "Wi."

- **For selected text:** Drag to highlight the text, and then write the Phone Lookup Command stroke /L. Your organizer replaces the selected text and adds the name and its associated information.

Looking up names to add to expense records

In Expense, Lookup displays the names in your Address Book that have data in the Company field. You can add these names to a list of attendees associated with an Expense record.

To add names to an Expense record:

1. Tap the Expense record you want to add names to.
2. Tap Details.



3. Tap Who.

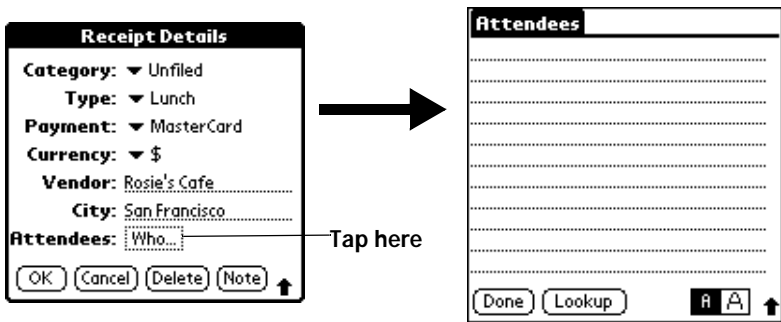

4. Tap Lookup.

The Attendees Lookup screen displays all the names in your Address Book that have data in the Company field.

5. Select the name you want to add, and then tap Add.

The name appears in the Attendees screen.

6. Repeat steps 4 and 5 to add more names.
7. Tap Done.
8. Tap OK.

Sorting lists of records

You can sort lists of records in various ways, depending on the application. Sorting is available in applications that have List screens: Address Book, To Do List, Memo Pad, and Expense.

Note: You can also assign records to categories. See “Categorizing records” earlier in this chapter.

To sort records in To Do List and Expense:

1. Open the application to display the List screen.
2. Tap Show.
3. Tap the Sort by pick list and select an option.
4. Tap OK.

To sort records in Address Book and Memo Pad:

1. Open the application to display the List screen.
2. Tap the Menu icon .
3. Tap Options, and then tap Preferences.

Address Book

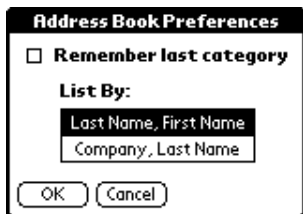

Memo Pad

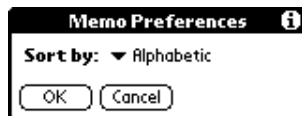

4. Do one of the following:

Address Book: Tap the setting you want.

Memo Pad: Tap the Sort by pick list and select Alphabetic or Manual.

5. Tap OK.

To sort the Memo List manually, tap and drag a memo to a new location in the list.

Note: To make the list of your memos appear in Palm Desktop software as you manually sorted it on your organizer, open Memo Pad in Palm Desktop software and click List by. Then select Order on handheld.

Making records private

In all basic applications except Expense, you can make individual records private. Private records remain visible and accessible, however, until you select the Security setting to hide all private records. See “Security” in Chapter 3 for more information.

Hiding private records

You can hide records that you mark as private. If you define a password for your organizer, you must enter it to display private records.

To hide private records:

1. Tap the Applications icon .
2. Tap Security.
3. Tap Hide.

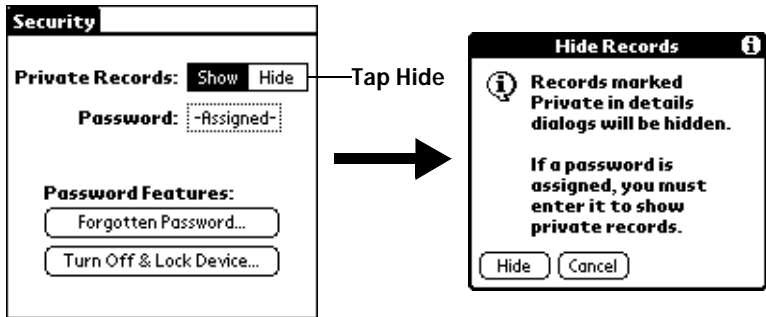

4. Tap Hide to confirm that you want to hide private records.

To display private records:

1. Tap the Applications icon .
2. Tap Security.
3. Tap Show.

If you do not have a password, hidden records become visible.

If you have a password, the Show Private Records dialog box appears. Go to step 4.

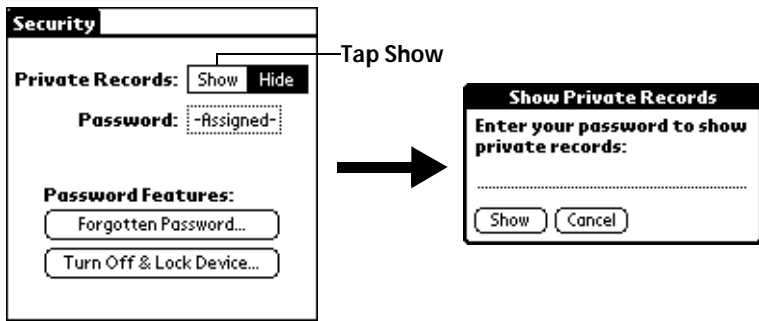

4. Enter your password, and then tap Show.

To make a record private:

1. Display the entry that you want to make private.
2. Tap Details.
3. Tap the Private check box to select it.
4. Tap OK.

Attaching notes

In all basic applications except Memo Pad, you can attach a note to a record. A note can be up to several thousand characters long. For example, for an appointment in Date Book, you can attach a note with directions to the location.

To attach a note to a record:

1. Display the entry to which you want to add a note.
2. In Address Book only: Tap Edit.
3. Tap Details.
4. Tap Note.
5. Enter your note.
6. Tap Done.

A small note icon appears at the right side of any item that has a note.

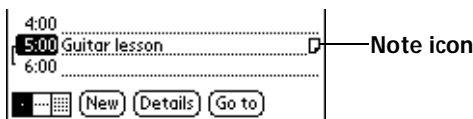

To review or edit a note:

1. Tap the Note icon .

To delete a note:

1. Tap the Note icon .
2. Tap Delete.
3. Tap Yes.

Choosing fonts

In all basic applications except Expense, you can change the font style to make text easier to read. You can choose a different font style for each application.

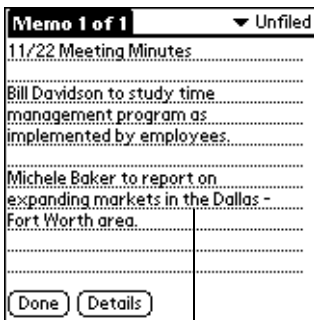

Small font



Large font

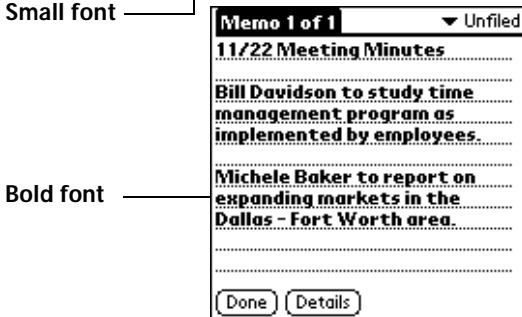

Bold font

To change the font style:

1. Open an application.
2. Tap the Menu icon .
3. Tap Options, and then tap Font.
4. Tap the font style you want to use.

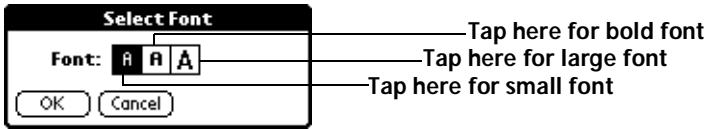

5. Tap OK.

Application-specific tasks

Date Book

When you open Date Book, the screen shows the current date and a list of times for a normal business day.

Scheduling an event

A record in Date Book is called an “event.” An event can be any kind of activity that you associate with a day. You can enter a new event on any of the available time lines.

When you schedule an event, its description appears on the time line, and its duration is automatically set to one hour. You can easily change the start time and duration for any event.

Note: It’s possible to schedule events that overlap, but Date Book makes it easy to find such conflicts. See “Spotting event conflicts” later in this chapter.

You can also schedule events in your Date Book that occur on a particular date but have no specific start or end times, such as birthdays, holidays, and anniversaries. These are referred to as “untimed events.” Untimed events appear at the top of the list of times, marked with a diamond. You can have more than one untimed event on a particular date.

You can also schedule a repeating event, such as a weekly meeting, and continuous events, such as a three-day conference or a vacation.

To schedule an event for the current day:

1. Tap the time line that corresponds to the beginning of the event.

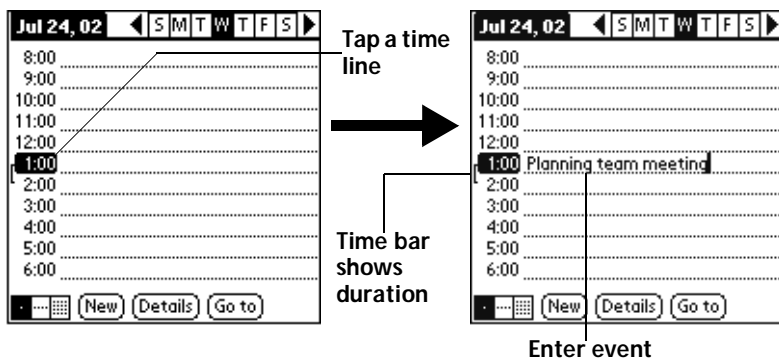

2. Enter a description of the event. You can enter up to 255 characters.
3. If the event is one hour long, skip to step 7. If the event is longer or shorter than an hour, tap the time of the event to open the Set Time dialog box.

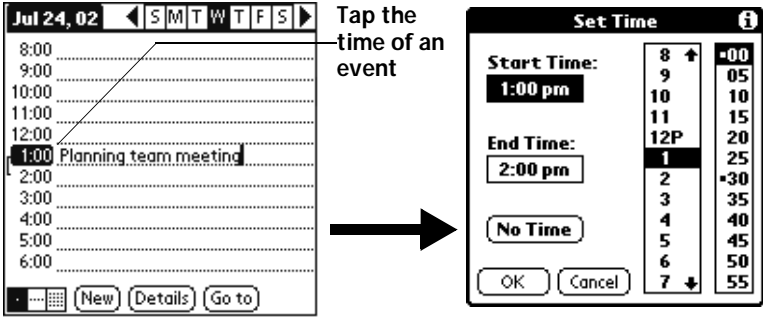

Tip: You can also open the Set Time dialog (to select a start time) by making sure no event is selected, and then writing a number on the number side of the Graffiti writing area.

4. Tap the time columns on the right side of the Set Time dialog to set the Start Time.

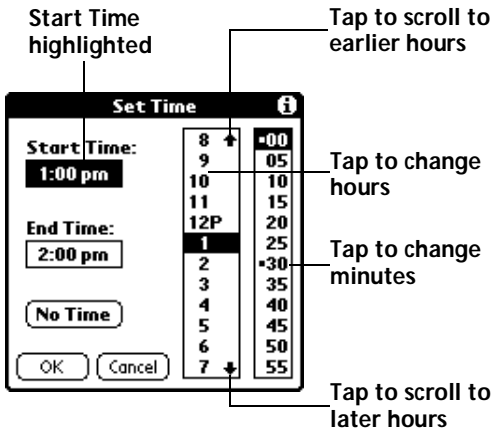

5. Tap the End Time box, and then tap the time columns to set the End Time.
6. Tap OK.
7. Tap a blank area of the screen to deselect the event. A vertical line appears next to the time, indicating the duration of the event.

To schedule an event for another day:

1. Select the date you want for the event by doing one of the following:
 - Tap the day of the week that you want in the date bar at the top of the screen. If necessary, tap the Previous week or Next week scroll arrows to move to another week.

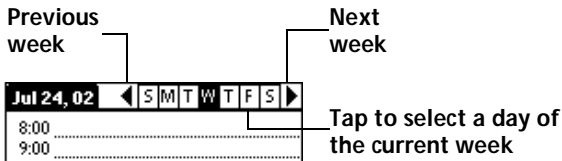

Tip: You can also use the scroll button on the front panel of your organizer to move forward or backward one day at a time.

- Tap Go To at the bottom of the screen to open the Go to Date dialog box. Select a date by tapping a year, month, and day in the calendar.

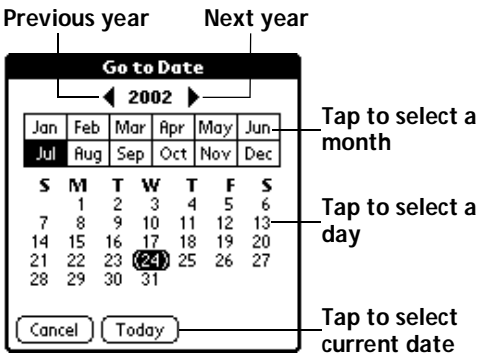

Tip: In the Go to Date dialog box, you can also use the scroll button on the front panel of the organizer to move forward or backward one month at a time.

2. After you locate the date, follow the steps for scheduling an event for the current day.

To schedule an untimed event:

1. Select the date that you want for the event as described in “To schedule an event for another day.”
2. Tap New.
3. Tap OK, so that no start or end times are defined for the new event.

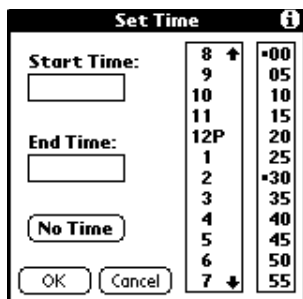

Tip: You can also create a new untimed event by making sure no event is selected and then writing letters in the Graffiti writing area.

4. Enter a description of the event.

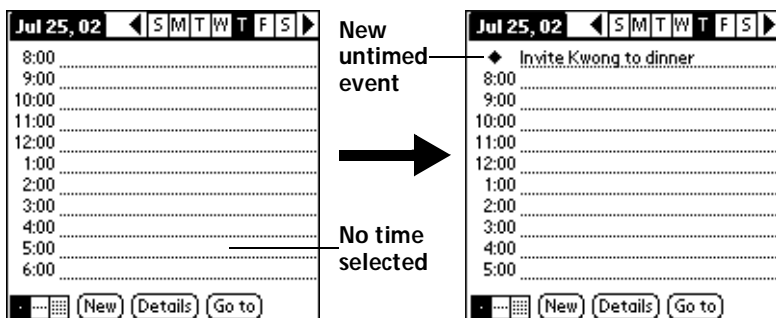

5. Tap a blank area on the screen to deselect the untimed event.

Note: If you create an event and decide later that there is no particular start or end time, you can easily change it to an untimed event. Tap the time of the event in the Date Book screen, tap No Time, and then tap OK.

Rescheduling an event

You can easily make changes to your schedule with your organizer.

To reschedule an event:

1. Tap the event you want to reschedule.
2. Tap Details.
3. To change the time, tap the Time box and select a new time.
4. To change the date, tap the Date box and select a new date.
5. Tap OK.

Setting an alarm for an event

The Alarm setting enables you to set an audible alarm for events in your Date Book. You can set an alarm to sound minutes, hours, or days before an event. The default Alarm setting is 5 minutes before the time of the event, but you can change this to any number of minutes, hours, or days.

When you set an alarm, this icon  appears to the far right of the event with the alarm. When the alarm tone sounds, a reminder message also appears onscreen.

To set an alarm for an event:

1. Tap the event to which you want to assign an alarm.
2. Tap Details.
3. Tap the Alarm check box to select it.

The default setting, 5 Minutes, appears.

4. Tap the pick list to select Minutes, Hours, or Days.
5. Select the 5 and enter any number from 0 to 99 (inclusive) as the number of time units.

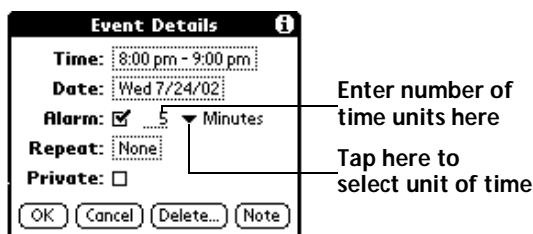

6. Tap OK.

Alarm for untimed events: You can set a silent alarm for an untimed event. In this case, the alarm triggers at the specified period of minutes, hours, or days before midnight (beginning) of the day of the untimed event. No audible alarm sounds for an untimed event; instead, the reminder message appears onscreen.

For example, you set an alarm for an untimed event that occurs on February 4th. If the alarm is set for 5 minutes, the reminder message appears at 11:55 PM on the night of February 3rd. The reminder remains onscreen until you turn on your organizer and tap OK to dismiss it.

Scheduling repeating or continuous events

The Repeat function lets you schedule events that recur at regular intervals or extend over a period of consecutive days.

A birthday is a good example of an event that repeats annually. Another example is a weekly guitar lesson that falls on the same day of the week and the same time of day.

A business trip or a vacation is an example of a continuous event.

To schedule a repeating or continuous event:

1. Tap the event.

Typically, a continuous event is an untimed event.

2. Tap Details.
3. Tap the Repeat box to open the Change Repeat dialog box.

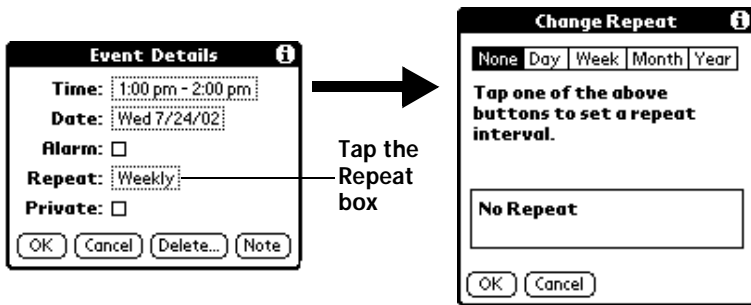

4. Tap Day, Week, Month, or Year to set how often the event repeats.

For a continuous event, tap Day.

5. Enter a number that corresponds to how often you want the event to repeat on the Every line.
For example, if you select Month and enter the number 2, the event repeats every other month.
6. To specify an end date for the repeating or continuous event, tap the End on pick list and tap Choose Date. Use the date picker to select an end date.
7. Tap OK.

After you schedule a repeating or continuous event, this icon  appears to the far right of the event.

Considerations for repeating or continuous events: Keep the following points in mind.

- If you change the start date of a repeating event, your organizer calculates the number of days you moved the event. Your organizer then automatically changes the end date to maintain the duration of the repeating event.
- If you change the repeat interval (e.g., daily to weekly) of a repeating event, past occurrences (prior to the day on which you change the setting) are not changed, and your organizer creates a new repeating event.
- If you change the date of an occurrence of a repeating event (e.g., from January 14th to January 15th) and apply the change to all occurrences, the new date becomes the start date of the repeating event. Your organizer adjusts the end date to maintain the duration of the event.
- If you change other repeat settings (e.g., time, alarm, private) of a repeating event and apply the change to all occurrences, your organizer creates a new event. The start date of this new event is the day on which the setting is changed. Past occurrences (prior to the day of the change) are not changed.
- If you apply a change to a single occurrence of a repeating event (e.g., time), that occurrence no longer shows the Repeat icon .

Changing the Date Book view

In addition to displaying the time list for a specific day, you can also display a whole week or month. You can also display the current time.

To cycle through Day, Week, and Month views:

- Press the Date Book application button repeatedly to display the next view.

To display the current time:

- Tap the date in the date bar to display the current time. After a few seconds, the date reappears.

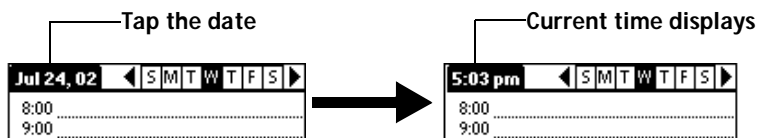

Working in Week View: Week View shows the calendar of your events for an entire week. This view lets you quickly review your appointments and available time slots. In addition, the graphical display helps you spot overlaps and conflicts in your schedule.

To display the Week View:

1. Tap the Week View button.



2. Tap the navigation controls to move forward or backward a week at a time, or to display details of an event.

Note: The Week View also shows untimed events and events that are before and after the range of times shown.

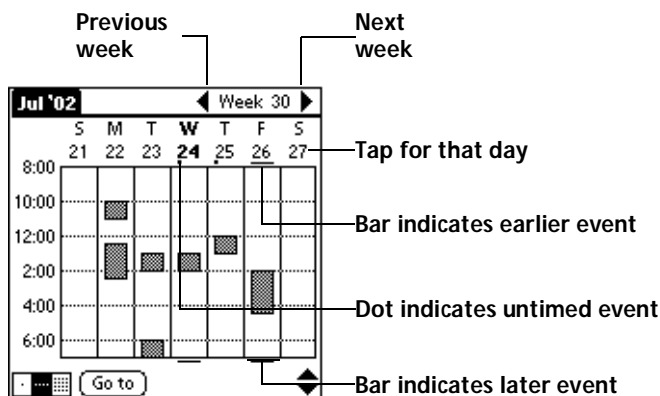

3. Tap an event to show a description of the event.

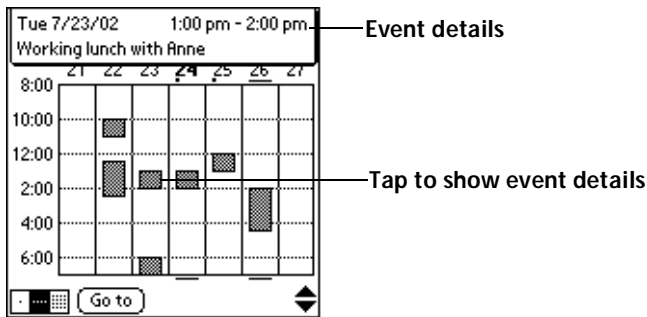

Tips for using Week View: Keep the following points in mind.

- To reschedule an event, tap and drag the event to a different time or day.
- Tap a blank time on any day to move to that day and have the time selected for a new event.
- Tap any day or date that appears at the top of the Week View to move directly to that day without selecting an event.
- The Week View shows the time span defined by the Start Time and End Time in the Date Book Preferences settings. If you have an event before or after this time span, a bar appears at the top or bottom of that day's column. Use the onscreen scroll arrows  to scroll to the event.

Spotting event conflicts

With the ability to define specific start and end times for any event, it's possible to schedule events that overlap (an event that starts before a previous event finishes).

An event conflict (time overlap) appears in the Week View as overlapping bars. The Day View displays overlapping brackets to the left of the conflicting times.

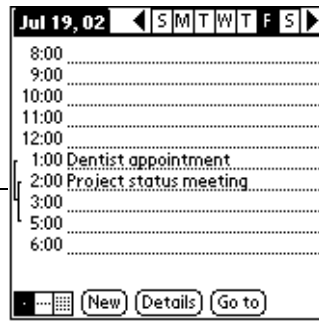
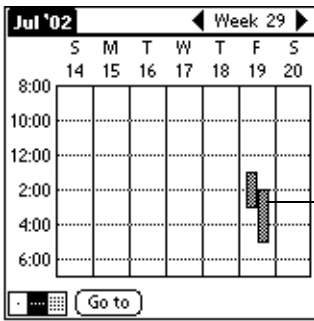

Working in Month View

The Month View screen shows which days have events scheduled. Dots and lines in the Month View indicate events, repeating events, and untimed events.



Month View button

You can control the dots and lines that appear in the Month View. See “Options menu” at the end of this section on Date Book.

Tips for using Month View: Keep the following points in mind.

- Tap a day in the Month View to display that day in the Day View.
- Tap the scroll arrows in the upper-right corner to move forward or backward a month.
- Tap Go to in order to open the date selector and select a different month.
- Use the scroll button on the front panel of your organizer to move between months. Press the upper half of the button to display the previous month, the lower half to display the next month.

Date Book menus, preferences, and display options

Date Book menus are shown here for your reference, and Date Book features that are not explained elsewhere in this book are described here.

See “Using menus” in Chapter 1 for information about choosing menu commands.

Record menu

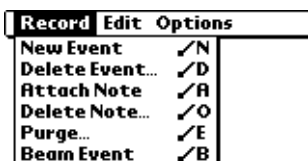

Options menu



Display Options Allows you to change Date Book's appearance and which events display.



- **Show Time Bars:** Activates the time bars that appear in the Day View. The time bars show the duration of an event and illustrate event conflicts.
- **Compress Day View:** Controls how times appear in the Day View. When Compress Day View is off, all time slots display. When it is on, start and end times display for each event, but blank time slots toward the bottom of the screen disappear to minimize scrolling.
- **Month View settings:** These check boxes apply to the Month View of the Date Book. You can activate any or all of these settings to show that you have Timed, Untimed, or Daily Repeating events in the Month View *only*.

Preferences



- **Start/End Time:** Define the start and end times for Date Book screens. If the time slots you select do not fit on one screen, you can tap the scroll arrows  to scroll up and down.
- **Alarm Preset:** Automatically sets an alarm for each new event. The silent alarm for untimed events is defined by minutes, days, or hours before midnight of the date of the event.
- **Alarm Sound:** Sets the tone of the alarm.
- **Remind Me:** Defines how many times the alarm sounds. The choices are Once, Twice, 3 Times, 5 Times, and 10 Times.
- **Play Every:** Defines how often the alarm sounds. The choices are Minute, 5 minutes, 10 minutes, and 30 minutes.

About Date Book

Shows version information for Date Book.

Address Book

Address Book is the application in which you store name and address information about people or businesses.

Creating an Address Book entry

A record in Address Book is called an “entry.” You can create entries on your organizer, or you can use Palm Desktop software to create entries on your computer and then download the entries to your organizer with your next HotSync operation.

Palm Desktop software also has data import capabilities that enable you to load database files into Address Book on your organizer.

See “Importing data” in Chapter 2 and Palm Desktop online Help for more information.

To create a new Address Book entry:

1. Press the Address Book application button  on the front of your organizer to display the Address List.
2. Tap New.

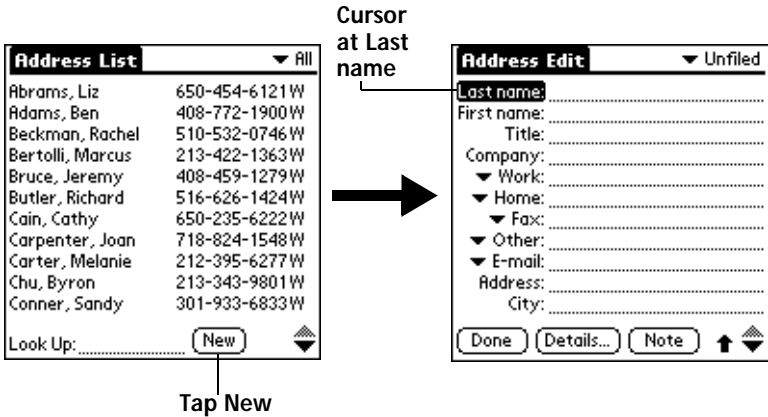

3. Enter the last name of the person you want to add to your Address Book.

Note: The organizer automatically capitalizes the first letter of each field (except numeric and e-mail fields). You do not have to use the Graffiti capital stroke to capitalize the first letter of the name.

4. Use the Next Field Graffiti stroke to move to the First Name field.



Tip: You can also move to any field by tapping it directly.

5. Enter the person's first name in the First Name field.
6. Enter the other information that you want to include in this entry.
7. Tap the scroll arrows  to move to the next page of information.
8. After you finish entering information, tap Done.

A screenshot of an 'Address Edit' form. The form has a title bar with 'Address Edit' and a 'Unfiled' status. The fields are: Last name: Carter, First name: Melanie, Title: (empty), Company: (empty), Work: 212-395-6277, Home: 212-395-4511, Fax: (empty), Other: (empty), E-mail: mcarter@aol.com, Address: 2267 5th Avenue, City: New York. At the bottom, there are three buttons: 'Done', 'Details...', and 'Note'. A line points from the 'Done' button to the text 'Tap Done' below it.

Tap Done

Tip: To create an entry that always appears at the top of the Address List, begin the Last name or Company field with a symbol, as in *If Found Call*. This entry can contain contact information in case you lose your organizer.

Selecting types of phone numbers

You can select the types of phone numbers or e-mail addresses that you associate with an Address Book entry. Any changes you make apply only to the current entry.

To select other types of phone numbers in an entry:

1. Tap the entry that you want to change.
2. Tap Edit.

3. Tap the pick list next to the label you want to change.

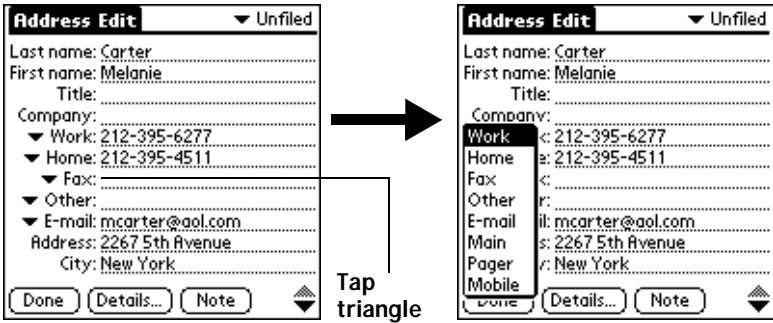

4. Select a new label.

Changing Address Entry details

The Address Entry Details dialog box provides a variety of options that you can associate with an entry.

To open the Address Entry Details dialog box:

1. Tap the entry whose details you want to change.
2. Tap Edit.
3. Tap Details.



4. Select any of the following settings:

Show in List: Select which type of phone or other information appears in the Address List screen. Your options are Work, Home, Fax, Other, and E-mail.

Category: Assign the entry to a category.

Private: Hide this entry when Security is turned on.

Address Book menus

Address Book menus are shown here for your reference, and Address Book features that are not explained elsewhere in this book are described here.

See “Using menus” in Chapter 1 for information about choosing menu commands.

The Record and Options menus differ depending on whether you’re displaying the Address List screen or the Address View screen.

Record menus

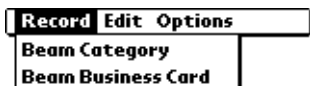

Address List

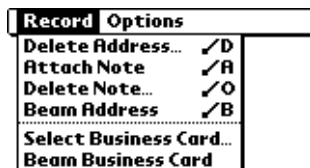

Address View

Options menus



Address List



Address View

Preferences

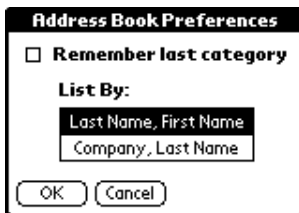

- Remember last category: Determines how Address Book appears when you return to it from another application. If you select this check box, Address Book shows the last category you selected. If you clear it, Address Book displays the All category.

Rename Custom Fields

These custom fields appear at the end of the Address Edit screen. Rename them to identify the kind of information you enter in them. The names you give the custom fields appear in all entries.



About Address Book

Shows version information for Address Book.

To Do List

A To Do List item is a reminder of some task that you have to complete. A record in To Do List is called an “item.”

To create a To Do List item:

1. Press the To Do List application button  on the front of your organizer to display the To Do List.
2. Tap New.

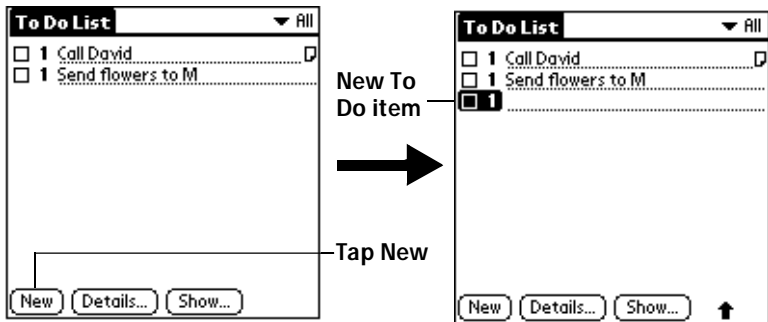

3. Enter the text of the To Do List item. The text can be longer than one line.
4. Tap anywhere onscreen to deselect the To Do List item.

Tip: If no To Do List item is currently selected, writing in the Graffiti writing area automatically creates a new item.

Setting priority

The priority setting for items lets you arrange the tasks in your To Do List according to their importance or urgency. The default setting for the To Do List is to arrange items by priority and due date, with priority 1 items at the top. If you have a number of items in your list, changing an item’s priority setting may move its position in the list.

Note: When you create a new To Do List item, its priority is automatically set to level 1, the highest (most important) level. If you select another item first, however, the item you create appears beneath the selected item and is given the same priority as the selected item.

To set the priority of a To Do List item:

1. Tap the Priority number on the left side of the To Do List item.

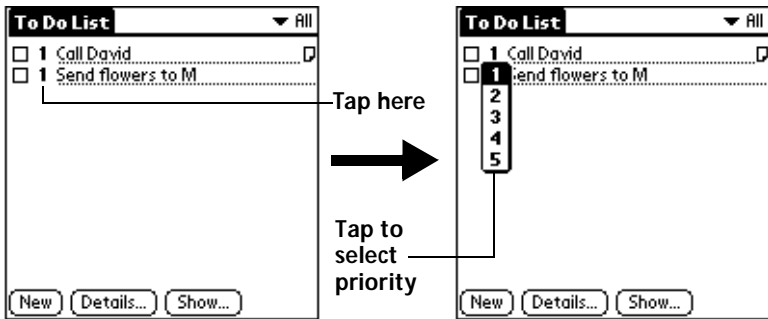

2. Tap the Priority number that you want to set (1 is most important).

Checking off a To Do List item

You can check off a To Do List item to remind yourself that you've completed it. You can set the To Do List to record the date that you complete the To Do item, and you can choose to show or hide completed items. See "To Do Show Options" later in this chapter.

To check off a To Do List item:

- Tap the check box on the left side of the item.

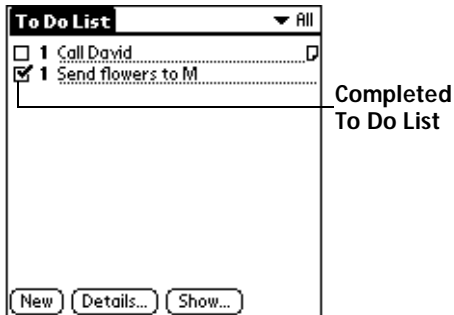

Changing To Do List item details

The To Do Item Details dialog box enables you to change settings for individual items.

To display the To Do Item Details dialog box:

1. Tap the text of the item whose details you want to change.
2. Tap Details.



Setting a due date

You can associate a due date with any To Do List item. You can also sort the items that appear in the list based on their due date.

To set a due date for a To Do List item:

1. In the Details dialog box, tap “No Date” to open the Due Date pick list.

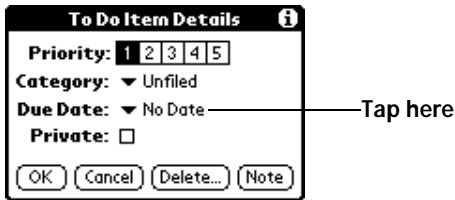

2. Tap the date that you want to assign the item:

Today: Assigns the current date.

Tomorrow: Assigns tomorrow’s date.

One week later: Assigns the date exactly one week from the current date.

No Date: Removes the due date from the item.

Choose Date: Opens the date selector, where you can choose any date that you want for the item.

3. Tap OK.

Tip: If you turn on the Show Due Dates option in the To Do Show options dialog, you can tap directly on the due date in the To Do List to open the pick list shown in step 2.

To Do Show Options

The Show Options dialog box enables you to control the appearance of To Do List.

To change the Show Options settings:

1. In To Do List, tap Show.



2. Select any of the following settings:

Show Completed Items: Displays your completed items in the To Do List. If you turn off this setting, your To Do items disappear from the list when you complete (check) them.

Items that no longer appear on the list because you turn off this setting have not been deleted. They are still in the memory of your organizer. Purge completed items to remove them from memory.

Show Only Due Items: Shows only the items that are currently due, past due, or have no due date specified. When this setting is active, items that are not yet due do not appear in the list until their due date.

Record Completion Date: Replaces the due date with the actual date when you complete (check) the item. If you do not assign a due date to an item, the completion date still records when you complete the item.

Show Due Dates: Displays the due dates associated with items in the To Do List and displays an exclamation mark next to items that remain incomplete after the due date passes.

Show Priorities: Shows the priority setting for each item.

Show Categories: Shows the category for each item.

3. Tap OK.

To Do List menus

To Do List menus are shown here for your reference, and To Do List features that are not explained elsewhere in this book are described here.

See “Using menus” in Chapter 1 for information about choosing menu commands.

Record menu

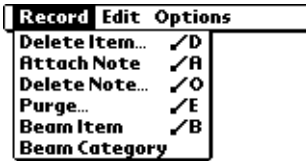

Options menu



About To Do List Shows version information for To Do List.

Memo Pad

A memo can contain up to 4,000 characters. The number of memos you can store is dependent only on the memory available on your organizer. A record in Memo Pad is called a “memo.”

To create a new memo:

1. Press the Memo Pad application button  on the front of your organizer to display the Memo List.
2. Tap New.

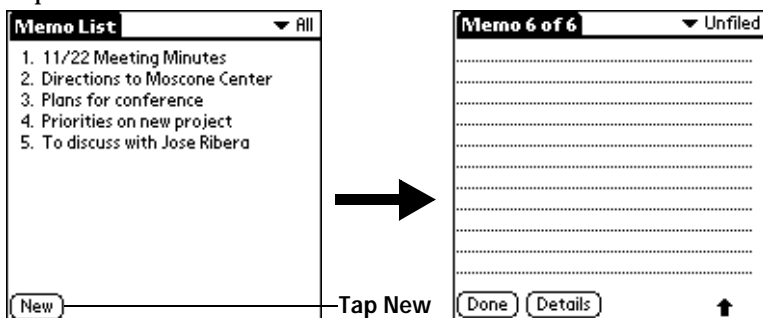

Tip: In the Memo List screen, you can also begin writing in the Graffiti writing area to create a new memo. The first letter is automatically capitalized and begins your new memo.

3. Enter the text you want to appear in the memo. Use the carriage return stroke to move down to new lines in the memo.
4. Tap Done.

Reviewing memos

The first line of a memo appears in the Memo List. This makes it easy to locate and review your memos.

To review a memo:

1. In the Memo List, tap the text of the memo.

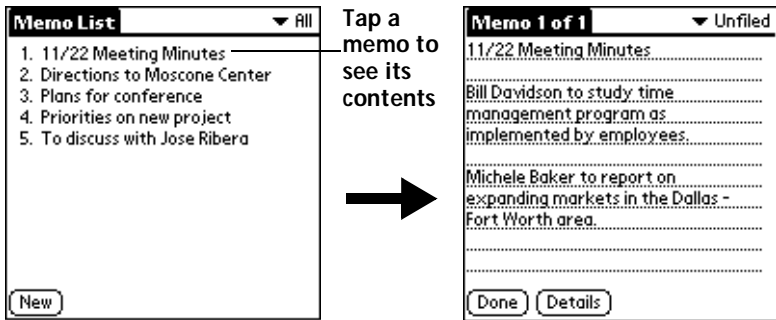

2. Review or edit the text in the memo.
3. Tap Done.

Memo Pad menus

Memo Pad menus are shown here for your reference, and Memo Pad features that are not explained elsewhere in this book are described here.

See “Using menus” in Chapter 1 for information about choosing menu commands.

The Record and Options menus differ depending on whether you’re displaying the Memo List or an individual memo.

Record menus

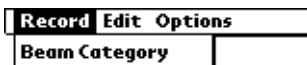

Memo List

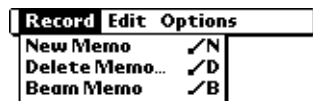

Memo screen

Options menus

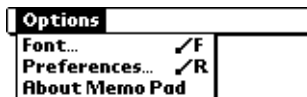

Memo List



Memo screen

Go to Top of Page	Moves to the top (first) line of the memo.
Go to Bottom of Page	Moves to the bottom (last) line of the memo.
Preferences	Displays the Memo Preferences dialog box, where you define the sort order for memos.
About Memo Pad	Shows version information for Memo Pad.

Calculator

The Calculator includes several buttons to help you perform calculations.



Clears the last number you entered. Use this button if you make a mistake while entering a number in the middle of a calculation. This button enables you to re-enter the number without starting the calculation over.



Clears the entire calculation and enables you to begin a fresh calculation.



Toggles the current number between a negative and positive value. If you want to enter a negative number, enter the number first *and then press* the +/- button.



Places the current number in memory. Each new number you enter with the M+ button is *added to the total* already stored in memory. The number that you add can be either a calculated value or any number you enter by pressing the number buttons. Pressing this button has no effect on the current calculation (or series of calculations); it merely places the value into memory until it is recalled.



Recalls the stored value from memory and inserts it in the current calculation.



Clears any value that is stored in the Calculator memory.

Recent Calculations

The Recent Calculations command enables you to review the last series of calculations and is particularly useful for confirming a series of “chain” calculations.

To display recent calculations:

1. Tap the Menu icon .
2. Tap Options, and then tap Recent Calculations.

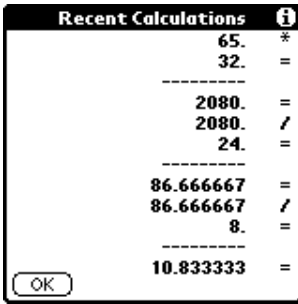

3. After you finish reviewing the calculations, tap OK.

Calculator menus

Calculator menus are shown here for your reference, and Calculator features that are not explained elsewhere in this book are described here.

See “Using menus” in Chapter 1 for information about choosing menu commands.

Options menus

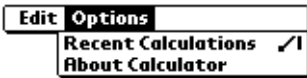

About Calculator Shows version information for Calculator.

Expense

Expense enables you to record the date, expense type, and the amount that you spent. A record in Expense is called an “item.” You can sort your Expense items into categories or add other information that you want to associate with the item.

To create an Expense item:

1. Tap the Applications icon .
2. Tap Expense.
3. Tap New.

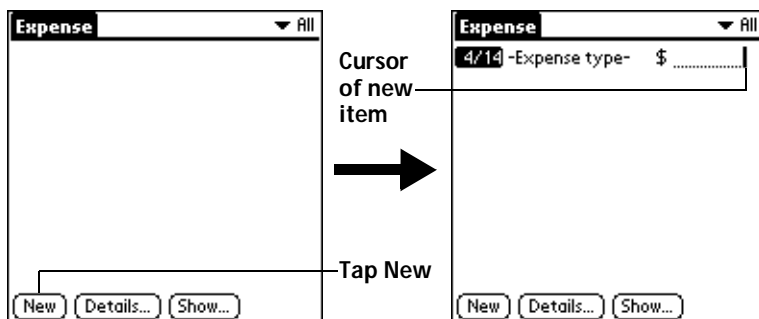

Tip: You can also create a new Expense item by writing on the number side of the Graffiti writing area while in the Expense List screen. The first number you write begins your new Expense item.

4. Enter the amount of the expense.
5. Tap the Expense type pick list and select a type from the list.

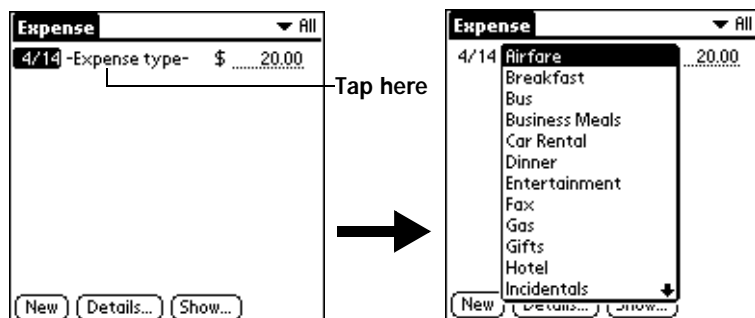

Note: As soon as you select an expense type, your organizer saves your entry. If you do not select an expense type, it does not save the entry.

Tip: A quick way to create a new Expense item is to make sure that no Expense item is selected in the Expense List, write the first letter(s) of the expense type, and then write the numerical amount of the Expense item. This technique takes advantage of the automatic fill feature. See “Options menu” later in this chapter for details.

Changing the date of an Expense item

Initially, Expense items appear with the date you enter them. You can use Expense to change the date associated with any Expense item.

To change the date of an Expense item:

1. Tap the Expense item you want to change.
2. Tap the date of the selected item.

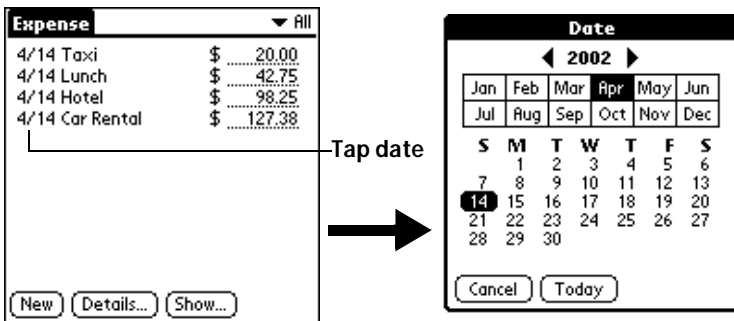

3. Tap the new date.

Entering receipt details

Expense provides a variety of options that you can associate with an item. These options appear in the Receipt Details dialog box.

To open the Receipt Details dialog box:

1. Tap the Expense item to which you want to assign details.
2. Tap Details.

The screenshot shows the 'Receipt Details' dialog box. It contains the following fields and options:

- Category:** ▼ Unfiled
- Type:** ▼ Lunch
- Payment:** ▼ Unfiled
- Currency:** ▼ \$
- Vendor:**
- City:**
- Attendees:** Who...

At the bottom of the dialog box are four buttons: OK, Cancel, Delete, and Note.

3. Select any of the following options:

Category: See “Categorizing records” earlier in this chapter.

Type: Opens a pick list of expense types.

Payment: Lets you choose the payment method used to pay the Expense item. If the item is prepaid (such as airline tickets supplied by your company), you can choose Prepaid to place your expense in the appropriate company-paid cell of your printed expense report spreadsheet. See “Transferring your data to Microsoft Excel” later in this chapter for more information.

Currency: Enables you to choose the type of currency used to pay the Expense item. The default currency unit is defined in the Preferences dialog (see “Options menu” later in this chapter). You can also display up to four other common types of currency. See “Customizing the Currency pick list” later in this chapter for more information.

Vendor and City: Lets you record the name of the vendor (usually a company) associated with the expense and the city where the expense was incurred. For example, a business lunch might be at Rosie's Cafe (Vendor) in San Francisco (City).

Attendees: See “Looking up names to add to expense records” earlier in this chapter.

4. Tap OK.

Customizing the Currency pick list

You can select the currencies and symbols that appear in the Currency pick list.

To customize the Currency pick list:

1. Tap the Currency pick list in the Receipt Details dialog box, and then select Edit currencies.

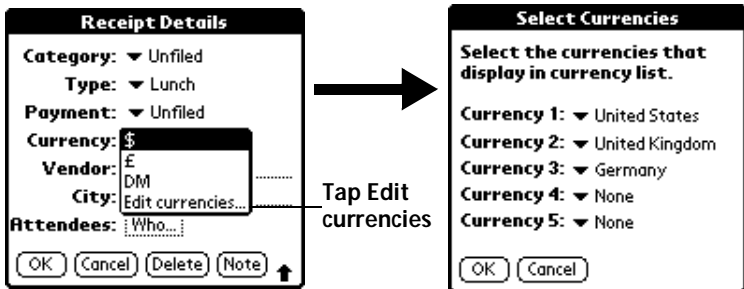

2. Tap each Currency pick list and select the country whose currency you want to display on that line.
3. Tap OK to close the Select Currencies dialog box.
4. Tap OK.

Defining a custom currency symbol

If the currency you want to use is not in the list of countries, you can create your own custom country and currency symbol.

To define a custom currency symbol:

1. Tap the Menu icon .
2. Tap Options, and then tap Custom Currencies.
3. Tap one of the four Country boxes.

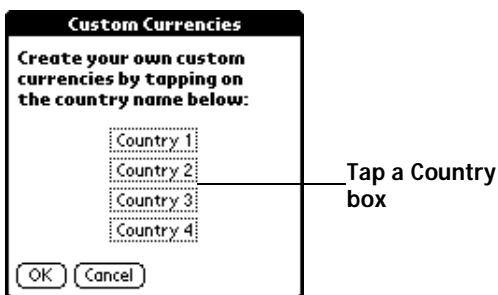

4. Enter the name of the country and the symbol that you want to appear in Expense.



5. Tap OK to close the Currency Properties dialog box.
6. Tap OK.

Note: If you want to use your custom currency symbol as the default for all Expense items, select the symbol in the Preferences dialog box. If you want to use your custom currency symbol only for a particular Expense item, select the symbol in the Receipt Details dialog box associated with that item.

Show Options

Show Options define the sort order and other settings that relate to your Expense items.

To open the Show Options dialog box:

1. In the Expense List, tap Show.
2. Select any of the options.

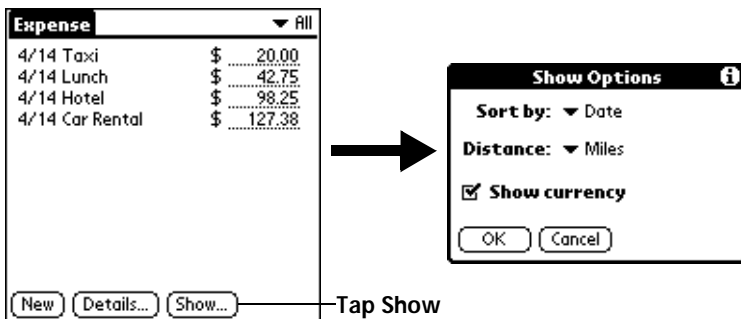

Sort by: Enables you to sort expense items by date or type.

Distance: Enables you to display Mileage entries in miles or kilometers.

Show currency: Shows or hides the currency symbol in the Expense List.

3. Tap OK.

Transferring your data to Microsoft Excel

After you enter your expenses into the Expense application on your organizer, Palm Desktop software enables you to view and print the data with your computer.

Note: You need Microsoft Excel version 5.0 (or later) to view and print your Expense data using one of the provided templates. Microsoft Excel is *not* included with the Palm VII organizer package. The procedures in this section also assume that you have installed Palm Desktop software. See “Palm Desktop organizer software” in Chapter 1 for more information.

Creating or printing an expense report

You can use Palm Desktop software to view and print your Expense data in a Microsoft Excel spreadsheet.

To create or print an expense report:

1. Perform a HotSync operation to transfer your latest Expense data to your computer.
2. Click Expense in Palm Desktop software to open Microsoft Excel and the Expense Report configuration dialog box.

Note: If you launch Expense from the Start menu instead of Palm Desktop software, you must first choose your organizer user name.

3. Click the expense category that you want.

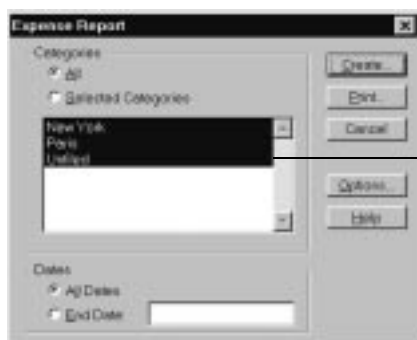

Click to select
Categories

Tip: You can press Ctrl+click to select multiple categories. To print the expenses associated with all of your Expense categories, select All in the Categories group.

4. If you want to define an end date for the expense report, enter the date in the End Date box.

Note: If you do not specify an end date, all expense entries for the selected categories appear — up to the date of the last HotSync operation.

5. Do one of the following:

Click Print to display the expense report in the Print Preview window, and then click Print in the Microsoft Excel window to print your expense report.

Click Create to display a Microsoft Excel spreadsheet containing your expense data. Your data appears in Microsoft Excel spreadsheet form. You can enter information, make formatting changes, and save and print the file in the normal manner.

Using expense report templates

Palm Desktop software includes several expense report templates. When you use one of these templates, you can edit your expense data in Microsoft Excel.

The templates have the extension .xlt and are stored in the template folder in the Palm Desktop software directory on your computer. To see what a template looks like before you use it, open the template in Microsoft Excel. For example, the template Sample2.xlt looks like this:

The screenshot shows the Microsoft Excel interface with the 'Sample2.xlt' template open. The spreadsheet is organized into several sections for recording expenses:

- Travel Expense Report:** Includes fields for Name, Expense, Approval, Date, and Mileage (Mile).
- LODGING:** Includes rows for Lodging & Hotel, Laundry, Taxi, and Lodging/Hotel.
- MEALS:** Includes rows for Breakfast, Lunch & Dinner, Dinner, and Meals total.
- BUSINESS:** Includes rows for Business meals, Conference, Entertainment, and Business total.
- TRANSPORTATION:** Includes rows for Airfare, Auto Rental, Auto Miles/Gas, Local Transportation, Tolls/Parking, Mile @ \$0.00 / mile, and Transportation total.
- MISCELLANEOUS:** Includes rows for Gifts, Telephone & Fax, Supplies, Postage, Others, and Misc. total.
- TOTAL:** A summary row for the total expense.

At the bottom right, there are fields for 'Less: work advance', 'Due employee', and 'Due company'. The spreadsheet has columns numbered 1 through 25 and rows numbered 1 through 65.

If you want to streamline or customize your expense reports, you can change these templates. For example, you can add your company

name to a template. See Appendix C for information on changing templates.

To view your expense data using a Microsoft Excel template:

1. Display your expense data in a Microsoft Excel spreadsheet as described in the previous procedure.
2. Click Options.

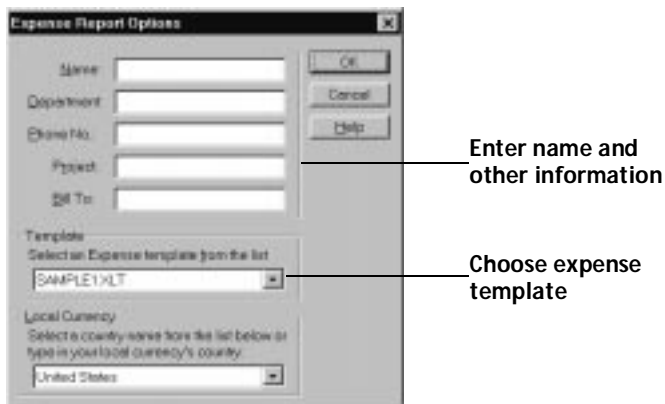

3. Enter name, department, and other information as necessary for your expense report.
4. Click the Templates menu; then select an expense template.

Note: If you want to create your own custom expense template and have it appear in the Templates menu, see Appendix C for more information.

5. Click OK.

Expense menus

Expense menus are shown here for your reference, and Expense features that are not explained elsewhere in this book are described here.

See “Using menus” in Chapter 1 for information about choosing menu commands.

Record menu

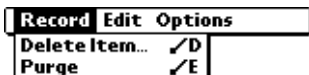

Options menu



Preferences

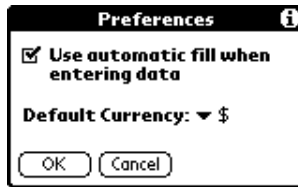

- **Use automatic fill:** Lets you select an expense type by writing the first letter of an expense type in the Graffiti writing area. For example, if you write the letter “T,” it enters the “Taxi” expense type. Writing “T” and then “E” enters “Telephone” which is the first expense type beginning with the letters “TE.”
- **Default currency:** Sets the default currency symbol for Expense.

About Expense Shows version information for Expense.

Chapter 5

Query Applications and the iMessenger™ Application

Your organizer is a wireless device

Your Palm VII™ organizer is equipped with an internal transmitter and an antenna. These components enable your organizer, like a cellular phone, to use a radio frequency to transmit and receive information over the airwaves.

You don't need a modem or a wired connection to a computer to use your organizer as a wireless device, but you must activate the Palm.Net™ wireless communication service. See "Activating the Palm.Net wireless communication service" in Chapter 1 for more information.

After you activate the service, you have access to two wireless features that enhance your ability to stay connected: web clipping and wireless Internet messaging. This chapter describes those features and explains how to use them.

Important: Whenever you use the wireless features of your organizer, please observe the guidelines or prohibitions on the use of wireless devices in your current location. For example, when you are on an airplane, do not raise the antenna or use the wireless features at times when the Federal Aviation Administration (FAA) or airline regulations prohibit the use of cellular phones. You can, of course, use all other applications of your organizer in accordance with airline regulations for electronic devices.

Web clipping: query applications

Web clipping is a fast and simple way to retrieve specific information from the Internet. It is a simple process of query-and-response: You submit a request for specific information from the Internet and tap a button that transmits your request; within seconds, you receive a response.

Query applications

Just as your web browser gives you access to many different web sites, your organizer gives you access to many different “sites” for web clipping — as many as you care to add and your organizer can store. If you have already set up your organizer, you have some already.

These “sites” are called *query applications*. They were created by third-party developers, but you open them and use them just as you would a basic Palm VII application like Address Book.

Query applications give you access to a wide spectrum of practical Internet information. Each query application is designed to let you query the Internet for a specific kind of information.

For example, the query applications available to you when you set up your organizer and install Palm™ Desktop organizer software give you access to the following kinds of information: traffic and weather conditions; airline, hotel, and restaurant information; locations of automatic teller machines; driving directions; stock market data; movie listings; availability of tickets to local events; business and general news; definitions, spelling, and synonyms of words; and business and residential phone numbers, addresses, and e-mail addresses.

Web clipping, not web browsing

It’s impractical to browse the Internet from a small handheld computer and look at elaborate, animated, graphics-laden web pages on a screen the size of your organizer’s. As a way to access Internet information, web clipping offers you the following advantages:

- **Convenience:** Because your organizer is a wireless device, you can be walking down the street while accessing the Internet.
- **Focus:** Query applications focus on retrieving small pieces of specific, up-to-date information.

So when you're near a desktop computer and have some time, you can take advantage of the elaborate graphics, variety, and many choices offered by a web site —



But when you're in a car or on the street and need information fast, a query application on your organizer makes it easy to find the specific information you need —



Adding more query applications

When you set up your organizer, you find that several query applications have been preloaded onto your organizer.

When you install Palm Desktop software on your computer, you can select many more query applications. Use the Install Tool to transfer these to your organizer.

Still more query applications are available on the web site <http://www.palm.net>.

You add query applications to your organizer just as you would any other application. See “Installing add-on applications” in Chapter 3 for details.

Wireless Internet messaging: the iMessenger application

Using the iMessenger application on your organizer, you can send and receive short text messages.

Your organizer is part of the Palm.Net network. This network receives and stores messages sent to you at your Palm.Net address, and it delivers any message you send directly from your organizer to the Internet e-mail address you specify.

When you activate the Palm.Net wireless communication service, you acquire an address on the network — for example, `username@palm.net`. Then, whenever you’re within coverage of the network, you can communicate with anyone who has an Internet e-mail account.

Important: The iMessenger application is completely independent of the Mail application. Mail does not use the transmitter or the Palm.Net wireless communication service. See “The iMessenger application differs from the Mail application” later in this chapter for details. See Chapter 6 for information about Mail.

The Palm.Net wireless communication service

The Palm.Net wireless communication service includes the following:

- The network through which you access the Internet.
- The web site on which you can track your usage of the service, learn about the service and its features, and find new query applications to download.
- The Palm.Net query application, in which you can also track your usage of the service and learn about the service and its features.

- Customer Care. See the *Getting Started* guide for the support e-mail addresses and phone numbers.
- Convenient credit card billing.

The network

The Internet is often described as a “network of networks,” and the Palm.Net network is just another network tied into the Internet.

The advantage of the Palm.Net network is that your organizer has a wireless, over-the-air connection to it. So long as one of the radio transmitter/receivers of the network can pick up the signal sent by your organizer — referred to as being “within coverage” — you can use query applications and the iMessenger application.

Note: See the important notice at the beginning of this chapter about observing regulations on the use of wireless devices on airplanes and in other locations where their use may be restricted.

Protection of your wireless transactions

Your organizer is equipped with next generation encryption technology from Certicom. This encryption technology is used to secure your credit card number when you activate the Palm.Net service. It is also used by various query applications to secure the transmission of sensitive information such as messages and passwords that are sent over the Palm.Net network. Data is protected both when sent from your organizer over the network and when coming in from the Internet directly to your organizer.

When a wireless transaction is secured, the command button that initiates the transaction is marked not only by the over-the-air icon, but also by the security icon.

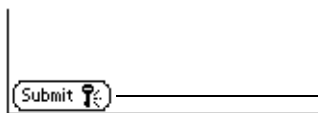

The security icon indicates that your transmission is encrypted

Encryption makes your data unreadable by anyone but the intended recipient. Encryption is done using elliptic curve cryptography, a technology developed by Certicom and used in a wide variety of consumer handheld devices and enterprise applications. For more information about Certicom’s encryption technology, visit the Certicom web site <http://www.certicom.com>.

It's not unusual to experience a delay of a several seconds when a wireless transaction is being encrypted.

In addition to the protection provided by the Palm.Net network, individual query applications may add another layer of protection to their transactions. For example, a query application may require you to create and use a password to access sensitive information (for example, your checking account).

See "Wireless preferences" in Chapter 8 for information about preventing the transmission of your location and identification. See "Security" in Chapter 3 for information about locking your organizer. See "Making records private" in Chapter 4 for information about hiding specific records.

The Palm.Net web site: <http://www.palm.net>

The Palm.Net web site is an important source of information about the wireless features of your organizer and about your use of the wireless communication service. The following features are available on the web site:

- **Coverage maps:** Review detailed maps that show where Palm.Net coverage is available. You can also look up a ZIP code to see if an area is within coverage. Go here if you want to report an area where the signal strength is too weak to perform wireless transactions.
- **My Account:** Check the current status of your account, in both summary and detailed (day-by-day) form. Go here to change your account information and password.

Note: Access to My Account is restricted to users who have an account with the Palm.Net wireless communication service. To access My Account, you must log in with the username and password you created during activation.

- **iMessenger application support:** Delete messages, designate a forwarding address, and designate an address to which to send a copy of all your outgoing messages.
- **Support:** Learn about Palm.Net services and wireless features, get answers to frequently asked questions, and submit questions to Palm.Net Customer Care.
- **Query Apps:** Download the latest query applications to your desktop computer.
- **Web Resources:** Order books about the Palm Computing® platform and sign up for InSync Online, an e-mail service that distributes

new query applications, tips about your organizer, and news about Palm Computing platform compatible products. Use the links on this site to visit hundreds of other sites related to products for the Palm Computing platform.

The Palm.Net query application

The Palm.Net query application is a condensed version of the web site. If you have a question about the service or your use of it, the query application is the first place to go to find your answer.

To open the Palm.Net query application:

- Tap the Palm.Net query application icon:  .

You can do the following in the query application:

- Check a summary of the current status of your account
- Read Customer Support topics
- Submit a question or comment to Customer Support

Improving signal strength

Radio signals can be blocked by many kinds of objects in the environment. Trying to perform wireless transactions using a weak signal requires more power from your batteries.

If you experience poor reception, often you can improve it simply by moving five or ten feet in any direction away from the spot where reception is poor. See “Wireless problems” in Appendix B for a list of steps you can take to improve reception.

As you move around to improve reception, you can monitor the increase or decrease in signal strength.

To monitor signal strength in the Diagnostics application:

- Tap the Diagnostics icon .

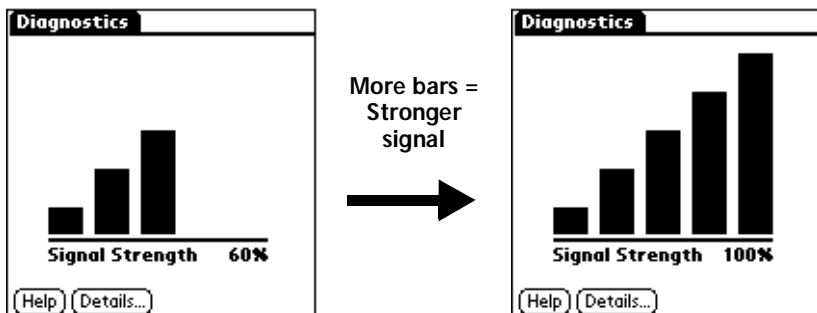

Both the bar graph and the number represent the signal strength:

- The graph represents signal strength as a series of bars. The more bars displayed, the stronger the signal.
- The number represents signal strength as a percentage. The higher the number, the stronger the signal.

You can also monitor signal strength from within query applications and the iMessenger application. A small version of the same bar graph you see in the Diagnostics application appears onscreen when you're performing a wireless transaction.

In query applications



In the iMessenger application



Using query applications

In general, web clipping is a simple process of query-and-response that works like this:

- You open the query application that provides the information you want. For example, you open a query application that reports the weather.
- You submit a query that requests specific information. For example, you ask what the weather forecast is for San Francisco.
- You tap a button that sends your request to the Internet.
- The query application sends your request to the Internet and returns, quickly, with a clipping that gives you only the specific piece of information that you requested.

Opening query applications

When you install query applications, they appear by default in the Palm.Net category of the Applications Launcher. The icons of query applications are easy to recognize: They all have a dark diamond shape as their background and include the over-the-air icon:

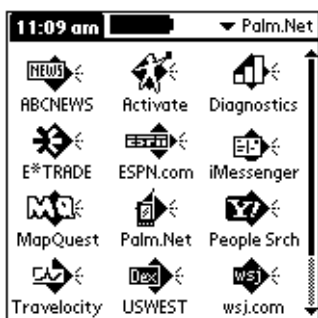

Palm.Net category of the Applications Launcher

Feel free to explore all of your query applications to find out what kind of information they offer. Despite the presence of the over-the-air symbol in its icon, you can open any query application without incurring any cost.

To open a query application:

1. Raise the antenna, located on the right side of your organizer.

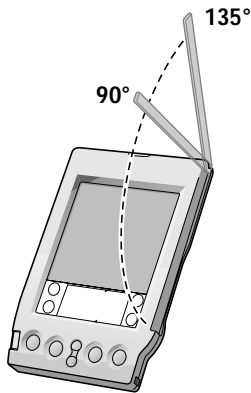

To ensure the best reception: If you are holding the organizer in your hand, raise the antenna to its position at 135°, located at the second click you feel as you raise the antenna. If the organizer is on a flat surface, raise the antenna to its position at 90°.

Raising the antenna automatically opens the Applications Launcher to the Palm.Net category. When the transmitter successfully connects to the network, your organizer beeps.

2. Tap the query application that queries the Internet for the kind of information you want.

Tip: You can set your organizer to open a specific application whenever you raise the antenna. See “Buttons preferences” in Chapter 8 for details.

Working with query applications

Query applications are designed so that you can use them as you use any of the basic applications. The skills you learn in other applications can be applied to working in query applications.

Query applications are similar to basic applications in the following ways:

- You tap to select an item or perform an action just as you do in other applications on your organizer.
- You use Graffiti® writing or the onscreen keyboard to enter text.
- Elements of the interface that look familiar — edit lines, pick lists, check boxes, scroll arrows, buttons, menus, etc. — behave in query applications as they behave in basic applications like Address Book or Memo Pad.

- In edit lines, you can select, cut, copy, and paste text as you do in other applications on your organizer.

Sorted pick lists

In query applications, pick lists of words sorted alphabetically or numbers sorted in ascending order work in the same way that Phone Lookup works: if you write the first letter of a word, the list scrolls to the first entry that begins with that letter. If you write the first two letters, the list scrolls to the entry that starts with those two letters; and so on, until the letters you write identify a unique entry.

For example, when you select a state from an alphabetical list of states, writing “m” causes the list to scroll to and select Maine. If you then write “o,” the list selects Montana and enters it in the field.

Actions that incur a cost

Tapping a command button or other object that displays the over-the-air icon initiates a wireless transaction. Typically, you incur a cost whenever you perform a wireless transaction. This cost takes the form of either (1) a deduction from the kilobytes included in your monthly plan or (2) if your monthly kilobytes have been used up, an additional charge. Consult <http://www.palm.net> or the Palm.Net query application for details on billing.

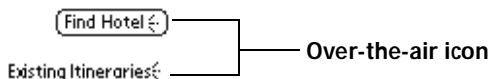

Simply reviewing the contents of a query application does not initiate a wireless transaction and costs nothing.

To submit a query to the Internet:

1. Raise the antenna.
2. Tap the icon of the query application you want to open.
3. Follow the directions onscreen for specifying the information you want from the Internet.

Some query applications need you to identify a location in order to give you useful information. For example, query applications that report the weather or list movie theaters need to know the location for which you want information. Such query applications may ask you to specify the ZIP code of the location you're interested in.

4. Tap the button or other object that displays the over-the-air icon to submit your query to the Internet.

The response — your clipping— typically appears onscreen within seconds.

To stop a wireless transaction:

- Tap the Stop icon.



Any data that is downloaded to your organizer before you tap the Stop icon appears onscreen.

Important: You incur a cost for any data that is downloaded to your organizer or sent to the Palm.Net server.

Reviewing current queries and clippings: Back arrow

Your organizer stores the queries and clippings of your current session so that you can review them. Use the Back arrow to review the pages you displayed since you opened the query application.

To go back to a previously viewed page:

- Tap the Back arrow ◀ in the query application you want to review.

Note: You do not incur a cost when you review pages.



Example of web clipping

This example takes you through the process of finding someone's phone number and address using the Yahoo!® People Search query application. This query application is preloaded on your organizer.

To find a phone number and an address:

1. Raise the antenna.

Raising the antenna automatically opens the Applications Launcher to the Palm.Net category. If you moved the Yahoo! People Search query application, go to that category.

2. Tap the Yahoo! People Search icon.

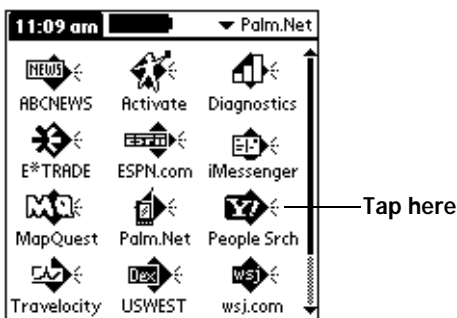

3. Tap the First Name edit line and enter the first name of a person whose address and phone number you want to find.

You can use Graffiti writing or the onscreen keyboard to enter data.

4. Enter the last name of the person and the city where the person lives.
5. Tap the State pick list and select the state where the person lives.

Tip: Writing the first few letters of the state you want causes the list to scroll to the first entry that begins with those letters. For example, write “ca” to select and enter California.

- 6. (Optional) If you want to find the address of the person, tap the Show Addresses check box to select it.
- 7. Tap Search.



Tap here to submit your query

Within seconds, your clipping appears. In this case, the query application found two items that satisfy your query.



How big was that clipping?

After you receive a clipping, you can find out the size of the clipping by tapping the title area of the screen. If you see two exclamation points (!!) there, the clipping is larger than 1,000 bytes.

To see the size of a clipping:

- Tap the title area. The title area expands to show how many bytes the clipping contains.



Reviewing stored clippings: History list

You can see a list of stored clippings in the History list and then select the one you want to review. You can see clippings that pertain only to the query application that is open. When you open another query application, the History list changes to display only clippings that you received in that query application.

Note: You do not incur a cost when you review clippings in the History list.

To review the History list:

1. Open the query application that has clippings you want to review.
2. Tap the History pick list.



3. Select the clipping you want to review.

Saving information from a query application

You can copy the text in a clipping or a page of a query application and paste it into another application. For example, you can copy an address you receive as a clipping from Yahoo! People Search and paste the address into Address Book.

To save the text of a clipping or page:

1. Make sure the clipping or page you want to copy is onscreen.

You can use the Back arrow or the History list to display the clipping or page you want.

2. Tap the Menu icon .
3. Tap Edit, and then tap Copy Page.
4. Open one of the basic applications, such as Address Book or Memo Pad.
5. Create a new record.
6. Tap the Menu icon.
7. Tap Edit, and then tap Paste.

Keep the following points in mind about the Copy Page command:

- Copying always starts at the top of the current clipping or page, regardless of what is displayed onscreen.
- The Copy Page command copies only the first 4,000 bytes (4KB) of data. If the clipping or page you copy contains more than 4KB of data, your organizer appends the word “truncated” to the end of the pasted text.
- The Copy Page command does not copy images or icons; table structures; or text formatting such as bold, italics, and so on.

Sending e-mail from a page

If a query application or clipping gives you the opportunity to reply to an e-mail address, you can do so.

To send e-mail from a page:

1. Tap the address displayed in the page.

The iMessenger application opens. The To: field contains the address to reply to.

2. Enter the text of your message.
3. Do one of the following:

Tap Put in Outbox to file the message in the Outbox. Your message is sent the next time you open the iMessenger application and tap Check & Send.

Tap Cancel, and then tap Yes to save the message in the Draft folder of the iMessenger application. Tap No to delete the message.

Query application menus

All query applications have the same menus. Query application menus are shown here for your reference, and query application features that are not explained elsewhere in this book are described here.

See “Using menus” in Chapter 1 for information about choosing menu commands.

Options menu



About Web Clipping

Shows version information for the web clipping technology that supports query applications.

Using the iMessenger application

 In addition to the Mail application and infrared (IR) beaming, which are explained in Chapter 6, your organizer offers you another way to stay in communication with others: wireless Internet messaging.

By activating the Palm.Net wireless communication service, you acquire an address and mailbox on the Palm.Net network. You can then use the iMessenger application to send and receive short text messages. Whenever you're within coverage of the network, you can use the iMessenger application to be in contact with anyone who has an Internet e-mail account.

In the iMessenger application, you can do the following:

- Download messages waiting for you on the Palm.Net network.
- Read, delete, reply to, and reroute incoming messages.
- Create outgoing messages and drafts of messages.
- Send messages to any Internet e-mail address directly from your organizer.

The iMessenger application differs from the Mail application

The iMessenger application is completely independent of the Mail application. You use them differently, and they do not interact in any way. You do not have to choose between Mail and the iMessenger application, however. You can use both.



Icon of the iMessenger application



Icon of the Mail application

One convenient similarity between the iMessenger application and Mail is this: skills you learn in one application you can easily transfer to the tasks you do in the other. For example, writing text, looking up addresses, viewing header information, saving drafts, and purging deleted items are all done the same way in both applications.

Mail depends on your computer

You use Mail to manage the e-mail that you receive in your desktop computer's E-Mail application. When you create e-mail items in Mail,

you cannot send them out directly from your organizer; rather, you must first synchronize your organizer with your computer. At that time, e-mail items you created in Mail are transferred to your desktop E-Mail application and sent out through that application. Mail does not use the transmitter or the Palm.Net wireless communication service. See Chapter 6 for complete information about Mail.

The iMessenger application is independent of your computer

The iMessenger application is a wireless feature. By taking advantage of the wireless capability of your organizer, the iMessenger application enables you to send and receive messages even though you may be miles away from any desktop computer. You work only with your organizer to create, send, receive, and otherwise manage messages. Synchronizing with your computer does not transfer iMessenger messages to your desktop E-Mail application.

Opening the iMessenger application

1. Raise the antenna, located on the right side of your organizer.

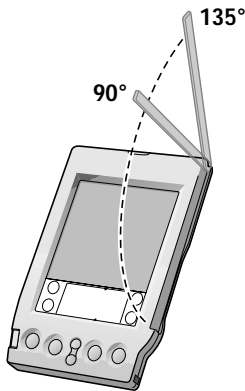

To ensure the best reception: If you are holding the organizer in your hand, raise the antenna to its position at 135°, located at the second click you feel as you raise the antenna. If the organizer is on a flat surface, raise the antenna to its position at 90°.

Raising the antenna automatically opens the Applications Launcher to the Palm.Net category. When the transmitter successfully connects to the network, your organizer beeps.

2. Tap the iMessenger icon .

Tip: You can set your organizer to open the iMessenger application directly whenever you raise the antenna. See “Buttons preferences” in Chapter 8 for details.

Checking for and viewing messages

The iMessenger List screen of the Inbox lists your downloaded messages, who sent them, and optionally, the date they were received. (See “Date column” later in this chapter.)

- Unread messages have a dash (—) next to them.
- Messages you’ve already read have a check mark (✓) next to them.
- Messages you create have a diamond (◆) next to them.

You can tap these symbols to open a menu of commands that you can use in the current context.

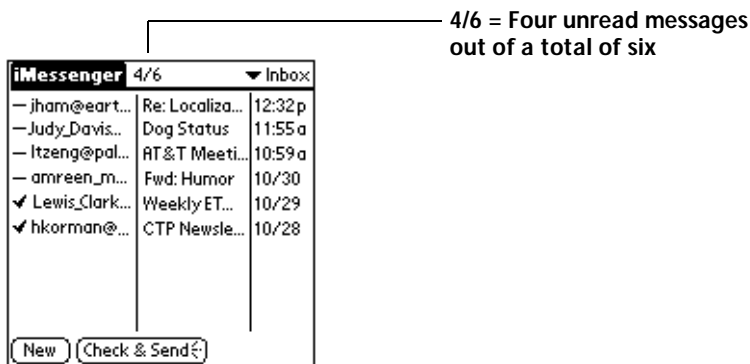

To check for new messages:

- Tap Check & Send.

Tapping Check & Send accomplishes two actions:

- Downloads messages that are waiting for you on the network
- Sends out messages that are in the iMessenger Outbox

A Transaction Progress message box appears onscreen and tracks the progress of the transaction.

The iMessenger application downloads no more than ten messages at a time to your organizer. The Transaction Progress message box notifies you if more messages are waiting for you on the network.

To cancel a wireless transaction:

- In the Transaction Progress message box, tap Cancel.

Any messages that were downloaded to your organizer before you tapped Cancel appear in the Inbox.

Important: You incur a cost for any data that was downloaded or sent to the server before you tapped Cancel.

To view a log of the most recent wireless transaction:

1. Tap the Menu icon .
2. Tap Options, and then tap Show Log.

To open a message:

- In the iMessenger List screen, tap a message to open it.

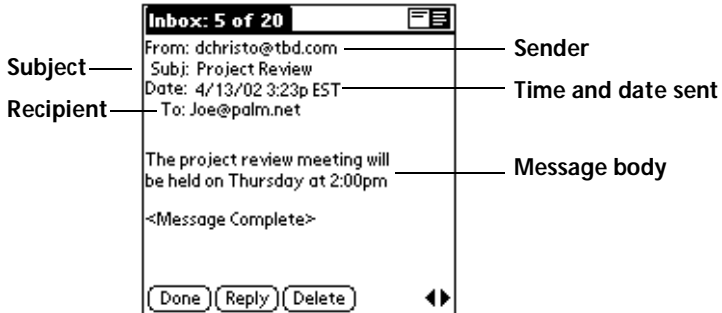

To close a message:

- Tap Done.

Opening and reading messages

A message is downloaded from the network in compressed characters. When you open the message, the characters are converted to an uncompressed, readable form.

The message arrives in segments, each comprising 500 readable characters.

Note: You are charged for the number of bytes downloaded as compressed characters, not by the number of readable characters.

Short messages and long messages

The following table outlines how incoming messages of various lengths are treated:

**If a message has x
readable characters**

500 or fewer characters

500 - 50,000 characters

More than 50,000
characters

Then this happens:

The entire message is downloaded.
<Message Complete> appears at the
end of the message.

The first 500 characters are
downloaded. A message at the end tells
you how many readable characters are
left to be retrieved. You can download
as much of the rest of the message as
you want or ignore what's left.

Palm.Net service returns the message
to the sender as undeliverable.



— Marks the end of a message

Tap right arrow to view the
next message, left arrow for
the previous one

Downloading the remainder of a long message

You download long messages in separate segments so that you can choose how much of the message you want to read (and pay for).

To download more of a long message:

1. At the bottom of the screen, tap More.

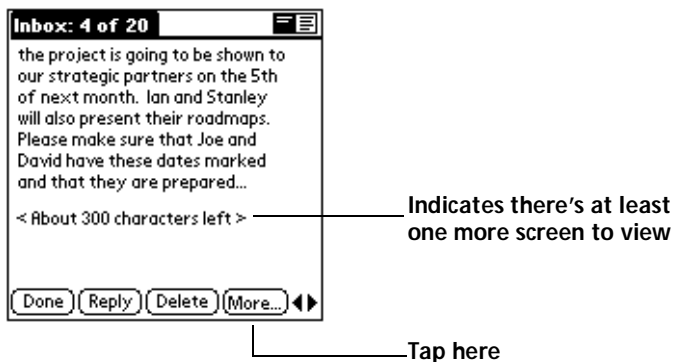

The Retrieve More dialog box appears.

2. Do one of the following:

For a message with fewer than 500 characters left, tap Get Rest.



For a message with more than 500 characters left, a different Retrieve More dialog box appears. Tap one of the following:

Get Next: Retrieves the next 500 characters of the message

Get Rest: Retrieves all the remaining text of the message



The maximum amount you can download in one transaction is 6,000 characters. If you want to get the rest of a message that has more than 6,000 characters left to download, you can download only 6,000 characters at one time. The Retrieve More dialog box looks like this:



Note: You don't have to download all the segments of a long message at one time. From the time you download the first 500 characters, you have a maximum of 30 days to download the remainder of the message. Then it's deleted from your mailbox on the Palm.Net network.

Displaying header information

Complete header information includes the distribution lists and the From:, Subj:, and Date: fields. By default, the iMessenger application displays abbreviated header information, which comprises only the From: and Subj: fields.



Abbreviated header icon

To display complete header information:

1. Open a message.
2. Tap the complete header icon.



Complete header icon

Tip: To redisplay the abbreviated header, tap the abbreviated header icon.

The iMessenger application uses the header type you select for all incoming messages.

Distribution lists of incoming messages

Distribution lists are the addresses in the To:, CC:, and BCC: fields of an incoming message. A maximum of 300 of the first 500 characters of a message is used to download the distribution lists. (A maximum of 100 characters is used to download the text in the Subj: field.)

If a distribution list must be truncated, an ellipsis (. . .) appears after the last name. There is no way to retrieve the truncated part of the list.

Your address (username@palm.net) always appears as the first address in the distribution list you are part of. After your address is downloaded, as much of the remaining information in the distribution lists is downloaded, up to the maximum 300 characters, in the following order: the To:, CC:, and BCC: fields.

Attachments

The iMessenger application does not support attachments, with one exception: If an attachment is a simple ASCII text file, the iMessenger application appends the text of the file to the end of the message, so you can read it as part of the body of the message.

Otherwise, when you open a message that was sent to you with any other kind of attachment, a message notifies you that the attachment cannot be downloaded. To prevent attachments from taking up space in your Palm.Net mailbox, delete the message as soon as you can.

One way to retrieve attachments sent to you is to have all messages delivered to your Palm.Net mailbox also delivered to your e-mail address. See “Identifying a forwarding address” later in this chapter.

Creating messages

To create a message in the iMessenger application, you identify the recipient(s) of the message, define a subject, and create the body of the message.

Note: A new message in the iMessenger application does not have CC: (copied) or BCC: (blind carbon copy) fields. You can, however, add as many names to the To: field as you like.

You create original messages and replies in the New Message screen. All messages must, at the very least, contain information in the To: field.

To create a message:

1. Tap New.

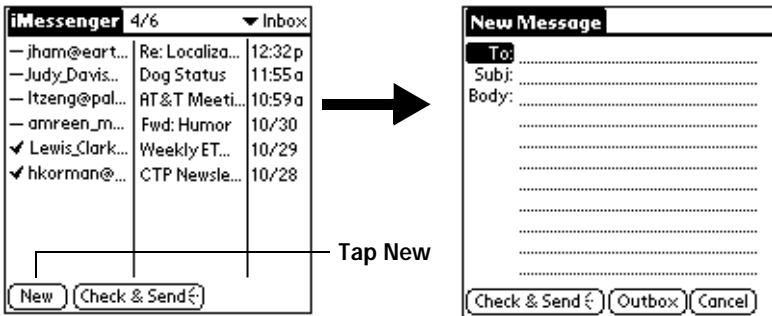

Tip: You can also create a message by tapping New from the Message menu.

2. Enter the e-mail address of the recipient.



You have two ways to enter the at sign (@):

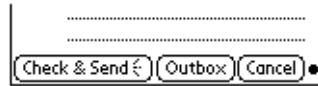

Tap once in the Graffiti writing area to activate Punctuation Shift. A dot appears

Then make this stroke



Or, tap "123" in the Graffiti writing area. Then tap @ on the numeric keyboard

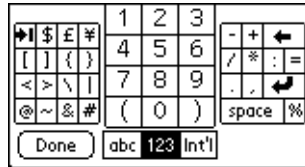

When you enter more than one address in the To: field, separate the addresses with commas or spaces, or enter each address on its own line.

3. Tap the Subj: field and enter a subject for your message.

4. Tap the Body: field and enter the text of your message.

Tip: If the address, subject, or body exceeds the capacity of the screen display, tap the name of the field (for example, tap “To:”) to expand that field. Tap the Done button to return to the New Message screen.

Tap the name of the field to open

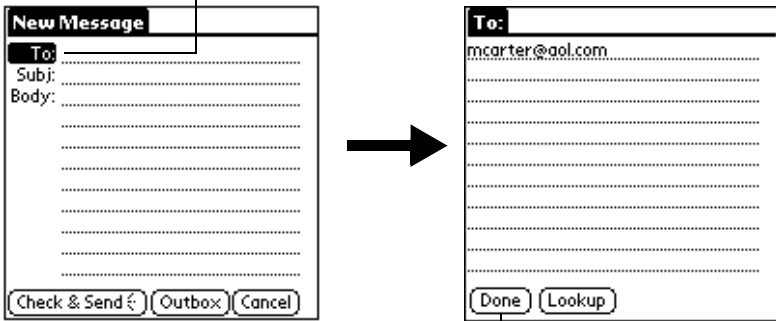

Tap to return to New Message screen

To reply to a message:

1. Tap a message in the iMessenger List to display it onscreen.
2. Tap Reply.
3. Select whom you want to reply to: Sender only or Forward (for someone who didn't see the original message).

Note: Although the iMessenger application does not have a “reply to all” option, you can add as many names to the To: field as you like.



4. Select whether you want to include original text and if so, whether you want to insert comments within the original text.

If you decide to insert comments, each line of the original text is marked with a >.

5. Tap OK.

6. Enter the text of your reply.
7. Tap Check & Send to send the message immediately. Tap Outbox to place the reply in the Outbox.

Looking up an address

To identify the recipient of a message, you need to enter that person's e-mail address. You can do this either by entering the data directly into the field or by using the Look Up command to access the information in your Address Book.

To look up an e-mail address:

1. Tap the To: field name to expand it.
2. Enter the first few letters of the last name of the person whose address you want to find.
3. Tap Lookup.
4. If the letters you enter identify a unique listing from your Address Book, your organizer completes the address for you. If not, the Lookup dialog box appears and lists all records that contain information in an E-mail field.

Tip: You can also open the Look Up dialog box in the New Message screen by tapping Lookup from the Options menu or by using the Graffiti Command stroke /L.

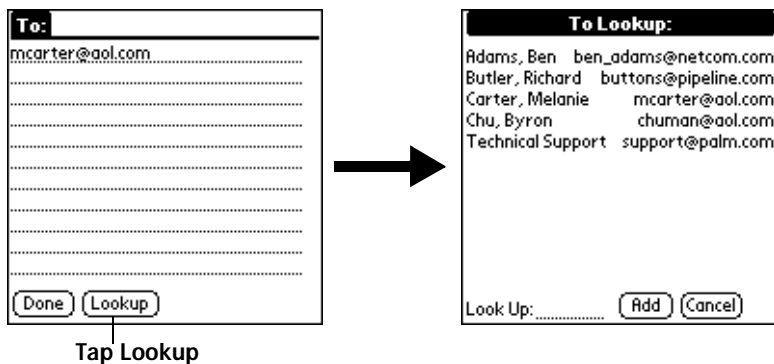

5. Enter the first letter of the entry you want to find to scroll to the first entry that begins with that letter. If you write an additional letter, the list scrolls to the first entry that starts with those two letters. For example, writing a "c" scrolls to "Carter," and writing "ch" scrolls to "Chu."

6. Tap an address to select it.
7. Tap Add.

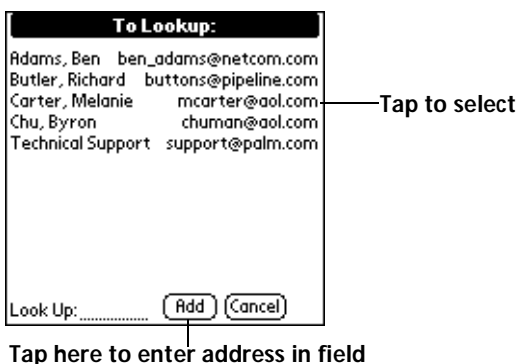

Rerouting replies to your messages

The From: field of your outgoing iMessenger messages contains your @palm.net address. If you don't want people who receive your messages to reply to you at your @palm.net address, you can specify a different address for recipients to use.

To reroute replies to your messages:

1. Tap the Menu icon .
2. Tap Options, and then tap Preferences.
3. In the edit line for Reply To Address, enter the address where you want to receive replies to your messages.



4. Tap OK.

When recipients reply to your message, their e-mail application automatically uses the Reply To address that you specify.

Note: The iMessenger application uses this address for *all* wireless Internet messages you subsequently send.

Adding a signature to your message

Adding a signature to your message is a two-part process. First, you create your signature. Then, every time you want to add your signature to a message, you must tap Add Signature.

The signature for your wireless Internet messages can be different from the signature you define in the Mail application.

To create a signature:

1. Tap the Menu icon .
2. Tap Options, and then tap Preferences.
3. Tap Signature.
4. Enter the text of your signature.

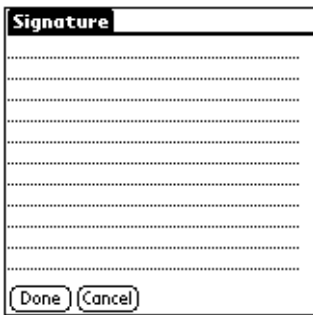

5. Tap Done.

To add a signature to your message:

1. In the new message you're creating, position the blinking cursor where you want to insert your signature.
2. Tap the Menu icon .
3. Tap Options, and then tap Add Signature.

Tip: You can also add your signature to the message by using the Graffiti Command stroke /Z.

The signature appears at the end of your message.

Sending messages

You can send wireless Internet messages anytime the organizer antenna is raised and you are located within coverage of the Palm.Net wireless communication service.

To send messages:

- Tap Check & Send.

Tapping Check & Send sends the current message and all messages in the Outbox. This command also downloads messages that are waiting for you on the network.

You can store messages in the Outbox and then send them at another time. For example, you can create messages and store them until you're in a location that is within coverage of the wireless communication service.

To store messages and send them later:

1. Create a message.
2. Tap Outbox.

The message is stored in the Outbox.

3. If you have more messages to write, repeat steps 1 and 2.
4. Tap Check & Send when you're ready to send the messages waiting in the Outbox.

To cancel a wireless transaction:

- In the Transaction Progress message box, tap Cancel.

Important: You incur a cost for any data that was sent to the server or downloaded before you tapped Cancel.

You can check the log to see which messages were sent.

To view a log of the most recent wireless transaction:

1. Tap the Menu icon .
2. Tap Options, and then tap Show Log.

Editing an unsent message

You can make changes to a message that has not yet been sent. When you edit a message, your organizer removes the message from the Outbox folder and takes you back to the New Message screen, where you can edit the message and resend it, save it as a draft, or delete it.

To edit an unsent message:

1. In the iMessenger List screen, tap Outbox from the pick list in the upper-right corner.

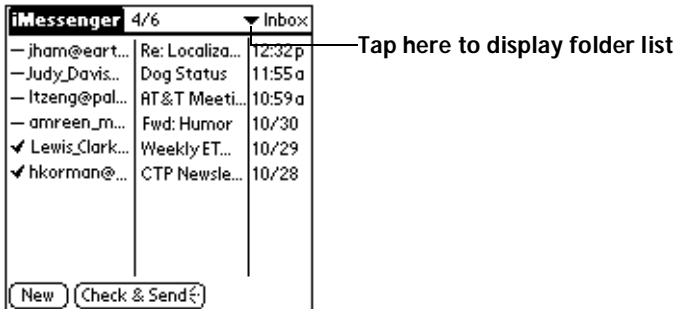

2. In the Outbox folder, tap the message you want to view.

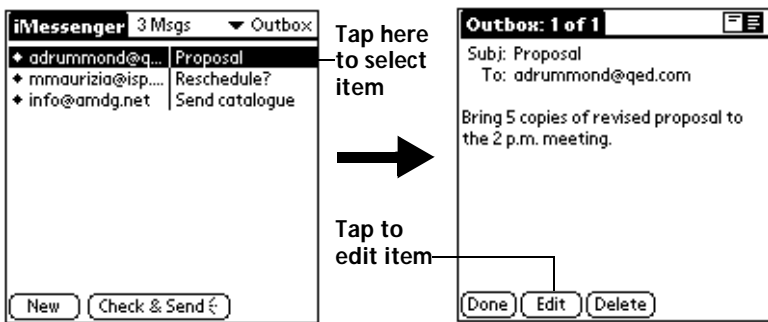

3. Tap Edit.

Draft messages

Sometimes you may not want to send a message immediately; for example, you may want to add additional information before sending it. Your organizer stores such messages in the Draft folder until you are ready to edit them again.

Note: When you're creating or editing a message, you can also save the item as a draft by canceling it. When you cancel a message, your organizer opens a dialog box asking if you want to save the message. If you tap Yes, your organizer saves the message in the Draft folder.

To save a message as a draft:

1. Create a message.
2. Tap the Menu icon .

3. Tap Message, and then tap Save Draft.

Tip: You can also save your message as a draft by using the Graffiti Command stroke /D.

To edit a message saved as a draft:

1. In the iMessenger List screen, tap Draft from the pick list in the upper-right corner.
2. Tap the draft you want to display.

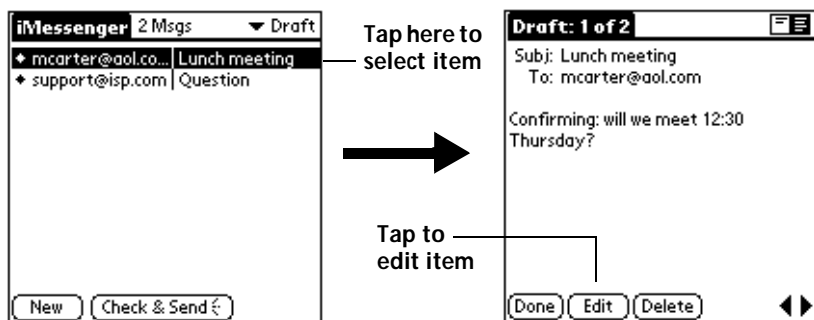

3. Tap Edit and enter your changes.

4. Do one of the following:

Tap Cancel and then Yes to save the message again as a draft.

Tap Check & Send to send the message.

Tap Outbox to move the item to your Outbox folder.

Filing a message

Your organizer can store any message you receive or create in the Filed folder.

To file a message:

1. Open the message.
2. Tap the Menu icon .
3. Tap Message, and then tap File.

To remove a message from the Filed folder:

1. In the iMessenger List screen, tap Filed from the pick list in the upper-right corner.
2. Tap the message you want to view.

3. Tap Edit or Reply to modify the message.

Tip: After you display and modify the message, you can send it now, move it to the Outbox, save it as a draft, or leave it in the Filed folder.

Deleting messages

Your organizer stores deleted messages in the Deleted folder until the folder reaches its maximum storage capacity of 50 kilobytes. At that point, messages in the Deleted folder are purged to make room for newly deleted messages. The message in the Deleted folder with the oldest date is purged first, then the one with the next oldest date, and so on, until there's enough space in the folder to hold the newly deleted message.

See “Purging deleted messages” later in this chapter to learn how to manage the size of the Deleted folder. See “Your Palm.Net mailbox” later in this chapter to learn about the storage and deletion of messages in your mailbox on the network.

To delete a message:

1. Open the message you want to delete.
2. Tap Delete.

Removing a message from the Deleted folder

You can remove a message from the Deleted folder and work with it again.

To remove a message from the Deleted folder:

1. In the iMessenger List screen, tap Deleted from the pick list in the upper-right corner.
2. Tap the message you want to restore.
3. Tap Undelete.

The organizer moves the message to the folder from which you deleted it and opens that folder.

Purging deleted messages

The Deleted folder has a maximum storage capacity of 50 kilobytes. To prevent deleted messages from taking up storage space on your organizer, purge the contents of your Deleted folder.

Note: You cannot restore messages after you purge them.

To purge the contents of the Deleted folder:

1. Tap the Menu icon .
2. Tap Message, and then tap Purge Deleted.
3. Tap Yes.

Tip: You can also purge deleted messages by using the Graffiti Command stroke /E.

Options for the iMessenger List screen

You can manage the way the iMessenger List screen displays information.

Folders

The iMessenger application provides folders for categorizing your messages. The iMessenger List screen displays the messages that are in the folder you select.

To select a folder:

1. Tap the pick list in the upper-right corner to open the list of folders:

Inbox: Contains messages downloaded from the network.

Outbox: Contains messages for which you tapped Outbox when you created them. Messages in the Outbox are sent out whenever you tap Check & Send.

Deleted: Contains messages you deleted. Purge these messages to free space on your organizer.

Filed: Contains messages you want to store on the organizer.

Draft: Contains messages you created but are not yet ready to send.

2. Select the folder you want to display.

Date column

The Date column is an optional part of the iMessenger List. By default, the Date column option is set to display. Turn it off to increase the amount of screen space available for the From: and Subj: fields.

Messages downloaded the same day on which they were sent display the time that they were received. Messages downloaded on a day after they were sent display the date they were received.

To show the Date column:

1. In the iMessenger List screen, tap the Menu icon .
2. Tap Options, and then tap Preferences.
3. Tap the Show Date check box to select it.

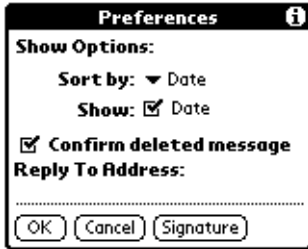

4. Tap OK.

Sorting the iMessenger List

You can sort messages by the date sent, by sender, or by subject.

To sort the iMessenger List:

1. In the iMessenger List screen, tap the Menu icon .
2. Tap Options, and then tap Preferences.
3. Tap the Sort by pick list and select one of the following options:
 - Date: Sorts by date and displays the most recent message at the top of the screen.
 - Sender: Sorts by sender's user name and displays messages in ascending alphabetical order, based on the first word of the From: field.
 - Subject: Sorts by subject and displays messages in ascending alphabetical order, based on the first word of the Subj: field.
4. Tap OK.

Your Palm.Net mailbox

Your mailbox on the Palm.Net network has a storage capacity of up to 2 MB; that's more than two million readable characters.

Attachments of messages in your mailbox take up storage space even though most attachments cannot be downloaded to your organizer. Messages that are larger than 50KB are not stored in your mailbox at

all because they cannot be delivered to your organizer; rather, they're returned to the sender as undeliverable.

A full mailbox

If your mailbox should run out of storage space, incoming messages are returned to the sender as undeliverable. To make room quickly in a full mailbox, you can delete blocks of messages. See "Deleting messages from your mailbox" below.

Life span of a message on the network

After you download the complete text of a message, or part of a long message, the message remains in your mailbox for 30 days. After 30 days, it is deleted from your mailbox.

Important: A message that you do not download to your organizer remains in your mailbox for 60 days. After 60 days, it is deleted from your mailbox.

Identifying a forwarding address

You can have all messages that are delivered to your Palm.Net mailbox also delivered to another address. Go to the My Account area of the web site <http://www.palm.net> and follow the instructions onscreen for identifying a forwarding address. This can be useful if you want to be able to retrieve attachments that are sent to you.

Keeping a copy of messages you send

You can keep a copy of your outgoing iMessenger messages by identifying an address to which to send a blind carbon copy of your messages. Go to the My Account area of the Palm.Net web site and follow the instructions onscreen for identifying a blind carbon copy address.

Deleting messages from your mailbox

You can delete blocks of messages directly from your Palm.Net mailbox. Go to the My Account area of the Palm.Net web site and follow the instructions onscreen. You can delete messages older than two weeks, older than four weeks, or all messages in the mailbox. You cannot look at your messages from the web site, and you cannot delete individual messages.

The iMessenger application and HotSync operations

The iMessenger application is independent of Palm Desktop software, with this exception: when you synchronize your organizer with Palm Desktop software, the following information is stored on your computer:

- Your iMessenger application preferences
- A record of what is currently in the iMessenger application, including the last message you downloaded from the network

This information becomes useful if you do a hard reset of your organizer. A hard reset erases all data on your organizer, including messages in the iMessenger application.

Important: *Synchronize immediately after you do a hard reset in order to restore the record of what messages were on your organizer before the hard reset.* Then the next time you use the Check & Send command, only messages you have not read yet are downloaded from the network.

See “Performing a hard reset” in Appendix A for more information.

To enable synchronization of the iMessenger application with a Macintosh computer, Macintosh users need a special version of Palm Desktop software. Go to the web site <http://www.palm.net> for information about this software.

iMessenger menus

iMessenger menus are shown here for your reference, and features that are not explained elsewhere in this book are described here.

See “Using menus” in Chapter 1 for information about choosing menu commands.

Pop-up menus

In the iMessenger List screen, tap the icon (a dash, check mark, or diamond) at the left to open a menu of commands that you can use in the current context.

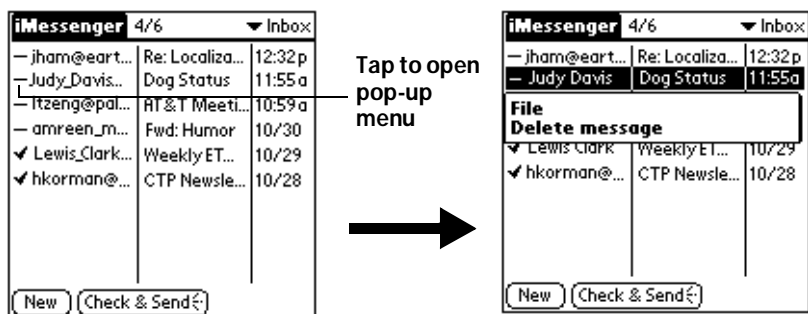

Message menus

The Message menu varies depending on whether you are viewing a message, creating a message, or viewing the iMessenger List.

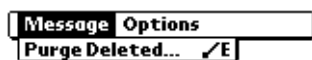

iMessenger List

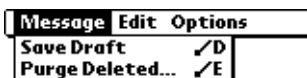

New Message

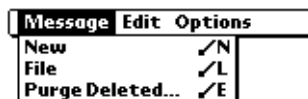

View Message

Options menus

The Options menu varies depending on whether you are viewing a message, creating, or viewing the iMessenger List.



iMessenger List



New Message



View Message

**About
iMessenger**

Shows version information for the iMessenger application.

Chapter 6

Managing Desktop E-Mail and Beaming Information

In addition to web clipping and wireless Internet messaging, your Palm VII™ organizer offers you the following features to help you stay connected:

- **Managing desktop E-Mail:** Using your organizer, you can read, reply to, compose, and delete e-mail from your desktop E-Mail application while you're away from your desk.

Note: This feature, called Mail, is completely independent of the iMessenger™ application, the application for wireless Internet messaging. Mail does not use the transmitter or the wireless communication service. See “The iMessenger application differs from the Mail application” in Chapter 5 for details.

- **Infrared (IR) beaming:** The infrared port located at the top of your organizer lets you send data from your organizer — including entire applications — to any other Palm Computing® platform device that's close by and also equipped with an IR port.

Managing desktop E-Mail away from your desk



Mail lets you manage the e-mail that you send and receive through the E-Mail application on your desktop computer. You can read, reply to, compose, and delete e-mail on your organizer; but to send or receive e-mail, you must perform a HotSync® operation either locally, using the organizer cradle, or remotely, using a Palm Modem® accessory or other modem.

The key to Mail is that it truly synchronizes the mail in the Inbox of your desktop E-Mail application with the mail on your organizer. For example, if you delete e-mail items from Mail, your next HotSync operation also deletes the e-mail items from your desktop E-Mail application, so you never have to delete e-mail items twice. Similarly, if you read an e-mail item on your organizer and leave it in your

Inbox, your next HotSync operation marks it as read in your desktop E-Mail application.

In Mail, you can do the following:

- View, delete, file, and reply to incoming mail.
- Create outgoing e-mail items and drafts of e-mail items.
- Create simple or complex filters, which allow you to decide the type of e-mail that your organizer retrieves from your desktop E-mail application.
- Use your organizer in its cradle to send and retrieve e-mail items from your desktop E-Mail application.

Setting up Mail on the desktop

Before you use Mail for the first time, make sure your desktop E-Mail application is up and running. You must also set up Palm™ Desktop organizer software for use with your desktop E-Mail application.

Your organizer supports a number of desktop E-Mail applications, such as Microsoft Exchange (version 4.0 or higher), Microsoft Windows Messaging 4.0, Microsoft Outlook 97, Microsoft Outlook Express, QUALCOMM Eudora (version 3.0.3 or higher), and Lotus cc:Mail (versions 2.5, 6.0, and 7.0). You can see the full list of the supported applications when you set up Mail.

If your desktop E-Mail application does not appear on the list, you may still be able to manage your desktop E-Mail application from your organizer by means of special connection software, called a conduit, that lets you synchronize your desktop E-Mail application and your organizer. Contact the vendor of your E-Mail application for more information.

Note: The following instructions assume that you have already installed Palm Desktop software on your computer and that you did not set up Mail during the installation. If you have not yet installed the Palm Desktop software, the installation procedure prompts you to set up Mail as part of the Palm Desktop software installation.

To set up Mail:

1. Click Start in the Windows taskbar.
2. Highlight Programs, highlight Palm Desktop software, and then click Mail Setup to begin setup.

3. Follow the instructions onscreen to set up your organizer for use with your desktop E-Mail application.

To select HotSync options:

1. Click the HotSync icon ™ in the Windows system tray (bottom-right corner of the taskbar).
2. Choose Custom.

Tip: You can also choose Custom from the HotSync menu in Palm Desktop software.

3. Select Mail in the list box.
4. Click Change.



5. Click one of the following settings:

Synchronize the files: Synchronizes the mail on your organizer and your desktop E-Mail application.

Desktop overwrites handheld: Replaces the mail on your organizer with the mail in your desktop E-Mail application. You should use this option only if, for some reason, the two inboxes get out of sync. This setting applies for only one HotSync operation and then reverts back to the default setting.

Do Nothing: Turns off communication between your organizer and desktop E-Mail application. This setting applies for only one HotSync operation and then reverts back to the default setting.

Set As Default: Changes the default setting on an ongoing basis. (When you first set up Mail, Synchronize the files is the default setting.)

Tip: To turn off Mail, select Do Nothing and then select the Set As Default check box.

To change your Mail setup options:

1. Click the HotSync icon  in the Windows system tray.
2. Choose Custom.

Tip: You can also choose Custom from the HotSync menu in Palm Desktop software.



3. Select Mail in the list box.
4. Click Change.
5. Modify your settings as needed.
6. Click OK.

Synchronizing Mail with your E-Mail application

After you enable and configure Mail, you need to perform a HotSync operation to synchronize Mail with your desktop E-Mail application. For a complete explanation of HotSync technology, see Chapter 7.

Opening the Mail application on your organizer

To open Mail:

1. Tap the Applications icon .
2. Tap the Mail icon .

Viewing e-mail items

The Message List lists the items of your incoming e-mail, who sent them, and the date they were received. E-mail items you've read have a check mark next to them. High-priority e-mail items appear in bold.

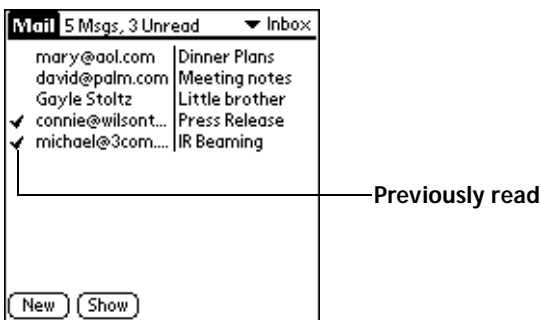

To open an e-mail item:

- Tap an e-mail item to open it.

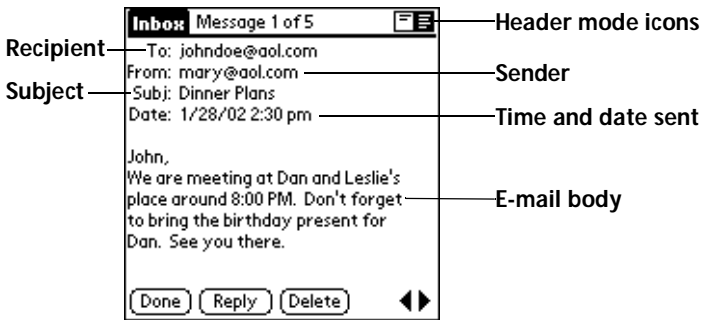

To close an e-mail item:

- Tap Done to close the e-mail item.

Displaying full header information

By default, Mail displays abbreviated header information, which comprises only the From: and Subj: fields. The full header provides complete information about the sender, receiver, and copied recipients, in addition to the subject and date the e-mail item was created. Mail uses the header type you select for all your e-mail items.

To display full header information:

1. Open an e-mail item.
2. Tap the complete header icon.

Tip: To redisplay the abbreviated header, tap the abbreviated header icon.

Creating e-mail items

You create e-mail items with your organizer the same way you create e-mail with your desktop E-mail application: you identify the recipient(s) of the e-mail item, define a subject, and create the body of the e-mail item.

You create original e-mail items and replies in the New Message screen. All e-mail items must, at the very least, contain information in the To: field.

To create an e-mail item:

1. Tap New.

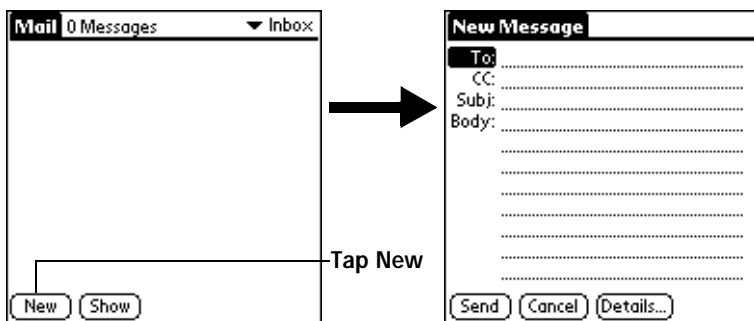

Tip: You can also create an e-mail item by tapping New from the Message menu.

2. Enter the e-mail address of the recipient.



Tip: Enter the address as if you were entering it from your desktop E-Mail application. For example, network users sending an e-mail item to a user on the same network do not need to add Internet information, such as @mycorp.com. When you enter more than one address in the To: field, separate the addresses with commas or spaces, or enter each address on its own line.

3. To send a copy of this e-mail item to additional recipients, tap the CC: field, and then enter the e-mail addresses of the additional recipients, separating the addresses with a comma followed by a space.
4. Tap the Subj: field and enter a subject for your e-mail item.
5. Tap the Body: field and enter the text of your e-mail item.

Tip: If the address, CC, subject, or body exceeds the capacity of the screen display, tap the name of the field (for example, tap “To:”) to expand that field. Tap the Done button to return to the New Message screen.

Tap the name of the field to open

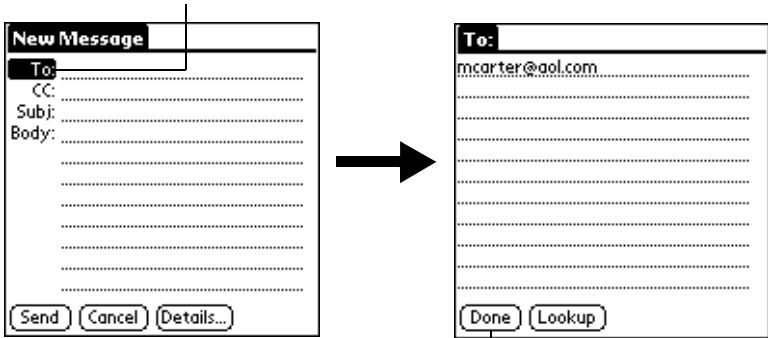

Tap to return to New Message screen

To reply to an e-mail item:

1. Tap an e-mail item in the Message List to display it onscreen.
2. Tap Reply.
3. Select whom you want to receive the reply: Sender only, All recipients, or someone who didn't see the original e-mail item (Forward).



4. Select whether you want to include original text or comment original text.
5. Tap OK.
6. Enter the text of your reply.

Tip: You have several options including setting the priority. See “Adding details to e-mail items” later in this chapter.

7. Tap Send to place your reply in the Outbox.

Looking up an address

To identify the recipient of an e-mail item, you need to enter that person's e-mail address. You can do this either by entering the data directly into the field or by using the Look Up command to access the information in your Address Book.

To look up an e-mail address:

1. Tap either the To: or CC: field name to expand it.
2. Enter the first few letters of the last name of the person whose address you want to find.
3. Tap Lookup.
4. If the letters you enter identify a unique listing from your Address Book, your organizer completes the address for you. If not, the Lookup dialog box appears and lists all records that contain information in an E-mail field.

Tip: You can also open the Look Up dialog box in the New Message screen by tapping Lookup from the Options menu or by using the Graffiti® Command stroke /L.

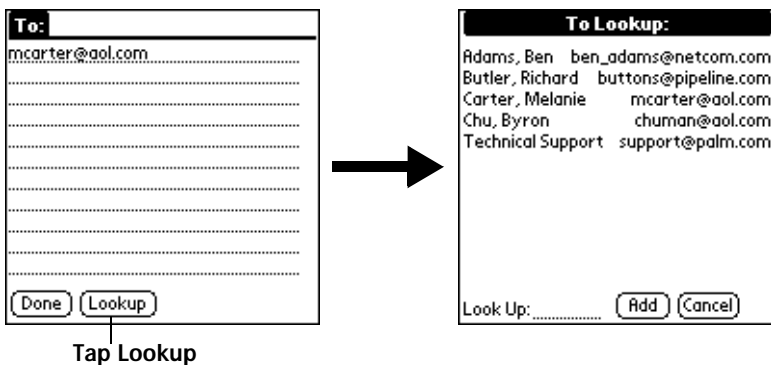

5. Enter the first letter of the entry you want to find to scroll to the first entry that begins with that letter. If you write an additional letter, the list scrolls to the first entry that starts with those two letters. For example, writing a "c" scrolls to "Carter," and writing "ch" scrolls to "Chu."
6. Tap an address to select it.
7. Tap Add.

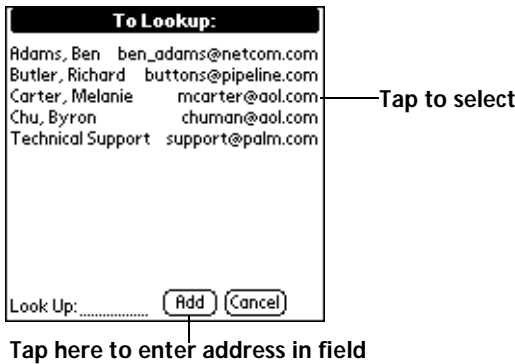

Adding details to e-mail items

Before you send your e-mail item, you can attach additional attributes to it, such as a signature or a priority level. These features are dependent on the desktop E-Mail application you use. If your application does not support the attribute you select, your organizer cannot attach that attribute to the e-mail item.

The following details are available:

Priority	Flags an e-mail item as High, Normal, or Low priority.
BCC	Creates a blind carbon copy field in the New Message screen.
Signature	Attaches previously defined text as the closing of an e-mail item. See “Adding a signature to your e-mail item” later in this chapter.
Confirm Read	Requests a confirmation telling you when the e-mail item was read.
Confirm Delivery	Requests a confirmation telling you when the e-mail item was delivered.

Note: The Priority and BCC settings are valid only for the current e-mail item and must be set for each item you create.

Setting a priority

To set a priority for your e-mail item:

1. In the New Message screen, tap Details.

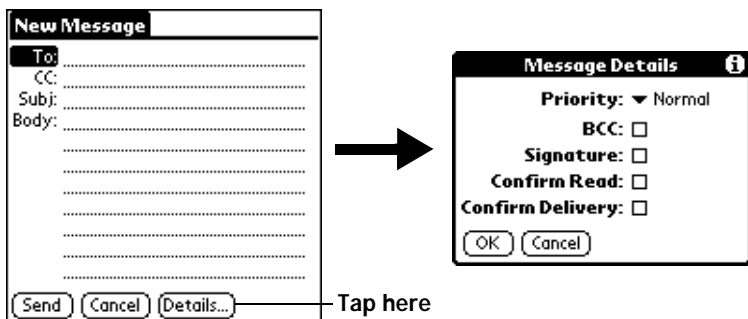

2. Tap the Priority pick list and select the priority you want.

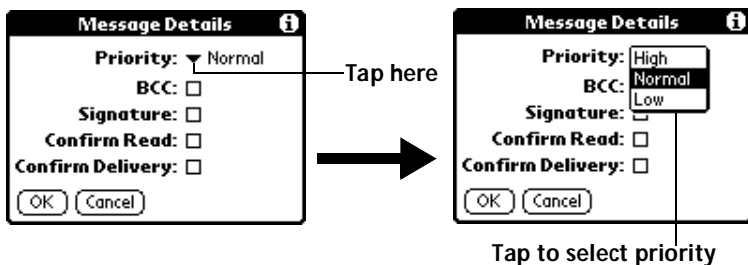

3. Tap OK.

Tip: Your organizer can flag e-mail items with a specific priority only if your desktop E-Mail application supports this feature.

Sending a blind carbon copy

To add a BCC field to your e-mail item:

1. Tap the BCC check box in the Message Details dialog box to select it.
2. Tap OK.

3. Tap the BCC: field and enter an address.

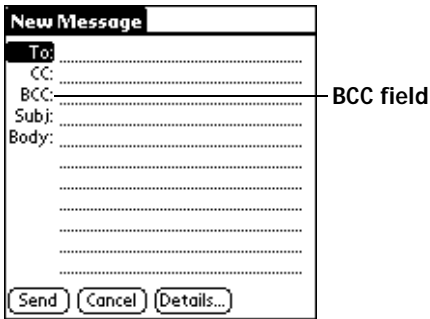

Adding a signature to your e-mail item

A signature consists of information about yourself that is appended to your e-mail item as its closing. For example, a signature can contain your name, address, phone and fax numbers, and any other text you want to include. By defining such information as a signature, you save yourself the trouble of having to enter it every time you create an e-mail item.

Adding a signature to your message is a two-part process. First, you create your signature. Then you select the Signature option.

To create a signature:

1. Tap the Menu icon .
2. Tap Options, and then tap Preferences.
3. Tap the Signature text field and enter the text of your signature.

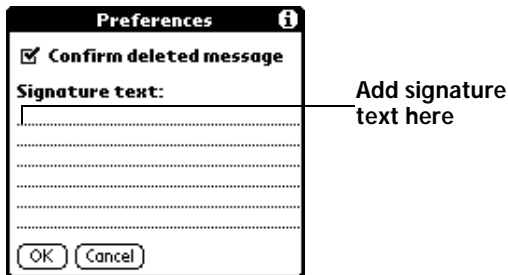

4. Tap OK.

To add a signature to your e-mail item:

1. In the New Message screen, tap Details.
2. Tap the Signature check box to select it and add your signature to the e-mail item.

Note: The check box stays selected, so all subsequent e-mail items you create will also contain your signature until you deselect the Signature option.

3. Tap OK.

Note: The signature does not display in your e-mail item; only your recipient sees the signature.

Requesting confirmations

To receive a confirmation when your e-mail item is read:

1. In the New Message screen, tap Details.
2. Tap the Confirm Read check box to select it.
3. Tap OK.

To receive a confirmation when your e-mail item is delivered:

1. In the New Message screen, tap Details.
2. Select the Confirm Delivery check box to select it.
3. Tap OK.

You won't receive a confirmation unless the e-mail application to which you send mail also supports this feature.

Storing e-mail to be sent later

When you send e-mail from your organizer, it actually stores the e-mail in the Outbox folder until the next time you synchronize your organizer with your computer. During synchronization, all e-mail stored in the Outbox folder is transferred to the Outbox folder in your desktop E-Mail application. E-mail created on your organizer is sent out the next time you send mail from your desktop E-Mail application.

To send e-mail:

- After you create an e-mail item, tap Send.

Editing unsent e-mail

You can make changes to an e-mail that has not yet been sent, as long as you have not yet performed a HotSync operation. When you edit an

e-mail item, your organizer removes the item from the Outbox folder and takes you back to the New Message screen, where you can edit the item and resend it, save it as a draft, or delete it.

To edit an e-mail item:

1. In the Message List, tap Outbox from the pick list in the upper-right corner.

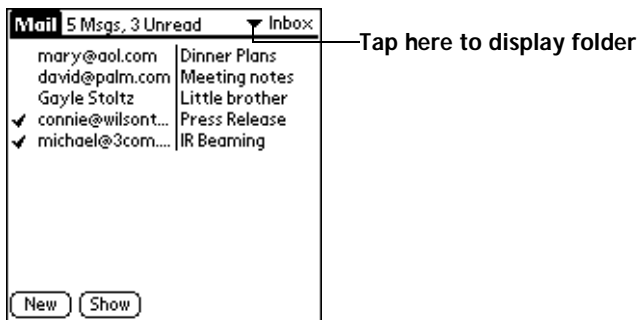

2. Tap the e-mail item you want to edit.

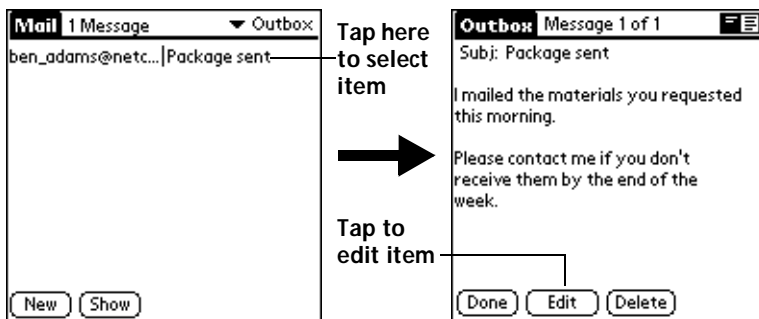

3. Tap Edit.

Draft e-mail

Sometimes you may not want to send an e-mail item immediately; for example, you may want to add additional information before sending it. Your organizer stores such e-mail items in the Draft folder until you are ready to edit them again.

Note: When you're creating or editing an e-mail item, you can also save the item as a draft by canceling it. When you cancel an item, your organizer opens a dialog asking if you want to save the e-mail item. If you tap Yes, your organizer saves the item in the Draft folder.

To save an e-mail item as a draft:

1. Create an e-mail item.
2. Tap the Menu icon .
3. Tap Message, and then tap Save Draft.

To edit an e-mail item saved as a draft:

1. In the Message List, tap Draft from the pick list in the upper-right corner.
2. Tap the draft you want to display.

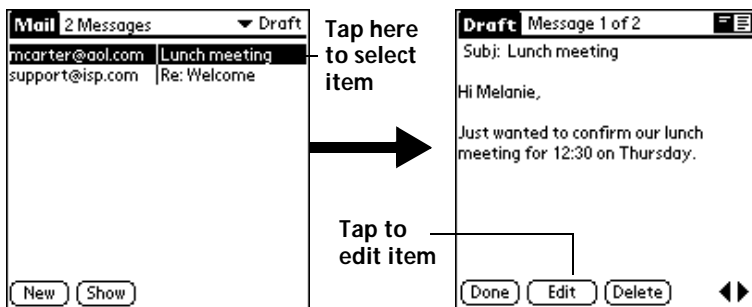

3. Tap Edit.
4. Enter your changes; then either save the e-mail item again as a draft, or tap Send to move the item to your Outbox folder.

Filing e-mail

Your organizer can store e-mail you receive or create in the Filed folder. The contents of this folder do not automatically synchronize with your desktop E-Mail application during a HotSync operation. Your organizer, however, stores a backup copy of the Filed folder on your computer hard disk.

To file e-mail:

1. Open an e-mail item.
2. Tap the Menu icon .
3. Tap Message, and then tap File.
4. Tap No to save the e-mail item and move it to the Filed folder, or tap Yes to file the item and keep a copy in the Inbox.

To remove e-mail from the Filed folder:

1. In the Message List, tap Filed from the pick list in the upper-right corner.
2. Tap the e-mail item you want to restore.
3. Tap Edit or Reply to modify the item.

Tip: After you display and modify the e-mail item, you can send it, save it as a draft, or return it to the Filed folder.

Deleting e-mail

Your organizer stores deleted e-mail in the Deleted folder until you perform the next HotSync operation. If you delete an e-mail item from the organizer, it is also deleted from your desktop E-Mail application when you perform the next HotSync operation.

To delete e-mail:

1. Open the e-mail item you want to delete.
2. Tap Delete.
3. If you selected the Preferences option to confirm deletion, tap Yes.

Removing e-mail from the Deleted folder

You can reverse the deletion of an e-mail item (by removing it from the Deleted folder) as long as you have not performed a HotSync operation or purged the contents of the Deleted folder.

To remove an e-mail item you received from the Deleted folder:

1. In the Message List, tap Deleted from the pick list in the upper-right corner.
2. Tap the e-mail item you want to restore.
3. Tap Undelete to move the selected item to the Inbox and mark it as read.

To remove an e-mail item you created from the Deleted folder:

1. In the Message List, tap Deleted from the pick list in the upper-right corner.
2. Tap the e-mail item you want to restore.
3. Tap Edit to display and modify the item.

Note: After you display and modify the e-mail item, you can send it or save it as a draft.

Purging deleted e-mail

Because your organizer stores deleted e-mail in the Deleted folder until you perform a HotSync operation, deleted e-mail can monopolize storage space. To avoid or correct this problem, purge the contents of your Deleted folder. E-mail that you purge is still deleted from your desktop E-Mail application when you perform the next HotSync operation.

To purge the contents of the Deleted folder:

1. Tap the Menu icon .
2. Tap Message, and then tap Purge Deleted.
3. Tap Yes.

Note: You cannot restore e-mail items after you purge them.

Message List options

Message List options enable you to manage the way the Message List displays information.

Folders

Your organizer provides folders for categorizing your mail. The Message List displays the e-mail items in the folder you select.

To select a folder:

1. Tap the pick list in the upper-right corner to open the list of folders:

Inbox: Contains the e-mail from your desktop E-Mail application Inbox, minus any that you have excluded using filtering options. See “Creating special filters” later in this chapter.

Outbox: Contains the e-mail you created and sent on the organizer since the last HotSync operation.

Deleted: Contains the e-mail you deleted since the last HotSync operation.

Filed: Contains the e-mail you want to store on the organizer.

Draft: Contains the e-mail you created using the organizer but are not yet ready to send.

2. Select the folder you want to display in the Message List screen.

Date column

The Date column is optional in the Message List. By default, the Date column is hidden to increase the available screen space.

To show the Date column:

1. In the Message List, tap Show.

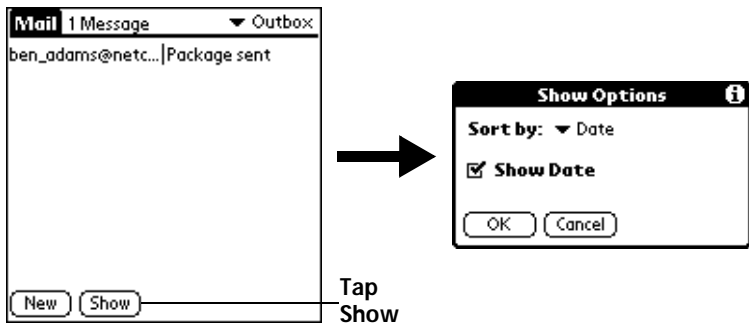

2. Tap the Show Date check box to select it.
3. Tap OK.

Sorting the Message List

You can sort e-mail items by the date sent, by sender, or by subject.

Note: High-priority e-mail items always appear first, no matter how you sort the list.

To sort the Message List:

1. In the Message List, tap Show.
2. Tap the Sort by pick list and select one of the following options:

Date: Sorts e-mail by date and displays the most recent e-mail item at the top of the screen.

Sender: Sorts e-mail by sender's user name and displays items in ascending alphabetical order, based on the first word of the From: field.

Subject: Sorts e-mail by subject and displays items in ascending alphabetical order, based on the first word of the Subj: field.

3. Tap OK.

HotSync options

HotSync options enable you to manage your e-mail more effectively by selecting which e-mail items download when you synchronize your computer and your organizer. You can define different settings for local and remote synchronization. For example, you may want to download all of your e-mail during local synchronization and only urgent e-mail during remote synchronization. Once defined, your organizer determines if synchronization is occurring locally or remotely and uses the appropriate settings for the HotSync operation.

To open the HotSync Options dialog box:

1. Tap the Menu icon .
2. Tap Options, and then tap HotSync Options.
3. Tap the Settings for pick list and select Local HotSync or Remote HotSync.

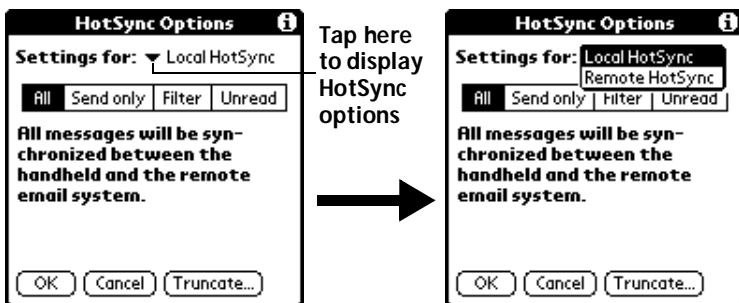

Note: For more information about Local and Remote HotSync operations, see Chapter 7.

4. Tap the filtering option you want to apply:

All: During synchronization, all e-mail items in your desktop E-Mail Inbox synchronize with your organizer, and all e-mail items in your organizer Outbox are sent to your desktop E-Mail application.

Send only: During synchronization, only the e-mail items in your organizer Outbox are sent to your desktop E-Mail application; from there, they are sent to their destinations.

Filter: During synchronization, all e-mail items in your organizer Outbox are sent to your desktop E-Mail application, and items in your desktop E-Mail Inbox that meet specific criteria

download to your organizer. When you select the Filter setting, the HotSync Options dialog box opens and displays additional filter settings. See “Creating special filters” later in this chapter.

Unread: During synchronization, only unread e-mail items download to your organizer from your desktop E-Mail Inbox, and all items in your organizer Outbox are sent to your desktop E-Mail application.

Note: The All setting does not mean that all information included in each e-mail item downloads to your organizer. Truncation settings (explained in a following section) for long e-mail items still apply. Also, Mail never downloads any attachments to your organizer. The e-mail item and any text information appear, but the attachment is left in your desktop E-Mail application.

5. If you selected All, Send only, or Unread, tap OK. If you selected Filter, continue to the next section.

Creating special filters

You can create special filters to control the type of e-mail items that download to your organizer during synchronization. Special filters work on the premise of ignoring or retrieving items that contain specific information in their header fields.

To create a special filter, you must decide whether you want to ignore or retrieve certain e-mail items. Then, based on that decision, you must tell your organizer what it needs to look for in the To:, From:, and Subj: fields to single out those e-mail items.

To access the special filter settings:

- Tap the Filter box in the HotSync Options dialog box.

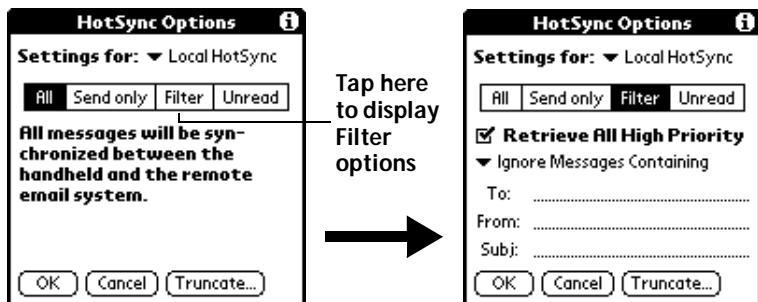

Ignoring or receiving e-mail

The first step in establishing a special filter is to determine whether you want to ignore or retrieve e-mail that matches the information you specify.

To define whether to ignore or receive e-mail:

- Tap the pick list in the center of the HotSync Options dialog box and select one of the following settings:

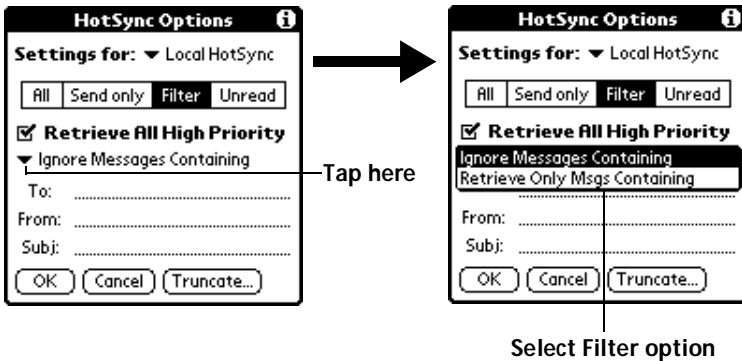

Ignore Messages Containing: Tells your organizer to *exclude* the e-mail items that meet the criteria you define and download *all other e-mail items* during synchronization. In general, this filter downloads more e-mail during synchronization because it blocks only one defined subset of e-mail.

Retrieve Only Msgs Containing: Tells your organizer to *include* only the e-mail items that meet the criteria you define and to ignore all other e-mail items during synchronization. This filter has the potential to block more e-mail during synchronization because it downloads only one subset of e-mail.

Defining filter strings

E-mail items are filtered based on the information contained in their To:, From:, and Subj: fields. The information that defines what your organizer is looking for is called a *filter string*. You create a filter string by listing the words you want your organizer to find and separating them with either a comma or a space. Each word in the filter string is joined by an implicit OR, so you do not need to enter logical connectors like AND or OR.

To create a more complex filter, you can define filter strings for the To:, From:, and Subj: fields simultaneously. Your organizer joins the filter

strings for these fields using an implicit AND; once again, you do not need to add the logical connector. Your organizer does that for you.

For example, suppose you want to receive only e-mail items from John Smith (jsmith@aol.com) or Jack Jones (jjones@aol.com) concerning the Apollo Project. You would create the following filter strings:

In the To: field: jsmith@aol.com, jjones@aol.com

In the Subj: field: Apollo Project

Your organizer interprets this as, “Accept e-mail items about the Apollo Project from John Smith or Jack Jones. Do not accept e-mail items from other people. Do not accept e-mail items from John or Jack about any other subject.”

When you define a string, note that your organizer searches for any instance of that *sequence* of characters. For example, if you create a filter that retrieves only e-mail items containing the string “info,” your organizer considers “**info**,” “rainforest” and “kinfolk” appropriate matches.

To define a filter string:

1. Tap a header field in the HotSync Options dialog box.

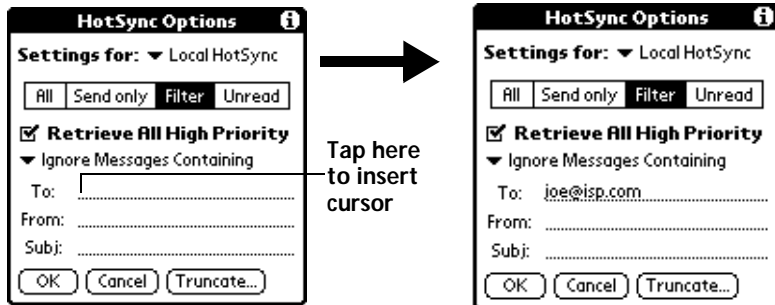

2. Enter your filter string, using commas or spaces to separate the words. Do not add connectors, such as AND or OR, between words in a string.

- If your string exceeds the length of the field, tap the name of the field to display the Notes screen for that header field. For more information about header field Notes screens, see “Creating e-mail items” earlier in this chapter.

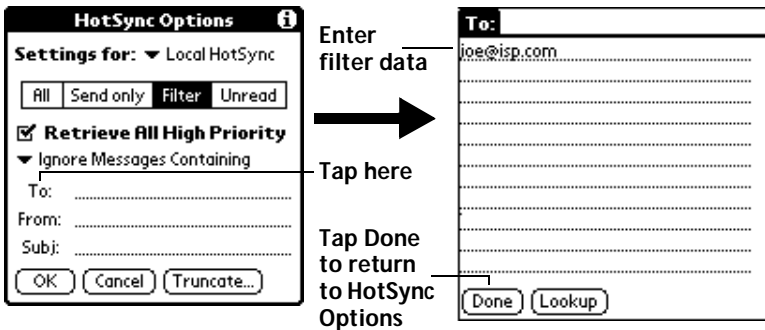

- Tap Done to return to the HotSync Options dialog box.
- Tap OK.

High-priority e-mail

The Retrieve All High Priority setting lets you retrieve e-mail items marked high-priority, even if those items would have been blocked by a defined filter.

To retrieve high-priority e-mail items:

- Tap the Filter box in the HotSync Options dialog box.
- Tap the Retrieve All High Priority check box to select it.

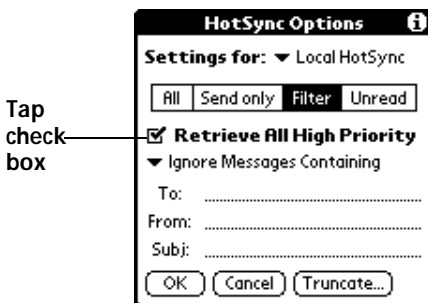

- Tap OK.

Note: This setting is applicable only if your E-Mail application has the capacity to flag high-priority e-mail items.

Truncating e-mail items

The Truncate feature lets you set a point at which long e-mail items truncate when downloading to your organizer. By default, this Truncate value is 4,000 characters. By truncating long messages, you reduce the time it takes to synchronize your desktop E-Mail and Mail, as well as the amount of storage space e-mail uses on your organizer.

Note: Truncation is separate and independent from filtering.

To truncate e-mail items:

1. Tap Truncate in the HotSync Options dialog box.

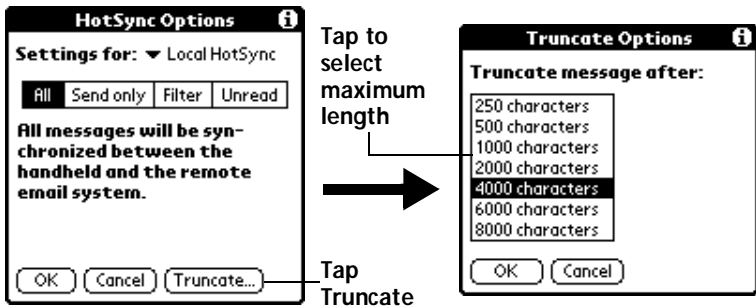

2. Tap to select the truncation setting you want.

Tip: If you select the maximum setting, messages can be 8,000 characters; longer messages are truncated. If you select a lower value, you'll have more room for e-mail items.

3. Tap OK.

Mail menus

Mail menus are shown here for your reference, and Mail features that are not explained elsewhere in this book are described here.

See "Using menus" in Chapter 1 for information about choosing menu commands.

Message menus

The Message menu varies depending on whether you are viewing an e-mail item, creating an e-mail item, or viewing the Message List.

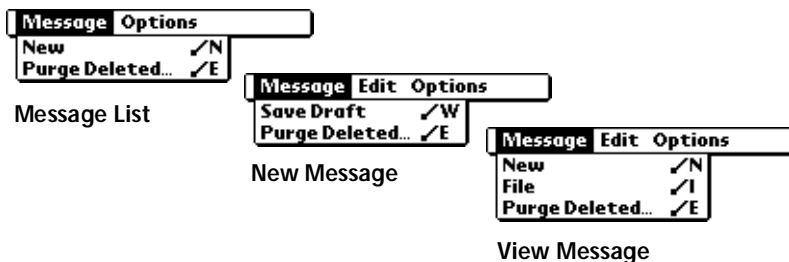

Options menus

The Options menu varies depending on whether you are creating or editing an e-mail item.

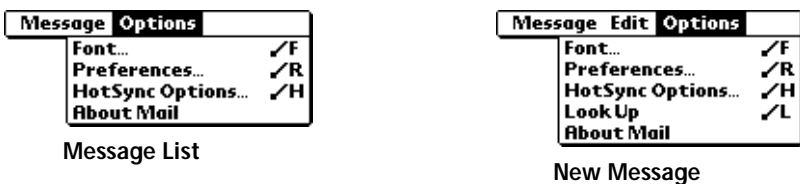

About Mail

Shows version information for Mail.

Beaming information

Your organizer is equipped with an IR (infrared) port that you can use to beam information to another Palm Computing platform device that's close by and also has an IR port. The IR port is located at the top of the organizer, behind the small dark shield.

You can beam the following information between Palm Computing platform devices:

- The record currently displayed in Date Book, Address Book, To Do List, or Memo Pad
- All records in the category currently displayed in Address Book, To Do List, or Memo Pad
- A special Address Book record that you designate as your business card, containing information you want to exchange with business contacts
- An application installed in RAM memory

To select a business card:

1. Create an Address Book record that contains the information you want on your business card.
2. Tap the Menu icon .
3. Tap Record, and then tap Select Business Card.
4. Tap Yes.

To beam a record, business card, or category of records:

1. Locate the record, business card, or category you want to beam.
2. Tap the Menu icon .
3. Tap Record, and then tap one of the following:
 - The Beam command for an individual record
 - In Address Book only: Beam Business Card
 - Beam Category
4. When the Beam Status dialog box appears, point the IR port directly at the IR port of the receiving organizer.

Tip: For best results, Palm VII organizers should be between 10 centimeters (approximately 4 inches) and 1 meter (approximately 39 inches) apart, and the path between the two devices must be clear of obstacles. Beaming distance to other Palm Computing platform devices may be different.



5. Wait for the Beam Status dialog box to indicate that the transfer is complete before you continue working on your organizer.

To beam an application:

1. Open the Applications Launcher.
2. Tap the Menu icon .
3. Tap App, and then tap Beam.
4. Tap the application you want to transfer.

Note: Some applications are copy-protected and cannot be beamed. These are listed with a lock icon next to them.

5. Tap Beam.
6. When the Beam Status dialog box appears, point the IR port directly at the IR port of the receiving organizer.
7. Wait for the Beam Status dialog box to indicate that the transfer is complete before you continue working on your organizer.

To receive beamed information:

1. Turn on your organizer.
2. Point the IR port directly at the IR port of the transmitting device to open the Beam Status dialog box.
3. Tap Yes.
4. Wait for the Beam Status dialog box to indicate that the transfer is complete, and then tap OK to display the new entry.

Incoming records are placed in the Unfiled category.

Tips on beaming information

- You can press the Address Book application button  for about two seconds to beam your business card.
- You can set the full-screen pen stroke to beam the current entry. See “Pen preferences” in Chapter 8 for more information.
- You can use the Graffiti Command stroke /B to beam the current entry.

Chapter 7

Advanced HotSync® Operations

HotSync® technology enables you to synchronize data between one or more Palm Computing® connected organizers and Palm™ Desktop organizer software or another personal information manager such as Microsoft Outlook. To synchronize data, you must connect your organizer and Palm Desktop software either directly by placing your organizer in the cradle attached to your computer, or indirectly, with a Palm Modem® accessory or network.

This chapter describes how to select HotSync options and perform a HotSync operation via a modem or network. See “Exchanging and updating data: HotSync operations” in Chapter 4 for information about performing your first and subsequent local HotSync operations.

Selecting HotSync setup options

You can choose when you want HotSync Manager to run. If necessary, you can adjust the local and modem HotSync settings.

To set the HotSync options:

1. Click the HotSync icon ™ in the Windows system tray.
2. Choose Setup.

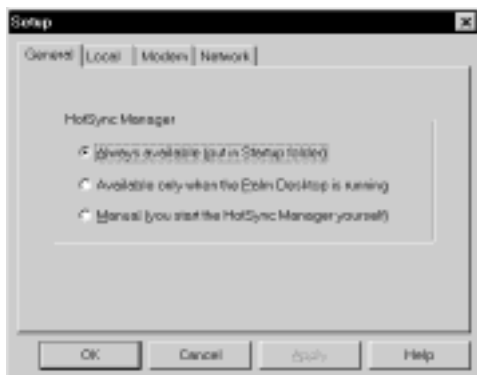

3. Click the General tab and select one of the following options:

Always available: Adds HotSync Manager to the Startup folder and constantly monitors the communication port for

synchronization requests from your organizer. With this option, the HotSync Manager synchronizes data even when Palm Desktop software is not running.

Available only when Palm Desktop software is running: Starts HotSync Manager and monitors requests automatically when you open Palm Desktop software.

Manual: Monitors requests only when you select HotSync Manager from the Start menu.

Tip: If you're not sure which option to use, keep the default setting: Always available.

4. Click the Local tab to display the settings for the connection between your computer and the organizer cradle, and adjust the following options as needed.

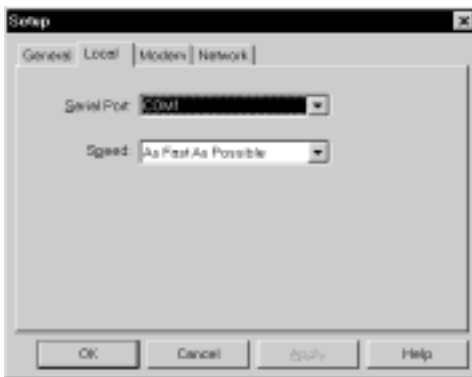

Serial Port: Identifies the port that HotSync Manager uses to communicate with the cradle. This selection should match the number of the port to which you connected the cradle.

Note: Your organizer cannot share this port with an internal modem or other device. See “Palm VII components” in Chapter 1 if you have trouble identifying the serial port.

Speed: Determines the speed at which data is transferred between your organizer and Palm Desktop software. Try the As Fast As Possible rate first, and adjust downward if you experience problems. This setting allows Palm Desktop software and your organizer to find and use the fastest speed.

5. Click the Modem tab to display the modem settings and adjust the options as needed. See “HotSync operations via a modem” later in

this chapter for more information.

6. If you are attached to a network, click the Network tab to display the network settings and adjust the options as needed. See “HotSync operations via a network” later in this chapter for more information.
7. Click OK.

Customizing HotSync application settings

For each application, you can define a set of options that determines how records are handled during synchronization. These options are called a “conduit.” By default, a HotSync operation synchronizes all files between the organizer and Palm Desktop software.

In general, you should leave the settings to synchronize all files. The only reason you might want to change these settings is to overwrite data on either your organizer or Palm Desktop software, or to avoid synchronizing a particular type of file because you don’t use it.

In addition to the conduits for Date Book, Address Book, To Do List, Memo Pad, and Expense, Palm Desktop software includes System and Install conduits. The System conduit backs up the system information stored on your organizer, including Graffiti® ShortCuts. The Install conduit installs applications on your organizer.

To customize HotSync application settings:

1. Click the HotSync icon  in the Windows system tray (bottom-right corner of the taskbar).

Tip: You can also click the HotSync command on the Palm Desktop software menu bar.

2. From the HotSync Manager menu, choose Custom.

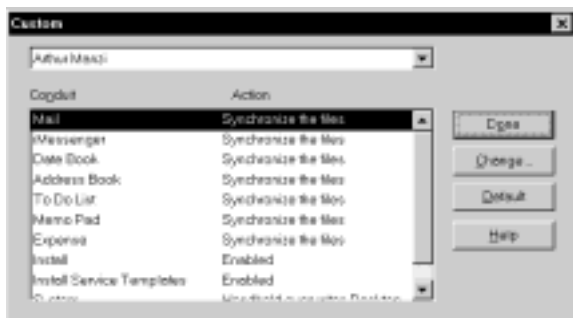

3. Select the appropriate user name from the list.
4. Select an application in the Conduit list.
5. Click Change.



6. Select the direction in which you want to write data, or click Do Nothing to skip data transfer for an application.

Note: Changing the HotSync setting from the default affects only the *next* HotSync operation. Thereafter, the HotSync Actions revert to their default settings. To use a new setting on an ongoing basis, select the Set As Default box. Thereafter, whatever you selected as the default setting is used when you click the Default button in the Custom dialog.

7. Click OK.
8. Repeat steps 4 through 7 to change conduit settings for other applications.
9. Click Done to activate your settings.

HotSync operations via a modem

You can use a modem to synchronize your organizer when you are away from your computer.

Note: The first HotSync operation must be local, using the cradle. After that, you can perform a modem HotSync operation.

To perform a HotSync operation via a modem, you need the following:

- A modem connected to your computer
- Palm Desktop software configured for use with the modem
- A modem, for example, a Palm Modem accessory, connected to your organizer
- Modem Preferences configured for use with a modem

Preparing your computer

You must perform a few steps to prepare your computer for a modem HotSync operation. Perform these steps before you leave your office so that your computer is ready to receive a call from your organizer.

To prepare your computer for a modem HotSync operation:

1. Confirm that the computer modem is connected and turned on, and that no communications applications, such as fax or telephony software, are running on a COM port.

Note: To avoid conflicts with the COM port, make sure the computer is disconnected from all online services, such as America Online (AOL) and CompuServe.

2. Start HotSync Manager if it is not already running, and from the HotSync Manager menu, choose Modem.

3. Adjust the following options as needed.

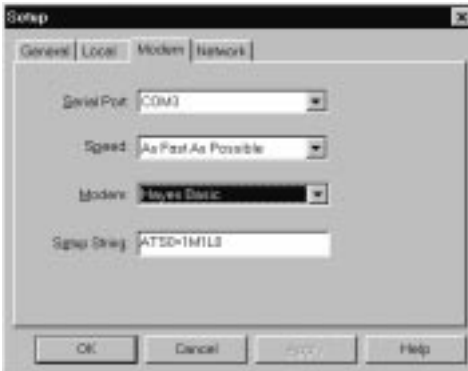

Serial Port: Identifies the port for the modem. If you are unsure of the port assignment, look at the Modem Properties in the Windows Control Panel.

Speed: Determines the speed at which data is transferred. Try the As Fast As Possible rate first, and adjust downward if you experience problems. This setting allows Palm Desktop software and your organizer to find and use the fastest speed.

Modem: Identifies the modem type or manufacturer. Refer to your modem manual or face plate for its type or settings. If you're not sure of your modem type or your modem doesn't match any that appear in the list, select Hayes Basic.



Setup String: Identifies the setup string for your particular modem. Not all modems require a setup string. Refer to your modem manual and enter the setup string if recommended by the manufacturer.

4. Click OK.

Preparing your organizer

There are a few steps you must perform to prepare your organizer for a modem HotSync operation.

To prepare your organizer for a modem HotSync operation:

1. Tap the Applications icon .
2. Tap the HotSync icon .
3. Tap the Enter Phone # field.

Note: If you plan to connect to your company’s dial-in server (network modem) instead of connecting to a computer modem, see “HotSync operations via a network” later in this chapter.

4. Enter the telephone number to access the modem connected to your computer.

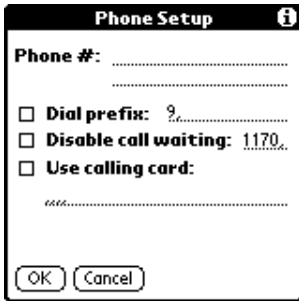

5. If needed, enter a dial prefix (such as “9”) to access an outside line, and then tap the Dial Prefix check box.



Tip: You can enter a comma in the field to introduce a “pause” in the dialing sequence.

6. If the phone line you’re using for the organizer has Call Waiting, select the Disable call waiting check box to avoid an interruption during the modem HotSync operation.
7. If you want to use a calling card to place the call, select the check box and enter the calling card number.
8. Tap OK.
9. Tap the Menu icon .
10. Tap Options, and then tap Modem Setup.
11. Enter the settings. See “Modem preferences” in Chapter 8 for more information.

Selecting the conduits for a modem HotSync operation

The Conduit Setup dialog box on your organizer enables you to define which files and/or applications synchronize during a modem HotSync operation. You can use these settings to minimize the time required to synchronize data with a modem.

To change the Conduit Setup for a modem HotSync operation:

1. Tap the Applications icon .
2. Tap the HotSync icon .
3. Tap the Menu icon .
4. Tap Options, and then tap Conduit Setup.
5. Tap the check boxes to deselect the files and applications that you do *not* want to synchronize during a modem HotSync operation. The default setting is to synchronize all files.





Note: Applications that do not have a database (such as games) do not synchronize — even if you select the item in the Conduit Setup dialog box.

6. Tap OK.

Performing a HotSync operation via a modem

After you prepare your computer and your organizer, and select your Conduit Setup options, you are ready to perform a modem HotSync operation.

To perform a modem HotSync operation:

1. Tap the Applications icon .
2. Tap the HotSync icon .
3. Tap the Modem icon  to dial the Palm Desktop modem and synchronize the applications.
4. Wait for the HotSync operation to complete.

See “HotSync problems” in Appendix B if you have any problems conducting a successful HotSync operation.

HotSync operations via a network

When you establish a HotSync network connection, you can take advantage of the LAN and WAN connectivity available in many office environments. The HotSync network connection enables you to perform a HotSync operation by dialing in to a network or by using a cradle that is connected to any computer on your LAN or WAN (provided that the computer connected to the cradle also has the HotSync network connection enabled, your computer is on, and the HotSync Manager is running).

Connecting to your company's dial-in server

The HotSync network connection requires the following:

- Your computer has TCP/IP support installed.
- Both your company's network system and its remote access server support TCP/IP. (Your system administrator has this information.)
- You have a remote access account. (If you don't have an account, consult your system administrator.)

Everything you need to connect to your company's dial-in server (network modem) is included with Palm Desktop software and your organizer. You need to activate the feature, however, on both Palm Desktop software and your organizer.

To prepare your computer for a network HotSync operation:

1. Click the HotSync Manager icon  in the Windows system tray.

Tip: The Windows system tray is usually in the lower-right corner on your computer display. The location may vary depending on the location of the taskbar and the version of Windows you are using.

2. Be sure Network is selected in the HotSync Manager menu.





3. From the HotSync Manager menu, choose Setup.
4. Click the Network tab and make sure your user name has a check mark next to it. If the check mark is not there, click the check box next to your user name.



5. Click OK.
6. Place your organizer in the cradle and perform a HotSync operation.

The HotSync operation records network information about your computer on your organizer. With this information, your organizer can locate your computer when you perform a HotSync operation over the network.

To prepare your organizer for a network HotSync operation:

1. Tap the Applications icon .
2. Tap the HotSync icon .
3. Tap the Menu icon .
4. Tap Options, then tap Modem Sync Prefs.
5. Tap Network.
6. Tap OK.

Note: For more information on using a HotSync network connection, see the web site <http://www.palm.com>. See “Network preferences and TCP/IP software” in Chapter 8 for information on configuring preferences for a HotSync network connection.

Using File Link

The File Link feature enables you to import Address Book and Memo Pad information onto your organizer from a separate external file such as a company phone list. HotSync Manager stores the data in a separate category on your Palm Desktop software and your organizer. You can configure the File Link feature to check for changes to the external file when you perform a HotSync operation.

With File Link, you can import data stored in any of the following formats:

- Comma delimited (.csv)
- Tab delimited (.tsv)
- Memo Pad archive (.mpa)
- Address Book archive (.aba)
- Text (.txt)

For information on how to set up a file link, see the Palm Desktop online Help.

Creating a user profile

If you use the File Link feature to configure several Palm Computing connected organizers with specific information (such as a company phone list) before distributing them to their actual users, you can create a user profile to load the data into an organizer without associating that data with a user name. The User Profile feature is designed only for the first-time HotSync operation, before you assign a User ID to a particular organizer.

To create a user profile:

1. Open Palm Desktop software.
2. From the Tools menu, choose Users.
3. Click Profiles.

4. Click New.



5. Enter a unique name for the profile, and click OK.



6. Repeat steps 3 and 4 for each profile that you want to create, and then click OK to return to Palm Desktop software.
7. Select the profile from the User list and create the data for the profile (e.g., company phone list, etc.).



To use a profile for the first-time HotSync operation:

1. Place the new organizer in the cradle.
2. Press the HotSync button  on the cradle.
3. Click Profiles.

4. Select the profile that you want to load on the organizer, and click OK.



5. Click Yes to transfer all the profile data to the organizer.

The next time you perform a HotSync operation, Palm Desktop software prompts you to assign a user name to the organizer.

Chapter 8

Setting Preferences for Your Organizer



The Preferences screens enable you to customize the configuration options on your organizer.

In the Preferences screens, you can do the following:

Buttons	Assign different applications to the buttons on the front panel of your organizer and the HotSync® button on the cradle; identify an application to open whenever you raise the antenna; reassign the full-screen pen stroke command.
Digitizer	Calibrate the screen on your organizer.
Formats	Set the country default and the formats for dates, times, calendar, and numbers.
General	Set the current date and time, the auto shut-off interval, the Beam Receive feature, and the system, alarm, and game sounds.
Modem	Configure your organizer for use with a modem.
Network	Configure your organizer for use with a network.
Owner	Assign your name, phone number, and other owner information to your organizer.
ShortCuts	Define a list of Graffiti® abbreviations.
Wireless	View your Palm.Net™ address; change the proxy server IP address; and receive a warning when a wireless transaction is about to transmit your identification or location.

Viewing preferences

To open the Preferences screens:

1. Tap the Applications icon .
2. Tap the Preferences icon .
3. Tap the pick list in the upper-right corner of the screen.
4. Select the Preferences screen you want to view.

Buttons preferences

The Buttons Preferences screen enables you to assign different applications to the buttons on the front panel of your organizer and the HotSync button on the cradle.

For example, if you find that you seldom use To Do List and often use Expense, you can assign the To Do List button to start Expense.

If you assign a different application to a button, you can still access the original application using the Applications Launcher.

The Buttons Preferences screen also enables you to reassign the full-screen pen stroke command and identify an application to open whenever you raise the antenna.

Any changes you make in the Buttons Preferences screen become effective immediately; you do not have to change to a different screen or application.

To reassign the applications buttons:

1. Tap the pick list next to the button you want to reassign.

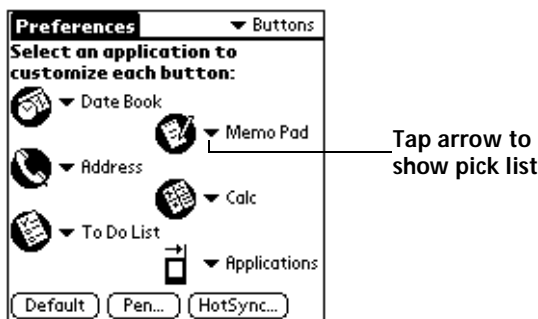

2. Tap the application that you want to assign to the button.

Tip: Tap Default to restore all of the buttons to their initial settings.

To identify the application that opens when you raise the antenna:

1. Tap the pick list next to the Applications button.
2. Tap the application you want to open whenever you raise the antenna.

Tip: Tap Default to have the Wireless category of the Applications Launcher open when you raise the antenna.

Pen preferences

The Buttons Preferences screen enables you to change the assignment of the full-screen pen stroke. By default, the full-screen pen stroke activates Graffiti Help.

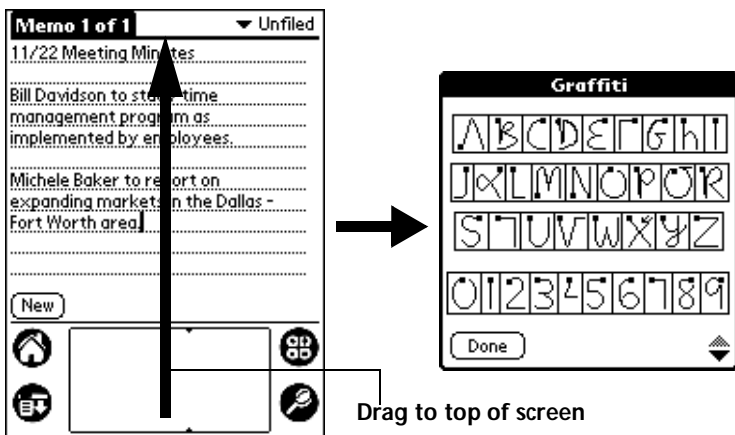

To change the Pen preferences:

1. Tap Pen.

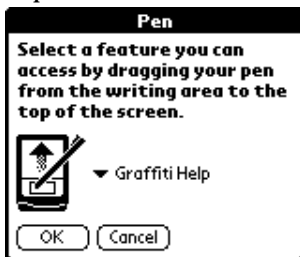

2. Tap the pick list and select one of the following settings for the full-screen pen stroke:

Backlight: Turns the backlight of your organizer on and off.

Keyboard: Opens the onscreen keyboard for entering text characters.

Graffiti Help: Opens a series of screens that show the complete Graffiti character set.

Turn Off & Lock: Turns off and locks the organizer. You must assign a password to lock the organizer. When locked, you need to enter the password to use your organizer.

Beam Data: Beams the current record to another Palm Computing® platform device equipped with an IR port.

3. Tap OK.

HotSync buttons preferences

You can also associate different applications with the HotSync buttons on the cradle and on the optional Palm Modem® accessory. Changes you make in the HotSync Buttons dialog box become effective immediately; you do not have to change to a different screen or application.

To change the HotSync buttons preferences:

1. Tap HotSync.
2. Tap the pick list next to the button you want to assign.

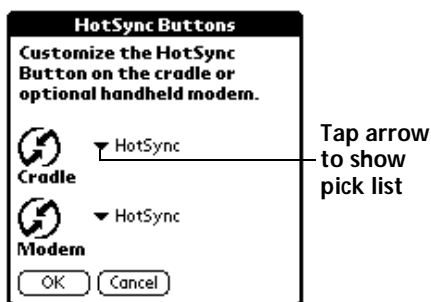

3. Tap the application that you want to assign to each button.

The default setting, HotSync, means the cradle and Palm Modem accessory perform their normal HotSync functions.

4. Tap OK.

Digitizer preferences

The Digitizer Preferences screen opens the digitizer calibration screen. This is the same screen that appears when you go through the Setup process for your organizer.

You can recalibrate your screen after a hard reset, or if your digitizer drifts.

Formats preferences

Use the Formats Preferences screen to set the country default and the display format of the dates, times, and numbers on your organizer.

Country default

The country default sets date, time, week start day, and number conventions based on geographic regions where you might use your organizer. For example, in the United Kingdom, time often is expressed using a 24-hour clock. In the United States, on the other hand, time is expressed using a 12-hour clock with an AM or PM suffix.

All your organizer applications use the Country default settings. You can, however, customize your own preferences as described in the “Time, date, week start, and numbers formats” section later in this chapter.

To set the country default:

1. Tap the country name pick list.

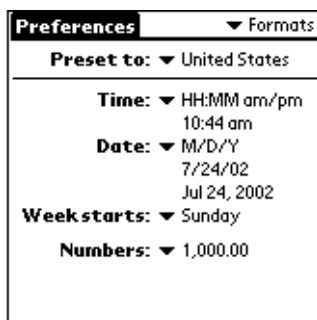

2. Tap the setting you want to use.

Time, date, week start, and numbers formats

The Time setting defines the format for the time of day. The time format that you select appears in all applications on your organizer.

To select the time, date, week start, and numbers format:

1. Tap the Time pick list and select a format.
2. Tap the Date pick list and select a format.
3. Tap the Week starts pick list, and select whether you want the first day of the week to be Sunday or Monday.

Note: This setting controls the Day, Week, and Month views in Date Book and all other aspects of your organizer that display a calendar.

4. Tap the Numbers pick list, and select formats for the decimal point and thousands separator.

General preferences

The General Preferences screen enables you to set the time, date, auto shutoff interval, sounds, and beam receive option for your organizer.

See Chapter 1 for information on setting the time and date.

Auto-off delay

Your organizer has an automatic shutoff feature that turns off the power and backlight after a period of inactivity. This feature helps conserve battery power in case you forget to turn off your organizer.

If you find that your organizer shuts itself off before you finish reviewing the information on the screen, you should increase the time setting of the automatic shutoff feature.

To set the Auto-off delay:

1. Tap the Auto-off pick list.
2. Tap the setting you want to use for the automatic shutoff feature: 1 minute, 2 minutes, or 3 minutes.

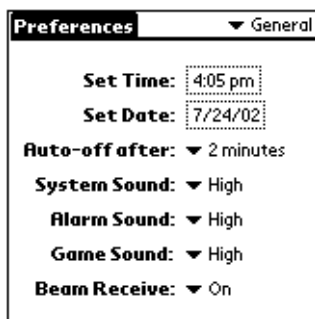

System, alarm, and game sounds

Your organizer uses a variety of sounds. The System, Alarm, and Game Sound settings enable you to turn the sounds on or off, and to adjust the volume level.

To set the system and alarm sounds:

1. Tap the System Sound pick list and select the sound level.

Note: When you turn off the System Sounds, you also turn off the “chime” tones associated with the HotSync operation.

2. Tap the Alarm Sound pick list and select the sound level.

3. Tap the Game Sound pick list and select the sound level.

Note: The Game Sound setting works only with games that are programmed to respond to this setting. Older games typically do not respond to this setting.

Beam Receive

You can choose to turn off the Beam Receive feature. This prohibits anyone from beaming information to your organizer. It also results in a slight saving of battery power.

To change the Beam Receive setting:

- Tap the Beam Receive pick list and select On or Off.

Modem preferences

The Modem Preferences screen enables you to define the settings for a modem that is directly connected to your organizer. These settings are for applications that activate and use the modem.

Note: You can purchase a Palm Modem accessory to use with your organizer. Visit the web site <http://www.palm.com>.

To define the Modem preferences:

1. Tap TouchTone or Rotary.

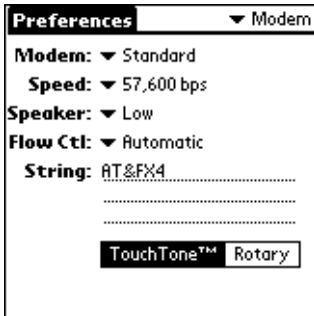

Note: Select the Rotary setting only if you are certain that your telephone service does not support TouchTone dialing.

2. Tap the Speed pick list and select the maximum speed for your modem.

Note: This is the speed at which your modem communicates with your organizer, not the speed at which the modem communicates with your telephone service.

3. Tap the Speaker pick list and select the volume for the modem.
4. Tap the Flow Ctl (Flow Control) pick list and select Automatic, On (Xon), or Off (Xoff) for the modem connection.
5. Tap the Modem pick list and select the type of modem connected to your organizer.

Note: If the modem connected to your organizer is not on the list, select Hayes Basic. In most cases, your organizer can function correctly with the Hayes Basic settings.

6. If necessary, edit the String text to change the modem setup string.

Network preferences and TCP/IP software

The Network Preferences settings enable you to use the TCP/IP software that is included in the organizer operating system. You can use the TCP/IP software to connect with Internet Service Providers (ISPs) or dial-in (remote access) servers. Because the TCP/IP software is a feature of the operating system, you configure all parameters relating to it from the Preferences application.

To use TCP/IP, you must configure both the Modem Preferences and the Network Preferences settings.

Note: Modem Preferences settings enable your organizer to use a modem to communicate with remote devices. For example, you can communicate with your ISP server or with your computer if you are away on travel. See “Modem preferences” earlier in this chapter to learn how to configure modem parameters.

After you configure both the Network and Modem Preferences, you can establish a PPP (Point-to-Point Protocol), SLIP (Serial Line Internet Protocol), or CSLIP (Compressed Serial Line Internet Protocol) connection with your ISP or dial-in server. You can do this either by using menu commands from the Network Preferences screen or by using a third-party application.

Note: TCP/IP provides the ability to connect to your ISP or dial-in server with applications that allow you to view the transmitted data. Visit the web site <http://www.palm.com> for information on third-party applications that take advantage of TCP/IP.

Selecting a service

Use the Service setting to select the service template for your Internet Service Provider or a dial-in server. Service templates are a set of ISP and dial-in server configuration settings that you can create, save, and reuse.

To select a service:

1. Tap the Service pick list.

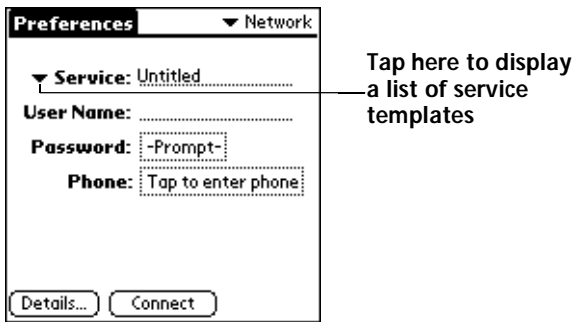

2. Tap the predefined service template you want to use.

Entering a user name

The User Name setting identifies the name you use when you log into your Internet Service Provider or your dial-in server. Although this field can contain multiple lines of text, only two lines appear onscreen.

To enter a user name:

1. Tap the User Name field.
2. Enter your user name.

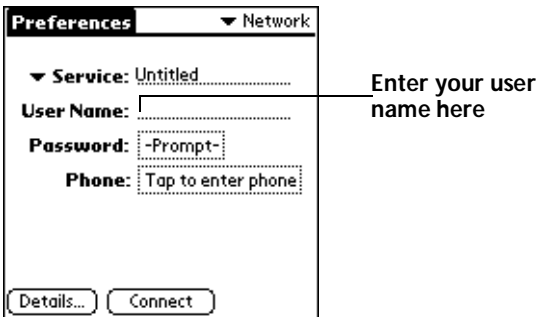

Note: Most dial-in servers do not accept spaces in the user name.

Entering a password

The Password box identifies the password you use to log into your server or ISP. Your entry in this field determines whether your

organizer prompts you to enter a password each time you log into your network:

- If you do not enter a password, your organizer displays the word “Prompt” in this field and asks you to enter a password during the login procedure.
- If you enter a password, your organizer displays the word “Assigned” in this field and does not prompt you to enter a password during the login procedure.

Note: If you are concerned about security, select the Prompt option and do not enter a password.

To enter a password:

1. Tap the Password field.
2. Enter the password you use to log into your server.

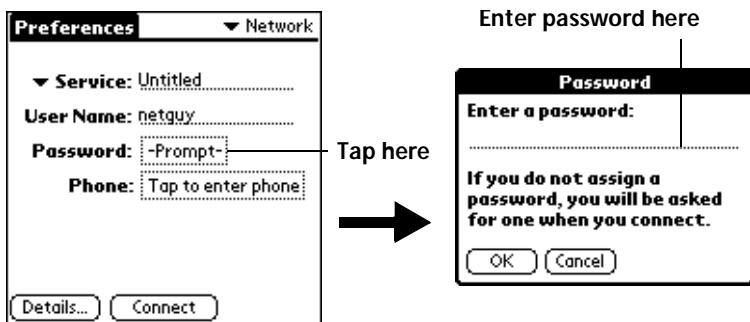

3. Tap OK.

Note: The Password field updates to display the word “Assigned.”

Adding telephone settings

When you select the Phone field, your organizer opens a dialog box in which you define the telephone number you use to connect with your ISP or dial-in server. In addition, you can also define a prefix, disable Call Waiting, and give special instructions for using a calling card.

Note: The Phone Setup dialog box works correctly for AT&T and Sprint long-distance services. However, because MCI works differently, MCI customers need to put the calling card number in the Phone # field and the phone number in the Use calling card field.

To enter your server phone number:

1. Tap the Phone # field.
2. Enter the phone number you use to reach your ISP or dial-in server.



Enter your ISP phone number here

3. If you need to enter a prefix or disable Call Waiting, continue to the following procedures. If not, tap OK.

Entering a prefix

A prefix is a number that you dial before the telephone number to access an outside line. For example, many offices require that you dial “9” to dial a number outside the building.

To enter a prefix:

1. Tap the Dial Prefix check box to select it.

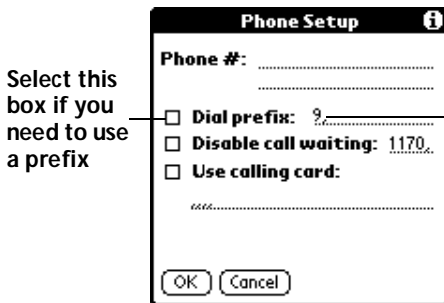

Select this box if you need to use a prefix

Enter your prefix here

2. Enter the prefix.

Tip: It's a good idea to add a comma after the prefix. One comma adds a two-second delay to the transmission.

3. Tap OK.

Disabling Call Waiting

Call Waiting can cause your session to terminate if you receive a call while you are connected. If your telephone has Call Waiting, you need to disable this feature before logging into your ISP or dial-in server.

To disable Call Waiting:

1. Tap the Disable call waiting check box to select it.

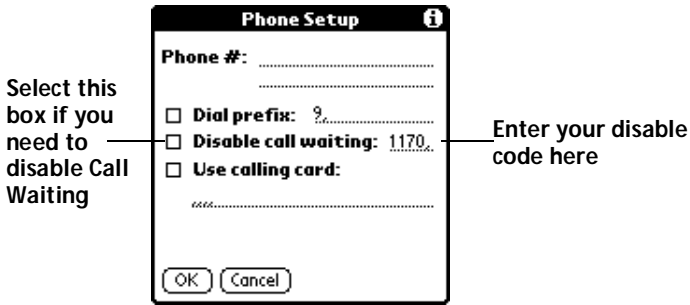

2. Enter the code to disable Call Waiting on the Disable call waiting line.

Note: Each telephone company assigns a code to disable Call Waiting. Contact your local telephone company for the code that is appropriate for you. It's a good idea to add a comma after the code. One comma adds a two-second delay to the transmission.

3. Tap OK.

Using a calling card

The Use calling card field enables you to use your calling card when dialing your ISP or Intranet server. Keep in mind that there is usually a delay before you enter your calling card number. When you define your calling card number, you need to add commas at the beginning to compensate for this delay. Each comma delays transmission of your calling card number for two seconds.

To use a calling card:

1. Tap the Use calling card check box to select it.

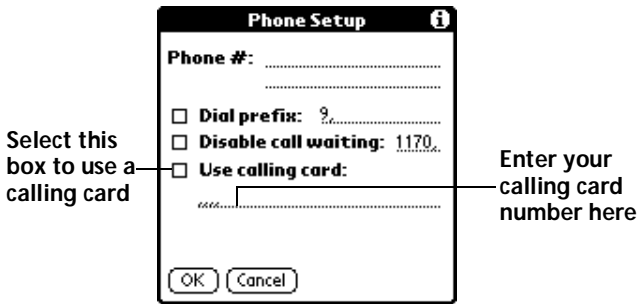

2. Enter your calling card number on the Use calling card line.

Note: It's a good idea to add at least three commas at the beginning of your calling card number to compensate for the cue delay.

3. Tap OK.

Connecting to your service

After you set your Modem and Network Preferences, establishing a connection to your Internet Service Provider (ISP) or your company's network (dial-in server) is easy.

Note: If you are connecting to an ISP, you need a third-party application, such as a web browser or news reader, to take advantage of this connection. For information about third-party applications that support TCP/IP, check the web site <http://www.palm.com>.

To establish a connection:

- In the Network Preferences screen, tap Connect to dial the current service and display the Service Connection Progress messages.

Tip: To see expanded Service Connection Progress messages, press the lower half of the Scroll button.

To close a connection:

- Tap Disconnect to terminate the connection between your organizer and your service.

Creating additional service templates

You can create additional service templates from scratch or by duplicating existing templates and editing information. After you create a new or duplicate template, you can add and edit settings.

To add a new service template:

1. Tap the Menu icon .
2. Tap Service, and then tap New.

A new service template (called Untitled) is added to the Service pick list.

To duplicate an existing service template:

1. Tap the Service pick list.
2. Tap the predefined service template you want to duplicate.
3. Tap the Menu icon .
4. Tap Service, and then tap Duplicate.

A copy of the service template is added to the Service pick list.

Adding detailed information to a service template

If you are using one of the predefined service templates, you probably only need to enter your user name and telephone number. If you are creating a new service template, you may need to provide additional information to your ISP or dial-in server. You use the Details dialog box to add additional information to a selected service template.

To select a connection type:

1. Tap the service field.
2. Tap Details.

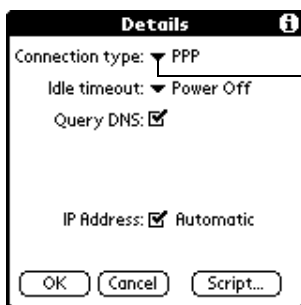

—Select connection type

3. Tap the Connection type pick list and select one of the following connection types:

PPP: Point-to-Point protocol

SLIP: Serial Line Internet Protocol

CSLIP: Compressed Serial Line Internet Protocol

Note: If you are not sure, try PPP; if that doesn't work, ask your Internet Service Provider or your system administrator for the correct connection type.

Idle timeout

The Idle timeout setting defines how long your organizer waits before dropping the connection with your ISP or dial-in server when you switch out of a TCP/IP application.

To set the Idle timeout:

1. Tap the Idle timeout pick list and select one of the following options:

Immediate: Drops the connection to your ISP immediately when you switch to another application.

1 minute: Waits one minute for you to open another application before it drops the connection.

2 minutes: Waits two minutes.

3 minutes: Waits three minutes.

Power Off: Keeps your PPP or SLIP connection until you turn off your organizer (or until it times out). This option works best with the Palm Modem accessory.

2. Tap OK.

Defining primary and secondary DNS

The Domain Naming System (DNS) is a mechanism in the Internet for translating the names of host computers into IP addresses. When you enter a DNS number (or IP address), you are identifying a specific server that handles the translation services.

Each IP address has four sections, separated by periods. In the Details dialog box, you enter each section separately. Each section of an IP address is made up of a number from 0 to 255; numbers are the only allowable characters in this field.

Ask your Internet Service Provider or system administrator for the correct Primary or Secondary DNS IP numbers.

Tip: Many systems do not require that you enter a DNS. If you are not sure, leave the DNS field blank.

To enter a primary and secondary DNS:

1. Tap the Query DNS check box to deselect it.

2. Tap the space to the left of the first period in the Primary DNS field, and then enter the first section of the IP address.

Note: Each section must be a number from 0 to 255.

3. Repeat step 2 for the second, third, and last sections of the Primary DNS field.
4. Repeat steps 2 and 3 for the Secondary DNS number.
5. Tap OK.

IP address

Everyone who logs on to the Internet needs to have a unique identifier (an IP address), whether permanent or temporary. Some networks dynamically assign a temporary IP address when clients log in. The IP Address field lets you identify whether your network provides automatic (dynamic) temporary IP addressing.

Note: If your IP address is permanently assigned, you need to get that information from your system administrator. If you are not sure, select Automatic.

To identify dynamic IP addressing:

- Tap the IP Address check box to select it.

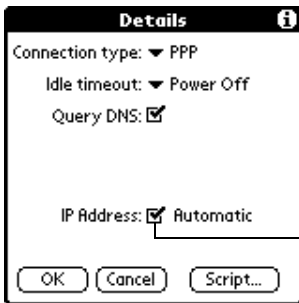

Tap to select automatic IP address

To enter a permanent IP address:

1. Tap the IP Address check box to deselect it and display a permanent IP address field below the check box.
2. Tap the space to the left of the first period then enter the first section of the IP address.

Note: Each section must be a number from 0 to 255.

3. Tap and enter the remaining sections of the IP address.
4. Tap OK.

Creating a login script

A login script is a series of commands, similar to an autoexec.bat file, that automates logging into your ISP. You can create login script files by selecting commands from the Command pick list in the Login Script dialog. Some commands from the Command pick list, such as Send, require you to supply additional information. Those commands have a parameter field so that you can add the necessary data.

Note: You can also use non-ASCII and literal characters in your login script. See Appendix D for more information.

To create a login script:

1. Tap Script.
2. Tap the End pick list.

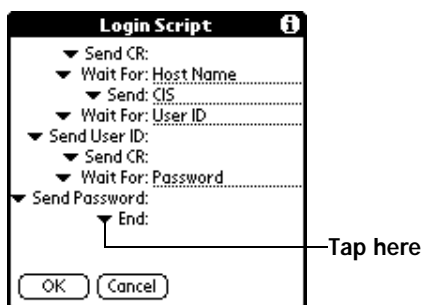

3. Tap the command you want from the Command list. If the command requires additional information, a field appears to the right of it for you to enter the information. The following commands are available:

Wait For: Tells your organizer to wait for specific characters from the TCP/IP server before executing the next command.

Send: Transmits specific characters to the TCP/IP server to which you are connecting.

Send CR: Transmits a carriage return or LF character to the TCP/IP server to which you are connecting.

Send User ID: Transmits the User ID information entered in the User ID field of the Network Preferences screen. The Send User ID command is usually followed by a Send CR command.

Send Password: Transmits the password entered in the Password field of the Network Preferences screen. If you did not enter a

password, this command prompts you to enter one. The Send Password command is usually followed by a Send CR command.

Delay: Tells your organizer to wait a specific number of seconds before executing the next command in the login script.

Get IP: Reads an IP address and uses it as the IP address for your organizer. This command is used with SLIP connections.

Prompt: Opens a dialog box and prompts you to enter text of some kind (for example, a password or a security code).

End: Identifies the last line in the login script.

4. Repeat steps 2 and 3 until the login script is complete.
5. Tap OK.

Deleting a service template

Use the Delete command from the Service menu to delete a service template.

To delete a service template:

1. Tap the Service pick list.
2. Tap the service template you want to delete.
3. Tap the Menu icon .
4. Tap Service, and then tap Delete.
5. Tap OK.

Network preferences menu commands

The Network Preferences screen includes menu commands to make it fast and easy to create and edit service templates. TCP/IP application menus are shown here for your reference.

See “Using menus” in Chapter 1 for more information about choosing menu commands.

Service menu

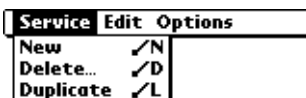

Options menu



TCP/IP troubleshooting

If you are having a problem establishing a network connection using TCP/IP, check this section and try the suggestions listed.

Displaying expanded Service Connection Progress messages

It's helpful to identify at what point in the login procedure the connection fails. An easy way to do this is to display the expanded Service Connection Progress messages. Expanded Service Connection Progress messages describe the current stage of the login procedure. Press the lower half of the scroll button at any point during login to display these messages.

Viewing the Network Log

If viewing the expanded Service Connection Progress messages does not give you enough information to find out why you cannot connect to your ISP or dial-in server, take a look at the Network Log. The Network Log lists all of the communication that occurs between your modem and your dial-in server during the login procedure. The information in the Network Log can help your ISP or your system administrator pinpoint where and why the login procedure communication fails.

To view the Network Log:

1. Tap Options, and then tap View Log.
2. Tap the up and down arrows of the scroll bar to see the entire Network Log.
3. Tap Done.

Adding a DNS number

If your ISP or dial-in server requires a DNS number and you did not enter that information in the Network Preferences screen, it will appear that you successfully logged into your network. When you try to use an application or look up information, however, the connection fails. If this occurs, try adding a DNS number. Ask your ISP or your system administrator for the correct Primary and Secondary DNS IP numbers.

Owner preferences

The Owner Preferences screen enables you to record a name, company name, phone number, or any other information that you want to associate with your organizer.

If you use the Security application to turn off and lock your organizer with a password, information that you put in the Owner Preferences displays the next time you turn on your organizer. See “Security” in Chapter 3 for more information.

To enter the Owner preferences:

- Enter the text that you want to associate with your organizer in the Owner Preferences screen. If you enter more text than can fit on one screen, a scroll bar automatically appears on the right side of the screen.

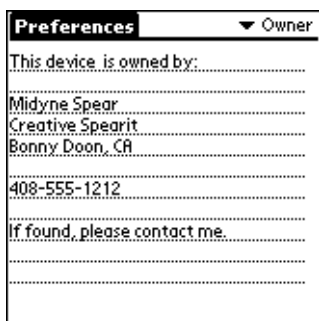

The screenshot shows a screen titled "Preferences" with a dropdown menu set to "Owner". The screen contains several text entry fields with dotted lines for guides. The text entered in the fields is as follows:

- This device is owned by:
- Midyne Spear
- Creative Spearit
- Bonny Doon, CA
- 408-555-1212
- If found, please contact me

If you assign a password with the Security application, the information in the Owner Preferences screen cannot be changed. In this case, an Unlock button appears at the bottom of the screen.

To unlock the Owner Preferences screen:

1. Tap Unlock.
2. Enter the password that you defined in the Security application.
3. Tap OK.

ShortCuts preferences

The ShortCuts Preferences screen enables you to define abbreviations for entering text with Graffiti strokes. This section describes how to create, edit, and delete a ShortCut. See “Graffiti ShortCuts” in Chapter 2 for more information on the use of ShortCuts.

Creating a ShortCut

You can create a ShortCut for any words, letters, or numbers. All ShortCuts you create appear on the list in the ShortCut Preferences screen. All the ShortCuts are available in any of your organizer applications and are backed up on your computer when you perform a HotSync operation.

To create a ShortCut:

1. Tap New.
2. On the ShortCut name line, enter the letters you want to use to activate the ShortCut.

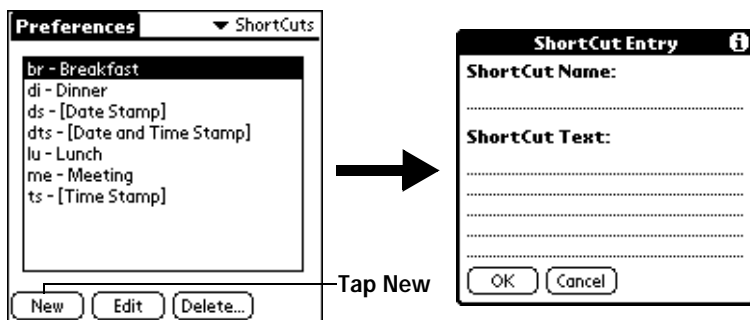

3. Tap the ShortCut Text area and enter the text that you want to appear when you write the ShortCut characters.

Tip: You may want to add a space (space character) after the last word in your ShortCut text. This way, a space automatically follows the ShortCut text.

4. Tap OK.

Tip: To use a ShortCut, draw the ShortCut stroke followed by the ShortCut characters. When you draw the ShortCut stroke, the ShortCut symbol appears at the insertion point to show that you are in ShortCut mode.

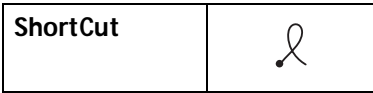

Editing a ShortCut

After you create a ShortCut, you can modify it at any time.

To edit a ShortCut:

1. Tap the ShortCut you want to edit.
2. Tap Edit.
3. Make the changes you want and tap OK.

Deleting a ShortCut

If you no longer need a ShortCut, you can delete it from the list of ShortCuts.

To delete a ShortCut:

1. Tap the ShortCut you want to delete.
2. Tap Delete.
3. Tap Yes.

Wireless preferences

The Wireless Preferences screen enables you to do the following:

- View your address on the Palm.Net network, which you create when you activate the service.
- Change the proxy server with which your organizer communicates.
- Receive a warning when a wireless transaction is about to transmit your identification or location.

Proxy

The IP address that appears by default in this screen is the address of the Palm.Net proxy server. You do not need to identify a different proxy server unless your organization has its own proxy server and supplies you with an IP address for that proxy server.

To change the IP address of your proxy server:

1. Tap the Proxy field.

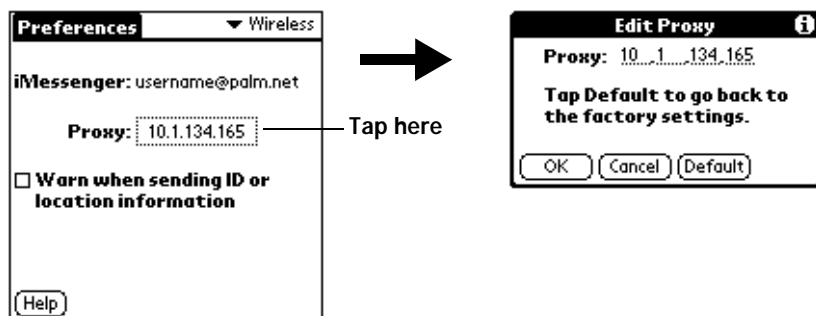

2. Tap the dot to the right of the first section of the Proxy field, and then enter the first section of the IP address.

Note: Each section must be a number from 0 to 255.

3. Repeat step 2 for the second, third, and last sections of the IP address.
4. Tap OK.

Tip: To restore the initial IP address of the proxy server, tap Default.

Sending ID or location information

When you submit a query to some query applications, they automatically elicit the following information from your organizer:

- The number that uniquely identifies your organizer
- Your approximate location, reported as the ZIP code of the area where you are currently located

Having such information enables the query application to offer you better service and more accurate information in its clippings.

If, however, you do not want to send this information over the airwaves, you can receive a warning whenever a query application is about to send this information. The warning gives you a choice; you can continue the transaction or cancel the transaction before any information is sent.

To activate the warning about transmission of ID or location:

- Select the check box next to Warn when sending ID or location information. A check mark should appear in the check box.

Appendix A

Maintaining Your Organizer

This chapter provides information on the following:

- Caring for your organizer
- About the AAA batteries
- Automatic recharging of the transmitter
- Proper use of the antenna
- Resetting your organizer

Caring for your organizer

Your organizer is designed to be rugged and reliable and to provide years of trouble-free service. Please observe the following general tips when using your organizer:

- Take care not to scratch the screen of your organizer. Keep the screen clean. When working with your organizer, use the supplied stylus or plastic-tipped pens intended for use with a touch-sensitive screen. Never use an actual pen or pencil or other sharp object on the surface of the organizer screen.
- Your organizer is not waterproof and should not be exposed to rain or moisture. Under extreme conditions, water may enter the circuitry through the front panel buttons. In general, treat your organizer as you would a pocket calculator or other small electronic instrument.
- The touch-sensitive screen of your organizer contains a glass element. Take care not to drop your organizer or subject it to any strong impact. Do not carry your organizer in your back pocket: if you sit on it, the glass may break.
- Protect your organizer from temperature extremes. Do not leave your organizer on the dashboard of a car on a hot day, and keep it away from heaters and other heat sources.
- Do not store or use your organizer in any location that is extremely dusty, damp, or wet.
- Use a soft, damp cloth to clean your organizer. If the surface of the organizer screen becomes soiled, clean it with a soft cloth moistened with a diluted window-cleaning solution.

About the AAA batteries

Please note the following considerations when replacing the batteries in your organizer:

- Under normal conditions, depending on your usage pattern, the AAA batteries of your organizer should provide weeks of use. You can conserve battery life by minimizing the use of the backlight feature, and changing the Auto-off setting that automatically turns the organizer off after a period of inactivity. See “General preferences” in Chapter 8 for more information.
- As the batteries become low in the course of normal use, messages appear onscreen alerting you to the low battery condition. Replace the batteries as soon as you can after the first alert appears. Remember to perform a HotSync® operation to back up your data before you replace the batteries. This helps prevent accidental data loss.
- When replacing the batteries, begin by turning your organizer off (so there is no screen display).
- When replacing the batteries, always use good quality batteries of the same type. Do not mix old and new batteries. Use only alkaline batteries with your organizer.
- When you remove the old batteries, the built-in backup power of your organizer maintains memory data. Whenever you remove the batteries, replace them immediately. We recommend replacing batteries within a **period of one minute**. If you encounter any difficulties or delays while you’re replacing the batteries, reinstall the original batteries and wait a few minutes for the backup power to recharge.
- If the batteries drain to the point where you cannot turn on your organizer, there is enough residual power in the batteries to preserve your data safely only for a few days beyond that point. If your organizer does not turn on when you press the power button, you should replace the batteries immediately.
- If you leave drained batteries in your organizer for an extended period of time, you can lose all of the stored data. If this happens, replace the batteries and use the reset button to reset your organizer. (See “Resetting your organizer” later in this chapter for details.) After you reset your organizer, perform a HotSync operation to restore the data from your computer.

Automatic recharging of the transmitter

The transmitter used by your organizer for web clipping and wireless Internet messaging contains a rechargeable storage battery. It is a NiCad (nickel-cadmium) battery.

When you first set up your organizer, the initial charging of the transmitter takes about 70 minutes. Like any storage battery, the transmitter must be recharged. How often recharging must happen depends on the frequency with which you use web clipping and wireless Internet messaging.

You don't have to do anything to recharge the transmitter. Your organizer senses when the transmitter needs to be recharged and automatically recharges it from the AAA batteries. Your organizer also tries to schedule the recharging of the transmitter at a time when you typically don't use the organizer. The organizer does not have to be turned on to recharge the transmitter.

To monitor the status of the transmitter:

1. In the Applications Launcher, tap the Diagnostics icon.
2. Tap Details.
3. Refer to the following fields for information on the transmitter:

Transmitter Charge: Indicates the voltage remaining in the transmitter. A number above 5 indicates that the transmitter has adequate power.

Scheduled Charge: Can show one of the five following states:

“Not Scheduled” indicates that your transmitter has adequate power.

“Today” or “Tomorrow” and a time indicate that your transmitter needs to be recharged, and your organizer has scheduled recharging to occur either today or tomorrow at the indicated time.

“Charging” indicates that your organizer is currently recharging the transmitter.

“Charging Suspended” indicates that your organizer is unable to recharge the transmitter because of power demands by your organizer (typically, the backlight is in use). To resume recharging, turn off the backlight or simply turn off your unit. Recharging resumes when power demands are reduced.

“Insert new AAA batteries” indicates that the batteries in your organizer lack sufficient power to continue recharging the transmitter. Insert new batteries as soon as you can.

Charge Finish: Appears only when recharging has been scheduled or is under way. Displays the estimated time that recharging will end.

Recharging takes less time than the initial charging of the transmitter. While the transmitter is being recharged, you cannot use query applications or the iMessenger™ application. You can, however, use all other applications.

Important: You yourself cannot replace the transmitter, even when it can no longer be recharged, because attempting to open the organizer voids the warranty. There are no parts inside your organizer that you can replace, so do not attempt to open it. See “Palm.Net™ Service Agreement, Warranty, and Other Product Information” for details.

For information on returning the organizer to 3Com, visit the web site <http://www.palm.net>

The RBRC Battery Recycling Seal is on the NiCad battery inside your organizer, which indicates that 3Com is voluntarily participating in an industry program to collect and recycle these batteries at the end of their useful life, when taken out of service in the United States or Canada. The RBRC program provides a convenient alternative to placing used NiCad batteries into the trash or the municipal waste stream, which is illegal in some areas. Please call 1-800-8-BATTERY for information on NiCad battery recycling in your area. 3Com Corporation’s involvement in this program is part of our commitment to preserving our environment and conserving our natural resources.

If you ever dispose of your organizer, please dispose of it without damaging the environment. Either return your organizer to 3Com, or take it to your nearest environmental recycling center.

Proper use of the antenna

The antenna of your organizer is designed to be durable and can easily withstand years of normal use. It is a movable part, however, so it's important to handle it with care. Keep these points in mind as you use the antenna:

- Do not lift or drag your organizer by the raised antenna.
- Do not bend the antenna.
- When you raise the antenna, you feel three clicks at its three positions: 90°, 135°, and 180°. We recommend that you transmit or receive data only after you raise the antenna at least to 90°.
- Whenever you're not using an application that performs wireless transactions, keep the antenna fully lowered.
- Before you use the wireless features of your organizer, please observe the guidelines or prohibitions on the use of wireless devices in your current location. For example, when you are on an airplane, do not raise the antenna or use the wireless features at times when the Federal Aviation Administration (FAA) or airline regulations prohibit the use of cellular phones. You can, of course, use all other applications of your organizer in accordance with airline regulations for electronic devices.

If the antenna is damaged, you can remove it and replace it with another antenna. For information on ordering a new antenna, visit the web site <http://www.palm.net>.

Important: Do not remove the antenna until you have a new antenna ready to install. Using the wireless features without an antenna can damage your organizer.

To remove the antenna:

1. Perform a HotSync operation, and then turn off your organizer.
2. Remove the AAA batteries.

Important: When you remove the batteries, the built-in backup power of your organizer maintains memory data. If you encounter any difficulties or delays while you're replacing the antenna, however, we recommend that you reinstall the batteries and wait a few minutes for the backup power to recharge. Then start the replacement process again.

3. Raise the antenna to 180°.

To be sure the antenna is raised to 180°, place the organizer face down on a flat surface and flatten the antenna against the surface.

4. Grasp the antenna close to the pivot point with your thumb and index finger.
5. Using your thumb, firmly push the antenna out of the pivot point.

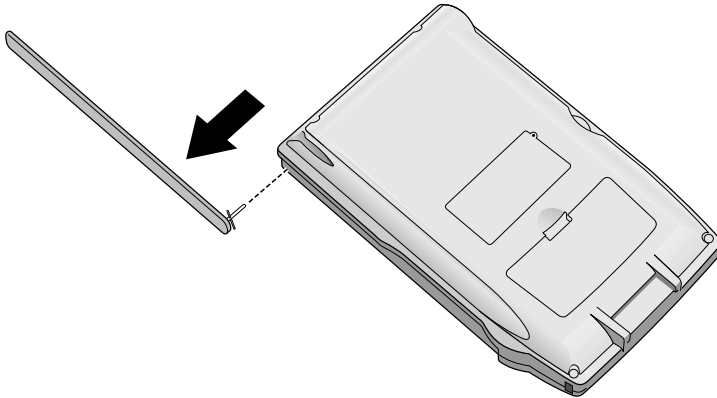

Note: After you remove the antenna, be careful not to change the alignment of the pivot point.

To insert the new antenna:

1. Holding the antenna in the 180° position, insert the contact pin into the center hole of the pivot point.
2. Align the transverse pin with the opening for it in the pivot point. Push the antenna the rest of the way into the pivot point until you feel the antenna snap into place.

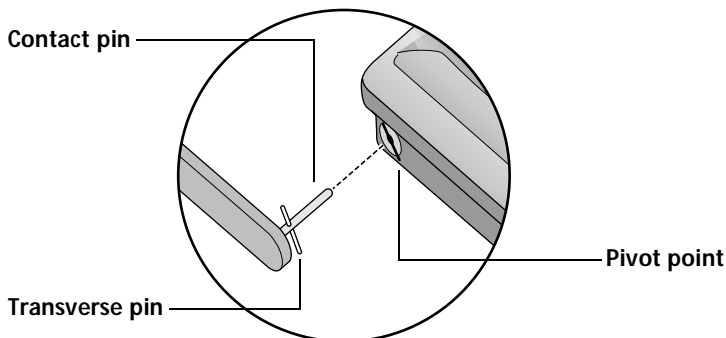

3. Lower the antenna.

4. Put the AAA batteries back in.
5. If necessary, perform a HotSync operation to restore your data.

Resetting your organizer

Under normal circumstances, you will not have to use the reset button. On rare occasions, however, your organizer may no longer respond when you press buttons or tap the screen. In this case, you need to reset your organizer so that it will work again.

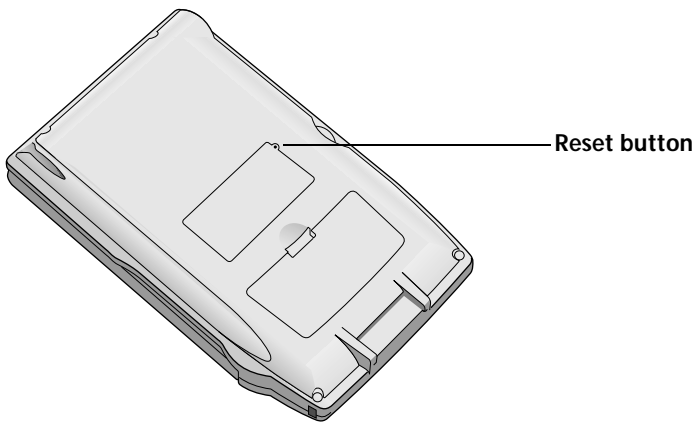

Performing a soft reset

A soft reset tells your organizer to stop what it's doing and start over again. All records stored in your organizer are retained with a soft reset.

Tip: The stylus that comes with your organizer has a reset tool inside. To use the tool, unscrew the top of the stylus.

To perform a soft reset:

- Use the reset tool, or the tip of an unfolded paper clip (or similar object *without* a sharp tip), to gently press the reset button inside the hole on the back panel of your organizer.

After a soft reset, the Welcome screen appears, followed by the General Preferences screen (to set time and date).

Performing a hard reset

With a hard reset, all records stored in your organizer are erased. Never perform a hard reset unless a soft reset does not solve your problem.

After performing a hard reset, you can transfer the data in Palm™ Desktop software to your organizer by performing a HotSync operation.

To perform a hard reset:

1. Hold down the power button on the front panel of the organizer.
2. While holding down the power button, use the reset tool, or the tip of an unfolded paper clip (or similar object *without* a sharp tip), to gently press the reset button.
3. Release the reset button, and then release the power button.
4. When a message appears on the organizer screen warning that you are about to erase all the data stored on your organizer, do one of the following:

Press the upper half of the scroll button on the front panel of the organizer to complete the hard reset and start Setup.

Press any other button to perform a soft reset.

Besides erasing all records, note these results of a hard reset:

- The current date and time are retained.
- Formats Preferences and other settings are restored to their initial default settings.
- Preloaded query applications reappear on your organizer. Other add-on applications, however, are deleted from your organizer, so you need to re-install them.
- If you use a proxy server other than the Palm.Net proxy server, you must re-enter its IP address. See “Wireless preferences” in Chapter 8 for details.

To restore your data after a hard reset:

Important: Be sure to perform a HotSync operation *before* you use the Check & Send command in the iMessenger application.

1. Click the HotSync icon ™ in the Windows system tray (bottom-right corner of the taskbar).

2. From the HotSync Manager menu, choose Custom.

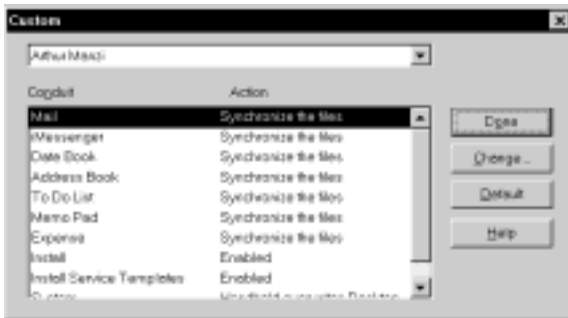

3. Select the appropriate user name from the list.
4. Select an application in the Conduit list.
5. Click Change.



6. Select Desktop overwrites handheld.

Note: Changing the HotSync setting from the default affects only the *next* HotSync operation. Thereafter, the HotSync actions revert to their default settings.

7. Click OK.
8. Repeat steps 4 through 7 to change conduit settings for other applications.
9. Click Done to activate your settings.
10. Perform a HotSync operation.

Appendix B

Frequently Asked Questions

If you encounter a problem with your organizer, please search the following areas before you contact Customer Care or Technical Support:

- The solutions offered in this chapter
- The README file and HelpNotes located in the folder where you installed Palm™ Desktop organizer software on your computer (or on your installation CD-ROM or diskettes)
- The Palm Desktop online Help
- The latest Palm VII™ organizer customer support information on <http://www.palm.net>

If you are unable to find a solution in these areas, contact Customer Care or Technical Support. For e-mail addresses and telephone numbers, see the *Getting Started* guide, which comes with your organizer.

Note: Many third-party add-on applications have been designed for the Palm Computing® platform. Unfortunately, we are not able to support such a large number of third-party applications. *If you are having a problem with a third-party application, please contact the developer or publisher of that software.*

Software installation problems

Problem

When I install Palm Desktop software I get an error that a modem is attached to my serial port, but there is no modem attached.

Solution

Take your organizer out of the cradle and install again.

Operating problems

Problem	Solution
I don't see anything on my organizer's screen.	Try each of these in turn: <ul style="list-style-type: none">■ Adjust the contrast control.■ Make sure batteries are installed properly.■ Replace the batteries. If your organizer still does not operate, try a soft reset. See "Resetting your organizer" in Appendix A.
I get a warning message telling me my organizer memory is full.	<ul style="list-style-type: none">■ Purge the Date Book, To Do List, Mail, and iMessenger™ applications. This removes records that you deleted from these applications from memory. You may need to perform a HotSync® operation to recover the memory.■ Delete unused memos and records. If necessary, you can save these records. See "Deleting records" in Chapter 4.■ If you have installed additional applications on your organizer, remove them to recover memory. See "Removing applications" in Chapter 3.
My organizer keeps turning itself off.	Your organizer is designed to turn itself off after a period of inactivity. This period can be set at one, two, or three minutes. Check the Auto-off setting. See "General preferences" in Chapter 8.
My organizer is not making any sounds.	Check the System Sound setting. See "General preferences" in Chapter 8.
My organizer has frozen.	Perform a soft reset. See "Resetting your organizer" in Appendix A.

Tapping and writing problems

Problem	Solution
When I tap the buttons or screen icons, my organizer activates the wrong feature.	Calibrate the screen. See “Digitizer preferences” in Chapter 8.
When I tap the Menu icon  , nothing happens.	Not all applications or screens have menus. Try changing to a different application.
I can't get my organizer to recognize my handwriting.	<ul style="list-style-type: none">■ For your organizer to recognize handwriting input with the stylus, you need to use Graffiti® writing. See “Using Graffiti writing to enter data” in Chapter 2.■ Make the Graffiti character strokes in the Graffiti writing area, not on the display part of the screen.■ Write Graffiti strokes for letters in the left-hand side, and the strokes for numbers in the right-hand side of the Graffiti writing area.■ Make sure that Graffiti is not shifted into extended or punctuation modes.■ See “Graffiti tips” in Chapter 2 for tips on increasing your accuracy when you write Graffiti characters.

Wireless problems

Problem

Solution

The signal strength is weak.

- Make sure the antenna is pointing straight up, perpendicular to the ground:
If you hold your organizer in your hand, raise the antenna to 135°.
If you lay it on a table or other surface parallel to the ground, raise the antenna to 90°.

Tap the Diagnostics icon . Then monitor the signal strength while you try the following solutions:

- Move away from your original location, five to ten feet in any direction.
- If you are indoors, stand near a window, or move outdoors.
- Open metal blinds on windows.
- If you are in an underground parking lot or other space below street level, move to a location aboveground.
- If you are in a crowd, move to a less crowded area.
- If you're in a vehicle, keep your organizer level with the windshield. The metal frame of the vehicle shields radio signals. Mountains and buildings may also block signals.
- If you're outdoors, move away from overhead electrical wires. Move from under trees.

I forgot the password to my Palm.Net™ service account.

Visit <http://www.palm.net>, or contact Customer Care. See the *Getting Started* guide for contact information.

Application problems

Problem

Solution

I tapped the Today button, but it does not show the correct date.

Your organizer is not set to the current date. Make sure the Set Date box in the General Preferences screen displays the current date. See “General preferences” in Chapter 8 for more information.

I know I entered some records, but they do not appear in the application.

- Check the Categories pick list (upper-right corner of the screen). Choose All to display all of the records for the application.
- Check Security and make sure that the Private Records setting is set to Show private records.
- In To Do List, tap Show and check whether Show Only Due Items is selected.

I am having problems listing memos the way I want to see them.

- If you cannot manually arrange the order of the memos in the List screen, check the Memo Preferences setting. Make sure that Sort by is set to Manual.
- If you choose to view your memos alphabetically on Palm Desktop software and then perform a HotSync operation, the memos on your organizer still appear in the order defined in the Memo Preferences setting. In other words, the sort settings that you use with Palm Desktop software *are not* transferred to your organizer.

I created an event in Date Book, but it doesn't appear in the Week View.

In the Week View, you cannot select overlapping events that have the same start time. If you have two or more events with the same start time, choose the Day View for the particular day to see the overlapping events.

HotSync problems

Problem	Solution
I cannot do a HotSync operation; what should I check to make sure I am doing it correctly?	<ul style="list-style-type: none">■ Check the Windows system tray to make sure the HotSync Manager is running. If it is not, open Palm Desktop software.■ Click the HotSync Manager, choose Setup, and click the Local tab. Check that the Serial Port setting displays the correct serial (COM) port where your cradle is attached.■ Make sure the cradle is connected securely.
I did a HotSync operation, but one of my applications did not synchronize.	Click the HotSync Manager and choose Custom. Check that the correct conduit is active.
I am using Outlook as my PIM, but I cannot do a HotSync operation.	<ul style="list-style-type: none">■ Click the HotSync Manager and choose Custom. Check that the correct conduit is active.■ Check that the correct conduit is installed. Reinstall the HotSync Manager and make sure the correct conduit is selected.
I cannot launch the HotSync Manager.	<ul style="list-style-type: none">■ Make sure you are not running another program, such as America Online, CompuServe, or WinFax, that uses the serial port you selected in the Setup dialog box.■ Uninstall and then reinstall Palm Desktop software.

I tried to do a local HotSync operation, but it did not complete successfully.

Try each of these in turn:

- Make sure HotSync Manager is running. If HotSync Manager is running, exit and restart it.
- Make sure you selected Local from the HotSync Manager menu or the Palm Desktop software menu.
- Check the cable connection between the cradle and the serial port on your computer.
- Make sure you selected the correct serial port on the Local tab in the Setup dialog. It should be set to the port where you connected the cradle.
- Try a lower baud rate setting on the Local tab in the Setup dialog.
- Make sure you are not running another program, such as America Online, CompuServe, or WinFax, that uses the serial port you selected in the Setup dialog box.
- Read the HotSync Log for the user account for which you are performing a HotSync operation.
- Make sure your organizer is seated in the cradle correctly.
- Make sure the gold-plated connectors on the cradle and your organizer are clean. Use a pencil eraser to clean them.

I tried to do a modem HotSync operation, but it did not complete successfully.

Check the following on your computer:

- Make sure your computer is turned on and that it does not shut down automatically as part of an energy-saving feature.
- Make sure the modem connected to your computer is turned on and is connected to the phone line.
- Make sure Modem is checked in the HotSync Manager menu.
- Make sure the modem you are using with your organizer has an on-off switch. Your organizer cannot “wake up” a modem that has an auto-off feature.
- Confirm that the Setup String in the Setup dialog box configures your modem correctly. You may need to select a different Modem Type or enter a custom Setup String. Most modems have a Setup String that causes them to send initial connection sounds to a speaker. You can use these sounds to check the modem connection.
- Confirm that the Speed setting in the Setup dialog box is appropriate for your modem.
- If you have problems using the As Fast As Possible option or a specific speed, try using a slower speed.
- Make sure you are not running another program, such as America Online, CompuServe, or WinFax, that uses the serial port you selected in the Setup dialog box.

I tried to do a modem HotSync operation, but it did not complete successfully.
(continued)

- Make sure your modem resets before you try again. (Turn off your modem, wait a minute, then turn it back on.)

Check the following on your organizer:

- Confirm that your modem is turned on.
- Make sure the dialing instruction dials the correct phone number.
- If you need to dial an outside line prefix, make sure you selected the Dial Prefix option on your organizer and entered the correct code.
- If the telephone line you are using has Call Waiting, make sure you selected the Disable call waiting option under Modem Sync Phone Setup on your organizer and entered the correct code.
- Make sure the telephone line you are using is not noisy, which can interrupt communications.
- Make sure your modem resets before you try again. (Turn off your modem, wait a minute, then turn it back on.)

Beaming problems

Problem

I cannot beam data to another Palm Computing platform device.

When someone beams data to my organizer, I get a message telling me it is out of memory.

Solution

- Confirm that your organizer and the other Palm VII organizer are between ten centimeters (approximately 4") and one meter (approximately 39") apart, and that the path between the two devices is clear of obstacles. Beaming distance to other Palm Computing platform devices may be different.
- Move your organizer closer to the receiving device.
- Your organizer requires at least twice the amount of memory available as the data you are receiving. For example, if you are receiving a 30K application, you must have at least 60K free.
- Perform a soft reset. See "Performing a soft reset" in Appendix A.

Password problems

Problem	Solution
I forgot the password, and my organizer is not locked.	<p>You can use Security to delete the password. If you do this, your organizer deletes all entries marked as private. You can, however, perform a HotSync operation <i>before</i> you delete the password: the HotSync process backs up all entries, whether or not they are marked private. In this case, the following procedure restores your private entries and lets you access them:</p> <ol style="list-style-type: none">1. Use the Palm Desktop software and the cradle to synchronize your data.2. Tap Forgotten Password in Security to remove the password and delete all private records.3. Perform a HotSync operation to synchronize your data and restore the private records by transferring them from your computer to your organizer.
I forgot the password and my organizer is locked.	<p>If you assign a password and lock your organizer, you must perform a hard reset to continue using your organizer. See “Performing a hard reset” in Appendix A for more information.</p>
I forgot the password to my Palm.Net service account.	<p>Visit http://www.palm.net, or contact Customer Care. See the <i>Getting Started</i> guide for contact information.</p>



Technical support and customer care

If, after reviewing the sources listed at the beginning of this appendix, you cannot solve your problem, contact your regional technical support office by e-mail, phone, or fax. For support e-mail addresses and phone numbers, see the *Getting Started* guide, which comes with your organizer.

Before requesting support, please experiment a bit to reproduce and isolate the problem. When you do contact support, please be ready to provide the following information:

- The name and version of the computer operating system you are using
- The actual error message or state you are experiencing
- The steps you take to reproduce the problem
- The version of organizer software you are using and available memory

To find version and memory information:

1. Tap the Applications icon .
2. Tap the Menu icon .
3. Tap App, and then tap Info.
4. Tap Version to see version numbers, and tap Size to see the amount of free memory, in kilobytes.

Note: Many third-party add-on applications have been designed for the Palm Computing platform. Unfortunately, we are not able to support such a large number of third-party applications. *If you are having a problem with a third-party application, please contact the developer or publisher of that software.*

Appendix C

Creating a Custom Expense Report

This section explains how to modify existing Expense application templates and how to create your own custom expense report templates for use with the Expense application.

Note: This section assumes that you are familiar with Microsoft Excel or a similar spreadsheet application. If you are not familiar with Microsoft Excel, consult your company's Information Services department or another experienced user.

About mapping tables

Before creating or modifying an Expense template, it's important to understand the function of the Palm™ Desktop organizer software Expense application. In simple terms, the Expense application is designed to move Expense data from your organizer into a Microsoft Excel spreadsheet.

Each Expense item stored in your organizer represents a group of related data. The following data can be associated with an expense item:

- Category
- Date
- Expense Type
- Amount
- Payment Method
- Payment Currency
- Vendor
- City
- Attendees
- Note

When you perform a HotSync® operation between your organizer and Palm Desktop software on your computer, the Expense data is stored on your computer (in a file named Expense.txt). When you open the Expense application in Palm Desktop software, an Excel macro starts, and populates an expense template with your data based on the rules specified in a spreadsheet file named Matable.xls.

The Matable.xls file is an editable spreadsheet that functions as a "mapping table." The function of the mapping table is to guide the Excel macro in extracting the Expense data. The mapping table tells

the Excel macro how large the spreadsheet is and provides the data-cell layout of the Excel template used for the Expense Report.

Customizing existing sample templates

Four sample Expense Report templates come with Palm Desktop software. These templates are stored in the Template folder (which is in the same folder as Palm Desktop software).

If the layout of one (or more) of these templates is appropriate for your reporting needs, you can easily customize the templates with your company name and other information.

To customize a sample Expense Report template:

1. Make a backup copy of the contents of the Template folder.

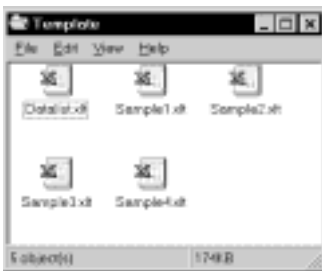

2. Double-click the name of the sample template you want to modify to open it in Microsoft Excel.
3. Make any changes that you want to the names (or other information) in the sample template.

Important: *Do not* insert rows or columns in the sample template. Doing so changes the way your Expense data maps to the template and causes errors. If you want to move the cells to a different location or add or delete rows or columns, you have to make changes to the Mappable.xls file.

Note: You can insert your own company logo without changing the Mappable.xls file. If you change the file name, however, you need to make a corresponding change in the Mappable.xls file.

You can also rename cells without changing the Mappable.xls file, provided that the expense type corresponds to your organizer data. For example, you can

change “Snack” to “Munchies,” and then all items entered on your organizer as “Snack” map to the cell(s) labeled “Munchies.”

4. From the File menu, choose Save As.
5. Click the Save as type drop-down list and choose Template (*.xlt).
6. Navigate to the Template folder (in the Palm Desktop software directory).

Note: If you *do not* need to change the Mappable.xls file, save the template file with its *original file name* (e.g., Sample2.xlt).

If you *do* need to change the Mappable.xls file, give your modified template a unique name. Be sure to use the .xlt file suffix, which defines the file as a Microsoft Excel template.

7. Click Save to save your modified template and make it available for future use.

Note: If you need to modify the Mappable.xls file, you must do this before you can use the modified template with your Expense data. To modify the Mappable.xls file for your new template, see “Programming the mapping table” later in this appendix. *Read all of the sections of this appendix before making changes to the Mappable.xls file.*

Determining the layout of the Expense Report

This section describes the layout considerations for the Expense Report and explains the terms used for creating the report.

Labels

There are two kinds of labels that you need to define for your report: day/date and expense type. Each kind of label can be either Fixed or Variable. A Fixed label means that the label *always* appears as a header at the beginning of a row or column. If a label is not Fixed, it is variable.

For example, a list table of expenses could have variable labels in the rows for day/date, and variable labels in the columns for expense type. In this case, neither day/date or expense type information would be “fixed” (as a header). Instead, the date and expense type information would be filled into the cells of the spreadsheet as appropriate.

Examples of both Fixed and Variable labels appear in the sample expense templates.

Sections

A Section is an area of the report that has common formatting. It is common for an Expense report to have more than one Section. For example, the following sample Expense Report named Sample3.xlt contains several Sections.

1	2	3	4	5	6	7	8	9	10
				Report:	Day:	Dept:	Project:		
Expense Report									
5	ITINERARY		DATE						
6			CITY						
7			CITY						
9	M E A L S	Breakfast	Employee paid						
10			Company paid						
11			Employee paid						
12		Lunch & Snack	Company paid						
13			Employee paid						
14		Dinner	Company paid						
15			Employee paid						
16		Business meals & entertainment	Company paid						
17		Employee paid							
18	Conference	Company paid							
19	M I S C		Employee paid						
20		Postage	Company paid						
21			Employee paid						
22		Parking & Tolls	Company paid						
23			Employee paid						
24		Gifts, Tips, Suppl	Company paid						
25		Incidentals, Other	Employee paid						
26									
27	BUSINESS MEALS AND ENTERTAINMENT EXPENDITURES								
28									
29									
30	Date	Expense Type	Amount	Vendor	Class				
31									

Because your Expense data maps to row and column areas of your final report, different Sections require different definitions for the data mapping. To create additional Sections with different mapping, you create corresponding additional lines to the mapping table file named Mappable.xls. This procedure is explained later in this appendix.

If a section contains cells for prepaid (company paid) expenses, you need to create an additional line in the mapping table for “prepaid.” This will count as an additional section in the mapping table. The only data that differs in the prepaid section (from the non-prepaid section) is the row/column numbers for the expense type.

Analyzing your custom Expense Report

If you already have a custom Excel expense report, you can use it with a modified mapping table. However, before you can create a Mappable.xls file that corresponds to your custom Expense Report, you must first analyze the characteristics of your report.

Perform the following before you begin a custom mapping table:

- Print a copy of your custom expense report. Activate the Row and Column Headings option in the Sheet settings of the Page Setup command. This enables you to quickly determine the size of the Section(s), as well as the numbers for the start rows and columns.
- On the printed copy, identify the data Sections. A Section is an area of data with common row and column formatting. A yellow highlighter marking pen can make it easy to see the Sections as you work with programming the mapping table. Your custom Expense Report can contain any number of Sections, and the same data can be repeated in any Section.
- On the printed copy, identify the type of Labels that apply to each Section. Each Section can have only one kind of Fixed or Variable Label for rows. Likewise, each Section can have only one kind of Fixed or Variable Label for columns.
- Place a copy of your custom Expense Report in the Template folder (in the Palm Desktop software directory). Change the file name so it has the file extension .xlt (which defines it as a Microsoft Excel template). Make a note of the exact file name so it can be defined in the mapping table file.

Programming the mapping table

Once you have analyzed the components of your custom Expense Report, you can program the mapping table to fill the report with data from the organizer.

To program a new custom mapping table:

1. Open a copy of the Maptable.xls file in Microsoft Excel.

Note: This file is located in the same folder as the Palm Desktop software application. *Make a backup copy of this file before you make your modifications.*

2. Mapping a new template. Scroll to where you find the name of the original template that you chose for your modifications. The name of the template will appear in column B of the Maptable.xls file, next to the cell highlighted in green that reads "Template Name:". If you did not modify an existing template, move to any table in the Maptable.xls file.
3. Select all the rows associated with the template name. To select the rows, click and drag on the row numbers (left side), so they appear highlighted.

	1	2	3	4	5
5	Template Name:	SAMPLE1.XLT			
6		ROW			
7		Fixed Label		Variable Label by	
8		Day/Date	Expense Type	Day/Date	Expense Type
9	Section:			X	
10					
11					
12					
13	Template Name:	SAMPLE2.XLT			
14		ROW			
15		Fixed Label		Variable Label by	
16		Day/Date	Expense Type	Day/Date	Expense Type
17	Main		X		
18	Business&Entertainment			X	
19					
20					
21					
22	Template Name:	SAMPLE3.XLT			
23		ROW			
24		Fixed Label		Variable Label by	
25		Day/Date	Expense Type	Day/Date	Expense Type
26	Main (PREPAID)		X		
27	Main		X		

All rows associated with template are selected

4. From the Edit menu, choose Copy.

5. Scroll down to a blank area of the Mappable.xls file (below the rows used for Sample4.xlt), and click on a row number to select a blank row.
6. From the Edit menu, choose Paste. A copy of the rows you selected in step 3 is pasted into the Mappable.xls file.
7. Name the table. In the cell immediately to the right of the cell entitled Template Name, enter the *exact* file name of your custom Expense Report template.
8. Define the number of Sections. Each row in a table defines how your organizer data will be placed in a Section of your custom Expense Report. Note that the prepaid portion of a section has its own row and counts as a separate section for map table purposes, *even though it is not a separate section in your template.*

22	Template Name:	SAMPLE3.XLT	
23			ROW
24		Fixed Label	
25		Day/Date	Expense Type
26	Main (PREPAID)		X
27	Main		X
28	Business Meals & Entertainment		
29	Mileage Log		

Table with four sections

You may add or delete rows as necessary so that the total number of rows corresponds to the number of Sections in your custom Expense Report. To clear all of the existing settings in a row, click to select the row and press Ctrl+Delete. Name each row to correspond to a Section of your custom Expense Report.

9. Determine the Label settings. The orientation of the data fields (Row, Column) appears in the yellow section of the table.

SAMPLE1.XLT		ROW				COLUMN			
		Fixed Label		Variable Label by		Fixed Label		Variable Label by	
Day/Date	Expense Type	Day/Date	Expense Type	Day/Date	Expense Type	Day/Date	Expense Type	Day/Date	Expense Type
		X							X

Determine whether the **Rows** will contain expense or date information, and place an “x” in the appropriate cell. When you do this, you also define whether the label is Fixed or Variable. You can place only one “x” in the Row section (columns 2–5).

Determine whether the **Columns** will contain expense or date information, and place an “x” in the appropriate cell. When you do this, you also define whether the label is Fixed or Variable. You can place only one “x” in the Column section (columns 6–9).

10. Define the dimensions of the Section. The dimensions of the Section appear in the green columns (10–13).

# of Rows	# of Columns	Start Row	Start Column
30		12	1

of Rows: Represents the total number of rows in the Section, excluding any header or total rows. In other words, this includes only the number of rows in the Section where your organizer data will be placed.

of Columns: Represents the total number of columns in the Section, excluding any header or total columns. In other words, this includes only the number of columns in the Section where your organizer data will be placed.

Start Row: Is the number of the first row of the Section that will be filled with your organizer data.

Start Column: Is the number of the first column of the Section that will be filled with your organizer data.

11. Define the Dates and Intervals. The dates and intervals between dates appears in the light blue columns (14–17).

Date	Intervals		
	Between		
Date	Dates	Start day	Day
1	0		

In the **Date** cell, enter the row or column number where all the date information will be placed.

In the **Dates** cell, enter the number of blank columns (or rows) separating the date fields. If there are no blank columns (or rows) between date entries, leave this number set to zero.

In the **Start Day** cell, enter the day of the week that starts the expense reporting period. Enter a three-character abbreviation for the day (e.g., Sun, Mon, Tue).

In the **Day** cell, enter the row or column number where all the day information will be placed. If the dates are in a row, enter the row number. If the dates are in a column, enter the column number.

12. Define whether the Section is in list format. This setting appears in the light purple columns (18–19).

Listing Format	Expense Type
YES	8

If the Section will present the data in a list format, enter the word “yes”. Otherwise, enter the word “no”. The following diagram shows data presented in a list format:

6	Date	Category	Type	Amount	Country	Payment Type
7						
8						
9						
10						
11						

Only if your section is in list format: In the Expense Type cell, enter the number of the row or column where the expense description will be placed. Expense amounts can be entered in several different columns or rows if required by your template. *Expense type labels* must all appear in the same column.

13. Enter the row or column numbers for the expense types that appear in the Section. These settings appear in the aqua columns (20–48).

Expense Types					
Refuel	Breakfast	Bus	Business Meals	Car Rental	Dinner
4	4	4	4	4	4

For these settings, simply enter the row or column number for the expense types that you want to appear in the Section. Note that the same row or column number can be used more than once. An example of this would be meals that encompass breakfast, lunch, dinner, and snacks. In the previous example, all expense items would be populated into row/column 4 of the custom Expense Report.

14. Complete the table. All of the remaining columns (49–57) in the table are used to define the column or row number that corresponds to the description.

15. Mark a Section for prepaid expenses (yellow column). If a row in the map table is for prepaid (company paid) expenses, type a “yes” in the cell on that Section’s row. Type “no” in all the cells of this column that do not pertain to prepaid expenses.

NO
PrePaid
NO
YES
NO

16. Repeat steps 9 through 15 for each Section that you have defined for your custom Expense Report.
17. Map Expense Report Options dialog (magenta section). The Expense Report Options dialog has five fields where you can enter data for the header on your expense report. Use this section to specify the row and column on your template where this information will be mapped.

Employee Name		Department	
Header/Row	Header/Col	Header/Row	Header/Col
2	5	2	5

Because header data is not related to any particular Section, you have to enter data in only one row. If the item does not appear on your template, leave these cells blank.

Using applications other than Microsoft Excel

You can use applications other than Microsoft Excel (such as Lotus 1-2-3 or Quattro Pro) to open and manipulate the Expense data on your computer. The data file is named “Expense.txt,” and is stored in the Expense folder, within the folder containing the organizer user data.

Expense data in the Expense.txt file is in tab-delimited format.

Expense file details

The Expense.txt file contains four groups of data. It will be easier to see these four distinct groups of data if you open the file with a spreadsheet application.

Trips	Shows the number of Expense application categories, and lists each one followed by an “end” statement.
Currency	Shows how many currencies were used for the Expense data, and lists the countries that correspond to that currency.
Trip	Shows the number of expenses by category, and lists the expenses for each category.
Expenses	Shows the total number of expenses, and lists them chronologically.

Appendix D

Non-ASCII Characters for Login Scripts

The following information enables you to create custom login scripts that require non-ASCII characters. It is provided for advanced users who understand the use and requirements of such characters in a custom login script.

Use of ^char

You may use the caret (^) to transmit ASCII command characters. If you send ^*char*, and the ASCII value of *char* is between @ and _, then the character is automatically translated to a single-byte value between 0 and 31.

For example, ^M is converted to a carriage return. If *char* is a value between a and z, then the character sequence is translated to a single-byte value between 1 and 26. If *char* is any other value, then the character sequence is not subject to any special processing.

For example, the string “Joe^M” transmits Joe, followed by a carriage return.

Carriage return and line feed

You may include carriage return and line feed commands as part of the login script, when entered in the following format:

- <cr> Sends or receives a carriage return
- <lf> Sends or receives a line feed

For example, the string “waitfor Joe<cr><lf>” waits to receive Joe followed by a carriage return and line feed from the remote computer before executing the next command in the script.

Literal characters

The backslash (\) character defines that the *next character* is transmitted as a literal character, and is not subject to any special processing ordinarily associated with that character.

Examples:

- \^ Includes a caret as part of the string
- \< Includes a < as part of the string
- \\ Includes a backslash as part of the string

Palm.Net™ Service Agreement, Warranty, and Other Product Information

Palm.Net service agreement

NOTICE TO END USER: CAREFULLY READ THE FOLLOWING LEGAL AGREEMENT (“AGREEMENT”). USE OF THE PALM.NET™ WIRELESS COMMUNICATION SERVICE (THE “SERVICE”) CONSTITUTES YOUR ACCEPTANCE OF THESE TERMS. IF YOU DO NOT AGREE TO THE TERMS OF THIS AGREEMENT, DO NOT ACTIVATE THE SERVICE. AS USED IN THIS AGREEMENT “YOU” MEANS BOTH THE INDIVIDUAL ACTIVATING THE SERVICE AND ANY CORPORATION OR OTHER ENTITY RESPONSIBLE FOR THE PAYMENT OF THE CORRESPONDING ACCOUNT. UPON WRITTEN OR ELECTRONIC NOTICE TO YOU, 3COM MAY MODIFY THIS AGREEMENT, MAY MODIFY THE SERVICE RULES OR PRICES, AND MAY DISCONTINUE OR REVISE ANY OR ALL OTHER ASPECTS OF THE SERVICE.

1. General Information, Definitions, and Operating Policies.

1.1 Description. The Service is provided by Palm Computing, Inc., a subsidiary of 3Com Corporation, hereinafter referred to as “3Com,” through the facilities of a wireless service provider(s) to 3Com (“Wireless Service Provider”). The “Network” is the method by which a Palm VII™ device connects to the Service. A Venue Host is a third party content provider to the Service. By subscribing to the Service, you have accepted the terms of this Agreement. Further, you agree to use the Service in a manner consistent with any and all applicable laws and regulations. If any information provided by you is incomplete or inaccurate, 3Com retains the right to terminate your access to the Service.

(a) 3Com is providing you with access to various types of information through the Service which may include, without limitation, financial information, news, maps and directions (the “Information”) solely for your own use and not for further redistribution. The Information is the property of 3Com or its Venue Hosts (or other licensors) and is protected by applicable law. 3Com and its Venue Hosts (or other licensors) reserve any rights not expressly granted herein.

(b) The Information does not include the design or layout of the web pages on which the Information is displayed. Elements of such web pages are protected by trade dress and other laws and may not be copied or retransmitted without the express permission of the web site owner.

(c) Neither 3Com nor the Venue Hosts assume the responsibility of enforcing licensing requirements, or of checking for licenses, with respect to licensed professions or trades, prior to publishing advertisements. Neither 3Com nor the Venue Hosts are responsible for the content of any advertising published on the server.

(d) You may obtain information regarding the general availability and reception quality of the Service in a given location within the United States ("Service Ratings") through the Palm.Net site on the World Wide Web at the URL <http://www.palm.net> (the "Palm.Net Site") by entering the corresponding U.S. Postal Service zip code in the space provided. You acknowledge and agree, however, that the Service Ratings are merely approximate guidelines, and shall not be considered to be a warranty or representation of 3Com, the Wireless Service Provider or any other third party as to the availability and/or reception quality of a Network connection from any given location at any given time. You acknowledge that neither 3Com, the Wireless Service Provider nor any other third party shall be liable to you if the actual Service in a given location is not available or is not of the same reception quality as any posted Service Rating for such location.

1.2 Accounts. To use the Service, you must have an open, active account that corresponds to your Palm VII device.

1.3 Password Responsibility. Once you subscribe to the Service, you shall receive a password and an account. You are solely and entirely responsible for maintaining the confidentiality of your password. Furthermore, you are solely and entirely responsible for any and all activities which occur under your account. You agree to immediately notify 3Com of any unauthorized use of your account or any other breach of security known to you. You acknowledge that the complete privacy of your data and messages transmitted while using the Service cannot be guaranteed. For the purposes hereof, "use" means to transfer data over the Network.

1.4 Lost or Stolen Units. You agree to notify 3Com immediately if your Palm VII device is lost or stolen. If you fail to do so, any charges incurred on your account will be your responsibility.

2. Copyright and Licenses. You acknowledge that no title to the intellectual property in, or transmitted by, the Service is transferred to you. Subject to the terms and conditions of this Agreement, you will have a nonexclusive, nontransferable, nonassignable personal subscription to the Service for the term of this Agreement. The use of any Service software or documentation related thereto is licensed, not sold, to you for use only under the terms of the license contained herein.

3. Interruptions of Service. In the event that the Service is interrupted or you experience some other difficulty with the Service, including any problems or outages with the Network, 3Com shall use commercially reasonable efforts to try to correct problems with the Service as soon as reasonably possible. You acknowledge and agree that 3Com is not responsible for performance degradation and delays due to conditions on the Internet or due to the equipment or actions of the Venue Hosts.

4. Charges and Billing Practices.

4.1 Current Rates. You may obtain current rates and surcharges for using the Service via 3Com's web site located at <http://www.palm.net> or by calling the Palm.Net Service customer service department at 1-888-756-PALM. In addition, you are responsible for paying any governmental taxes imposed on your use of the Service, including, but not limited to, sales, use or value-added taxes. You are solely responsible for arranging payment for any and all additional or premium charges for your use of any third

party services via the Service.

4.2 Payment. To establish an individual, non-corporate accounts, payment must be made by a major credit card accepted by 3Com (currently, VISA, MasterCard, and American Express). For a corporate account, payment may be made by major credit card or via an approved purchase order. Cash will not be accepted.

4.3 Activation and Changes. Upon each activation of your account, you may be charged an activation fee. If you request any change to your level of service, you agree to pay any additional fees, if applicable, related thereto.

4.4 Billing Information. The billing period ends each month on the monthly anniversary of your activation date. If, however, the billing period would end on the 29th, 30th or 31st day of a month, the Billing Date will be the first day of the following month. You will be billed in advance for the next month's service level charge, and in arrears for any previously unbilled usage. It is possible that 3Com may (but you agree that it is not obligated to) give you the option to obtain an estimate of the then-current charges incurred by you since your last billing statement through the Palm.Net Site; however, you acknowledge that the amount displayed therein at any given time is only a general estimate of the total amount that will be billed to you in your next billing statement, and agree that additional charges owed by you for your use of the Service (including without limitation taxes, service level change fees, and other charges incurred but not yet billed to your account) may be included in your next monthly bill. If you have elected to pay for the Service by credit card and 3Com does not receive payment from the card issuer or its agent, you agree to pay all amounts due upon demand by 3Com. Each time you use the Service you agree and reaffirm that 3Com is authorized to charge your designated credit card. Your card issuer agreement governs your use of your designated card in connection with the Service, and you must refer to that agreement and not this Agreement to determine your rights and liabilities as a cardholder. Further, you agree that 3Com may delay obtaining authorization from your card issuer until submission of the accumulated charges.

4.5 Late Payment: Discrepancies. If 3Com does not receive the full amount of your Service account balance within thirty (30) days of the Billing Date, a late payment charge of one and one-half percent (1.5%) per month (or the highest amount allowed by law, whichever is lower) may be added to your bill and immediately become due and payable. Unless you notify 3Com of any discrepancies within sixty (60) days after they first appear on your account statement, they will be deemed accepted by you for all purposes, including resolution of inquiries made by your card issuer. You release 3Com from all liabilities and claim of loss resulting from any error or discrepancy that is not reported to 3Com within sixty (60) days of its first appearance on an invoice or credit card statement.

4.6 Deactivation for Non Payment. You agree to pay 3Com all reasonable attorney's fees and costs incurred by 3Com to collect any past due amounts. Your account may be deactivated without further notice if payment is sixty (60) days past due, regardless of the dollar amount. You agree to pay any outstanding balance in full within thirty (30) days of cancellation or termination of your Service account.

4.7 Reservation of Rights. 3COM RESERVES THE RIGHT, AT ANY TIME, TO CHANGE ITS FEES AND BILLING METHODS, INCLUDING THE ADDITION OF

SUPPLEMENTAL FEES OR SEPARATE CHARGES FOR CONTENT, OR SERVICES PROVIDED BY 3COM, EFFECTIVE THIRTY (30) DAYS AFTER AN ONLINE POSTING ON THE PALM.NET SITE. 3COM MAY ADDITIONALLY PROVIDE NOTICE OF BILLING CHANGES THROUGH YOUR DESKTOP E-MAIL OR THROUGH THE U.S. MAIL. If any such change is unacceptable to you, you may terminate your subscription to the Service, as provided in Section 5 below. YOUR CONTINUED USE OF THE SERVICE FOLLOWING THE EFFECTIVE DATE OF A CHANGE TO SUCH FEES AND BILLING METHODS SHALL CONSTITUTE YOUR ACCEPTANCE OF SUCH CHANGE.

5. Term; Termination; Effect of Termination.

5.1 Obligations. This Agreement shall be effective as of the date when you activate the Service. This Agreement shall remain in effect until terminated as set forth herein. 3Com reserves the right, in its sole discretion, to suspend or terminate your access to and use of Service without further notice if you breach any of the terms and conditions of this Agreement. Additionally, either you or 3Com may terminate this Agreement at any time without cause by sending notice to the other party.

5.2 Responsibilities. Termination of this Agreement shall not relieve you of any obligations to pay accrued charges, including any prorated charges accrued for the billing cycle in which this Agreement is terminated. The payment in advance for the next month's service level is nonrefundable.

5.3 Additional Charges. You will be charged for any additional charges beyond the monthly rates and applicable usage surcharges that have accumulated through the date of termination of your account, and will be billed for such additional amounts on the account's monthly anniversary date.

6. Links to Other Content. Some Service plans enable access through the Network to third-party World Wide Web sites and other resources. Neither 3Com nor any Venue Host assumes responsibility for the availability or content of these sites and resources. Therefore, any concerns that you may have regarding any site should be directed to the relevant site administrator or webmaster.

7. Availability of Service. The Service will be available in the United States and in the District of Columbia, EXCEPT for Alaska, Guam, Hawaii, the Marshall Islands, Montana, North Dakota, Puerto Rico, South Dakota, Vermont and Wyoming. There will also be areas within the 44 covered states and District of Columbia where the Service is not available. Specific coverage information will be available at the Palm.Net Site. If the Service is not available within your intended location, you agree that your sole remedy shall be to terminate this Agreement.

7.1 Compliance with Laws. You shall not use the Service in any manner contrary to local, state or federal law. 3Com expressly disclaims any and all responsibility or liability for any action by you that is contrary to such law(s) by you and reserves the right to terminate your Service immediately upon notice for your failure to comply with any such local, state or federal law.

8. Disclaimer of Service Warranties.

8.1 Subscription to Service does not affect the warranty that came with your Palm VII device. No additional warranty is provided as a result of subscribing to the Service. 3Com SPECIFICALLY DISCLAIMS ANY RESPONSIBILITY FOR ANY EQUIPMENT OR SOFTWARE PROVIDED BY YOU AND IN NO WAY WARRANTS THE CAPABILITIES OF ANY SUCH PROVIDED EQUIPMENT OR SOFTWARE USED IN CONJUNCTION WITH THE SERVICE OR THE PALM VII DEVICE. 3COM FURTHER MAKES NO REPRESENTATIONS OR WARRANTIES THAT THE PALM VII DEVICE OR THE SERVICE WILL ACHIEVE THE MAXIMUM NETWORK ACCESS SPEED SET FORTH IN ANY 3COM DOCUMENTATION.

8.2 YOU EXPRESSLY AGREE THAT USE OF THE SERVICE IS AT YOUR SOLE RISK. THE SERVICE IS PROVIDED ON AN "AS IS" AND AN "AS AVAILABLE" BASIS.

8.3 3COM AND ITS LICENSORS EXPRESSLY DISCLAIM ALL WARRANTIES OF ANY KIND, WHETHER EXPRESS, IMPLIED OR STATUTORY, INCLUDING, BUT NOT LIMITED TO THE IMPLIED WARRANTIES OF MERCHANTABILITY, FITNESS FOR A PARTICULAR PURPOSE, TITLE AND NON-INFRINGEMENT OF THIRD PARTY RIGHTS.

8.4 3COM MAKES NO WARRANTY THAT THE SERVICE WILL MEET YOUR REQUIREMENTS, OR THAT THE SERVICE WILL BE UNINTERRUPTED, TIMELY, SECURE, OR ERROR FREE; NOR DO 3COM OR ITS LICENSORS MAKE ANY WARRANTY AS TO THE RESULTS THAT MAY BE OBTAINED FROM THE USE OF THE SERVICE OR AS TO THE ACCURACY, COMPLETENESS OR RELIABILITY OF ANY INFORMATION OBTAINED THROUGH THE SERVICE. 3COM AND/OR ITS LICENSORS MAY MAKE IMPROVEMENTS AND/OR CHANGES IN THE SERVICE AT ANY TIME.

8.5 YOU UNDERSTAND AND AGREE THAT ANY MATERIAL AND/OR DATA DOWNLOADED OR OTHERWISE OBTAINED THROUGH THE USE OF THE SERVICE IS DONE AT YOUR OWN DISCRETION AND RISK AND THAT YOU WILL BE SOLELY RESPONSIBLE FOR ANY DAMAGE TO YOUR PALM VII DEVICE AND/OR YOUR COMPUTER SYSTEM OR LOSS OF DATA THAT RESULTS FROM THE DOWNLOAD OF SUCH MATERIAL AND/OR DATA.

8.6 3COM MAKES NO WARRANTY REGARDING ANY GOODS OR SERVICES PURCHASED OR OBTAINED THROUGH THE SERVICE OR ANY TRANSACTIONS ENTERED INTO THROUGH THE SERVICE.

8.7 NO ADVICE OR INFORMATION, WHETHER ORAL OR WRITTEN, OBTAINED BY YOU FROM 3COM OR THROUGH THE SERVICE SHALL CREATE ANY WARRANTY NOT EXPRESSLY MADE HEREIN.

8.8 SOME JURISDICTIONS DO NOT ALLOW THE EXCLUSION OF CERTAIN WARRANTIES, SO SOME OF THE ABOVE EXCLUSIONS MAY NOT APPLY TO YOU.

9. Limitation Of Liability For The Service.

9.1 3Com shall not be liable for any loss, injury, claim, liability or damage of any kind resulting in any way from (i) your use of the Service, (ii) your use of any equipment in connection with the Service, or (iii) the content of materials included with or accessed via use of the Service, or (iv) any goods or services purchased through the Service. Neither 3Com nor any Wireless Service Providers shall have any liability of any kind, direct or indirect, to you for any damages other than actual damages directly or proximately resulting from the failure, delay, or nonperformance of the Service. The limitations stated in this Section 9 ("Limitation of Liability") also apply to Venue Hosts and Wireless Service Providers.

9.2 3COM, WIRELESS SERVICE PROVIDERS AND/OR 3COM'S LICENSORS SHALL NOT BE LIABLE FOR ANY DIRECT, INDIRECT, INCIDENTAL, SPECIAL OR CONSEQUENTIAL DAMAGES, WHETHER BASED IN CONTRACT, TORT (INCLUDING NEGLIGENCE), STRICT LIABILITY, OR OTHERWISE, RESULTING FROM THE USE OR THE INABILITY TO USE THE SERVICE, RELATED FACILITIES, EQUIPMENT OR SOFTWARE, EITHER SEPARATELY OR IN COMBINATION WITH ANY OTHER SERVICES, FACILITIES, EQUIPMENT, OR SOFTWARE, WHETHER OR NOT PERFORMED OR PROVIDED UNDER THIS AGREEMENT, OR FOR COST OF PROCUREMENT OF SUBSTITUTE GOODS AND SERVICES OR RESULTING FROM ANY GOODS OR SERVICES PURCHASED OR OBTAINED OR MESSAGES RECEIVED OR TRANSACTIONS ENTERED INTO THROUGH THE SERVICE, OR RESULTING FROM UNAUTHORIZED ACCESS TO OR ALTERATION OF YOUR TRANSMISSIONS OR DATA, INCLUDING BUT NOT LIMITED TO, DAMAGES FOR LOSS OF PROFITS, USE, DATA OR OTHER INTANGIBLE, EVEN IF 3COM, WIRELESS SERVICE PROVIDERS AND/OR 3COM'S LICENSORS HAVE BEEN ADVISED OF THE POSSIBILITY OF SUCH DAMAGES.

9.3 NOTWITHSTANDING ANY OTHER PROVISION OF THIS AGREEMENT, THE MAXIMUM LIABILITY OF 3COM FOR DAMAGES HEREUNDER SHALL NOT EXCEED \$100.00 AND THE MAXIMUM COLLECTIVE LIABILITY OF 3COM AND WIRELESS SERVICE PROVIDERS FOR ACTUAL DAMAGES DIRECTLY AND PROXIMATELY RESULTING FROM THE FAILURE, DELAY, OR NONPERFORMANCE OF THE SERVICE HEREUNDER SHALL BE LIMITED SOLELY TO THE AMOUNT PAID BY YOU TO 3COM FOR THE SERVICE DURING SUCH PERIOD OF FAILURE, DELAY, OR NONPERFORMANCE.

9.4 SOME JURISDICTIONS DO NOT ALLOW THE LIMITATION OR EXCLUSION OF LIABILITY FOR INCIDENTAL OR CONSEQUENTIAL DAMAGES SO SOME OF THE ABOVE LIMITATIONS MAY NOT APPLY TO YOU.

10. Third Party Rights. The provisions of this Agreement are for the benefit of 3Com, Venue Hosts, and their respective licensors. Each of these individuals or entities shall have the right to assert and enforce this Agreement on its own behalf.

11. Messaging Service Terms and Conditions.

11.1 Rules of Use. If you elect to use the Wireless Internet Messaging Service (the "Messaging Service"), you hereby agree to comply with the additional terms and conditions set forth in this Section 11 ("Messaging Terms and Conditions"). You further

agree that this Agreement applies with equal force and effect to your use of the Messaging Service.

(a) You are solely responsible for the contents of your transmissions through the Messaging Service. Your use of the Messaging Service is subject to all applicable local, state, national and international laws and regulations.

(b) You agree: (1) to comply with US law regarding the transmission of technical data exported from the United States through the Messaging Service; (2) not to use the Messaging Service for unlawful or wrongful purposes, including, but not limited to, distributing material that (i) is copyrighted (except to the extent expressly permitted by the copyright owner), (ii) is obscene, libelous, harassing or discriminatory, (iii) is protected by trade secret, (iv) is an invasion of the privacy of a third party; (v) creates a clear and present danger, or (vi) advocates unlawful conduct; (3) not to interfere or disrupt networks connected to the Messaging Service; and (4) to comply with all regulations, policies and procedures of networks connected to the Messaging Service.

(c) You agree not to use the Messaging Service for chain letters, junk mail, spamming or any use of distribution lists to any person who has not given specific permission to be included in such a process.

11.2 Modifications To Messaging Service. 3Com reserves the right to modify or discontinue the Messaging Service with or without notice. 3Com shall not be liable to you or any third party should 3Com exercise its right to modify or discontinue the Messaging Service. You agree that 3Com has no obligation to monitor or regulate the transmissions sent by you. 3Com will endeavor to keep your messages private, viewable only by you and the person to whom you address it. However, systems operators may need to look at your messages if 3Com believes it is necessary to protect itself or others from injury or damage; for example, if 3Com has reason to believe you are involved in illegal activities which could lead the authorities to seize or search its system. 3Com reserves the right to the appropriate action if it becomes aware of any use of the Messaging Service which 3Com believes violates any law or is otherwise wrongful, including immediately terminating your access to the Messaging Service, but 3Com will not monitor messages unless it believes the Messaging Service is being misused.

11.3 No Resale Or Commercial Use Of The Service. Your right to use the Messaging Service is personal to you. You agree not to resell the use of the Messaging Service, without the express written consent of 3Com.

11.4 Indemnification. Since you are responsible for your transmissions and their consequences, you agree to indemnify and hold 3Com, its parents, subsidiaries, affiliates, officers and employees, harmless from and against any claim or demand, including reasonable attorneys' fees, made by any third party resulting from or arising out of your use of the Messaging Service (or the Messaging Service by persons using your password), your violation of this Agreement, or the infringement by you, or other user of the Messaging Service using your computer or password, of any intellectual property or other right of any person or entity.

12. General.

12.1 Entire Agreement. This Agreement is intended as the complete, final and exclusive statement of the terms of the agreement between the parties relating to the subject matter hereof and supersede all prior understandings, writings, proposals, representations or communications, oral or written, relating to the subject matter hereof. 3Com may make changes to this Agreement by notifying you in accordance with Section 12.3. No change requested by you shall be binding upon 3Com unless agreed to in writing executed by both parties.

12.2 Force Majeure. Except with respect to your payment obligations under this Agreement, neither party shall be liable to the other party for any alleged loss or damages resulting from delays in performance caused by acts of the other party, acts of civil or military authority, governmental priorities, earthquake, fire flood, epidemic, quarantine, energy crisis, strike, labor trouble, war, riot, accident, shortage, delay in transportation, or any other causes beyond the reasonable control of the party whose performance is so delayed.

12.3 Notices. You may send notices to 3Com by postal mail or by express delivery, addressed to 3Com at 5400 Bayfront Plaza, Santa Clara, CA 95052-8145, Attention: Palm VII Customer Care or at such other address as 3Com may provide. 3Com may send notices to you electronically by facsimile, desktop e-mail, or by postal mail, addressed to you at your last known address or number. All notices shall be deemed to have been given and received on the earlier of actual delivery or three (3) days from the date of postmark.

12.4 Waiver. A waiver of any default hereunder or of any of the terms and conditions of this Agreement shall not be deemed to be a continuing waiver or a waiver of any other default or of any other term or condition, but shall apply solely to the instance to which such waiver is directed. The exercise of any right or remedy provided in this Agreement shall be without prejudice to the right to exercise any other right or remedy provided by law or equity.

12.5 Severability. In the event any provisions of this Agreement are found to be invalid, illegal or unenforceable, the validity, legality and enforceability of any of the remaining provisions shall not in any way be affected or impaired thereby.

12.6 Assignment. Assignment of this Agreement shall be prohibited without the express written consent of the other party; except that 3Com shall be entitled to assign its rights and obligations hereunder to any subsidiary or affiliate or in connection with a merger or other business combination in which 3Com is not the surviving entity. Any attempted assignment in violation of this provision shall be null and void.

12.7 Governing Law. THE VALIDITY, PERFORMANCE, CONSTRUCTION, AND INTERPRETATION OF THIS AGREEMENT SHALL BE GOVERNED BY THE LAWS OF THE STATE OF CALIFORNIA, EXCLUDING CONFLICTS OF LAWS PRINCIPLES. The Superior Court of Santa Clara County and/or the United States District Court for the Northern District of California shall have jurisdiction and venue over all controversies in connection herewith.

12.8 **Arbitration.** All disputes, claims, and controversies between the parties arising out of or related to this Agreement or the breach thereof (except for non-payment or late payment; and breach of any obligation of confidentiality or infringement of any intellectual property right for which an injunction may be sought) shall be settled by arbitration. The arbitration shall be conducted by one arbitrator under the then current Commercial Arbitration Rules of the American Arbitration Association. The power of the arbitrator shall be limited to that possessed by a Superior Court Judge in California. The arbitrator is prohibited from awarding damages or remedies in excess of those allowed by the provisions of this Agreement. The decision and award of the arbitrator shall be final and binding and judgment on the award so rendered may be entered in any court having jurisdiction thereof. The arbitration shall be held in Santa Clara County, California, or a mutually convenient location, and the award shall be deemed to be made in California.

12.9 **Survival.** Sections 4 (“Charges and Billing Practices”), 5.3 (“Additional Charges”), 8 (“Disclaimer of Service Warranties”), 9 (“Limitation Of Liability For The Service”), 11.4 (“Indemnification”), and 12 (“General”) shall survive the expiration or termination of this Agreement.

Limited warranty

HARDWARE: Palm Computing, Inc., a subsidiary of 3Com Corporation (collectively “3Com”), warrants to the original end user (“Customer”) that this product will be free from defects in workmanship and materials, under normal use, for one year from the date of original purchase from 3Com or its authorized reseller. 3Com’s sole obligation under this express warranty shall be, at 3Com’s option and expense, to replace the product or part with a comparable product or part, repair the product or part, or if neither repair nor replacement is reasonably available, 3Com may, in its sole discretion, refund to Customer the purchase price paid for the product or part. Replacement products or parts may be new or reconditioned. 3Com warrants any replaced or repaired product or part, and any hardware upgrade to which Customer is entitled under an agreement between Customer and 3Com, for a period of ninety (90) days from shipment, or through the end of the original warranty, whichever is longer. All products or parts that are replaced become the property of 3Com.

Accessory products, as listed in the applicable 3Com catalogue, are not covered under this Limited Warranty except for the modem for the connected organizer, the cradles, cables, memory upgrades, and leather items sold under the 3Com® brand. 3Com shall not be responsible for Customer’s software, firmware, information, or memory data contained in, stored on, or integrated with any products returned to 3Com for repair, whether under warranty or not.

SOFTWARE: 3Com warrants to Customer that the Palm™ Desktop organizer software and Palm OS™ software licensed from it will perform in substantial conformance to their program specifications, for a period of ninety (90) days from the date of original purchase from 3Com or its authorized reseller. 3Com warrants the media containing software against failure during the warranty period. No updates are provided. 3Com does not provide any warranty for Adobe® Acrobat® Reader or any other third-party applications software that is licensed to Customer by the third party. 3Com’s sole obligation with respect to this express warranty shall be (at 3Com’s discretion) to refund the

purchase price paid by Customer for any defective software product, or to replace any defective media with software which substantially conforms to applicable 3Com published specifications. 3Com makes no warranty or representation that its software products will meet Customer's requirements or will work in combination with any hardware or applications software products provided by third parties, that the operation of the software products will be uninterrupted or error free, or that all defects in the software products will be corrected.

YEAR 2000 WARRANTY: In addition to the Hardware Warranty and Software Warranty stated above, 3Com warrants that the following date-data sensitive Palm Computing® products, namely the Pilot 1000, Pilot 5000, PalmPilot™ Personal Edition, PalmPilot Professional Edition, Palm III™, and Palm VII™ connected organizers, as well as all other 3Com products based on the Palm Computing platform software as of July 1, 1998 and later, including the companion desktop software for Microsoft® Windows® and MAC OS™ platforms, will continue performing properly with regard to such date-data on and after January 1, 2000, provided that all other products used by Customer in connection or combination with the Palm Computing product, including hardware, software, and firmware, accurately exchange date-data with the Palm Computing product. 3Com makes no certification regarding the Year 2000 status of any other Palm Computing products.

Any Palm Computing platform application supplied by 3Com that makes correct use of Palm Computing platform date and time functions will not have a problem transitioning to the year 2000. The date and time utilities for the Palm Computing platform use 32 bits to store seconds, starting at January 1, 1904. This approach allows the correct representation of dates up to 6:28:15 A.M. on February 6, 2040. Provided the product is still being sold by 3Com, 3Com will make software enhancements to remove this limitation to the Palm Computing platform well in advance of this date.

If it appears that any Palm Computing product does not perform properly with regard to such date-data on and after January 1, 2000, and Customer notifies Palm Computing before the later of April 1, 2000, or ninety (90) days after original purchase of the product from 3Com or its authorized reseller, 3Com shall, at its option and expense, provide a software update which would effect the proper performance of the product, repair the product, deliver to Customer an equivalent product to replace the product, or, if none of the foregoing is feasible, refund to Customer the purchase price paid for the product.

Any software update or replaced or repaired Palm Computing product will carry a Year 2000 Limited Warranty for ninety (90) days after purchase or until April 1, 2000, whichever is later.

Customers using date and time utilities other than those supplied by Palm Computing should check with the developer to determine if the software will correctly handle all of the subtle issues of date and time conversion.

OBTAINING WARRANTY SERVICE: Customer must contact a Palm Computing, Inc. or 3Com Technical Support or Customer Service center within the applicable warranty period to obtain warranty service authorization. Dated proof of original purchase from 3Com or its authorized reseller will be required. 3Com is not responsible for Customer products or parts received without a warranty service authorization. In the United States, 3Com may ship a replacement product or part prior to receiving the original

product or part ("advance exchange"). If advance exchange is not available, then the repaired product or part will be shipped as soon as reasonably possible, which will be no later than thirty (30) days after 3Com receives the original product or part. Repaired or replacement products will be shipped to Customer at 3Com's expense. The repair and replacement process for products or parts in locations outside of the United States will vary depending on Customer's location.

Products or parts shipped by Customer to 3Com must be sent prepaid and packaged appropriately for safe shipment, and it is recommended that they be insured or sent by a method that provides for tracking of the package. When an advance exchange is provided and Customer fails to return the original product or part to 3Com within thirty (30) days from the date the warranty service authorization is issued, 3Com will charge Customer the then-current published catalogue price of such product or part.

WARRANTIES EXCLUSIVE: IF THIS PRODUCT DOES NOT OPERATE AS WARRANTED ABOVE, CUSTOMER'S SOLE REMEDY FOR BREACH OF THAT WARRANTY SHALL BE REPLACEMENT OR REPAIR OF THE PRODUCT OR PART OR REFUND OF THE PURCHASE PRICE PAID, AT 3COM'S OPTION. TO THE FULL EXTENT ALLOWED BY LAW, THE FOREGOING WARRANTIES AND REMEDIES ARE EXCLUSIVE AND ARE IN LIEU OF ALL OTHER WARRANTIES, TERMS, OR CONDITIONS, EXPRESS OR IMPLIED, EITHER IN FACT OR BY OPERATION OF LAW, STATUTORY OR OTHERWISE, INCLUDING WARRANTIES, TERMS, OR CONDITIONS OF MERCHANTABILITY, FITNESS FOR A PARTICULAR PURPOSE, SATISFACTORY QUALITY, CORRESPONDENCE WITH DESCRIPTION, AND NON-INFRINGEMENT, ALL OF WHICH ARE EXPRESSLY DISCLAIMED. 3COM NEITHER ASSUMES NOR AUTHORIZES ANY OTHER PERSON TO ASSUME FOR IT ANY OTHER LIABILITY IN CONNECTION WITH THE SALE, INSTALLATION, MAINTENANCE OR USE OF ITS PRODUCTS.

3COM SHALL NOT BE LIABLE UNDER THIS WARRANTY IF ITS TESTING AND EXAMINATION DISCLOSE THAT THE ALLEGED DEFECT OR MALFUNCTION IN THE PRODUCT DOES NOT EXIST OR WAS CAUSED BY CUSTOMER'S OR ANY THIRD PERSON'S MISUSE, NEGLIGENCE, IMPROPER INSTALLATION OR TESTING, UNAUTHORIZED ATTEMPTS TO OPEN, REPAIR, OR MODIFY THE PRODUCT, OR ANY OTHER CAUSE BEYOND THE RANGE OF THE INTENDED USE, OR BY ACCIDENT, FIRE, LIGHTNING, OTHER HAZARDS, OR ACTS OF GOD. THIS WARRANTY DOES NOT COVER PHYSICAL DAMAGE TO THE SURFACE OF THE PRODUCT, INCLUDING CRACKS OR SCRATCHES ON THE LCD TOUCHSCREEN OR OUTSIDE CASING. THIS WARRANTY DOES NOT APPLY WHEN THE MALFUNCTION RESULTS FROM THE USE OF THIS PRODUCT IN CONJUNCTION WITH ACCESSORIES, OTHER PRODUCTS, OR ANCILLARY OR PERIPHERAL EQUIPMENT AND 3COM DETERMINES THAT THERE IS NO FAULT WITH THE PRODUCT ITSELF. THIS WARRANTY DOES NOT APPLY TO ANY MALFUNCTION OR FAILURE OF THE PRODUCT OR PART DUE TO ANY COMMUNICATION SERVICE CUSTOMER MAY SUBSCRIBE TO OR USE WITH THE PRODUCT.

LIMITATION OF LIABILITY: TO THE FULL EXTENT ALLOWED BY LAW, 3Com ALSO EXCLUDES FOR ITSELF AND ITS SUPPLIERS ANY LIABILITY, WHETHER BASED IN CONTRACT OR TORT (INCLUDING NEGLIGENCE), FOR INCIDENTAL, CONSEQUENTIAL, INDIRECT, SPECIAL, OR PUNITIVE DAMAGES OF ANY KIND, OR FOR LOSS OF REVENUE OR PROFITS, LOSS OF BUSINESS, LOSS OF INFORMA-

TION OR DATA, OR OTHER FINANCIAL LOSS ARISING OUT OF OR IN CONNECTION WITH THE SALE, INSTALLATION, MAINTENANCE, USE, PERFORMANCE, FAILURE, OR INTERRUPTION OF THIS PRODUCT, EVEN IF 3COM OR ITS AUTHORIZED RESELLER HAS BEEN ADVISED OF THE POSSIBILITY OF SUCH DAMAGES, AND LIMITS ITS LIABILITY TO REPLACEMENT, REPAIR, OR REFUND OF THE PURCHASE PRICE PAID, AT 3COM'S OPTION. THIS DISCLAIMER OF LIABILITY FOR DAMAGES WILL NOT BE AFFECTED IF ANY REMEDY PROVIDED HEREIN SHALL FAIL OF ITS ESSENTIAL PURPOSE.

DISCLAIMER: Some countries, states, or provinces do not allow the exclusion or limitation of implied warranties or the limitation of incidental or consequential damages for certain products supplied to consumers, or the limitation of liability for personal injury, so the above limitations and exclusions may be limited in their application to you. When the implied warranties are not allowed to be excluded in their entirety, they will be limited to the duration of the applicable written warranty. This warranty gives you specific legal rights which may vary depending on local law.

GOVERNING LAW: This Limited Warranty shall be governed by the laws of the State of California, U.S.A. excluding its conflicts of laws principles and excluding the United Nations Convention on Contracts for the International Sale of Goods.

Palm Computing, Inc., a subsidiary of 3Com Corporation
5400 Bayfront Plaza
PO Box 58007
Santa Clara, California 95052-8007
(408) 326-5000
12/02/98

3Com end user software license agreement

YOU SHOULD CAREFULLY READ THE FOLLOWING TERMS AND CONDITIONS BEFORE USING THIS PRODUCT. IT CONTAINS SOFTWARE, THE USE OF WHICH IS LICENSED BY PALM COMPUTING, INC., A SUBSIDIARY OF 3COM CORPORATION (COLLECTIVELY, "3COM"), TO ITS CUSTOMERS FOR THEIR USE ONLY AS SET FORTH BELOW. IF YOU DO NOT AGREE TO THE TERMS AND CONDITIONS OF THIS AGREEMENT, DO NOT USE THE SOFTWARE. USING ANY PART OF THE SOFTWARE INDICATES THAT YOU ACCEPT THESE TERMS.

LICENSE: 3Com grants you a nonexclusive license to use the accompanying software program(s) (the "Software") subject to the terms and restrictions set forth in this License Agreement. You are not permitted to lease or rent (except under separate mutually agreeable terms set forth in writing), distribute or sublicense the Software or to use the Software in a time-sharing arrangement or in any other unauthorized manner. Further, no license is granted to you in the human readable code of the Software (source code). Except as provided below, this License Agreement does not grant you any rights to patents, copyrights, trade secrets, trademarks, or any other rights in respect to the Software.

The Software is licensed to be used on any personal computer and/or any 3Com product, provided that the Software is used only in connection with 3Com products. With respect to the Desktop Software, you may reproduce and provide one (1) copy of such

Software for each personal computer or 3Com product on which such Software is used as permitted hereunder. With respect to the Device Software, you may use such Software only on one (1) 3Com product. Otherwise, the Software and supporting documentation may be copied only as essential for backup or archive purposes in support of your use of the Software as permitted hereunder. You must reproduce and include all copyright notices and any other proprietary rights notices appearing on the Software on any copies that you make.

Notwithstanding any other provision of this License Agreement, this License Agreement shall not be deemed to apply to the Adobe® Acrobat® Reader software or any other applications software licensed to you by third parties that is included on the same media as 3Com's Software ("Other Software") if the Other Software provides that the use of the Other Software is subject to the terms and conditions of the third party's license agreement.

NO ASSIGNMENT; NO REVERSE ENGINEERING: You may transfer the Software and this License Agreement to another party if the other party agrees in writing to accept the terms and conditions of this License Agreement. If you transfer the Software, you must at the same time either transfer all copies of the Software as well as the supporting documentation to the same party or destroy any such materials not transferred. Except as set forth above, you may not transfer or assign the Software or your rights under this License Agreement.

Modification, reverse engineering, reverse compiling, or disassembly of the Software is expressly prohibited. However, if you are a European Community ("EC") resident, information necessary to achieve interoperability of the Software with other programs within the meaning of the EC Directive on the Legal Protection of Computer Programs is available to you from 3Com upon written request.

EXPORT RESTRICTIONS: You agree that you will not export or re-export the Software or accompanying documentation (or any copies thereof) or any products utilizing the Software or such documentation in violation of any applicable laws or regulations of the United States or the country in which you obtained them.

The software covered by this agreement may contain strong data encryption code which cannot be exported outside of the U.S. or Canada. You agree that you will not export/reexport, either physically or electronically, the encryption software or accompanying documentation without obtaining written authorization from the U.S. Department of Commerce.

TRADE SECRETS; TITLE: You acknowledge and agree that the structure, sequence and organization of the Software are the valuable trade secrets of 3Com and its suppliers. You agree to hold such trade secrets in confidence. You further acknowledge and agree that ownership of, and title to, the Software and all subsequent copies thereof regardless of the form or media are held by 3Com and its suppliers.

UNITED STATES GOVERNMENT LEGEND: The Software is commercial in nature and developed solely at private expense. The Software is delivered as "Commercial Computer Software" as defined in DFARS 252.227-7014 (June 1995) or as a commercial item as defined in FAR 2.101(a) and as such is provided with only such rights as are provided in this License Agreement, which is 3Com's standard commercial license for the

Software. Technical data is provided with limited rights only as provided in DFAR 252.227-7015 (Nov. 1995) or FAR 52.227-14 (June 1987), whichever is applicable.

TERM AND TERMINATION: This License Agreement is effective until terminated. You may terminate it at any time by destroying the Software and documentation together with all copies and merged portions in any form. It will also terminate immediately if you fail to comply with any term or condition of this License Agreement. Upon such termination you agree to destroy the Software and documentation, together with all copies and merged portions in any form.

GOVERNING LAW: This License Agreement shall be governed by the laws of the State of California as such laws are applied to agreements entered into and to be performed entirely within California between California residents and by the laws of the United States. You agree that the United Nations Convention on Contracts for the International Sale of Goods (1980) is hereby excluded in its entirety from application to this License Agreement.

LIMITED WARRANTY; LIMITATION OF LIABILITY: All warranties and limitations of liability applicable to the Software are as stated on the Limited Warranty Card or in the product manual accompanying the Software. Such warranties and limitations of liability are incorporated herein in their entirety by this reference.

SEVERABILITY: In the event any provision of this License Agreement is found to be invalid, illegal or unenforceable, the validity, legality and enforceability of any of the remaining provisions shall not in any way be affected or impaired and a valid, legal and enforceable provision of similar intent and economic impact shall be substituted therefor.

ENTIRE AGREEMENT: This License Agreement sets forth the entire understanding and agreement between you and 3Com, supersedes all prior agreements, whether written or oral, with respect to the Software, and may be amended only in a writing signed by both parties.

Palm Computing, Inc., a subsidiary of 3Com Corporation
5400 Bayfront Plaza
PO Box 58007
Santa Clara, California 95052-8007
(408) 326-5000
9/03/98

FCC Statement

This device complies with part 15 of the FCC rules. Operation is subject to the condition that this device may not cause harmful interference.

Note: This equipment has been tested and found to comply with the limits for a Class B digital device, pursuant to Part 15 of the FCC rules. These limits are designed to provide reasonable protection against harmful interference in a residential installation. This equipment generates, uses, and can radiate radio frequency energy and, if not installed and used in accordance with the instructions, may cause harmful interference to radio communications. However, there is no guarantee that interference will not occur in a particular installation. If this equipment does cause harmful interference to radio or television reception, which can be determined by turning the equipment off and on, the user is encouraged to try to correct the interference by one or more of the following measures:

- Reorient or relocate the receiving antenna.
- Increase the separation between the equipment and receiver.
- Connect the equipment into an outlet on a circuit different from that to which the receiver is connected.
- Consult the dealer or an experienced radio/TV technician for help.

The use of shielded I/O cables is required when connecting this equipment to any and all optional peripheral or host devices. Failure to do so may violate FCC rules.

Caution: Changes or modifications not covered in this manual must be approved in writing by the manufacturer's Regulatory Engineering Department. Changes or modifications made without written approval may void the user's authority to operate this equipment.

Canadian RFI Statement

This Class B digital apparatus meets all requirements of the Canadian Interference-Causing Equipment Regulations.

Cet appareil numérique de la classe B respecte toutes les exigences du Règlement sur le matériel brouilleur du Canada.

Index

A

AAA batteries. *See* Batteries

ABA (Address Book archive file) 42

Accented characters

 Graffiti writing 38

 onscreen keyboard 41

Account on Palm.Net service 126

Activating the Palm.Net service 15,
125

Add-on applications 48–51, 236

Address Book

 If Found Call entry 97

 adding custom fields 100

 archive files (.aba) 42

 business card for beaming 187

 categorizing records 70

 conduit for synchronizing 192

 creating records 63, 96–97

 deleting records 65

 displaying category 99

 displaying data in the Address
 List 98

 finding records 73–74

 fonts 81

 menus 98

 notes for records 80–81

 opening 59

 overview 59

 pressing button to beam
 information 188

 private records 80

 sorting records 78

Address on Palm.Net network 124

Airline regulations on use of wireless
devices 121

Alarm

 preset 95

 setting 87

 sound 95, 209, 240

 for untimed events 88

Alphabet

 Graffiti writing 34

 onscreen keyboard 19, 25

Antenna

 best positions 6, 130, 242

 location 5

 pen stroke to open
 application 205

 proper use 121, 233

 replacing 233–235

Application buttons 5, 20

 for beaming 188

 for cycling through views 58, 59,
 60, 61

 reassigning 204

Applications

 Address Book 59

 beaming 187–188

 Calculator 61

 categories 45–46

 Date Book 58

 Expense 62

 font style 82

 iMessenger 138

 installing 48–51

 Memo Pad 61

 opening 21

 preferences for 47

 problems with 243

 query applications 128

 removing 51

 security 53

 size in kilobytes 250

 third-party 250

 To Do List 60

 version of 250

 viewing as icons 46

 viewing as list 46

See also Add-on applications

Applications Launcher 20–21, 45–47

Archive files

 importing data from 42

 for main applications 42

 saving deleted records 65

 saving purged records 66

Arrows 20

Attachments

 iMessenger application 145, 157

 Mail 181

Automatic fill, in Expense 119
Auto-off delay 209
Autotext. *See* Graffiti ShortCuts

B

Backlight 6, 206
Bar graph showing signal strength 128
Batteries

- backup power when removed 230
- battery door 7, 9
- battery life 230
- conserving power 209
- gauge 21
- installing 9, 10
- See also* Transmitter

BCC (blind carbon copy) 158, 172
Beaming information 187–188

- location of IR port 6
- pen stroke to activate 206
- problems with 248

Billing 126, 131, 267
Bold font for text 81
Brightness control 7
Business card for beaming 187
Buttons preferences 204

C

Calculator

- buttons explained 109
- memory 109
- opening 62
- overview 61
- recent calculations 62, 109

Calibration 18, 207, 241
Call Waiting, disabling 196, 216
Calling card, using in phone settings 196, 216
Capital letters (Graffiti writing) 35
Caring for the organizer 229
Categories

- application 45–46
- assigning records to 69–70
- beaming 187–188
- creating 71–72

default 70
displaying 71, 99, 243
folders for e-mail 178
folders for iMessenger messages 156
merging 73
renaming 72
using in Applications Launcher 46
cc:Mail 164
Certicom 125
Chain calculations 109
Characters, Graffiti 31
Charging the transmitter 10
Check boxes 19
Check marks to mark read items e-mail (Mail) 166
messages (iMessenger application) 140
Clearing Calculator entries 109
Clippings

- response to query 129
- reviewing 132–135
- saving information from 135–136
- size of 134

COM port. *See* Serial port
Combining categories 73
Comma delimited files, importing data from 42
Command buttons 19, 125, 131
Command equivalents (Graffiti writing) 24
Compressing Day view 94
Computer keyboard, entering data with 27
Conduits

- for connecting to PIMs 14
- for modem HotSync operations 196
- for synchronizing applications 244, 192–193, 236–237

Confirming e-mail 174
Conflicting events 91
Connecting to Internet 130, 139

- service templates 217
 - to server or ISP 217
 - Continuous events
 - deleting from Date Book 65
 - scheduling 88
 - Contrast control 7
 - Copy Page command in query applications 136
 - Copying text 64
 - Country default setting 207
 - Coverage of Palm.Net service 125, 126
 - Cradle
 - connecting to serial port 8
 - for local HotSync operations 68
 - Creating
 - Address Book entries 96–97
 - categories 45–46, 71–72
 - currency symbols 114
 - custom fields in Address Book 100
 - Date Book events 83
 - e-mail in Mail 167–169
 - Expense items 111
 - expense reports in Excel 115–118
 - memos 106
 - messages in iMessenger application 146–149
 - notes for records 80
 - queries to submit to
 - Internet 130–132
 - records 63
 - To Do List items 101
 - Currency
 - default 119
 - defining 114
 - for Expense items 113
 - Current date 30, 243
 - Current time 21
 - displaying in Date Book 90
 - setting 29
 - Custom currencies and symbols 114
 - Custom expense reports 251–261
 - Custom fields in Address Book 100
 - Customer support 125, 126, 239, 250
 - Customizing. *See* Preferences
 - Cutting text 64
 - Cycling through views 58, 59, 60, 61
- ## D
- Data entry. *See* Entering data
 - Date Book
 - adding Address Book data to records 75–76
 - alarm 87
 - archive files (.dba) 42
 - changing event time 87
 - changing event to untimed 86
 - conduit for synchronizing 192
 - conflicting events 91
 - continuous events 88–89
 - creating records 63, 83–87
 - Day view 89
 - deleting records 65
 - display options 94
 - end time for Day view 95
 - fonts 81
 - menus 93
 - Month view 92
 - notes for records 80–81
 - opening 58
 - overview 58
 - private records 80
 - purging records 66
 - repeating events 65, 88–89
 - scheduling events 83–87
 - selecting dates 85
 - start time for Day view 95
 - Sunday or Monday to start week 208
 - switching views 89
 - untimed events 83, 86
 - Week view 90, 208, 243
 - Dates
 - Expense item 112
 - setting current 30, 243
 - showing in iMessenger list 156
 - showing in Mail list 179
 - To Do List record due 103
 - Year 2000 warranty 274
 - Day (Date Book view) 83, 94
 - DBA (Date Book archive file) 42
 - Decimal point 208

- Default
 - categories 70
 - currency in Expense 119
 - proxy server 227
 - settings. *See* Preferences
- Deleted
 - data, saving in archive files 65
 - e-mail, recovering 177
 - iMessage messages, recovering 155
- Deleting
 - applications 48, 51
 - Desktop software 52
 - e-mail 177
 - Graffiti characters 33
 - iMessage messages 155
 - iMessage messages from network 158
 - passwords 54
 - records 65
 - service templates 222
 - text 64
 - See also* Purging records
- Delivering
 - e-mail (Mail) 171, 174
 - messages (iMessage application) 151
- Desktop E-Mail application
 - applications supported 164
 - managing 163–186
 - support of Mail features 171
- Desktop software 12–13
 - configuring mail 164–166
 - for entering data 27
 - linking to external files 200
 - removing 52
 - saving deleted data to an archive file 65
 - system requirements 4
 - upgrading 10
 - See also* PIM
- Diagnostics application
 - monitoring signal strength 128, 242
 - monitoring transmitter charge 231
- Digitizer 18, 207, 241
- Distribution lists in iMessage
 - application 145
- DNS (Domain Naming System) 219
- Double-booked events 91
- Downloading iMessage
 - messages 140–145
- Drafts
 - in iMessage application 153
 - in Mail 175
- Dragging
 - memos into other applications 61
 - stylus to activate features 205
 - using the stylus 18
- E**
- Editing
 - records 63–65
 - unsent e-mail (Mail) 174
 - unsent messages (iMessage application) 152
- Elliptic curve cryptography 125
- E-mail addresses
 - in Address Book 97, 98
 - looking up (iMessage application) 149–150
 - looking up (Mail) 170–171
- E-mail items. *See* Mail
- Encryption 125
- Entering data 25–28
 - importing from other applications 42–43
 - problems with 241
 - using Graffiti writing 31–40
 - using the computer keyboard 41
 - using the onscreen keyboard 41
- Entries. *See* Address Book
- Eudora 164
- Events. *See* Date Book
- Excel, transferring Expense data to 115–118
- Exchange 164
- Exchanging data. *See* HotSync
- Exclamation marks in To Do List 104
- Expense
 - adding Address Book data to records 76–77

- categorizing records 70
- conduit for synchronizing 192
- creating records 63, 111
- currency 113, 119
- date of item 112
- defining new currency 114
- deleting records 65
 - menus 118
- notes for records 80–81
- opening 62
- overview 62
- purging records 66
- receipt details 112
- reports in Excel 115–118, 251–261
- sorting records 78
- templates for reports 117
- type 113, 119
- vendor 113

F

- FAQ 239–250
- FCC Statement 279
- Federal Aviation Administration (FAA) guidelines on using wireless devices 121
- Files, linking to external 200
- Filing
 - e-mail (Mail) 176
 - messages (iMessenger application) 154
- Filters for e-mail 181–184
- Finding
 - applications, using Graffiti
 - writing 21
 - e-mail addresses (iMessenger application) 149–150
 - e-mail addresses (Mail) 170–171
 - information in
 - applications 73–77
 - phone numbers 75–76
 - using the Find application 74
- Folders
 - for e-mail (Mail) 178
 - for messages (iMessenger application) 156
- Fonts 81, 82

- Formats preferences 207
- Frequently asked questions 239–250
- Frozen organizer 240

G

- Games 50, 210
- General preferences
 - alarm sounds 209
 - auto-off delay 209
 - system sounds 209
- Getting more of truncated messages 143–144
- Glossary. *See* Graffiti ShortCuts
- Graffiti
 - accented characters 38
 - alphabet 31, 34
 - basic concepts 31
 - capital letters 35
 - Command stroke 24, 151
 - defined 26
 - Giraffe game for practicing 51
 - how to write characters 32
 - menu commands 24
 - moving the cursor 39
 - numbers 35
 - online Help 65, 205
 - problems using 241
 - punctuation marks 36
 - ShortCuts for entering data 39, 225–226
 - symbols 37
 - tips 33
 - writing 31–40
 - writing area 5, 32

H

- Hard reset 236
 - effect on iMessenger application 159
 - after upgrading 12
- Header information
 - in iMessenger application 144, 148
 - in Mail 167, 169
- Help
 - Graffiti 65

- online Tips 24
- Hiding records 79
- High Priority e-mail filter 184
- History, list of clippings 135
- HotSync
 - buttons preferences 206
 - conduits for synchronizing
 - applications 192–193, 236–237
 - customizing 192
 - defined 67
 - first-time operation 67–69, 200–202
 - for managing desktop
 - E-Mail 165–166
 - HotSync Manager 67
 - and iMessenger application 159
 - linking to external files 200
 - local operation 68, 190, 245
 - modem operation 190, 194–197, 246–247
 - modem settings 195
 - network operation 198
 - options for filtering
 - e-mail 180–184
 - problems with 244–247
 - before replacing batteries 230
 - setting options 189–191
 - for synchronizing data 12
 - using with another PIM 52

I

Icons

- alarm 87
- application 19, 46
- in iMessenger application 140, 160
- note 80
- online Tips 24
- onscreen 241
- over-the-air 131
- for query applications 129
- repeating event 89
- security (for wireless transactions) 125
- Idle timeout of ISP or server connection 219

- Ignoring e-mail. *See* Filters for e-mail
- iMessenger application
 - address 124, 227
 - address lookup 149–150
 - attachments 145
 - canceling transactions 140
 - checking for messages 140–141
 - closing messages 141
 - copy of outgoing messages 158
 - creating messages 146–149
 - deleting messages 155, 158
 - different from Mail 138
 - draft messages 153
 - editing unsent messages 152
 - filing messages 154
 - folders 156
 - fonts 81
 - forwarding address 158
 - icons in 140
 - log of wireless transaction 141
 - long messages 141–144
 - mailbox on network 157
 - menus 159
 - opening messages 141–145
 - opening upon raising
 - antenna 205
 - overview 17, 124, 138
 - purging deleted messages 155
 - recovering deleted messages 155
 - replying to messages 148
 - rerouting replies 150
 - sending messages 146–149, 151–152
 - short messages 141
 - showing dates 156
 - signature 151
 - sorting messages 157
 - synchronizing after hard
 - reset 159
 - undeliverable messages 157
 - viewing messages 140–145
- Importing data 28, 42–43
- Inbox
 - iMessenger application 156
 - Mail 178
- Infrared port. *See* IR port

Installing
 applications 48–51
 batteries 9
 conduit to install
 applications 192
 Desktop software 13, 239
 Mail. *See* Mail, desktop
 configuration
InSync Online 126
Interface elements 19
International characters
 Graffiti writing 38
 onscreen keyboard 41
Internet. *See* iMessenger application
 and Query applications
IP address
 for Network preferences 220
 for Palm.Net proxy server 227
 for service template 218
IR port 6
 See also Beaming information
Items. *See* To Do List or Expense

K

Keyboard
 computer 41
 onscreen 19, 41, 206
Kilobytes (KB) 131, 134, 136

L

Letters
 font style 82
 Graffiti 31, 34
 onscreen keyboard 41
List, in Applications Launcher 46
Locking the organizer with a
 password 54–55, 206, 224
Log of iMessenger transactions 141
Login scripts 221, 263
Looking up Address Book data
 to add to other records 75–76
 scrolling in Address List 73
 to add to e-mail (Mail) 170–171
 to add to messages (iMessenger
 application) 149–150
Lost organizer, contact for 97

Lost records 243
Lotus
 1-2-3, for expense reports 260
 cc:Mail 164
 Organizer, importing data
 from 42

M

Macintosh compatibility 4, 159
Mail
 address lookup 170–171
 attachments 181
 BCC (blind carbon copy) 171,
 172
 changing setup 166
 closing e-mail 167
 confirm delivery 171, 174
 confirm read 171, 174
 creating e-mail 167–169
 deleting e-mail 177
 desktop configuration 164–166
 different from iMessenger
 application 138
 draft e-mail 175
 editing unsent e-mail 174
 filing e-mail 176
 filtering options 180–184
 folders 178
 fonts 81
 HotSync options 165–166
 menus 185
 opening e-mail 166
 overview 163–164
 priority of delivery 171, 172
 purging deleted e-mail 178
 recovering deleted e-mail 177
 replying to e-mail 169
 sending 174
 showing dates 179
 signature 171, 173–174
 sorting e-mail 179
 synchronizing 166
 truncating e-mail 185
 viewing e-mail 166
Mailbox on Palm.Net network 157
Main applications 20
Maintenance information 229

- MapQuest 123
 - Maps of Palm.Net coverage 126
 - Memo Pad
 - adding Address Book data to records 75–76
 - archive files (.mpa) 42
 - categorizing records 69
 - conduit for synchronizing 192
 - creating records 63, 106
 - deleting records 65
 - dragging memos into other applications 61
 - fonts 81
 - menus 107, 110
 - opening 61
 - overview 61
 - private records 80
 - reviewing memos 106
 - sorting records 78, 243
 - Memory
 - amount of free 250
 - for beaming 248
 - Calculator 109
 - regaining 66, 240
 - Memos. *See* Memo Pad
 - Menus 23–24, 241
 - Address Book 98
 - choosing 23
 - command equivalents (Graffiti writing) 24
 - Date Book 93
 - Edit menu 64–65
 - Expense 118
 - iMessenger application 159
 - Mail 185
 - Memo Pad 107, 110
 - menu bar 19, 23
 - Network Preferences 222
 - pop-up (iMessenger application) 160
 - query applications 137
 - To Do List 105
 - Messages. *See* iMessenger application
 - Microsoft
 - Excel, transferring Expense data to 115–118
 - Exchange 164
 - Outlook, connecting to 14, 164, 244
 - Windows Messaging 4.0 164
 - Modem
 - HotSync operations via 194–197, 246–247
 - preferences 211
 - Monday, to start week 208
 - Month (Date Book view) 92, 94
 - Moving the cursor (Graffiti writing) 39
 - MPA (Memo Pad archive file) 42
- ## N
- Network
 - connecting 217
 - connection type 218
 - idle timeout 219
 - login scripts 221
 - Palm.Net service 125
 - password 214
 - phone settings 214
 - preferences 212–223
 - primary DNS 219
 - secondary DNS 219
 - selecting service 212
 - TCP/IP 212
 - user name 213
 - Network HotSync operation 198
 - NiCad (nickel-cadmium)
 - battery 231–232
 - Notes, attaching to records 80–81
 - Numbers
 - decimal point and thousands separator 208
 - Graffiti writing 35
 - onscreen keyboard 19, 25, 41
- ## O
- 1-2-3, for expense reports 260
 - Onscreen keyboard 25, 41, 65
 - pen stroke to open 206
 - Opening
 - Address Book 59
 - applications 20–21
 - Calculator 62

- Date Book 58
 - Expense 62
 - iMessenger application 139
 - Mail 166
 - Memo Pad 61
 - query applications 129–130
 - To Do List 60
 - Organizer
 - interface elements 19
 - locking 54–55
 - problems with 239–250
 - setting up 10
 - turning on and off 6
 - unique name 12
 - Organizer (Lotus PIM) 42
 - Outbox
 - iMessenger application 152, 156
 - Mail 174, 178
 - Outlook, connecting to 14, 164, 244
 - Overlapping events 91
 - Owner preferences 224
- P**
- Palm Desktop software. *See* Desktop software
 - Palm.Net service
 - account status 126
 - activating 15
 - mailbox on 157
 - maps of coverage 126
 - network 125
 - overview 14, 124
 - password 15
 - protection of wireless transactions 125
 - query application 127
 - service agreement 265
 - signal strength 127
 - support information 126
 - username 16
 - web site 126
 - Passwords 53–55
 - changing 54
 - creating 53
 - deleting 54
 - for network 214
 - forgotten 55, 249
 - for Palm.Net service 15, 16, 242
 - Pasting text 64
 - Payment, Expense item 113
 - PDB (add-on application file extension) 49
 - Pen stroke, full-screen 205–206
 - Personal information managers. *See* PIM
 - Phone Lookup 75–76
 - Phone numbers
 - selecting for Address List 98
 - selecting types 97
 - Phone settings for ISP or dial-in server 214–217
 - Pick lists 20, 131
 - PIM (personal information manager)
 - in upgrading process 10
 - using HotSync Manager with 52
 - using with organizer 14
 - Pop-up menus (iMessenger application) 160
 - Power button 6
 - PPP 218
 - PQA (query application file extension) 49
 - PRC (add-on application file extension) 49
 - Preferences 29
 - Buttons 204
 - choosing 47
 - Digitizer 207
 - Formats 207
 - General 209
 - HotSync buttons 206
 - Modem 211
 - Network 212–223
 - Owner 224
 - ShortCuts 225
 - Wireless 227
 - Primary DNS 219
 - Printing
 - expense reports from
 - Excel 115–118
 - records from applications 12
 - Prioritizing To Do List records 101, 104
 - Priority of delivery (Mail) 172

Private records
 displaying and creating 79–80,
 243
 lost with forgotten password 55
 See also Security
Problems with organizer 239–250
Profiles 200
Proxy server for Palm.Net service 227
Punctuation marks
 Graffiti writing 36
 onscreen keyboard 41
Purging
 deleted e-mail (Mail) 178
 deleted messages (iMessenger
 application) 155
 records 66
 See also Deleting

Q

QUALCOMM 164
Quattro Pro, for expense reports 260
Query applications
 downloading new 123, 126
 example 133–134
 going back through pages 132
 menus 137
 overview 16, 122, 128
 for Palm.Net service 127
 preferred application to
 open 205
 preventing transmission of
 location and ID 228
 reviewing clippings 135
 saving information
 from 135–136
 sending messages from 136
 stopping transactions 132
 submitting queries 131

R

Radio signal 121, 127, 242
Range of times in Day view 95
Reading e-mail on organizer 166
Receipts, recording in Expense 112
Receiving data. *See* Beaming
 information

Reception 127, 242
Recharging the transmitter 231
Records
 Address Book 96
 beaming 187–188
 choosing categories 69
 creating 63
 Date Book 83
 defined 63
 deleting 65
 displaying a category of 71
 editing 63–65
 Expense 111
 fonts 81
 hiding private 53, 79
 lost 243
 Memo Pad 106
 notes for 80–81
 number of 250
 private 79–80
 purging 66
 sorting 77–78
 To Do List 101
Recovering
 deleted e-mail (Mail) 177
 deleted messages (iMessenger
 application) 155
 filed e-mail (Mail) 177
 filed messages (iMessenger
 application) 154
Recycling NiCad battery 232
Removing
 applications 51
 Desktop software 52
Renaming categories 72
Repeating events
 deleting from Date Book 65
 scheduling 88
Replacing antenna 233–235
Replying to mail
 in iMessenger application 148,
 150
 in Mail 169
 in query applications 136
Requirements 4
Rerouting replies to messages
 (iMessenger application) 150

- Rescheduling events 87
 - Resetting organizer
 - hard reset 236
 - location of reset button 7, 235
 - soft reset 235
 - tool for 235
 - Responses to queries. *See* Clippings
 - Retrieving e-mail. *See* Filters for e-mail
- ## S
- Saving
 - clippings 135–136
 - data 45, 63, 65
 - draft e-mail (Mail) 175
 - draft messages (iMessenger application) 153
 - Scheduling events 83–87
 - Screen
 - backlight 6
 - blank 240
 - calibrating 18, 207
 - caring for 229
 - touching with your finger 5
 - Scroll bar 20
 - Scroll button 6
 - Searching. *See* Finding
 - Secondary DNS 219
 - Security 53–55
 - changing password 54
 - deleting password 54
 - displaying owner's name 224
 - forgotten password 55
 - locking the organizer 54
 - preventing transmission of
 - location and ID 228
 - private records 79–80
 - of wireless transactions 125
 - Selecting
 - date for event 85
 - e-mail to be synchronized. *See* Filters for e-mail
 - phone numbers in Address Book 97
 - text 64
 - Sending
 - data. *See* Beaming information
 - e-mail (Mail) 167–169, 174
 - messages (iMessenger application) 146–149, 151–152
 - messages from query applications 136
 - queries to Internet 131
 - Separators between addresses 147, 168
 - Serial port 8, 190, 194
 - Service agreement, Palm.Net 265
 - Service templates 217, 222
 - Service, Palm.Net 124
 - Service, selecting for network 212
 - Setting up organizer 10
 - Settings. *See* Preferences
 - ShortCuts
 - backing up 192
 - managing 225–226
 - menu commands 24
 - predefined 40
 - using 39
 - Showing dates
 - in iMessenger list 156
 - in Mail list 179
 - Signal strength 127–128, 242
 - Signature
 - for e-mail (Mail) 173–174
 - for messages (iMessenger application) 151
 - Soft reset 235
 - Sorting
 - applications 46
 - e-mail (Mail) 179
 - messages (iMessenger application) 157
 - records 77–78, 243
 - Sounds. *See* Alarm and System sounds
 - Starting applications
 - basic applications 20–21
 - iMessenger application 139
 - query applications 130
 - Storing
 - e-mail (Mail) 174, 176
 - messages (iMessenger application) 152

- Stylus
 - dragging with 18
 - pen stroke to activate a feature 205
 - reset tool 235
 - tapping with 18
 - writing with 7, 31
 - Submitting queries to Internet 131
 - Sunday, to start week 208
 - Symbols
 - for currency 113
 - in Graffiti writing 37
 - See also* Icons
 - Synchronizing data. *See* HotSync
 - System conduit 192
 - System requirements for Desktop software 4
 - System sounds 209
- T**
- Tab delimited files, importing data from 42
 - Tapping 18, 241
 - TCP/IP 212, 223
 - TDA (To Do List archive file) 42
 - Technical Support 125, 126, 239, 250
 - Templates for expense reports 117
 - Text
 - copying 64
 - cutting 64
 - entry. *See* Entering data
 - fonts for 81
 - selecting all 64
 - Text files, importing data from 42
 - Thousands separator 208
 - Time
 - alarm setting 87
 - format 208
 - setting current 29
 - setting event 83
 - start and end for Date Book Day view 95
 - Time bars in Date Book 94
 - Tips, online 24
 - To Do List
 - adding Address Book data to records 75–76
 - archive files (.tda) 42
 - categorizing records 69, 104
 - checking off items 102
 - completed items 104
 - completion date 104
 - conduit for synchronizing 192
 - creating records 63, 101
 - deleting records 65
 - due date 103, 104
 - fonts 81
 - menus 105
 - notes for records 80–81
 - opening 60
 - overview 60
 - prioritizing records 101, 104
 - private records 80
 - problems with 243
 - purging records 66, 104
 - sorting records 78
 - Today. *See* Current date
 - Transferring data. *See* HotSync
 - Transmitter 10, 231
 - Transmitting data. *See* Beaming information
 - Troubleshooting 239–250
 - Truncated messages (iMessenger application) 143–144
 - Truncating e-mail (Mail) 185
 - Turning off organizer
 - automatically 209
 - pen stroke for 206
 - power button 6
 - problems with 240
 - Turning on organizer
 - application buttons 5
 - displaying owner's name 224
 - power button 6
 - problems with 240
 - 2000, Year 274
- U**
- Undeliverable iMessenger messages 157
 - Undoing actions 64
 - Uninstalling Desktop software 52
 - Unresponsive organizer 240
 - Unsent e-mail, editing 174

Unsent iMessenger messages,
editing 152
Untimed events 83, 86, 88
Updating data. *See* HotSync
Upgrading 10–12
User profiles 200
User-defined categories 70
Username
 identifying organizer 224
 for ISP 213
 for Palm.Net service 15, 16, 227
 unique for each organizer 11

V

Vendor for Expense item 113

W

Web clipping 137
 example 133–134
 overview 16, 121–123
 See also Query applications
Web sites 14, 125, 126

Week (Date Book view) 90–91, 208,
243
Windows Messaging (Microsoft) 164
Wireless communication service. *See*
Palm.Net service
Wireless features. *See* iMessenger
application *and* Query
applications
Wireless Internet messaging. *See*
iMessenger application
Wireless preferences 227
Writing area 5
Writing. *See* Entering data

X

XLT (Expense report template in
Excel) 117

Y

Yahoo! People Search 133
Year 2000 warranty 274

