



FCC PART 73G & BETS 6 LOW POWER FM BROADCAST STATIONS (LPFM) TEST REPORT

APPLICANT	BEI ELECTRONICS, LLC
	4100 N 24TH STREET P.O. BOX 3606 QUINCY, IL 62305
FCC ID	DDEETG500
IC	131A-ETG500
MODEL NUMBER	ETG500
PRODUCT DESCRIPTION	FM BROADCAST TRANSMITTER
DATE SAMPLE RECEIVED	12/31/2018
DATE TESTED	12/4/2019
TESTED BY	Tim Royer
APPROVED BY	Franklin Rose
TEST RESULTS	<input checked="" type="checkbox"/> PASS <input type="checkbox"/> FAIL

Report Number	Report Version	Description	Issue Date
212UT20 TestReport	---	Initial Issue	3/5/2020
	Rev1	Revised RF power output section	3/25/2020
	Rev2	Revised EUT power source	3/31/2020

THE ATTACHED REPORT SHALL NOT BE REPRODUCED EXCEPT IN FULL WITHOUT THE WRITTEN APPROVAL OF TIMCO ENGINEERING, INC.

This report relates only to the Equipment Under Test (EUT) sample(s) tested.

TABLE OF CONTENTS

GENERAL REMARKS	1
GENERAL INFORMATION	2
RESULTS SUMMARY	3
RF POWER OUTPUT	4
TEST DATA: RF OUTPUT POWER	5
OUTPUT POWER:	5
TEST DATA: POWER IN THE FINAL STAGE	5
MODULATION CHARACTERISTICS	6
AUDIO FREQUENCY RESPONSE.....	7
TEST DATA: AUDIO FREQUENCY RESPONSE PLOT.....	7
AUDIO INPUT VS MODULATION	8
TEST DATA: MODULATION LIMITING	9
OCCUPIED BANDWIDTH & EMISSION MASK.....	10
TEST DATA: OCCUPIED BANDWIDTH TABLE	11
20dB OCCUPIED BANDWIDTH PLOT LOW END OF BAND	11
20dB OCCUPIED BANDWIDTH PLOT MIDDLE OF BAND	12
20dB OCCUPIED BANDWIDTH PLOT HIGH END OF BAND	13
EMISSION MASK PLOT LOW END OF BAND	14
EMISSION MASK PLOT MIDDLE OF BAND	15
EMISSION MASK PLOT HIGH END OF BAND	16
SPURIOUS EMISSIONS AT ANTENNA TERMINALS (CONDUCTED)	17
TEST DATA: LOW FREQUENCY	18
TEST DATA: MIDDLE FREQUENCY	19
TEST DATA: HIGH FREQUENCY	20
FIELD STRENGTH OF SPURIOUS EMISSIONS.....	21
TEST DATA: LOW FREQUENCY	23
TEST DATA: MIDDLE FREQUENCY	23
TEST DATA: HIGH FREQUENCY	24
FREQUENCY STABILITY	25
TEST DATA: FCC FREQUENCY STABILITY TABLE	26
TEST DATA: FCC FREQUENCY STABILITY PLOT	26
TEST DATA: IC FREQUENCY STABILITY TABLE	27
TEST DATA: IC FREQUENCY STABILITY PLOT.....	27
STATE OF THE MEASUREMENT UNCERTAINTY.....	28
EQUIPMENT LIST.....	29

GENERAL REMARKS

Summary

The device under test does:

- Fulfill the general approval requirements as identified in this test report and was selected by the customer.
- Not fulfill the general approval requirements as identified in this test report

Attestations

This equipment has been tested in accordance with the standards identified in this test report. To the best of my knowledge and belief, these tests were performed using the measurement procedures described in this report.

All instrumentation and accessories used to test products for compliance to the indicated standards are calibrated regularly in accordance with ISO 17025 requirements.

I attest that the necessary measurements were made at:

Timco Engineering Inc.
849 NW State Road 45
Newberry, FL 32669
Designation #: US1070

Tested by:



Name and Title	Tim Royer, Project Manager / EMC Testing Engineer
Date	02/20/2019

Reviewed and Approved by:



Name and Title	Franklin Rose, Project Manager / EMC Testing Technician
Date	02/27/2019

Applicant: BEI ELECTRONICS, LLC
FCC ID: DDEETG500
IC: 131A-ETG500
Report: 212UT20TestReport_Rev2

GENERAL INFORMATION

EUT Description	FM BROADCAST TRANSMITTER
FCC ID	DDEETG500
IC	131A-ETG500
Model Number	ETG500
Operating Frequency	88 – 108 MHz
Test Frequencies	88, 98, 108 MHz
EUT Power Source	<input checked="" type="checkbox"/> 90–250Vac/50– 60Hz
	<input type="checkbox"/> DC Power
	<input type="checkbox"/> Battery Operated Exclusively
Test Item	<input type="checkbox"/> Prototype
	<input checked="" type="checkbox"/> Pre-Production
	<input type="checkbox"/> Production
Type of Equipment	<input checked="" type="checkbox"/> Fixed
	<input type="checkbox"/> Mobile
	<input type="checkbox"/> Portable
Antenna Connector	DIN
Test Conditions	The temperature was 26°C Relative humidity of 50%.
Modification to the EUT	No Modification to EUT.
Test Exercise	The EUT was placed in continuous transmit and was operated in “Test Mode” for digital emissions tests.
Applicable Standards	ANSI C63.26-2015, FCC CFR 47 Part 73, BETS-6 Issue 2, Referencing ANSI/TIA 603-D:2010
Test Facility	Timco Engineering Inc. at 849 NW State Road 45 Newberry, FL 32669 USA. Designation #: US1070, IC US0111, 2056A

Applicant: BEI ELECTRONICS, LLC
 FCC ID: DDEETG500
 IC: 131A-ETG500
 Report: 212UT20TestReport_Rev2

RESULTS SUMMARY

Test Description	FCC RULE PART NO.	RESULT
RF Power Output	2.1046(a), 73.267(b), 73.211 BETS-6 6.1.3	Pass
Power Into the Amplifier	2.1033(C)(8)	For Reporting Only
Modulation Characteristics	2.202(g)(III)(3), BETS-6 4.2	Pass
Audio Frequency Response	2.1047(a)	Pass
Audio Input Vs. Modulation	2.1047(b), BETS-6 4.2	Pass
Occupied Bandwidth	2.1049(e)(3) – (5), 73.317(b), (c), BETS-6 6.3.3	Pass
Spurious Emissions at Antenna Terminal	Part 2.1051 & 73.317(d), BETS-6 6.3.3	Pass
Field Strength of Spurious Radiation	Part 2.1053(a) & 73.317(d), BETS-6 6.3.3	Pass
Frequency Stability	Part 2.1055(a)(3), Part 73.1545(b), BETS-6 6.2.2	Pass

RF POWER OUTPUT

Rule Part No.: Part 2.1046(a), Part 73.267(b), 73.211, BETS-6 6.1.3

Test Requirements: Part 73.267(b)

(c) *Indirect method.* The operating power is determined by the indirect method by applying an appropriate factor to the input power to the last radio-frequency power amplifier stage of the transmitter, using the following formula:

$$\text{Transmitter output power} = E_p \times I_p \times F$$

Where:

E_p = DC input voltage of final radio stage.

I_p = Total DC input current of final radio stage.

F = Efficiency factor.

(1) If the above formula is not appropriate for the design of the transmitter final amplifier, use a formula specified by the transmitter manufacturer with other appropriate operating parameters.

(2) The value of the efficiency factor, F , established for the authorized transmitter output power is to be used for maintaining the operating power, even though there may be some variation in F over the power operating range of the transmitter.

(3) The value of F is to be determined and a record kept thereof by one of the following procedures listed in order of preference:

(i) Using the most recent measurement data for calibration of the transmission line meter according to the procedures described in paragraph (b) of this section or the most recent measurements made by the licensee establishing the value of F . In the case of composite transmitters or those in which the final amplifier stages have been modified pursuant to FCC approval, the licensee must furnish the FCC and also retain with the station records the measurement data used as a basis for determining the value of F .

(ii) Using measurement data shown on the transmitter manufacturer's test data supplied to the licensee; *Provided*, That measurements were made at the authorized frequency and transmitter output power.

(iii) Using the transmitter manufacturer's measurement data submitted to the FCC for type acceptance and as shown in the instruction book supplied to the licensee.

§73.811 LPFM power and antenna height requirements.

(a) *Maximum facilities.* LPFM stations will be authorized to operate with maximum facilities of 100 watts ERP at 30 meters HAAT. An LPFM station with a HAAT that exceeds 30 meters will not be permitted to operate with an ERP greater than that which would result in a 60 dBu contour of 5.6 kilometers. In no event will an ERP less than one watt be authorized. No facility will be authorized in excess of one watt ERP at 450 meters HAAT.

§73.812 Rounding of power and antenna heights.

(a) Effective radiated power (ERP) will be rounded to the nearest watt on LPFM authorizations.

Applicant: BEI ELECTRONICS, LLC
FCC ID: DDEETG500
IC: 131A-ETG500
Report: 212UT20TestReport_Rev2

Test Requirements: BETS-6 6.1.3

6.1.3 Standard

The standard rating of power output for the transmitting equipment shall be as specified by the individual manufacturer. The transmitting equipment shall be capable of being adjusted to deliver the rated power output when the AC input voltage varies by 5% from the rated value.

Method of Measurement: ANSI C63.26

Test Setup Diagram:

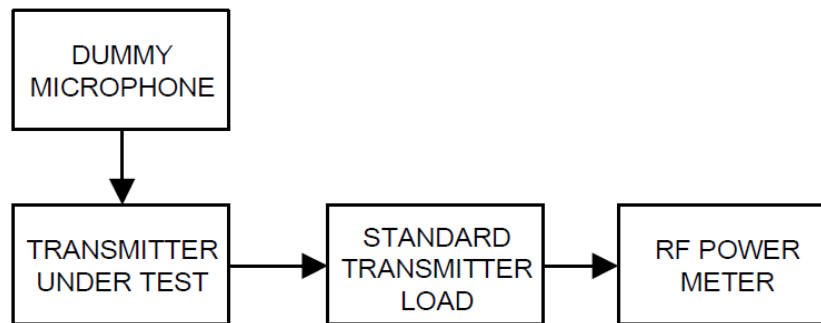

RF POWER OUTPUT

$$\text{Transmitter output power} = E_p \times I_p \times F$$

Where:

E_p = DC input voltage of final radio stage.

I_p = Total DC input current of final radio stage.

F = Efficiency factor.

Test Data: RF Output Power

OUTPUT POWER: 465 Watts

Test Data: Power In the Final Stage

Power at Final Stage: (230.0 VDC) (2.5 A) = **575 Watts**

MODULATION CHARACTERISTICS

Rule Part No.: Part 2.202(g)(III)(3) "Sound Broadcasting", BETS-6 4.2

Test Requirements: Part 2.202(g)(III)(3)

Description of emission	Necessary bandwidth		Designation of emission
	Formula	Sample calculation	
III-A. FREQUENCY MODULATION			
3. Sound Broadcasting			
Sound broadcasting	$B_n = 2M + 2DK$, K = 1 (typically)	Monaural, D = 75,000 Hz, M = 15,000, Bandwidth: 18,000 Hz = 180 kHz	180KF3E

Test Requirements: BETS-6 4.2

4.2 Type of Emission

The designation of modulation and emission refers to the manner in which the carrier is modulated and transmitted. The transmitting equipment shall produce F3EGN emission for monophonic operation and F8EHF emission for stereophonic operation. The transmitting equipment shall be capable of operating with a frequency deviation of ± 75 kHz, which is equivalent to 100% modulation.

Type of Emission: 180KF3E

$$B_n = 2M + 2DK$$

$$B_n = 2(15K) + 2(75K)(1) = 180K$$

Where:

M = 10 (Modulation Frequency, kHz)

D = 75 (Peak Deviation, kHz)

K = 1 (constant value)

AUDIO FREQUENCY RESPONSE

Rule Part No.: FCC Part 2.1047(a), (b)

Test Requirements: FCC Part 2.1047(a)

§2.1047 Measurements required: Modulation characteristics.

(a) *Voice modulated communication equipment.* A curve or equivalent data showing the frequency response of the audio modulating circuit over a range of 100 to 5000 Hz shall be submitted. For equipment required to have an audio low-pass filter, a curve showing the frequency response of the filter, or of all circuitry installed between the modulation limiter and the modulated stage shall be submitted.

Method of Measurement: ANSI C63.26 s. 5.3.3

Test Setup Diagram:

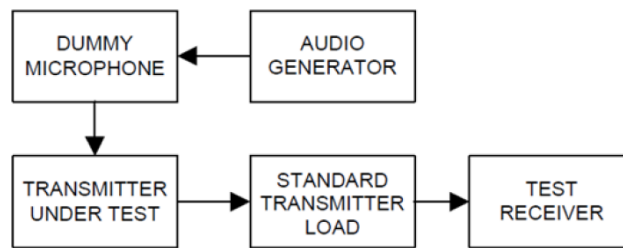
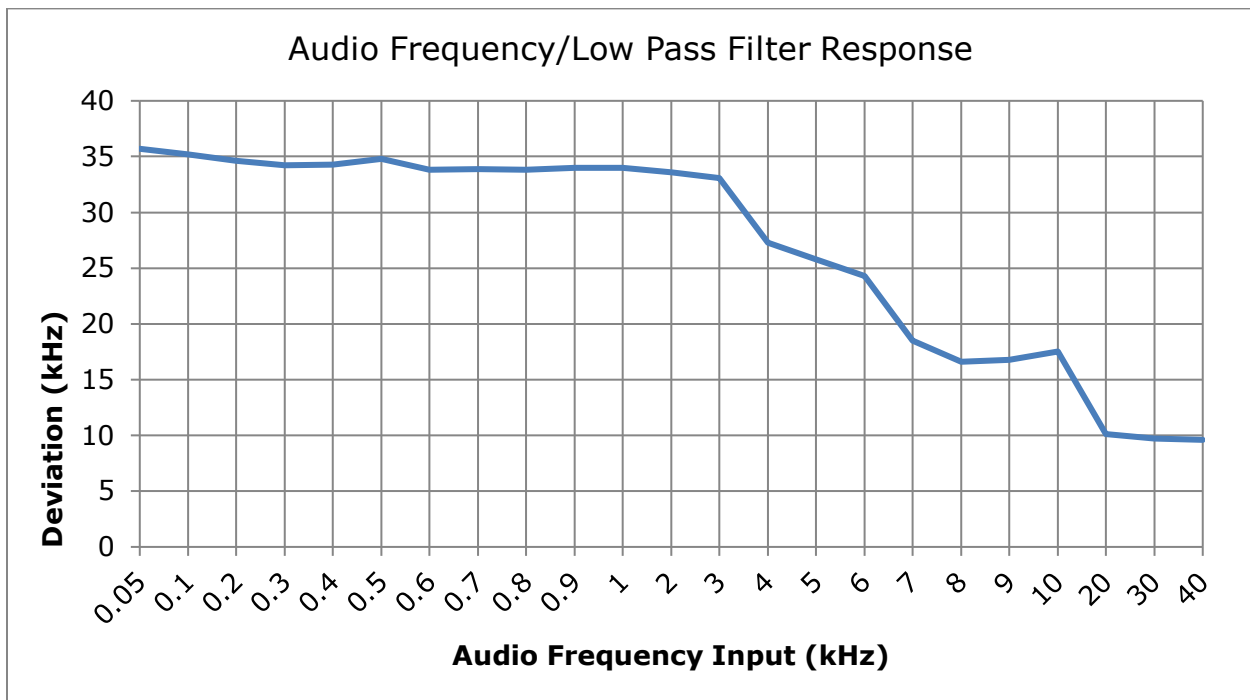

Figure 3—Equipment set-up audio frequency response (constant input)

Test Data: Audio Frequency Response Plot



Applicant: BEI ELECTRONICS, LLC
 FCC ID: DDEETG500
 IC: 131A-ETG500
 Report: 212UT20TestReport_Rev2

AUDIO INPUT VS MODULATION

Rule Part No.: FCC Part 2.1047(b), BETS-6 4.2

Test Requirements: FCC Part 2.1047(b)

(b) *Equipment which employs modulation limiting.* A curve or family of curves showing the percentage of modulation versus the modulation input voltage shall be supplied. The information submitted shall be sufficient to show modulation limiting capability throughout the range of modulating frequencies and input modulating signal levels employed.

Test Requirements: BETS-6 4.2

4.2 Type of Emission

The designation of modulation and emission refers to the manner in which the carrier is modulated and transmitted. The transmitting equipment shall produce F3EGN emission for monophonic operation and F8EHF emission for stereophonic operation. The transmitting equipment shall be capable of operating with a frequency deviation of ± 75 kHz, which is equivalent to 100% modulation.

Method of Measurement: ANSI C63.26 s. 5.3.2

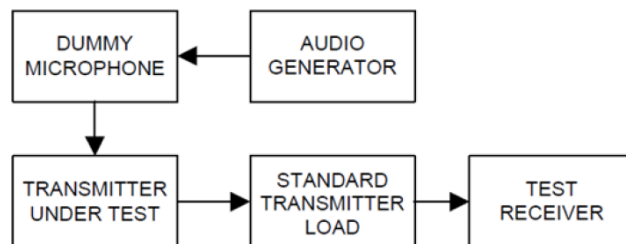
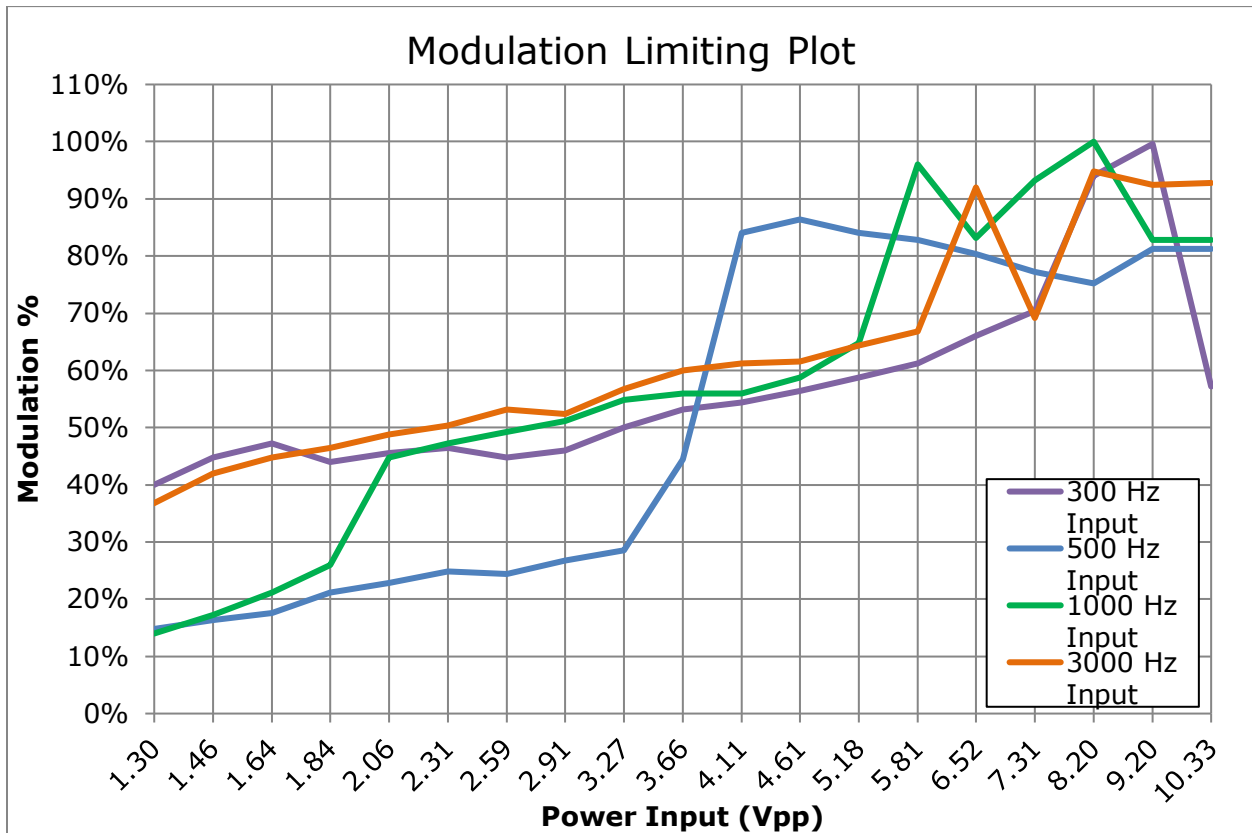

Figure 3—Equipment set-up audio frequency response (constant input)

AUDIO INPUT VERSUS MODULATION

Test data: Modulation Limiting



OCCUPIED BANDWIDTH & EMISSION MASK

Rule Part No.: FCC Part 2.1049(e)(3) – (5), Part 73.317(b), (c), BETS-6 6.3.3

Requirement: FCC 2.1049(e)(3)-(5)

§2.1049 Measurements required: Occupied bandwidth.

(e) Transmitters for use in the Radio Broadcast Services:

(3) FM broadcast transmitter not used for multiplex operation—when modulated 85 percent by a 15 kHz input signal.

(4) FM broadcast transmitters for multiplex operation under Subsidiary Communication Authorization (SCA)—when carrier is modulated 70 percent by a 15 kHz main channel input signal, and modulated an additional 15 percent simultaneously by a 67 kHz subcarrier (unmodulated).

(5) FM broadcast transmitter for stereophonic operation—when modulated by a 15 kHz input signal to the main channel, a 15 kHz input signal to the stereophonic subchannel, and the pilot subcarrier simultaneously. The input signals to the main channel and stereophonic subchannel each shall produce 38 percent modulation of the carrier. The pilot subcarrier should produce 9 percent modulation of the carrier.

Requirement: FCC 73.317(b), (c)

(b) Any emission appearing on a frequency removed from the carrier by between 120 kHz and 240 kHz inclusive must be attenuated at least 25 dB below the level of the unmodulated carrier. Compliance with this requirement will be deemed to show the occupied bandwidth to be 240 kHz or less.

(c) Any emission appearing on a frequency removed from the carrier by more than 240 kHz and up to and including 600 kHz must be attenuated at least 35 dB below the level of the unmodulated carrier.

Requirement: BETS-6 6.3.3

6.3.3 Standard

Spurious emissions of the transmitting equipment shall not exceed the values given below:

Spurious Emission	Maximum Value
Between 120 kHz and 240 kHz from the carrier frequency	-25 dB
More than 240 kHz and up to and including 600 kHz from the carrier frequency	-35 dB*
More than 600 kHz from the carrier frequency, whichever is the stronger	$-(43 + 10 \log P)$ or -80 dB* P = power in watts

Test Setup Diagram:

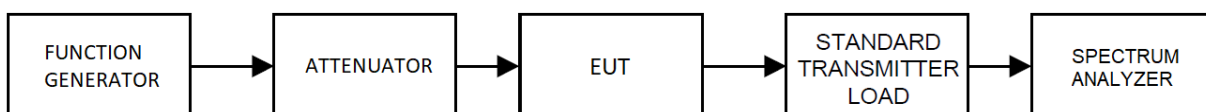

Applicant: BEI ELECTRONICS, LLC
 FCC ID: DDEETG500
 IC: 131A-ETG500
 Report: 212UT20TestReport_Rev2

Test Data: Occupied Bandwidth Table

Frequency (MHz)	20dB OBW (kHz)
88	252.5
98	256.51
108	258.51

20dB OCCUPIED BANDWIDTH PLOT Low End of band

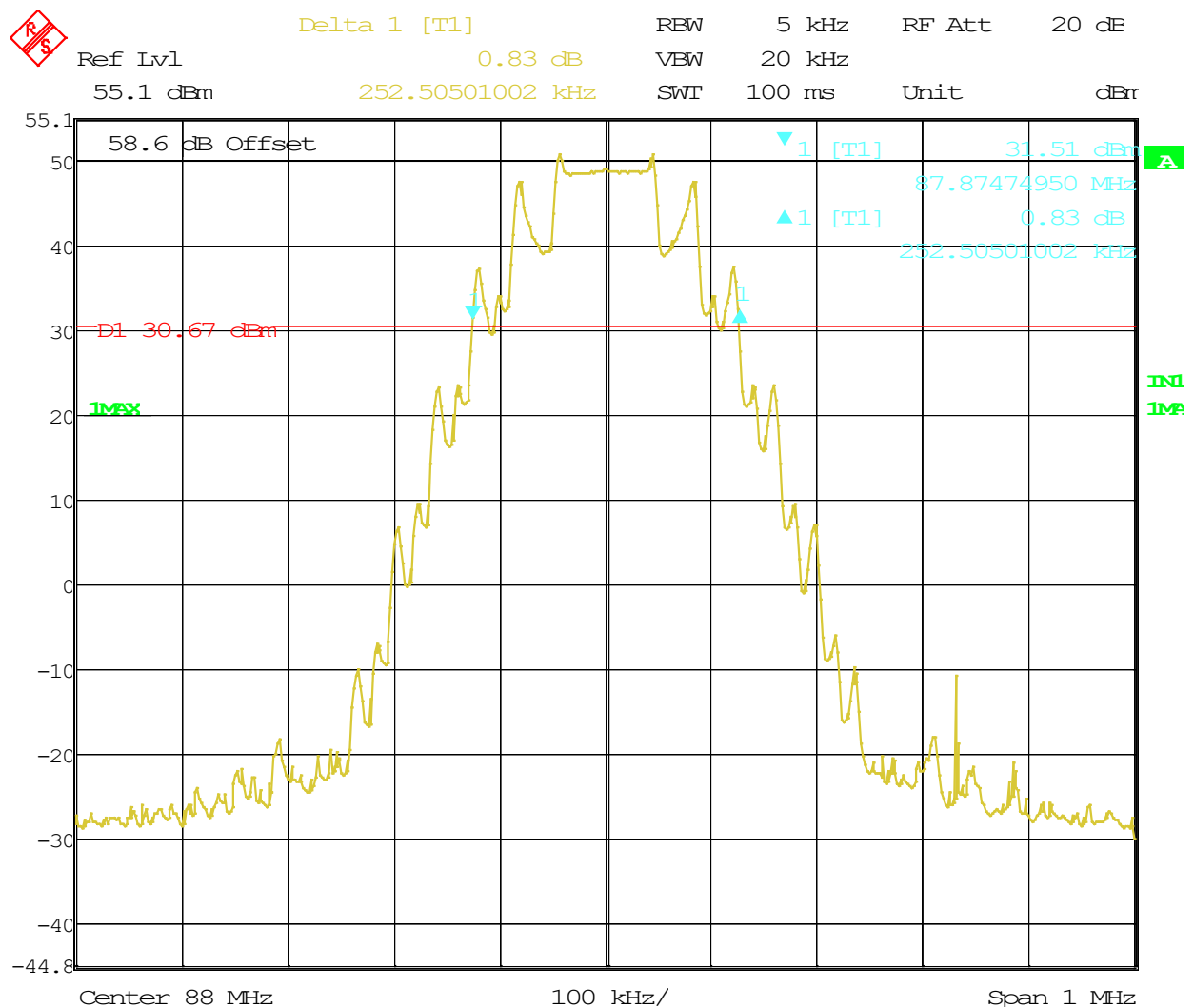

Date: 1.JAN.1997 03:24:08

Applicant: BEI ELECTRONICS, LLC
 FCC ID: DDEETG500
 IC: 131A-ETG500
 Report: 212UT20TestReport_Rev2

20dB OCCUPIED BANDWIDTH PLOT Middle of band

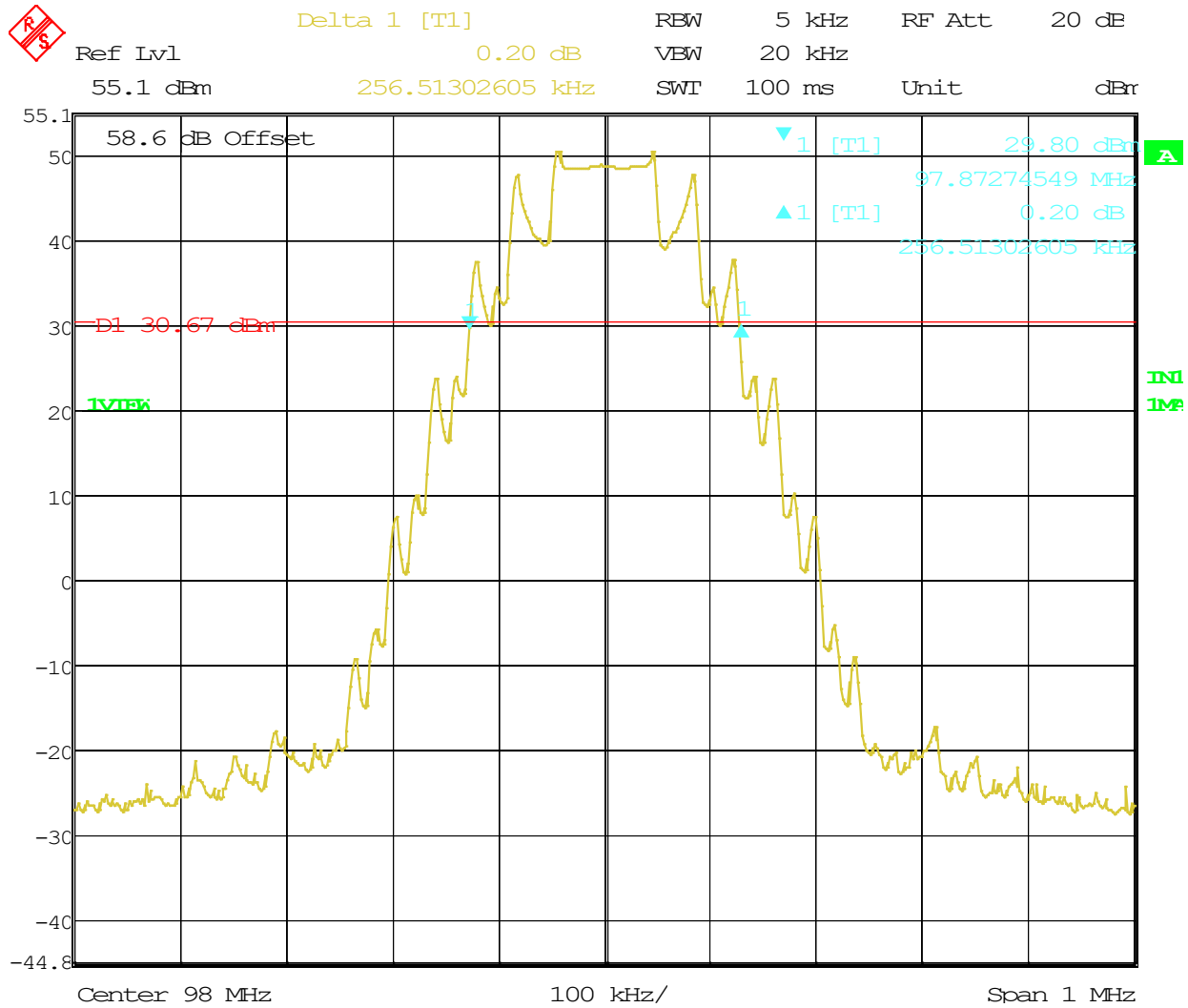

Date: 1.JAN.1997 03:22:43

20dB OCCUPIED BANDWIDTH PLOT High End of band

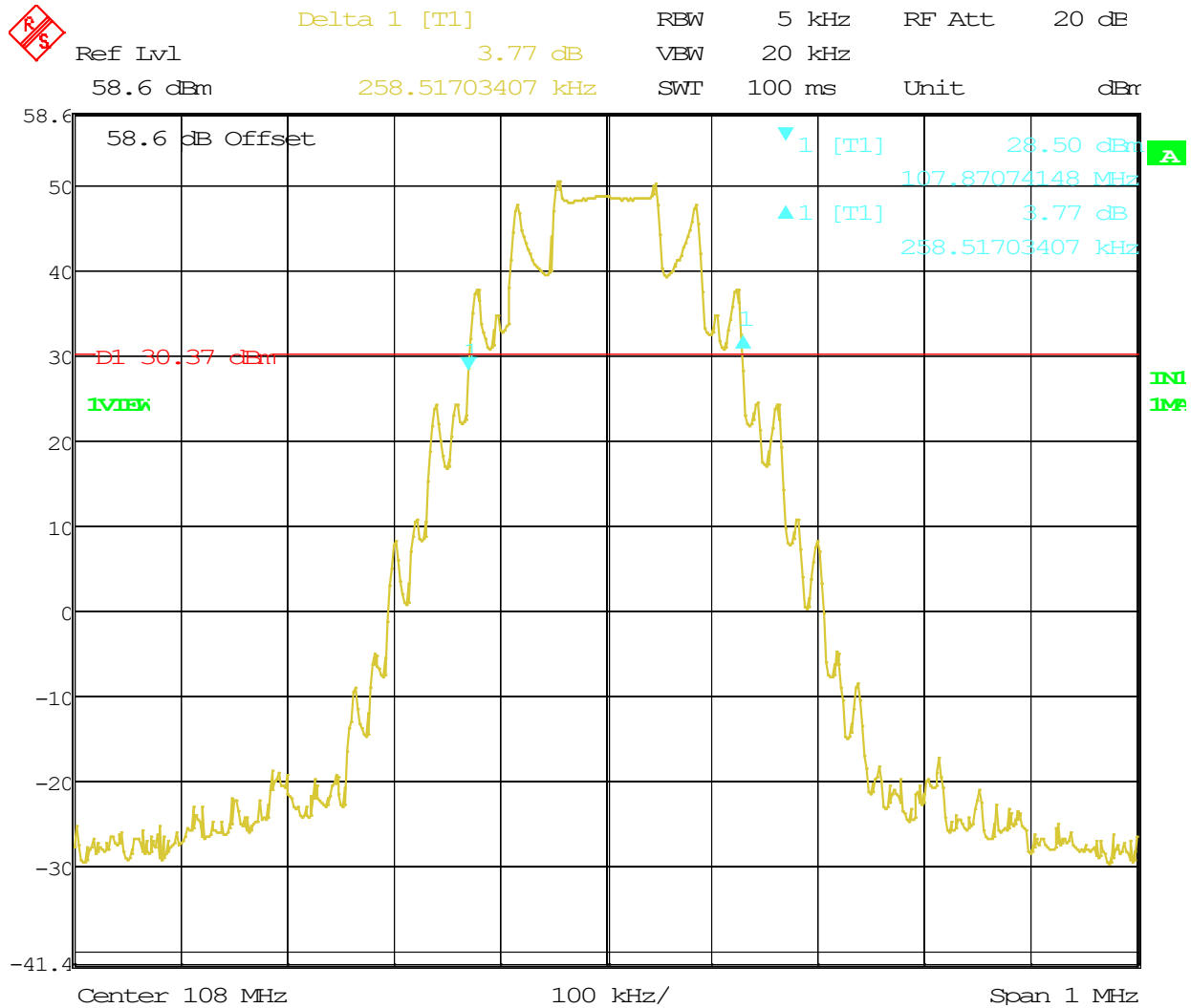

Date: 1.JAN.1997 03:05:35

EMISSION MASK PLOT Low End of band

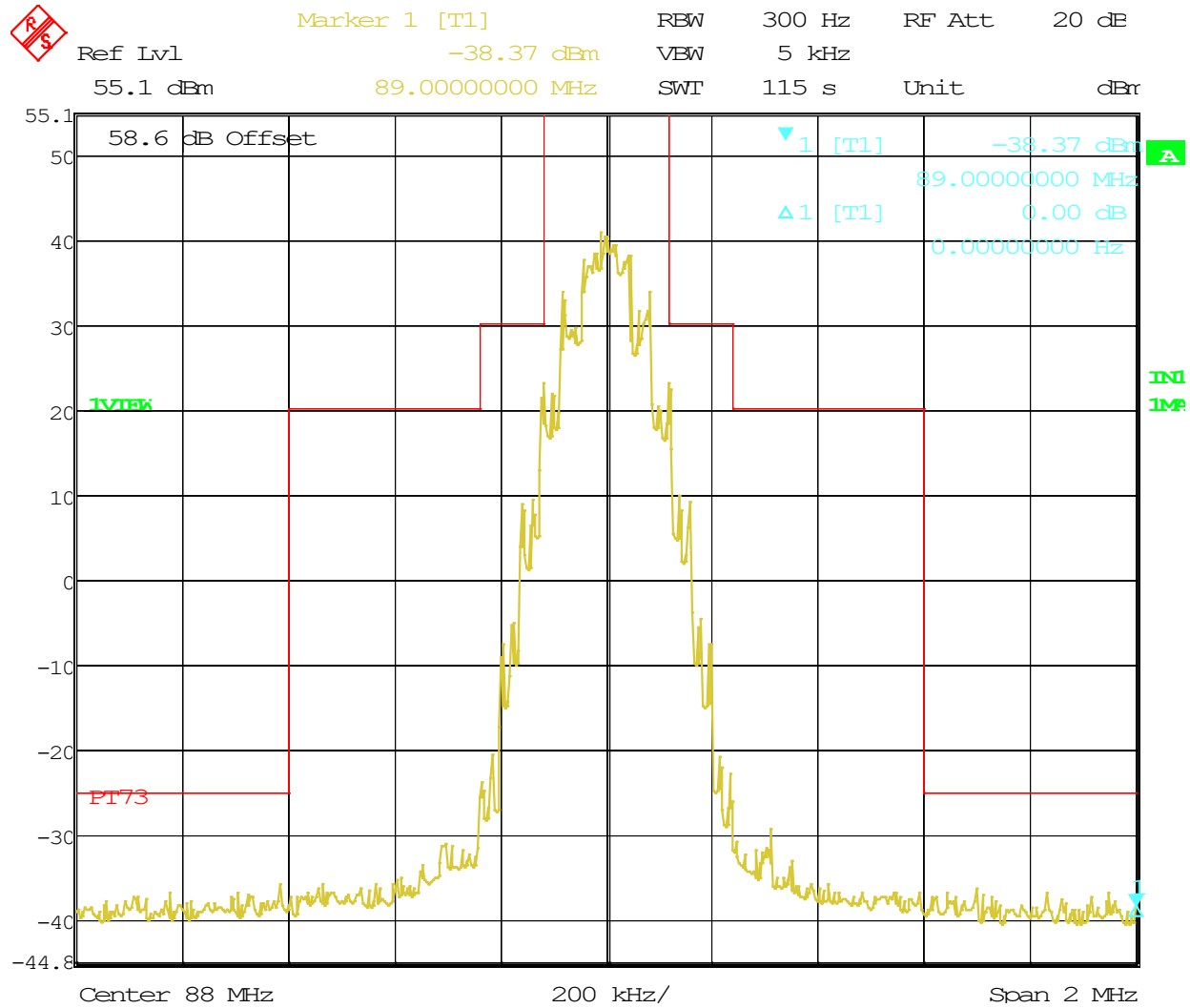

Date: 1.JAN.1997 03:18:41

Applicant: BEI ELECTRONICS, LLC
 FCC ID: DDEETG500
 IC: 131A-ETG500
 Report: 212UT20TestReport_Rev2

EMISSION MASK PLOT Middle of band

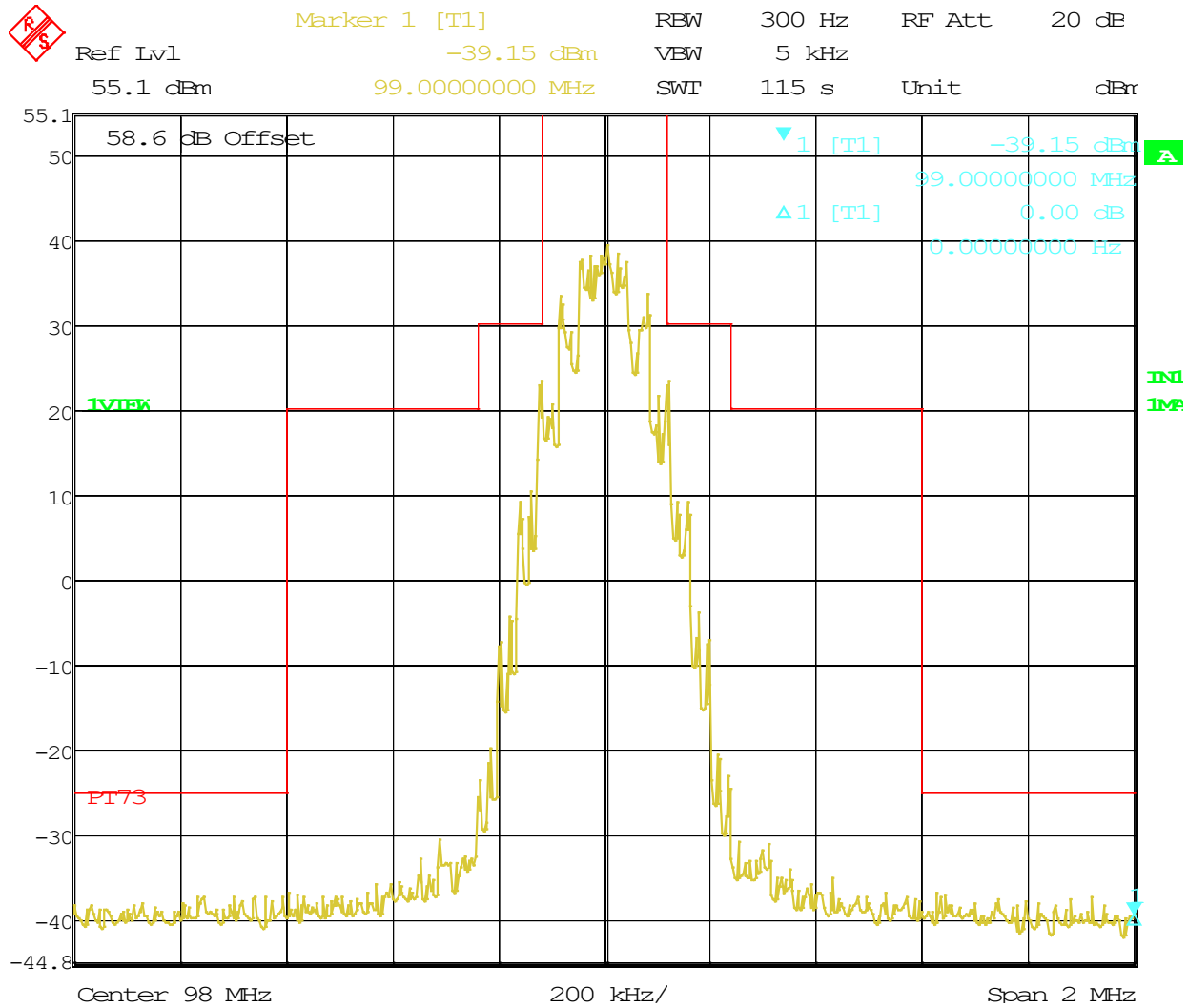

Date: 1.JAN.1997 03:12:47

Applicant: BEI ELECTRONICS, LLC
 FCC ID: DDEETG500
 IC: 131A-ETG500
 Report: 212UT20TestReport_Rev2

EMISSION MASK PLOT High End of band

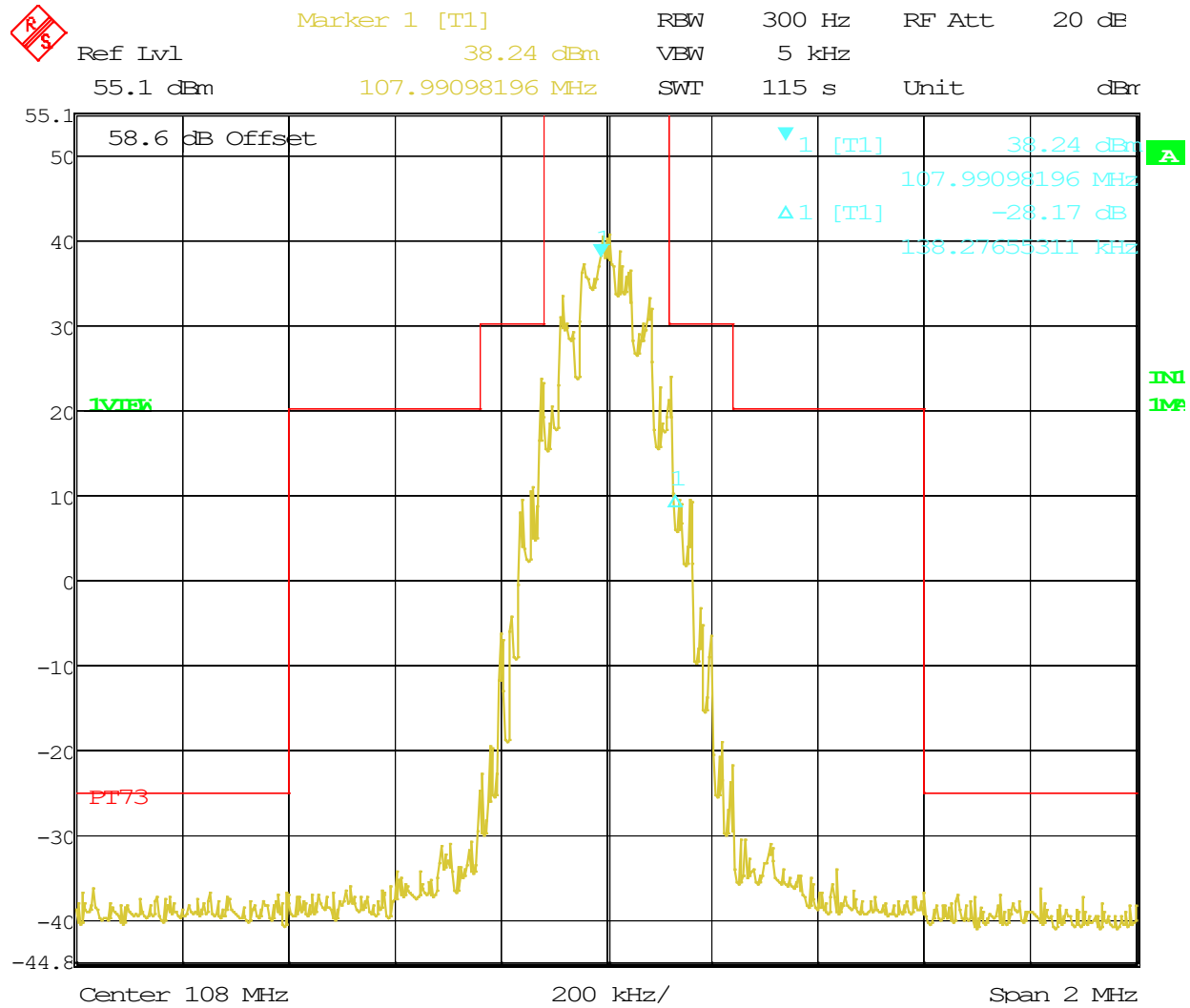

Date: 1.JAN.1997 03:09:35

Applicant: BEI ELECTRONICS, LLC
 FCC ID: DDEETG500
 IC: 131A-ETG500
 Report: 212UT20TestReport_Rev2

SPURIOUS EMISSIONS AT ANTENNA TERMINALS (CONDUCTED)

Rule Part No.: Part 2.1051 & 73.317(d), BETS-6 6.3.3

Test Requirements: 73.317 (d)

(d) Any emission appearing on a frequency removed from the carrier by more than 600 kHz must be attenuated at least $43 + 10 \log_{10}(\text{Power, in watts})$ dB below the level of the unmodulated carrier, or 80 dB, whichever is the lesser attenuation.

Test Requirements: BETS-6 6.3.3

More than 600 kHz from the carrier frequency, whichever is the stronger	$-(43 + 10 \log P)$ <input type="text"/> or -80 dB* P = power in watts
---	--

$$43 + 10 * \log (1213) = 73.83 \text{ dB} < 80 \text{ dB}$$

Antenna Conducted Emissions: The RBW = 100 kHz, VBW = 300 kHz and the span set to 10.0 MHz and the spectrum was scanned from 30 MHz to the 10th harmonic of the fundamental. Above 1 GHz the resolution bandwidth was 1 MHz and the VBW = 3 MHz and the span to 50 MHz.

Method of Measuring Conducted Spurious Emissions

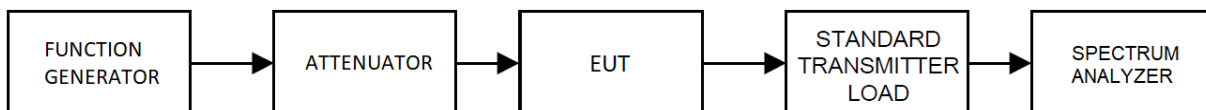

SPURIOUS EMISSIONS AT ANTENNA TERMINALS (CONDUCTED)

SPURIOUS EMISSIONS AT ANTENNA TERMINALS (CONDUCTED)

Test Data: Low Frequency

		(dBm)	(Watts)	Limit (dBc)
Mean High Power (dBm)		56.7	467.74	69.7
		High Power		
	Frequency	Peak (dBm)	Margin (dB)	
(fundamental)	88.000	0.00	0.00	
2nd Harmonic	176.000	-13.40	0.40	
3rd Harmonic	264.000	-20.49	7.49	
4th Harmonic	* 352.000	-27.76	14.76	
5th Harmonic	* 440.000	-27.76	14.76	
6th Harmonic	* 528.000	-27.76	14.76	
7th Harmonic	* 616.000	-27.76	14.76	
8th Harmonic	* 704.000	-27.76	14.76	
9th Harmonic	* 792.000	-27.76	14.76	
10th Harmonic	* 880.000	-27.76	14.76	
* Indicates Noise Floor of Measurement				

Test Data: Middle Frequency

		(dBm)	(Watts)	Limit (dBc)
Mean High Power (dBm)		56.7	467.74	69.7
		High Power		
		Frequency	Peak (dBm)	Margin (dB)
(fundamental)		98.000	0.00	0.00
2nd Harmonic		196.000	-38.36	25.36
3rd Harmonic		294.000	-24.49	11.49
4th Harmonic	*	392.000	-46.71	33.71
5th Harmonic		490.000	-38.91	25.91
6th Harmonic	*	588.000	-46.71	33.71
7th Harmonic	*	686.000	-46.71	33.71
8th Harmonic	*	784.000	-46.71	33.71
9th Harmonic	*	882.000	-46.71	33.71
10th Harmonic	*	980.000	-46.71	33.71
* Indicates Noise Floor of Measurement				

SPURIOUS EMISSIONS AT ANTENNA TERMINALS (CONDUCTED)

Test Data: High Frequency

		(dBm)	(Watts)	Limit (dBc)
Mean High Power (dBm)		56.7	467.74	69.7
		High Power		
		Frequency	Peak (dBm)	Margin (dB)
(fundamental)		108.000	0.00	0.00
2nd Harmonic		216.000	-25.84	12.84
3rd Harmonic		324.000	-26.80	13.80
4th Harmonic		432.000	-37.67	24.67
5th Harmonic		540.000	-39.56	26.56
6th Harmonic		648.000	-41.91	28.91
7th Harmonic	*	756.000	-46.26	33.26
8th Harmonic	*	864.000	-46.26	33.26
9th Harmonic	*	972.000	-46.26	33.26
10th Harmonic		1080.000	-32.91	19.91
* Indicates Noise Floor of Measurement				

FIELD STRENGTH OF SPURIOUS EMISSIONS

Rule Parts. No.: Part 2.1053(a) & 73.317 (d), BETS-6 6.3.3

Test Requirements: 73.317 (d)

(d) Any emission appearing on a frequency removed from the carrier by more than 600 kHz must be attenuated at least $43 + 10 \log_{10}(\text{Power, in watts})$ dB below the level of the unmodulated carrier, or 80 dB, whichever is the lesser attenuation.

Test Requirements: BETS-6 6.3.3

More than 600 kHz from the carrier frequency, whichever is the stronger

$-(43 + 10 \log P)$
 or -80 dB^*
 P = power in watts

$$43 + 10 * \log (1213) = 73.83 \text{ dB} < 80 \text{ dB}$$

Test Site Setup:

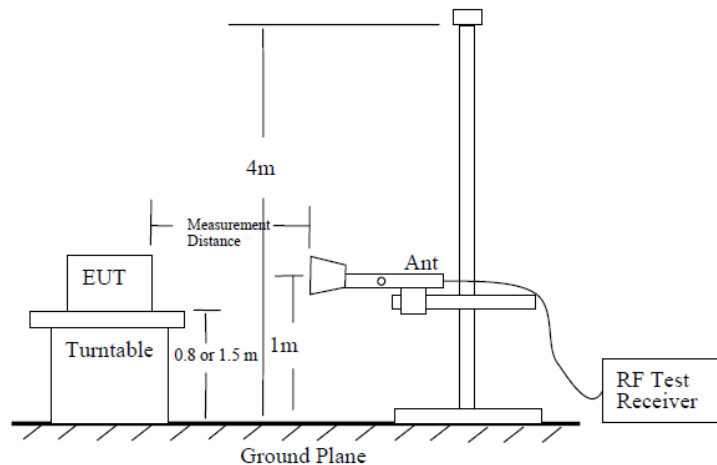

EUT Orientation(s):

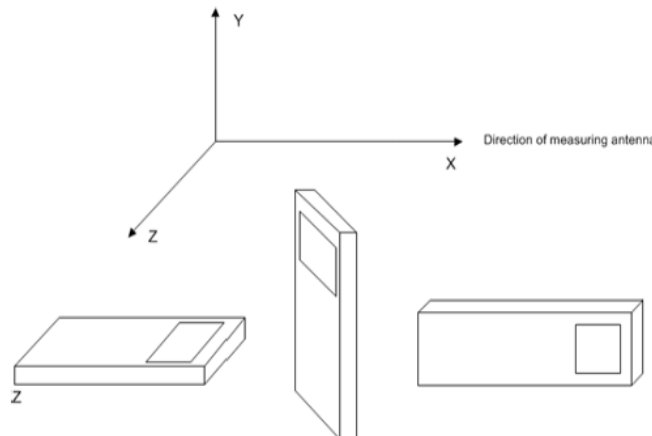

Applicant: BEI ELECTRONICS, LLC
 FCC ID: DDEETG500
 IC: 131A-ETG500
 Report: 212UT20TestReport_Rev2

FIELD STRENGTH OF SPURIOUS EMISSIONS

Note: The tabulated data shows the results of the radiated field strength emissions test. The spectrum was scanned from the lowest frequency generated internally to at least the tenth harmonic of the fundamental. This test was conducted in accordance with the standard listed above using the substitution method. Measurements were made at the test site of TIMCO ENGINEERING, INC. located at 849 NW State Road 45, Newberry, FL 32669. The measurements below represent the worst case of all the frequencies tested.

Note: Six (6) or more of the highest emissions of each worst-case operational mode of the EUT are represented below. Emissions 20 dB below the limit were not required to be reported.

FIELD STRENGTH OF SPURIOUS EMISSIONS

Test Data: Low Frequency

Tuned Frequency (MHz)	Emission Frequency (MHz)	Meter Reading (dBµV)	Antenna Polarity	Coax Loss (dB)	Correction Factor (dB/m)	Distance (m)	Field Strength (dBµV/m)	ERP (dBm)	Limit (dBm)	Margin (dB)
88.00	176.00	29.48	V	1.54	14.70	3.00	45.72	-51.65	-13.00	38.65
88.00	264.00	64.58	V	2.03	12.80	3.00	79.41	-17.96	-13.00	4.96
88.00	264.00	61.35	H	2.03	12.80	3.00	76.18	-21.19	-13.00	8.19
88.00	352.00	45.98	H	2.12	14.80	3.00	62.90	-34.48	-13.00	21.48
88.00	352.00	55.94	V	2.12	14.80	3.00	72.86	-24.52	-13.00	11.52
88.00	440.00	40.57	V	2.40	16.20	3.00	59.17	-38.21	-13.00	25.21
88.00	440.00	30.54	H	2.40	16.20	3.00	49.14	-48.24	-13.00	35.24
88.00	528.00	29.69	H	2.76	17.20	3.00	49.65	-47.73	-13.00	34.73
88.00	528.00	24.34	V	2.76	17.20	3.00	44.30	-53.08	-13.00	40.08
88.00	616.00	30.24	V	2.90	18.80	3.00	51.94	-45.44	-13.00	32.44
88.00	616.00	25.57	H	2.90	18.80	3.00	47.27	-50.11	-13.00	37.11
88.00	704.00	28.54	H	3.11	21.30	3.00	52.95	-44.43	-13.00	31.43
88.00	704.00	29.80	V	3.11	21.30	3.00	54.21	-43.17	-13.00	30.17
88.00	792.00	25.73	V	3.32	21.30	3.00	50.35	-47.03	-13.00	34.03
88.00	792.00	23.81	H	3.32	21.30	3.00	48.43	-48.95	-13.00	35.95

Test Data: Middle Frequency

Tuned Frequency (MHz)	Emission Frequency (MHz)	Meter Reading (dBµV)	Antenna Polarity	Coax Loss (dB)	Correction Factor (dB/m)	Distance (m)	Field Strength (dBµV/m)	ERP (dBm)	Limit (dBm)	Margin (dB)
98.00	196.00	38.46	V	1.61	15.90	3.00	55.97	-41.41	-13.00	28.41
98.00	196.00	36.94	V	1.61	15.90	3.00	54.45	-42.93	-13.00	29.93
98.00	294.00	65.08	V	2.08	13.70	3.00	80.86	-16.52	-13.00	3.52
98.00	294.00	61.50	H	2.08	13.70	3.00	77.28	-20.10	-13.00	7.10
98.00	392.00	36.90	V	2.27	15.10	3.00	54.27	-43.11	-13.00	30.11
98.00	392.00	32.02	H	2.27	15.10	3.00	49.39	-47.99	-13.00	34.99
98.00	490.00	30.19	H	2.62	17.80	3.00	50.61	-46.77	-13.00	33.77
98.00	490.00	27.50	V	2.62	17.80	3.00	47.92	-49.46	-13.00	36.46
98.00	588.00	36.68	V	2.87	18.90	3.00	58.45	-38.93	-13.00	25.93
98.00	588.00	23.80	H	2.87	18.90	3.00	45.57	-51.81	-13.00	38.81
98.00	686.00	41.03	H	3.06	20.80	3.00	64.89	-32.49	-13.00	19.49
98.00	686.00	40.10	V	3.06	20.80	3.00	63.96	-33.42	-13.00	20.42
98.00	784.00	36.98	V	3.30	21.60	3.00	61.88	-35.49	-13.00	22.49
98.00	784.00	37.06	H	3.30	21.60	3.00	61.96	-35.41	-13.00	22.41
98.00	882.00	38.72	H	3.54	21.50	3.00	63.76	-33.61	-13.00	20.61
98.00	882.00	39.27	V	3.54	21.50	3.00	64.31	-33.06	-13.00	20.06
98.00	980.00	37.48	V	3.69	23.60	3.00	64.77	-32.61	-13.00	19.61
98.00	980.00	32.44	H	3.69	23.60	3.00	59.73	-37.65	-13.00	24.65

Test Data: High Frequency

Tuned Frequency (MHz)	Emission Frequency (MHz)	Meter Reading (dBμV)	Antenna Polarity	Coax Loss (dB)	Correction Factor (dB/m)	Distance (m)	Field Strength (dBμV/m)	ERP (dBm)	Limit (dBm)	Margin (dB)
108.00	216.00	49.81	H	1.67	10.70	3.00	62.18	-35.20	-13.00	22.20
108.00	216.00	53.84	V	1.67	10.70	3.00	66.21	-31.17	-13.00	18.17
108.00	324.00	58.61	V	2.09	13.80	3.00	74.50	-22.88	-13.00	9.88
108.00	324.00	59.95	H	2.09	13.80	3.00	75.84	-21.54	-13.00	8.54
108.00	432.00	37.72	H	2.38	16.90	3.00	57.00	-40.37	-13.00	27.37
108.00	432.00	43.98	V	2.38	16.90	3.00	63.26	-34.11	-13.00	21.11
108.00	540.00	41.67	V	2.78	17.30	3.00	61.75	-35.63	-13.00	22.63
108.00	540.00	28.72	H	2.78	17.30	3.00	48.80	-48.58	-13.00	35.58
108.00	648.00	27.74	H	2.96	20.20	3.00	50.90	-46.48	-13.00	33.48
108.00	648.00	33.72	V	2.96	20.20	3.00	56.88	-40.50	-13.00	27.50
108.00	756.00	36.84	V	3.23	20.90	3.00	60.97	-36.41	-13.00	23.41
108.00	756.00	29.59	H	3.23	20.90	3.00	53.72	-43.66	-13.00	30.66
108.00	864.00	33.40	H	3.50	22.70	3.00	59.60	-37.78	-13.00	24.78
108.00	864.00	36.18	V	3.50	22.70	3.00	62.38	-35.00	-13.00	22.00
108.00	972.00	37.68	V	3.66	23.60	3.00	64.94	-32.44	-13.00	19.44
108.00	972.00	30.86	H	3.66	23.60	3.00	58.12	-39.26	-13.00	26.26
108.00	1080.00	33.96	H	3.90	27.70	3.00	65.56	-31.82	-13.00	18.82
108.00	1080.00	39.74	V	3.90	27.70	3.00	71.34	-26.04	-13.00	13.04

FREQUENCY STABILITY

Rule Parts. No.: Part 2.1055(a)(3), Part 73.1545(b), BETS-6 6.2.2

Test Requirements: Part 2.1055(A) (3)

§2.1055 Measurements required: Frequency stability.

(a) The frequency stability shall be measured with variation of ambient temperature as follows:

(1) From -30° to $+50^{\circ}$ centigrade for all equipment except that specified in paragraphs (a) (2) and (3) of this section.

(3) From 0° to $+50^{\circ}$ centigrade for equipment to be licensed for use in the Radio Broadcast Services under part 73 of this chapter.

Test Requirements: Part 73.1545(b)

§73.1545 Carrier frequency departure tolerances.

(b) *FM stations.* (1) The departure of the carrier or center frequency of an FM station with an authorized transmitter output power more than 10 watts may not exceed ± 2000 Hz from the assigned frequency.

Test Requirements: BETS-6 6.2.2

6.2 Carrier Frequency Stability

6.2.1 Definition

The carrier frequency stability is the ability of the transmitting equipment to maintain a mean test frequency.

6.2.2 Method of Measurement

After a warm-up period of one hour at rated AC input voltage, measure the frequency of the carrier at one minute intervals during a period of fifteen minutes. From these measurements, determine a mean test frequency. Then, measure and record the operating frequency at a temperature of 5°C at 85, 100 and 115% of the rated AC supply voltage. Repeat for a temperature of 45°C .

Where it is not practical to subject the complete transmitting equipment to the specified test conditions, it is permissible to isolate and separately measure the stability of the frequency-determining elements of the transmitting equipment under the specified conditions.

6.2.3 Standard

The frequency of the carrier shall remain within ± 1 kHz of the mean test frequency.

Method of Measurements: ANSI C63.26 5.6

Applicant: BEI ELECTRONICS, LLC
FCC ID: DDEETG500
IC: 131A-ETG500
Report: 212UT20TestReport_Rev2

Test Data: FCC Frequency Stability Table

FCC Part 73 Limit	2	+/- kHz	
FCC Part 73 Lower Limit	98.098008	MHz	
FCC Part 73 Upper Limit	98.102008	MHz	
Rated Supply Voltage	110.0	<input checked="" type="radio"/> AC <input type="radio"/> DC	
Temperature / Voltage Variation			
Temperature (°C)	Supplied Voltage (V)	Frequency (MHz)	Deviation (kHz)
0	110.0	98.099995	0.013
+10	110.0	98.099997	0.011
+20 (reference)	110.0	98.100008	0.000
+20	93.5	98.100008	0.000
+20	126.5	98.100008	0.000
+30	110.0	98.100004	0.004
+40	110.0	98.099996	0.012
+50	110.0	98.099991	0.017

Test Data: FCC Frequency Stability Plot

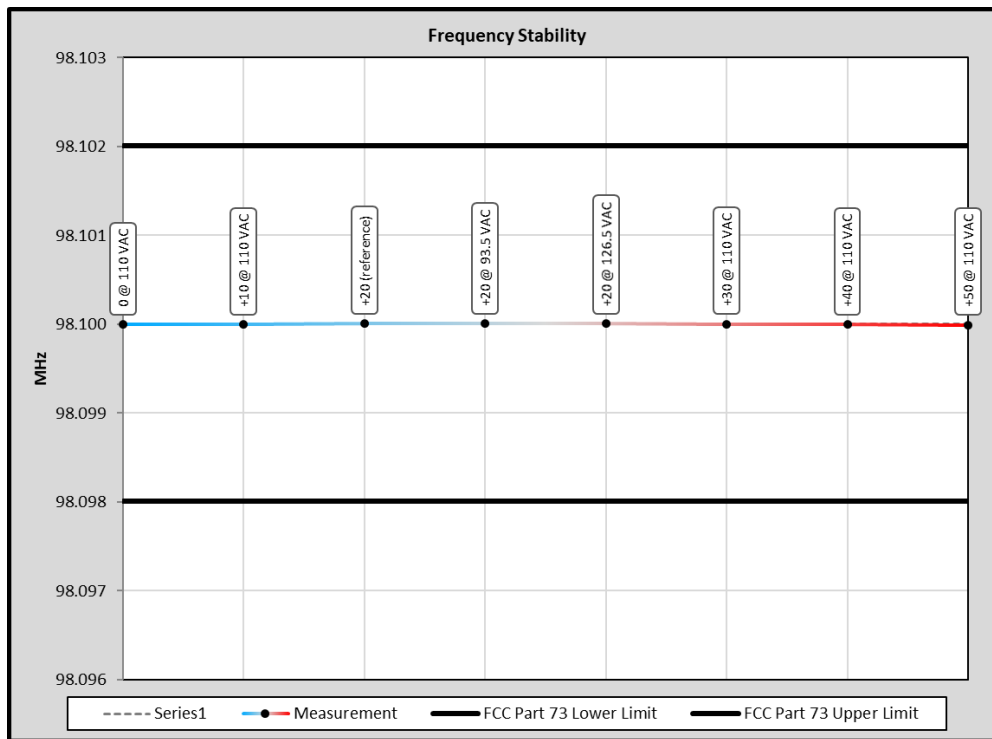

Test Data: IC Frequency Stability Table

BETS-6 Limit	1	+/- kHz
BETS-6 Lower Limit	98.098995	MHz
BETS-6 Upper Limit	98.100995	MHz
Rated Supply Voltage	110.0	<input checked="" type="radio"/> AC <input type="radio"/> DC
Temperature / Voltage Variation		
Temperature (°C)	Supplied Voltage (V)	Frequency (MHz)
+20 (reference)	110	98.099995
+5	94	98.099997
+5	110	98.099997
+5	127	98.099997
+45	94	98.099996
+45	110	98.099996
+45	127	98.099996

Test Data: IC Frequency Stability Plot

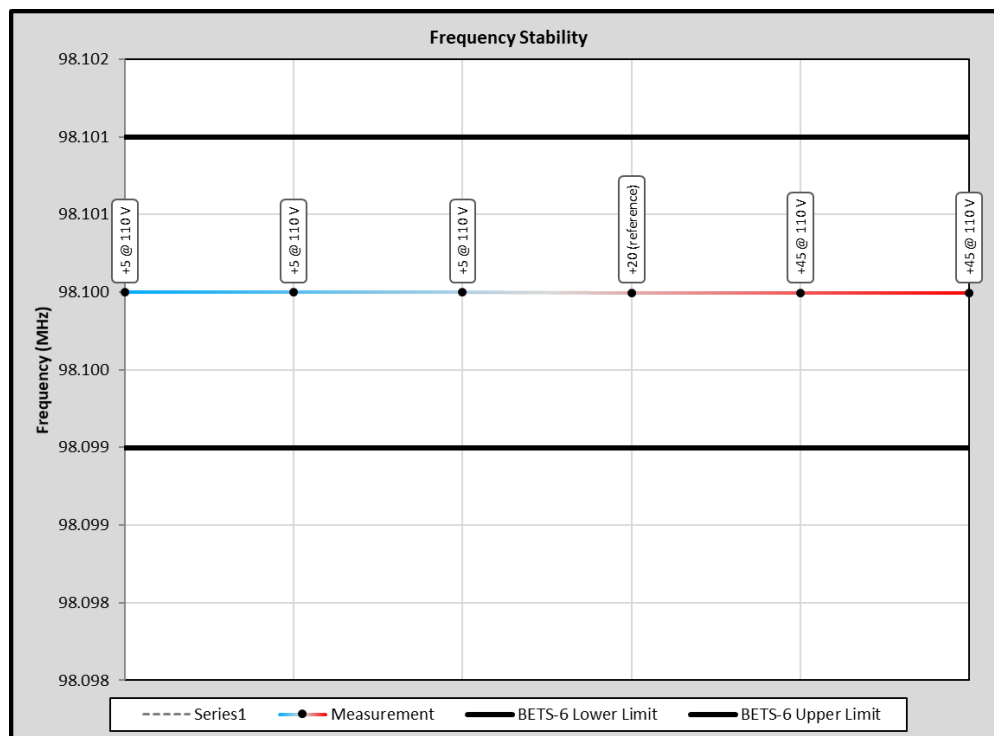

STATE OF THE MEASUREMENT UNCERTAINTY

The data and results referenced in this document are true and accurate. The measurement uncertainty was calculated for all measurements listed in this test report according to CISPR 16-4 or ENTR 100-028 Specification for radio disturbance and immunity measuring apparatus and methods – Part 4: “Uncertainty in EMC Measurements” and is documented in the Timco Engineering, Inc. quality system according to DIN EN ISO/IEC 17025. Furthermore, component and process variability of devices similar to that tested may result in additional deviation. The manufacturer has the sole responsibility of continued compliance of the device.

Hereafter the best measurement capability for Timco Engineering, Inc. is reported:

This uncertainty represents an expanded uncertainty expressed at approximately the 95% confidence level using a coverage factor of $k=1.96$.

Test Items	Measurement Uncertainty	Notes
RF Frequency Accuracy	± 49.5 Hz	(1)
RF Conducted Power	± 0.93 dB	(1)
Conducted spurious emission of transmitter valid up to 40GHz	± 1.86 dB	
Occupied Bandwidth	± 2.65 %	
Audio Frequency Response	± 1.86 dB	
Modulation limiting	± 1.88 %	
Radiated RF Power	± 1.4 dB	
Maximum frequency deviation: Within 300 Hz and 6 kHz of audio freq. Within 6 kHz and 25 kHz of audio freq.	± 1.88 % ± 2.04 %	
Rad Emissions Sub Meth up to 26.5GHz	± 2.14 dB	
Rad Emissions Sub Meth up to 18-40 GHz	± 2.04 %	
Adjacent channel power	± 1.47 dB	(1)
Intermodulation - Tx	± 2.07 dB	
Noise Figure	± 1.00 dB	
Transient Frequency Response	± 1.88 %	
Temperature	± 1.0 °C	(1)
Humidity	± 5.0 %	
Radiated Emissions to 6.0GHz	± 4.4 dB	
Power line conducted emissions	± 3.9 dB	

(1) This uncertainty represents an expanded uncertainty expressed at approximately the 95% confidence level using a coverage factor of $k=1.96$.

EQUIPMENT LIST

Device	Manufacturer	Model	Serial Number	Cal/Char Date	Due Date
Antenna: Biconical 1096	Eaton	94455-1	1096	08/01/17	08/01/20
Antenna: Log-Periodic 1122	Electro-Metrics	LPA-25	1122	07/26/17	07/26/19
Temperature Chamber LARGE	Tenney Engineering	TTRC	11717-7	N/A	N/A
Frequency Counter	HP	5385A	2730A03025	11/08/17	11/08/19
CHAMBER	Panashield	3M	N/A	07/11/18	07/11/20
Sweep/Signal Generator	Anritsu	68369B	985112	11/08/17	11/08/19
Antenna: Double-Ridged Horn/ETS Horn 2	ETS-Lindgren	3117	00041534	03/01/17	03/01/19
Software: Field Strength Program	Timco	N/A	Version 4.10.7.0	N/A	N/A
Type K J Thermometer	Martel	303	080504494	11/06/17	11/06/19
Modulation Analyzer	HP	8901A	3050A05856	04/13/17	04/13/19
EMI Test Receiver R & S ESU 40 Chamber	Rohde & Schwarz	ESU 40	100320	08/28/18	08/28/20
Coaxial Cable - Chamber 3 cable set (Primary)	Micro-Coax	Chamber 3 cable set (Primary)	KMKM-0244-01; KMKM-0670-00; KFKF-0198-01	08/09/16	08/09/19
Function Generator	Standford	DS340	25200	02/21/18	02/21/20
Terminator N 20W DC-18G	Narda	8205	#14	04/06/17	04/06/19
Non Radiating 50 OHM Load	Tenuline	8329-300		02/01/18	02/01/21
Bore-sight Antenna Positioning Tower	Sunol Sciences	TLT2	N/A	N/A	N/A

*EMI RECEIVER SOFTWARE VERSION

The receiver firmware used was version 4.43 Service Pack 3

END OF REPORT

Applicant: BEI ELECTRONICS, LLC
 FCC ID: DDEETG500
 IC: 131A-ETG500
 Report: 212UT20TestReport_Rev2