



ETG2000.20
ETG1000.10
ETG500.5
ETG150
ETG 20

FM SOLID STATE TRANSMITTER WITH AUDIO CHANGEOVER OPTION

Rev. 01 – 26/06/2018
Cod. MAN1046UUK

ELENOS
World Broadcast Experience

USER MANUAL



World Broadcast Experience

Operative Office: via G. Amendola 9,
44028 Poggio Renatico (Fe) ITALY
C.C.I.A.A. 101 216, C.Fisc. e P.IVA IT00415540384



UNI EN ISO 9001:2008 certified company
Certificate No.102222A

We kindly remind you to register your product on <http://www.elenos.com/product-registration/>

For further information and help please contact the Customer Service:

Elenos

Ph : +39 0532 829965
Fax : +39 0532 829177
E-mail : info@elenos.com
Internet web site : www.elenos.com

Elenos USA

2561 NW 74th Ave, Unit A-16, 33122 Miami (Florida), Ph +1 855-305-3058

We kindly recommend you to fill in the RMA module (ITA <http://www.elenos.com/it/elenos-rma/> o ENG <http://www.elenos.com/elenos-rma/>) and to report the apparatus serial number (available on identification label).



AT	BE	BG	CY	HR	DK	EE
FI	FR	DE	GR	IE	IT	LV
LT	LU	MT	NL	PL	PT	GB
CZ	RO	SK	SI	ES	SE	HU

All copyrights are reserved, you may not reproduce any part of this manual, in any form, without the express written permission of Elenos S.r.l.

All copyrights are reserved, you may not reproduce any part of this manual, in any form, without the express written permission of Elenos S.r.l.

Revision history

no.	Date (dd/mm/yy)	Description
00	01/12/2017	First release
01	26/06/2018	Updated para 6 "Datasheet"

Index

1	Informative letter	7
1.1	Personnel in charge	8
1.2	Warranty	8
1.3	Exclusion	9
1.4	Exemption from liability	9
2	Safety	11
2.1	Safety precautions	13
2.2	First aid	15
2.2.1	Treatment of electrical burns	15
2.2.1.1	Extensive burns and skin cuts	15
2.2.1.2	Less severe burns (1st and 2nd degree)	15
2.2.2	Treatment of electric shocks	15
2.2.2.1	If the victim is unresponsive	15
2.2.2.2	If the victim is responsive	16
2.3	Workplace characteristics	16
2.3.1	Room characteristics	16
2.3.2	Electrical system features	16
2.4	Exposure evaluation	18
2.4.1	Calculation in the free space	18
2.4.1.1	Electric field values (V/m) as a function of power (W) and distance.	20
3	CE conformity	21
3.1	CE conformity	23
3.2	Labels	26
3.2.1	Identification label	26
3.2.2	Assistance label	26
3.2.3	Warranty label	26
3.2.4	Serial number label	26
4	Product description	27
4.1	Controls and connections overview	29
4.2	Connectors pin assignment	30
4.2.1	EIA485 – Telemetry – Ethernet – Interlock	30
4.2.2	TC/TS – Profiles	30
4.2.3	Stereo L/R – AES/EBU	31
4.2.4	Aux1 – Aux2 – MPX – MPX Monitor	31
4.2.5	RF Monitor	31
4.2.6	Line Input – Grounding	31
4.3	Safeness algorithms	32
4.3.1	Software's protections	32
4.3.1.1	IPF (Intelligent Proportional Foldback)	32
4.3.1.2	IPC (Intelligent Power Control)	32

Index

4.3.1.3	Safety Management (“Lifextender”)®	32
5	Block diagrams	35
5.1	Block diagram	37
5.1.1	ETG 2000.20	37
5.1.2	ETG 1500.15 / ETG 1000.10	38
5.1.3	ETG 700.7 / ETG 500.5 / ETG 300.3 / ETG 150	39
5.1.3	ETG 20	39
6	User instructions	41
6.1	User interface	43
6.1.1	Menu tree	44
6.1.2	TX Control Panel (Main Window)	45
6.1.3	System Menu → System Config (1 of 2 and 2 of 2)	46
6.1.4	System Menu → Communication Port Set / System Info	47
6.1.5	System Menu → System Time / Clock Pwr Target 1 of 2	48
6.1.6	System Menu → Clock Pwr Target 2 of 2 / Telemetry Config	49
6.1.7	Inputs Menu → Base Band Levels / Change Over Inputs	50
6.1.8	Inputs Menu → Input Sensitivity Settings	51
6.1.9	RF & PWR Menu → View TX Parameters (1 of 2 and 2 of 2)	52
6.1.10	Password Menu → Password / Password Setting	53
6.1.11	Password Menu → Password Recovery	54
6.1.12	Alarm Menu → Alarm List / Event History	55
6.1.13	Alarm Menu → User Alarm Data / User Alarms Timers	56
6.1.14	Alarm Menu → Audio Trim and Alarms	57
6.1.15	Diagnostic Menu → UART 0 Info / UART 1 Info	58
6.1.16	Diagnostic Menu → UART 2 Info	59
6.2	Alarms/Warnings/Status list	61
6.3	External connectable devices	65
6.3.1	Connecting to a LAN/PC	65
6.3.2	Connecting to a Change Over/Audio Matrix	66
7	Datasheet	67
7.1	Datasheet	68
8.1.1	Individual models specific parameters	70
7.2	ETG models layouts	71
7.2.1	ETG 2000.20	71
7.2.2	ETG 1500.15	72
	ETG 1000.10	72
7.2.3	ETG 700.7 / ETG 300.3 / ETG 500.5 / ETG 150	73
7.2.4	ETG 20	74
8	Maintenance	75
8.1	Maintenance	76
8.1.1	Periodic checks and replacements	76

This page intentionally blank

1 Informative letter

1	Informative letter	7
1.1	Personnel in charge	8
1.2	Warranty	8
1.3	Exclusion	9
1.4	Exemption from liability	9

Dear Customer,

Thank you for choosing an Elenos product.

ELENOS s.r.l. produces solid state VHF/FM sound broadcasting transmitters ranging from minimum power of 10W to maximum power of 30kW, exchange units, remote control units, etc.

The equipment has been produced to ensure constant performance over time as long as periodical controls and essential maintenance works are carried out as required.

However, before attempting any kind of operation an accurate reading of this manual and of all relevant documentation attached is recommended to the user.

ELENOS s.r.l. Management

WARNING

This device can only be used by holders of all the authorizathion provided by the competent Authorities of the specific country.

Elenos s.r.l.

1.1 Personnel in charge

This manual has to be intended as an integral part constituting the equipment, and **must be readily at hand to all the personnel responsible for its installation, use and maintenance.**

The installation, use and maintenance of the device concerned in this case must be permitted exclusively to properly trained and qualified personnel, who must have received the appropriate training on the use of the equipment and who are aware of every possible risk occurring when operating with devices connected to dangerous voltage electrical networks, operating with high internal voltages and generating high radiofrequency output power.

This manual does not claim to be a comprehensive collection of safety standards required for the use of the equipment.

However, **the user and the maintenance technician are required to know the content of these manual** and of all its connected attachments.

This equipment must be used only by holders of governmental licenses and/or ministerial authorizations only.

1.2 Warranty

The products sold to the Customer by Elenos Srl are covered by a 24-month warranty starting from the FOB date of shipment from Elenos Srl site; this warranty is granted both to the Customer and to any other possible subsequent purchaser of the product and covers any kind of fault caused by defective components of the product itself, as long as it is maintained in an excellent controlled condition. It is essential to the effective coverage of the warranty issued by Elenos Srl the registration of the product by the Customer through the web site www.elenos.com/product-registration/.

In case the Customer detects a failure under warranty, he must give immediate written notice to Elenos Srl and send the product at his own expense to the Elenos Srl headquarter or to the nearest qualified Elenos Srl centre; in case of shipment to its headquarter, the latter agrees to replace within the next 45 days for free the defective component; in case of shipment to a qualified service Elenos Srl, the latter shall refund the cost of the intervention on the faulty component on the basis of a fixed and agreed tariff in advance between the customer and Elenos Srl. If the product purchased by the customer forms part of the so-called products "Reduced mobility" (weight higher than Kg. 50 (110lb), the maintenance or replacement of the defective component will be in the place where the equipment is located and will be done by the technicians of the closer technical center qualified by Elenos Srl. All this after the evaluation by a technician designated from Elenos on the presence of a case of exclusion from the guarantee.

For details, please consult the Terms and Conditions documents.

1.3 Exclusion

The customer expressly accepts the exclusion from the terms of Elenos Srl warranty's coverage all damages caused by electrical discharges (lighting) and incorrect power supply voltages, as well as by the Customer's negligence, carelessness or unskillfulness, or by unauthorized staff maintenance operations or by replacements of original parts of the equipment with new systems or spare parts not directly supplied by Elenos Srl or by its authorized distributors, or by a use of the product other than those intended for the same product, or from any action or fact attributed to third parties who have access to the product for the same Customer's approval or even without the Customer being aware thereof after that the latter has received the delivery of the products.

The warranty expressly excludes coverage for damages caused by fires, floods, or other natural disasters, wars, revolts, as well as in all cases the equipment becomes the material object of a crime.

The warranty is also expressly excluding coverage for damages occurred after the delivery of the equipment by Elenos Srl to the carrier, being the Customer responsible for any risk related to the transport, since its time-frames, costs and methods are chosen and covered by the same Customer.

1.4 Exemption from liability

The customer is responsible for installation, maintenance and control products, as well as verification that the climatic and environmental conditions, in which the products are placed, are suitable for their use and do not affect the operation. All in observance of Elenos Srl's manual attached to the product purchased, that must be the reference for the customer to require validly and effectively the replacement or repair under warranty. Conversely, if the customer fails to observe the precepts contained in the instruction manual, as well as the minimum care required to the normal user of such equipment, the guarantee granted by Elenos Srl will not operate and the customer himself will totally assume the risk of any damages occurred to the products.

Elenos Srl reserves the right to make possible changes to parts, details and accessories that may be considered opportune to be done for the improvement of the equipment, or to meet the needs connected to constructive and commercial requirements, in any moment, without prior notice of it and without committing to upgrade immediately this manual.

For details, please consult the Terms and Conditions documents.

This page intentionally blank

2 Safety

2	Safety	11
2.1	Safety precautions	13
2.2	First aid	15
2.2.1	Treatment of electrical burns	15
2.2.1.1	Extensive burns and skin cuts	15
2.2.1.2	Less severe burns (1st and 2nd degree)	15
2.2.2	Treatment of electric shocks	15
2.2.2.1	If the victim is unresponsive	15
2.2.2.2	If the victim is responsive	16
2.3	Workplace characteristics	16
2.3.1	Room characteristics	16
2.3.2	Electrical system features	16
2.4	Exposure evaluation	18
2.4.1	Calculation in the free space	18
2.4.1.1	Electric field values (V/m) as a function of power (W) and distance.	20

This page intentionally blank

All ELENOS s.r.l products are compliant with the safety standards required for this type of equipment.

2.1 Safety precautions

The user must follow also the safety precautions listed below:

- The original configuration of the equipment must absolutely not be modified. On receipt of the same equipment it is essential to check whether the supply is compliant with the order's specific terms and in case of nonconformities please report it immediately Elenos Srl.
- Protective devices must not be disconnected (with exception of their replacement), altered or modified without authorization.
- Check all protective devices periodically after the occurrence of a fault (e.g. devices against excess voltage, against excess currents, circuit breakers, etc.).
- To guarantee safety of the personnel and to protect the equipment from damages it is absolutely forbidden to put it into operation and/or to use it while the doors are open and/or without the partial or whole presence of protection panels and/or without grounding connection, which must always be of extremely high quality and in accordance with regulations in force. It is also forbidden to disconnect and/or to alter the equipment's means of protection.
- Before starting any operation, the equipment must be disconnected from the mains. Disconnection must be verified via visual inspection.
- The equipment must be powered exclusively with the appropriate voltage. An incorrect power voltage can cause irreparable damages to the equipment and to the personnel working with it. This same information is reported on the product's nameplate, which is generally located upon its casing. In no case must the name plate be removed, even if the equipment is resold.
- The equipment must be powered by an electrical system which is compliant with the regulations in force.
- On the equipment can be found further pictograms reporting safety warnings that must be carefully followed by anyone that has to work with it. The lack of respect for rules here described exempts the Constructor from all liability for all possible damages or accidents occurring to persons or property and place responsibility to the user himself.

Hazardous voltage



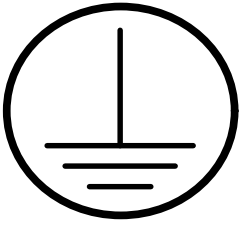

The equipment is directly connected to the “building installation”

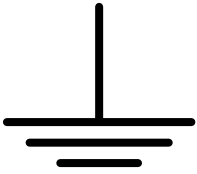

Between the equipment and the “building connection” there is an interposed structure

- To ensure a correct use of the equipment do not obstruct the ventilation grids. Do not put the equipment close to heat sources, flammable products, or inside closed installations lacking of a proper air circulation.
- It is required to observe general and firefighting rules for the place hosting the equipment.
- Avoid any liquid contamination to the equipment. Always disconnect power supply to the equipment before carrying out any cleansing operations. Do not use liquid or spray detergents.
- Some components contain TOXIC SUBSTANCES, such as for example BERYLLIUM OXIDE. Please be aware that in some countries rules for storing and disposing of hazardous materials may apply.
- Following a visual check, if any component seems damaged, fractured or not intact, the utmost care must be taken when coming in physical contact through hands or other means with the equipment.
- Please ensure that any person in charge of the use or the maintenance of a transmitter presenting one or more parts under hazardous voltage is able to perform artificial respiration and cardiac massage; all the staff must be trained on how to provide first medical aid in case of emergency. It is strongly advised to hang in a visible position an informative panel reporting clear instructions regarding first aid's procedures for the rescue of people injured in a work accident and to supply rooms where electrical equipment is present with first aid kits. It is strongly advised to organize an intervention plan in order to ensure a quick connection with local public or private first aid institutions so to be easily available for all the people hosted within the site.

2.2 First aid



This paragraph does NOT represent a complete guide about first aid procedures, it is rather intended as a brief summary to be used as a reference. It must be in fact an impelling duty for all the personnel operating with this equipment to be capable of performing appropriate first aid procedures in order to prevent avoidable deaths.

2.2.1 Treatment of electrical burns

2.2.1.1 Extensive burns and skin cuts

- Cover the area with a clean sheet or cloth.
- Do not break blisters, not remove tissue, not remove adhered particles of clothing, or apply any ointment.
- Treat the victim accordingly to the type of shock suffered.
- Arrange transportation to a hospital as quickly as possible.
- If arms and legs are injured, keep them raised.

WARNING:

If medical aid is not available within one hour and if the victim is conscious and if it does not present retching problems, administer a salt and soda liquid solution to be drank: 1 full teaspoon of salt and half teaspoon of sodium bicarbonate for every 250 ml (8.5 oz) of tepid water, let the victim sip this solution slowly, for about four times (1/2 glass over a period of 15 minutes passing).

Stop this operation if retching problems occur. Do not administer alcoholic solutions.

2.2.1.2 Less severe burns (1st and 2nd degree)

- Apply on the burns cool (not ice-cold) gauze compresses using the cleanest available cloth.
- Do not break blisters, not remove tissue, not remove adhered particles of clothing, or not apply any ointment.
- If necessary, put on clean and dry clothes
- Treat the victim accordingly to the type of shock suffered.
- Arrange transportation to a hospital as quickly as possible.
- If arms and legs are injured, keep them raised.

2.2.2 Treatment of electric shocks

2.2.2.1 If the victim is unresponsive

Place victim flat on his back on a hard surface

A) Airways (fig. a):

- if the victim is unresponsive open the victim's airways
- push the victim's forehead backwards
- open the victim's mouth if necessary
- check the victim's breathing



fig.a

B) Artificial respiration (fig. b):

- if the victim cannot breathe, perform artificial respiration
- incline the victim's head backwards
- close the victim's nostrils
- place your mouth on the victim's mouth
- perform 4 quick blows
- remember to start breathing immediately



fig.b

fig.c1

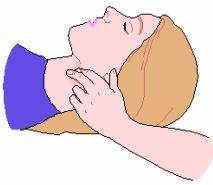

fig.c2



fig.c3



C) Circulation (fig. c1):

- check the victim's pulse (fig. c1)
- if absent, start cardiac massage (fig. c2)
- compress the chest every 1.5 – 2 seconds
- if a rescuer is present, perform 15 compressions in approximately 80 seconds, + 2 quick blows
- if there are two rescuers, perform 5 compressions in approximately 60 seconds, + 1 quick blow (fig. c3)

WARNING:

Do not interrupt the rhythm of compressions when the second person is performing artificial respiration.

2.2.2.2 If the victim is responsive

- cover the victim with a blanket
- keep them as calm as possible
- loosen their clothing and place them in a reclining position

WARNING:

CALL FOR MEDICAL ASSISTANCE AS SOON AS POSSIBLE IN ALL CASES

2.3 Workplace characteristics

2.3.1 Room characteristics

In order to work freely on the equipment and to be able to perform the relative installation or maintenance operations, it is necessary to keep a minimum distance from the walls on all sides of the machine.

The room must be equipped with an appropriate system of clean and dust-filtered air ventilation with a flow rate suitable for the characteristics of the equipment operating in the room itself.

Outgoing exhausted air must be conveyed directly outside. If the duct's length or size is such to presume it may be causing a consistent loss of load to the air flow rate it is necessary to add an extraction apparatus. At the conveyor's outlet intrusion protection devices must be provided against insects or other kinds of animals and suitable precautionary measures against liquid or other materials intrusion must be applied.

The equipment can operate properly if the temperature ranges from -5°C to $+45^{\circ}\text{C}$ (23°F to 113°F), with 95% RH non-condensing at $+40^{\circ}\text{C}$ (104°F).

2.3.2 Electrical system features

The electrical network installation has to be set in accordance with the regulations in force. The power supply network must allow an appropriate power provision according to the laws in force in the Country of installation on the quality of the electrical energy supply service.

It is highly recommended to use a transformer/network separator and a reduction network for discharging high voltage.

Provide a protected under load disconnecter (circuit breaker or fuses) with appropriate disconnection power and capacity according to the absorption characteristics of the equipment model.

Use cables of an appropriate size with respect to the rated absorbed current.

Earth connection must be performed according to the applicable laws.

Special care must be applied to the earth connection of the antenna system since it is exposed to electrical atmospheric events.

Never forget that despite the earth connection of the equipment frame and the whole antenna system, it is always dangerous to operate on the equipment in the event of bad weather with atmospheric discharge. In fact, in the event of high energy discharge (lightning), the equipment frame can instantly reach very dangerous voltage levels, due to the earth connection inductance.

For this reason, the equipment should be installed in rooms accessible to maintenance personnel only and for the time necessary for repairs and checks only.

2.4 Exposure evaluation

Exposure assessment requires the identification of electric field values in places where the presence of people may occur.

The field values must refer to the type of stay and the exposed subjects, according to the provisions of current legislation.

The identification of the electric field values can be carried out in various ways, depending on the need for precision and the fact that one intends to perform a prediction, or a subsequent verification.

We intend to provide below elements that may be useful in the evaluation and measurements of electromagnetic fields, with particular reference to sound and television broadcasting systems.

2.4.1 Calculation in the free space

A first approximate evaluation can be made by placing the following hypotheses:

- i) source located in far field
- ii) absence of obstacles

The first hypothesis (i) must be previously verified by applying the equation:

1.
$$d \geq \frac{D}{\lambda}$$

where “d” represents the distance between source and evaluation point, “D” the physical dimension of the source and “λ” the wavelength of the field.

Under these hypotheses, the electric field at distance “d” from the source is:

2.
$$E = \sqrt{P_r \eta} = \sqrt{\frac{P_t}{4\pi d^2} \eta}$$

where “Pt” is the power transmitted (ERP) in the direction of the evaluation point.

Introducing the polarization of the electric field, impressed by the particular type of antenna used in transmission, the relation 2 must be applied to the three components Ex, Ey, Ez of the field; the expression of the total electric field becomes:

3.
$$E = \sqrt{E_x^2 + E_y^2 + E_z^2}$$

In the specific case of broadcasting plants for sound and television broadcasting, the following recurrent characteristics can be found:

- a. the source is not isotropic, so the ERP should be calculated in the direction of the evaluation point
- b. in the case in which the worst case of exposure is concerned, it can be applied the expression 2 in which the maximum transmitted ERP power is considered, regardless of the direction, ignoring the radiation characteristics of the antenna system in the horizontal and vertical plane
- c. the polarization of the field is almost always vertical in the case of systems for sound broadcasting, while it can be vertical, horizontal or mixed in the case of television broadcasting. In all cases, the decomposition of the power transmitted in the various polarization components and the subsequent recombination by means of formula 3 allows, firstly, to disregard the polarization of the field and to directly apply the expression 2
- d. in the case of multiple sources, the total expression

4.
$$E_{totN} = \sqrt{E_{tot1}^2 + E_{tot2}^2 + E_{toti}^2 + E_{totm}^2}$$

The following table gives an indication of the first approximation of the field value as a function of the power (in W) transmitted by the source and distance (in meters); the values shown (all in V/m) represent the worst case (see point)

2.4.1.1 Electric field values (V/m) as a function of power (W) and distance.

Power transmitted by the source (ERP) in Watts	Distance from the source of the evaluation point								
	30m 98.4ft	50m 164ft	100m 328ft	300m 984ft	500m 1,640ft	1,000m 3,280ft	3,000m 9,840ft 1.864mi	5,000m 16,400ft 3.107mi	10,000m 32,800ft 6.214mi
1	0.18	0.11	0.05	0.02	0.01	--	--	--	--
30	1.00	0.60	0.30	0.10	0.06	0.03	--	--	--
50	1.29	0.77	0.39	0.13	0.08	0.04	0.01	--	--
100	1.82	1.09	0.55	0.18	0.11	0.05	0.02	0.01	--
300	3.16	1.90	0.95	0.32	0.19	0.09	0.03	0.02	0.01
500	4.08	2.45	1.22	0.41	0.24	0.12	0.04	0.02	0.01
1,000 (1k)	5.77	3.46	1.73	0.58	0.35	0.17	0.06	0.03	0.02
3,000 (3k)	10.00	6.00	3.00	1.00	0.60	0.30	0.10	0.06	0.03
5,000 (5k)	12.91	7.74	3.87	1.29	0.77	0.39	0.13	0.08	0.04
10,000 (10k)	18.25	10.95	5.48	1.82	1.09	0.55	0.18	0.11	0.05
30,000 (30k)	31.62	18.97	9.49	3.16	1.90	0.95	0.32	0.19	0.09
50,000 (50k)	40.82	24.49	12.25	4.08	2.45	1.22	0.41	0.24	0.12
100,000 (100k)	57.73	34.64	17.32	5.77	3.46	1.73	0.58	0.34	0.17
300,000 (300k)	100.00	60.00	30.00	10.00	6.00	3.00	1.00	0.60	0.30
500,000 (500k)	129.10	77.46	38.73	12.91	7.74	3.87	1.29	0.77	0.39
1,000,000 (1M)	182.57	109.54	54.77	18.26	10.95	5.48	1.82	1.09	0.55

Note: field values above 6V/m are highlighted in yellow; those ones that exceed 20V/m are highlighted in red.

Note: RF EXPOSURE SAFETY DISTANCE (only for FCC) RF Exposure Limits for United States of America, according to FCC regulation: setting to the maximum of the output power of the apparatus, to guarantee the limits of exposure declared within this document, it is necessary that the antenna gain used with persons should maintain a minimum separation distance of 656.74 cm for general uncontrolled exposure and general controlled exposure.

RF Exposure Limits for Canada, according to IC regulation: setting to the maximum of the output power of the apparatus, to guarantee the limits of exposure declared within this document, it is necessary that the antenna gain used with this device should be 0dBi or less and all persons should maintain a minimum separation distance of 817.42 cm for general uncontrolled exposure and general controlled exposure.

Limites d'exposition RF: en réglant au maximum de la puissance de sortie de l'appareil, afin de garantir les limites d'exposition déclarées dans ce document, il est nécessaire que le gain d'antenne utilisé avec cet appareil doit être de 0 dBi ou moins et toutes les personnes doivent conserver une distance de séparation minimale de 817.42 cm pour les expositions générales non contrôlées et les expositions générales contrôlées. this device should be 0dBi or less and all

3 CE conformity

3	CE conformity	21
3.1	CE conformity	23
3.2	Labels	26
3.2.1	Identification label	26
3.2.2	Assistance label	26
3.2.3	Warranty label	26
3.2.4	Serial number label	26

This page intentionally blank

3.1 CE conformity

For first immission on the market, **ELENOS s.r.l respects the procedures envisaged by the 1999/5/EC Directive.**

This includes the following:

- Technical documentation available exclusively to the Control Authority for 10 years after the launch on the market of the last equipment produced for that type.
Such documentation contains the product description, the drawings, the electrical diagrams, circuits, etc., the standards to which it complies and the list of technical solutions guaranteeing observance and the reports of the technical tests performed, proof of respect for production standards.
- Declaration of Conformity – supplied with the product.
- CE marking indicated on the product and on the documentation.
- Written technical report from the European Notified Body, contained in the Technical File.
- Notification to the Authority of the member states where the product will be distributed.

EC Declaration of Conformity

According to Directive 1999/5/EC (R&TTE)



We : ELENOS s.r.l. - via G.Amendola, 9 – 44028 Poggio Renatico (FE) - Italy

Declare under our sole responsibility that the product:

ETG 2000.3, ETG 1900.3, ETG 1800.3, ETG 1700.3, ETG 1600.3, ETG 1500.3, ETG 1400.3, ETG 1200.3, ETG 1000.3, ETG 900.3, ETG 800.3, ETG 700.3, ETG 600.3, ETG 500.3, ETG 400.3, ETG 300.3, ETG 250.3, ETG 200.3, ETG 150.3, ETG 100.3

ETG 1400.2, ETG 1200.2, ETG 1000.2, ETG 900.2, ETG 800.2, ETG 700.2, ETG 600.2, ETG 500.2, ETG 400.2, ETG 300.2, ETG 250.2, ETG 200.2, ETG 150.2, ETG 100.2, ETG 80.2

ETG 800.1, ETG 700.1, ETG 600.1, ETG 500.1, ETG 400.1, ETG 300.1, ETG 250.1, ETG 200.1, ETG 150.1, ETG 100.1, ETG 80.1, ETG 50.1,

ETG 150, ETG 100, ETG 80, ETG 50, ETG 40, ETG 30, ETG 20, ETG 10

ETG 2000.20, ETG 1900.20, ETG 1800.20, ETG 1700.20, ETG 1600.20, ETG 1500.20, ETG 1400.20, ETG 1200.20, ETG 1000.20, ETG 900.20, ETG 800.20, ETG 700.20, ETG 600.20, ETG 500.20, ETG 400.20, ETG 300.20, ETG 250.20, ETG 200.20, ETG 150.20, ETG 100.20

ETG 1500.15, ETG 1400.15, ETG 1200.15, ETG 1000.15, ETG 900.15, ETG 800.15, ETG 700.15, ETG 600.15, ETG 500.15, ETG 400.15, ETG 300.15, ETG 250.15, ETG 200.15, ETG 150.15, ETG 100.15, ETG 80.15

ETG 1000.10, ETG 900.10, ETG 800.10, ETG 700.10, ETG 600.10, ETG 500.10, ETG 400.10, ETG 300.10, ETG 250.10, ETG 200.10, ETG 150.10, ETG 100.10, ETG 80.10

ETG 700.7, ETG 600.7, ETG 500.7, ETG 400.7, ETG 300.7, ETG 250.7, ETG 200.7, ETG 150.7, ETG 100.7, ETG 80.7, ETG 50.7

ETG 500.5, ETG 400.5, ETG 300.5, ETG 250.5, ETG 200.5, ETG 150.5, ETG 100.5, ETG 80.5, ETG 50.5

ETG 300.3, ETG 250.3, ETG 200.3, ETG 150.3, ETG 100.3, ETG 80.3, ETG 50.3

With intended purpose: VHF FM broadcast transmitters

And manufactured by: ELENOS s.r.l.

To which this declaration relates is in conformity with the essential requirements and other relevant requirements of the R&TTE Directive (1999/5/CE).

The product is in conformity with the following standards and/or other normative documents:

Health and safety requirements pursuant to Article 3.1.a

Standards applied: EN60215: 1989/A1:1992/A2:1994

Protection requirements concerning electromagnetic compatibility pursuant to article 3.1.b

Standards applied: EN301 489-1 V 1.8.1 ; EN301 489-11 V 1.3.1;

Measures for the efficient use of the radio frequency spectrum pursuant to article 3.2

Standards applied: EN302 018-2 V1.2.1

Supplementary information :

Notified body involved: Nemko AS

Technical file held by : Elenos s.r.l and Nemko AS

Place and Date: Ferrara My 16, 2011

Responsible person: **Leonardo Busi (Amministratore unico)**
Tel. 439 0532 829965
e.mail : leonardobusi@elenos.com

Signature

AMMINISTRATORE UNICO

This page intentionally blank

3.2 Labels

3.2.1 Identification label

It shows the key features equipment, such as: manufacturing company, product model, power supply type and power consumption. Warning: do not ever remove this label.



3.2.2 Assistance label

It shows the main Elenos customer assistance contacts.



Note: this label may not be present.



3.2.3 Warranty label

Unauthorized removal or tampering of this seal (positioned over the screws) will make void the warranty.



3.2.4 Serial number label

It shows the serial number of the equipment in numeric and barcode format. In addition, a qr-code for the registration is displayed.



4 Product description

4	Product description	27
4.1	Controls and connections overview	29
4.2	Connectors pin assignment	30
4.2.1	EIA485 – Telemetry – Ethernet – Interlock	30
4.2.2	TC/TS – Profiles	30
4.2.3	Stereo L/R – AES/EBU	31
4.2.4	Aux1 – Aux2 – MPX – MPX Monitor	31
4.2.5	RF Monitor	31
4.2.6	Line Input – Grounding	31
4.3	Safeness algorithms	32
4.3.1	Software’s protections	32
4.3.1.1	IPF (Intelligent Proportional Foldback)	32
4.3.1.2	IPC (Intelligent Power Control)	32
4.3.1.3	Safety Management (“Lifextender”)®	32

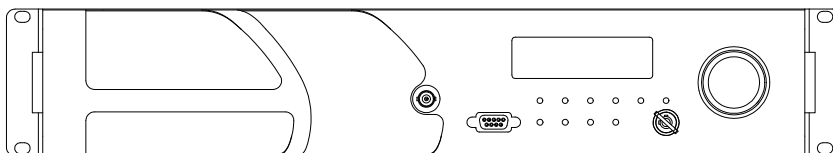

Controls and connectors

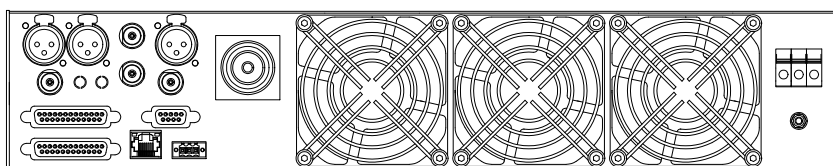

This page intentionally blank

4.1 Controls and connections overview

Below, the list of connections and controls available in all the product line. The differences between the two rear panels shown, concern only the number of fans and the type of RF output connector.

Front panel controls and connections

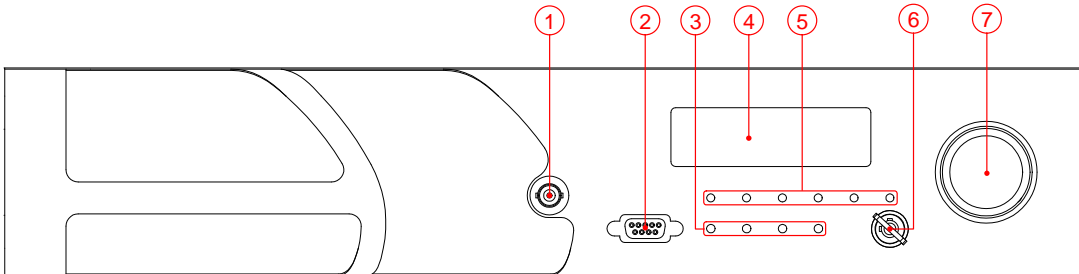

- 1) Rf monitor
- 2) Telemetry
- 3) Pushbuttons
- 4) OLED display
- 5) Status LEDs
- 6) Remote/Local
- 7) Control knob^(encoder)

Rear panel connections

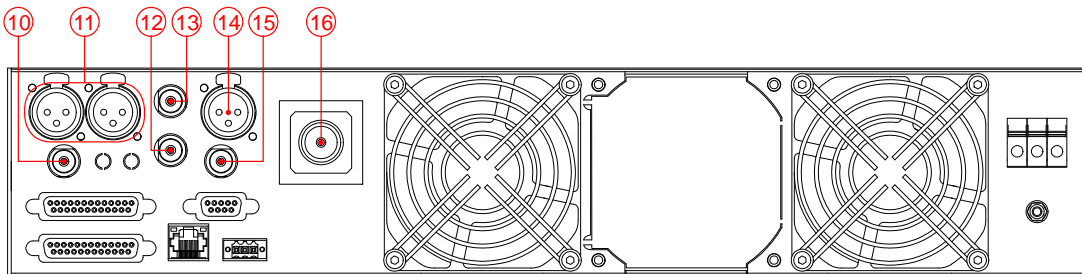

20W to 700W models

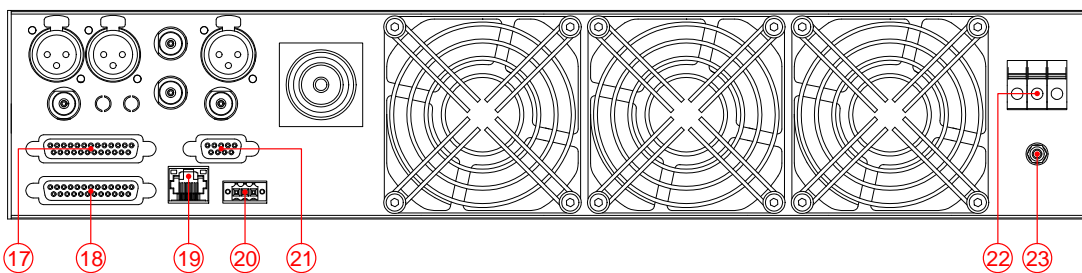

1000W to 2000W models

- 10) Aux2 input
- 11) Stereo inputs
- 12) Aux1 input
- 13) MPX input
- 14) AES/EBU inputs
- 15) MPX Monitor
- 16) RF output
- 17) TC/TS
- 18) Profiles
- 19) Ethernet
- 20) Interlock
- 21) EIA485
- 22) AC line inputs
- 23) Grounding

4.2 Contnetors pin assignment

4.2.1 EIA485 – Telemetry – Ethernet – Interlock

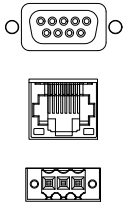

EIA485 (DB9) – Cn no. 21, 2		
Pin. #	Function	Note
1	Tx+	EIA485/422
2	Tx-	EIA485/422
3	Rx+	EIA485/422
4	Rx-	EIA485/422
5	Common	Gnd (frame)
6	Common	Gnd (frame)
7	Common	Gnd (frame)
8	Common	Gnd (frame)
9	Common	Gnd (frame)

Ethernet Connect. (EJ45) – Cn no. 19			
Pin. #	Function	Pin	Function
1	TD+	5	TCT
2	TD-	6	RD-
3	RD+	7	n.c.
4	n.c.	8	RCT
Interlock Connector – Cn no. 20			
Pin. #	Function	Type	Note
1	Common	Gnd	//
2	Float Intlk 1	//	//
3	Float Intlk 2	//	//

4.2.2 TC/TS – Profiles

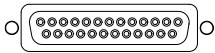

TC/TS Connector (DB25) – Cn no. 17					
Pin. #	Function	Type	Note	Sym	Comment
1	Interlock	TC	Level		Status command Active when grounded
2	Tx On	TC	Pulse(500ms)		Pulse command Active when grounded
3	Tx Off	TC	Pulse(500ms)		Pulse command Active when grounded
4	Ref. Power	DTM	Voltage		0...4V
5	Common	Gnd	//	//	Connected to device frame
6	n.c.	//	//	//	//
7	Exc. Enable	TC	Level		Status command Active when grounded
8	n.c.	//	//	//	//
9	Common	Gnd	//	//	Connected to device frame
10	I IPA	DTM	Voltage		0...4V
11	Mains Fault	TS	Level (O.C.)		Externally powered Open = active fault
12	Tx On	TS	Level (O.C.)		Externally powered Closed = Tx On
13	Warning	TS	Level (O.C.)		Externally powered Open = active warning
14	Alarm Reset	TC	Pulse		Pulse command Active when grounded
15	Low Power	TC	Pulse		Pulse command Active when grounded
16	Rsr Power	TC	Pulse		Pulse command Active when grounded
17	Fwd Power	DTM	Voltage		0...4V
18	Common	Gnd	//	//	Connected to device frame
19	n.c.	//	//	//	//
20	n.c.	//	//	//	//
21	Common	Gnd	//	//	Connected to device frame
22	V IPA	DTM	Voltage		0...4V
23	Audio Fault	TS	Level (O.C.)		Externally powered Grounded = active alarm
24	Fault	TS	Level (O.C.)		Externally powered Open = active alarm
25	Remote	TS	Level (O.C.)		Externally powered Grounded = active alarm

Profiles Connector (DB25)			
Pin. #	Function	Type	Note
1	Channel 1	TC	Pulse
2	Channel 3	TC	Pulse
3	Channel 5	TC	Pulse
4	Spare	TC	Pulse
5	Common	Gnd	//
6	Common	Gnd	//
7	Traffic alert	TC	Level
8	Common	Gnd	//
9	Common	Gnd	//
10	Common	Gnd	//
11	Channel 5	TS	Level
12	Channel 3	TS	Level
13	Channel 1	TS	Level
14	Channel 2	TC	Pulse
15	Channel 4	TC	Pulse
16	Channel 6	TC	Pulse
17	n.c.	//	//
18	Common	Gnd	//
19	Common	Gnd	//
20	Common	Gnd	//
21	Common	Gnd	//
22	Common	Gnd	//
23	Channel 6	TS	Level
24	Channel 4	TS	Level
25	Channel 2	TS	Level

4.2.3 Stereo L/R – AES/EBU

Stereo L/R (XLR) – Cn no. 11			
Pin. #	Function	Type	Note
1	Common	Gnd	//
2	Input L/R +	Bal.	600Ω/10kΩ
3	Input L/R –	Bal.	

AES/EBU (XLR) – Cn no. 14			
Pin. #	Function	Type	Note
1	Common	Gnd	//
2	Input +	Diff.	110Ω
3	Input –	Diff.	



4.2.4 Aux1 – Aux2 – MPX – MPX Monitor

Aux1 + Aux2 – Cn no. 12, 10			
Pin. #	Function	Type	Note
1	Input	Unbal.	10kΩ
2	Common	Gnd	//

MPX Monitor – Cn no. 15			
Pin. #	Function	Type	Note
1	Input	Unbal.	10kΩ
2	Common	Gnd	//

MPX – Cn no. 13			
Pin. #	Function	Type	Note
1	Input	Unbal.	600Ω/5kΩ
2	Common	Gnd	//



4.2.5 RF Monitor

RF Monitor – Cn no. 1			
Pin. #	Function	Type	Note
1	Output	Unbal.	50Ω
2	Common	Gnd	//



4.2.6 Line Input – Grounding

AC Line Input and Grounding – Cn no. 22, 23			
Pin. #	Function	AWG/sqmm	Note
1	Phase	13/2.5 max	100–240Vac
2	Neutral	13/2.5 max	
3	Gnd	13/2.5 max	/
G	Gnd	13/2.5 max	M4

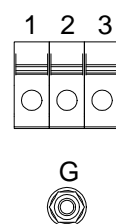

4.3 Safeness algorithms

The apparatus is provided with a hardware and software protective system which is partly integrated and partly optional.

4.3.1 Software's protections

4.3.1.1 IPF (Intelligent Proportional Foldback)

The IPF is an intelligent system which reduces the equipment's output power in case of excess of load mismatch, thus preventing the equipment turning off.

Foldback acts if the load mismatch increases slowly. If the event is fast (examples: a spark into a connector, the detachment of a transmission line, a short circuit and so on), the protection acts quickly.

The activation of this feature is shown on display and via telemetry as alarm no. "026".

4.3.1.2 IPC (Intelligent Power Control)

When the equipment is properly working, the IPC keeps the output power constant within $\pm 1\%$ of the target set, irrespective of mains voltage, temperature and load variations.

This greatly contributes to making the equipment insensitive to its working conditions. The IPC also allows to optimize the efficiency of the RF section by making work the MOSFETs constantly at maximum efficiency, thus minimizing overall electrical consumption.

4.3.1.3 Safety Management ("Lifextender")®

The Safety Management consists of algorithms to perform real-time analysis of the transmitter's operating status. It works in order to maintain the output power set, according to kind and severity of any anomalies (internal or environmental) which may occur.

The Safety Management may perform an output power reduction proportional to the severity of the anomaly that occurs, in order to avoid the propagation of the fault.

The algorithms act at different levels and in various sections of the equipment: Thermal Management on the RF unit; Current Management, Fault Management and Thermal Management on the power supply units; Fault management on the RF unit; Cooling Management on the fans.

Thermal Management on the RF's group (Lifextender)®

When the temperature measured in close proximity to the MOSFET exceeds 72°C, an algorithm intervenes that reduces the output power to a value such as to keep the temperature back within a still acceptable value. If this happens, an alarm of "Rf thermal derating" (no.010) is sent.

If this algorithm does not manage to maintain the temperature below 75°C, the transmitter is switched off.

Current Management on the power supply (Lifextender)®

This is activated when the maximum current rated for continuous operation of the power supply is exceeded. This value is lower than deliverable current limit and represents the threshold which can be exceeded only for short periods (maximum 1 minute each time). If this situation occurs, the “PSU current derating” function is activated (alarm “013” and, if necessary, alarm “014”) and the ALC management algorithm, running in correct working mode, is replaced by another one in which the current delivered by the power supply units has the highest priority in this case and the RF output power derated consequently. The current derating is deactivated when the power delivered rises to the value set by the user and the maximum current provided by the power supply units is less than or equal to the maximum value allowed for continuous operation.

Thermal Management on the power supply (Lifextender)®

The power supply management algorithm that works to maintain the temperature of the power supplies below a safe value is the same that operates in the RF section and is logically connected in “OR” with that the derating (acting directly on the output power) is activated when the power supply temperature exceeds 72°C (162° F).

Fault Management on the RF modules (Lifextender)®

It allows to reduce the maximum RF output power according to the number of correctly working RF amplifier modules, so that they don't could be stressed.

A special algorithm correlates the optimal RF output power with the number of these modules.

To prevent any damage, the fans speed is increased to the maximum value.

Cooling Management on the RF modules (Lifextender)®

In respect to the current cooling requirements, the fan speed rotation is automatically adjusted from a minimum of 50% to a maximum of 120% approx. (these values may change according to the models of used fan). The cooling demand evaluation is based on accurate measurements of the temperature close to each MOSFET and to the power supply units. The Cooling Management aims to:

1. extend the life of the fans;
2. minimize the quantity of dust which can be carried by the air flow;
3. allow the safe operation of the equipment also under extreme temperature conditions;
4. ensure that temperatures of mosfets and power supplies remain as stable as possible to avoid thermal and mechanical stress;
5. reduce the energy consumption when a strong heat extraction is not needed.

Without Lifextender, the fans always operate at 100%.

This page intentionally blank

5 Block diagrams

5	Block diagrams	35
5.1	Block diagram	37
5.1.1	ETG 2000.20	37
5.1.2	ETG 1500.15 / ETG 1000.10	38
5.1.3	ETG 700.7 / ETG 500.5 / ETG 300.3 / ETG 150	39
5.1.3	ETG 20	39

This page intentionally blank

5.1 Block diagram

5.1.1 ETG 2000.20

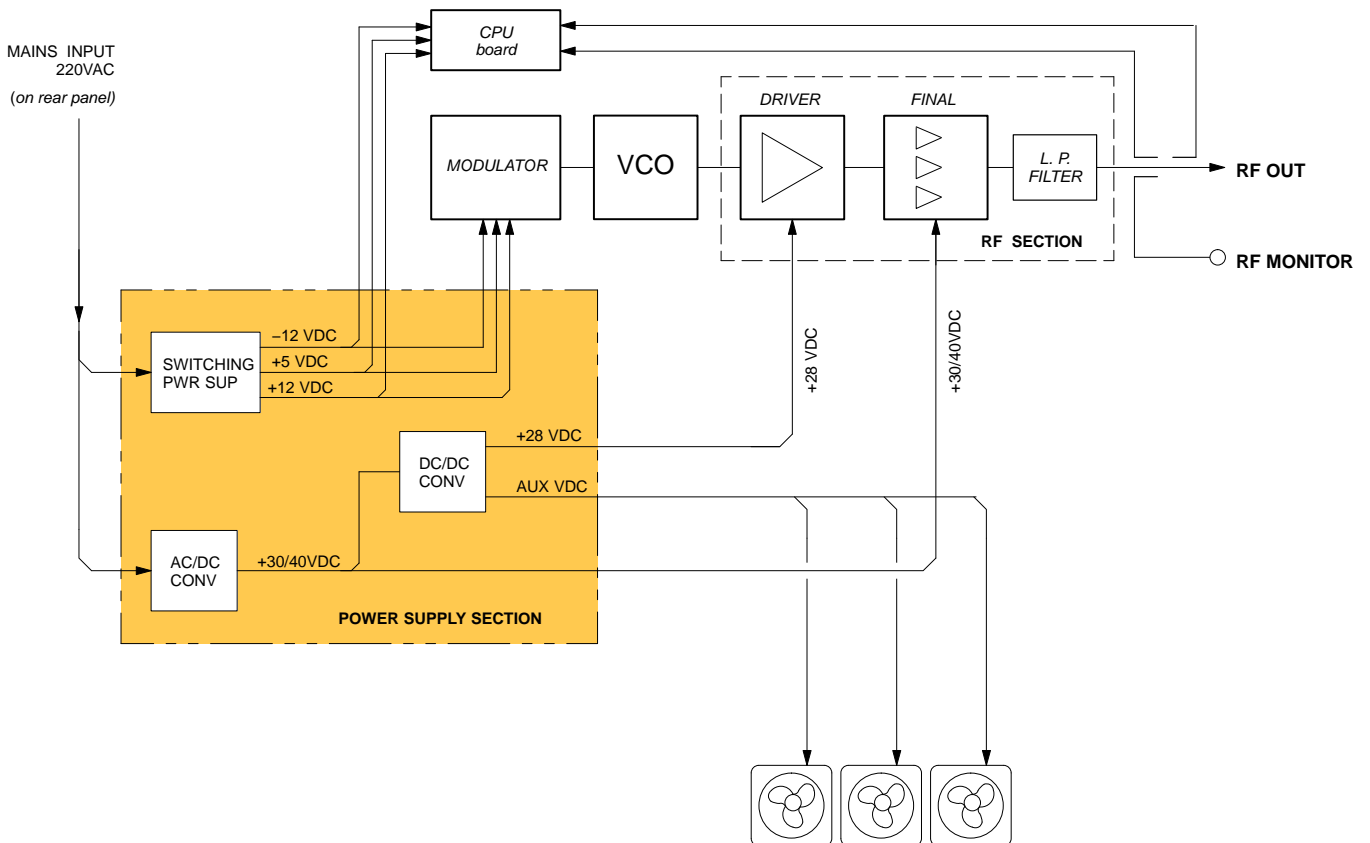
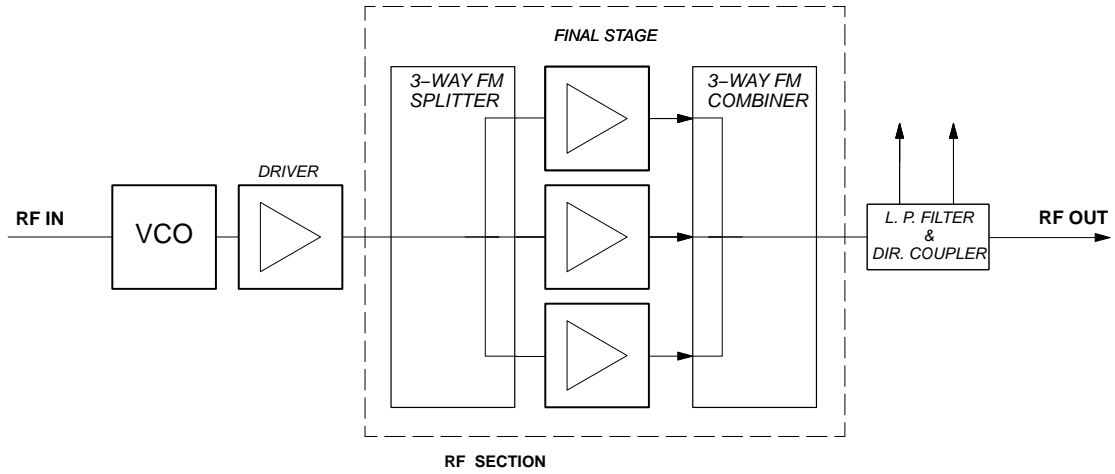

5.1.2 ETG 1000.10

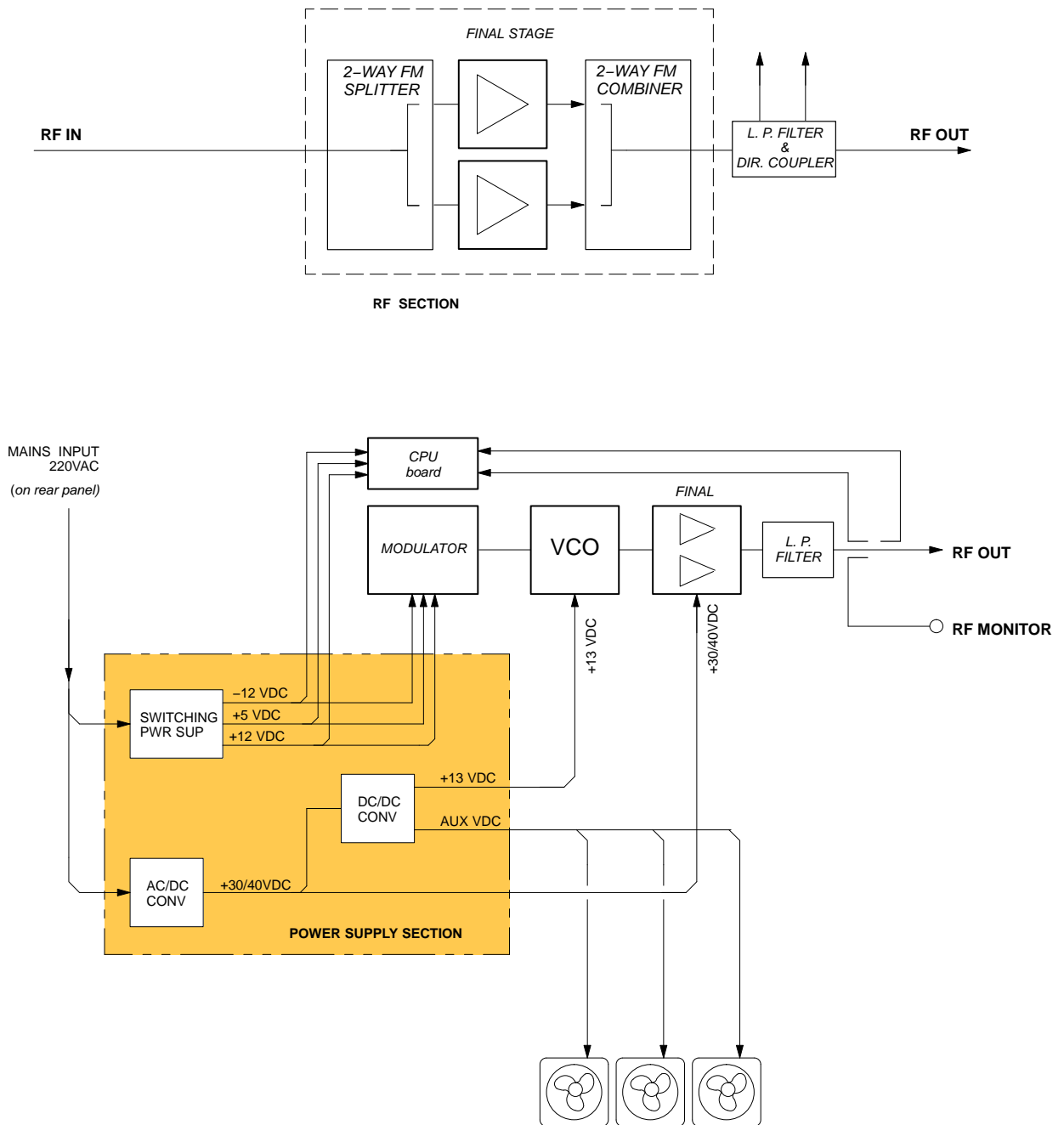

5.1.3 ETG 700.7
ETG 150

ETG 500.5

ETG 300.3

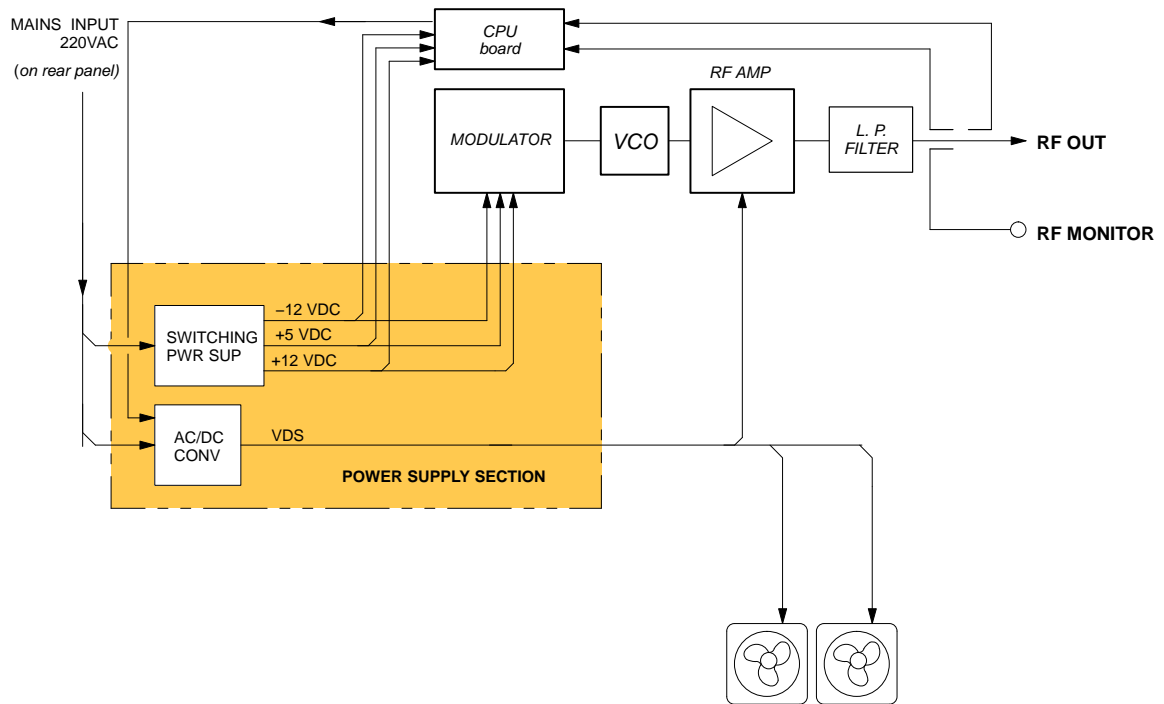

5.1.4 ETG 20

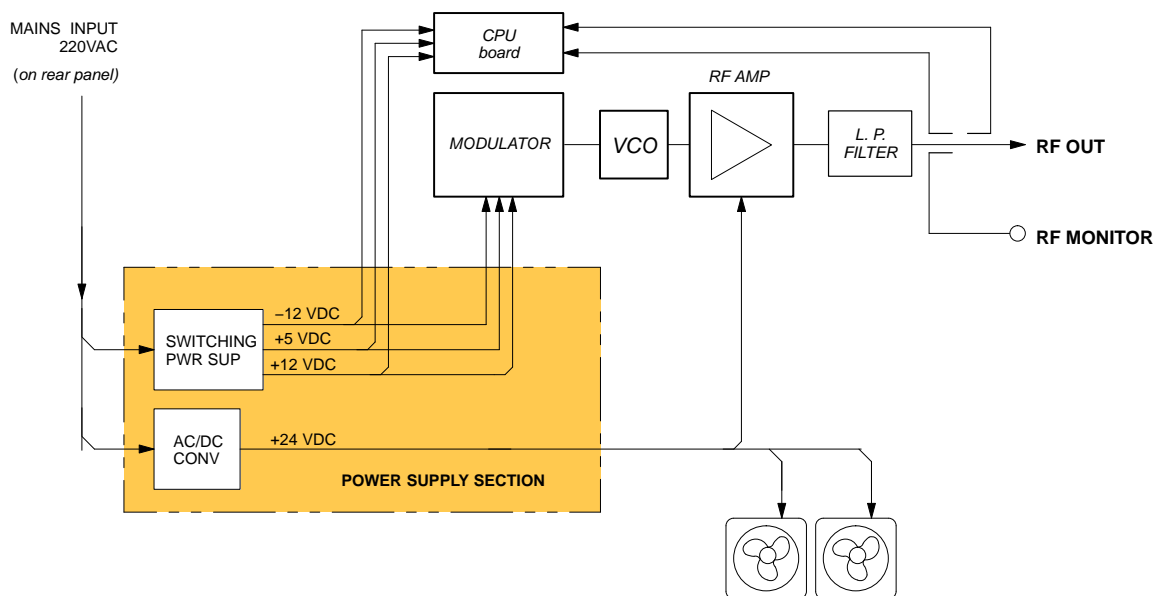

This page intentionally blank

6 User instructions

6	User instructions	41
6.1	User interface	43
6.1.1	Menu tree	44
6.1.2	TX Control Panel (Main Window)	45
6.1.3	System Menu → System Config (1 of 2 and 2 of 2)	46
6.1.4	System Menu → Communication Port Set / System Info	47
6.1.5	System Menu → System Time / Clock Pwr Target 1 of 2	48
6.1.6	System Menu → Clock Pwr Target 2 of 2 / Telemetry Config	49
6.1.7	Inputs Menu → Base Band Levels / Change Over Inputs	50
6.1.8	Inputs Menu → Input Sensitivity Settings	51
6.1.9	RF & PWR Menu → View TX Parameters (1 of 2 and 2 of 2)	52
6.1.10	Password Menu → Password / Password Setting	53
6.1.11	Password Menu → Password Recovery	54
6.1.12	Alarm Menu → Alarm List / Event History	55
6.1.13	Alarm Menu → User Alarm Data / User Alarms Timers	56
6.1.14	Alarm Menu → Audio Trim and Alarms	57
6.1.15	Diagnostic Menu → UART 0 Info / UART 1 Info	58
6.1.16	Diagnostic Menu → UART 2 Info	59
6.2	Alarms/Warnings/Status list	61
6.3	External connectable devices	65
6.3.1	Connecting to a LAN/PC	65
6.3.2	Connecting to a Change Over/Audio Matrix	66

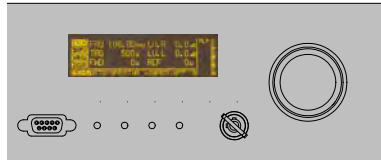

Managing the device in local mode. Navigating the menus and setting the parameters. Status LEDs and messages.

A simple grid representing a list of messages. It consists of 10 rows and 4 columns. The top row is highlighted in light blue, and the remaining rows are white with black borders.

Messaging. The equipment can send messages regarding status, events and alarms. The list can be consulted locally on a display, remotely via PC connected in telemetry to the front panel or via web. Here is the complete list.

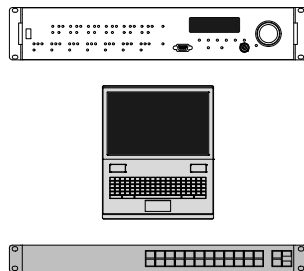

Devices that can be connected to the equipment.
For remote controlling via web, see the manual dedicated to the web interface.

6.1 User interface

All commands and data displayed by screen are listed on next pages.

Warning: The screens shown below are subject to change without notice and may look some different depending on system configuration.

Important: to be sure that new values entered will be stored, please wait at least 60 seconds before shut down the apparatus.

Note: for information about the remote control via web interface, please refer to the relevant “WEB interface User Manual”

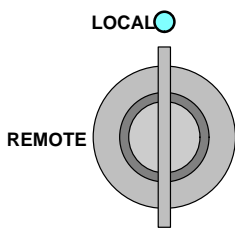

To navigate the entire menu by encoder the equipment has to be set in Local Mode.

When the amplifier works in Remote Mode, navigating is possible but the following items of menus aren't available: "Password Settings"; "Life Extender"; "GSM/Modem Menu" and "Diagnostic Menu".

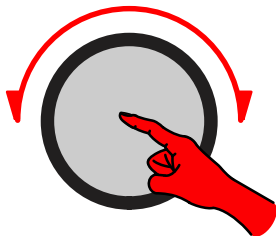

Rotate clockwise or counterclockwise the encoder to scroll the menu items, to select fields in the screens or to increase/decrease values.

Press the encoder to select a menu item, to confirm a selection or to save values.

A long press of encoder causes the return to the main screen.



The entire menu path can be checked at any time



Press "ESC" button to exit quickly from the screen without using the encoder.

6.1.1 Menu tree

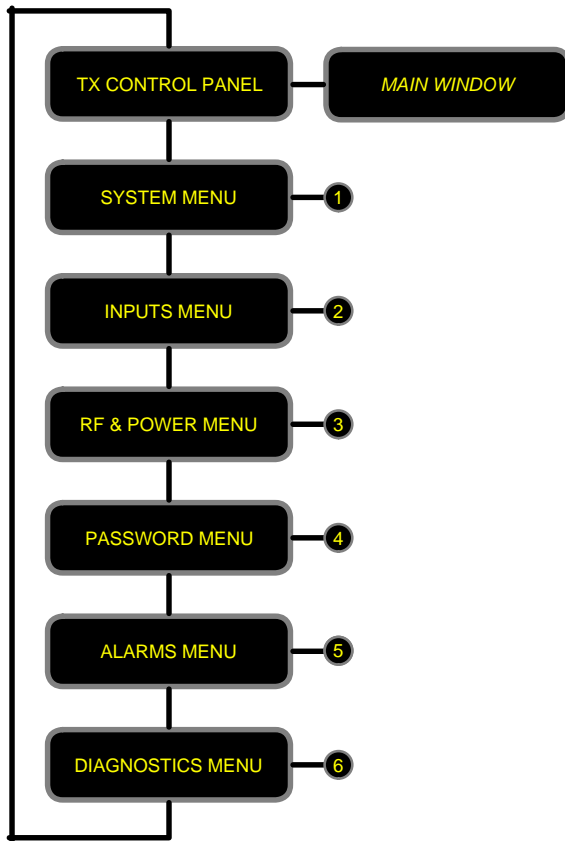

- To scroll the menu, rotate the encoder.
- To enter a submenu, or to access the masks, press it.
- To return to the main menu, press and hold the encoder.
- The menu is fully accessible only when the unit works in local mode.
- Some menu items may not be displayed when the unit works in remote mode.
- To choose local or remote mode, rotate the switchkey.

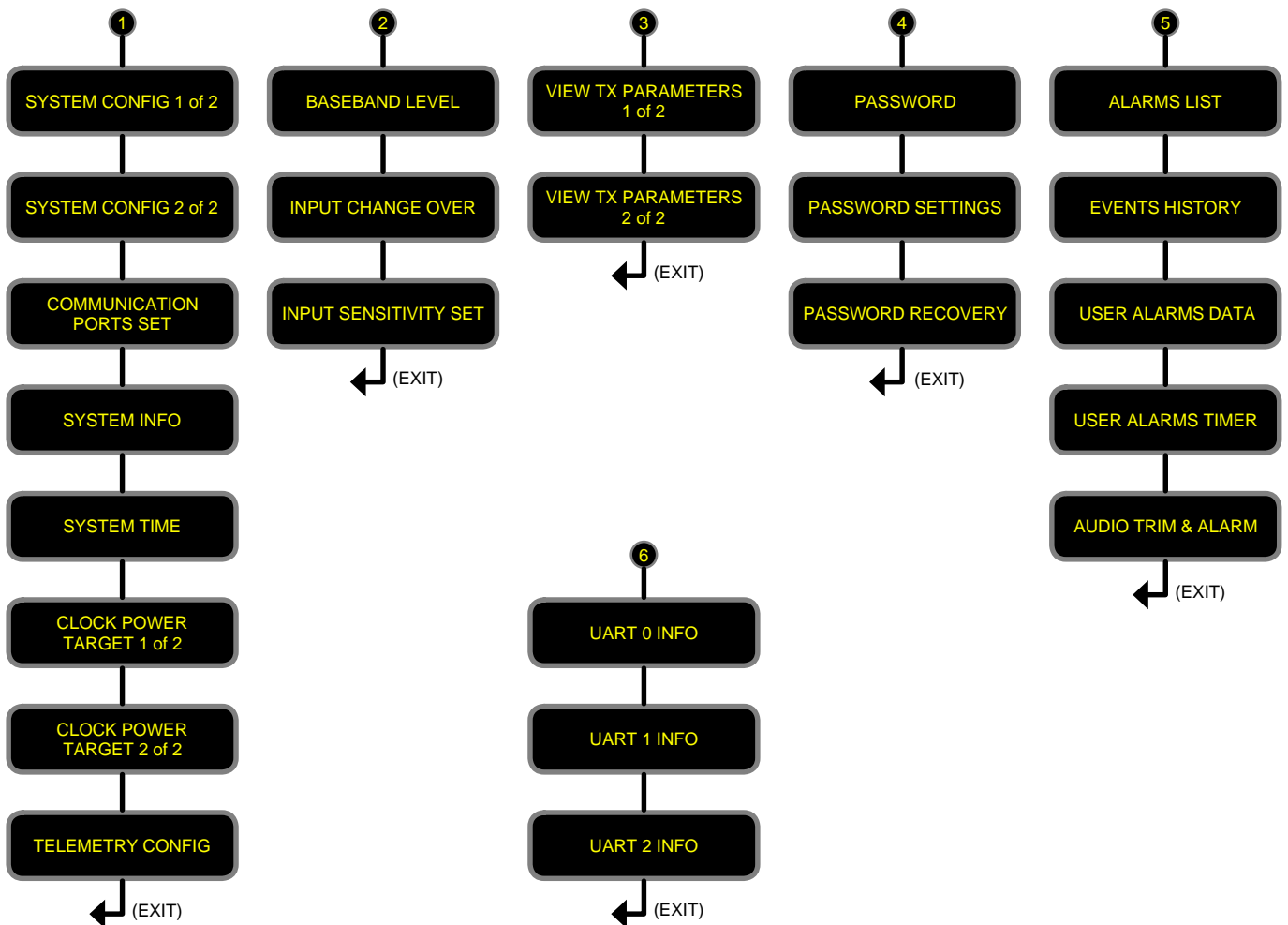

6.1.2 TX Control Panel (Main Window)

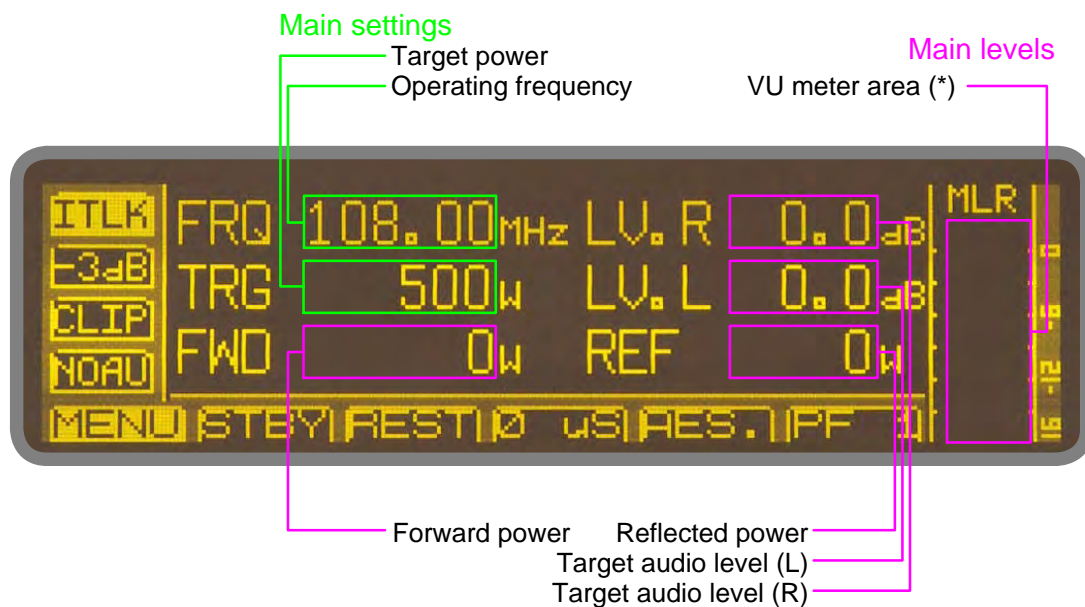

(*) The number of bars displayed depends on the type of input selected. Up to three bars can be shown: MPX (M), Left Stereo (L) and Right Stereo (R).

Main alarms

- Active when audio is lower than set level
- Active when clipper operates because overdriving
- Active when output is less than half target
- Active when inerlock contacts are open



6.1.3 System Menu → System Config (1 of 2 and 2 of 2)



SYSTEM MENU



Temperature Unit: CELSIUS or FAHRENHEIT.

Show Display: ALWAYS = display on also in remote mode.

Power Oscillation Check: TRUE = RF power swing protection active.

UPS Target (W): Target power in case of functioning with UPS.

Minimum Temperature Sensors: Failure when >nn broken thermal probes.

Time Base (10MHz): VCO's synchronization INTernal or EXTernal.

Forward Power Calibration (%): RF output power reading calibration.

SWR Foldback: ENABLE = ROS protection active.

IPA Bias Threshold (V): RF preamplifier polarization threshold.

Reflected Power Threshold Nominal (10%): TRUE = Active (10% of rated power).

Reflected Power Threshold Level (W): User defined reflected power threshold (*)

Power Amplifier bias (V): RF amplifier polarization threshold.

Max Target Power (W): Maximum settable output power.

Please, note that when a field name is abbreviated in the mask, it will write like this:

ShowDisplay = Show D.



SYSTEM MENU



Minumum LevelForward Power Fault(W): user defined low power threshold. It works in OR with the standard “-3dB” alarm. Lower values of -3dB (half power) are ignored.

(*) It works when “**ReflectedPower ThresholdNominal (10%)**” = “**FALSE**” and “**SWR Foldback**” = “**DISAB**led”. This value may be up to about 12% of rated power.

6.1.4 System Menu → Communication Port Set / System Info

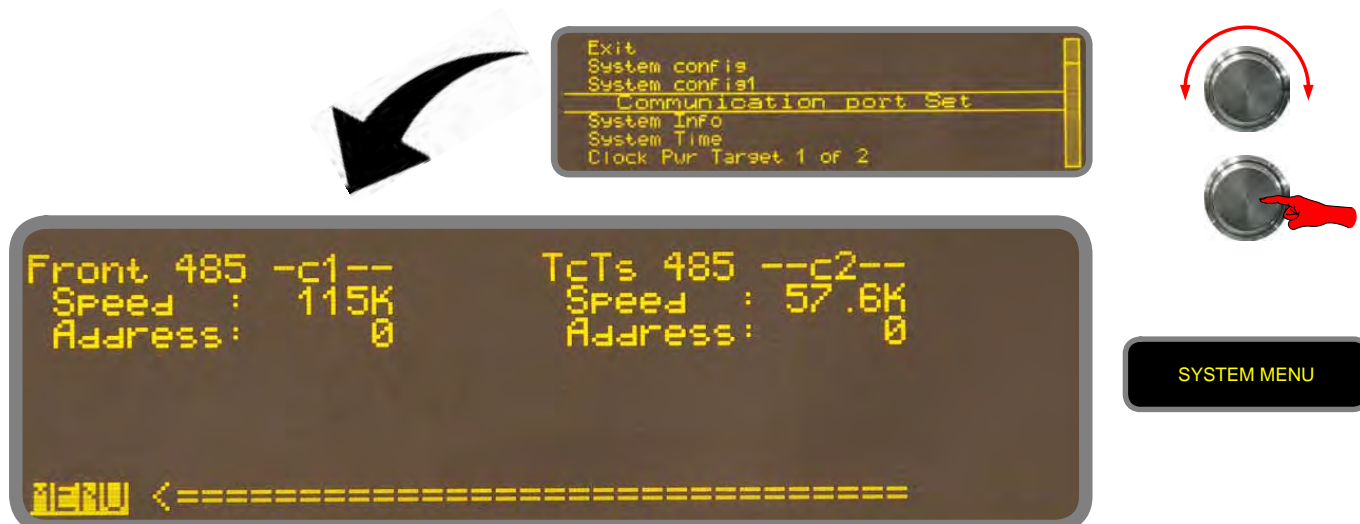

Front and rear RS485 communication ports speeds and addresses. Currently, default speed values are 38400. Previously, they were 9600. All devices working in combined or n+1 systems must be set to the same communication speed, otherwise they won't work properly. Default address values are 0. These values must be set to specific numbers when the equipment works in combined systems because it's a slave one and must be managed by master device.

IMPORTANT: to connect separately purchased equipment, ask for hardware and documentation needed to configure them properly.



Display-only screen.

The software version "**Ver.Sw**", the protocol "**Ver.P**" and the serial number "**SN**" are here indicated.

Also, the operating time "**On air time**" and the fans running time "**Fan work time**" are shown in "hours-minutes-seconds" format.

To reset the fan running time value (e.g. after their replacing), press "**R**".

6.1.5 System Menu → System Time / Clock Pwr Target 1 of 2



SYSTEM MENU

```
System Confis
Communication Port Set
System Info
System Time
Clock Pwr Target 1 of 2
Clock Pwr Target 2 of 2
Telemetry Confis
```

```

      wd dd/mm/yy   hh:mm:ss
C:   02 31/10/17   11:05:49
SET>02 31/10/17   11:05:38
-----
MENU|STBY|REST|0 US|AES.|PF 1|
```

In this screen it's possible to set the current date "**dd/mm/yy**" and the current time "**hh:mm:ss**", together with the day of the week "**wd**".

It's important to set all the parameters correctly to make the adjustment algorithms work well.

The line labeled "**C**" shows the current values, the one with the word "**SET>**" is editable and accepts the new data.



NOTE: the "**wd**" value may be 01 to 07, where 01 is Monday and 07 is Sunday.



SYSTEM MENU

```
Communication Port Set
System Info
System Time
Clock Pwr Target 1 of 2
Clock Pwr Target 2 of 2
Telemetry Confis
Exit
```

```

Target Power Mode :      FIXED
Clocked           T3     T2     T1     T0
Targets %:        100    75    50    25
W:                500    375   250   125
-----
MENU|STBY|REST|0 US|AES.|PF 1|
```

The "**Target Power Mode**" may be "**FIXED**" or "**CLOCKED**".

To follow an energy-saving policy, may be useful to choice the "**CLOCKED**" mode.

When the "**FIXED**" option is chosen, the transmitter will work always at the target power value. Otherwise, if the "**CLOCKED**" option is selected, the output power will be adjusted depending on what is set in the next screen.

"**T3**", "**T2**", "**T1**" and "**T0**" are the possible levels that may be matched to the time slots divided per hours. They are arranged in percentages of the target power and the related values are shown at the bottom.

Editing the "**T3**" value ("**W:**"), the others values are recalculated automatically.

6.1.6 System Menu → Clock Pwr Target 2 of 2 / Telemetry Config

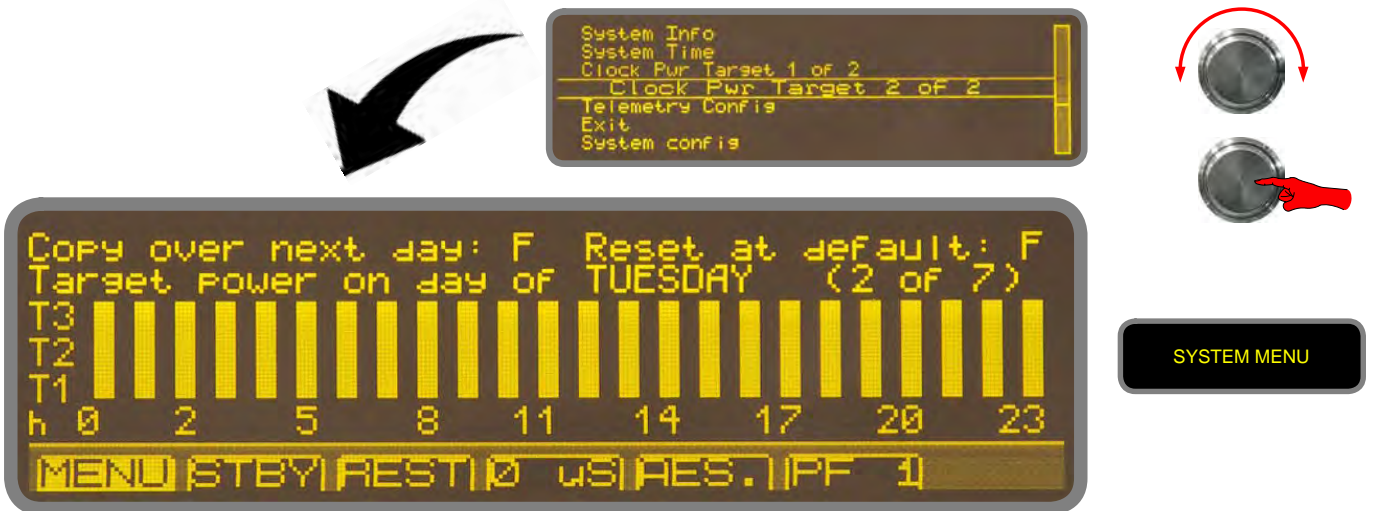

Here it's possible defining the power profiles for hours and days of the week.

Each hour can be associated to any target available (T3 to T0), defined at the previous step.

When "**T0**" is selected, no bar will be displayed.

To copy the current profile to the next day one, force to "**T**" the value of "**Copy over next day:**" by pressing the encoder on it.

The day for the which the data are inserted is shown by "**Target power on day of**".

NOTE: 01 is Monday and 07 is Sunday



The device may be equipped by a telemetry board for working with a LAN. In this case, it must be properly set (defaults are shown in this screen if the option is installed). The system administrator is required for correct setting the "**IP Address**", "**SubNet Mask**" and "**Gateway**" values.

"**DHCP Status**" indicates if the IP Address is managed in fixed ("**FALSE**") or in dynamic ("**TRUE**") mode. "**Battery Status**" shows info about efficiency of the backup battery.

"**Internal. RTC:**" = "**TRUE**" force the internal time clock reference.

"**Present:**", "**Reset:**" and "**Power on:**" show the status of the board.

6.1.7 Inputs Menu → Base Band Levels / Change Over Inputs



Display-only screen.

Values of the inputs and deviation for the carriers are shown.

This mask may look different depending on the equipment operating mode.

Displaying VU-meter style bars, located on the right of numeric values, facilitates the evaluation of the parameters.

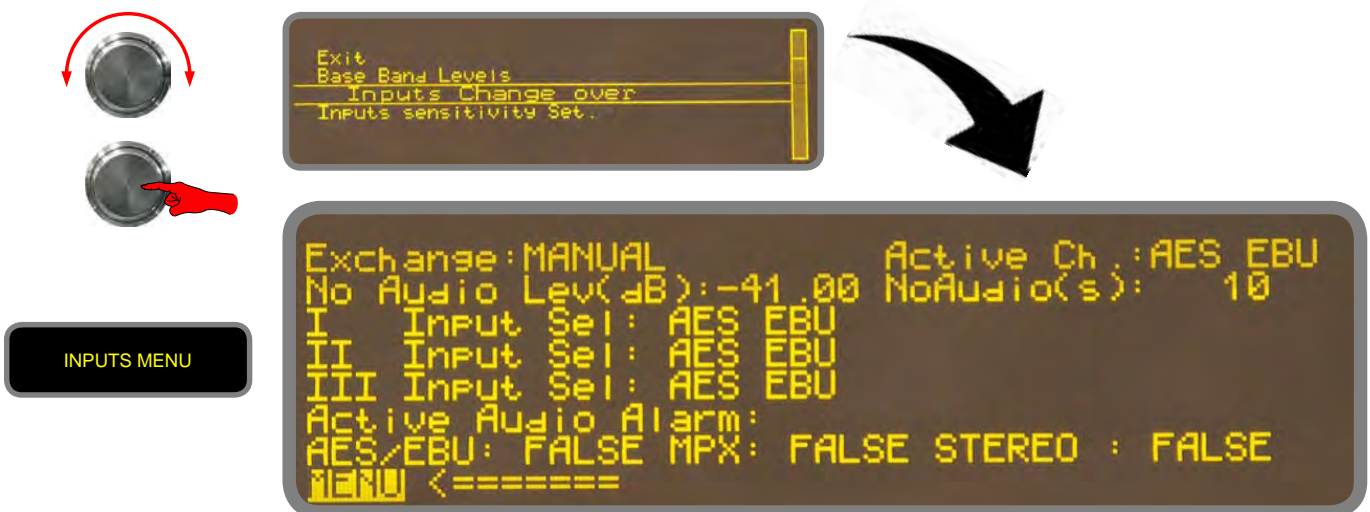

The “**Exchange**” mode may be “**AUTO**matic” or “**MANUAL**” (in this case the equipment must be controlled by the user). “**ActiveChannel**” shows the currently active audio input. The “**NoAudioLevel(dB)**” is the threshold below which automatic exchange is activated after the audio remains so for the time indicated in “**NoAudio(s):**”

Inputs priority is managed by the “**I / II / III Input Select**” list. A failure in the first (I) audio input causes the switch to the second (II), a failure in the second one causes the switch to the third (III). A failure in the third one restores the main input and then no more changes. “**Active Audio Alarm:** → **AES/EBU / MPX / STEREO**” = “**TRUE**” enables the No Audio Alarm sending for each specific input.

6.1.8 Inputs Menu → Input Sensitivity Settings

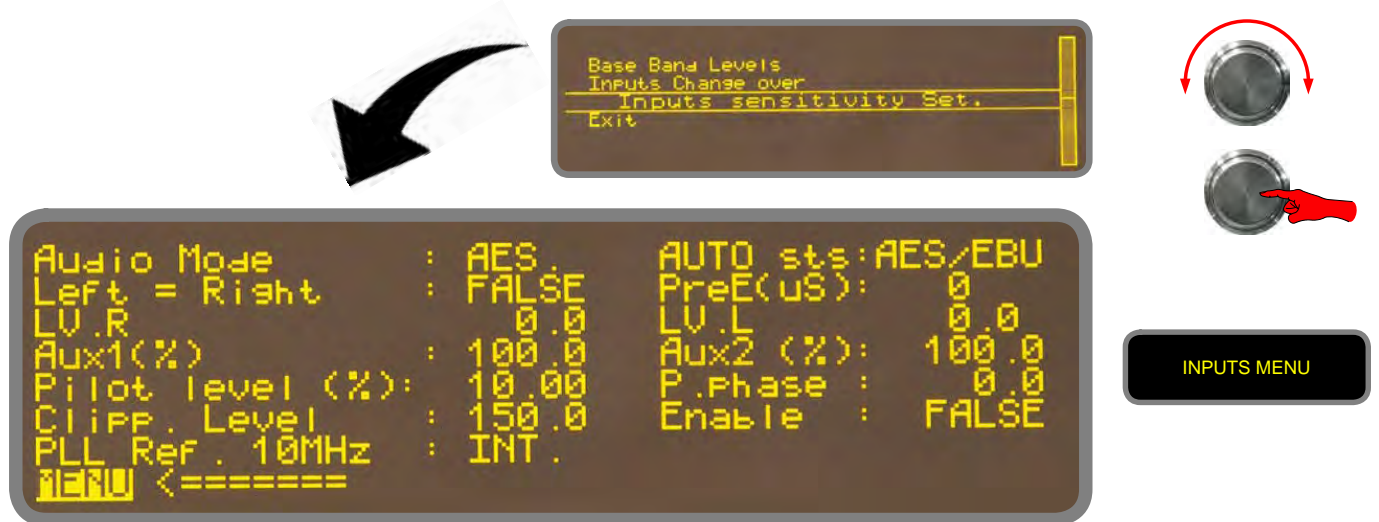

“Audio Mode” & AUTO sts

The option “**Left = Right:**” set to “**TRUE**” forces both L and R Stereo inputs to the same attenuation level, otherwise each stereo channel is attenuated by the level stored in “**LeVel R**” and “**LeVel L**”. “**PreEmphasys**” may be 0, 25, 50 or 75 μ S.

“**Aux1(%)**” and “**Aux2(%)**” specify the attenuation levels of the aux channels input.

“**Pilot Level (%)**” and “**Pilot Phase:**” specify the percentage of pilot tone and its phase in degrees.

“**Clipper Level:**”, expressed in kilohertz, indicates the deviation level beyond which the protection must be activated, when “**Enable:**” is set to “**TRUE**”.

“**PLLReference10MHz**” set to “**INTernal**” forces to use the VCO’s built in reference, whereas set to “**EXTernal**” takes an outside reference (such as a GPS).

In the last case, the signal must be applied to the appropriate connector placed on the back if this option is present.

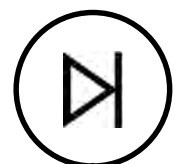

6.1.9 RF & PWR Menu → View TX Parameters (1 of 2 and 2 of 2)

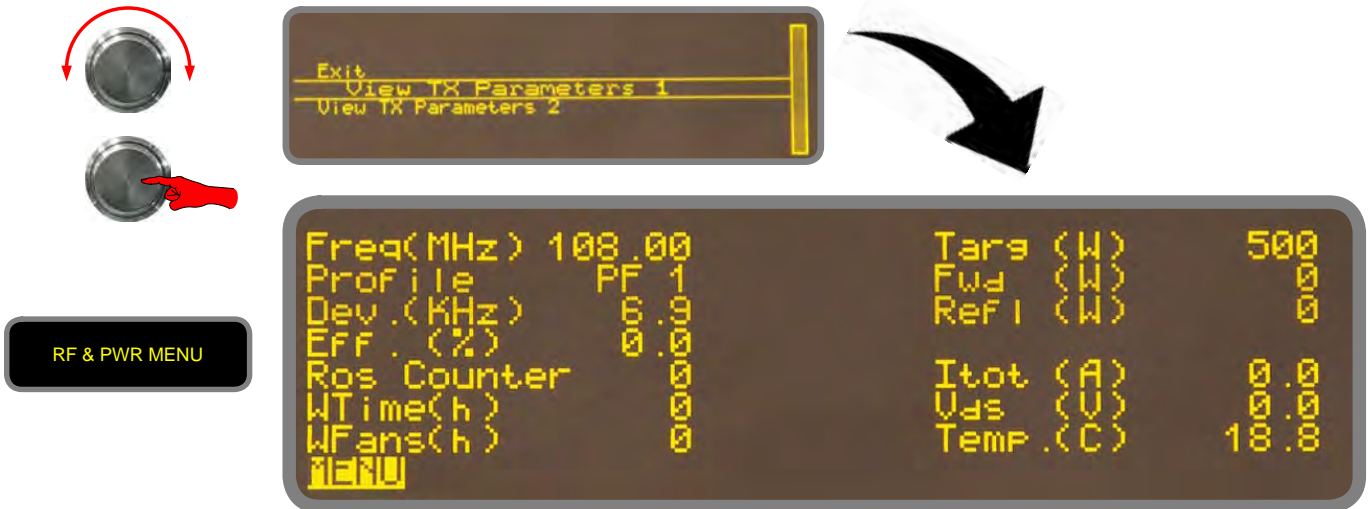

RF & PWR MENU

```

Exit
View TX Parameters 1
View TX Parameters 2
    
```

```

Freq(MHz) 108.00      Targ (W)      500
Profile     PF 1      Fwd (W)       0
Dev.(KHz)   6.0      Refl (W)       0
Eff. (%)    0.00
Ros Counter 000000    Itot (A)      0.0
WTime(h)    000000    Vds (V)       0.0
WFans(h)    000000    Temp.(C)     18.8
    
```

Display-only screen.

The following data are grouped here:

(On the left) operating frequency; selected profile; deviation level; device efficiency; counter of ROS protection occurred; working hours (on air) and fan working hours.

(On the right) target, forward and reflected power; total current absorbed by RF amplifier modules and cooling fans; Vds and max temperature of all internal probes.

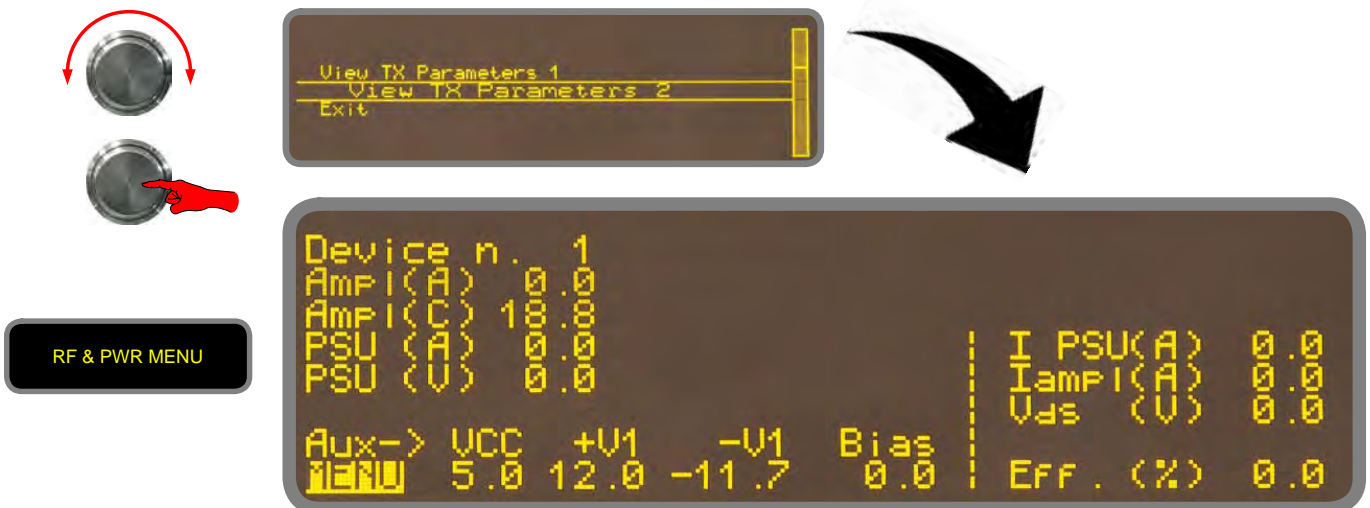

RF & PWR MENU

```

View TX Parameters 1
View TX Parameters 2
Exit
    
```

```

Device n. 1
AmpI(A) 100.00
AmpI(C) 1000.00
PSU (A) 000.0000
PSU (V) 0.00
    |
    | I PSU(A) 0.0
    | IampI(A) 0.0
    | Vds (V) 0.0
    |
Aux-> VCC +V1 -V1 Bias
MENU 5.0 12.0 -11.7 0.0 | Eff. (%) 0.0
    
```

Display-only screen.

“**Device n.**” is the MOSFET or PSU of which the parameters are listed below:

“**AmpI(A)**” = current consumption and “**AmpI(C / F)**” = temperature (°C or °F).

“**PSU (A)**” and “**PSU (V)**” = currents and voltages supplied by the main PSUs.

“**Aux-> VCC +V1 -V1**” = voltages supplied by the auxiliary power supply.

“**Bias**” = MOSFET polarization voltage value.

“**I PSU(A)**” and “**IampI(A)**” = total current absorbed by MOSFETs and supplied by PSUs.

“**Vds (V)**” = MOSFETs power supply voltage.

“**Eff. (%)**” = total efficiency of the apparatus.

6.1.10 Password Menu → Password / Password Setting



Factory preset password is “0000”. This value must be changed in “Password setting” by system administrator in order to prevent unauthorized accesses.

There are two levels of protection: “User” and “System”.

Once the settings the two new passwords, access to menu items and parameter changes will be governed by individual privileges.

Follow the procedure below.

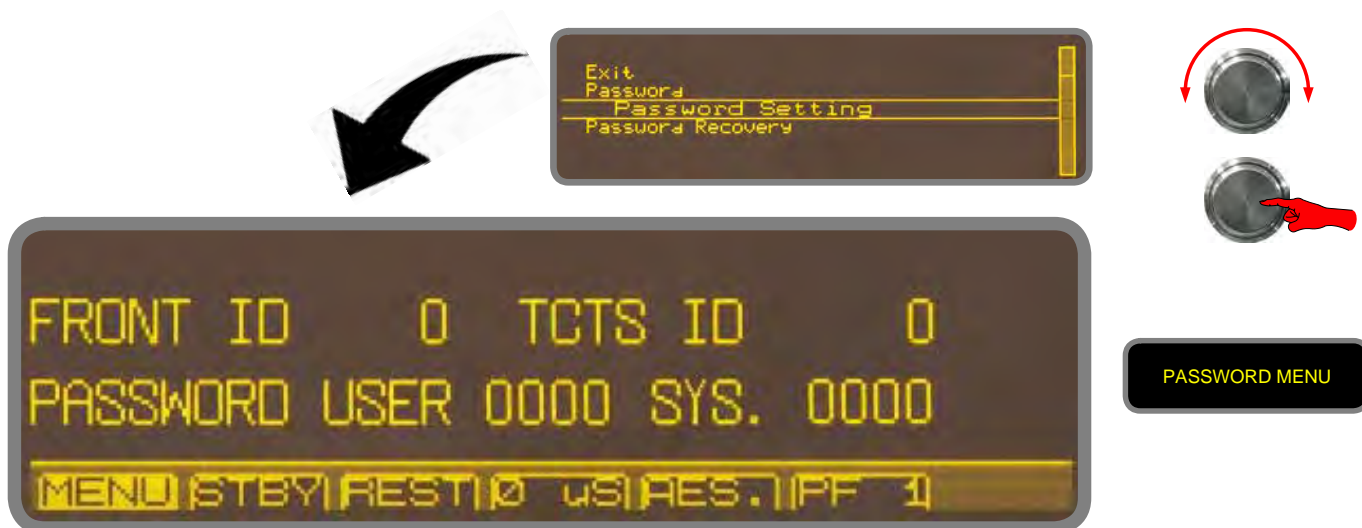

First, change the value of password “**USER**” (password “**SYS.**” is not yet visible), then exit and re-enter the mask: password “**SYS.**” is now visible and editable.

Choose two distinct password for the levels, both different from “0000”.

By now, menus and parameters will be accessible depending on logins.

Users will no longer have access to parameters settings.

6.1.11 Password Menu → Password Recovery



If users forgot the password, it's kindly advised to contact Elenos.

The "**UNLOCK CODE**" is useful to obtain the 24h "**PASSWORD RECOVERY**" and must be provided to Elenos.

Subsequently, system administrator have to redefine passwords by "PASSWORD SETTING" mask.

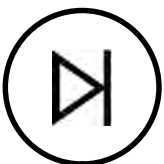

6.1.12 Alarm Menu → Alarm List / Event History

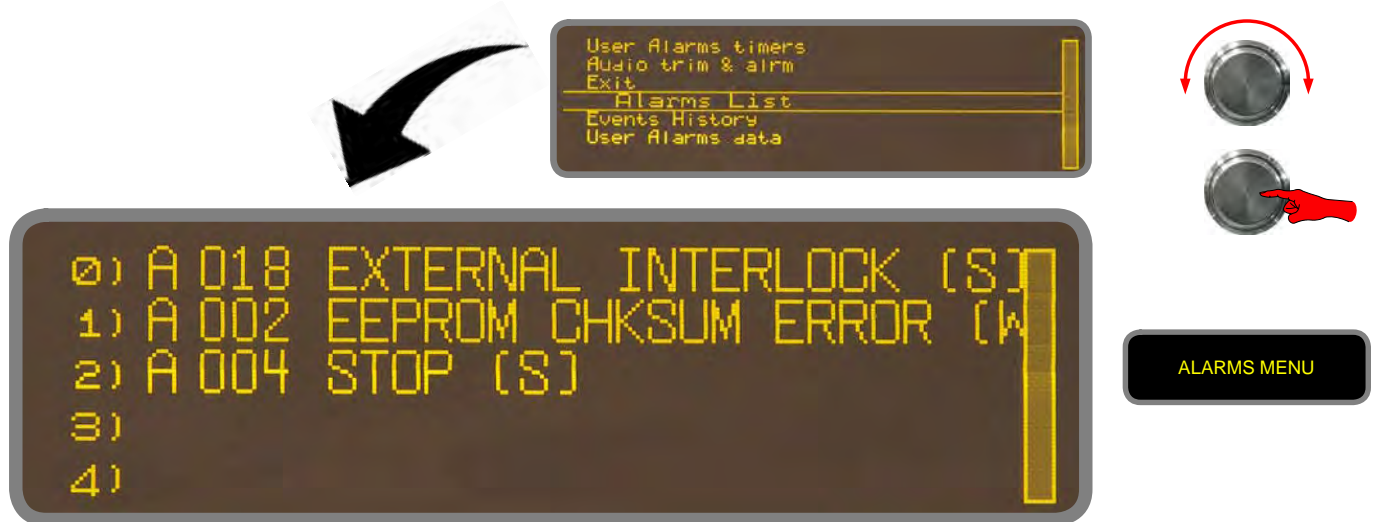

Display-only screen.

It's possible scrolling the list of all recently occurred alarms.

The ones preceded by letter "A" are active, the others are occurred.

Between brackets, the type of message is specified: **S**tatus, **W**arning and **A**larm.

In order to understand the meaning of the alarms please see the paragraph "Alarms/ events listing".

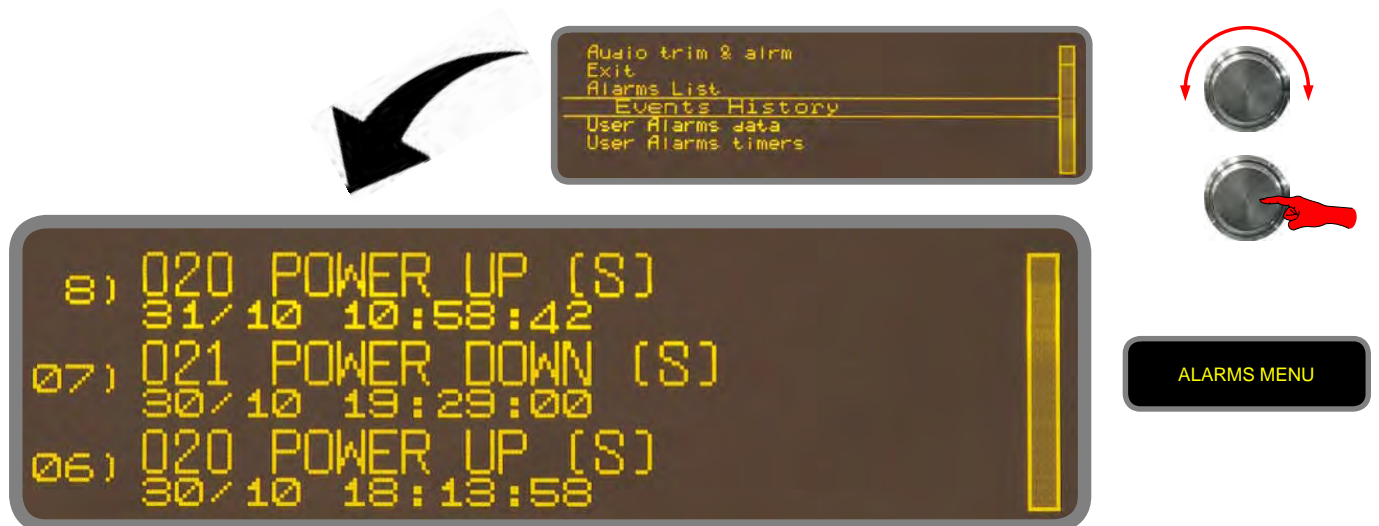

Display-only screen.

It's possible to scroll the list of all events occurred (up to 99 items), identified by code, description, date, time and type.

6.1.13 Alarm Menu → User Alarm Data / User Alarms Timers

ALARMS MENU

```

Exit
Alarms List
Events History
User Alarms data
User Alarms timers
Audio trim & alarm
    
```

PARAM	Rds	En.	Max	Min	Type
Env. Temp(C):	00.0	F	50.0	45.0	UPPER
RF Temp(C):	19.1	F	90.0	98.0	UPPER
RF Curr(A):	0.00	F	1.20	1.00	UPPER
PSU Temp(C):	00.00	F	90.00	98.00	UPPER
PSU Curr(A):	00.00	F	250.00	22.00	UPPER
FWD PWR(W):	100.00	F	2500	2000	LOWER
REFL PWR(W):	1	F	50	45	UPPER

Parameters of some alarms may be customized.

They are: **Environmental Temperature (C or F)**; **RF Temperature (C or F)**; **RF Current(A)**;

PSU Temperature(C or F); **PSU Current(A)**; **Forward power(W)** and **Reflected power(W)**.

Forcing to “T” the value of “**Enable**” by pressing the encoder, the alarms will be activated depending on limits specified by “Max” and “Min” values.

It’s also possible to choose the criterion (Type) with which the limits will affect the automatic algorithm: “UPPER” to have an alarm when the parameter will exceed the max value; “LOWER” to have it below the minimum one; “INSIDE” to have an alarm when the value is between max and minimum; “OUTSIDE” for the opposite.

A max value lower than the minimum one will exclude the alarm.

ALARMS MENU

```

Alarms List
Events History
User Alarms data
User Alarms timers
Audio trim & alarm
Exit
    
```

PARAM	Rds	En.	Delay	Timer	Alarm
Env. Temp(C):	0.0	F	1200	1200.0	F
RF Temp(C):	19.1	F	1200	1200.0	F
RF Curr(A):	0.00	F	1200	1200.0	F
PSU Temp(C):	0.00	F	1200	1200.0	F
PSU Curr(A):	0.00	F	1200	1200.0	F
FWD PWR(W):	0	F	1200	1200.0	F
REFL PWR(W):	1	F	1200	1200.0	F

The left half mask works such as the previous one.

Delay is the time frame before the alarm is considered valid. This parameter is expressed in tenths of a second so that the value “120”, visible in the screen, means 12 seconds.

When a condition that could be an alarm is triggered, the related “Timer” starts. At the end of the countdown, the alarm is validated and the flag “**Alarm**” becomes “**True**”.

6.1.14 Alarm Menu → Audio Trim and Alarms

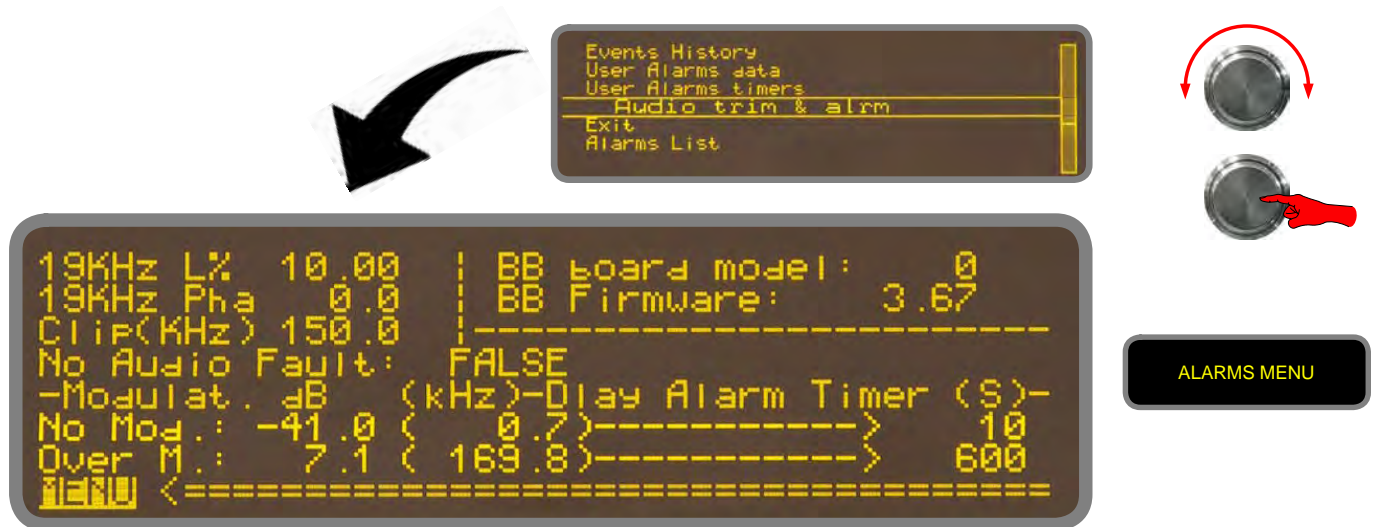

In the box on the right, at the top of the screen, model of board and firmware installed are indicated.

This mask summarizes some parameters already seen in “Input sensitivity settings” and “Change over inputs” screens.

In addition, the status of the “No Audio Fault” alarm is displayed.

Signal management takes place via the TC/TS connector.

6.1.15 Diagnostic Menu → UART 0 Info / UART 1 Info



Display-only screen.

This screen shows the status of the serial communication with the Hostlink Slave and the number of errors that occurred from the beginning.



Display-only screen.

This screen shows the status of the serial communication with a terminal monitor or an external GSM modem, along with the number of errors that occurred from the beginning.

6.1.16 Diagnostic Menu → UART 2 Info



Display-only screen.

This screen shows the status of the serial communication with the power supply units and the number of errors that occurred from the beginning.

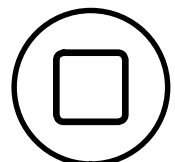

This page intentionally blank

6.2 Alarms/Warnings/Status list

A task called “Alarms Managing” monitors all physical and logical quantities.

Each of them is sampled and processed by a combinatorial network to evaluate if an alarm (or a warning) must be activated.

This task and the ALC management have the same high priority for having a constant monitoring of the entire apparatus and intervene quickly.

The last alarms occurred are stored in a list with the time and date of the occurrence.

All events that may occur are listed on next pages.



Alarm.

An event of this type means that a malfunctioning is occurring and maintenance could be necessary. However, the apparatus will attempt to minimize the failure by itself applying suitable algorithms.



Warning.

An event of this type means that a temporary irregular condition is occurring. Normally, there isn't an important failure and the apparatus will recover its functionality by itself applying suitable algorithms.



Status.

An event of this type notifies the operating condition of the apparatus and doesn't mean that a malfunctioning is occurring.

List of events that may be reported by the equipment. They are of 3 kinds: “STATUS” = possible statuses of the machine; “WARNING” = reports not requiring immediate technical intervention; “ALARM” = faults requiring repair.

Some may be different depending on equipment (see brackets in “Message”).

Event	Code	Message	Description
STATUS	000	CORRECT WORKING	No error. The apparatus is working correctly. The event “019 ON AIR” has a higher priority.
STATUS	001	SYSTEM RESET	The list of occurred alarms is under deleting process. Active ones aren’t deleted.
WARNING	002	EEPROM CHKSUM ERROR	The data stored in memory is no longer reliable. The apparatus will be restarted with default parameters.
ALARM	003	BLOCKED	The apparatus is blocked after that five restore have been attempted. To restart it, a reset command is required.
STATUS	004	STOP	The apparatus is in StandBy mode with no active alarms, ready to work.
ALARM	005	-3dB CARRIER	The RF output power is less than half target power since one minute during the start up or five seconds during the correct working.
ALARM	006	HIGH REF PWR	High reflected power is detected after that a “Three Block Out” recovery protection has been attempted.
ALARM	007	MIN 12V	The negative voltage reference is no longer reliable. The apparatus attempts the “Three Block Out” recovery protection.
ALARM	008	RF AMP. FAULT	A failure is occurred in one or more RF amplifier modules.
WARNING	009	RF AMP. FAULT DERATING	As above, but the RF output power is reduced according to an algorithm.
WARNING	010	RF THERMAL DERATING	The temperature of one or more RF amplifier modules is been too high so that the RF output power is reduced according to an algorithm.
ALARM	011	RF OVER TEMPERATURE	The “RF THERMAL DERATING” failed and the apparatus attempts the “Three Block Out” recovery protection.
ALARM	012	PSU FAULT	A PSU malfunction is occurring.
WARNING	013	PSU CURRENT DERATING	One or more PSU overloads are occurred so that the apparatus is reducing the RF power output according to an algorithm.
ALARM	014	PSU OVER CURRENT	The apparatus was shut down in a minute since the current derating didn’t decrease.
WARNING	015	PSU THERMAL DERATING	One or more PSU overheatings are occurred so that the apparatus is reducing the RF output power according to an algorithm.
ALARM	016	PSU OVER TEMPERATURE	Too high temperature of one or more PSU so that apparatus has been shut down.
ALARM	017	PSU COMM TIMEOUT	The RS485 internal bus dedicated to the communication between CPU and PSU isn’t working correctly.
STATUS	018	EXTERNAL INTERLOCK	The interlock circuit is open and the apparatus is blocked.
STATUS	019	ON AIR	The apparatus works correctly.
STATUS	020	POWER UP	RF output power increase is occurring.
STATUS	021	POWER DOWN	RF output power decrease is occurring.
WARNING	022	PSUTHERMALDERATING/FAULT	One or more PSU are performing a thermal derating by reducing the current supplied.

Event	Code	Message	Description
WARNING	023	PSU LOW POWER	One or more PSU are in thermal derating so that the RF output power is reduced.
ALARM	024	PSU RF OFF	The RF section has been turned off so that the fans can quickly cool the apparatus.
STATUS	025	WORKING MODE COMBINED	The apparatus works in a combined Tx.
WARNING	026	SWR FOLDBACK	High reflected power has been detected so that the apparatus is adjusting the RF output power according to an algorithm.
ALARM	027	UNLOCK	The PLL of the VCO is no longer locked to the set frequency.
ALARM	028	EXCITER COMM ERROR	The exciter serial communication has stopped working correctly.
ALARM	029	NO AUDIO	The audio input level has remained lower than the minimum set level for the set time.
STATUS	030	OVER 2/3 CARRIER	The RF out power is rising up to 2/3 of the target after which a “-3dB” alarm has occurred.
WARNING	031	FAN 1 ERROR	Fan no.1 has stopped working properly.
WARNING	032	OVER MODULATION	Excessive modulation is occurring (too high frequency deviation).
WARNING	033	FAN 2 ERROR	Fan no.2 has stopped working properly.
WARNING	034	TEMPERATURE SENSOR ERROR	If the thermal probes installed are more than one, it means the fault of one of these because its read value is significantly different from the expected one.
ALARM	035	PWR FORWARD OSCILLATION	RF output power oscillation is detected and the apparatus attempts the “Three Block Out” recovery protection.
ALARM	036	THREE BLOCK OUT	The malfunction has not disappeared during the automatic protection time and the apparatus was stopped.
WARNING	037	USER ENV TEMP OUT LIMIT	The user-defined environmental temperature limits in “User Alarms Data” have been exceeded.
WARNING	038	USER RF TEMP OUT LIMIT	The user-defined RF temperature limits in “User Alarms Data” have been exceeded.
WARNING	039	USER PSU TEMP OUT LIMIT	The user-defined PSU temperature limits in “User Alarms Data” have been exceeded.
WARNING	040	USER RF CURRENT OUT LIMIT	The user-defined RF current limits in “User Alarms Data” have been exceeded.
WARNING	041	USER PSU CURRENT OUT LIMIT	The user-defined PSU current limits in “User Alarms Data” have been exceeded.
WARNING	042	USER FRW PWR OUT LIMIT	The user-defined RF forward power limits in “User Alarms Data” have been exceeded.
WARNING	043	USER RFL PWR OUT LIMIT	The user-defined RF reflected power limits in “User Alarms Data” have been exceeded.
ALARM	044	OUT PWR NOT VERIFIED	The RF output power measurement is not reliable.
STATUS	045	UPS ACTIVE	The apparatus works by drawing current from the UPS.
ALARM	046	SHUNT COMM TIMEOUT	Internal serial communication timeout. The apparatus has stopped working.
WARNING	047	WARNING TEMPERATURE SENSOR	A thermal probe is unreliable and its reading is discarded.
ALARM	049	DRAIN VOLTAGE TOO LOW	VDS voltage too low. The amplifier section has been stopped and will remain so until the disappearance of the cause.
WARNING	050	OVER FRW PWR ERROR	An overshoot of RF output power respect to the target is occurred.
WARNING	051	PSU VOLTAGE DERATING	One or more PSU are in voltage derating.

Event	Code	Message	Description
WARNING	052	PSU MAINS OVER VOLTAGE	Mains voltage too high.
STATUS	053	PILOT PWR GOOD (Amplifier)	The RF input power level is correct.
WARNING	053	EXT REF MISSING (Exciter)	External reference (10Mhz) absent.
WARNING	054	INCREASE PILOT PWR (Amplifier)	The RF input power level is to low but not dangerous and must be increased.
WARNING	054	MPX NO AUDIO (Exciter)	The MPX input level has remained lower than the minimum set level for the set time.
WARNING	055	DECREASE PILOT PWR (Amplifier)	The RF input power level is to high but not dangerous and should be decreased.
WARNING	055	AES/EBU NO AUDIO (Exciter)	The AES/EBU input level has remained lower than the minimum set level for the set time.
ALARM	056	BAD INPUT RF PROTECTION (Amplifier)	RF input power level out of limit. The external modulator has been disconnected.
WARNING	056	STEREO NO AUDIO (Exciter)	The STEREO inputs level is lower than the minimum set level for the set time.
WARNING	057	STREAMING NO AUDIO	No sufficient level audio streaming signal for the set time.
WARNING	058	DIG MPX NO AUDIO	No sufficient level digital MPX audio signal for the set time.
WARNING	059	BATTERY LOW	The CPU backup battery is low. In case of no mains, the clock will lose settings.
WARNING	060	REFERENCE VOLTAGE ERROR	The internal refer. voltage is no longer reliable and the measurements will be incorrect. Some wrong alarms or warnings could be sent.
WARNING	061	FAN 3 ERROR	Fan no.3 has stopped working properly.
WARNING	062	DRAIN VOLTAGE CONTROL ERROR	VDS voltage is more than 4V different from the expected value. The adjustment is fixed at the last valid value. It restarts when the difference becomes less than 4V.
WARNING	065	RTC FAULT	The clock says a wrong time; it isn't possible to correct automatically. Some settings, such as "clock power target", will not run correctly.
STATUS	066	RTC USER UPDATED	The user has updated the internal clock.
STATUS	067	RTC AUTOMATIC RECOVERY	The apparatus has updated the internal clock automatically.
STATUS	068	CLIPPER ON	Audio clipper protection has been activated to prevent a frequency deviation excess.
STATUS	069	CLIPPER OFF	Audio clipper protection no longer actives.
STATUS	070	RTC SERVER NTP UPDATED	The internal time reference has been updated via NTP server.

6.3 External connectable devices

6.3.1 Connecting to a LAN/PC

Connect the apparatus to PC via LAN using a switch or any other device such as a router. Also the direct connection between apparatus and PC is possible. See web connection manual for all details.

NOTE: for a complete overview of remote controlling, please refer to the web interface manual

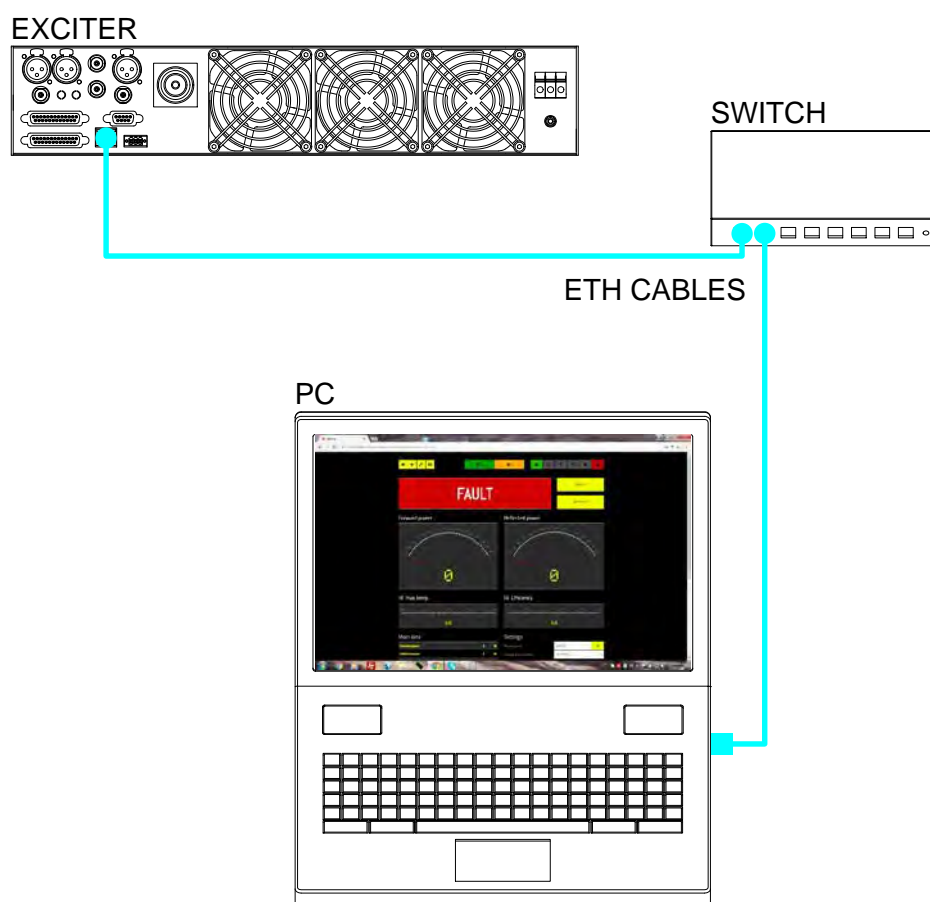

6.3.2 Connecting to a Change Over/Audio Matrix

In N+1 systems, the apparatus may be a transmitter or the reserve (the exciter and its connections aren't shown).

Examples of connections between these devices are shown below.

Tx1 in a N+1 system

Echos6 SE
(Elenos Changeover)

EXCITER

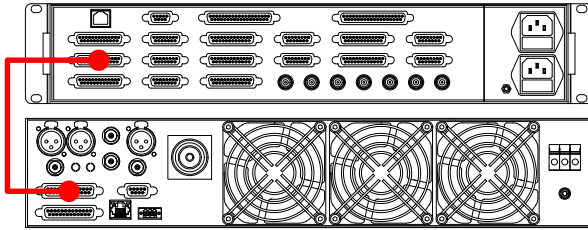

All cables are DB25 extension cords

NOTE: if the transmitter is not the #1, look at the Echos6 manual for the connector use

Reserve in a N+1 system

Echos6 SE
(Elenos Changeover)

EXCITER

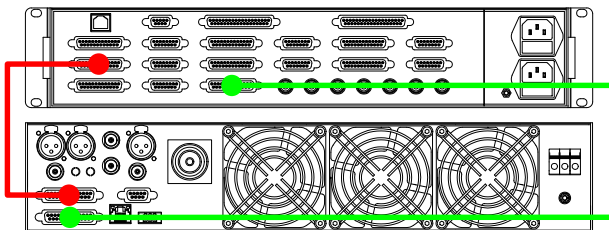

All cables are DB25 extension cords

Reserve in a N+1 system with Audio Matrix

Echos6 SE
(Elenos Changeover)

Audio Matrix
(BNC Version)

EXCITER

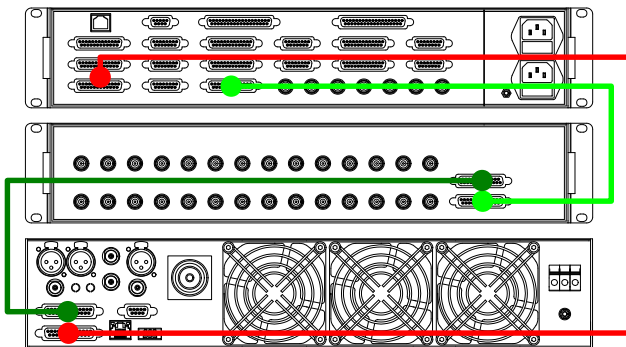

All cables are DB25 extension cords

Reserve in a N+1 system with double Audio Matrix

Echos6 SE
(Elenos Changeover)

Audio Matrix
(XLR Version)

Audio Matrix
(BNC Version)

EXCITER

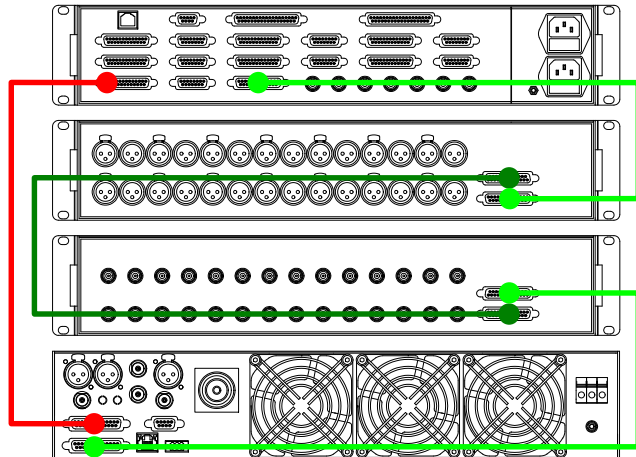

All cables are DB25 extension cords

7 Datasheet

7 Datasheet	67
7.1 Datasheet	68
8.1.1 Individual models specific parameters	70
7.2 ETG models layouts	71
7.2.1 ETG 2000.20	71
7.2.2 ETG 1500.15	72
ETG 1000.10	72
7.2.3 ETG 700.7 / ETG 300.3 / ETG 500.5 / ETG 150	73
7.2.4 ETG 20	74

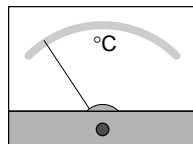
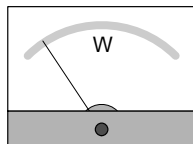
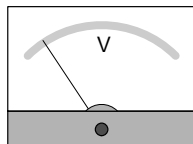
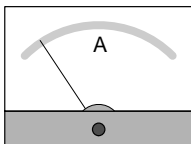
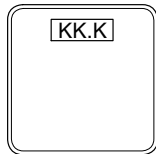
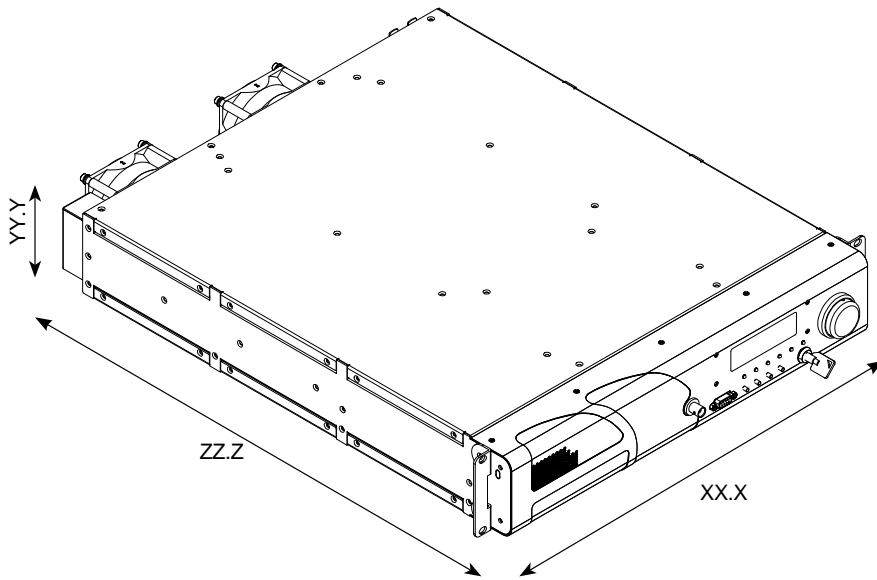

7.1 Datasheet

GENERAL DATA

Rated output power	See "Spec" table, <i>Rated FWD</i> column
Operating band	87.5–108 MHz
Samples	RF sample – MPX monitor
RS232/485	Yes
Displayable parameters	All most important parameters, such as voltages, currents, temperatures, RF powers, efficiencies and more on high resolution graphic OLED
Adjustments	By front panel/via web interface
Number of RF power LDMOS	See "Spec" table, <i>no. MOSFETs</i> column
RF power technology (by Elenos)	ICEFET and ECOSAVING
Number of power supplies	1
Dimensions (rack units/ W–H–D)	2HE/ 48.5–8.5–58.5 cm (19.1–3.3–23 inches)
Weight	See "Spec" table, <i>Weight</i> column
Cooling fans (long life, speed controlled)	2 for 20W to 700W models 3 for 1000W to 2000W models
Overall efficiency (typical)	≥ 70%

REMOTE CONTROL

Remote control capability	WEB, SNMP, SMS, (with optional modem)
---------------------------	---------------------------------------

CONNECTORS

RF output	N female for 20W to 700W models 7/16" for 1000W to 2000W models
RF monitor	BNC female (on front panel)
Ethernet	RJ45 (on rear panel)
RS232/485	DB9 female (on rear panel)
Telemetry (EIA485)	DB9 female (on rear panel)
TC/TS (parallel I/O)	DB25 female (on rear panel)
Profiles (only in N+1 configuration)	DB25 female (on rear panel)
Interlock	SL–SMT3.50 3pole (on rear panel)
MPX/Aux1/Aux2/MPX monitor	BNC female (on front panel)
Stereo Audio/AES–EBU	XLR 3pole female (on rear panel)
Mains	no. 3 terminal blocks
Safety ground connection	M4 threaded screw

RF PERFORMANCES

Output impedance	50Ω
Automatic RF power control	Stabilizes the RF output power
Overall RF output power stability	within ± 0.1 dB
VSWR	2:1, (@ 10% of rated output power) fast HW protection Automatic SW foldback over 1.7:1 with max. 200ms delay; Open and short circuit output protection
Harmonics and spurious emissions	Within ETSI standards

MODULATION PERFORMANCES

MPX input level	–10 to +15 dBμ for 75 kHz standard deviation
MPX input impedance	600Ω balanced/5k0Ω unbalanced
MPX audio level adjustment	0.1 dBm steps
L/R input level	–10 to +15 dBμ for 75 kHz standard deviation
L/R input impedance	600Ω balanced/10k0Ω unbalanced
L/R input level adjustment	0.1 dBm steps
AES/EBU input level	–20 dBFS to 0 dBFS
AES/EBU input impedance	110Ω balanced
AES/EBU input resolution	24 bits
AES/EBU input sampling rate	32, 44.1, 48, 96 and 192 kHz automatically selected
SCA/RDS input level	0 dBu for 10% deviation (adjustable)
Pilot level adjustment	0.05% steps soft adjustment
Pilot phase adjustment	0.01° steps soft adjustment
Pilot tone frequency	19 kHz
Pre–emphasis	0/25/50/75μs selectable
Pre–emphasis accuracy	within ± 0.1 dB
Pre–emphasis tolerance	± 0.1 μs
Pilot tone deviation	± 75 kHz soft adjustment
Pilot tone frequency stability	± 1 Hz
19 kHz output	Yes
AES/EBU/Stereo/MPX/input automatic ch–ov.	Yes, sorted by priority list, audio input sensitivity and no–audio delay time
THD + N	< 0.03% @ 1 kHz
FM S/N MPX FCC	82 dB 20Hz–23kHz 50μs ref @ 53 kHz RMS
FM S/N STEREO CCIR	≥ 72 dB weighted/unweighted @ f _{mod} = 400Hz, 75kHz freq. de., peak value measurement, L/R/Mono channel

Asynchronous AM S/N unweighted	> 55 dB
Synchronous AM S/N unweighted	> 50 dB
Modulation frequency range	16 Hz – 15 kHz
Amplitude/frequency characteristic	± 0.1 dB (with/without pre-emphasis) @ $f_{mod} = 400\text{Hz}$, 16Hz–15kHz L/R/Mono channel
Stereo crosstalk	> 60 dB (linear/non linear) @ 30Hz–15kHz L/R channel (100% modulation)
Distortion	< 0.05% with 75kHz/100kHz frequency deviation @ 16Hz–15kHz, L/R channel
Intermodulation distortion	< 0.05% channel, 60Hz/7kHz, 4:1, + 4dB μ
Emission class	F3
Stereo emission	According to ITU–R recommendation 450 (pilot tone)
PLL lock time	< 10s
Intermodulation distortion	< 0.05% measured with two tones of 1kHz and 1.3kHz, 1:1 ratio @ 100% modulation
Frequency deviation	± 75kHz, 0.1 dB step adjustable
Maximum frequency deviation	± 150kHz
Frequency stability	1PPM
RF frequency steps	10 kHz
Phase response	0.01° linear phase, 53kHz–100kHz
Modulation capability	± 165kHz

INSTALLATION REQUIREMENTS

Power supply	110–230V _{ac} single-phase
Power consumption (typical)	See “Spec” table, <i>Consumption</i> column
Recommended wiring section	2.5mm ² /AWG13
Total current consumption (typical @ 230V _{ac})	See “Spec” table, <i>Current</i> column. Current absorption may increase in case of lower AC line voltage
Power factor	> 0.95

COOLING SYSTEM

Cooling system	Forced air–cooling (fans)
Air flow	240m ³ /h typical (20W to 700W models) 400m ³ /h typical (1000W to 2000W models)

NOISE DATA

Acoustic noise	< 65 phones @ transmitter room, 2m distance from front panel
----------------	---

ENVIRONMENT

Operating temperature	–5 to +45°C / 23 to 113°F –5 to +39°C / 23 to 102°F recommended
Operating humidity	95% non-condnsing @ 40°C / 104°F
Operating altitude	< 3000 meters / < 9840 feet
Storage temperature	–20 to +55°C / –4 to 131°F
Storage humidity	90% non-condnsing @ 55°C / 131°F
Storage altitude	< 15000 meters / < 49,200 feet

TELECONTROL AND TELEMETRY

Remote control	Yes
SNMP option	Yes

7.1.1 Individual models specific parameters

"SPEC" table in datasheet					
Model	Rated FWD	no. MOSFETs	Weight	Consumption	Current
ETG20	20 adjustable	1	7.9 kg (17.4lb)	60W	0.26A @ 230V _{ac}
ETG150	150 adjustable	1	9.4 kg (20.7lb)	230W	1A @ 230V _{ac}
ETG300	300 adjustable	1	9.4 kg (20.7lb)	430W	1.9A @ 230V _{ac}
ETG500	500 adjustable	1	9.4 kg (20.7lb)	570W	2.5A @ 230V _{ac}
ETG700	700 adjustable	1	9.4 kg (20.7lb)	800W	3.9A @ 230V _{ac}
ETG1000	1000 adjustable	2	13.2 kg (29.1lb)	1400W	6A @ 230V _{ac}
ETG1500	1500 adjustable	3	13.2 kg (29.1lb)	2000W	8.7A @ 230V _{ac}
ETG2000	2000 adjustable	3	13.2 kg (29.1lb)	2700W	11.7A @ 230V _{ac}

7.2 ETG models layouts

7.2.1 ETG 2000.20

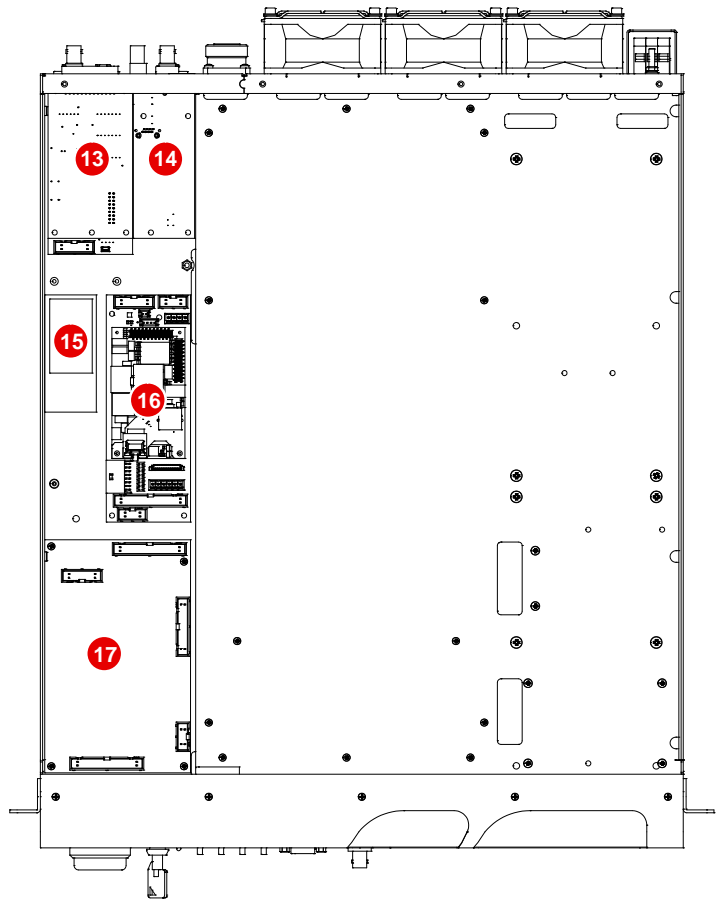
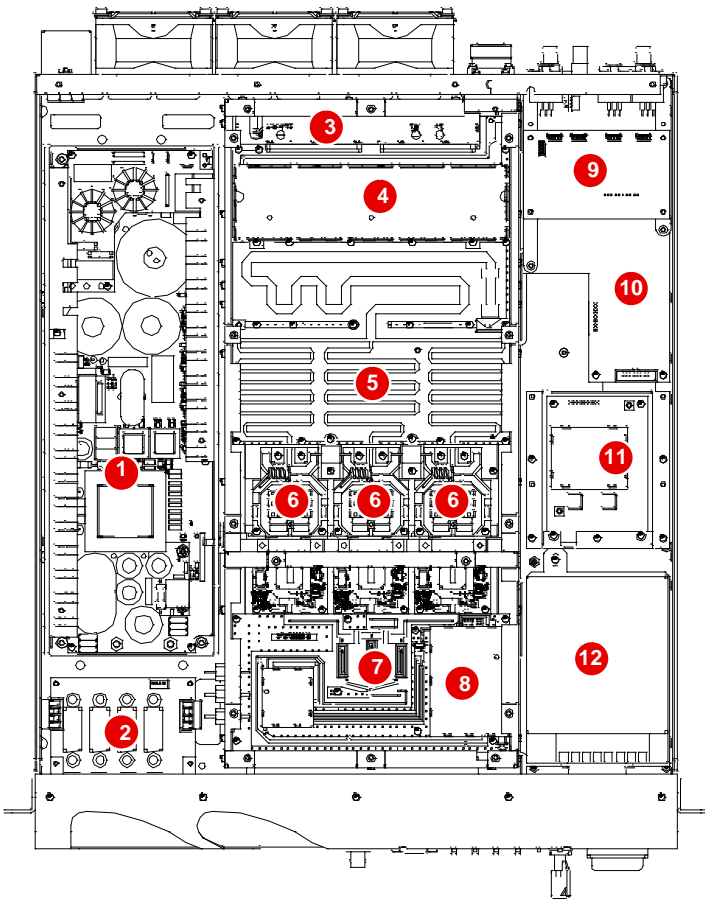
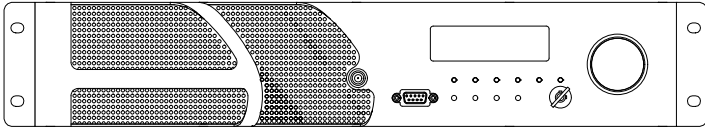

- 1 AC/DC Main Pwr Supply
- 2 DC/DC Pwr Supply
- 3 Output directional coupler
- 4 Output filter
- 5 Output combiner
- 6 Final stages
- 7 Input splitter
- 8 Driver stage
- 9 Audio inputs change-over
- 10 Stereo coder
- 11 VCO
- 12 AC/DC Service Pwr supply
- 13 TC/TS + Profiles boards
- 14 Interlock board
- 15 Backup battery
- 16 Aux + telemetry boards
- 17 CPU

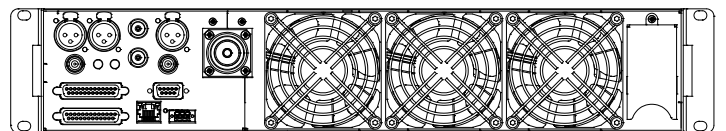

7.2.2 ETG 1500.15 ETG 1000.10

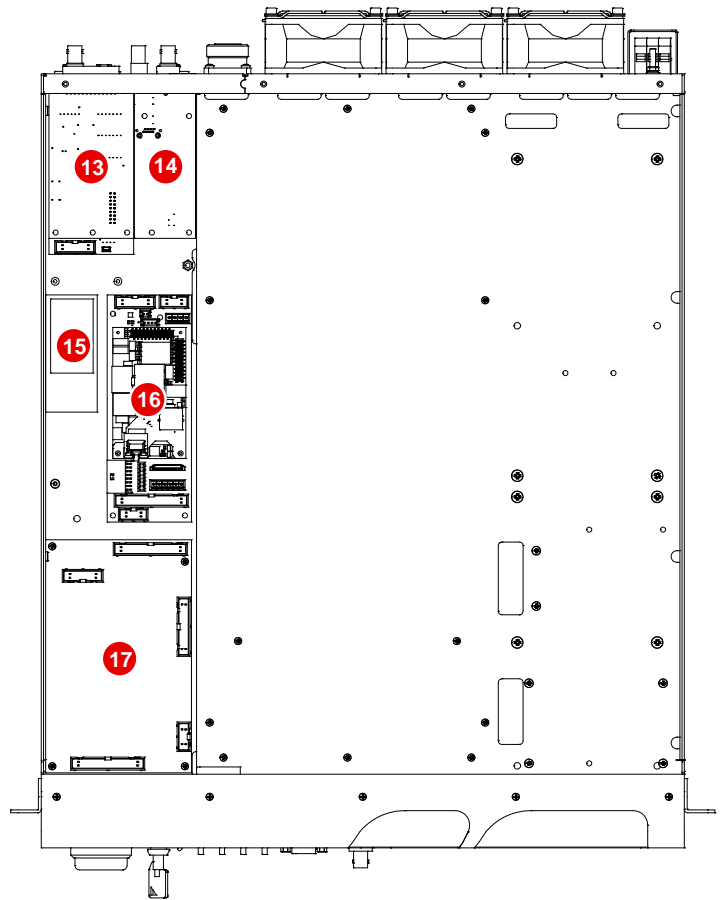
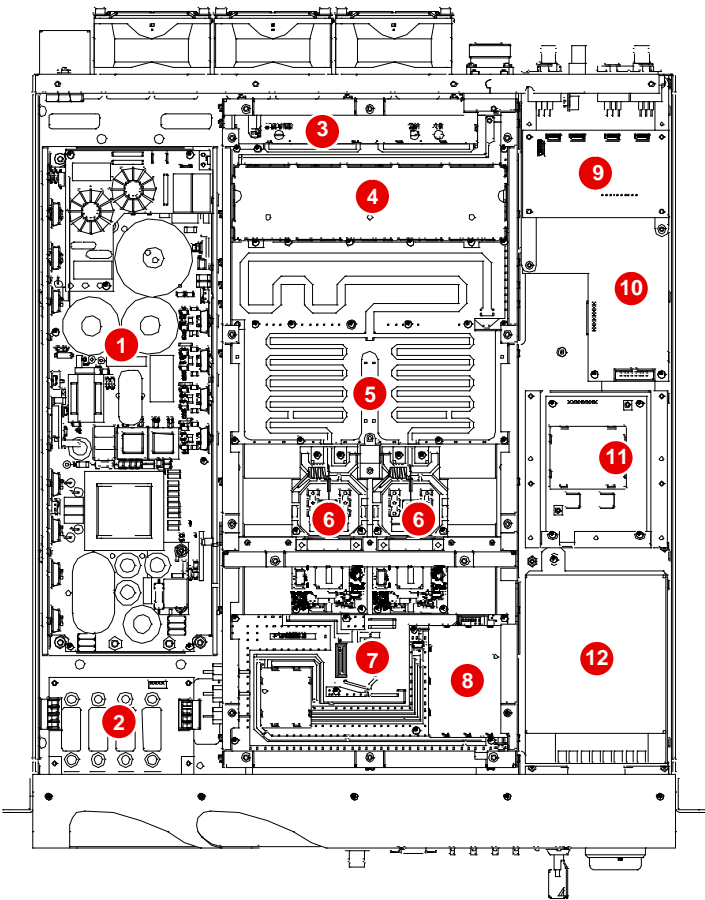
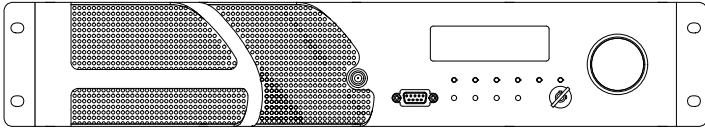

- | | |
|------------------------------|-----------------------------|
| 1 AC/DC Main Pwr Supply | 10 Stereo coder |
| 2 DC/DC Pwr Supply | 11 VCO |
| 3 Output directional coupler | 12 AC/DC Service Pwr supply |
| 4 Output filter | 13 TC/TS + Profiles boards |
| 5 Output combiner | 14 Interlock board |
| 6 Final stages | 15 Backup battery |
| 7 Input splitter | 16 Aux + telemetry boards |
| 8 Driver stage | 17 CPU |
| 9 Audio inputs change-over | |

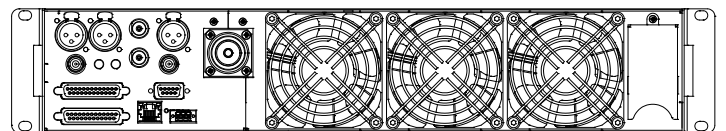

7.2.3 ETG 700.7 ETG 300.3
 ETG 500.5 ETG 150

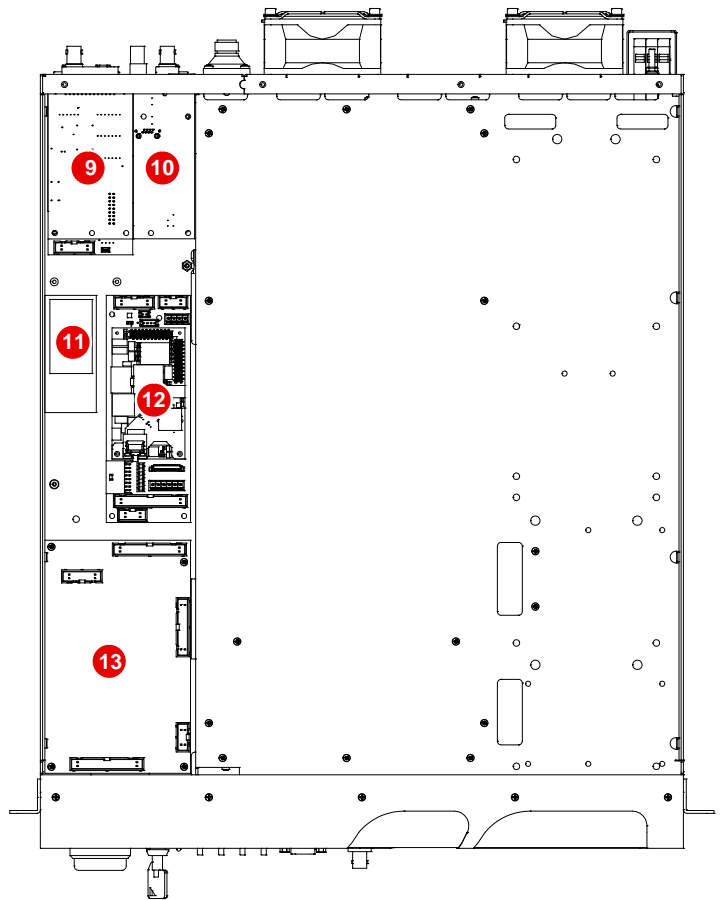
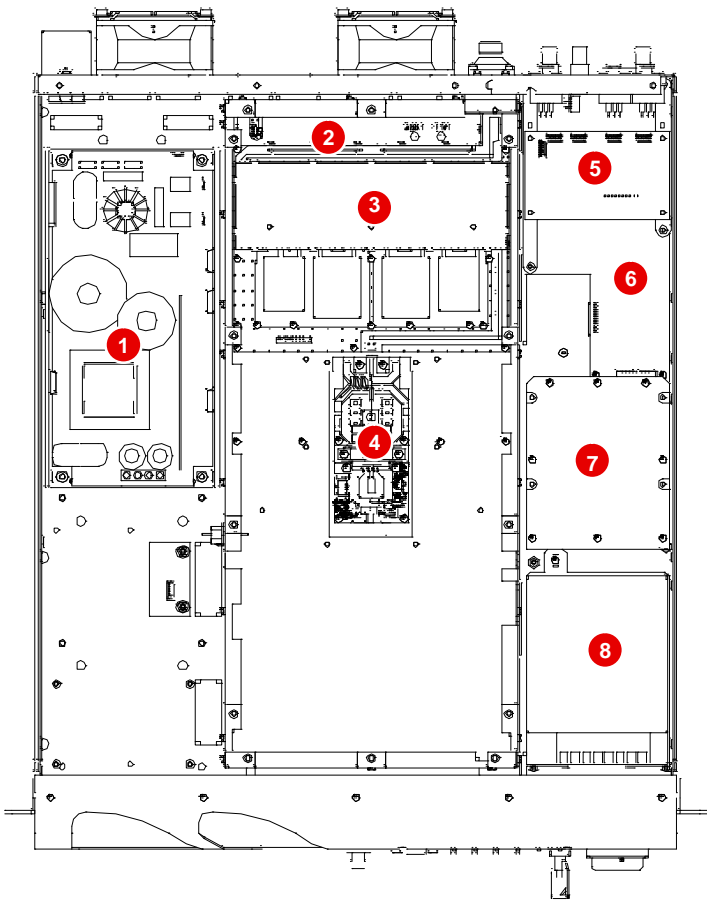
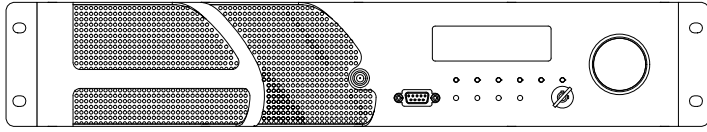

- | | |
|------------------------------|----------------------------|
| 1 AC/DC Main Pwr Supply | 8 AC/DC Service Pwr supply |
| 2 Output directional coupler | 9 TC/TS + Profiles boards |
| 3 Output filter | 10 Interlock board |
| 4 Final stage | 11 Backup battery |
| 5 Audio inputs change-over | 12 Aux + telemetry boards |
| 6 Stereo coder | 13 CPU |
| 7 VCO | |

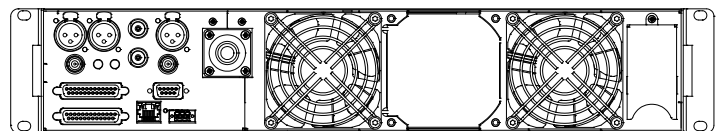

7.2.4 ETG 20

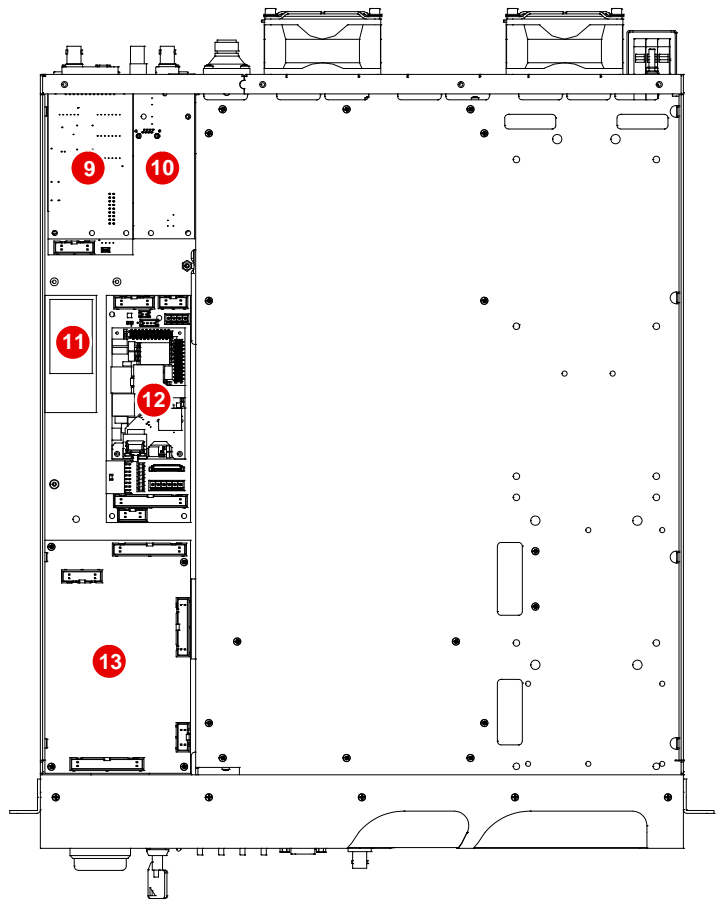
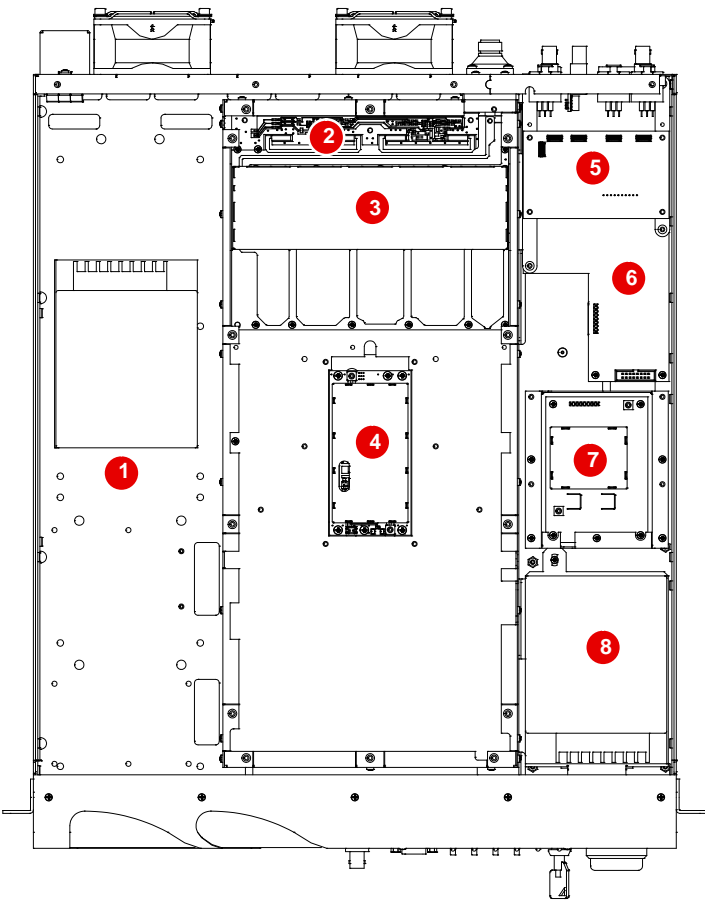
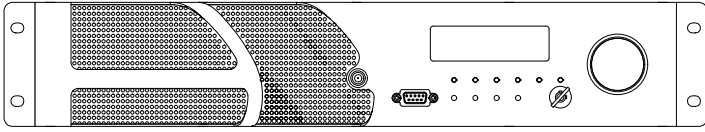

- | | |
|------------------------------|----------------------------|
| 1 AC/DC Main Pwr Supply | 8 AC/DC Service Pwr supply |
| 2 Output directional coupler | 9 TC/TS + Profiles boards |
| 3 Output filter | 10 Interlock board |
| 4 Final stage | 11 Backup battery |
| 5 Audio inputs change-over | 12 Aux + telemetry boards |
| 6 Stereo coder | 13 CPU |
| 7 VCO | |

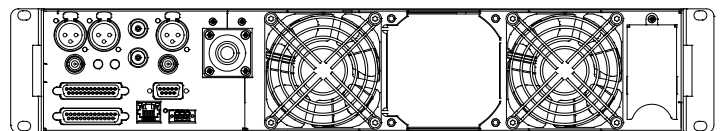

8 Maintenance

8 Maintenance **75**
8.1 Maintenance 76
8.1.1 Periodic checks and replacements 76

Datashet

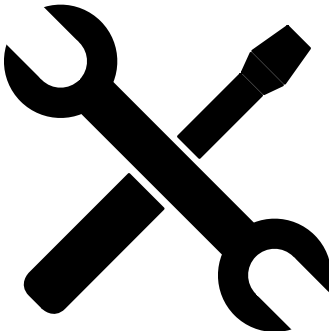

8.1 Maintenance

8.1.1 Periodic checks and replacements

CHECKS		
Periodicity		Intervention
Recommended when used under extreme conditions (temperature, humidity, dust, reflected power)	Needed under normal conditions	
2-weekly	monthly	Cleaning the air filters (<i>if arranged on board of the unit</i>)
monthly	6-monthly	Cleaning the front panel grid (<i>if the air filters are not arranged on board of the unit</i>)
3-monthly	Yearly	Verifying forward and reflected power values
3-monthly	Yearly	Verifying the proper fan working
3-monthly	Yearly	Verifying the conditions of the electrical connections
Yearly	2-yearly	Cleaning the fan blades
6-monthly	2-yearly	Verifying the conditions of the RF power transmission lines
6-monthly	Yearly	Verifying the current absorption of the power supplies (<i>as similar as possible</i>)
6-monthly	Yearly	Verifying the current value of each MOSFET
6-monthly	2-yearly	Cleaning from dust the environment where the unit is installed
6-monthly	Yearly	Performing the spectrum analysis
3-monthly	Yearly	Verifying the correct operating temperature of the MOSFETs
3-monthly	Yearly	Verifying the correct operating temperature of the power supplies
6-monthly	2-yearly	Presence of corrosion on connectors and boards