



MEASUREMENT REPORT

FCC PART 15.249 / RSS-210

FCC ID: DD4ULXD6X52

IC: 616A-ULXD6X52

APPLICANT: Shure Incorporated

Application Type: Certification

Product: Wireless Boundary Transmitter

Model No.: ULXD6/C X52, ULXD6/O X52

Brand Name: SHURE

FCC Classification: Low Power Communication Device Transmitter (DXX)

FCC Rule Part(s): Part 15.249

IC Rule(s): RSS-210 Issue 9, RSS-GEN Issue 4

Test Procedure(s): ANSI C63.10 - 2013

Test Date: August 06 ~ October 23, 2016

Reviewed By
Manager

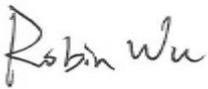
: 

(Robin Wu)

Approved By
CEO

: 

(Marlin Chen)



The test results relate only to the samples tested.

This equipment has been shown to be capable of compliance with the applicable technical standards as indicated in the measurement report and was tested in accordance with the measurement procedures specified in ANSI C63.10-2013. Test results reported herein relate only to the item(s) tested.

The test report shall not be reproduced except in full without the written approval of MRT Technology (Suzhou) Co., Ltd.

Revision History

Report No.	Version	Description	Issue Date	Note
1608RSU00402	Rev. 01	Initial report	10-23-2016	Valid

CONTENTS

Description	Page
1. INTRODUCTION	6
1.1. Scope	6
1.2. MRT Test Location	6
2. PRODUCT INFORMATION	7
2.1. Equipment Description.....	7
2.2. Product Specification Subjective to this Report.....	7
2.3. Operation Frequency and Channel List.....	8
2.4. Test Configuration	8
2.5. EMI Suppression Device(s)/Modifications.....	8
2.6. Labeling Requirements.....	8
2.7. Test Software	8
3. DESCRIPTION OF TEST	9
3.1. Evaluation Procedure	9
3.2. AC Line Conducted Emissions	9
3.3. Radiated Emissions.....	10
4. ANTENNA REQUIREMENTS.....	11
5. TEST EQUIPMENT CALIBRATION DATE.....	12
6. MEASUREMENT UNCERTAINTY.....	13
7. TEST RESULT	14
7.1. Summary	14
7.2. Conducted Emission.....	15
7.2.1. Test Limit	15
7.2.2. Test Setup.....	15
7.2.3. Test Result.....	16
7.3. Radiated Emission.....	18
7.3.1. Test Limit	18
7.3.2. Test Setup.....	19
7.3.3. Test Result.....	21
7.4. Radiated Restricted Band Edge Measurement	28
7.4.1. Test Result.....	28
7.5. 20dB Spectrum Bandwidth Measurement	30
7.5.1. Test Limit	30
7.5.2. Test Procedure used.....	30

7.5.3.	Test Setting.....	30
7.5.4.	Test Setup.....	30
7.5.5.	Test Result.....	31
7.6.	99% Bandwidth Measurement.....	32
7.6.1.	Test Limit.....	32
7.6.2.	Test Procedure used.....	32
7.6.3.	Test Setting.....	32
7.6.4.	Test Setup.....	32
7.6.5.	Test Result.....	33
8.	CONCLUSION.....	34

§2.1033 General Information

Applicant:	Shure Incorporated
Applicant Address:	5800 West Touhy Avenue, Niles, IL60714-4608, USA
Manufacturer:	Shure Incorporated
Manufacturer Address:	5800 West Touhy Avenue, Niles, IL60714-4608, USA
Test Site:	MRT Technology (Suzhou) Co., Ltd
Test Site Address:	D8 Building, Youxin Industrial Park, No.2 Tian'edang Rd., Wuzhong Economic Development Zone, Suzhou, China
MRT Registration No.:	809388
IC Registration No.:	11384A
FCC Rule Part(s):	Part 15.249
IC Rule:	RSS-210 Issue 9, RSS-GEN Issue 4
FCC ID:	DD4ULXD6X52
IC:	616A-ULXD6X52
Test Device Serial No.:	N/A <input type="checkbox"/> Production <input checked="" type="checkbox"/> Pre-Production <input type="checkbox"/> Engineering
FCC Classification:	Low Power Communication Device Transmitter (DXX)

Test Facility / Accreditations

Measurements were performed at MRT Laboratory located in Tian'edang Rd., Suzhou, China.

- MRT facility is a FCC registered (MRT Reg. No. 809388) test facility with the site description report on file and has met all the requirements specified in Section 2.948 of the FCC Rules.
- MRT facility is an IC registered (MRT Reg. No. 11384A-1) test laboratory with the site description on file at Industry Canada.
- MRT facility is a VCCI registered (R-4179, G-814, C-4664, T-2206) test laboratory with the site description on file at VCCI Council.
- MRT Lab is accredited to ISO 17025 by the American Association for Laboratory Accreditation (A2LA) under the American Association for Laboratory Accreditation Program (A2LA Cert. No. 3628.01) in EMC, Telecommunications and Radio testing for FCC, Industry Canada, EU and TELEC Rules.



1. INTRODUCTION

1.1. Scope

Measurement and determination of electromagnetic emissions (EMC) of radio frequency devices including intentional and/or unintentional radiators for compliance with the technical rules and regulations of the Federal Communications Commission and the Industry Canada Certification and Engineering Bureau.

1.2. MRT Test Location

The map below shows the location of the MRT LABORATORY, its proximity to the Taihu Lake. These measurement tests were conducted at the MRT Technology (Suzhou) Co., Ltd. Facility located at D8 Building, Youxin Industrial Park, No.2 Tian'edang Rd., Wuzhong Economic Development Zone, Suzhou, China. The detailed description of the measurement facility was found to be in compliance with the requirements of § 2.948 according to ANSI C63.4-2013 on September 30, 2013.



2. PRODUCT INFORMATION

2.1. Equipment Description

Product Name	Wireless Boundary Transmitter
Model No.	ULXD6/C X52, ULXD6/O X52
Frequency Range	X52 Band: 902 ~ 928 MHz
Working Mode	Normal Mode and HD Mode
Power Level	0.25mW & 10mW & 20mW
Antenna Type	PIFA
Antenna Gain	Max 0.97dBi
Components	
Rechargeable Li-ion Battery	Model: SB900A OUTPUT: 3.7Vdc, 1320mAh, 4.88Wh

Note 1: The EUT has two working modes (Normal Mode & HD Mode) and two modes can be switched from the digital wireless receiver.

Note 2: Normal mode has three power levels (0.25mW & 10mW & 20mW). Power levels are switchable among these power levels. HD mode means high density mode and it only has 0.25mW power level.

Note 3: The EUT is capable of operating with AA alkaline batteries or with the Shure SB900A rechargeable battery pack.

Note 4: The difference between ULXD6/C and ULXD6/O is that the EUT has different built-in MIC.

2.2. Product Specification Subjective to this Report

Working Mode	HD Mode
Frequency Range	902 ~ 928 MHz
Power Level	0.25mW
Type of Modulation	8PSK
Channel Spacing	25kHz
Date Rate	93.75kbps

Note: For other features of this EUT, test report will be issued separately.

2.3. Operation Frequency and Channel List

X52 band

Channel	Frequency
LOW	902.4 MHz
...	...
MID	915.0 MHz
...	...
HIG	927.6 MHz

2.4. Test Configuration

The **Wireless Boundary Transmitter FCC ID: DD4ULXD6X52** was tested as described in this report is in compliance with the requirements limits of FCC Rules Part 15.207,15.209, 15.215 and 15.249. ANSI C63.10-2013 was used to reference the appropriate EUT setup for radiated spurious emissions testing and AC line conducted testing.

2.5. EMI Suppression Device(s)/Modifications

No EMI suppression device(s) were added and/or no modifications were made during testing.

2.6. Labeling Requirements

Per 2.1074 & 15.19; Docket 95-19

The label shall be permanently affixed at a conspicuous location on the device; instruction manual or pamphlet supplied to the user and be readily visible to the purchaser at the time of purchase. However, when the device is so small wherein placement of the label with specified statement is not practical, only the FCC ID must be displayed on the device per Section 15.19(a)(5). Please see attachment for FCC ID label and label location.

2.7. Test Software

The test utility software used during testing was "ttermpro.exe".

3. DESCRIPTION OF TEST

3.1. Evaluation Procedure

The measurement procedures described in the American National Standard for Testing Unlicensed Wireless Devices (ANSI C63.10-2013), and the requirements provided in FCC 15.207, 15.209, 15.215 and 15.249 were performed in the report of the **Wireless Boundary Transmitter**.

Deviation from measurement procedure.....None

3.2. AC Line Conducted Emissions

The line-conducted facility is located inside an 8'x4'x4' shielded enclosure. A 1m x 2m wooden table 80cm high is placed 40cm away from the vertical wall and 80cm away from the sidewall of the shielded room. Two 10kHz-30MHz, 50Ω/50uH Line-Impedance Stabilization Networks (LISNs) are bonded to the shielded room floor. Power to the LISNs is filtered by external high-current high-insertion loss power line filters. These filters attenuate ambient signal noise from entering the measurement lines. These filters are also bonded to the shielded enclosure.

The EUT is powered from one LISN and the support equipment is powered from the second LISN. All interconnecting cables more than 1 meter were shortened to a 1 meter length by non-inductive bundling (serpentine fashion) and draped over the back edge of the test table. All cables were at least 40cm above the horizontal reference ground-plane. Power cables for support equipment were routed down to the second LISN while ensuring that that cables were not draped over the second LISN.

Sufficient time for the EUT, support equipment, and test equipment was allowed in order for them to warm up to their normal operating condition. The RF output of the LISN was connected to the receiver and exploratory measurements were made to determine the frequencies producing the maximum emission from the EUT. The receiver was scanned from 150kHz to 30MHz. The detector function was set to peak mode for exploratory measurements while the bandwidth of the analyzer was set to 9kHz. The EUT, support equipment, and interconnecting cables were arranged and manipulated to maximize each emission. Each emission was also maximized by varying: power lines, the mode of operation or data exchange speed, or support equipment whichever determined the worst-case emission. Once the worst case emissions have been identified, the one EUT cable configuration/arrangement and mode of operation that produced these emissions are used for final measurements on the same test site. The analyzer is set to CISPR quasi-peak and average detectors with a 9kHz resolution bandwidth for final measurements.

An extension cord was used to connect to a single LISN which powered by EUT. The extension cord was calibrated with LISN, the impedance and insertion loss are compliance with the requirements as stated in ANSI C63.10-2013.

Line conducted emissions test results are shown in Section 7.2.

3.3. Radiated Emissions

The radiated test facilities consisted of an indoor 3 meter semi-anechoic chamber used for final measurements and exploratory measurements, when necessary. The measurement area is contained within the semi-anechoic chamber which is shielded from any ambient interference. For measurements above 1GHz absorbers are arranged on the floor between the turn table and the antenna mast in such a way so as to maximize the reduction of reflections. For measurements below 1GHz, the absorbers are removed. A MF Model 210SS turntable is used for radiated measurement. It is a continuously rotatable, remote controlled, metallic turntable and 2 meters (6.56 ft.) in diameter. The turn table is flush with the raised floor of the chamber in order to maintain its function as a ground plane. An 80cm high PVC support structure is placed on top of the turntable.

For all measurements, the spectrum was scanned through all EUT azimuths and from 1 to 4 meter receive antenna height using a broadband antenna from 30MHz up to the upper frequency shown in 15.33(b)(1) depending on the highest frequency generated or used in the device or on which the device operates or tunes. For frequencies above 1GHz, linearly polarized double ridge horn antennas were used. For frequencies below 30MHz, a calibrated loop antenna was used. When exploratory measurements were necessary, they were performed at 1 meter test distance inside the semi-anechoic chamber using broadband antennas, broadband amplifiers, and spectrum analyzers to determine the frequencies and modes producing the maximum emissions. Sufficient time for the EUT, support equipment, and test equipment was allowed in order for them to warm up to their normal operating condition. The test set-up for frequencies below 1GHz was placed on top of the 0.8 meter high, 1 x 1.5 meter table; and test set-up for frequencies 1-25GHz was placed on top of the 1.5 meter high, 1 x 1.5 meter table. The EUT, support equipment, and interconnecting cables were arranged and manipulated to maximize each emission. Appropriate precaution was taken to ensure that all emissions from the EUT were maximized and investigated. The system configuration, clock speed, mode of operation or video resolution, if applicable, turntable azimuth, and receive antenna height was noted for each frequency found.

Final measurements were made in the semi-anechoic chamber using calibrated, linearly polarized broadband and horn antennas. The test setup was configured to the setup that produced the worst case emissions. The spectrum analyzer was set to investigate all frequencies required for testing to compare the highest radiated disturbances with respect to the specified limits. The turntable containing the EUT was rotated through 360 degrees and the height of the receive antenna was varied 1 to 4 meters and stopped at the azimuth and height producing the maximum emission. Each emission was maximized by changing the orientation of the EUT through three orthogonal planes and changing the polarity of the receive antenna, whichever produced the worst-case emissions. According to 3dB Beam-Width of horn antenna, the horn antenna should be always directed to the EUT when rising height.

4. ANTENNA REQUIREMENTS

Excerpt from §15.203 of the FCC Rules/Regulations:

“An intentional radiator antenna shall be designed to ensure that no antenna other than that furnished by the responsible party can be used with the device. The use of a permanently attached antenna or of an antenna that uses a unique coupling to the intentional radiator shall be considered sufficient to comply with the provisions of this section.”

- The antenna of the **Wireless Boundary Transmitter is permanently attached.**
- There are no provisions for connection to an external antenna.

Conclusion:

The **Wireless Boundary Transmitter FCC ID: DD4ULXD6X52** unit complies with the requirement of §15.203.

5. TEST EQUIPMENT CALIBRATION DATE

Conducted Emissions - SR2

Instrument	Manufacturer	Type No.	Serial No.	Cali. Interval	Cali. Due Date
EMI Test Receiver	R&S	ESR7	101209	1 year	2016/11/03
Two-Line V-Network	R&S	ENV216	101683	1 year	2016/11/03
Two-Line V-Network	R&S	ENV216	101684	1 year	2016/11/03
Temperature/Humidity Meter	Yuhuaze	N/A	N/A	1 year	2016/12/20
Shielding Anechoic Chamber	MIX-BEP	Chamber-SR2	N/A	1 year	2017/05/10

Radiated Emission - AC1

Instrument	Manufacturer	Type No.	Serial No.	Cali. Interval	Cali. Due Date
MXE EMI Receiver	Agilent	N9038A	MY51210182	1 year	2017/08/03
Preamplifier	Agilent	83017A	MY52090106	1 year	2017/03/28
Loop Antenna	Schwarzbeck	FMZB1519	1519-041	1 year	2016/12/14
TRILOG Antenna	Schwarzbeck	VULB9162	9162-047	1 year	2016/11/07
Broad-Band Horn Antenna	Schwarzbeck	BBHA9120D	9120D-1167	1 year	2016/11/07
Digital Thermometer & Hygrometer	Yuhuaze	HTC-2	N/A	1 year	2016/12/20
Anechoic Chamber	TDK	Chamber-AC1	N/A	1 year	2017/05/10

Conducted Test Equipment - TR3

Instrument	Manufacturer	Type No.	Serial No.	Cali. Interval	Cali. Due Date
Spectrum Analyzer	Agilent	N9020A	MY52090106	1 year	2017/05/08
Temperature/Humidity Meter	Yuhuaze	HTC-2	N/A	1 year	2016/12/20

Software	Version	Function
e3	V8.3.5	EMI Test Software

6. MEASUREMENT UNCERTAINTY

Where relevant, the following test uncertainty levels have been estimated for tests performed on the EUT as specified in CISPR 16-4-2. This uncertainty represents an expanded uncertainty expressed at approximately the 95% confidence level using a coverage factor of $k = 2$.

AC Conducted Emission Measurement - SR2
Measuring Uncertainty for a Level of Confidence of 95% ($U=2Uc(y)$): 150kHz~30MHz: 3.46dB
Radiated Emission Measurement - AC1
Measuring Uncertainty for a Level of Confidence of 95% ($U=2Uc(y)$): 9kHz ~ 1GHz: 4.18dB 1GHz ~ 25GHz: 4.76dB
20dB Spectrum Bandwidth - TR3
Measuring Uncertainty for a Level of Confidence of 95% ($U=2Uc(y)$): 0.28%

7. TEST RESULT

7.1. Summary

Company Name: Shure Incorporated

Data Rate(s) Tested: 93.75kbps

FCC Part Section(s)	Test Description	Test Limit	Test Condition	Test Result	Reference
15.207	AC Conducted Emissions 150kHz - 30MHz	< FCC 15.207 limits	Line Conducted	Pass	Section 7.2
15.209 15.249	General Field Strength Limits (Restricted Bands and Radiated Emission Limits)	Emissions in restricted bands must meet the radiated limits detailed in 15.209	Radiated	Pass	Section 7.3 & 7.4
15.215(c)	20dB Spectrum Bandwidth	20 dB bandwidth of the emission in the specific band	Conducted	Pass	Section 7.5

RSS Section(s)	Test Description	Test Limit	Test Condition	Test Result	Reference
RSS-Gen Clause 8.8	AC Conducted Emissions 150kHz - 30MHz	< RSS-Gen Clause 8.8 limits	Line Conducted	Pass	Section 7.2
RSS-210 Clause 8.9 Annex A2.9	General Field Strength Limits (Restricted Bands and Radiated Emission Limits)	Emissions in restricted bands must meet the radiated limits detailed in clause 8.10	Radiated	Pass	Section 7.3 & 7.4
RSS-GEN Clause 6.6	99% Occupied Bandwidth	N/A	Conducted	Pass	Section 7.6

Notes:

- 1) All modes of operation and data rates were investigated. For radiated emission test, every axis (X, Y, Z) was also verified. The test results shown in the following sections represent the worst case emissions.
- 2) The analyzer plots shown in this section were all taken with a correction table loaded into the analyzer. The correction table was used to account for the losses of the cables and attenuators used as part of the system to connect the EUT to the analyzer at all frequencies of interest.
- 3) All antenna port conducted emissions testing was performed on a test bench with the antenna port of the EUT connected to the spectrum analyzer through calibrated cables and attenuators.

7.2. Conducted Emission

7.2.1. Test Limit

FCC Part 15 Subpart C Paragraph 15.207 Limits		
Frequency (MHz)	QP (dBuV)	AV (dBuV)
0.15 - 0.50	66 - 56	56 - 46
0.50 - 5.0	56	46
5.0 - 30	60	50

Note 1: The lower limit shall apply at the transition frequencies.

Note 2: The limit decreases linearly with the logarithm of the frequency in the range 0.15 MHz to 0.5 MHz.

7.2.2. Test Setup

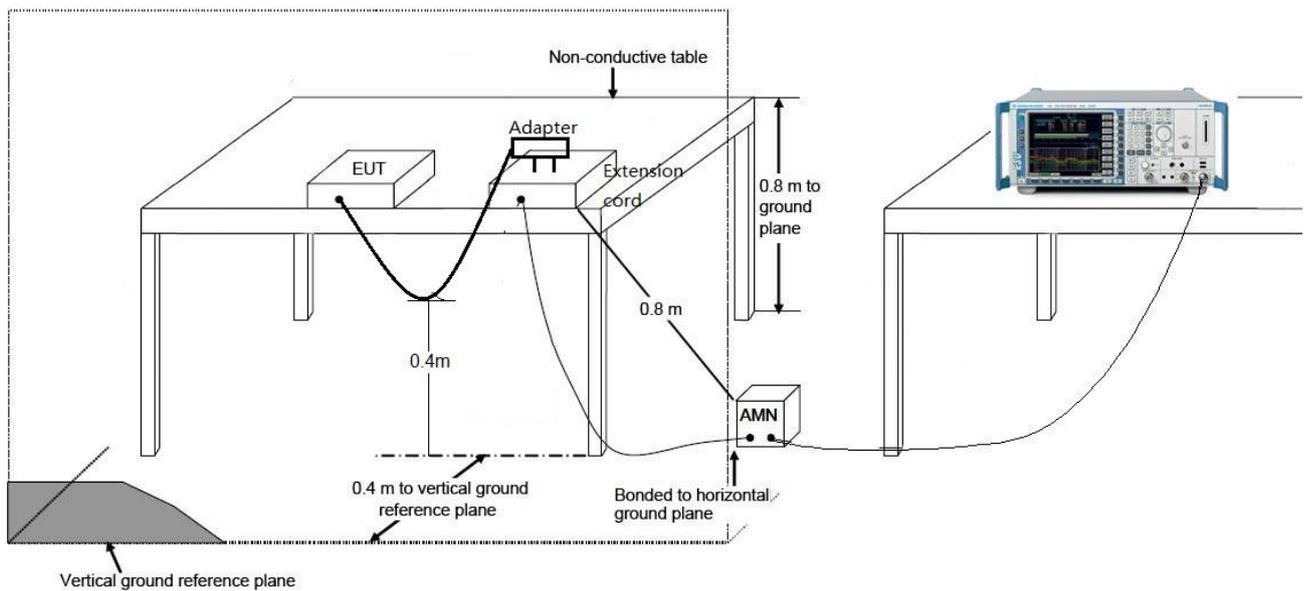

7.2.3. Test Result

Site: SR2	Time: 2016/08/24 - 00:19
Limit: FCC_Part15.207_CE_AC Power	Engineer: Lewis Huang
Probe: ENV216_101683_Filter On	Polarity: Line
EUT: Wireless Boundary Transmitter	Power: AC 120V/60Hz
Mode 1: Transmit at Channel 915.0MHz	

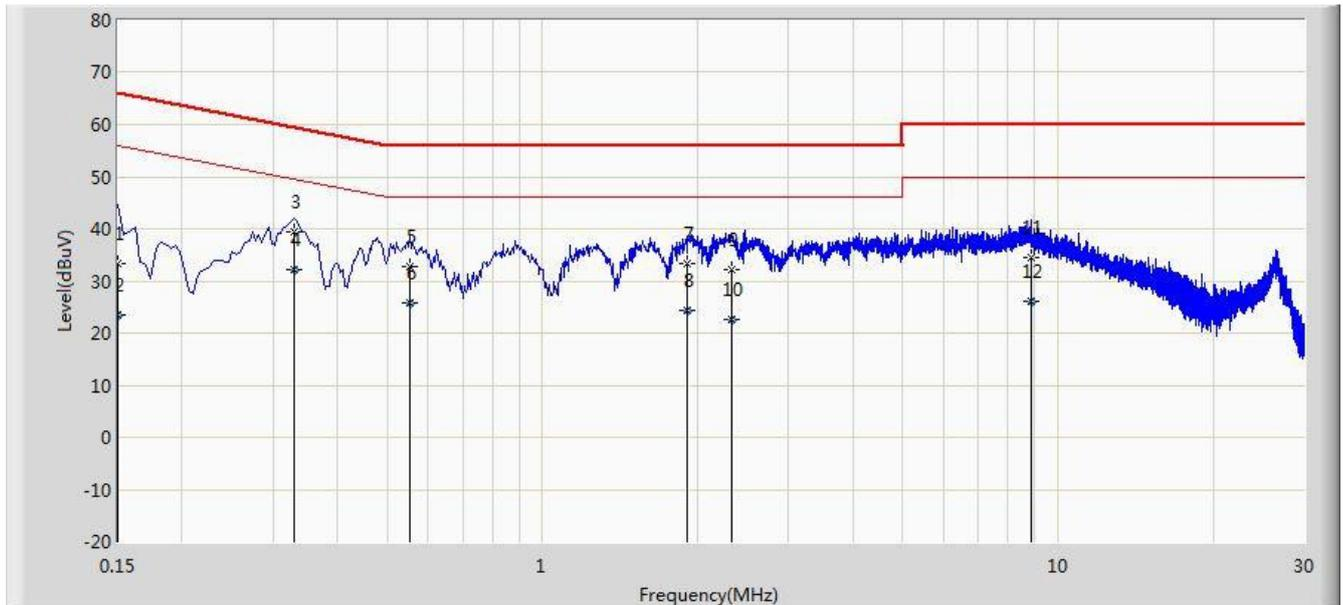

No	Flag	Mark	Frequency (MHz)	Measure Level (dBuV)	Reading Level (dBuV)	Over Limit (dB)	Limit (dBuV)	Factor (dB)	Type
1			0.150	33.424	22.255	-32.576	66.000	11.168	QP
2			0.150	23.500	12.331	-32.500	56.000	11.168	AV
3			0.330	39.280	29.251	-20.172	59.451	10.028	QP
4		*	0.330	32.197	22.169	-17.254	49.451	10.028	AV
5			0.554	32.754	22.615	-23.246	56.000	10.139	QP
6			0.554	25.694	15.555	-20.306	46.000	10.139	AV
7			1.906	33.439	23.564	-22.561	56.000	9.875	QP
8			1.906	24.209	14.334	-21.791	46.000	9.875	AV
9			2.334	32.216	22.354	-23.784	56.000	9.863	QP
10			2.334	22.641	12.779	-23.359	46.000	9.863	AV
11			8.846	34.400	24.246	-25.600	60.000	10.155	QP
12			8.846	26.225	16.070	-23.775	50.000	10.155	AV

Note: Measure Level (dBμV) = Reading Level (dBμV) + Factor (dB)

Factor (dB) = Cable Loss (dB) + LISN Factor (dB)

Site: SR2	Time: 2016/08/24 - 00:24
Limit: FCC_Part15.207_CE_AC Power	Engineer: Lewis Huang
Probe: ENV216_101683_Filter On	Polarity: Neutral
EUT: Wireless Boundary Transmitter	Power: AC 120V/60Hz
Mode 1: Transmit at Channel 915.0MHz	

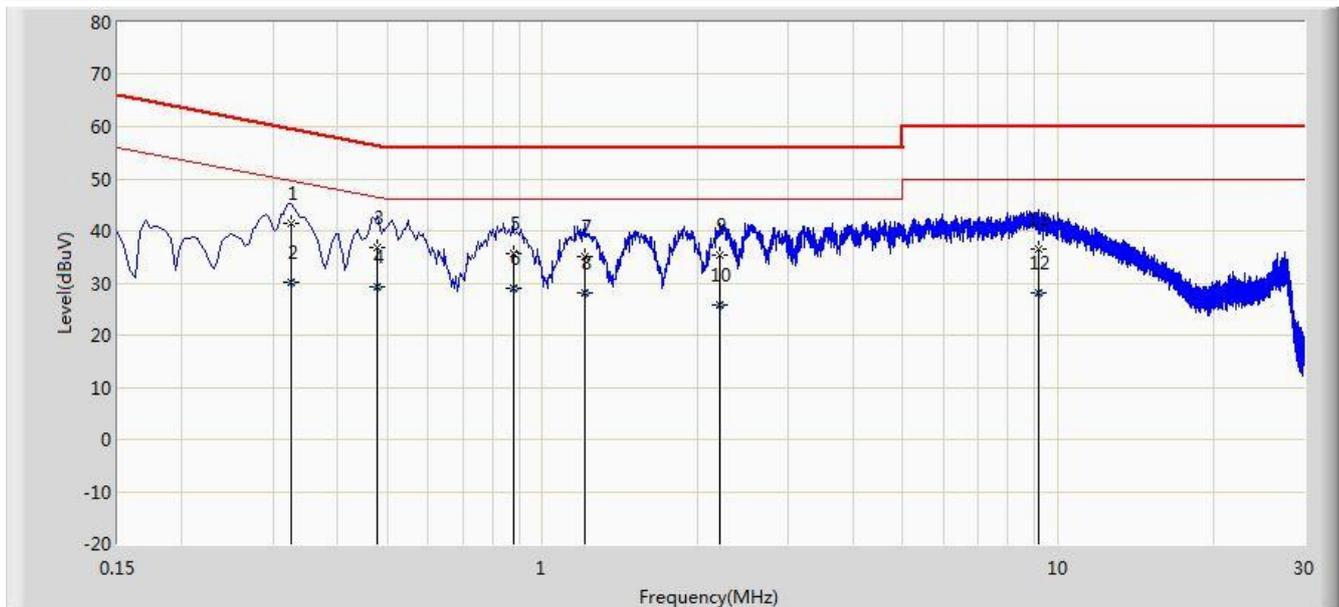

No	Flag	Mark	Frequency (MHz)	Measure Level (dBuV)	Reading Level (dBuV)	Over Limit (dB)	Limit (dBuV)	Factor (dB)	Type
1			0.326	41.504	31.447	-18.048	59.552	10.057	QP
2			0.326	30.235	20.178	-19.317	49.552	10.057	AV
3			0.478	36.947	26.776	-19.427	56.374	10.170	QP
4		*	0.478	29.319	19.149	-17.054	46.374	10.170	AV
5			0.878	35.595	25.619	-20.405	56.000	9.976	QP
6			0.878	28.921	18.945	-17.079	46.000	9.976	AV
7			1.206	35.128	25.226	-20.872	56.000	9.902	QP
8			1.206	27.990	18.088	-18.010	46.000	9.902	AV
9			2.210	35.281	25.412	-20.719	56.000	9.869	QP
10			2.210	25.902	16.033	-20.098	46.000	9.869	AV
11			9.158	36.608	26.423	-23.392	60.000	10.186	QP
12			9.158	28.115	17.929	-21.885	50.000	10.186	AV

Note: Measure Level (dBμV) = Reading Level (dBμV) + Factor (dB)

Factor (dB) = Cable Loss (dB) + LISN Factor (dB)

7.3. Radiated Emission

7.3.1. Test Limit

FCC Part 15 Subpart C Paragraph 15.209		
Frequency (MHz)	Field Strength (microvolts/meter)	Measurement Distance (uV/m)
0.009-0.490	2400/F(kHz)	300
0.490-1.705	24000/F(kHz)	30
1.705-30.0	30	30
30-80	100**	3
80-216	150**	3
216-960	200**	3
Above 960	500	3

Note 1: The lower limit shall apply at the transition frequency.

Note 2: Distance refers to the distance in meters between the measuring instrument antenna and the closed point of any part of the device or system.

Note 3: E field strength (dBuV/m) = 20 log E field strength (uV/m).

FCC Part 15 Subpart C Paragraph 15.249		
Fundamental Frequency	Field Strength of Fundamental (millivolts/meter)	Field Strength of Harmonics (microvolts/meter)
902-928(MHz)	50	500
2400-2483.5(MHz)	50	500
5725-5875(MHz)	50	500
24.0-24.25(GHz)	250	2500

FCC Part 15.249 (d), Emissions radiated outside of the specified frequency bands, except for harmonics, shall be attenuated by at least 50 dB below the level of the fundamental or to the general

radiated emission limits in §15.209, whichever is the lesser attenuation.

7.3.2. Test Setup

9kHz ~ 30MHz Test Setup:

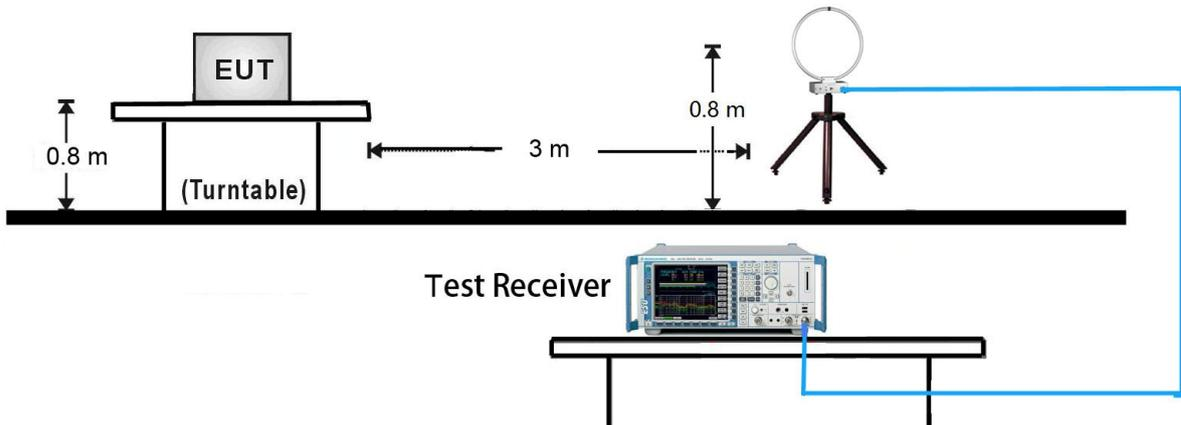

30MHz ~ 1GHz Test Setup:

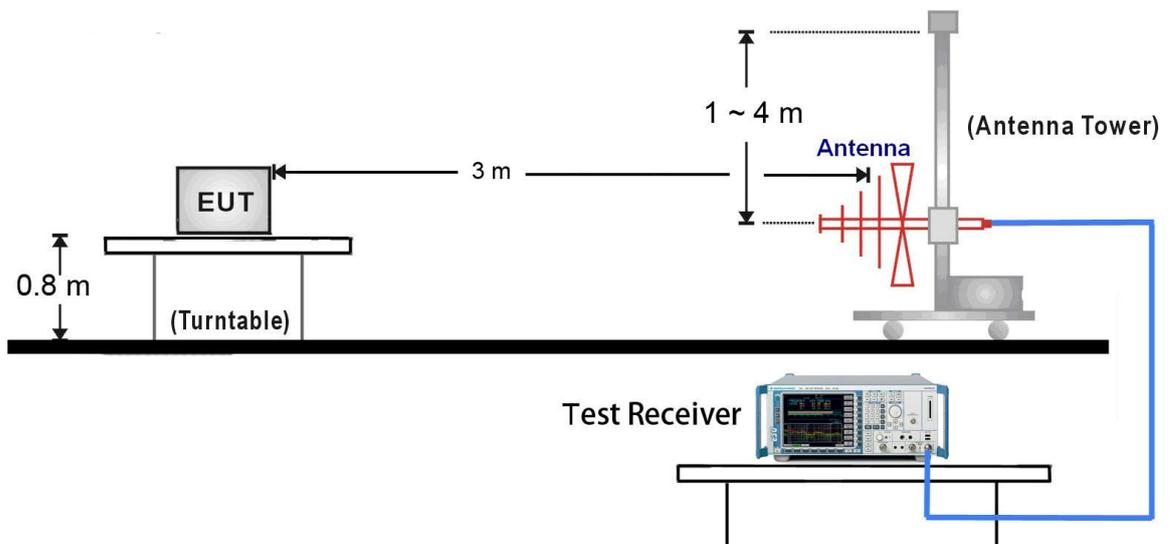

1GHz ~ 10GHz Test Setup:

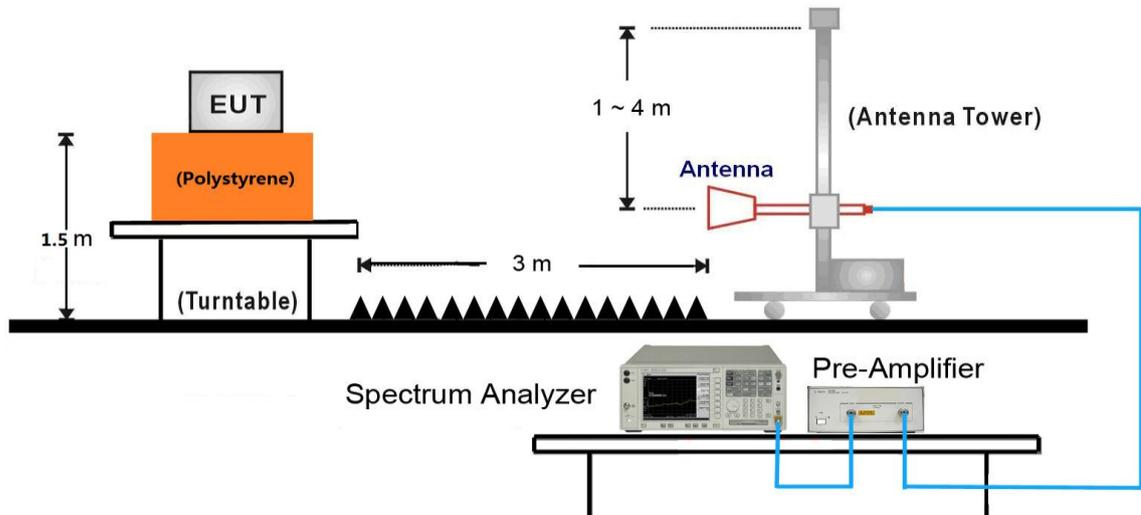

7.3.3. Test Result

Test Mode:	X52 Band 0.25mW	Test Site:	AC1
Remark:	Fundamental Radiated Emission	Test Engineer:	Lewis Huang

Frequency (MHz)	Reading Level (dB μ V)	Factor (dB)	Measure Level (dB μ V/m)	Limit (dB μ V/m)	Margin (dB)	Detector	Polarization
902.4	66.95	24.38	91.33	114	-22.67	PK	Horizontal
	58.85	24.38	83.23	114	-30.77	PK	Vertical
915.0	67.32	24.57	91.70	114	-22.30	PK	Horizontal
	57.74	24.57	82.12	114	-31.88	PK	Vertical
927.6	66.26	24.73	90.64	114	-23.36	PK	Horizontal
	56.85	24.73	81.23	114	-32.77	PK	Vertical

Note 1: Measure Level (dB μ V/m) = Reading Level (dB μ V) + Factor (dB)

Factor (dB) = Cable Loss (dB) + Antenna Factor (dB/m)

Note 2: All readings below 1GHz are peak, above 1GHz are performed with peak and/or average measurements as necessary.

Note 3: Average measurement was not performed when the peak level lower than average limit.

Test Mode:	X52 Band 0.25mW	Test Site:	AC1
Frequency	902.4MHz	Test Engineer:	Lewis Huang
Remark:	Harmonic Radiated Emission		

Frequency (MHz)	Reading Level (dB μ V)	Factor (dB)	Measure Level (dB μ V/m)	Limit (dB μ V/m)	Margin (dB)	Detector	Polarization
1804.8	40.1	-6.9	33.2	74.0	-40.8	PK	Horizontal
2707.2	37.9	-2.7	35.2	74.0	-38.8	PK	Horizontal
3609.6	35.8	-0.7	35.1	74.0	-38.9	PK	Horizontal
4512.0	34.4	1.7	36.1	74.0	-37.9	PK	Horizontal
1804.8	39.5	-6.9	32.6	74.0	-41.4	PK	Vertical
2707.2	37.6	-2.7	34.9	74.0	-39.1	PK	Vertical
3609.6	35.5	-0.7	34.8	74.0	-39.2	PK	Vertical
4512.0	35.0	1.7	36.7	74.0	-37.3	PK	Vertical

Note 1: Measure Level (dB μ V/m) = Reading Level (dB μ V) + Factor (dB)

Factor (dB) = Cable Loss (dB) + Antenna Factor (dB/m) – Pre Amplifier Gain (dB)

Note 2: Average measurement was not performed when the peak level lower than average limit.

Test Mode:	X52 Band 0.25mW	Test Site:	AC1
Frequency	915.0MHz	Test Engineer:	Lewis Huang
Remark:	Harmonic Radiated Emission		

Frequency (MHz)	Reading Level (dB μ V)	Factor (dB)	Measure Level (dB μ V/m)	Limit (dB μ V/m)	Margin (dB)	Detector	Polarization
1830.0	39.4	-6.8	32.6	74.0	-41.4	PK	Horizontal
2745.0	38.4	-2.5	35.9	74.0	-38.1	PK	Horizontal
3660.0	35.6	-0.6	35.0	74.0	-39.0	PK	Horizontal
4575.0	34.3	1.9	36.2	74.0	-37.8	PK	Horizontal
1830.0	40.1	-6.8	33.3	74.0	-40.7	PK	Vertical
2745.0	38.2	-2.5	35.7	74.0	-38.3	PK	Vertical
3660.0	35.7	-0.6	35.1	74.0	-38.9	PK	Vertical
4575.0	36.1	1.9	38.0	74.0	-36.0	PK	Vertical

Note 1: Measure Level (dB μ V/m) = Reading Level (dB μ V) + Factor (dB)

Factor (dB) = Cable Loss (dB) + Antenna Factor (dB/m) – Pre Amplifier Gain (dB)

Note 2: Average measurement was not performed when the peak level lower than average limit.

Test Mode:	X52 Band 0.25mW	Test Site:	AC1
Frequency	927.6MHz	Test Engineer:	Lewis Huang
Remark:	Harmonic Radiated Emission		

Frequency (MHz)	Reading Level (dBμV)	Factor (dB)	Measure Level (dBμV/m)	Limit (dBμV/m)	Margin (dB)	Detector	Polarization
1855.2	38.7	-6.6	32.1	74.0	-41.9	PK	Horizontal
2782.8	37.7	-2.4	35.3	74.0	-38.7	PK	Horizontal
3710.4	35.3	-0.5	34.8	74.0	-39.2	PK	Horizontal
4638.0	33.7	2.1	35.8	74.0	-38.2	PK	Horizontal
1884.0	46.6	-6.4	40.2	74.0	-33.8	PK	Vertical
2782.8	37.2	-2.4	34.8	74.0	-39.2	PK	Vertical
3710.4	35.4	-0.5	34.9	74.0	-39.1	PK	Vertical
4638.0	34.4	2.1	36.5	74.0	-37.5	PK	Vertical

Note 1: Measure Level (dBμV/m) = Reading Level (dBμV) + Factor (dB)

Factor (dB) = Cable Loss (dB) + Antenna Factor (dB/m) – Pre Amplifier Gain (dB)

Note 2: Average measurement was not performed when the peak level lower than average limit.

Test Mode:	X52 Band 0.25mW	Test Site:	AC1
Frequency	902.4MHz	Test Engineer:	Lewis Huang
Remark:	The worst case of General Radiated Emission		

Frequency (MHz)	Reading Level (dB μ V)	Factor (dB)	Measure Level (dB μ V/m)	Limit (dB μ V/m)	Margin (dB)	Detector	Polarization
415.6	1.8	16.9	18.7	46.0	-27.3	QP	Horizontal
658.6	2.2	21.5	23.7	46.0	-22.3	QP	Horizontal
510.6	2.7	18.7	21.4	46.0	-24.6	QP	Vertical
740.5	2.1	22.6	24.7	46.0	-21.3	QP	Vertical
1450.5	42.5	-7.8	34.7	74.0	-39.3	PK	Horizontal
2275.0	39.8	-3.4	36.4	74.0	-37.6	PK	Horizontal
2224.0	40.3	-3.5	36.8	74.0	-37.2	PK	Vertical
3686.0	37.4	-0.6	36.8	74.0	-37.2	PK	Vertical

Note 1: Measure Level (dB μ V/m) = Reading Level (dB μ V) + Factor (dB)

Factor (dB) = Cable Loss (dB) + Antenna Factor (dB/m) – Pre Amplifier Gain (dB)

Note 2: Average measurement was not performed when the peak level lower than average limit.

Note 3: The test trace is same as the ambient noise (the test frequency range: 9 kHz ~ 30 MHz), therefore no data appear in the report.

Test Mode:	X52 Band 0.25mW	Test Site:	AC1
Frequency	915.0MHz	Test Engineer:	Lewis Huang
Remark:	The worst case of General Radiated Emission		

Frequency (MHz)	Reading Level (dB μ V)	Factor (dB)	Measure Level (dB μ V/m)	Limit (dB μ V/m)	Margin (dB)	Detector	Polarization
632.4	3.8	21.1	24.9	46.0	-21.1	QP	Horizontal
851.6	2.8	23.7	26.5	46.0	-19.5	QP	Horizontal
497.5	1.4	18.4	19.8	46.0	-26.2	QP	Vertical
713.9	2.3	22.2	24.5	46.0	-21.5	QP	Vertical
2334.5	40.2	-3.6	36.6	74.0	-37.4	PK	Horizontal
3907.0	36.8	0.2	37.0	74.0	-37.0	PK	Horizontal
2215.5	40.1	-3.6	36.5	74.0	-37.5	PK	Vertical
4578.5	37.2	1.9	39.1	74.0	-34.9	PK	Vertical

Note 1: Measure Level (dB μ V/m) = Reading Level (dB μ V) + Factor (dB)

Factor (dB) = Cable Loss (dB) + Antenna Factor (dB/m) – Pre Amplifier Gain (dB)

Note 2: Average measurement was not performed when the peak level lower than average limit.

Note 3: The test trace is same as the ambient noise (the test frequency range: 9 kHz ~ 30 MHz), therefore no data appear in the report.

Test Mode:	X52 Band 0.25mW	Test Site:	AC1
Frequency	927.6MHz	Test Engineer:	Lewis Huang
Remark:	The worst case of General Radiated Emission		

Frequency (MHz)	Reading Level (dB μ V)	Factor (dB)	Measure Level (dB μ V/m)	Limit (dB μ V/m)	Margin (dB)	Detector	Polarization
471.4	0.3	18.1	18.4	46.0	-27.6	QP	Horizontal
747.8	1.9	22.7	24.6	46.0	-21.4	QP	Horizontal
649.3	1.7	21.4	23.1	46.0	-22.9	QP	Vertical
756.0	2.1	22.8	24.9	46.0	-21.1	QP	Vertical
2241.0	40.0	-3.5	36.5	74.0	-37.5	PK	Horizontal
3864.5	36.7	0.1	36.8	74.0	-37.2	PK	Horizontal
1442.0	41.8	-7.9	33.9	74.0	-40.1	PK	Vertical
1569.5	41.5	-7.7	33.8	74.0	-40.2	PK	Vertical

Note 1: Measure Level (dB μ V/m) = Reading Level (dB μ V) + Factor (dB)

Factor (dB) = Cable Loss (dB) + Antenna Factor (dB/m) – Pre Amplifier Gain (dB)

Note 2: Average measurement was not performed when the peak level lower than average limit.

Note 3: The test trace is same as the ambient noise (the test frequency range: 9 kHz ~ 30 MHz), therefore no data appear in the report.

7.4. Radiated Restricted Band Edge Measurement

7.4.1. Test Result

Site: AC1	Time: 2016/08/22 - 20:12
Limit: FCC_Part15.209_RE(3m)	Engineer: Lewis Huang
Probe: VULB 9168 _20-2000MHz	Polarity: Horizontal
EUT: Wireless Boundary Transmitter	Power: By Battery
Test Mode: Transmit by X52 Band at Channel 927.6MHz 0.25mW	

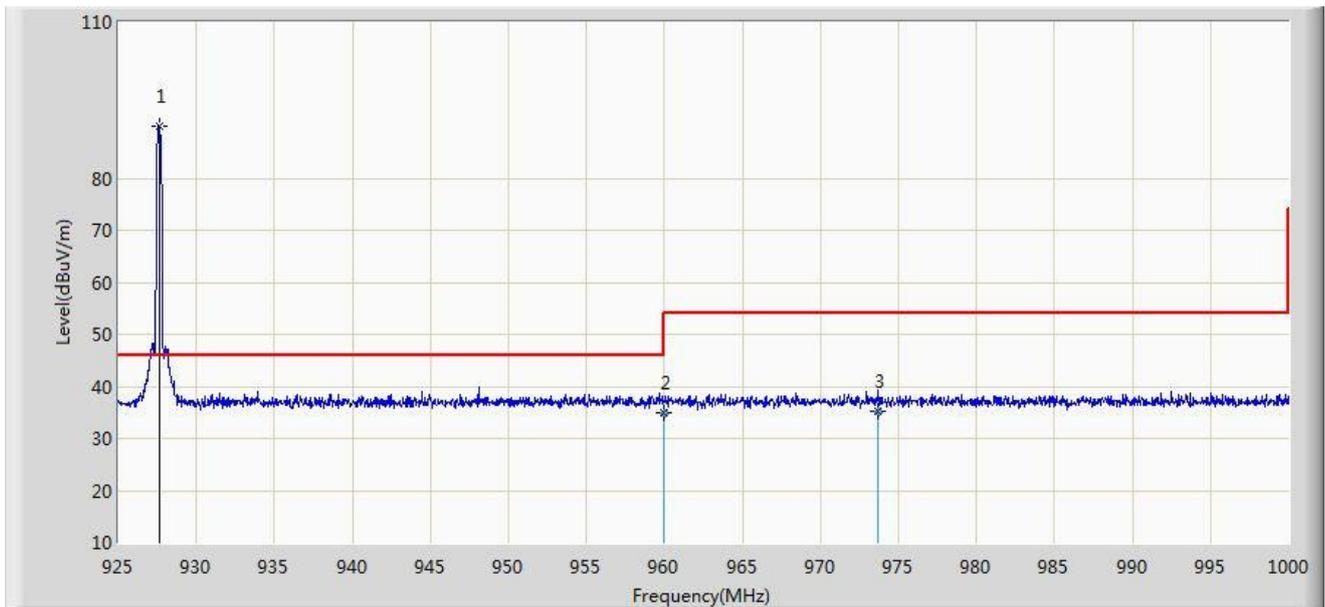

No	Flag	Mark	Frequency (MHz)	Measure Level (dBuV/m)	Reading Level (dBuV)	Over Limit (dB)	Limit (dBuV/m)	Factor	Type
1		*	927.625	90.042	65.308	N/A	N/A	24.734	PK
2			960.000	34.866	9.920	-11.134	46.000	24.946	QP
3			973.713	35.310	10.290	-18.690	54.000	25.020	QP

Note: Measure Level (dB μ V/m) = Reading Level (dB μ V) + Factor (dB)

Factor (dB) = Cable Loss (dB) + Antenna Factor (dB/m)

Site: AC1	Time: 2016/08/22 - 20:13
Limit: FCC_Part15.209_RE(3m)	Engineer: Lewis Huang
Probe: VULB 9168 _20-2000MHz	Polarity: Vertical
EUT: Wireless Boundary Transmitter	Power: By Battery
Test Mode: Transmit by X52 Band at Channel 927.6MHz 0.25mW	

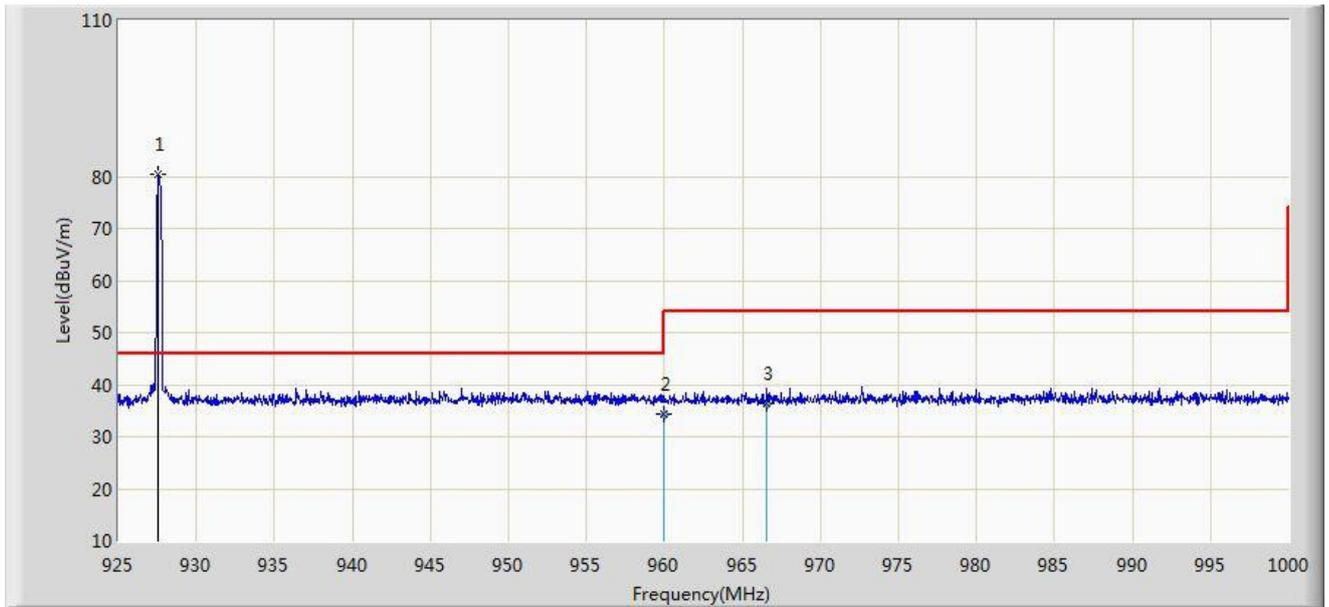

No	Flag	Mark	Frequency (MHz)	Measure Level (dBuV/m)	Reading Level (dBuV)	Over Limit (dB)	Limit (dBuV/m)	Factor	Type
1		*	927.550	80.361	55.627	N/A	N/A	24.734	PK
2			960.000	34.236	9.290	-11.764	46.000	24.946	QP
3			966.588	36.281	11.290	-17.719	54.000	24.990	QP

Note: Measure Level (dB μ V/m) = Reading Level (dB μ V) + Factor (dB)

Factor (dB) = Cable Loss (dB) + Antenna Factor (dB/m)

7.5. 20dB Spectrum Bandwidth Measurement

7.5.1. Test Limit

Intentional radiators must be designed to ensure that the 20 dB bandwidth of the emission in the specific band (902 ~ 928 MHz).

7.5.2. Test Procedure used

ANSI C63.10 Clause 6.9.2

7.5.3. Test Setting

1. Set the spectrum span range to overlap the nominal center frequency
2. Set RBW = 100 kHz
3. VBW $\geq 3 \times$ RBW
4. Detector = Peak
5. Trace mode = max hold
6. Sweep = auto couple
7. Allow the trace was allowed to stabilize and marker the highest level.
8. Determine the display level (the highest level - 20dB) and place two markers, one at the lowest frequency and the other at the highest frequency.

7.5.4. Test Setup

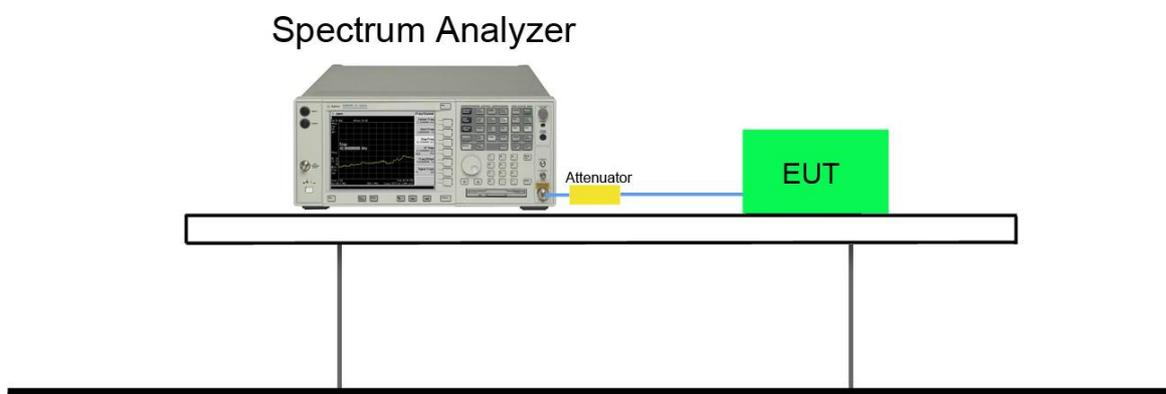

7.5.5. Test Result

Power Level (mW)	Frequency (MHz)	Frequency Range $F_L > 902\text{MHz}$	Frequency Range $F_H < 928\text{MHz}$	Result
0.25	902.4	902.376	---	Pass
	927.6	---	927.628	Pass

X52 Band 0.25mW - 20dB Spectrum Bandwidth

902.4 MHz

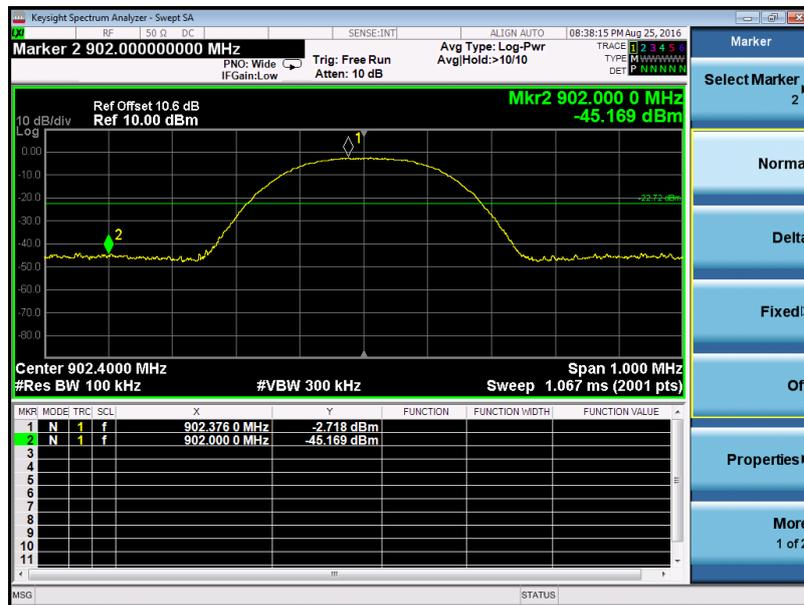

927.6 MHz

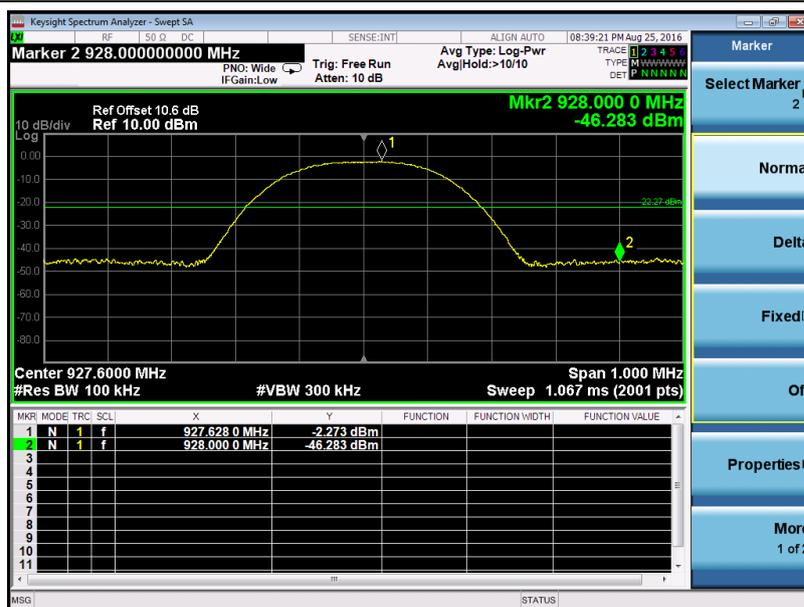

7.6. 99% Bandwidth Measurement

7.6.1. Test Limit

N/A

7.6.2. Test Procedure used

ANSI C63.10 Section 6.9

7.6.3. Test Setting

1. The analyzers' automatic bandwidth measurement capability was used to perform the 99% bandwidth measurement. The bandwidth measurement was not influenced by any intermediated power nulls in the fundamental emission.
2. RBW = approximately 1% to 5% of the OBW.
3. VBW $\geq 3 \times$ RBW.
4. Detector = Peak.
5. Trace mode = max hold.

7.6.4. Test Setup

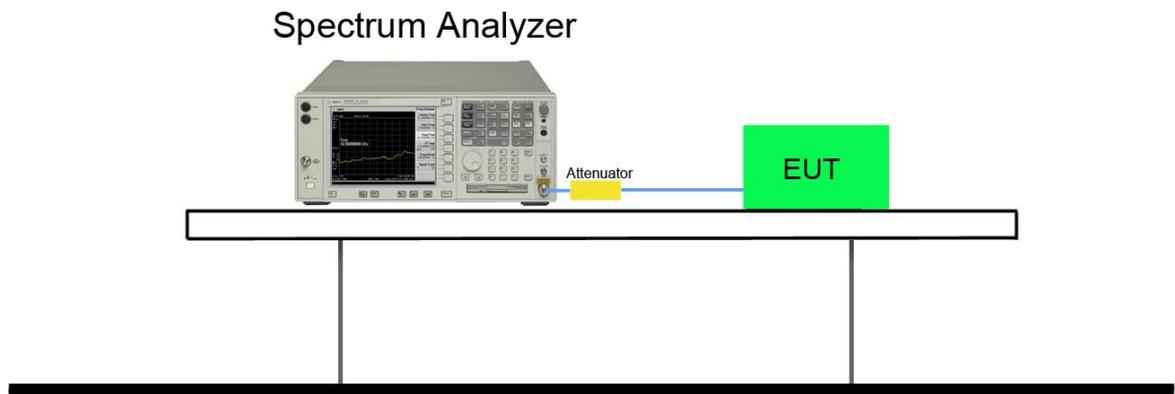

7.6.5. Test Result

Power Level (mW)	Frequency (MHz)	99% Bandwidth (kHz)
0.25	902.4	163.53
0.25	915.0	164.04
0.25	927.6	162.83

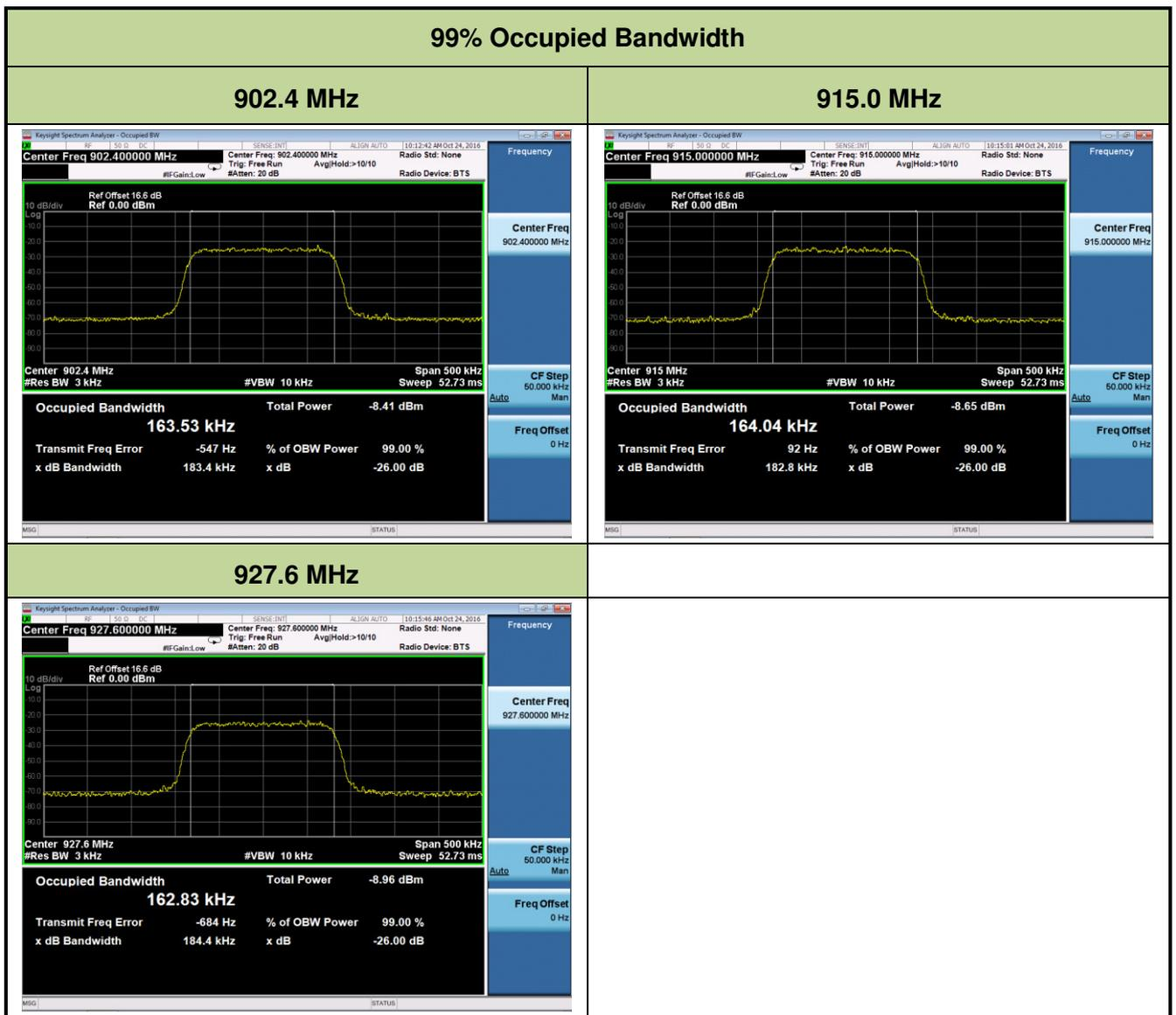

8. CONCLUSION

The data collected relate only the item(s) tested and show that the **Wireless Boundary Transmitter FCC ID: DD4ULXD6X52** is in compliance with Part 15C of the FCC Rules.

————— The End —————