



RF MEASUREMENT REPORT

FCC ID: DD4SLXD3H55

Applicant: Shure Incorporated

Product: Plug-on Wireless Transmitter

Model No.: SLXD3 H55

Brand Name:  , **SHURE**[®]

FCC Classification: Licensed LPAS Device (TLD)

FCC Rule Part(s): Part 74 Subpart H (Section 74.861)

Result: Complies

Received Date: 2023-04-14

Test Date: 2023-04-20 ~ 2023-04-26

Reviewed By:

Jame Yuan

Approved By:

Robin Wu



The test results relate only to the samples tested.

The test results shown in the test report are traceable to the national/international standards through the calibration of the equipment and evaluated measurement uncertainty herein.

The test report shall not be reproduced except in full without the written approval of MRT Technology (Suzhou) Co., Ltd.

Revision History

Report No.	Version	Description	Issue Date	Note
2304RSU032-U5	V01	Initial Report	2023-08-05	Valid

CONTENTS

Description	Page
1. General Information	5
1.1. Applicant	5
1.2. Manufacturer	5
1.3. Testing Facility	5
1.4. Product Information.....	6
1.5. Radio Specification under Test	6
1.6. Working Frequencies	6
2. Test Configuration	7
2.1. Test Mode	7
2.2. Test System Connection Diagram	7
2.3. Test Software	7
2.4. Applied Standards.....	8
2.5. Test Environment Condition.....	8
3. Measuring Instrument	9
4. Decision Rules and Measurement Uncertainty	10
4.1. Decision Rules	10
4.2. Measurement Uncertainty.....	10
5. Test Result.....	11
5.1. Summary	11
5.2. RF Output Power Measurement	12
5.2.1. Test Limit	12
5.2.2. Test Procedure	12
5.2.3. Test Setting	12
5.2.4. Test Setup	12
5.2.5. Test Result	12
5.3. Frequency Tolerance Measurement.....	13
5.3.1. Test Limit	13
5.3.2. Test Procedure	13
5.3.3. Test Setting	13
5.3.4. Test Setup	14
5.3.5. Test Result	14
5.4. 99% Occupied Bandwidth Measurement.....	15
5.4.1. Test Limit	15
5.4.2. Test Procedure	15
5.4.3. Test Setting	15

5.4.4.	Test Setup	15
5.4.5.	Test Result	15
5.5.	Out-of-band Emission Mask Measurement	16
5.5.1.	Test Limit	16
5.5.2.	Test Procedure	16
5.5.3.	Test Setting	16
5.5.4.	Test Setup	16
5.5.5.	Test Result	17
5.6.	Necessary Bandwidth Measurement	18
5.6.1.	Test Limit	18
5.6.2.	Test Procedure	18
5.6.3.	Test Setting	18
5.6.4.	Test Setup	18
5.6.5.	Test Result	18
5.7.	Radiated Spurious Emissions Measurement	19
5.7.1.	Test Limit	19
5.7.2.	Test Procedure	19
5.7.3.	Test Setting	19
5.7.4.	Test Setup	20
5.7.5.	Test Result	20
Appendix A – Test Result		21
A.1	RF Output Power Test Result	21
A.2	Frequency Tolerance Test Result	22
A.3	99% Occupied Bandwidth Test Result	23
A.4	Out-of-band Emission Mask Test Result	24
A.5	Necessary Bandwidth Test Result	27
A.6	Radiated Spurious Emissions Test Result	36
Appendix B – Test Setup Photograph		37
Appendix C – EUT Photograph		38

1.4. Product Information

Product Name	Plug-on Wireless Transmitter
Model No.	SLXD3 H55
Serial No.	3CC23617366 (Radiated Testing) 3CC23618076 (Conducted Testing)
Frequency Range	514 ~ 558 MHz
Power Type	Two AA batteries or Li-ion battery(3.6Vdc) or USB (5Vdc)
Operating Temperature	-18 ~ 50°C
Accessories	
Rechargeable Li-ion Battery	Model: SB903 Output: 3.6Vdc, 1200mAh, 4.32Wh

Note: The information of EUT was provided by the manufacturer, and the accuracy of the information shall be the responsibility of the manufacturer.

1.5. Radio Specification under Test

Frequency Range	514 ~ 558 MHz
Declared Power Level	1mW & 10mW & 30mW
Type of Modulation	4FSK
Channel Spacing	25kHz
Antenna Type	Dipole
Antenna Gain	0.70 dBi

Note: Power level and transmit frequency can be selected using the front panel controls.

1.6. Working Frequencies

Bottom Channel (MHz)	Middle Channel (MHz)	Top Channel (MHz)
514.000	536.000	558.000

2. Test Configuration

2.1. Test Mode

Mode 1: Transmit one channel at the fixed power level

2.2. Test System Connection Diagram

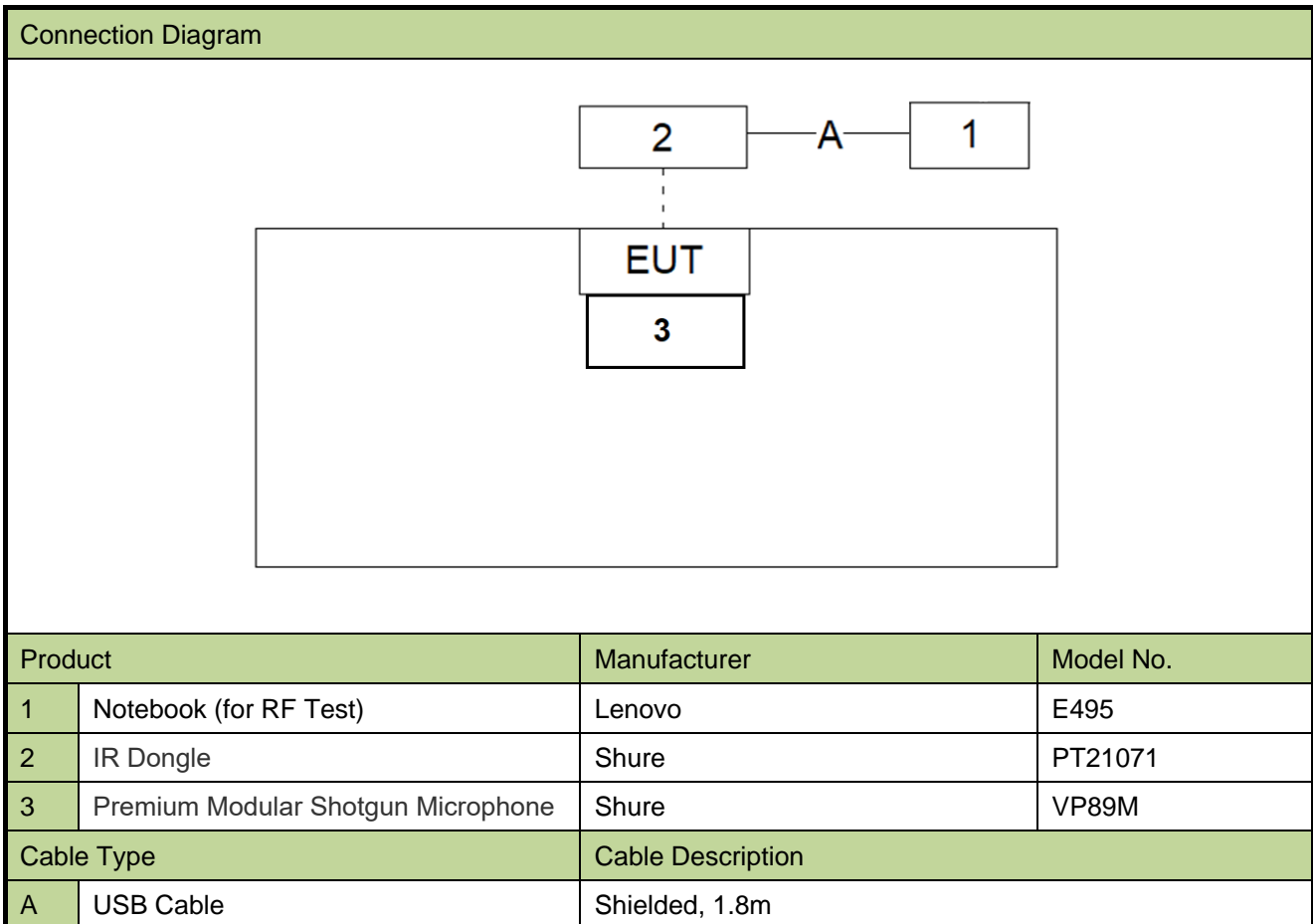

2.3. Test Software

The test utility software used during testing was “teraterm”, and the version was V4.85, all test commands were provided by the manufacturer.

2.4. Applied Standards

According to the specifications of the manufacturer, the EUT must comply with the requirements of the following standards:

- FCC Part 74.861
- KDB 206256 D01v02r01
- ANSI C63.26-2015
- ETSI EN 300 422 - 1 V 1.4.2

2.5. Test Environment Condition

Ambient Temperature	15 ~ 35°C
Relative Humidity	20 ~ 75%RH

3. Measuring Instrument

Instrument	Manufacturer	Model No.	Asset No.	Cali. Interval	Cali. Due Date	Test Site
Two-Line V-Network	R&S	ENV216	MRTSUE06002	1 year	2023-06-04	WZ-SR2
Shielding Room	MIX-BEP	WZ-SR2	MRTSUE06215	5 years	2026-12-20	WZ-SR2
Thermohygrometer	testo	608-H1	MRTSUE06404	1 year	2023-06-06	WZ-SR2
EMI Test Receiver	R&S	ESR3	MRTSUE06909	1 year	2023-10-27	WZ-SR2
Thermohygrometer	testo	608-H1	MRTSUE06402	1 year	2023-06-06	WZ-SR5
Shielding Room	HUAMING	WZ-SR5	MRTSUE06442	N/A	N/A	WZ-SR5
USB Power Sensor	Keysight	U2021XA	MRTSUE06446	1 year	2023-06-04	WZ-SR5
Signal Analyzer	Keysight	N9010B	MRTSUE06457	1 year	2023-06-04	WZ-SR5
Attenuator	MVE	MVE2213	MRTSUE11060	1 year	2023-06-09	WZ-SR5
Attenuator	MVE	MVE2213	MRTSUE11072	1 year	2023-06-09	WZ-SR5
Temperature Chamber	BAOYT	BYH-150CL	MRTSUE06051	1 year	2023-10-08	WZ-TR3
Thermohygrometer	testo	608-H1	MRTSUE06401	1 year	2023-06-06	WZ-TR3
Signal Analyzer	Keysight	N9010B	MRTSUE07027	1 year	2023-11-25	WZ-TR3
TRILOG Antenna	Schwarzbeck	VULB 9162	MRTSUE06022	1 year	2023-05-20	WZ-AC2
EMI Test Receiver	Agilent	N9038A	MRTSUE06125	1 year	2023-06-04	WZ-AC2
Thermohygrometer	Mingle	ETH529	MRTSUE06170	1 year	2023-11-27	WZ-AC2
Horn Antenna	Schwarzbeck	BBHA 9120D	MRTSUE06171	1 year	2023-10-13	WZ-AC2
Preamplifier	Schwarzbeck	BBV 9718	MRTSUE06176	1 year	2023-05-08	WZ-AC2
Anechoic Chamber	RIKEN	WZ-AC2	MRTSUE06213	1 year	2023-04-21	WZ-AC2
				1 year	2024-04-20	WZ-AC2
Thermohygrometer	testo	608-H1	MRTSUE11038	1 year	2023-11-01	WZ-AC2

Software	Version	Function
EMI Software	V3.0.0	EMI Test Software
Controller_MF 7802	1.02	RE Antenna & Turntable
BenchVue Power Meter	2018.1	Power

4. Decision Rules and Measurement Uncertainty

4.1. Decision Rules

The Decision Rule is based on Simple Acceptance in accordance with ISO Guide 98-4: 2012 Clause 8.2. (Measurement uncertainty is not taken into account when stating conformity with a specified requirement.)

4.2. Measurement Uncertainty

Where relevant, the following test uncertainty levels have been estimated for tests performed on the EUT as specified in CISPR 16-4-2. This uncertainty represents an expanded uncertainty expressed at approximately the 95% confidence level using a coverage factor of $k = 2$.

AC Conducted Emission Measurement
The maximum measurement uncertainty is evaluated as: 9kHz~150kHz: 3.58dB 150kHz~30MHz: 3.20dB
Radiated Emission Measurement
The maximum measurement uncertainty is evaluated as: Coaxial: 9kHz~30MHz: 2.59dB Coplanar: 9kHz~30MHz: 2.60dB Horizontal: 30MHz~200MHz: 3.85dB 200MHz~1GHz: 4.36dB 1GHz~40GHz: 4.98dB Vertical: 30MHz~200MHz: 4.06dB 200MHz~1GHz: 5.28dB 1GHz~40GHz: 4.91dB
Spurious Emissions, Conducted
Measuring Uncertainty for a Level of Confidence of 95% ($U=2Uc(y)$): 2.3dB
Output Power
Measuring Uncertainty for a Level of Confidence of 95% ($U=2Uc(y)$): 1.5dB
Occupied Bandwidth
Measuring Uncertainty for a Level of Confidence of 95% ($U=2Uc(y)$): 3.2%

5. Test Result

5.1. Summary

FCC Part Section(s)	Test Description	Test Condition	Test Result
74.861(e)(1)(ii)	RF Output Power	Conducted	Pass
74.861(e)(4)	Frequency Stability		Pass
74.861(e)(5)	Occupied Bandwidth		Pass
74.861(e)(6)	Emission Mask		Pass
74.861(e)(7)	Necessary Bandwidth		Pass
74.861(e)(7)	Radiated Spurious Emission	Radiated	Pass

Notes:

- 1) The analyzer plots shown in this section were all taken with a correction table loaded into the analyzer. The correction table was used to account for the losses of the cables and attenuators used as part of the system to connect the EUT to the analyzer at all frequencies of interest.
- 2) All modes of operation and data rates were investigated. For radiated emission test, every axis (X, Y, Z) was also verified. The test results shown in the following sections represent the worst emissions.
- 3) For different power levels, except RF Output Power & necessary bandwidth & emission mask test items were evaluated all power levels, any others test items were only assessed max power level.

5.2. RF Output Power Measurement

5.2.1. Test Limit

The conducted power may not exceed 250mW in 470 ~ 608 MHz band.

5.2.2. Test Procedure

ANSI C63.26-2015 - Section 5.2.4.2

5.2.3. Test Setting

The output of the EUT was connected to an RF average power meter through fixed attenuation.

The EUT was set to transmit on the low, middle, and high frequencies in each power level.

Measure the average power of the transmitter.

5.2.4. Test Setup

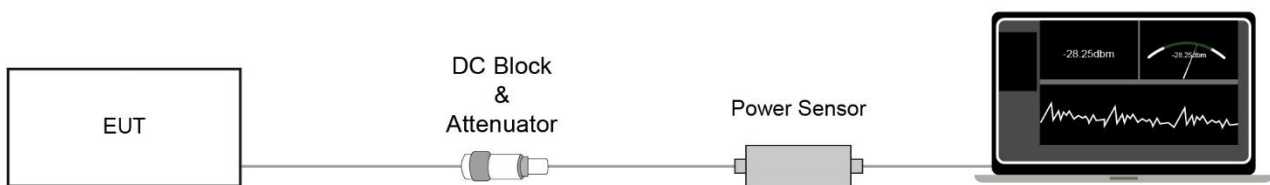

5.2.5. Test Result

Refer to Appendix A.1.

5.3. Frequency Tolerance Measurement

5.3.1. Test Limit

The frequency tolerance of the transmitter shall be 0.005 percent.

5.3.2. Test Procedure

ANSI C63.26 - Section 5.6.3

5.3.3. Test Setting

Frequency Stability Under Temperature Variations:

The equipment under test was connected to an external AC or DC power supply and input rated voltage. RF output was connected to a frequency counter or spectrum analyzer via feed through attenuators. The EUT was placed inside the temperature chamber. Set the spectrum analyzer RBW low enough to obtain the desired frequency resolution and measure EUT 20°C operating frequency as reference frequency. Turn EUT off and set the chamber temperature to highest. After the temperature stabilized for approximately 30 minutes recorded the frequency. Repeat step measure with 10°C decreased per stage until the lowest temperature reached.

Frequency Stability Under Voltage Variations:

Set chamber temperature to 20°C. Use a variable AC power supply / DC power source to power the EUT and set the voltage to rated voltage. Set the spectrum analyzer RBW low enough to obtain the desired frequency resolution and recorded the frequency.

Reduce the input voltage to specify extreme voltage variation ($\pm 15\%$) and endpoint (If a product is specified to operate over a range of input voltage then the -15% variation is applied to the lowermost voltage and the $+15\%$ is applied to the uppermost voltage), record the maximum frequency change.

5.3.4. Test Setup

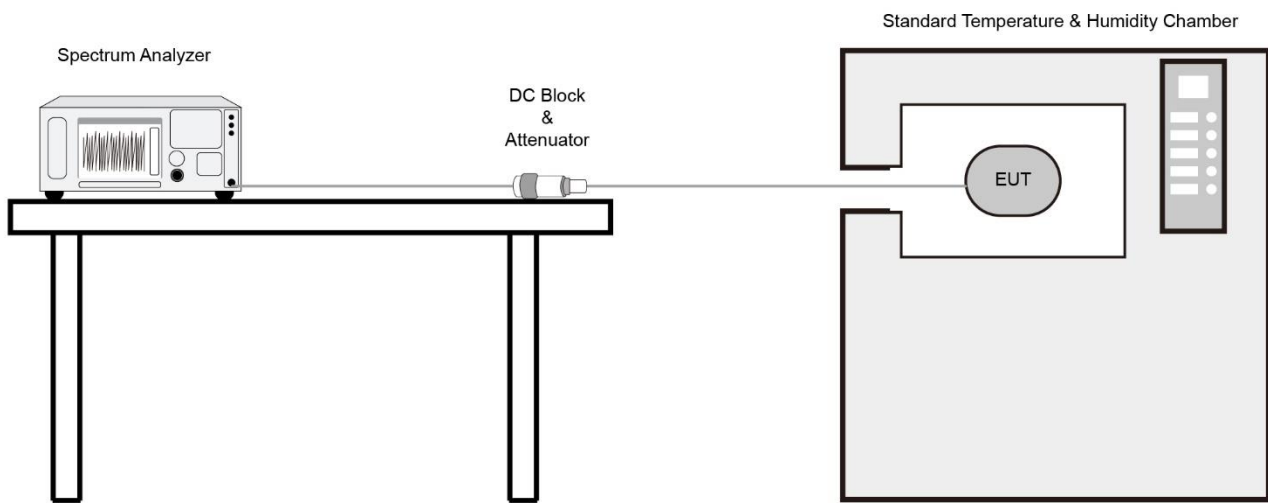

5.3.5. Test Result

Refer to Appendix A.2.

5.4. 99% Occupied Bandwidth Measurement

5.4.1. Test Limit

The operating bandwidth shall not exceed 200 kHz.

5.4.2. Test Procedure

ANSI C63.26-2015 - Section 5.4.4

5.4.3. Test Setting

1. The signal analyzer's automatic bandwidth measurement capability was used to perform the 99% occupied bandwidth. The bandwidth measurement was not influenced by any intermediate power nulls in the fundamental emission.
2. RBW = 1 - 5% of the expected OBW
3. VBW $\geq 3 \times$ RBW
4. Detector = Peak
5. Trace mode = max hold
6. Sweep = auto couple
7. The trace was allowed to stabilize
8. Reported the measured 99% occupied bandwidth

5.4.4. Test Setup

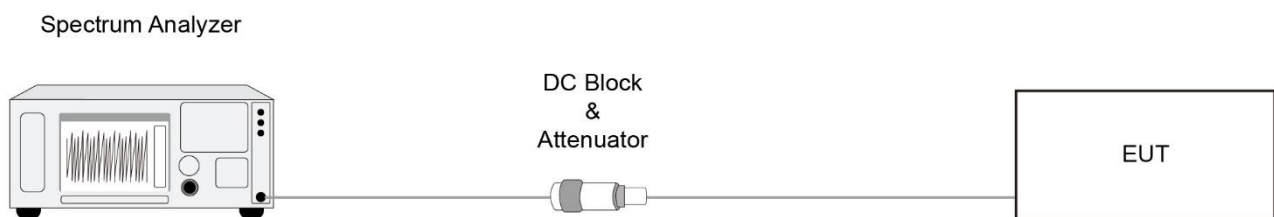

5.4.5. Test Result

Refer to Appendix A.3.

5.5. Out-of-band Emission Mask Measurement

5.5.1. Test Limit

The mean power of emissions shall be attenuated below the mean output power of the transmitter in accordance with the following schedule:

- (i) On any frequency removed from the operating frequency by more than 50 percent up to and including 100 percent of the authorized bandwidth: at least 25 dB;
- (ii) On any frequency removed from the operating frequency by more than 100 percent up to and including 250 percent of the authorized bandwidth: at least 35 dB;
- (iii) On any frequency removed from the operating frequency by more than 250 percent of the authorized bandwidth: at least $43+10\log_{10}$ (mean output power in watts) dB.

5.5.2. Test Procedure

ANSI C63.26 - Section 5.7

5.5.3. Test Setting

Emission Mask

- a) The EUT was connected to a spectrum analyzer. The un-modulated carrier signal level was measured and recorded.
- b) The EUT was modulated with typical digital modulation.
- c) The spectrum analyzer center frequency was set to the EUT operating frequency; span was set to 2 MHz; resolution bandwidth was set to 1 MHz; video bandwidth set to 3 MHz; sweep time set to 3 s; after clear/write, max-hold was set; Marker 1 was set to RMS, then Marker 1 was set to reference value.
- d) The RMS output power was recorded and used to set the reference level on the spectrum analyzer.
- e) The spectrum analyzer span was then set to 1.5 MHz; resolution bandwidth set to 2 kHz, video bandwidth set to 5 kHz, sweep time to Auto.

5.5.4. Test Setup

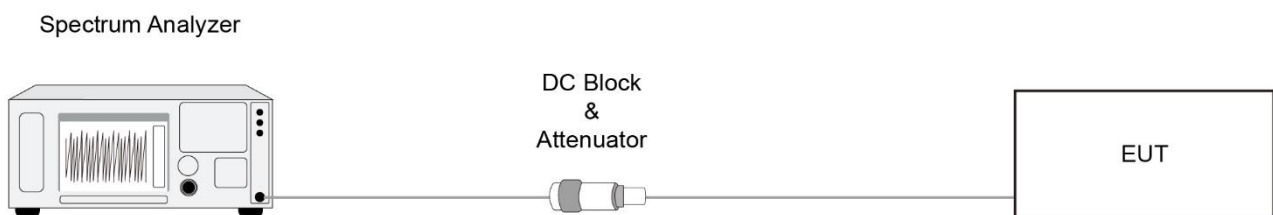

5.5.5. Test Result

Refer to Appendix A.4.

5.6. Necessary Bandwidth Measurement

5.6.1. Test Limit

Digital emissions within the band from one megahertz below to one megahertz above the carrier frequency shall comply with the emission mask in section 8.3.2.2 of the European Telecommunications Institute Standard ETSI EN 300 422-1 v1.4.2, the transmitter output spectrum shall be within the mask defined as below figure.

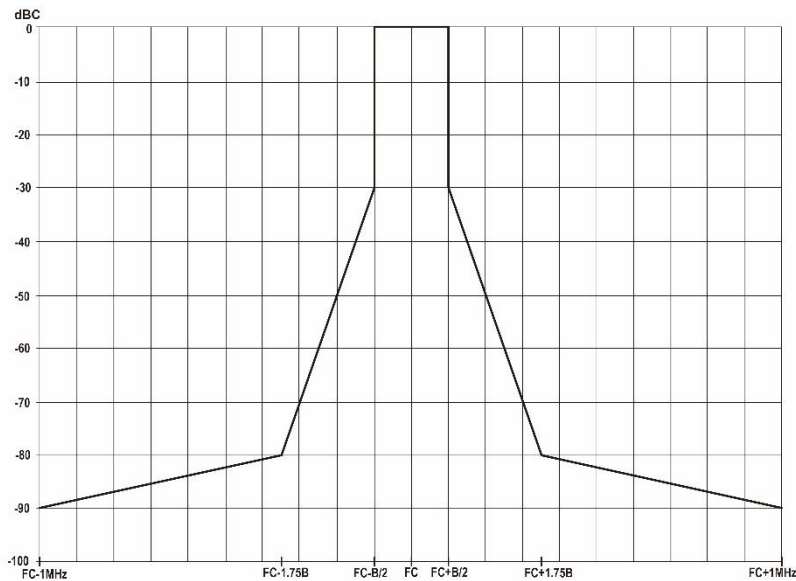

5.6.2. Test Procedure

EN 300 422-1 V1.4.2 clause 8.3.2.1.

5.6.3. Test Setting

The EUT was powered up and the transmit frequency & power output of the EUT were selected.

The spectrum analyzer center frequency is set to the nominal EUT channel center frequency.

5.6.4. Test Setup

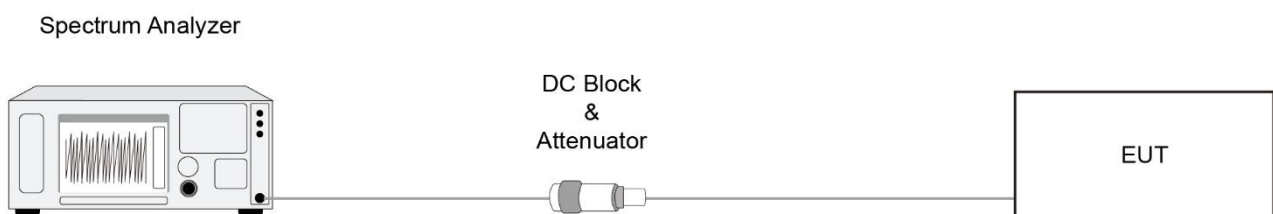

5.6.5. Test Result

Refer to Appendix A.5.

5.7. Radiated Spurious Emissions Measurement

5.7.1. Test Limit

According to FCC Part 74.861(e)(7), beyond one megahertz below and above the carrier frequency, emissions shall comply with the limits specified in section 8.4 of ETSI EN 300 422-1 v1.4.2.

State	Frequency Range		
	47MHz to 74MHz, 87.5MHz to 137MHz 174MHz to 230MHz, 470MHz to 862MHz	Other Frequencies below 1000MHz	Frequencies above 1000MHz
Operation	4nW	250nW	1uW
Standby	2nW	2nW	20nW

5.7.2. Test Procedure

ETSI EN 300 422-1 V1.4.2 clause 8.4.2.

5.7.3. Test Setting

Table 1 - RBW as a function of frequency

Frequency	RBW
25 ~ 30 MHz	9 kHz
30 ~ 1000 MHz	100 kHz
1000 ~ 6000 MHz	1 MHz

Emissions shall be investigated up to the 10th harmonic of the fundamental.

Compliance with the emission limits shall be demonstrated using an RMS Average detector.

All significant broadband and narrowband signals found in the preliminary sweeps were measured using a peak detector at a test distance of 3 meters.

At each frequency at which a component is detected, the sample shall be rotated to obtain maximum response and the effective radiated power of that component determined by a substitution measurement.

5.7.4. Test Setup

Below 1GHz Test Setup:

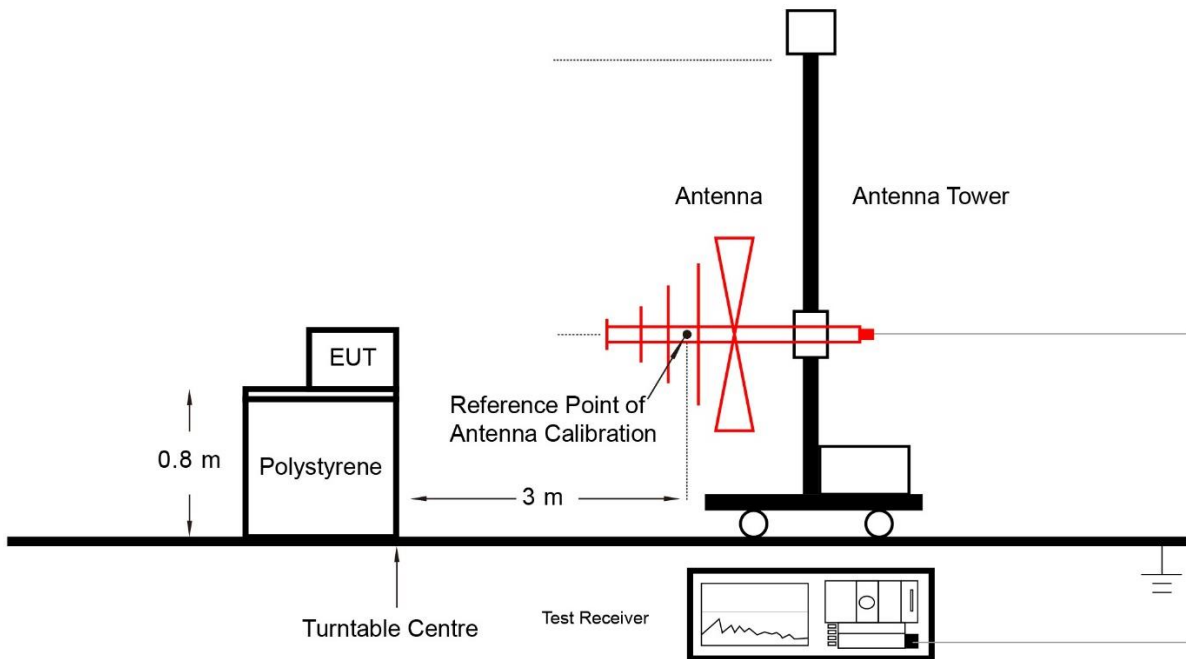

Above 1GHz Test Setup:

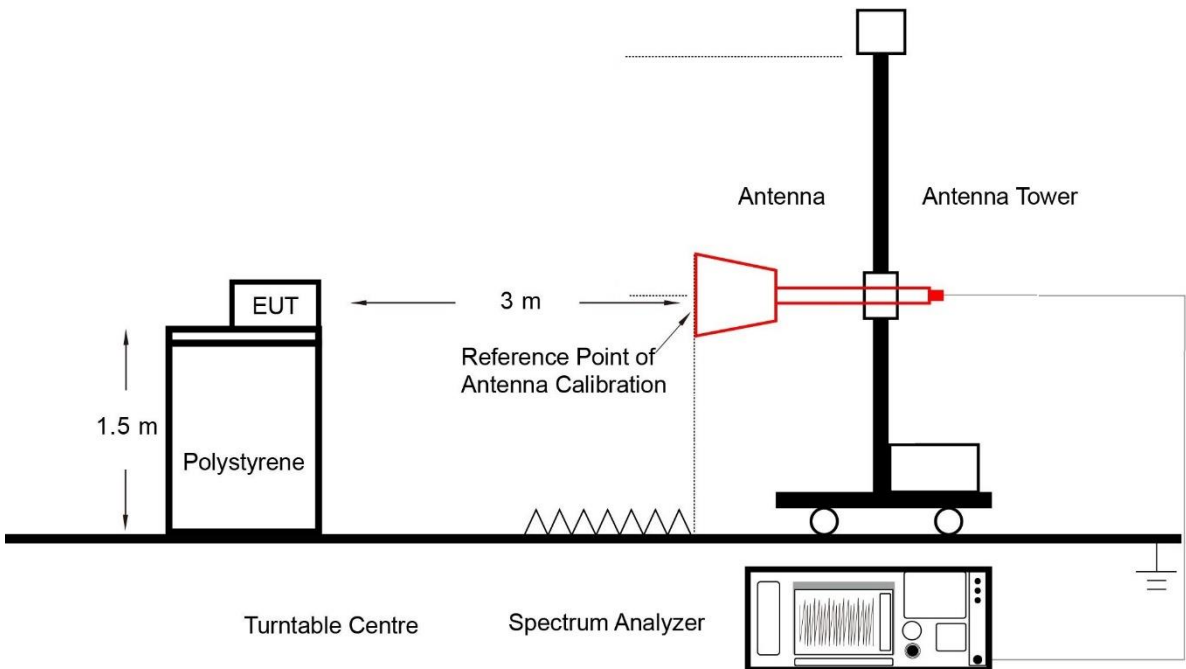

5.7.5. Test Result

Refer to Appendix A.6.

Appendix A – Test Result

A.1 RF Output Power Test Result

Test Site	WZ-SR5	Test Engineer	Dandy Li
Test Date	2023-04-23		

Frequency (MHz)	Conducted Output Power (dBm)	Limit (dBm)	Test Result
30mW Power Level			
514.000	15.49	≤ 23.98	Pass
536.000	15.34	≤ 23.98	Pass
558.000	15.31	≤ 23.98	Pass
10mW Power Level			
514.000	10.24	≤ 23.98	Pass
536.000	10.29	≤ 23.98	Pass
558.000	10.43	≤ 23.98	Pass
1mW Power Level			
514.000	0.46	≤ 23.98	Pass
536.000	0.39	≤ 23.98	Pass
558.000	0.44	≤ 23.98	Pass

Note: Limit = $10 \cdot \log(250\text{mW}) = 23.98$ dBm.

A.2 Frequency Tolerance Test Result

Test Site	WZ-TR3	Test Engineer	Dandy Li
Test Date	2023-04-23	Test Mode	514.000MHz

Voltage (%)	Power (VDC)	Temp (°C)	Frequency Tolerance (%)			
			0 minutes	2 minutes	5 minutes	10 minutes
100	3.6	- 10	-0.000042	-0.000040	-0.000039	-0.000037
		0	-0.000034	-0.000033	-0.000032	-0.000032
		+ 10	-0.000024	-0.000024	-0.000023	-0.000022
		+ 20	-0.000022	-0.000019	-0.000018	-0.000017
		+ 30	-0.000020	-0.000021	-0.000020	-0.000019
		+ 40	-0.000012	-0.000011	-0.000011	-0.000011
		+ 50	0.000001	-0.000002	-0.000002	-0.000002
115	4.14	+ 20	-0.000022	-0.000019	-0.000018	-0.000017
85	3.06	+ 20	-0.000022	-0.000019	-0.000018	-0.000017

Note: Frequency Tolerance (ppm) = $\{[\text{Measured Frequency (Hz)} - \text{Declared Frequency (Hz)}] / \text{Declared Frequency (Hz)}\} * 10^2$.

A.3 99% Occupied Bandwidth Test Result

Test Site	WZ-SR5	Test Engineer	Dandy Li
Test Date	2023-04-20		

Test Mode	Frequency (MHz)	99% Bandwidth (kHz)	Limit (kHz)	Result
30mW Power Level	514.000	166.89	< 200	Pass
	536.000	166.52	< 200	Pass
	558.000	167.19	< 200	Pass

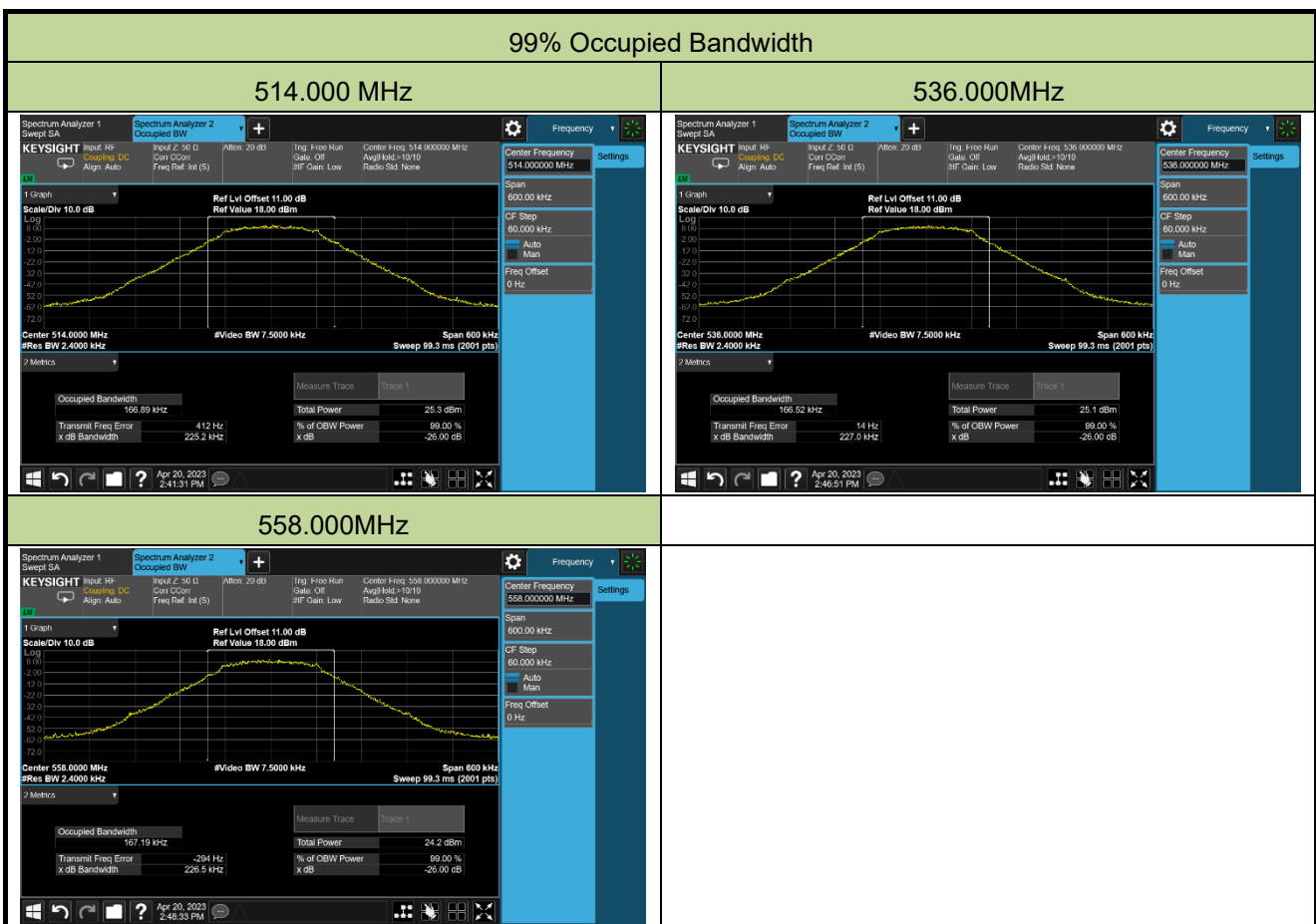

A.4 Out-of-band Emission Mask Test Result

Test Site	WZ-SR5	Test Engineer	Dandy Li
Test Date	2023-04-21		

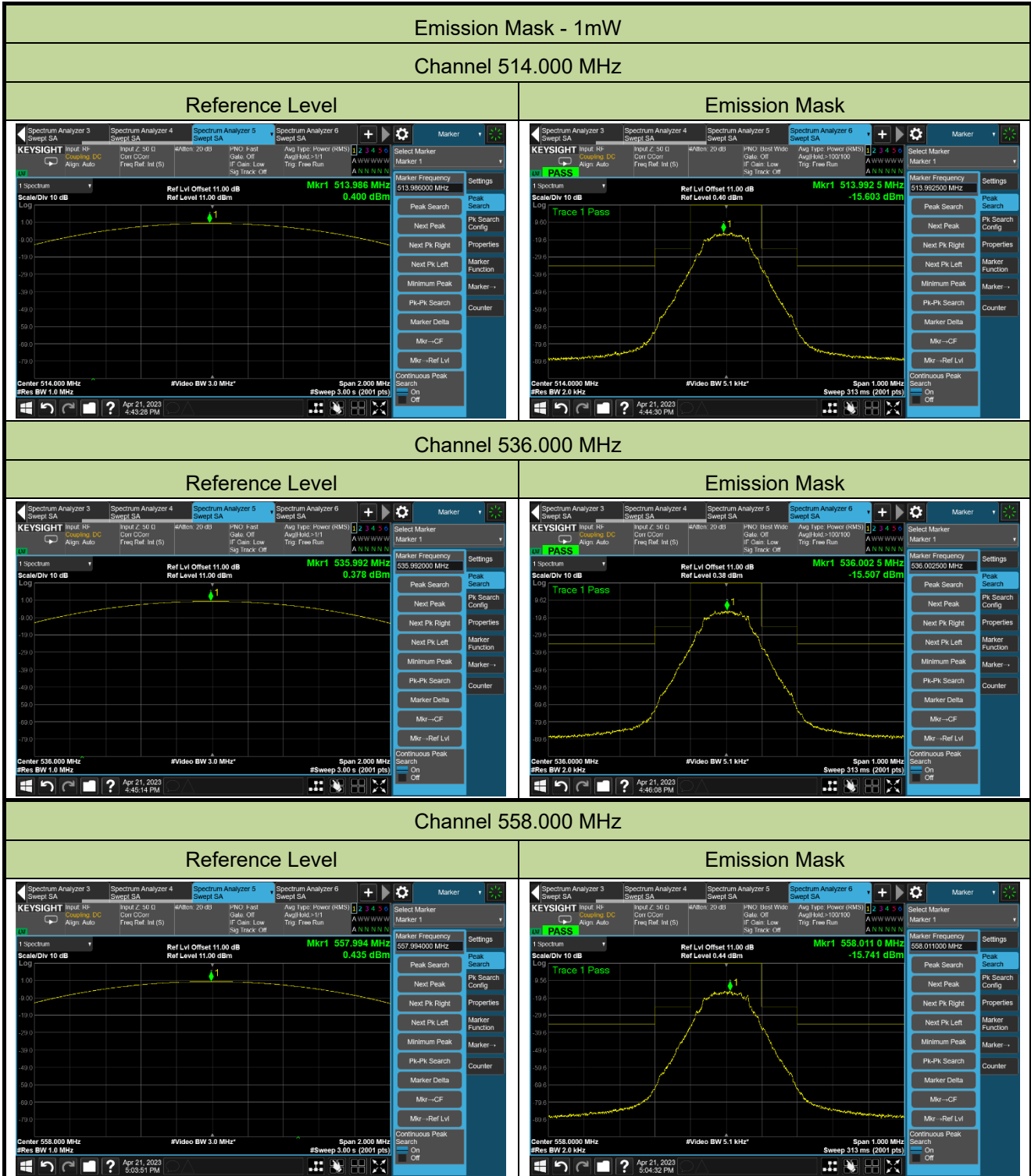

Emission Mask - 10mW

Channel 514.000MHz

Reference Level

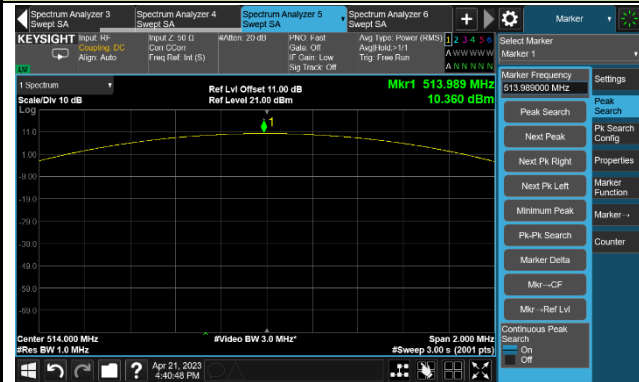

Emission Mask

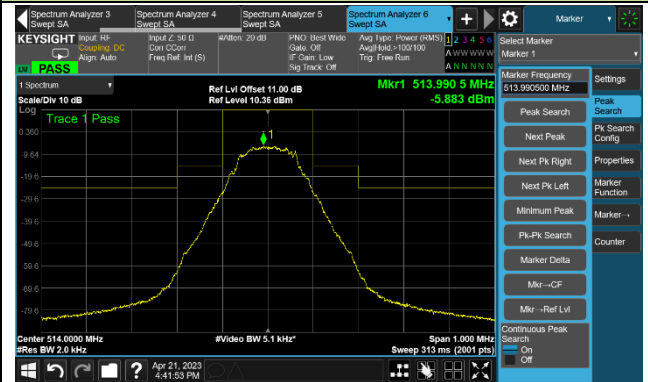

Channel 536.000 MHz

Reference Level

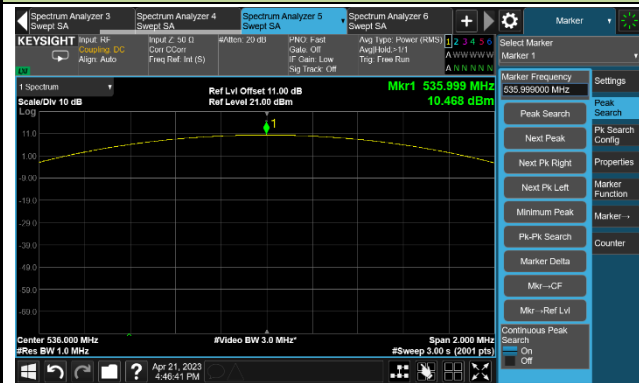

Emission Mask

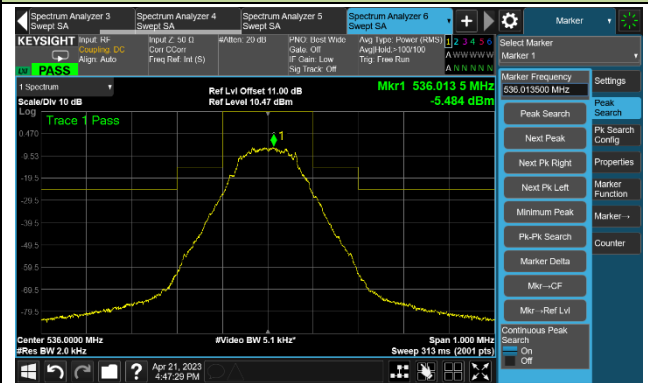

Channel 558.000 MHz

Reference Level

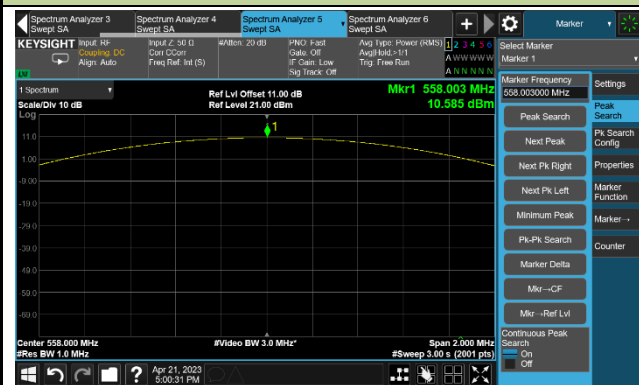

Emission Mask

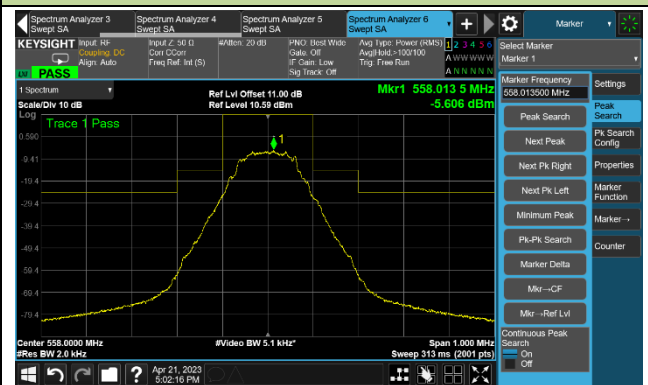

Emission Mask - 30mW

Channel 514.000 MHz

Reference Level

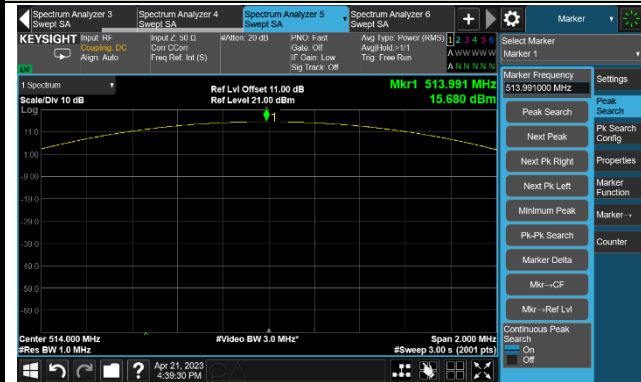

Emission Mask

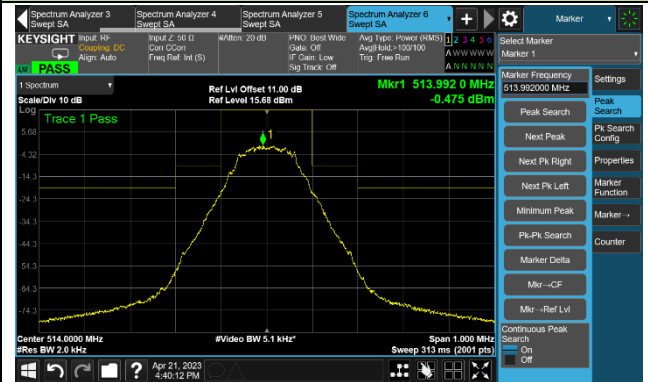

Channel 536.000 MHz

Reference Level

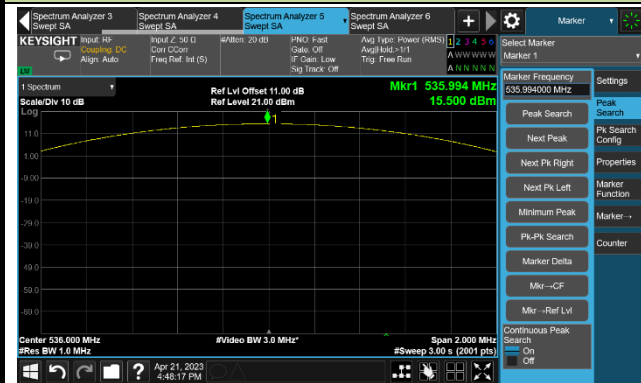

Emission Mask

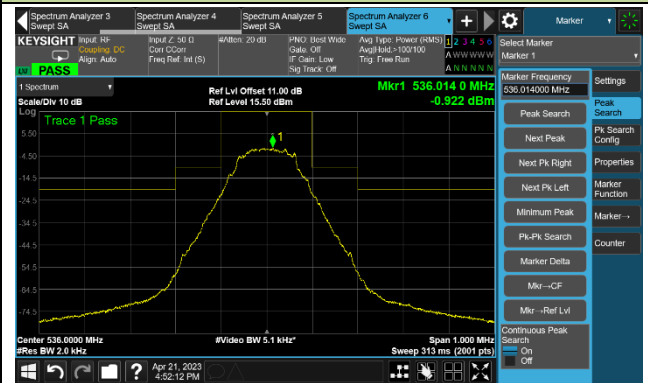

Channel 558.000 MHz

Reference Level

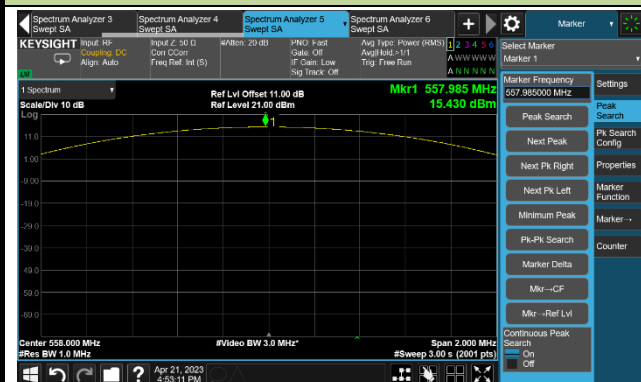

Emission Mask

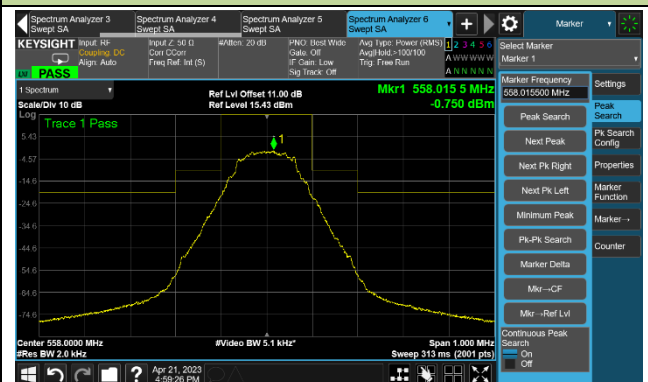

A.5 Necessary Bandwidth Test Result

Test Site	WZ-SR5	Test Engineer	Dandy Li
Test Date	2023-04-20		

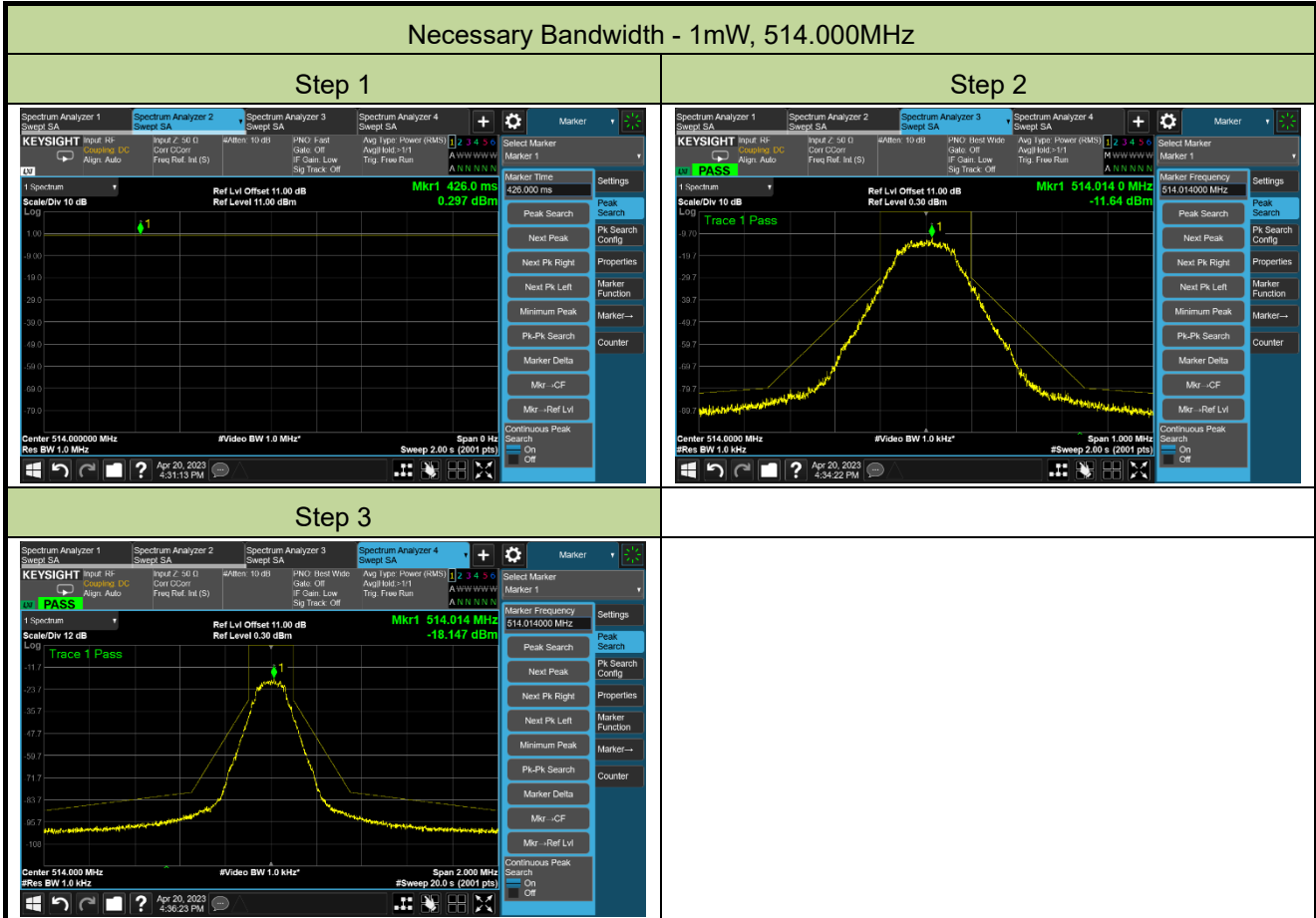

Necessary Bandwidth - 1mW, 536.000MHz

Step 1

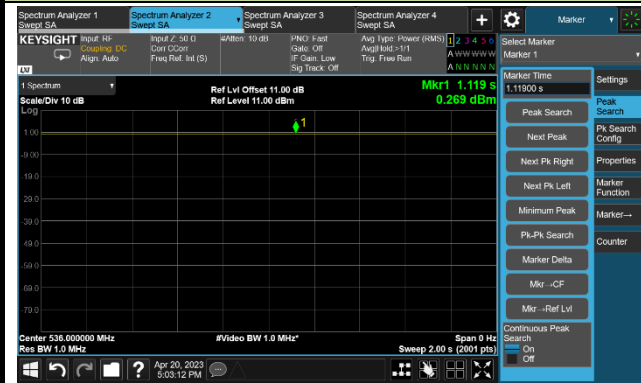

Step 2

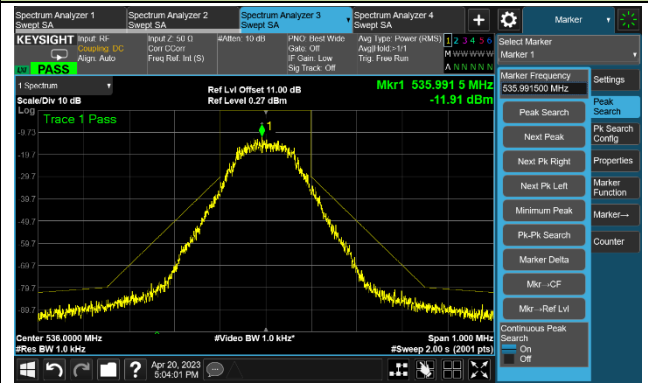

Step 3

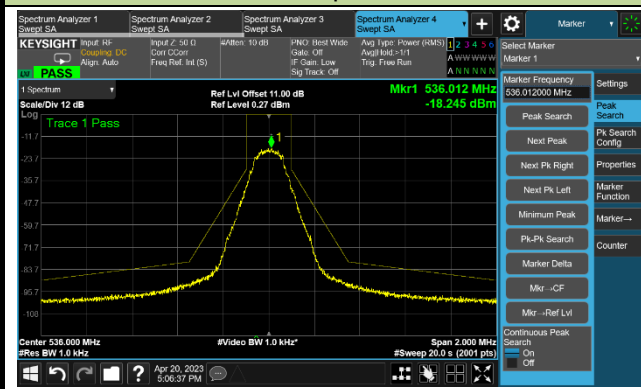

Necessary Bandwidth - 1mW, 558.000MHz

Step 1

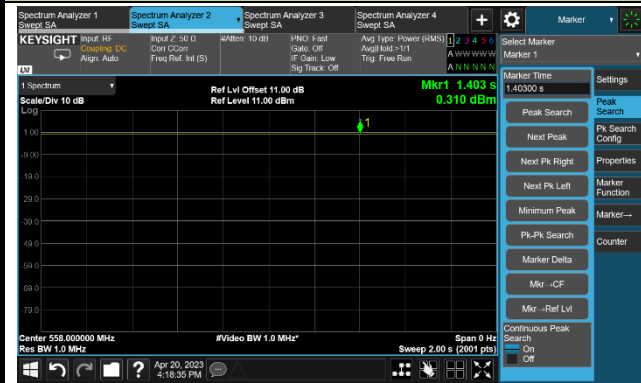

Step 2

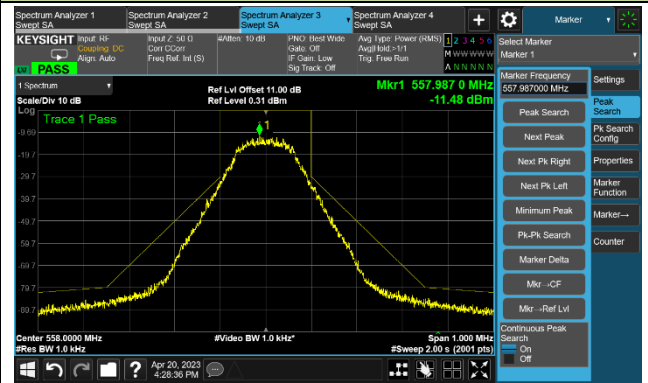

Step 3

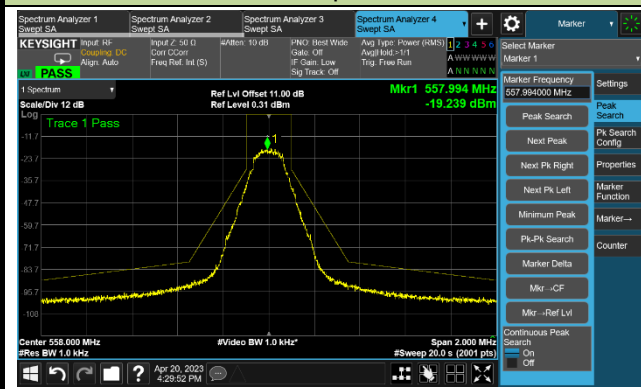

Necessary Bandwidth - 10mW, 514.000MHz

Step 1

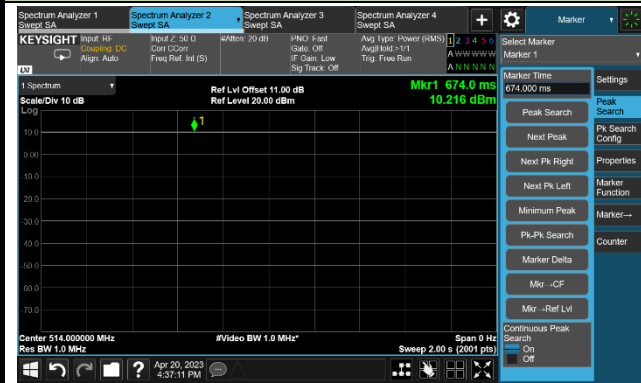

Step 2

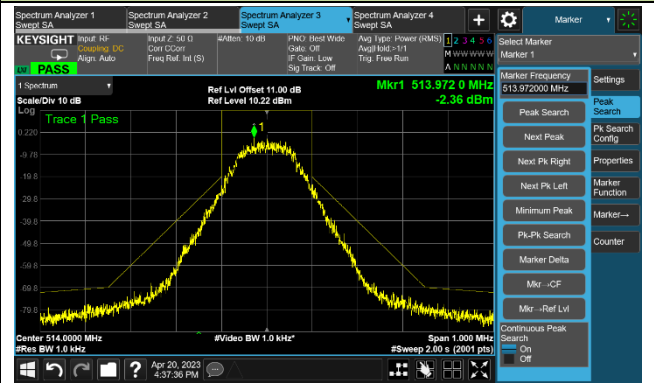

Step 3

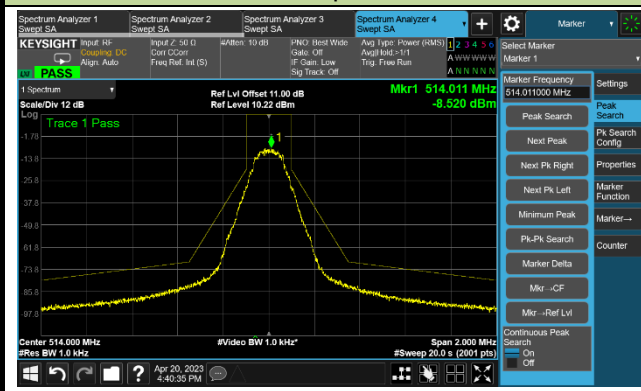

Necessary Bandwidth - 10mW, 536.000MHz

Step 1

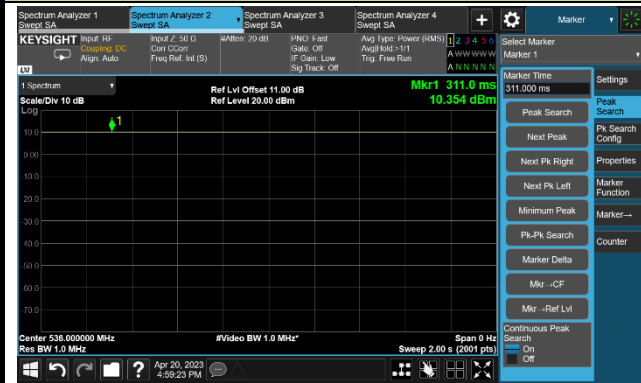

Step 2

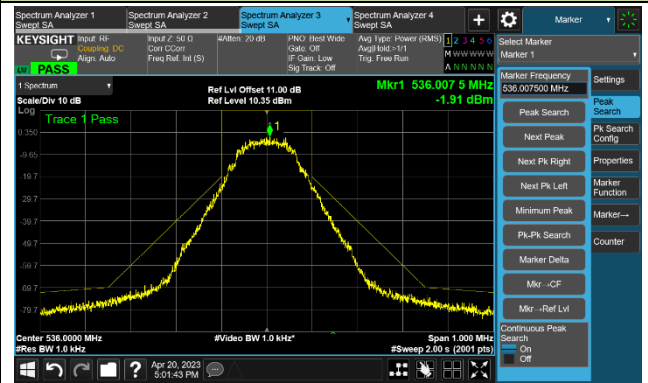

Step 3

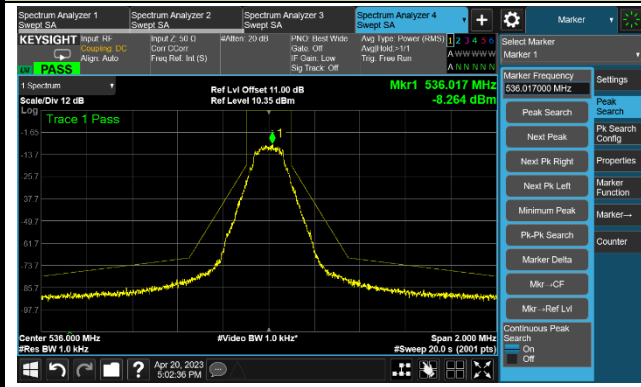

Necessary Bandwidth - 10mW, 558.000MHz

Step 1

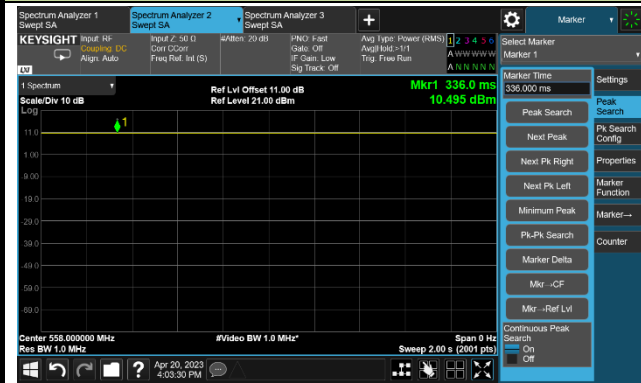

Step 2

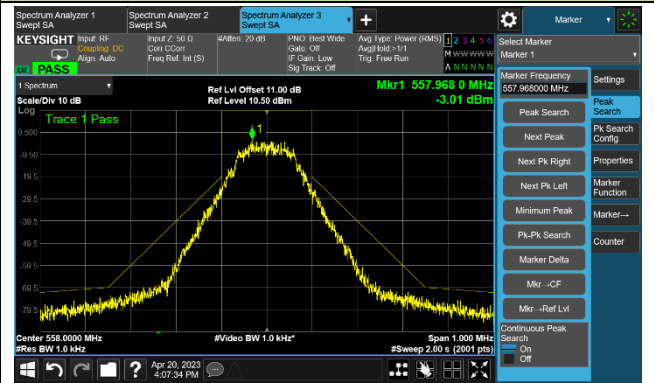

Step 3

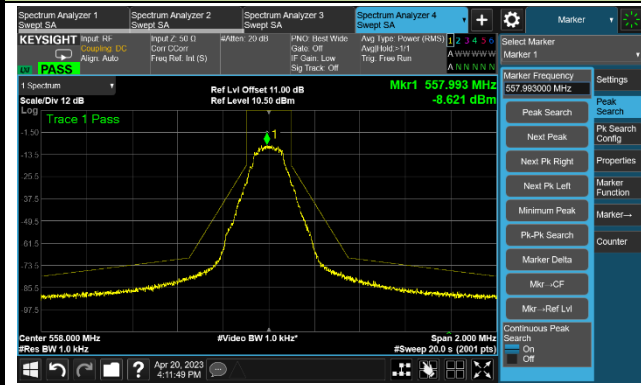

Necessary Bandwidth - 30mW, 514.000MHz

Step 1

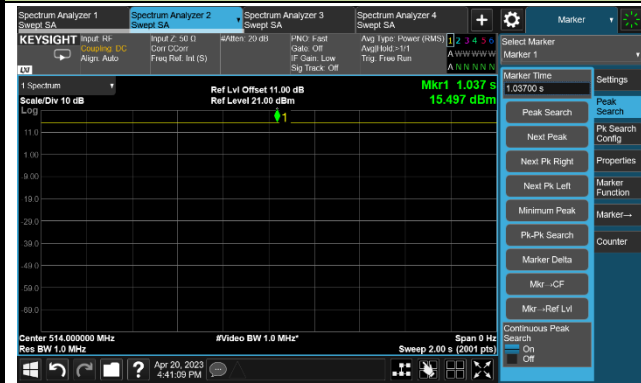

Step 2

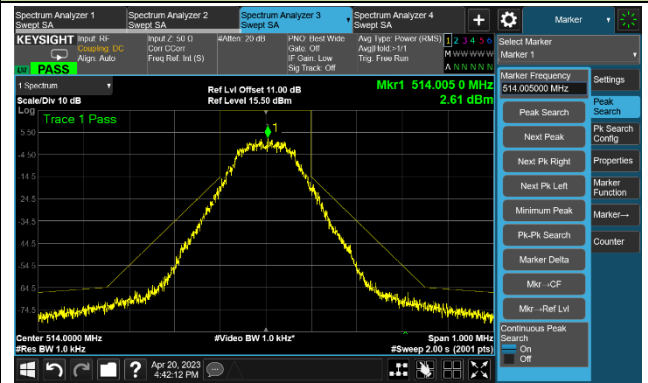

Step 3

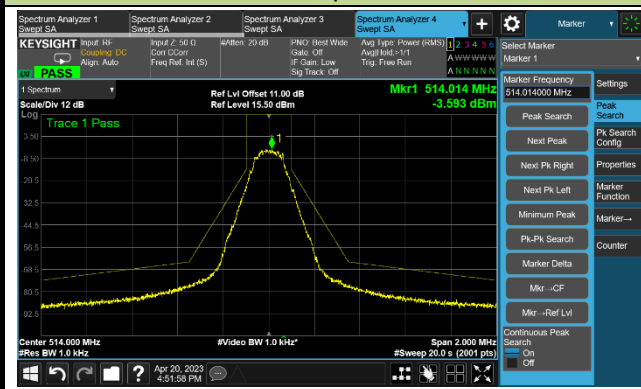

Necessary Bandwidth - 30mW, 536.000MHz

Step 1

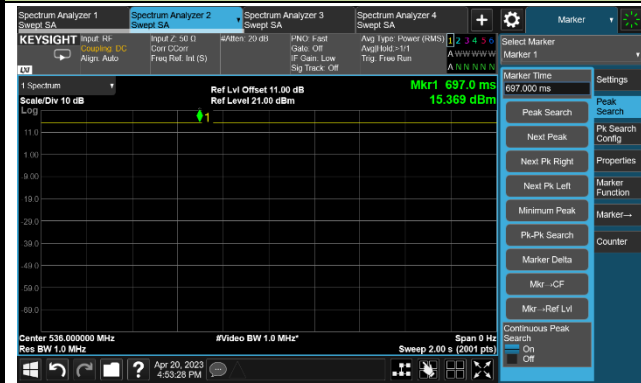

Step 2

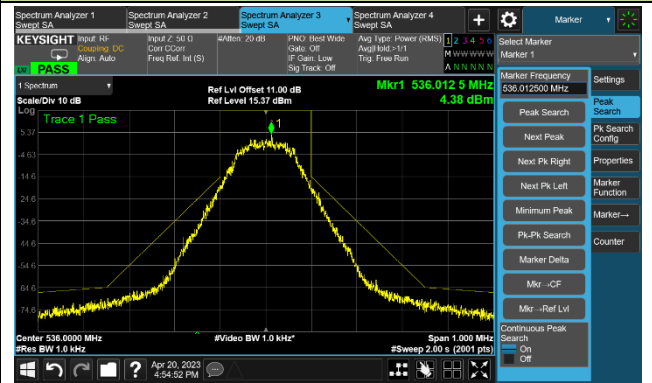

Step 3

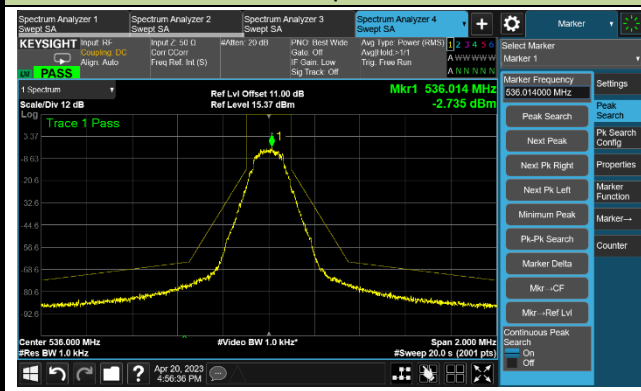

Necessary Bandwidth - 30mW, 558.000MHz

Step 1

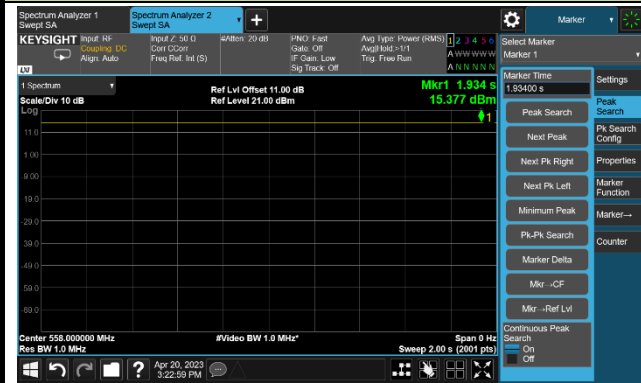

Step 2

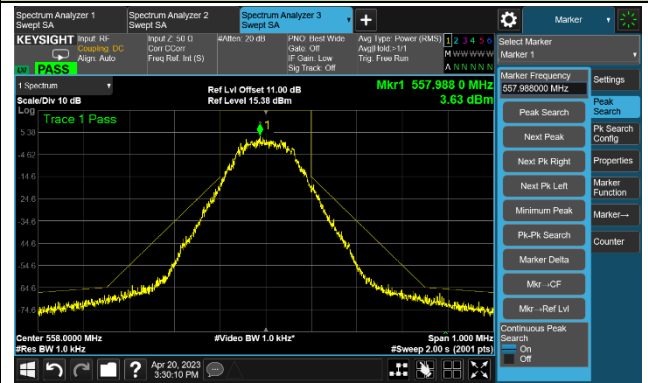

Step 3

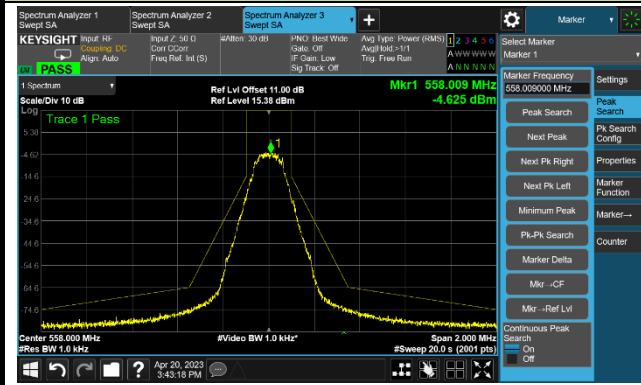

A.6 Radiated Spurious Emissions Test Result

Test Site	WZ-AC2	Test Engineer	Dick Shen
Test Date	2023-04-26	Test Mode	30mW

Test Channel (MHz)	Frequency (MHz)	Reading Level (dBm)	Substitution Factor (dB)	Measure Level (dBm)	Limit (dBm)	Margin (dB)	Detector	Polarization
514.000	55.705	-92.9	29.3	-63.6	-54.0	-9.6	Peak	Horizontal
	728.400	-103.7	38.1	-65.6	-54.0	-11.6	Peak	Horizontal
	98.385	-105.0	40.2	-64.8	-54.0	-10.8	Peak	Vertical
	759.440	-103.5	38.5	-65.0	-54.0	-11.0	Peak	Vertical
	1365.000	-67.0	9.3	-57.7	-30.0	-27.7	Peak	Horizontal
	2440.000	-66.2	10.0	-56.2	-30.0	-26.2	Peak	Horizontal
	1360.000	-66.2	9.1	-57.1	-30.0	-27.1	Peak	Vertical
	2432.500	-65.2	9.8	-55.4	-30.0	-25.4	Peak	Vertical
536.000	52.795	-104.7	30.7	-74.0	-54.0	-20.0	Peak	Horizontal
	724.520	-102.9	38.1	-64.8	-54.0	-10.8	Peak	Horizontal
	96.445	-104.1	40.0	-64.1	-54.0	-10.1	Peak	Vertical
	777.870	-103.0	38.2	-64.8	-54.0	-10.8	Peak	Vertical
	1365.000	-66.8	9.3	-57.5	-30.0	-27.5	Peak	Horizontal
	4670.000	-70.0	14.7	-55.3	-30.0	-25.3	Peak	Horizontal
	1360.000	-67.3	9.1	-58.2	-30.0	-28.2	Peak	Vertical
	2822.500	-67.0	10.6	-56.4	-30.0	-26.4	Peak	Vertical
558.000	49.400	-104.0	31.8	-72.2	-54.0	-18.2	Peak	Horizontal
	706.090	-103.6	37.6	-66.0	-54.0	-12.0	Peak	Horizontal
	102.750	-103.6	38.7	-64.9	-54.0	-10.9	Peak	Vertical
	761.380	-103.7	38.5	-65.2	-54.0	-11.2	Peak	Vertical
	1250.000	-67.7	8.8	-58.9	-30.0	-28.9	Peak	Horizontal
	3107.500	-67.4	10.5	-56.9	-30.0	-26.9	Peak	Horizontal
	1920.000	-65.4	8.0	-57.4	-30.0	-27.4	Peak	Vertical
	2820.000	-67.3	10.6	-56.7	-30.0	-26.7	Peak	Vertical

Note 1: Measure Level (dBm) = Reading Level (dBm) + Substitution Factor (dB)

Note 2: Substitution Factor (dB) = Cable Loss (dB) + Space Attenuation (dB) - Antenna Gain (dBi) - 2.15 (dB)

Note 3: RMS measurement was not performed when peak measure level was lower than the RMS limit.

Appendix B – Test Setup Photograph

Refer to “ 2304RSU032-UT” file.

Appendix C – EUT Photograph

Refer to “2304RSU032-UE” file.