



# RF MEASUREMENT REPORT

---

**FCC ID:** DD4SLXD3G58  
**Applicant:** Shure Incorporated  
**Product:** Plug-on Wireless Transmitter  
**Model No.:** SLXD3 G58  
**Brand Name:**   
**FCC Classification:** Licensed LPAS Device (TLD)  
**FCC Rule Part(s):** Part 74 Subpart H (Section 74.861)  
**Result:** Complies  
**Received Date:** 2023-04-14  
**Test Date:** 2023-04-20 ~ 2023-08-04

**Reviewed By:**

\_\_\_\_\_  
Jame Yuan

**Approved By:**

\_\_\_\_\_  
Robin Wu



The test results relate only to the samples tested.

The test results shown in the test report are traceable to the national/international standards through the calibration of the equipment and evaluated measurement uncertainty herein.

The test report shall not be reproduced except in full without the written approval of MRT Technology (Suzhou) Co., Ltd.

---

### Revision History

Report No.	Version	Description	Issue Date	Note
2304RSU032-U2	V01	Initial Report	2023-08-05	Valid

---

**CONTENTS**

Description	Page
<b>1. General Information .....</b>	<b>5</b>
1.1. Applicant .....	5
1.2. Manufacturer .....	5
1.3. Testing Facility .....	5
1.4. Product Information.....	6
1.5. Radio Specification under Test .....	6
1.6. Working Frequencies .....	6
<b>2. Test Configuration .....</b>	<b>7</b>
2.1. Test Mode .....	7
2.2. Test System Connection Diagram .....	7
2.3. Test Software .....	7
2.4. Applied Standards.....	8
2.5. Test Environment Condition.....	8
<b>3. Measuring Instrument .....</b>	<b>9</b>
<b>4. Decision Rules and Measurement Uncertainty .....</b>	<b>10</b>
4.1. Decision Rules .....	10
4.2. Measurement Uncertainty.....	10
<b>5. Test Result.....</b>	<b>11</b>
5.1. Summary .....	11
5.2. RF Output Power Measurement .....	12
5.2.1. Test Limit .....	12
5.2.2. Test Procedure .....	12
5.2.3. Test Setting .....	12
5.2.4. Test Setup .....	12
5.2.5. Test Result .....	12
5.3. Frequency Tolerance Measurement .....	13
5.3.1. Test Limit .....	13
5.3.2. Test Procedure .....	13
5.3.3. Test Setting .....	13
5.3.4. Test Setup .....	14
5.3.5. Test Result .....	14
5.4. 99% Occupied Bandwidth Measurement.....	15
5.4.1. Test Limit .....	15
5.4.2. Test Procedure .....	15
5.4.3. Test Setting .....	15

5.4.4.	Test Setup .....	15
5.4.5.	Test Result .....	15
5.5.	Out-of-band Emission Mask Measurement .....	16
5.5.1.	Test Limit .....	16
5.5.2.	Test Procedure .....	16
5.5.3.	Test Setting .....	16
5.5.4.	Test Setup .....	16
5.5.5.	Test Result .....	17
5.6.	Necessary Bandwidth Measurement .....	18
5.6.1.	Test Limit .....	18
5.6.2.	Test Procedure .....	18
5.6.3.	Test Setting .....	18
5.6.4.	Test Setup .....	18
5.6.5.	Test Result .....	18
5.7.	Radiated Spurious Emissions Measurement .....	19
5.7.1.	Test Limit .....	19
5.7.2.	Test Procedure .....	19
5.7.3.	Test Setting .....	19
5.7.4.	Test Setup .....	20
5.7.5.	Test Result .....	20
<b>Appendix A – Test Result .....</b>		<b>21</b>
A.1	RF Output Power Test Result .....	21
A.2	Frequency Tolerance Test Result .....	22
A.3	99% Occupied Bandwidth Test Result .....	23
A.4	Out-of-band Emission Mask Test Result .....	24
A.5	Necessary Bandwidth Test Result .....	27
A.6	Radiated Spurious Emissions Test Result .....	36
<b>Appendix B – Test Setup Photograph .....</b>		<b>37</b>
<b>Appendix C – EUT Photograph .....</b>		<b>38</b>



#### 1.4. Product Information

Product Name	Plug-on Wireless Transmitter
Model No.	SLXD3 G58
Serial No.	3CC23618002 (Radiated Testing) 3CC23617102 (Conducted Testing)
Frequency Range	470 ~ 514 MHz
Power Type	Two AA batteries or Li-ion battery(3.6Vdc) or USB (5Vdc)
Operating Temperature	-18 ~ 50°C
Accessories	
Rechargeable Li-ion Battery	Model: SB903 Output: 3.6Vdc, 1200mAh, 4.32Wh

Note: The information of EUT was provided by the manufacturer, and the accuracy of the information shall be the responsibility of the manufacturer.

#### 1.5. Radio Specification under Test

Frequency Range	470 ~ 514 MHz
Declared Power Level	1mW & 10mW & 30mW
Type of Modulation	4FSK
Channel Spacing	25kHz
Antenna Type	Dipole
Antenna Gain	1.10 dBi

Note: Power level and transmit frequency can be selected using the front panel controls.

#### 1.6. Working Frequencies

Bottom Channel (MHz)	Middle Channel (MHz)	Top Channel (MHz)
470.125	492.125	514.000

## 2. Test Configuration

### 2.1. Test Mode

Mode 1: Transmit one channel at the fixed power level

### 2.2. Test System Connection Diagram

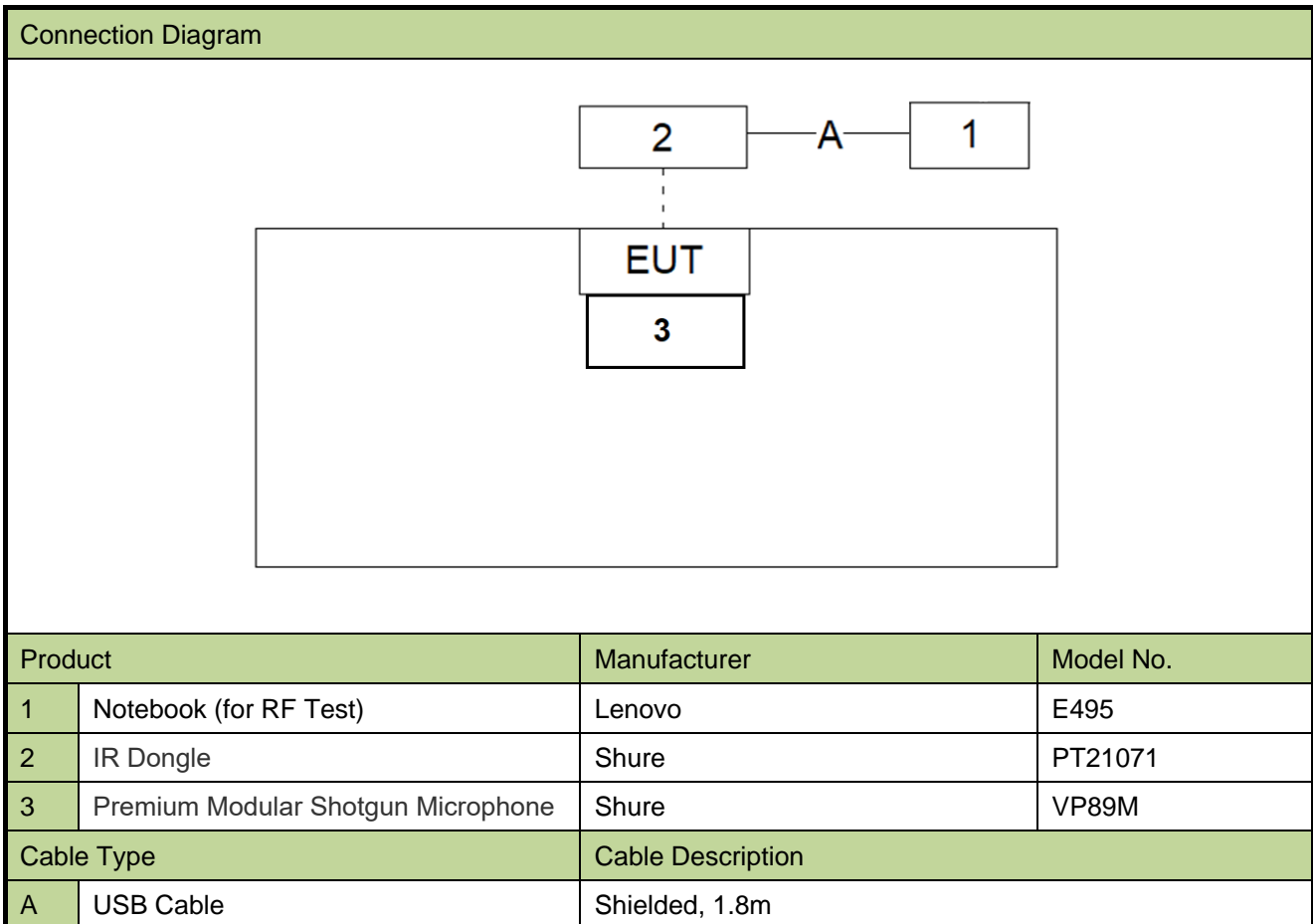

### 2.3. Test Software

The test utility software used during testing was “teraterm”, and the version was V4.85, all test commands were provided by the manufacturer.

#### 2.4. Applied Standards

According to the specifications of the manufacturer, the EUT must comply with the requirements of the following standards:

- FCC Part 74.861
- KDB 206256 D01v02r01
- ANSI C63.26-2015
- ETSI EN 300 422 - 1 V 1.4.2

#### 2.5. Test Environment Condition

Ambient Temperature	15 ~ 35°C
Relative Humidity	20 ~ 75%RH



### 3. Measuring Instrument

Instrument	Manufacturer	Model No.	Asset No.	Cali. Interval	Cali. Due Date	Test Site
Thermohygrometer	testo	608-H1	MRTSUE06402	1 year	2023-06-06	WZ-SR5
					2024-05-31	WZ-SR5
Shielding Room	HUAMING	WZ-SR5	MRTSUE06442	N/A	N/A	WZ-SR5
USB Power Sensor	Keysight	U2021XA	MRTSUE06446	1 year	2023-06-04	WZ-SR5
					2024-05-23	WZ-SR5
Signal Analyzer	Keysight	N9010B	MRTSUE06457	1 year	2023-06-04	WZ-SR5
					2024-05-23	WZ-SR5
Attenuator	MVE	MVE2213	MRTSUE11060	1 year	2023-06-09	WZ-SR5
					2024-06-08	WZ-SR5
Attenuator	MVE	MVE2213	MRTSUE11072	1 year	2023-06-09	WZ-SR5
					2024-06-08	WZ-SR5
Temperature Chamber	BAOYT	BYH-150CL	MRTSUE06051	1 year	2023-10-08	WZ-TR3
Thermohygrometer	testo	608-H1	MRTSUE06401	1 year	2023-06-06	WZ-TR3
					2024-05-31	WZ-TR3
Signal Analyzer	Keysight	N9010B	MRTSUE07027	1 year	2023-11-25	WZ-TR3
TRILOG Antenna	Schwarzbeck	VULB 9162	MRTSUE06022	1 year	2023-05-20	WZ-AC2
					2024-05-15	WZ-AC2
EMI Test Receiver	Agilent	N9038A	MRTSUE06125	1 year	2023-06-04	WZ-AC2
					2024-05-23	WZ-AC2
Thermohygrometer	Mingle	ETH529	MRTSUE06170	1 year	2023-11-27	WZ-AC2
Horn Antenna	Schwarzbeck	BBHA 9120D	MRTSUE06171	1 year	2023-10-13	WZ-AC2
Preamplifier	Schwarzbeck	BBV 9718	MRTSUE06176	1 year	2023-05-08	WZ-AC2
					2024-05-07	WZ-AC2
Anechoic Chamber	RIKEN	WZ-AC2	MRTSUE06213	1 year	2023-04-21	WZ-AC2
				1 year	2024-04-20	WZ-AC2
Thermohygrometer	testo	608-H1	MRTSUE11038	1 year	2023-11-01	WZ-AC2

Software	Version	Function
EMI Software	V3.0.0	EMI Test Software
Controller_MF 7802	1.02	RE Antenna & Turntable
BenchVue Power Meter	2018.1	Power

## 4. Decision Rules and Measurement Uncertainty

### 4.1. Decision Rules

The Decision Rule is based on Simple Acceptance in accordance with ISO Guide 98-4: 2012 Clause 8.2. (Measurement uncertainty is not taken into account when stating conformity with a specified requirement.)

### 4.2. Measurement Uncertainty

Where relevant, the following test uncertainty levels have been estimated for tests performed on the EUT as specified in CISPR 16-4-2. This uncertainty represents an expanded uncertainty expressed at approximately the 95% confidence level using a coverage factor of  $k = 2$ .

AC Conducted Emission Measurement	
The maximum measurement uncertainty is evaluated as:	
9kHz~150kHz:	3.58dB
150kHz~30MHz:	3.20dB
Radiated Emission Measurement	
The maximum measurement uncertainty is evaluated as:	
Coaxial:	9kHz~30MHz: 2.59dB
Coplanar:	9kHz~30MHz: 2.60dB
Horizontal:	30MHz~200MHz: 3.85dB
	200MHz~1GHz: 4.36dB
	1GHz~40GHz: 4.98dB
Vertical:	30MHz~200MHz: 4.06dB
	200MHz~1GHz: 5.28dB
	1GHz~40GHz: 4.91dB
Spurious Emissions, Conducted	
Measuring Uncertainty for a Level of Confidence of 95% ( $U=2Uc(y)$ ):	
2.3dB	
Output Power	
Measuring Uncertainty for a Level of Confidence of 95% ( $U=2Uc(y)$ ):	
1.5dB	
Occupied Bandwidth	
Measuring Uncertainty for a Level of Confidence of 95% ( $U=2Uc(y)$ ):	
3.2%	

## 5. Test Result

### 5.1. Summary

FCC Part Section(s)	Test Description	Test Condition	Test Result
74.861(e)(1)(ii)	RF Output Power	Conducted	Pass
74.861(e)(4)	Frequency Stability		Pass
74.861(e)(5)	Occupied Bandwidth		Pass
74.861(e)(6)	Emission Mask		Pass
74.861(e)(7)	Necessary Bandwidth		Pass
74.861(e)(7)	Radiated Spurious Emission	Radiated	Pass

Notes:

- 1) The analyzer plots shown in this section were all taken with a correction table loaded into the analyzer. The correction table was used to account for the losses of the cables and attenuators used as part of the system to connect the EUT to the analyzer at all frequencies of interest.
- 2) All modes of operation and data rates were investigated. For radiated emission test, every axis (X, Z) was also verified. The test results shown in the following sections represent the worst emissions.
- 3) For different power levels, except RF Output Power & necessary bandwidth & emission mask test items were evaluated all power levels, any others test items were only assessed max power level.

## 5.2. RF Output Power Measurement

### 5.2.1. Test Limit

The conducted power may not exceed 250mW in 470 ~ 608 MHz band.

### 5.2.2. Test Procedure

ANSI C63.26-2015 - Section 5.2.4.2

### 5.2.3. Test Setting

The output of the EUT was connected to an RF average power meter through fixed attenuation.

The EUT was set to transmit on the low, middle, and high frequencies in each power level.

Measure the average power of the transmitter.

### 5.2.4. Test Setup

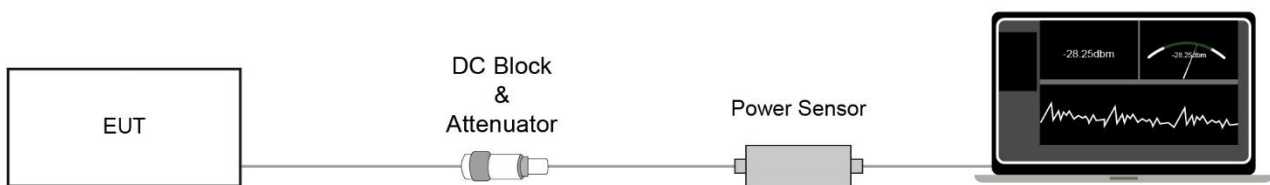

### 5.2.5. Test Result

Refer to Appendix A.1.

### **5.3. Frequency Tolerance Measurement**

#### **5.3.1. Test Limit**

The frequency tolerance of the transmitter shall be 0.005 percent.

#### **5.3.2. Test Procedure**

ANSI C63.26 - Section 5.6.3

#### **5.3.3. Test Setting**

##### **Frequency Stability Under Temperature Variations:**

The equipment under test was connected to an external AC or DC power supply and input rated voltage. RF output was connected to a frequency counter or spectrum analyzer via feed through attenuators. The EUT was placed inside the temperature chamber. Set the spectrum analyzer RBW low enough to obtain the desired frequency resolution and measure EUT 20°C operating frequency as reference frequency. Turn EUT off and set the chamber temperature to highest. After the temperature stabilized for approximately 30 minutes recorded the frequency. Repeat step measure with 10°C decreased per stage until the lowest temperature reached.

##### **Frequency Stability Under Voltage Variations:**

Set chamber temperature to 20°C. Use a variable AC power supply / DC power source to power the EUT and set the voltage to rated voltage. Set the spectrum analyzer RBW low enough to obtain the desired frequency resolution and recorded the frequency.

Reduce the input voltage to specify extreme voltage variation ( $\pm 15\%$ ) and endpoint (If a product is specified to operate over a range of input voltage then the  $-15\%$  variation is applied to the lowermost voltage and the  $+15\%$  is applied to the uppermost voltage), record the maximum frequency change.

### 5.3.4. Test Setup

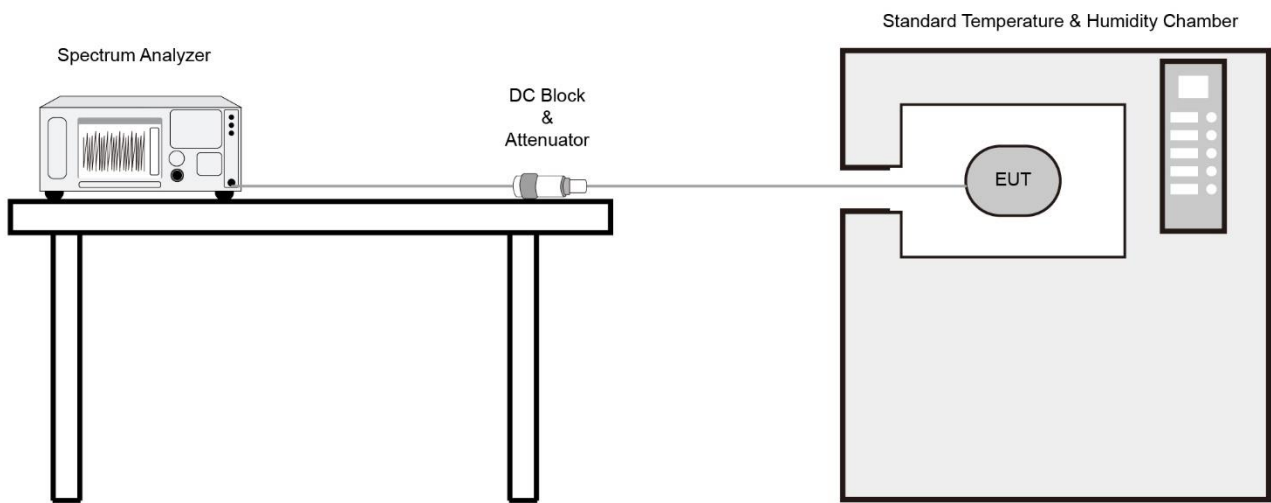

### 5.3.5. Test Result

Refer to Appendix A.2.

## 5.4. 99% Occupied Bandwidth Measurement

### 5.4.1. Test Limit

The operating bandwidth shall not exceed 200 kHz.

### 5.4.2. Test Procedure

ANSI C63.26-2015 - Section 5.4.4

### 5.4.3. Test Setting

1. The signal analyzer's automatic bandwidth measurement capability was used to perform the 99% occupied bandwidth. The bandwidth measurement was not influenced by any intermediate power nulls in the fundamental emission.
2.  $RBW = 1 - 5\%$  of the expected OBW
3.  $VBW \geq 3 \times RBW$
4. Detector = Peak
5. Trace mode = max hold
6. Sweep = auto couple
7. The trace was allowed to stabilize
8. Reported the measured 99% occupied bandwidth

### 5.4.4. Test Setup

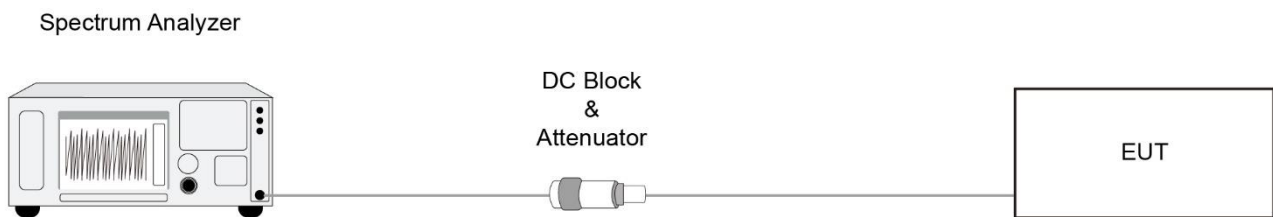

### 5.4.5. Test Result

Refer to Appendix A.3.

## 5.5. Out-of-band Emission Mask Measurement

### 5.5.1. Test Limit

The mean power of emissions shall be attenuated below the mean output power of the transmitter in accordance with the following schedule:

- (i) On any frequency removed from the operating frequency by more than 50 percent up to and including 100 percent of the authorized bandwidth: at least 25 dB;
- (ii) On any frequency removed from the operating frequency by more than 100 percent up to and including 250 percent of the authorized bandwidth: at least 35 dB;
- (iii) On any frequency removed from the operating frequency by more than 250 percent of the authorized bandwidth: at least  $43+10\log_{10}$  (mean output power in watts) dB.

### 5.5.2. Test Procedure

ANSI C63.26 - Section 5.7

### 5.5.3. Test Setting

Emission Mask

- a) The EUT was connected to a spectrum analyzer. The un-modulated carrier signal level was measured and recorded.
- b) The EUT was modulated with typical digital modulation.
- c) The spectrum analyzer center frequency was set to the EUT operating frequency; span was set to 2 MHz; resolution bandwidth was set to 1 MHz; video bandwidth set to 3 MHz; sweep time set to 3 s; after clear/write, max-hold was set; Marker 1 was set to RMS, then Marker 1 was set to reference value.
- d) The RMS output power was recorded and used to set the reference level on the spectrum analyzer.
- e) The spectrum analyzer span was then set to 1.5 MHz; resolution bandwidth set to 2 kHz, video bandwidth set to 5 kHz, sweep time to Auto.

### 5.5.4. Test Setup

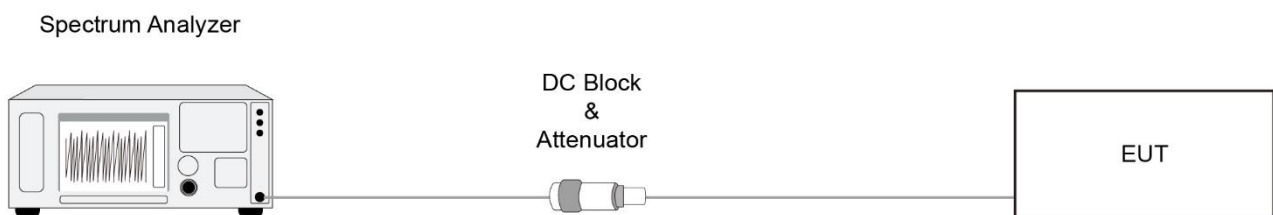



#### **5.5.5. Test Result**

Refer to Appendix A.4.

## 5.6. Necessary Bandwidth Measurement

### 5.6.1. Test Limit

Digital emissions within the band from one megahertz below to one megahertz above the carrier frequency shall comply with the emission mask in section 8.3.2.2 of the European Telecommunications Institute Standard ETSI EN 300 422-1 v1.4.2, the transmitter output spectrum shall be within the mask defined as below figure.

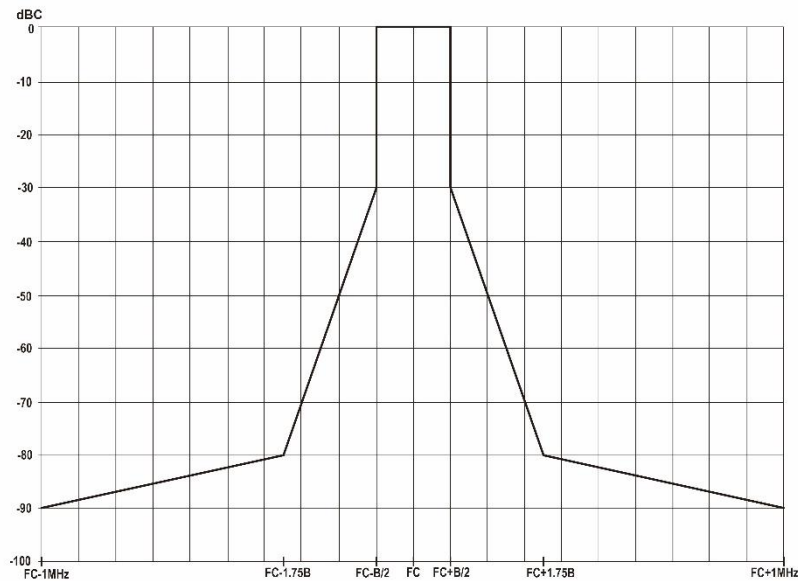

### 5.6.2. Test Procedure

EN 300 422-1 V1.4.2 clause 8.3.2.1.

### 5.6.3. Test Setting

The EUT was powered up and the transmit frequency & power output of the EUT were selected.

The spectrum analyzer center frequency is set to the nominal EUT channel center frequency.

### 5.6.4. Test Setup

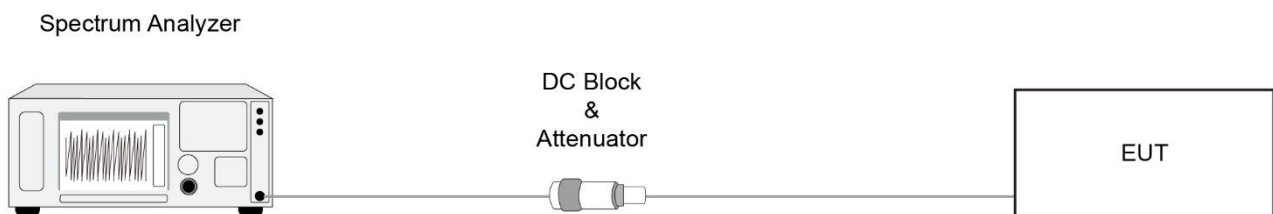

### 5.6.5. Test Result

Refer to Appendix A.5.

## 5.7. Radiated Spurious Emissions Measurement

### 5.7.1. Test Limit

According to FCC Part 74.861(e)(7), beyond one megahertz below and above the carrier frequency, emissions shall comply with the limits specified in section 8.4 of ETSI EN 300 422-1 v1.4.2.

State	Frequency Range		
	47MHz to 74MHz, 87.5MHz to 137MHz 174MHz to 230MHz, 470MHz to 862MHz	Other Frequencies below 1000MHz	Frequencies above 1000MHz
Operation	4nW	250nW	1uW
Standby	2nW	2nW	20nW

### 5.7.2. Test Procedure

ETSI EN 300 422-1 V1.4.2 clause 8.4.2.

### 5.7.3. Test Setting

**Table 1 - RBW as a function of frequency**

Frequency	RBW
25 ~ 30 MHz	9 kHz
30 ~ 1000 MHz	100 kHz
1000 ~ 6000 MHz	1 MHz

Emissions shall be investigated up to the 10<sup>th</sup> harmonic of the fundamental.

Compliance with the emission limits shall be demonstrated using an RMS Average detector.

All significant broadband and narrowband signals found in the preliminary sweeps were measured using a peak detector at a test distance of 3 meters.

At each frequency at which a component is detected, the sample shall be rotated to obtain maximum response and the effective radiated power of that component determined by a substitution measurement.

### 5.7.4. Test Setup

Below 1GHz Test Setup:

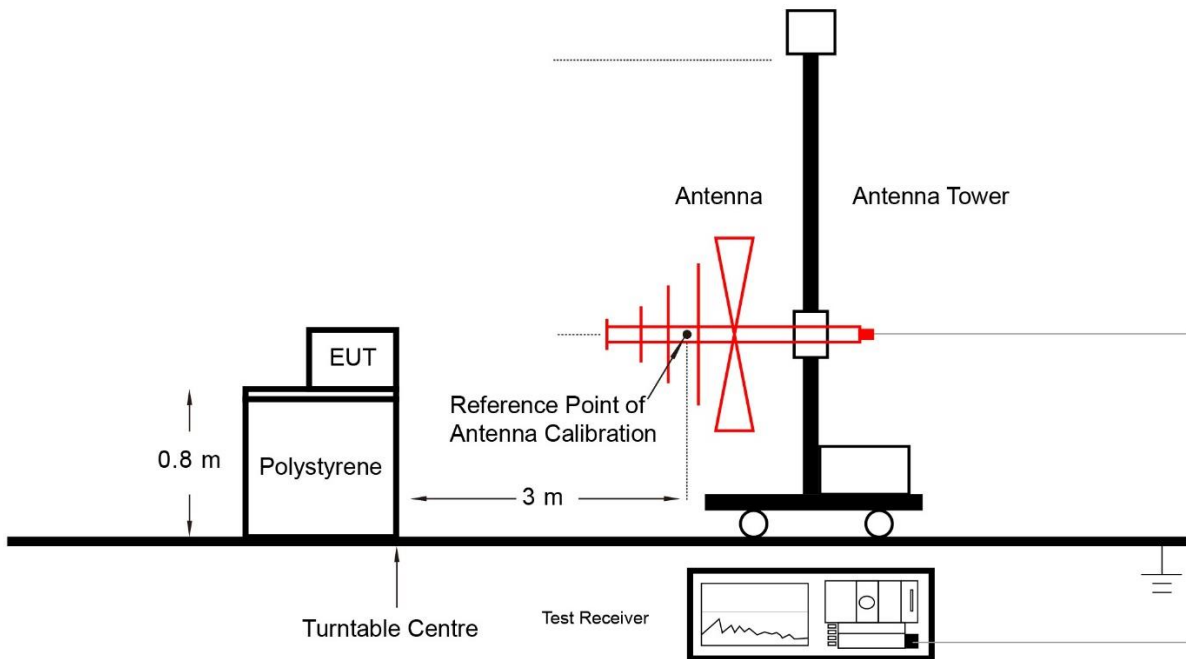

Above 1GHz Test Setup:

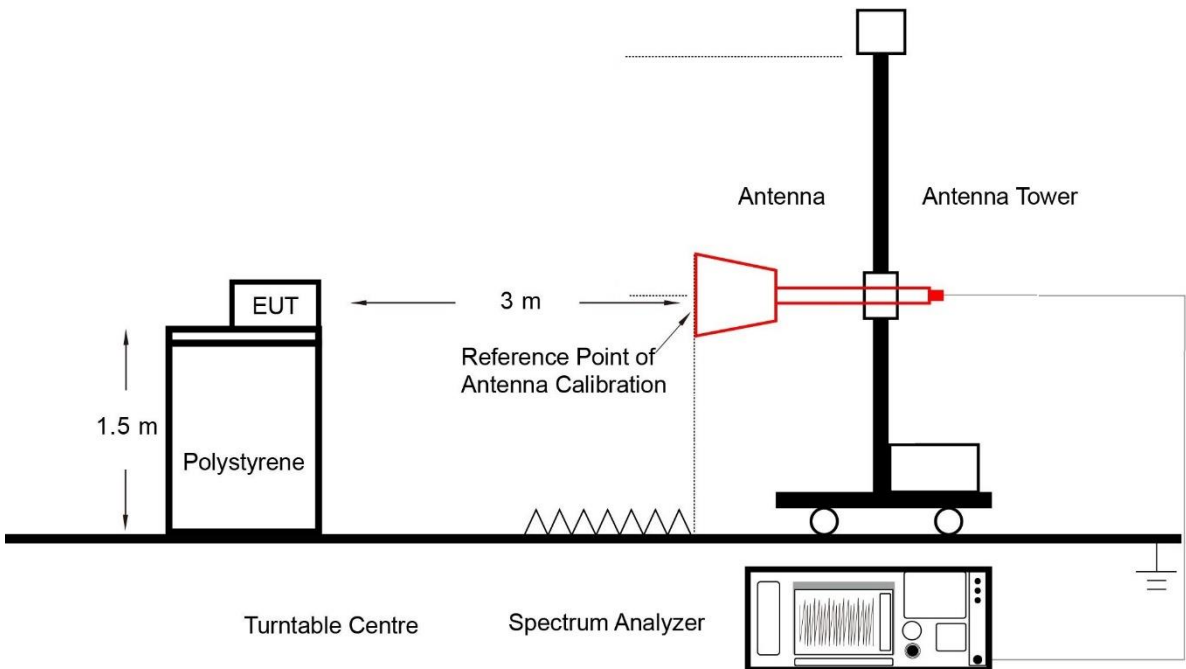

### 5.7.5. Test Result

Refer to Appendix A.6.

## Appendix A – Test Result

### A.1 RF Output Power Test Result

Test Site	WZ-SR5	Test Engineer	Dandy Li
Test Date	2023-04-23 ~ 2023-08-03		

Frequency (MHz)	Conducted Output Power (dBm)	Limit (dBm)	Test Result
30mW Power Level			
470.125	15.44	≤ 23.98	Pass
492.125	15.19	≤ 23.98	Pass
514.000	15.40	≤ 23.98	Pass
10mW Power Level			
470.125	10.12	≤ 23.98	Pass
492.125	10.35	≤ 23.98	Pass
514.000	10.49	≤ 23.98	Pass
1mW Power Level			
470.125	0.36	≤ 23.98	Pass
492.125	0.47	≤ 23.98	Pass
514.000	0.48	≤ 23.98	Pass

Note: Limit =  $10 \cdot \log(250\text{mW}) = 23.98$  dBm.

**A.2 Frequency Tolerance Test Result**

Test Site	WZ-TR3	Test Engineer	Dandy Li
Test Date	2023-08-03	Test Mode	470.125MHz

Voltage (%)	Power (VDC)	Temp (°C)	Frequency Tolerance (%)			
			0 minutes	2 minutes	5 minutes	10 minutes
100	3.6	- 10	0.000053	0.000054	0.000051	0.000051
		0	0.000054	0.000053	0.000053	0.000053
		+ 10	0.000053	0.000052	0.000052	0.000052
		+ 20	0.000053	0.000052	0.000052	0.000053
		+ 30	0.000052	0.000053	0.000052	0.000053
		+ 40	0.000051	0.000051	0.000050	0.000050
		+ 50	0.000050	0.000051	0.000051	0.000175
115	4.14	+ 20	0.000053	0.000053	0.000052	0.000053
85	3.06	+ 20	0.000053	0.000053	0.000052	0.000053

Note: Frequency Tolerance (ppm) =  $\{[\text{Measured Frequency (Hz)} - \text{Declared Frequency (Hz)}] / \text{Declared Frequency (Hz)}\} * 10^2$ .

**A.3 99% Occupied Bandwidth Test Result**

Test Site	WZ-SR5	Test Engineer	Dandy Li
Test Date	2023-04-20 ~ 2023-08-03		

Test Mode	Frequency (MHz)	99% Bandwidth (kHz)	Limit (kHz)	Result
30mW Power Level	470.125	167.72	< 200	Pass
	492.125	166.86	< 200	Pass
	514.000	168.39	< 200	Pass

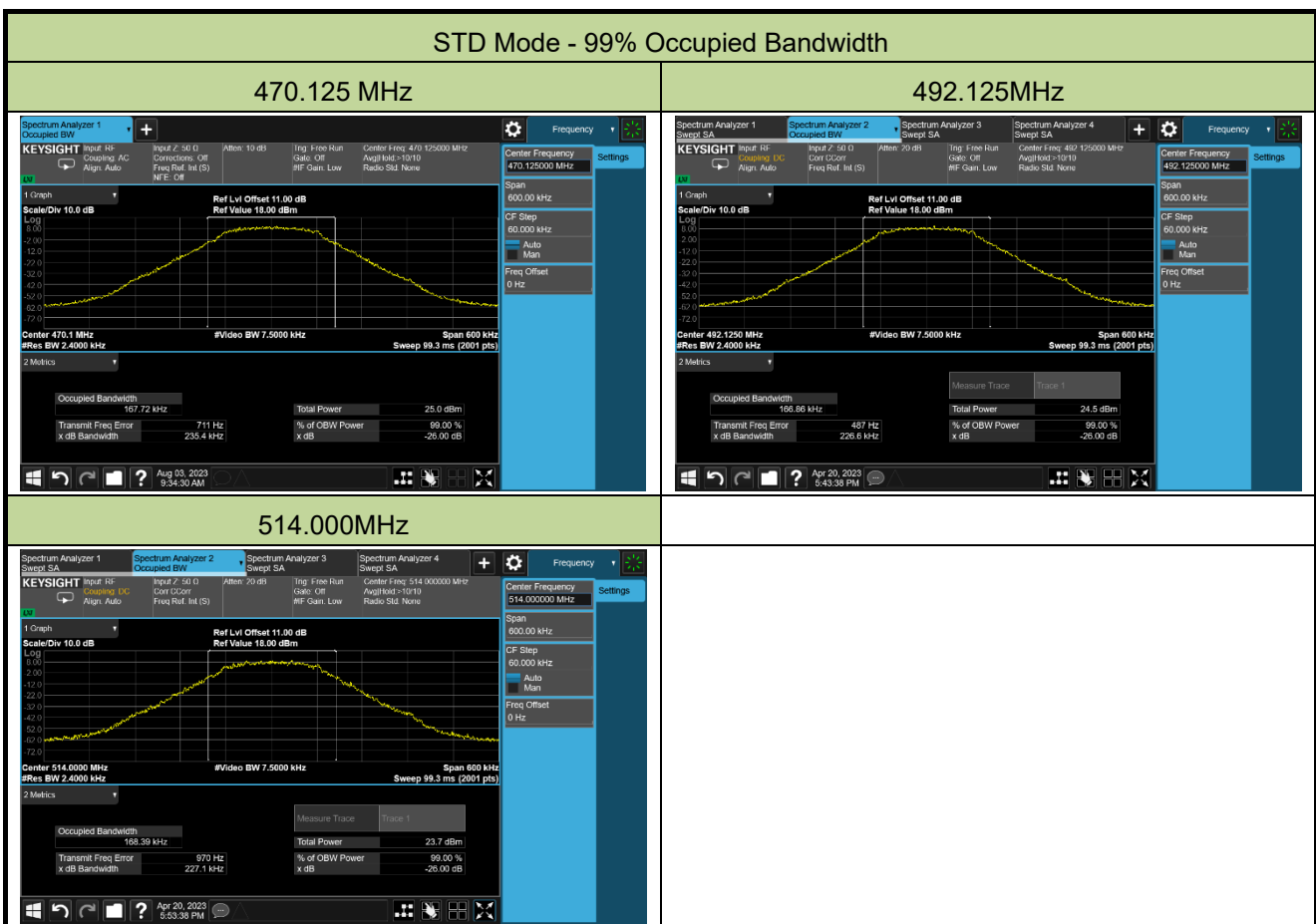

**A.4 Out-of-band Emission Mask Test Result**

Test Site	WZ-SR5	Test Engineer	Dandy Li
Test Date	2023-04-21 ~ 2023-08-03		

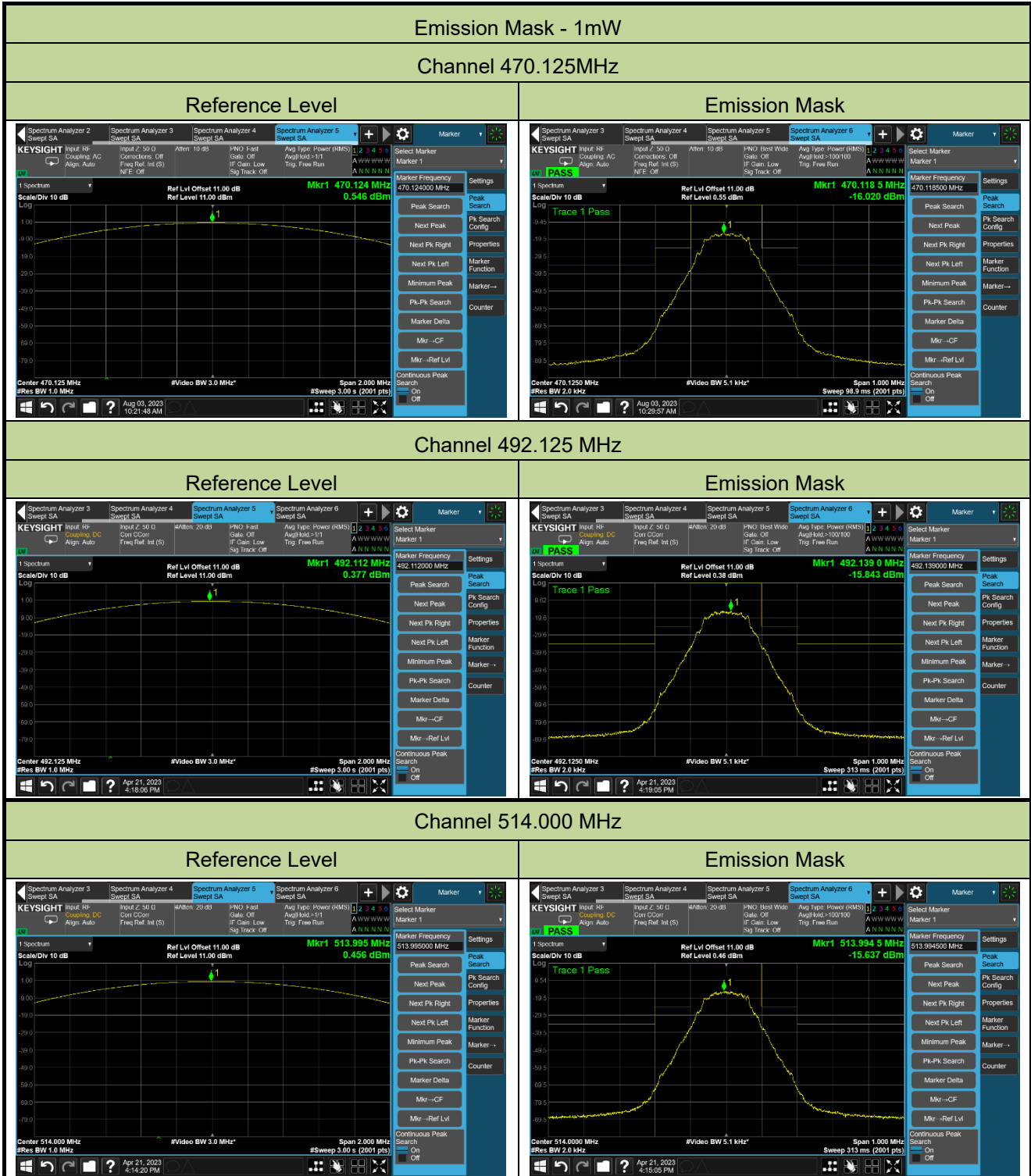



### Emission Mask - 10mW

#### Channel 470.125MHz

##### Reference Level

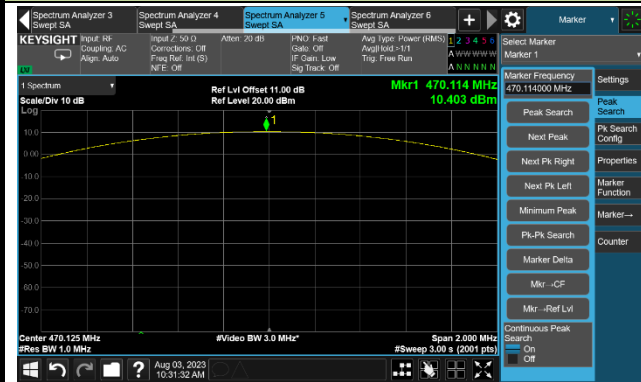

##### Emission Mask

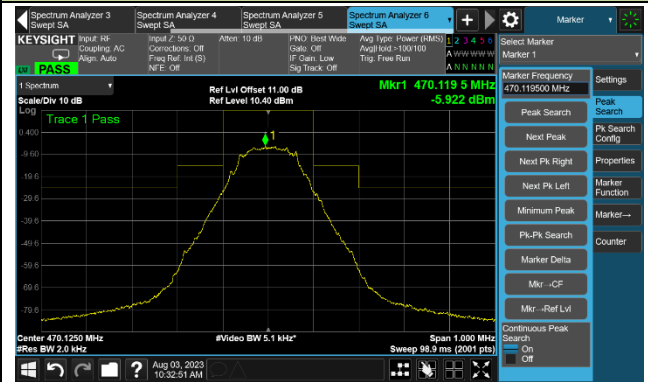

#### Channel 492.125 MHz

##### Reference Level

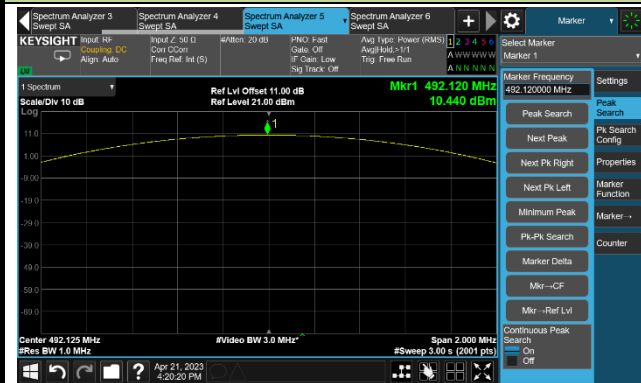

##### Emission Mask

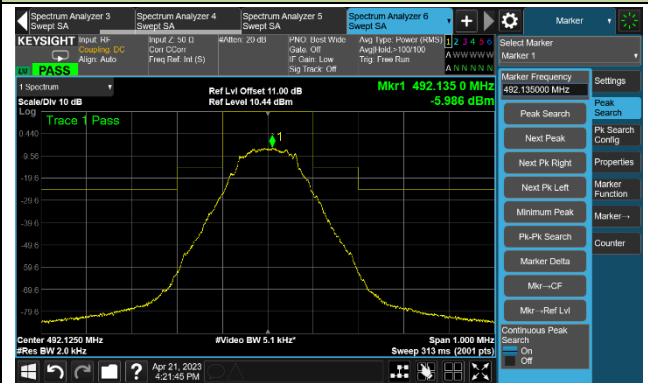

#### Channel 514.000 MHz

##### Reference Level

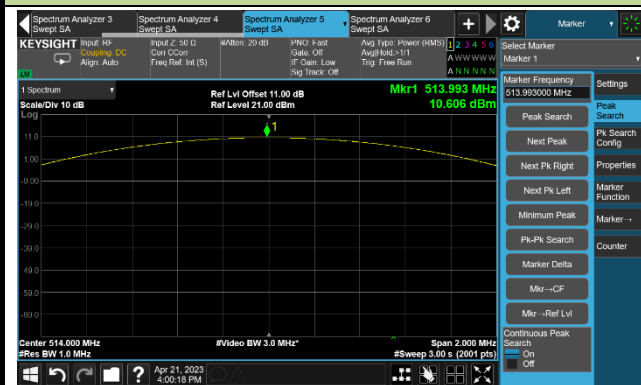

##### Emission Mask

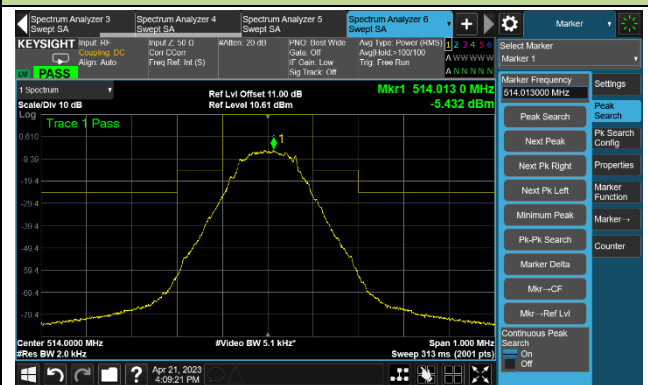

### Emission Mask - 30mW

#### Channel 470.125MHz

##### Reference Level

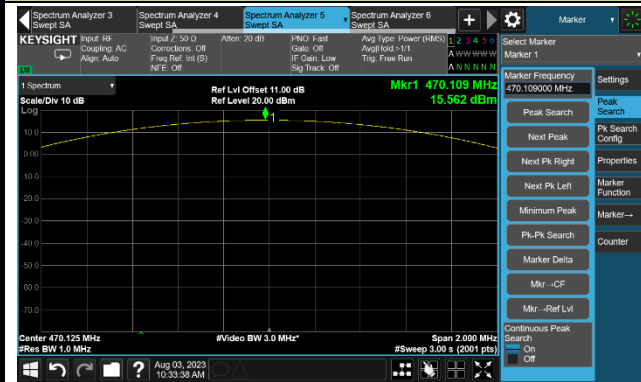

##### Emission Mask

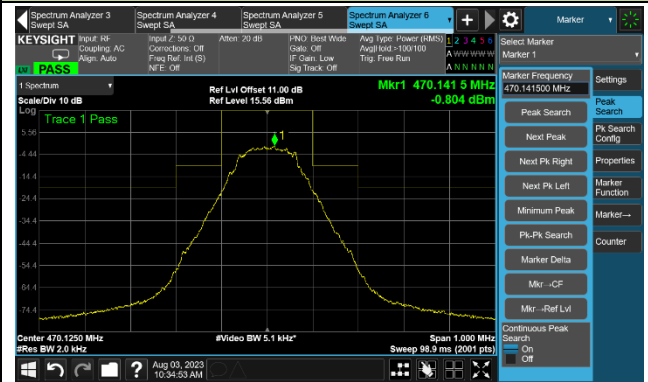

#### Channel 492.125 MHz

##### Reference Level

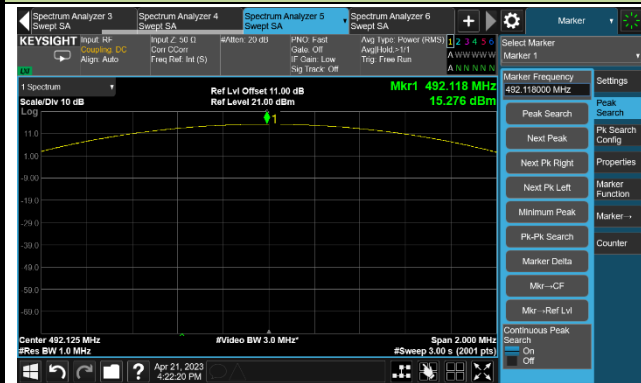

##### Emission Mask

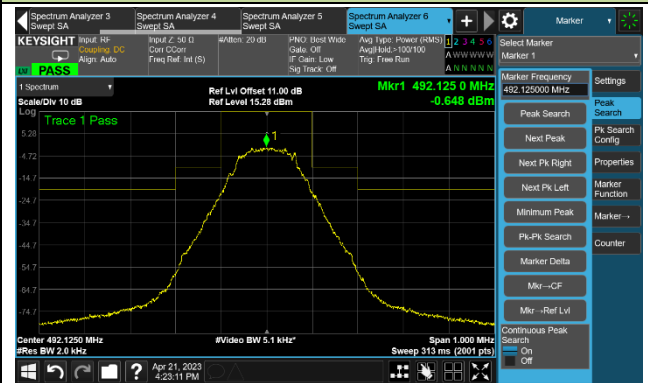

#### Channel 514.000 MHz

##### Reference Level

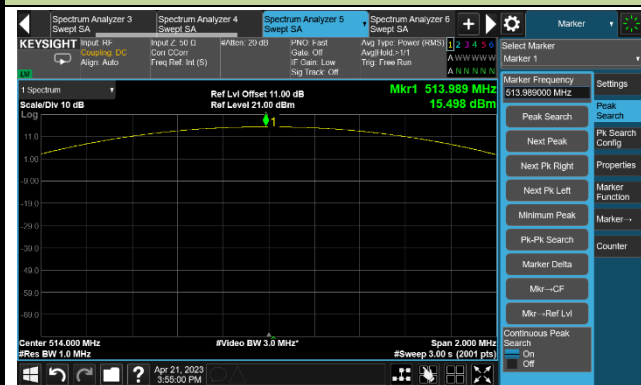

##### Emission Mask

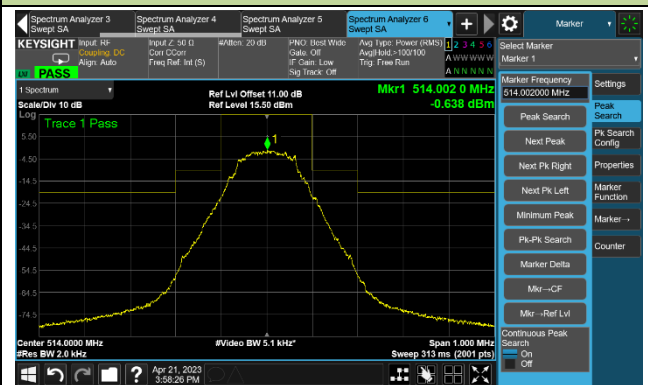

### A.5 Necessary Bandwidth Test Result

Test Site	WZ-SR5	Test Engineer	Dandy Li
Test Date	2023-04-20 ~ 2023-08-03		

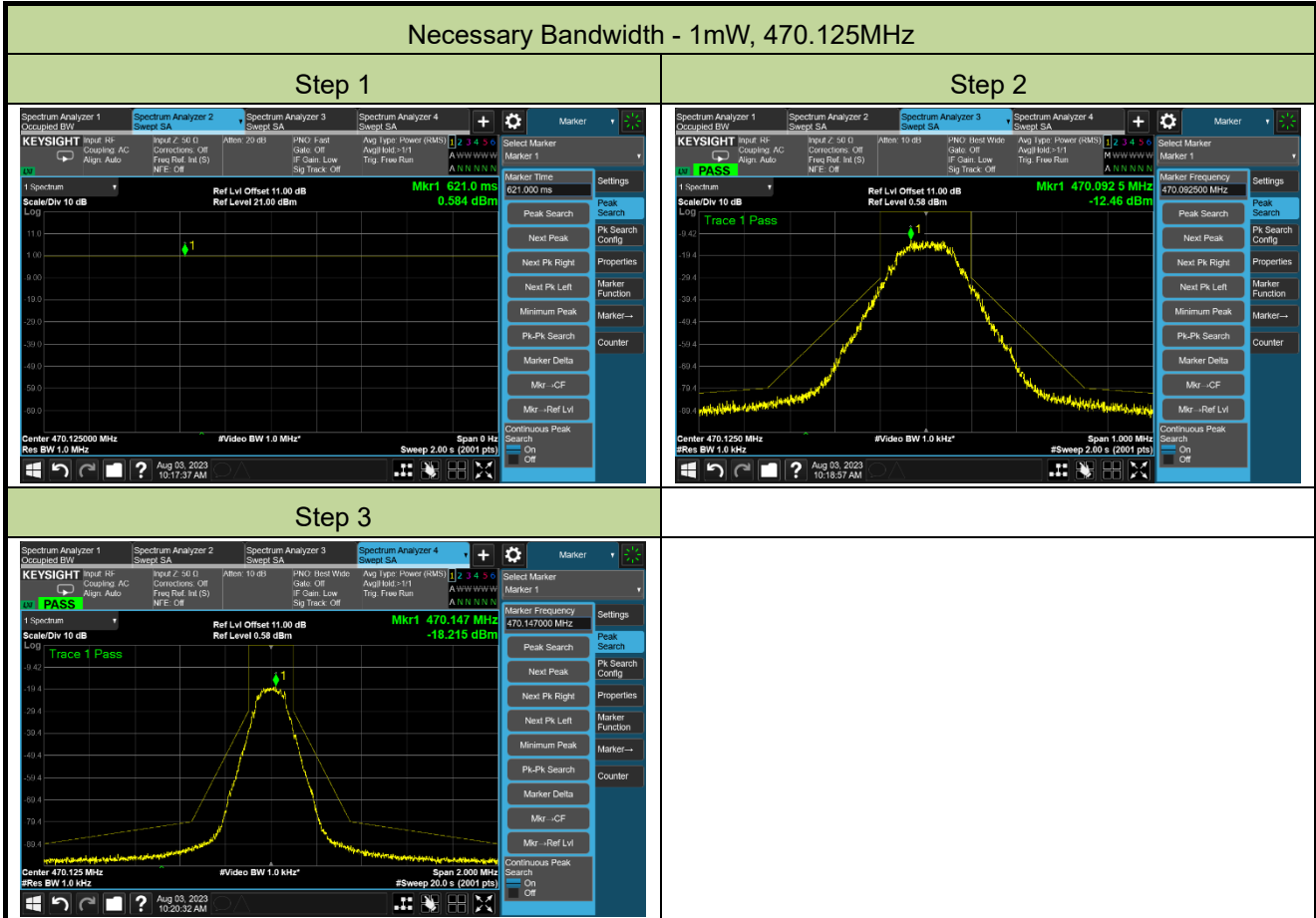

### Necessary Bandwidth - 1mW, 492.125MHz

#### Step 1

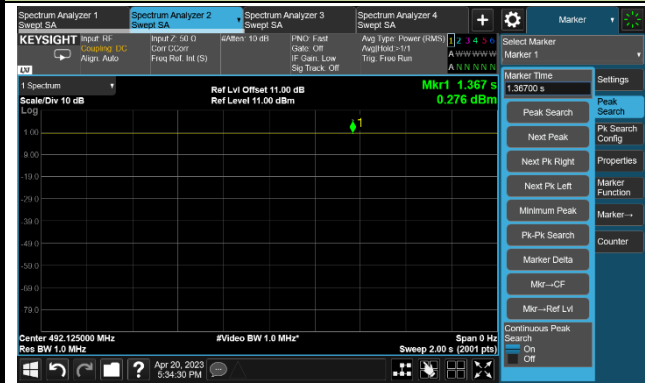

#### Step 2

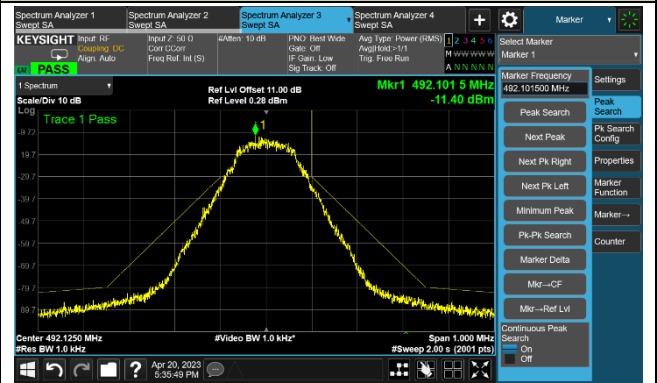

#### Step 3

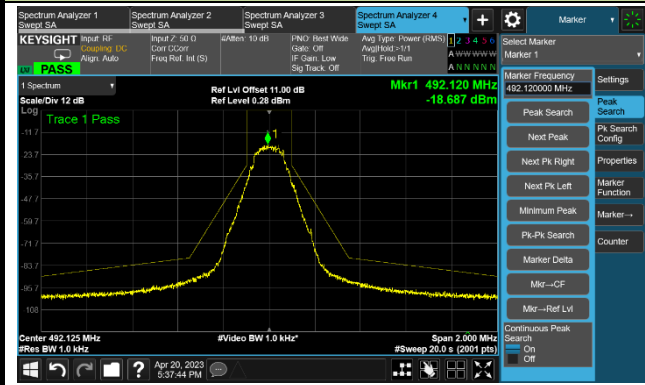

### Necessary Bandwidth - 1mW, 514.000MHz

#### Step 1

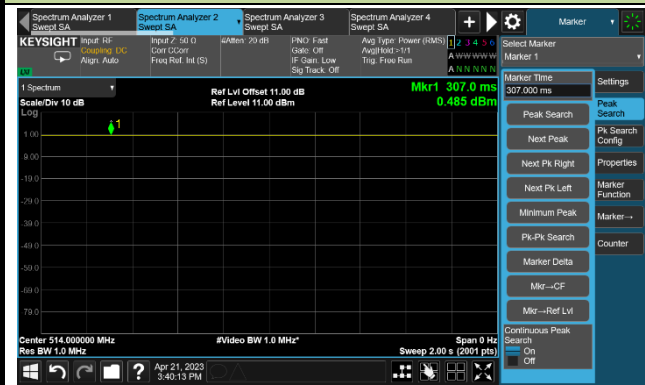

#### Step 2

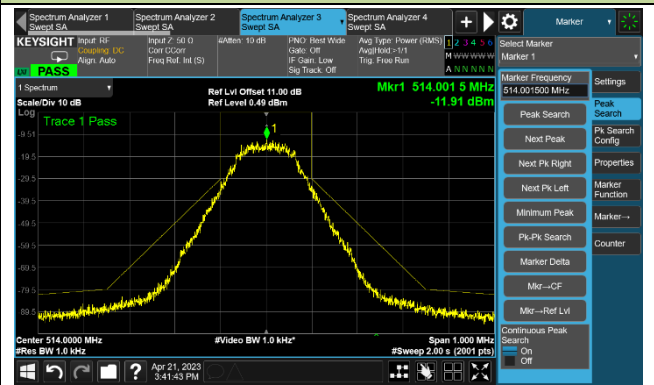

#### Step 3

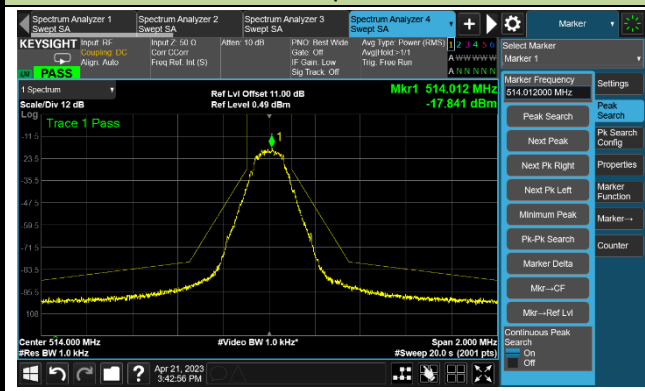

### Necessary Bandwidth - 10mW, 470.125MHz

#### Step 1

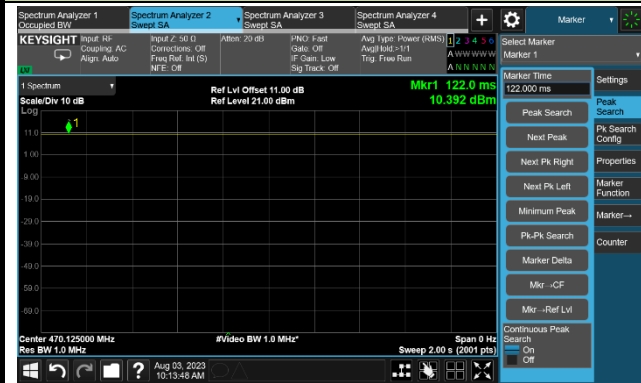

#### Step 2

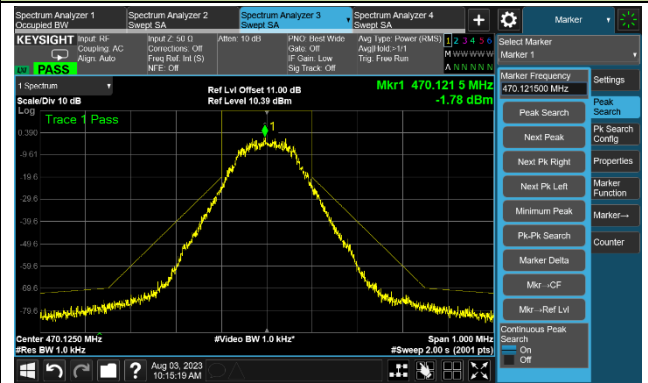

#### Step 3

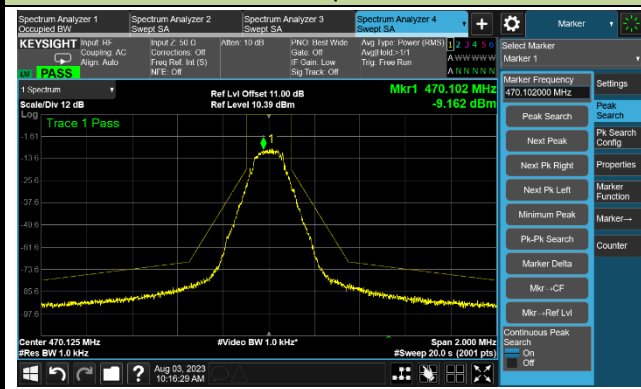

### Necessary Bandwidth - 10mW, 492.125MHz

#### Step 1

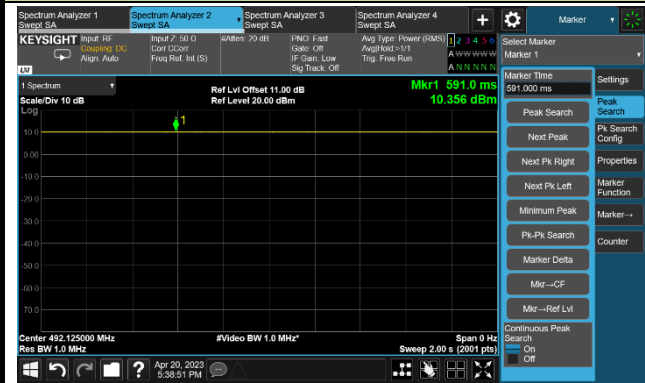

#### Step 2

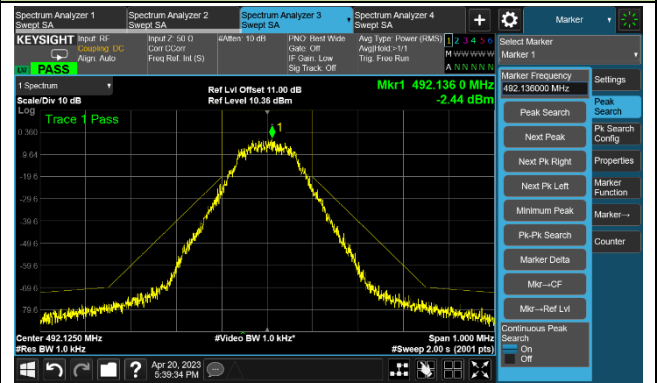

#### Step 3

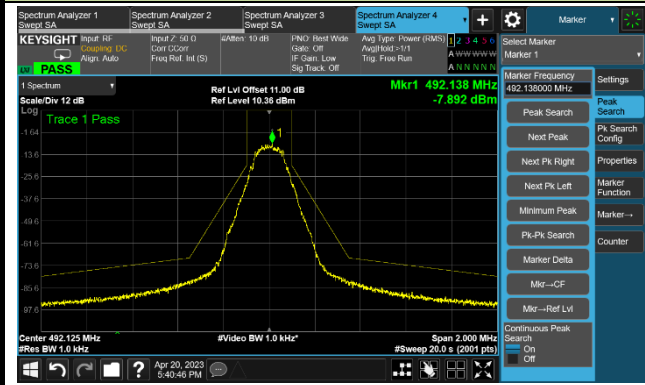

### Necessary Bandwidth - 10mW, 514.000MHz

#### Step 1

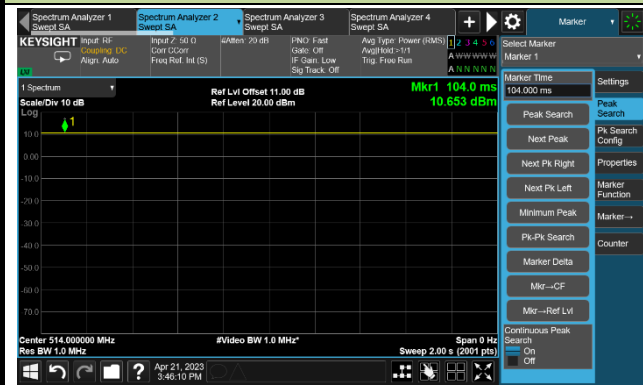

#### Step 2

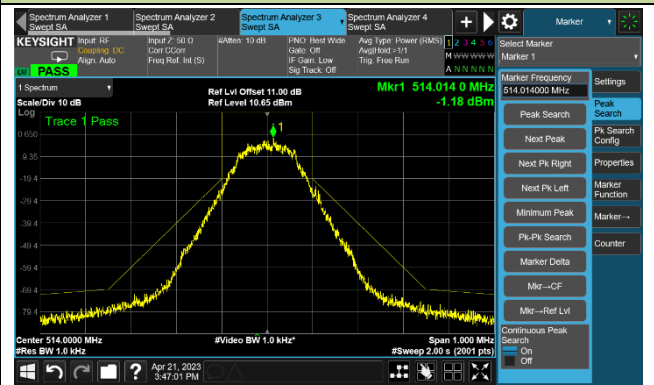

#### Step 3

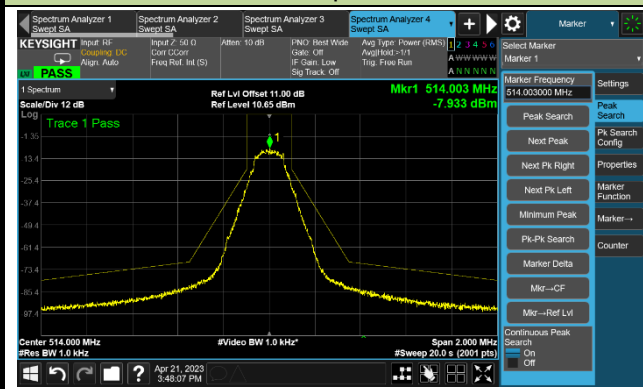



### Necessary Bandwidth - 30mW, 470.125MHz

#### Step 1

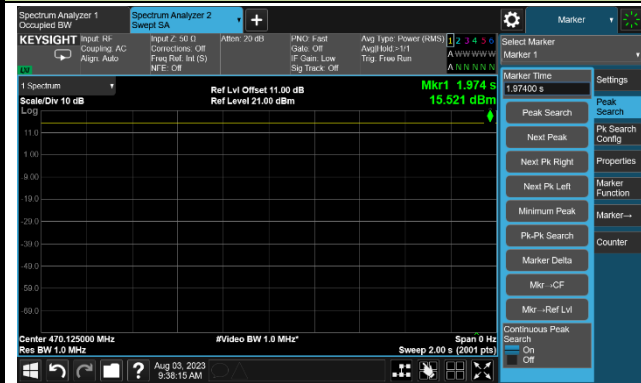

#### Step 2

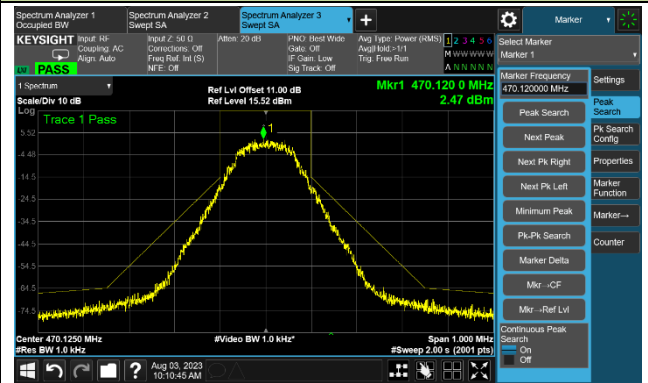

#### Step 3

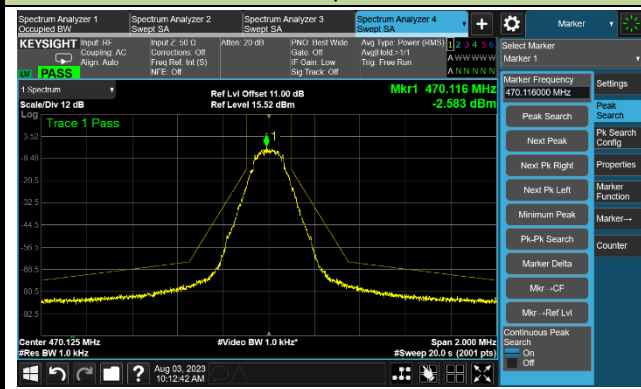

### Necessary Bandwidth - 30mW, 492.125MHz

#### Step 1

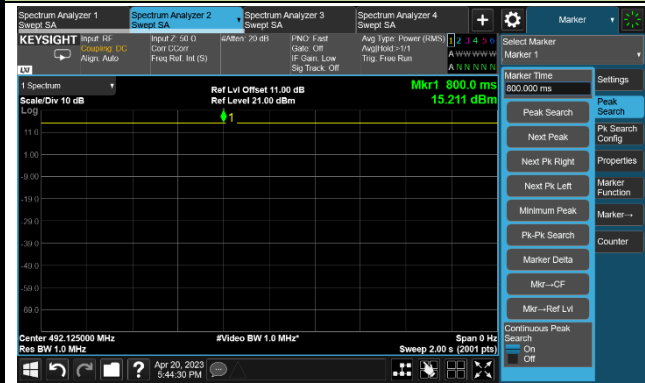

#### Step 2

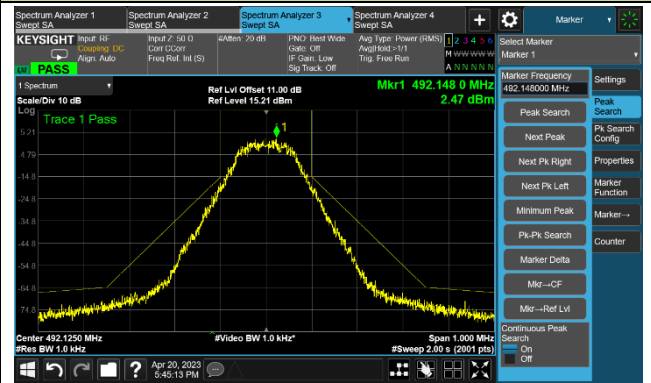

#### Step 3

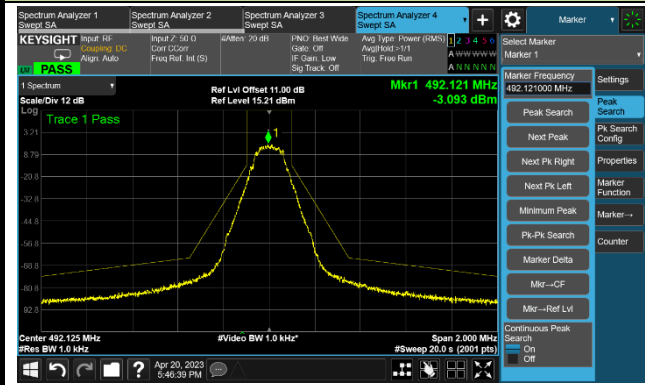

### Necessary Bandwidth - 30mW, 514.000MHz

#### Step 1

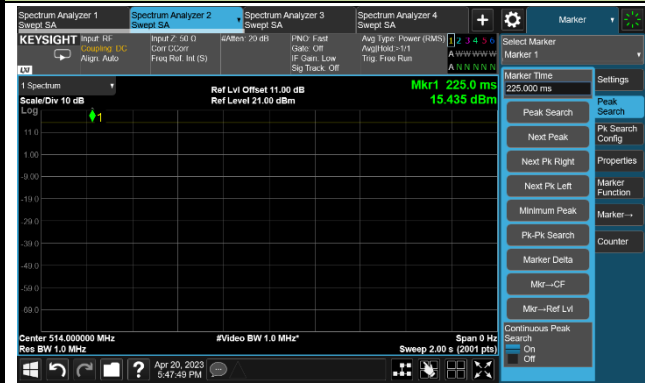

#### Step 2

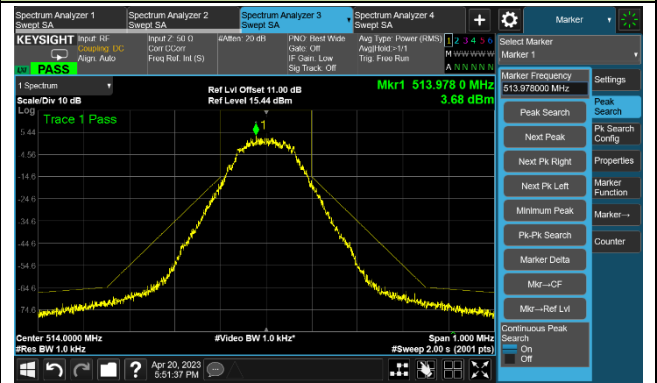

#### Step 3

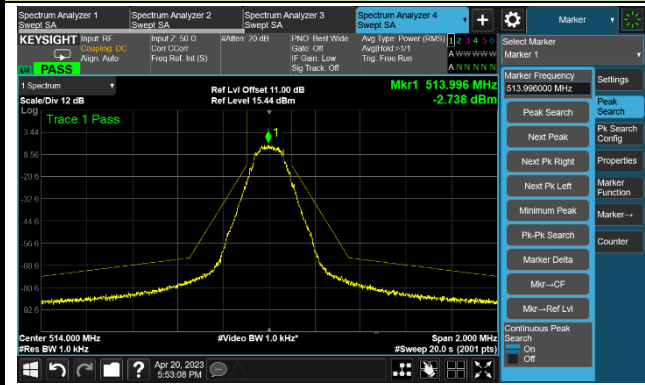

**A.6 Radiated Spurious Emissions Test Result**

Test Site	WZ-AC2	Test Engineer	Dick Shen
Test Date	2023-04-26 ~ 2023-08-04	Test Mode	30mW Power Level

Test Channel (MHz)	Frequency (MHz)	Reading Level (dBm)	Substitution Factor (dB)	Measure Level (dBm)	Limit (dBm)	Margin (dB)	Detector	Polarization
470.125	194.900	-101.4	28.3	-73.1	-54.0	-19.1	Peak	Horizontal
	676.990	-101.0	36.5	-64.5	-54.0	-10.5	Peak	Horizontal
	107.600	-101.4	30.4	-71.0	-54.0	-17.0	Peak	Vertical
	748.285	-100.7	36.7	-64.0	-54.0	-10.0	Peak	Vertical
	1738.000	-63.7	5.0	-58.7	-30.0	-28.7	Peak	Horizontal
	3770.000	-66.5	13.5	-53.0	-30.0	-23.0	Peak	Horizontal
	3538.000	-65.5	13.5	-52.0	-30.0	-22.0	Peak	Vertical
492.125	4758.000	-67.6	16.7	-50.9	-30.0	-20.9	Peak	Vertical
	212.845	-104.2	31.4	-72.8	-54.0	-18.8	Peak	Horizontal
	812.790	-102.6	38.1	-64.5	-54.0	-10.5	Peak	Horizontal
	97.415	-104.2	40.6	-63.6	-54.0	-9.6	Peak	Vertical
	760.410	-103.2	38.5	-64.7	-54.0	-10.7	Peak	Vertical
	1476.000	-62.3	5.8	-56.5	-30.0	-26.5	Peak	Horizontal
	1920.000	-65.0	8.2	-56.8	-30.0	-26.8	Peak	Horizontal
514.000	1078.000	-64.5	7.3	-57.2	-30.0	-27.2	Peak	Vertical
	2814.000	-67.0	10.4	-56.6	-30.0	-26.6	Peak	Vertical
	50.855	-104.7	31.3	-73.4	-54.0	-19.4	Peak	Horizontal
	730.825	-103.4	38.2	-65.2	-54.0	-11.2	Peak	Horizontal
	96.445	-104.8	40.0	-64.8	-54.0	-10.8	Peak	Vertical
	745.375	-102.7	37.6	-65.1	-54.0	-11.1	Peak	Vertical
	1920.000	-65.7	8.2	-57.5	-30.0	-27.5	Peak	Horizontal
4057.500	-68.9	12.5	-56.4	-30.0	-26.4	Peak	Horizontal	
1357.500	-67.1	9.1	-58.0	-30.0	-28.0	Peak	Vertical	
4050.000	-69.1	12.8	-56.3	-30.0	-26.3	Peak	Vertical	

Note 1: Measure Level (dBm) = Reading Level (dBm) + Substitution Factor (dB)

Note 2: Substitution Factor (dB) = Cable Loss (dB) + Space Attenuation (dB) - Antenna Gain (dBi) - 2.15 (dB)

Note 3: RMS measurement was not performed when peak measure level was lower than the RMS limit.

## Appendix B – Test Setup Photograph

Refer to “ 2304RSU032-UT” file.

## Appendix C – EUT Photograph

Refer to “2304RSU032-UE” file.