

**SHURE**

# SLX-D

SLX-D Digital Wireless

## PRELIMINARY USER GUIDE





©2020 Shure Incorporated  
00000000 (Preliminary Draft)

Printed in China



# IMPORTANT SAFETY INSTRUCTIONS

1. READ these instructions.
2. KEEP these instructions.
3. HEED all warnings.
4. FOLLOW all instructions.
5. DO NOT use this apparatus near water.
6. CLEAN ONLY with dry cloth.
7. DO NOT block any ventilation openings. Allow sufficient distances for adequate ventilation and install in accordance with the manufacturer's instructions.
8. DO NOT install near any heat sources such as open flames, radiators, heat registers, stoves, or other apparatus (including amplifiers) that produce heat. Do not place any open flame sources on the product.
9. DO NOT defeat the safety purpose of the polarized or grounding type plug. A polarized plug has two blades with one wider than the other. A grounding type plug has two blades and a third grounding prong. The wider blade or the third prong are provided for your safety. If the provided plug does not fit into your outlet, consult an electrician for replacement of the obsolete outlet.
10. PROTECT the power cord from being walked on or pinched, particularly at plugs, convenience receptacles, and the point where they exit from the apparatus.
11. ONLY USE attachments/accessories specified by the manufacturer.
12. USE only with a cart, stand, tripod, bracket, or table specified by the manufacturer, or sold with the apparatus. When a cart is used, use caution when moving the cart/apparatus combination to avoid injury from tip-over.
13. UNPLUG this apparatus during lightning storms or when unused for long periods of time.
14. REFER all servicing to qualified service personnel. Servicing is required when the apparatus has been damaged in any way, such as power supply cord or plug is damaged, liquid has been spilled or objects have fallen into the apparatus, the apparatus has been exposed to rain or moisture, does not operate normally, or has been dropped.
15. DO NOT expose the apparatus to dripping and splashing. DO NOT put objects filled with liquids, such as vases, on the apparatus.
16. The MAINS plug or an appliance coupler shall remain readily operable.
17. The airborne noise of the Apparatus does not exceed 70dB (A).
18. Apparatus with CLASS I construction shall be connected to a MAINS socket outlet with a protective earthing connection.
19. To reduce the risk of fire or electric shock, do not expose this apparatus to rain or moisture.
20. Do not attempt to modify this product. Doing so could result in personal injury and/or product failure.
21. Operate this product within its specified operating temperature range.

	This symbol indicates that dangerous voltage constituting a risk of electric shock is present within this unit.
	This symbol indicates that there are important operating and maintenance instructions in the literature accompanying this unit.

## WARNING

- Battery packs may explode or release toxic materials. Risk of fire or burns. Do not open, crush, modify, disassemble, heat above 140°F (60°C), or incinerate.
- Follow instructions from manufacturer
- Only use Shure charger to recharge Shure rechargeable batteries
- WARNING: Danger of explosion if battery incorrectly replaced. Replace only with same or equivalent type.
- Never put batteries in mouth. If swallowed, contact your physician or local poison control center
- Do not short circuit; may cause burns or catch fire
- Do not charge or use battery packs other than Shure rechargeable batteries
- Dispose of battery packs properly. Check with local vendor for proper disposal of used battery packs.
- Batteries (battery pack or batteries installed) shall not be exposed to excessive heat such as sunshine, fire or the like

## Important Product Information



### LICENSING INFORMATION

Licensing: A ministerial license to operate this equipment may be required in certain areas. Consult your national authority for possible requirements. Changes or modifications not expressly approved by Shure Incorporated could void your authority to operate the equipment. Licensing of Shure wireless microphone equipment is the user's responsibility, and licensability depends on the user's classification and application, and on the selected frequency. Shure strongly urges the user to contact the appropriate telecommunications authority concerning proper licensing, and before choosing and ordering frequencies.

#### 低功率電波輻射性電機管理辦法

##### 第十二條

經型式認證合格之低功率射頻電機，非經許可，公司、商號或使用者均不得擅自變更頻率、加大功率或變更原設計之特性及功能。第十四條

低功率射頻電機之使用不得影響飛航安全及干擾合法通信；經發現有干擾現象時，應立即停用，並改善至無干擾時方得繼續使用。前項合法通信，指依電信法規定作業之無線電通信。低功率射頻電機須忍受合法通信或工業、科學及醫療用電波輻射性電機設備之干擾。

### Australia Warning for Wireless

This device operates under an ACMA class licence and must comply with all the conditions of that licence including operating frequencies. Before 31 December 2014, this device will comply if it is operated in the 520-820 MHz frequency band. **WARNING:** After 31 December 2014, in order to comply, this device must not be operated in the 694-820 MHz band.

### Canada Warning for Wireless

This device operates on a no-protection, no-interference basis. Should the user seek to obtain protection from other radio services operating in the same TV bands, a radio licence is required. For further details, consult Innovation, Science and Economic Development Canada's document Client Procedures Circular CPC-2-1-28, Voluntary Licensing of Licence-Exempt Low-Power Radio Apparatus in the TV Bands.

Ce dispositif fonctionne selon un régime de non-brouillage et de non-protection. Si l'utilisateur devait chercher à obtenir une certaine protection contre d'autres services radio fonctionnant dans les mêmes bandes de télévision, une licence radio serait requise. Pour en savoir plus, veuillez consulter la Circulaire des procédures concernant les clients CPC-2-1-28, Délivrance de licences sur une base volontaire pour les appareils radio de faible puissance exempts de licence et exploités dans les bandes de télévision d'Innovation, Sciences et Développement économique Canada.

เครื่องโทรคมนาคมและอุปกรณ์นี้มีความสอดคล้องตามมาตรฐานหรือข้อกำหนดทางเทคนิคของ กสทช.

# System Components

## All systems include:

- ① Rack mounting hardware
- ② ¼-wave antennas (2)
- ③ Power supply
- ④ AA batteries (2)
- ⑤ SLXD4 or SLXD4D receiver

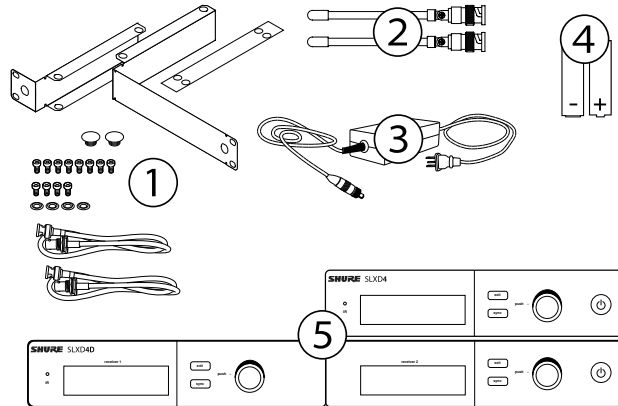

## Guitar system includes:

- ⑥ ¼" to mini 4-pin guitar cable
- ⑦ SLXD1 bodypack transmitter

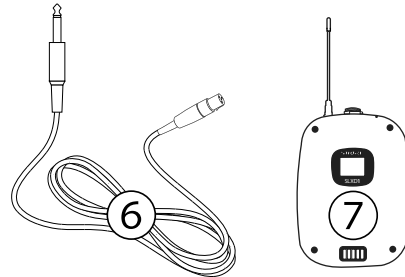

## Vocal system includes:

- ⑧ Microphone clip
- ⑨ SLXD2 handheld transmitter with microphone cartridge (choice of SM58®, SM86, Beta 58A®, Beta 87A™, or Beta 87C™)

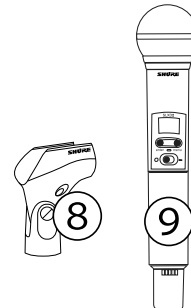

## Lavalier, Headworn, and Instrument systems include bodypack transmitter (⑦) and one of the following:

- ⑩ WL93 miniature lavalier microphone
- ⑪ WL183/WL185/ML4 lavalier microphone
- ⑫ SM35 headset microphone
- ⑬ Beta 98H/C™ instrument microphone
- ⑭ MX153 earset headworn microphone

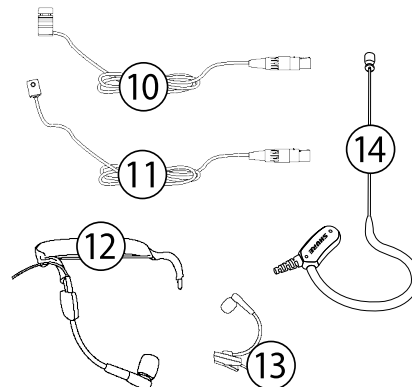

## Combo system includes:

- ⑨ Handheld transmitter with SM58 microphone head
- ⑪ WL185

# Set Up the Receiver

1. Attach the included antennas to the back of the receiver.

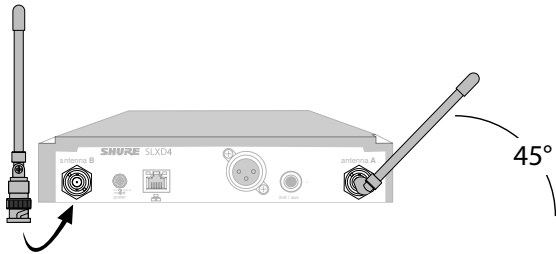

2. Connect the power supply to the receiver and plug the cord into an AC power source.

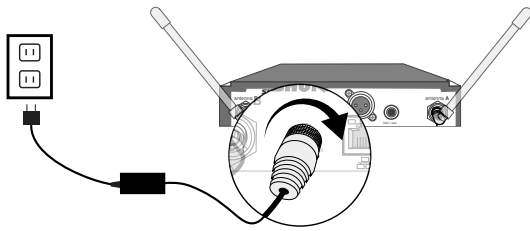

3. Connect the audio output to an amplifier or mixer.

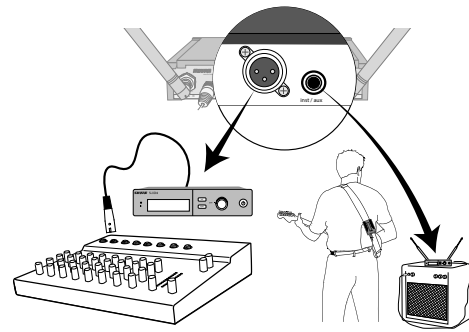

4. Press the power button on the receiver. Use the menu to set the system to microphone (mic) or instrument (line) level as appropriate.

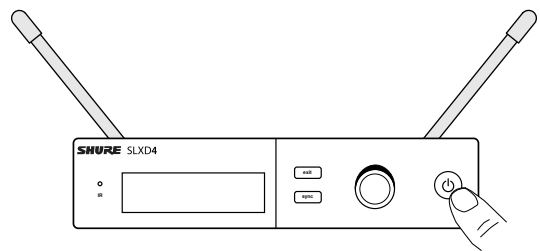

## Install Transmitter Batteries

### Bodypack:

1. Push the tab up and open the battery door to access the battery compartment
2. Place a Shure SB903 Li-ion rechargeable battery or 2 AA batteries in the compartment
3. Close the battery door

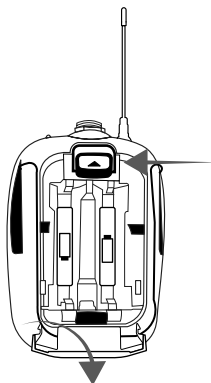

### Handheld:

1. Turn the battery cover clockwise to access the battery compartment
2. Lift the battery door to open the battery compartment
3. Place a Shure SB903 Li-ion rechargeable battery or 2 AA batteries in the compartment
4. Replace the battery cover and turn it counterclockwise to secure it

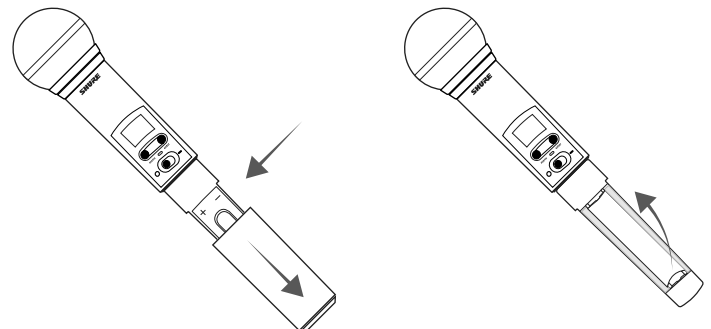

# What are Groups and Channels?

To minimize interference, Shure wireless systems organize the RF band into predefined **groups** and **channels**. A group is a set of compatible frequencies within a frequency band. A single frequency within a group is a channel. Tune a receiver and transmitter to the best available channel within its group to set up your system.

To ensure compatibility, all receivers in the same band should be set to the same group. You can configure this manually, or use the **Guided Frequency Setup** to walk you through the process of finding an optimal configuration.

For best results, use a network switch when connecting 3 or more receivers.

**Important!** To avoid interference, before you begin:

**Turn off** all transmitters for the systems you are setting up. This prevents them from interfering with the frequency scan.

**Turn on** the following devices so they are operating as they would be during the presentation or performance. This will allow the scan to detect and avoid any interference from these devices:

- Configured wireless systems or devices
- Computers
- Large LED panels
- Effects processors
- CD players

## Using the Guided Frequency Setup

Set up a new system:

1. Push the control knob and select **1. Frequency Setup** > **1.1 Guided Frequency Setup**.
2. Select **Initialize My System** and push the control knob to continue.
3. Turn off all transmitters you plan to use with your system.
4. Select **start scan**.
5. After the scan is done, push the control knob to assign frequencies to the receiver.
6. Turn on the transmitter you plan to use with this receiver.

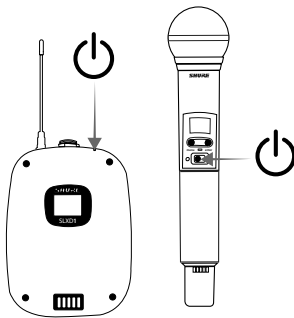

7. Align the infrared (IR) ports on the transmitter and receiver, and push the **sync** button.

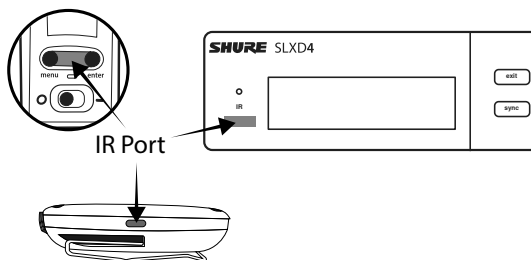

8. Once the sync is complete, the system is ready for use.

Add a new receiver to your system:

1. Push the control knob and select **Frequency Setup** > **Guided Frequency Setup**.
2. Select **Add Receiver to My System**.
3. To change the group, rotate the control knob to select **G:**, push to select, rotate to change the number, push again to confirm.
4. Select **start scan**.
5. After the scan completes, push the control knob to apply the receiver channel.
6. Turn on the transmitter you plan to use with this receiver.
7. Align the infrared (IR) port on the transmitter with that on the receiver, and push the **sync** button.
8. Once the sync is complete, the system is ready for use.

## Manual Frequency Selection

To manually adjust group, channel or frequency:

1. Select **1. Frequency Setup** > **1.4 Manual Frequency Setup** from the receiver menu.
2. Use the control knob to select and adjust the group (G), channel (C), or frequency (MHz).
3. Select **apply** and push the control knob to save.

## Sound Check and Gain Adjustment

Navigate to the receiver's **Gain** screen to test the transmitter at performance levels. Adjust the gain to keep the audio indicator within the horizontal bracket above the bar. Reduce the gain if there is audible distortion of the audio.

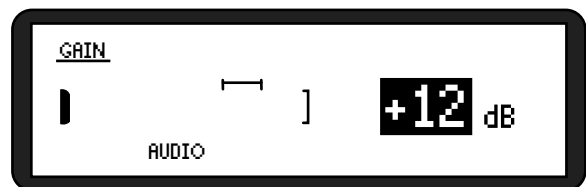

# Frequencies for European Countries

## G51 470-534 MHz

Country Code Code de Pays Codice di paese Código de país Länder-Kürzel	Frequency Range Gamme de frequences Gamme di frequenza Gama de frecuencias Frequenzbereich
A, B, BG, CH, CY, CZ, D, DK, EST, F	*
FIN, GB, GR, H, HR, I, IRL, IS, L, LT	*
M, N, NL, P, PL, RO, S, SK, SLO, TR	*
All other countries	*

\* This equipment may be capable of operating on some frequencies not authorized in your region. See Licensing Information.

## H51 534-598 MHz

Country Code Code de Pays Codice di paese Código de país Länder-Kürzel	Frequency Range Gamme de frequences Gamme di frequenza Gama de frecuencias Frequenzbereich
A, B, BG, CH, CY, CZ, D, EST	534 - 598 MHz*
F, GB, GR, H, I, IS, L, LT	534 - 598 MHz*
NL, P, PL, S, SK, SLO	534 - 598 MHz*
DK, FIN, M, N	*
HR, E, IRL, LV, RO, TR	*
All other countries	*

\* This equipment may be capable of operating on some frequencies not authorized in your region. See Licensing Information.

## K51 606-670 MHz

Country Code Code de Pays Codice di paese Código de país Länder-Kürzel	Frequency Range Gamme de frequences Gamme di frequenza Gama de frecuencias Frequenzbereich
A, B, BG, CH, CY, CZ, D, EST	606 - 670 MHz*
F, GB, GR, H, I, IS, L, LT	606 - 670 MHz*
NL, P, PL, S, SK, SLO	606 - 670 MHz*
RO	646 - 647; 654 - 655; 662 - 663 MHz*
DK, E, FIN, HR, IRL, LV, M, N, TR	*
All other countries	*

\* This equipment may be capable of operating on some frequencies not authorized in your region. See Licensing Information.

## L52 632-694 MHz

Country Code Code de Pays Codice di paese Código de país Länder-Kürzel	Frequency Range Gamme de frequences Gamme di frequenza Gama de frecuencias Frequenzbereich
A, B, BG, CH, CY, CZ, D, DK, EST, F	*
FIN, GB, GR, H, HR, I, IRL, IS, L, LT	*
M, N, NL, P, PL, RO, S, SK, SLO, TR	*
All other countries	*

\* This equipment may be capable of operating on some frequencies not authorized in your region. See Licensing Information.

**P51 710-782 MHz**

Country Code Code de Pays Codice di paese Código de país Länder-Kürzel	Frequency Range Gamme de frequences Gamme di frequenza Gama de frecuencias Frequenzbereich
A, B, BG, CH, CY, CZ, D, EST, F, GB	710 - 782 MHz*
GR, H, I, IS, L, LT, NL, P, PL, S, SK, SLO	710 - 782 MHz*
RO	718 - 719; 726 - 727; 734 - 743; 750 - 751; 758 - 759 MHz*
DK, E, FIN, HR, IRL, LV, M, N, TR	*
All other countries	*

\* This equipment may be capable of operating on some frequencies not authorized in your region. See Licensing Information.

**Q51 794-806 MHz**

Country Code Code de Pays Codice di paese Código de país Länder-Kürzel	Frequency Range Gamme de frequences Gamme di frequenza Gama de frecuencias Frequenzbereich
A, B, BG, CH, CY, CZ, D, DK, E, EST	*
F, FIN, GB, GR, H, HR, I, IRL, IS, L, LT	*
LV, M, N, NL, P, PL, S, SK, SLO, TR	*
All other countries	*

\* This equipment may be capable of operating on some frequencies not authorized in your region. See Licensing Information.

**R51 800-810 MHz**

Country Code Code de Pays Codice di paese Código de país Länder-Kürzel	Frequency Range Gamme de frequences Gamme di frequenza Gama de frecuencias Frequenzbereich
N	800 - 810 MHz*
A, B, BG, CH, CY, CZ, D, DK, E, EST	*
F, FIN, GB, GR, H, HR, I, IRL, IS, L, LT	*
LV, M, N, NL, P, PL, S, SK, SLO, TR	*
All other countries	*

\* This equipment may be capable of operating on some frequencies not authorized in your region. See Licensing Information.

**S50 823-832 MHz, 863-865 MHz**

Country Code Code de Pays Codice di paese Código de país Länder-Kürzel	Frequency Range Gamme de frequences Gamme di frequenza Gama de frecuencias Frequenzbereich
D	license free
A, B, BG, CH, CY, CZ, D, DK, EST, F	*
FIN, GB, GR, H, HR, I, IRL, IS, L, LT	*
M, N, NL, P, PL, RO, S, SK, SLO, TR	*
863 - 865 MHz	EU: license free
All other countries	*

\* This equipment may be capable of operating on some frequencies not authorized in your region. See Licensing Information.

**V51 174-216 MHz**

Country Code Code de Pays Codice di paese Código de país Länder-Kürzel	Frequency Range Gamme de frequences Gamme di frequenza Gama de frecuencias Frequenzbereich
A, B, BG, CH, CY, CZ, D, DK, E, EST	*
F, FIN, GB, GR, H, HR, I, IRL, IS, L, LT	*

SLXD1		
Dipole Antenna	Antenna Gain	Frequency
Bands G58 G59 G60 G61	2.8	510MHz
Bands G62 H55 H56 H57 J52 J53 J54	2.7	530MHz
Bands K59 L55 L56 L57 L58 L59	2.6	630MHz
Bands M55 P53 Q51 JB	2.1	750MHz
Bands S50 X51	2.7	930MHz
SLXD2		
Dipole Antenna	Antenna Gain	Frequency
Bands G58 G59 G60 G61	2.2	510MHz
Bands G62 H55 H56 H57	1.2	530MHz
Bands J52 J53 J54	0.1	570MHz
Bands K59 L55 L56 L57 L58 L59	-0.8	690MHz
Bands M55 P53 Q51 JB	0.4	710MHz
Bands S50 X51	-0.9	930MHz

Country Code Code de Pays Codice di paese Código de país Länder-Kürzel	Frequency Range Gamme de frequences Gamme di frequenza Gama de frequencias Frequenzbereich
LV, M, N, NL, P, PL, S, SK, SLO, TR	*
All other countries	*

\* This equipment may be capable of operating on some frequencies not authorized in your region. See Licensing Information.

#### Z17 1492-1525 MHz

Country Code Code de Pays Codice di paese Código de país Länder-Kürzel	Frequency Range Gamme de frequences Gamme di frequenza Gama de frequencias Frequenzbereich
A, B, BG, CH, CY, CZ, D, DK, E, EST	*
F, FIN, GB, GR, H, HR, I, IRL, IS, L, LT	*
LV, M, N, NL, P, PL, S, SK, SLO, TR	*
This Wireless microphone operates on the range of 1492-1525 MHz. Should be used INDOORS ONLY.	All other countries
*	

\* This equipment may be capable of operating on some frequencies not authorized in your region. See Licensing Information.

#### Z18 1785-1805 MHz

Country Code Code de Pays Codice di paese Código de país Länder-Kürzel	Frequency Range Gamme de frequences Gamme di frequenza Gama de frequencias Frequenzbereich
A, B, BG, CH, CY, CZ, D, DK, E, EST	*
F, FIN, GB, GR, H, HR, I, IRL, IS, L, LT	*
LV, M, N, NL, P, PL, S, SK, SLO, TR	*
All other countries	*

\* This equipment may be capable of operating on some frequencies not authorized in your region. See Licensing Information.

## Certifications

Certified under FCC Part 15 and FCC Part 74.

Certified by ISED in Canada under RSS-102 and RSS-210.

CAN ICES-3 (B)/NMB-3 (B)

Approved under the Declaration of Conformity (DoC) provision of FCC Part 15.

These transmitters have been tested and found to comply with international radiation exposure limits set forth for an uncontrolled environment. This equipment is in direct contact with the body of the user under normal operating conditions. These transmitters must not be co-located or operating in conjunction with any other antenna or transmitter.

**FCC ID:** DD4SLXD1G58, DD4SLXD1H55, DD4SLXD1J52, DD4SLXD2G58, DD4SLXD2H55, DD4SLXD2J52. **IC:** 616A-SLXD1G58, 616A-SLXD1H55, 616A-SLXD1J52, 616A-SLXD2G58, 616A-SLXD1H55, 616A-SLXD1J52.

Meets essential requirements of the following European Directives:

- WEEE Directive 2012/19/EU, as amended by 2008/34/EC
- RoHS Directive EU 2015/863

**Note:** Please follow your regional recycling scheme for batteries and electronic waste

This product meets the Essential Requirements of all relevant European directives and is eligible for CE marking.

Hereby, Shure Incorporated declares that the radio equipment is in compliance with Directive 2014/53/EU. The full text of the EU declaration of conformity is available at the following internet address: <http://www.shure.com/europe/compliance>

Authorized European representative:  
Shure Europe GmbH  
Headquarters Europe, Middle East & Africa  
Department: EMEA Approval  
Jakob-Dieffenbacher-Str. 12  
75031 Eppingen, Germany  
Phone: +49-7262-92 49 0  
Fax: +49-7262-92 49 11 4  
Email: [EMEAsupport@shure.de](mailto:EMEAsupport@shure.de)

## Information to the user

This device complies with part 15 of the FCC Rules. Operation is subject to the following two conditions:

1. This device may not cause harmful interference.
2. This device must accept any interference received, including interference that may cause undesired operation.

**Note:** This equipment has been tested and found to comply with the limits for a Class B digital device, pursuant to part 15 of the FCC Rules. These limits are designed to provide reasonable protection against harmful interference in a residential installation. This equipment generates uses and can radiate radio frequency energy and, if not installed and used in accordance with the instructions, may cause harmful interference to radio communications. However, there is no guarantee that interference will not occur in a particular installation. If this equipment does cause harmful interference to radio or television reception, which can be determined by turning the equipment off and on, the user is encouraged to try to correct the interference by one or more of the following measures:

- Reorient or relocate the receiving antenna.
- Increase the separation between the equipment and the receiver.
- Connect the equipment to an outlet on a circuit different from that to which the receiver is connected.
- Consult the dealer or an experienced radio/TV technician for help.

This device operates on frequencies shared with other devices. Consult the Federal Communications Commission White Space Database Administration website to determine available channels in your area prior to operation.

This device contains licence-exempt transmitter(s)/receiver(s) that comply with Innovation, Science and Economic Development Canada's licence-exempt RSS(s). Operation is subject to the following two conditions:

1. This device may not cause interference.
2. This device must accept any interference, including interference that may cause undesired operation of the device.

L'émetteur/récepteur exempt de licence contenu dans le présent appareil est conforme aux CNR d'Innovation, Sciences et Développement économique Canada applicables aux appareils radio exempts de licence. L'exploitation est autorisée aux deux conditions suivantes :

1. L'appareil ne doit pas produire de brouillage;
2. L'appareil doit accepter tout brouillage radioélectrique subi, même si le brouillage est susceptible d'en compromettre le fonctionnement.



The SHURE logo is presented in a bold, white, sans-serif font, centered within a black, rounded rectangular background.

**United States, Canada, Latin  
America, Caribbean:**

Shure Incorporated  
5800 West Touhy Avenue  
Niles, IL 60714-4608 USA

Phone: 847-600-2000  
Fax: 847-600-1212 (USA)  
Fax: 847-600-6446  
Email: [info@shure.com](mailto:info@shure.com)

**Europe, Middle East, Africa:**

Shure Europe GmbH  
Jakob-Dieffenbacher-Str. 12,  
75031 Eppingen, Germany

Phone: + 49-7262-92490  
Fax: + 49-7262-9249114  
Email: [info@shure.de](mailto:info@shure.de)

**UK Importer**

Shure UK Limited  
Unit 2, The IO Centre, Lea Road,  
Waltham Abbey, Essex, EN9 1 AS,  
UK

**Asia, Pacific:**

Shure Asia Limited  
22/F, 625 King's Road  
North Point, Island East  
Hong Kong

Phone: 852-2893-4290  
Fax: 852-2893-4055  
Email: [info@shure.com.hk](mailto:info@shure.com.hk)

**PT. GOSHEN SWARA INDONESIA**

Kompleks Harco Mangga Dua Blok L No. 35 Jakarta Pusat

I.16.GSI31.00501.0211