



# MEASUREMENT REPORT

## FCC PART 74 Subpart H

---

**FCC ID:** DD4SLXD1J52  
**APPLICANT:** Shure Incorporated  
**Application Type:** Certification  
**Product:** Digital Wireless Microphone Transmitter  
**Model No.:** SLXD1 J52  
**Brand Name:**   
**FCC Classification:** Licensed LPAS Device (TLD)  
**FCC Rule Part(s):** Part 74 Subpart H (Section 74.861)  
**Test Procedure(s):** ANSI C63.26-2015, KDB 206256 D01v02  
ETSI EN 300 422-1 V1.4.2 (2011-08)  
**Test Date:** October 21 ~ November 25, 2019

Reviewed By:

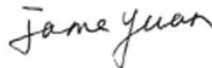

( Jame Yuan )

Approved By:

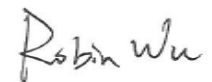

( Robin Wu )



The test results relate only to the samples tested.

The test results shown in the test report are traceable to the national/international standards through the calibration of the equipment and evaluated measurement uncertainty herein.

The test report shall not be reproduced except in full without the written approval of MRT Technology (Suzhou) Co., Ltd.

---

## Revision History

| Report No.    | Version | Description    | Issue Date | Note  |
|---------------|---------|----------------|------------|-------|
| 1910RSU041-U8 | Rev. 01 | Initial Report | 11-25-2019 | Valid |
|               |         |                |            |       |

---

## CONTENTS

| Description   | Page      |
|---|-----------|
| <b>§2.1033 General Information .....</b>                  | <b>5</b>  |
| <b>1. INTRODUCTION .....</b>                              | <b>6</b>  |
| 1.1. Scope .....  | 6         |
| 1.2. MRT Test Location .....                              | 6         |
| <b>2. PRODUCT INFORMATION .....</b>                       | <b>7</b>  |
| 2.1. Equipment Description.....                           | 7         |
| 2.2. Product Specification Subjective to this Report..... | 7         |
| 2.3. Working Frequencies for this report .....            | 7         |
| 2.4. Test Software .....                                  | 7         |
| 2.5. EMI Suppression Device(s) / Modifications .....      | 7         |
| <b>3. DESCRIPTION OF TEST .....</b>                       | <b>8</b>  |
| 3.1. Evaluation Procedure .....                           | 8         |
| 3.2. Radiated Measurement.....                            | 8         |
| <b>4. TEST EQUIPMENT CALIBRATION DATE .....</b>           | <b>10</b> |
| <b>5. MEASUREMENT UNCERTAINTY .....</b>                   | <b>12</b> |
| <b>6. TEST RESULT .....</b>                               | <b>13</b> |
| 6.1. Summary .....  | 13        |
| 6.2. RF Output Power Measurement .....                    | 14        |
| 6.2.1. Test Limit .....                                   | 14        |
| 6.2.2. Test Procedure Used .....                          | 14        |
| 6.2.3. Test Setting.....                                  | 14        |
| 6.2.4. Test Setup.....                                    | 14        |
| 6.2.5. Test Result.....                                   | 15        |
| 6.1. Frequency Tolerance Measurement .....                | 16        |
| 6.1.1. Test Limit .....                                   | 16        |
| 6.1.2. Test Procedure .....                               | 16        |
| 6.1.3. Test Setting.....                                  | 16        |
| 6.1.4. Test Setup.....                                    | 17        |
| 6.1.5. Test Result.....                                   | 18        |
| 6.2. 99% Occupied Bandwidth Measurement .....             | 20        |
| 6.2.1. Test Limit .....                                   | 20        |
| 6.2.2. Test Procedure used.....                           | 20        |
| 6.2.3. Test Setting.....                                  | 20        |

---

|   |           |
|---|-----------|
| 6.2.4. Test Setup.....                            | 20        |
| 6.2.5. Test Result.....                           | 21        |
| 6.3. Out-of-band Emission Mask Measurement.....   | 22        |
| 6.3.1. Test Limit.....                            | 22        |
| 6.3.2. Test Procedure Used.....                   | 22        |
| 6.3.3. Test Setting.....                          | 22        |
| 6.3.4. Test Setup.....                            | 23        |
| 6.3.5. Test Result.....                           | 24        |
| 6.4. Necessary Bandwidth Measurement.....         | 27        |
| 6.4.1. Test Limit.....                            | 27        |
| 6.4.2. Test Procedure Used.....                   | 27        |
| 6.4.3. Test Setting.....                          | 27        |
| 6.4.4. Test Setup.....                            | 28        |
| 6.4.5. Test Result.....                           | 29        |
| 6.5. Radiated Spurious Emissions Measurement..... | 35        |
| 6.5.1. Test Limit.....                            | 35        |
| 6.5.2. Test Procedure Used.....                   | 35        |
| 6.5.3. Test Setting.....                          | 35        |
| 6.5.4. Test Setup.....                            | 36        |
| 6.5.5. Test Result.....                           | 37        |
| <b>7. CONCLUSION.....</b>                         | <b>39</b> |
| <b>Appendix A – Test Setup Photograph.....</b>    | <b>40</b> |
| <b>Appendix B – EUT Photograph.....</b>           | <b>41</b> |

## §2.1033 General Information

|                                |   |
|--------------------------------|---|
| <b>Applicant:</b>              | Shure Incorporated  |
| <b>Applicant Address:</b>      | 5800 West Touhy Avenue, Niles, IL 60714-4608, USA   |
| <b>Manufacturer:</b>           | Shure Incorporated  |
| <b>Manufacturer Address:</b>   | 5800 West Touhy Avenue, Niles, IL 60714-4608, USA   |
| <b>Test Site:</b>              | MRT Technology (Suzhou) Co., Ltd  |
| <b>Test Site Address:</b>      | D8 Building, No.2 Tian'edang Rd., Wuzhong Economic Development Zone, Suzhou, China  |
| <b>Test Device Serial No.:</b> | N/A <input type="checkbox"/> Production <input checked="" type="checkbox"/> Pre-Production <input type="checkbox"/> Engineering |

### Test Facility / Accreditations

Measurements were performed at MRT Laboratory located in Tian'edang Rd., Suzhou, China.

- MRT facility is a FCC accredited (MRT Designation No. CN1166) test facility with the site description report on file and has met all the requirements specified in ANSI C63.4-2014.
- MRT facility is an IC registered (MRT Reg. No. 11384A-1) test laboratory with the site description on file at Industry Canada.
- MRT facility is a VCCI registered (R-20025, G-20034, C-20020, T-20020) test laboratory with the site description on file at VCCI Council.
- MRT Lab is accredited to ISO 17025 by the American Association for Laboratory Accreditation (A2LA) under the American Association for Laboratory Accreditation Program (A2LA Cert. No. 3628.01) in EMC, Telecommunications, Radio and SAR testing.



## 1. INTRODUCTION

### 1.1. Scope

Measurement and determination of electromagnetic emissions (EMC) of radio frequency devices including intentional and/or unintentional radiators for compliance with the technical rules and regulations of the Federal Communications Commission and the Innovation, Science and Economic Development Canada and Certification and Engineering Bureau.

### 1.2. MRT Test Location

The map below shows the location of the MRT LABORATORY, its proximity to the Taihu Lake. These measurement tests were conducted at the MRT Technology (Suzhou) Co., Ltd. Facility located at D8 Building, No.2 Tian'edang Rd., Wuzhong Economic Development Zone, Suzhou, China. The measurement facility compliant with the test site requirements specified in ANSI C63.4-2014.



## 2. PRODUCT INFORMATION

### 2.1. Equipment Description

|                                |   |
|--------------------------------|---|
| Product Name                   | Digital Wireless Microphone Transmitter                       |
| Model No.                      | SLXD1 J52   |
| Power Type                     | Two AA batteries (3.0Vdc) or Rechargeable Li-ion Battery Pack |
| Working Voltage                | 1.9 ~ 4.2 Vdc   |
| Operating Temperature          | -18 ~ 50°C  |
| <b>Accessories</b>             |   |
| Rechargeable<br>Li-ion Battery | Model: SB903<br>Output: 3.6Vdc, 1200mAh, 4.32Wh               |

### 2.2. Product Specification Subjective to this Report

|                      |                |
|----------------------|----------------|
| Frequency Range      | 558 ~ 602MHz   |
| Declared Power Level | 1mW & 10mW     |
| Type of Modulation   | 4FSK           |
| Channel Spacing      | 25kHz          |
| Antenna Type         | Dipole Antenna |
| Antenna Gain         | 2.7dBi         |

Note 1: For other features of this EUT, test report will be issued separately.

Note 2: Power level and operating frequency can be selected via EUT screen.

### 2.3. Working Frequencies for this report

| Channel | Frequency   |
|---------|-------------|
| Low     | 558.000 MHz |
| ...     | ...         |
| Mid     | 580.000 MHz |
| ...     | ...         |
| High    | 602.000 MHz |

### 2.4. Test Software

The test utility software used during testing was "IPOP", and the version was V4.1, all test commands were provided by the manufacturer.

### 2.5. EMI Suppression Device(s) / Modifications

No EMI suppression device(s) were added and no modifications were made during testing.

### 3. DESCRIPTION OF TEST

#### 3.1. Evaluation Procedure

The measurement procedures described in the American National Standard for Compliance Testing of Transmitters Used in Licensed Radio Services (ANSI C63.26-2015).

**Deviation from measurement procedure.....None**

#### 3.2. Radiated Measurement

The radiated test facilities consisted of an indoor 3 meter semi-anechoic chamber used for final measurements and exploratory measurements, when necessary. The measurement area is contained within the semi-anechoic chamber which is shielded from any ambient interference. For measurements above 1GHz absorbers are arranged on the floor between the turn table and the antenna mast in such a way so as to maximize the reduction of reflections. For measurements below 1GHz, the absorbers are removed. A turntable is used for radiated measurement. It is a continuously rotatable, remote controlled, metallic turntable and 2 meters (6.56 ft.) in diameter. The turn table is flush with the raised floor of the chamber in order to maintain its function as a ground plane. An 80cm high PVC support structure is placed on top of the turntable.

For all measurements, the spectrum was scanned through all EUT azimuths and from 1 to 4 meter receive antenna height using a broadband antenna from 30MHz up to the upper frequency shown in 15.33(b)(1) depending on the highest frequency generated or used in the device or on which the device operates or tunes. For frequencies above 1GHz, linearly polarized double ridge horn antennas were used. For frequencies below 30MHz, a calibrated loop antenna was used. When exploratory measurements were necessary, they were performed at 1 meter test distance inside the semi-anechoic chamber using broadband antennas, broadband amplifiers, and spectrum analyzers to determine the frequencies and modes producing the maximum emissions. Sufficient time for the EUT, support equipment, and test equipment was allowed in order for them to warm up to their normal operating condition. The test set-up for frequencies below 1GHz was placed on top of the 0.8 meter high, 1 x 1.5 meter table; and test set-up for frequencies 1-40GHz was placed on top of the 1.5 meter high, 1 x 1.5 meter table. The EUT, support equipment, and interconnecting cables were arranged and manipulated to maximize each emission. Appropriate precaution was taken to ensure that all emissions from the EUT were maximized and investigated. The system configuration, clock speed, mode of operation or video resolution, if applicable, turntable azimuth, and receive antenna height was noted for each frequency found.

Final measurements were made in the semi-anechoic chamber using calibrated, linearly polarized broadband and horn antennas. The test setup was configured to the setup that produced the worst case emissions. The spectrum analyzer was set to investigate all frequencies required for testing to compare the highest radiated disturbances with respect to the specified limits. The turntable containing the EUT was rotated through 360 degrees and the height of the receive antenna was



varied 1 to 4 meters and stopped at the azimuth and height producing the maximum emission. Each emission was maximized by changing the orientation of the EUT through three orthogonal planes and changing the polarity of the receive antenna, which produced the worst-case emissions.

According to 3dB Beam-Width of horn antenna, the horn antenna should be always directed to the EUT when rising height.

#### 4. TEST EQUIPMENT CALIBRATION DATE

##### Conducted Emissions - SR2

| Instrument         | Manufacturer | Type No.    | Asset No.   | Cali. Interval | Cali. Due Date |
|--------------------|--------------|-------------|-------------|----------------|----------------|
| EMI Test Receiver  | R&S          | ESR3        | MRTSUE06185 | 1 year         | 2020/04/15     |
| Two-Line V-Network | R&S          | ENV 216     | MRTSUE06002 | 1 year         | 2020/06/13     |
| Two-Line V-Network | R&S          | ENV 216     | MRTSUE06003 | 1 year         | 2020/06/13     |
| Thermohygrometer   | Testo        | 608-H1      | MRTSUE06404 | 1 year         | 2020/08/08     |
| Shielding Room     | MIX-BEP      | Chamber-SR2 | MRTSUE06215 | N/A            | N/A            |

##### Radiated Emissions - AC1

| Instrument                 | Manufacturer | Type No.    | Asset No.   | Cali. Interval | Cali. Due Date |
|----------------------------|--------------|-------------|-------------|----------------|----------------|
| EMI Test Receiver          | R&S          | ESR7        | MRTSUE06001 | 1 year         | 2020/08/01     |
| PXA Signal Analyzer        | Keysight     | 9030B       | MRTSUE06395 | 1 year         | 2020/09/03     |
| Loop Antenna               | Schwarzbeck  | FMZB 1519   | MRTSUE06025 | 1 year         | 2020/11/10     |
| Bilog Period Antenna       | Schwarzbeck  | VULB 9168   | MRTSUE06172 | 1 year         | 2020/03/31     |
| Broad Band Horn Antenna    | Schwarzbeck  | BBHA 9120D  | MRTSUE06023 | 1 year         | 2020/10/13     |
| Broad Band Horn Antenna    | Schwarzbeck  | BBHA 9170   | MRTSUE06024 | 1 year         | 2019/12/17     |
| Microwave System Amplifier | Agilent      | 83017A      | MRTSUE06076 | 1 year         | 2020/11/15     |
| Preamplifier               | Schwarzbeck  | BBV 9721    | MRTSUE06121 | 1 year         | 2020/06/11     |
| Thermohygrometer           | Testo        | 608-H1      | MRTSUE06403 | 1 year         | 2020/08/08     |
| Anechoic Chamber           | TDK          | Chamber-AC1 | MRTSUE06212 | 1 year         | 2020/04/30     |

##### Radiated Emission - AC2

| Instrument                        | Manufacturer | Type No.    | Asset No.   | Cali. Interval | Cali. Due Date |
|-----------------------------------|--------------|-------------|-------------|----------------|----------------|
| Spectrum Analyzer                 | Keysight     | N9038A      | MRTSUE06125 | 1 year         | 2020/08/01     |
| Loop Antenna                      | Schwarzbeck  | FMZB 1519   | MRTSUE06025 | 1 year         | 2020/11/10     |
| Bilog Period Antenna              | Schwarzbeck  | VULB 9162   | MRTSUE06022 | 1 year         | 2020/10/13     |
| Horn Antenna                      | Schwarzbeck  | BBHA9120D   | MRTSUE06171 | 1 year         | 2020/10/27     |
| Broad Band Horn Antenna           | Schwarzbeck  | BBHA 9170   | MRTSUE06024 | 1 year         | 2019/12/17     |
| Broadband Coaxial<br>Preamplifier | Schwarzbeck  | BBV 9718    | MRTSUE06176 | 1 year         | 2020/11/15     |
| Preamplifier                      | Schwarzbeck  | BBV 9721    | MRTSUE06121 | 1 year         | 2020/06/11     |
| Temperature/Humidity Meter        | Minggao      | ETH529      | MRTSUE06170 | 1 year         | 2019/12/13     |
| Anechoic Chamber                  | RIKEN        | Chamber-AC2 | MRTSUE06213 | 1 year         | 2020/04/30     |

## Conducted Test Equipment - TR3

| Instrument                             | Manufacturer | Type No.    | Asset No.   | Cali. Interval | Cali. Due Date |
|--|--------------|-------------|-------------|----------------|----------------|
| EXA Signal Analyzer                    | Agilent      | N9020A      | MRTSUE06106 | 1 year         | 2020/04/15     |
| EXA Signal Analyzer                    | Keysight     | N9010B      | MRTSUE06452 | 1 year         | 2020/07/11     |
| Signal Analyzer                        | R&S          | FSV40       | MRTSUE06218 | 1 year         | 2020/04/15     |
| Power Meter                            | Agilent      | U2021XA     | MRTSUE06030 | 1 year         | 2020/11/18     |
| USB wideband power sensor              | Keysight     | U2021XA     | MRTSUE06446 | 1 year         | 2020/06/30     |
| USB wideband power sensor              | Keysight     | U2021XA     | MRTSUE06447 | 1 year         | 2020/06/30     |
| Bluetooth Test Set                     | Anritsu      | MT8852B-042 | MRTSUE06389 | 1 year         | 2020/06/13     |
| Audio Analyzer                         | Agilent      | U8903B      | MRTSUE06143 | 1 year         | 2020/06/13     |
| Modulation Analyzer                    | HP           | 8901A       | MRTSUE06098 | 1 year         | 2020/10/10     |
| Wideband Radio<br>Communication Tester | R&S          | CMW 500     | MRTSUE06243 | 1 year         | 2020/11/07     |
| DC Power Supply                        | GWINSTEK     | DPS-3303C   | MRTSUE06064 | N/A            | N/A            |
| Temperature & Humidity<br>Chamber      | BAOYT        | BYH-150CL   | MRTSUE06051 | 1 year         | 2020/11/07     |
| Thermohygrometer                       | testo        | 608-H1      | MRTSUE06401 | 1 year         | 2020/08/08     |

| Software     | Version | Function          |
|--------------|---------|-------------------|
| EMI Software | V3      | EMI Test Software |

## 5. MEASUREMENT UNCERTAINTY

Where relevant, the following test uncertainty levels have been estimated for tests performed on the EUT as specified in CISPR 16-4-2. This uncertainty represents an expanded uncertainty expressed at approximately the 95% confidence level using a coverage factor of  $k = 2$ .

| Conducted Emission Measurement - SR2   |
|--|
| The maximum measurement uncertainty is evaluated as:<br>9kHz~150kHz: 3.84dB<br>150kHz~30MHz: 3.46dB  |
| Radiated Emission Measurement - AC1  |
| The maximum measurement uncertainty is evaluated as:<br>Horizontal: 30MHz~300MHz: 4.07dB<br>300MHz~1GHz: 3.63dB<br>1GHz~18GHz: 4.16dB<br>Vertical: 30MHz~300MHz: 4.18dB<br>300MHz~1GHz: 3.60dB<br>1GHz~18GHz: 4.76dB |
| Radiated Emission Measurement - AC2  |
| The maximum measurement uncertainty is evaluated as:<br>Horizontal: 30MHz~300MHz: 3.75dB<br>300MHz~1GHz: 3.53dB<br>1GHz~18GHz: 4.28dB<br>Vertical: 30MHz~300MHz: 3.86dB<br>300MHz~1GHz: 3.53dB<br>1GHz~18GHz: 4.33dB |

## 6. TEST RESULT

### 6.1. Summary

| FCC Part Section(s) | Test Description           | Test Limit  | Test Condition | Test Result | Reference   |
|---------------------|----------------------------|---|----------------|-------------|-------------|
| 74.861(e)(1)(ii)    | RF Output Power            | $\leq 250\text{mW}$ Conducted   | Conducted      | Pass        | Section 6.2 |
| 74.861(e)(4)        | Frequency Stability        | $\pm 0.005\%$   |                | Pass        | Section 6.3 |
| 74.861(e)(5)        | Occupied Bandwidth         | $< 200\text{kHz}$   |                | Pass        | Section 6.4 |
| 74.861(e)(6)        | Emission Mask              | The mean power of emissions shall be attenuated below the mean output power of the transmitter as below:<br>$(50\% \sim 100\%)*\text{OBW} \geq 25\text{dB}$<br>$(100\% \sim 250\%)*\text{OBW} \geq 35\text{dB}$<br>More than $250\%*\text{OBW} \geq 43 + 10*\log(P)\text{dB}$ |                | Pass        | Section 6.5 |
| 74.861(e)(7)        | Necessary Bandwidth        | Refer to clause 6.6.1   |                | N/A         | Section 6.6 |
| 74.861(e)(7)        | Radiated Spurious Emission | Refer to clause 6.7.1   | Radiated       | Pass        | Section 6.7 |

#### Notes:

- 1) The analyzer plots shown in this section were all taken with a correction table loaded into the analyzer. The correction table was used to account for the losses of the cables and attenuators used as part of the system to connect the EUT to the analyzer at all frequencies of interest.
- 2) All modes of operation and data rates were investigated. For radiated emission test, every axis (X, Y, Z) was also verified. The test results shown in the following sections represent the worst emissions.
- 3) Besides RF Output Power & Necessary Bandwidth & Radiated Spurious Emission & Emission Mask perform two power levels, any others test item only perform max power level.
- 4) We selected DC voltage 3.6V as normal test voltage.

## 6.2. RF Output Power Measurement

### 6.2.1. Test Limit

The conducted power may not exceed 250mW in 470 ~ 608 and 614 ~ 698 MHz band.

### 6.2.2. Test Procedure Used

ANSI C63.26-2015 - Section 5.2.4.2

### 6.2.3. Test Setting

The output of the EUT was connected to an RF average power meter through fixed attenuation.

The EUT was set to transmit on the low, middle, and high frequencies in each power level.

Measure the average power of the transmitter. This EUT's duty cycle is 100%.

### 6.2.4. Test Setup

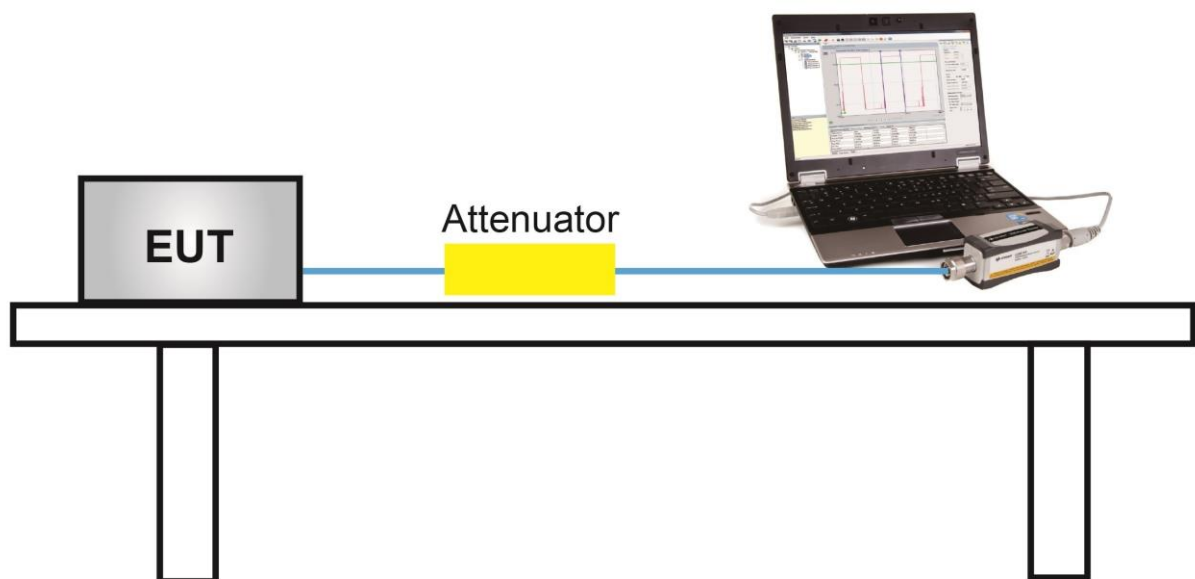

**6.2.5. Test Result**

|               |          |                   |            |
|---------------|----------|-------------------|------------|
| Test Site     | TR3      | Temperature       | 25°C       |
| Test Engineer | Andy Zhu | Relative Humidity | 52%        |
| Test Mode     | J52 Band | Test Date         | 2019/10/25 |

| Frequency (MHz) | Power Meter Level (dBm) | Conducted Power Limit (dBm) | Test Result |
|-----------------|-------------------------|-----------------------------|-------------|
| <b>1mW</b>      |                         |                             |             |
| 558.000         | -0.31                   | ≤ 23.98                     | Pass        |
| 580.000         | -0.63                   | ≤ 23.98                     | Pass        |
| 602.000         | -1.24                   | ≤ 23.98                     | Pass        |
| <b>10mW</b>     |                         |                             |             |
| 558.000         | 10.21                   | ≤ 23.98                     | Pass        |
| 580.000         | 10.19                   | ≤ 23.98                     | Pass        |
| 602.000         | 9.88                    | ≤ 23.98                     | Pass        |

Note: Limit (dBm) =  $10 \cdot \log(250 \text{ mW}) = 23.98 \text{ dBm}$ .

## **6.1. Frequency Tolerance Measurement**

### **6.1.1. Test Limit**

The frequency tolerance of the transmitter shall be 0.005 percent.

### **6.1.2. Test Procedure**

ANSI C63.26 - Section 5.6.3

### **6.1.3. Test Setting**

#### **Frequency Stability Under Temperature Variations:**

The equipment under test was connected to an external AC or DC power supply and input rated voltage. RF output was connected to a frequency counter or spectrum analyzer via feed through attenuators. The EUT was placed inside the temperature chamber. Set the spectrum analyzer RBW low enough to obtain the desired frequency resolution and measure EUT 20°C operating frequency as reference frequency. Turn EUT off and set the chamber temperature to highest. After the temperature stabilized for approximately 30 minutes recorded the frequency. Repeat step measure with 10°C decreased per stage until the lowest temperature reached.

#### **Frequency Stability Under Voltage Variations:**

Set chamber temperature to 20°C. Use a variable AC power supply / DC power source to power the EUT and set the voltage to rated voltage. Set the spectrum analyzer RBW low enough to obtain the desired frequency resolution and recorded the frequency.

Reduce the input voltage to specify extreme voltage variation ( $\pm 15\%$ ) and endpoint (If a product is specified to operate over a range of input voltage then the  $-15\%$  variation is applied to the lowermost voltage and the  $+15\%$  is applied to the uppermost voltage), record the maximum frequency change.



### 6.1.4. Test Setup

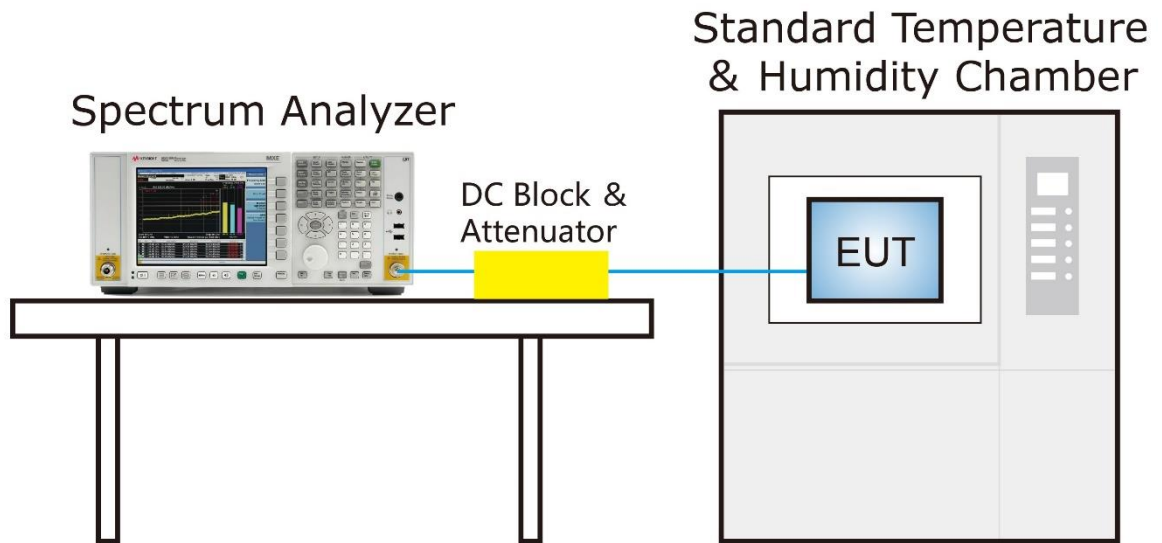

**6.1.5. Test Result**

|               |                 |                   |            |
|---------------|-----------------|-------------------|------------|
| Test Site     | TR3             | Temperature       | -20 ~ 50°C |
| Test Engineer | Andy Zhu        | Relative Humidity | 48 ~ 55%RH |
| Test Mode     | J52 Band - 10mW | Test Date         | 2019/10/25 |

| Voltage (%) | Power (V <sub>DC</sub> ) | Temp (°C)    | Nominal Frequency (MHz) | Measured Frequency (MHz) | Deviation (%) | Limit (%) | Result |
|-------------|--------------------------|--------------|-------------------------|--------------------------|---------------|-----------|--------|
| 100%        | 3.60                     | -20          | 558.000                 | 557.999519               | -0.000086     | -/+0.005  | Pass   |
|             |                          |              | 580.000                 | 579.999819               | -0.000031     | -/+0.005  | Pass   |
|             |                          |              | 602.000                 | 601.999816               | -0.000031     | -/+0.005  | Pass   |
|             |                          | -10          | 558.000                 | 557.999577               | -0.000076     | -/+0.005  | Pass   |
|             |                          |              | 580.000                 | 579.999948               | -0.000009     | -/+0.005  | Pass   |
|             |                          |              | 602.000                 | 601.999951               | -0.000008     | -/+0.005  | Pass   |
|             |                          | 0            | 558.000                 | 557.999528               | -0.000085     | -/+0.005  | Pass   |
|             |                          |              | 580.000                 | 580.000127               | 0.000022      | -/+0.005  | Pass   |
|             |                          |              | 602.000                 | 602.000101               | 0.000017      | -/+0.005  | Pass   |
|             |                          | +10          | 558.000                 | 557.999685               | -0.000056     | -/+0.005  | Pass   |
|             |                          |              | 580.000                 | 580.000164               | 0.000028      | -/+0.005  | Pass   |
|             |                          |              | 602.000                 | 602.000175               | 0.000029      | -/+0.005  | Pass   |
|             |                          | +20<br>(Ref) | 558.000                 | 557.999640               | -0.000065     | -/+0.005  | Pass   |
|             |                          |              | 580.000                 | 580.000238               | 0.000041      | -/+0.005  | Pass   |
|             |                          |              | 602.000                 | 602.000247               | 0.000041      | -/+0.005  | Pass   |
|             |                          | +30          | 558.000                 | 557.999564               | -0.000078     | -/+0.005  | Pass   |
|             |                          |              | 580.000                 | 580.000227               | 0.000039      | -/+0.005  | Pass   |
|             |                          |              | 602.000                 | 602.000234               | 0.000039      | -/+0.005  | Pass   |
|             |                          | +40          | 558.000                 | 557.999518               | -0.000086     | -/+0.005  | Pass   |
|             |                          |              | 580.000                 | 580.000214               | 0.000037      | -/+0.005  | Pass   |
|             |                          |              | 602.000                 | 602.000224               | 0.000037      | -/+0.005  | Pass   |
|             |                          | +50          | 558.000                 | 557.999528               | -0.000085     | -/+0.005  | Pass   |
|             |                          |              | 580.000                 | 580.000248               | 0.000043      | -/+0.005  | Pass   |
|             |                          |              | 602.000                 | 602.000258               | 0.000043      | -/+0.005  | Pass   |

| Voltage (%) | Power (V <sub>DC</sub> ) | Temp (°C) | Nominal Frequency (MHz) | Measured Frequency (MHz) | Deviation (%) | Limit (%) | Result |
|-------------|--------------------------|-----------|-------------------------|--------------------------|---------------|-----------|--------|
| 115%        | 4.14                     | +20       | 558.000                 | 557.999518               | -0.000086     | -/+0.005  | Pass   |
|             |                          |           | 580.000                 | 580.000154               | 0.000027      | -/+0.005  | Pass   |
|             |                          |           | 602.000                 | 602.000162               | 0.000027      | -/+0.005  | Pass   |
| 85%         | 3.06                     | +20       | 558.000                 | 557.999521               | -0.000086     | -/+0.005  | Pass   |
|             |                          |           | 580.000                 | 580.000160               | 0.000028      | -/+0.005  | Pass   |
|             |                          |           | 602.000                 | 602.000168               | 0.000028      | -/+0.005  | Pass   |

Note 1: Frequency Tolerance (%) =  $\{[\text{Measured Frequency (MHz)} - \text{Nominal Frequency (MHz)}] / \text{Nominal Frequency (MHz)}\} * 10^2$ .

## 6.2. 99% Occupied Bandwidth Measurement

### 6.2.1. Test Limit

The operating bandwidth shall not exceed 200 kHz.

### 6.2.2. Test Procedure used

ANSI C63.26-2015 - Section 5.4.4

### 6.2.3. Test Setting

1. The signal analyzer's automatic bandwidth measurement capability was used to perform the 99% occupied bandwidth. The bandwidth measurement was not influenced by any intermediate power nulls in the fundamental emission.
2. RBW = 1 - 5% of the expected OBW
3. VBW  $\geq 3 \times$  RBW
4. Detector = Peak
5. Trace mode = max hold
6. Sweep = auto couple
7. The trace was allowed to stabilize
8. Reported the measured 99% occupied bandwidth

### 6.2.4. Test Setup

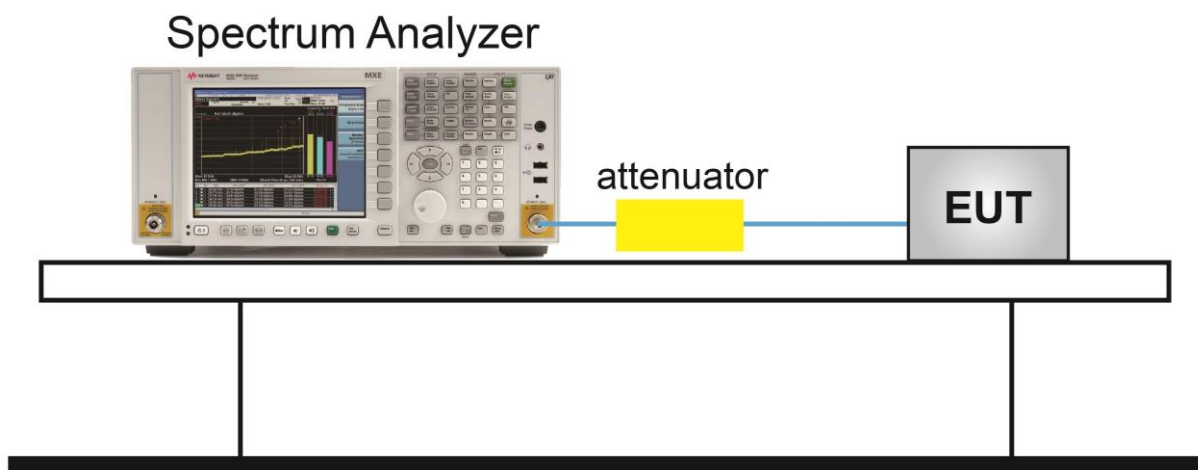

### 6.2.5. Test Result

|               |                 |                   |            |
|---------------|-----------------|-------------------|------------|
| Test Site     | TR3             | Temperature       | 25°C       |
| Test Engineer | Andy Zhu        | Relative Humidity | 52%        |
| Test Mode     | J52 Band - 10mW | Test Date         | 2019/10/25 |

| Frequency (MHz) | 99% Bandwidth (kHz) | Limit (kHz) | Result |
|-----------------|---------------------|-------------|--------|
| 558.000         | 168.75              | < 200       | Pass   |
| 580.000         | 167.82              | < 200       | Pass   |
| 602.000         | 169.27              | < 200       | Pass   |

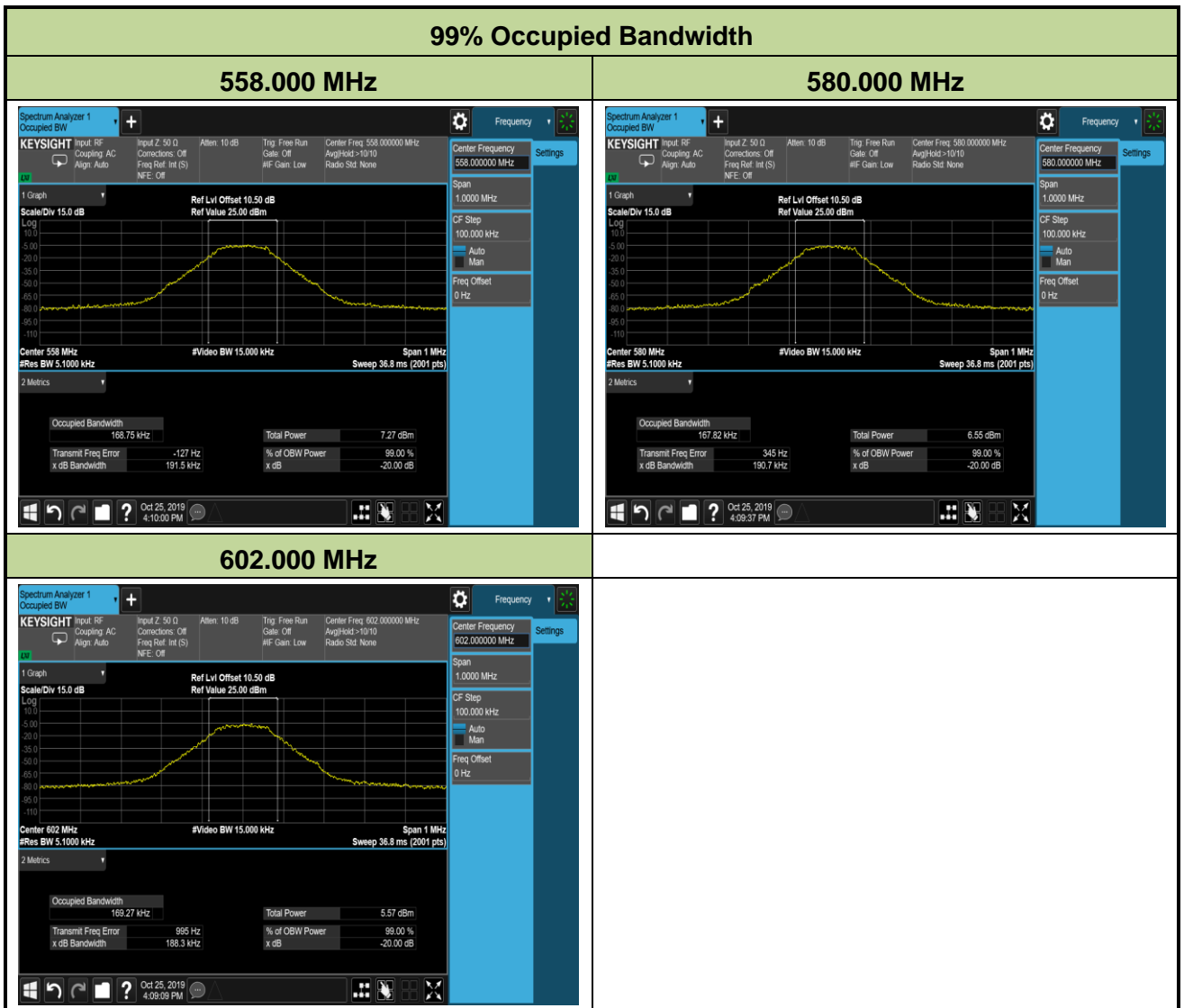

### **6.3. Out-of-band Emission Mask Measurement**

#### **6.3.1. Test Limit**

The mean power of emissions shall be attenuated below the mean output power of the transmitter in accordance with the following schedule:

- (i) On any frequency removed from the operating frequency by more than 50 percent up to and including 100 percent of the authorized bandwidth: at least 25 dB;
- (ii) On any frequency removed from the operating frequency by more than 100 percent up to and including 250 percent of the authorized bandwidth: at least 35 dB;
- (iii) On any frequency removed from the operating frequency by more than 250 percent of the authorized bandwidth: at least  $43+10\log_{10}$  (mean output power in watts) dB.

#### **6.3.2. Test Procedure Used**

ANSI C63.26 - Section 5.7

#### **6.3.3. Test Setting**

Emission Mask

- a) The EUT was connected to a spectrum analyzer. The un-modulated carrier signal level was measured and recorded.
- b) The EUT was modulated with typical digital modulation.
- c) The spectrum analyzer center frequency was set to the EUT operating frequency; span was set to 2 MHz; resolution bandwidth was set to 1 MHz; video bandwidth set to 3 MHz; sweep time set to 3 s; after clear/write, max-hold was set; Marker 1 was set to Peak, then Marker 1 was set to reference value.
- d) The peak output power was recorded and used to set the reference level on the spectrum analyzer.
- e) The spectrum analyzer span was then set to 1.5 MHz; resolution bandwidth set to 2 kHz, video bandwidth set to 5 kHz, sweep time to Auto; trace set to Max Hold.

### 6.3.4. Test Setup

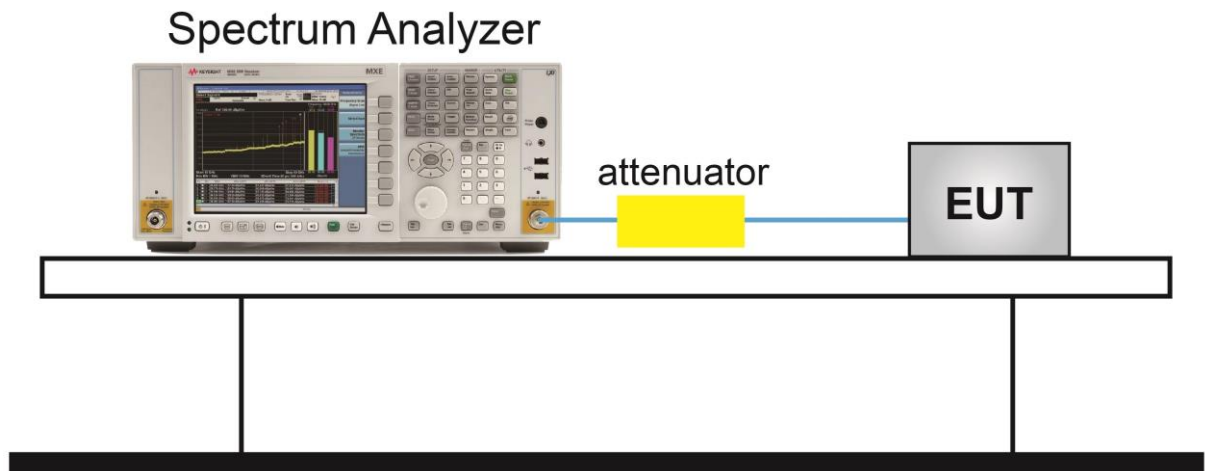

### 6.3.5. Test Result

|               |          |                   |            |
|---------------|----------|-------------------|------------|
| Test Site     | TR3      | Temperature       | 25°C       |
| Test Engineer | Andy Zhu | Relative Humidity | 52%        |
| Test Mode     | J52 Band | Test Date         | 2019/10/29 |

### J52 58 Band 1mW - Emission Mask

#### Channel 558.000MHz

##### Reference Level



##### Emission Mask

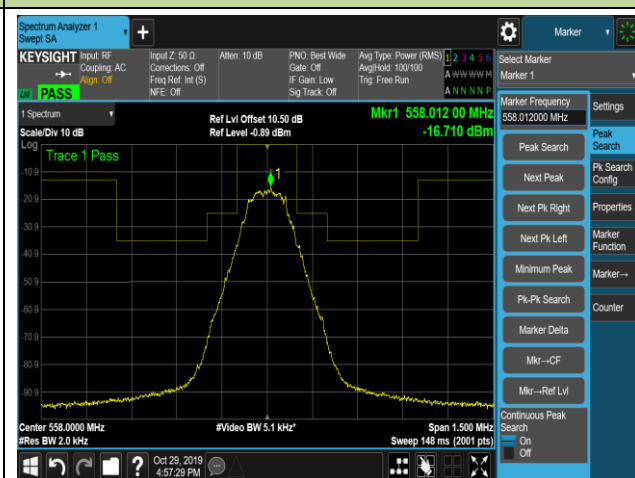

#### Channel 580.000 MHz

##### Reference Level



##### Emission Mask

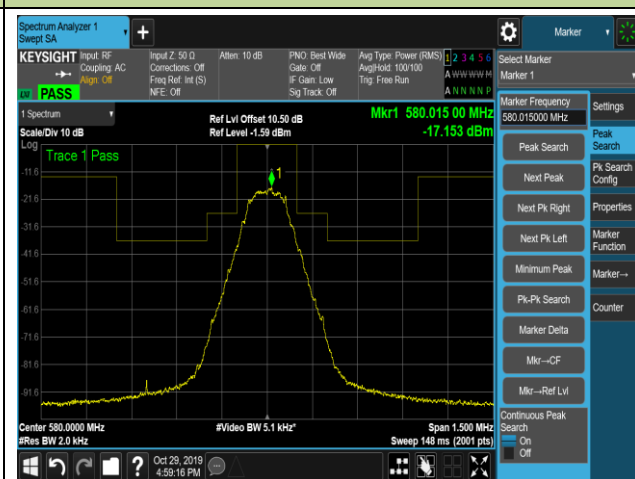



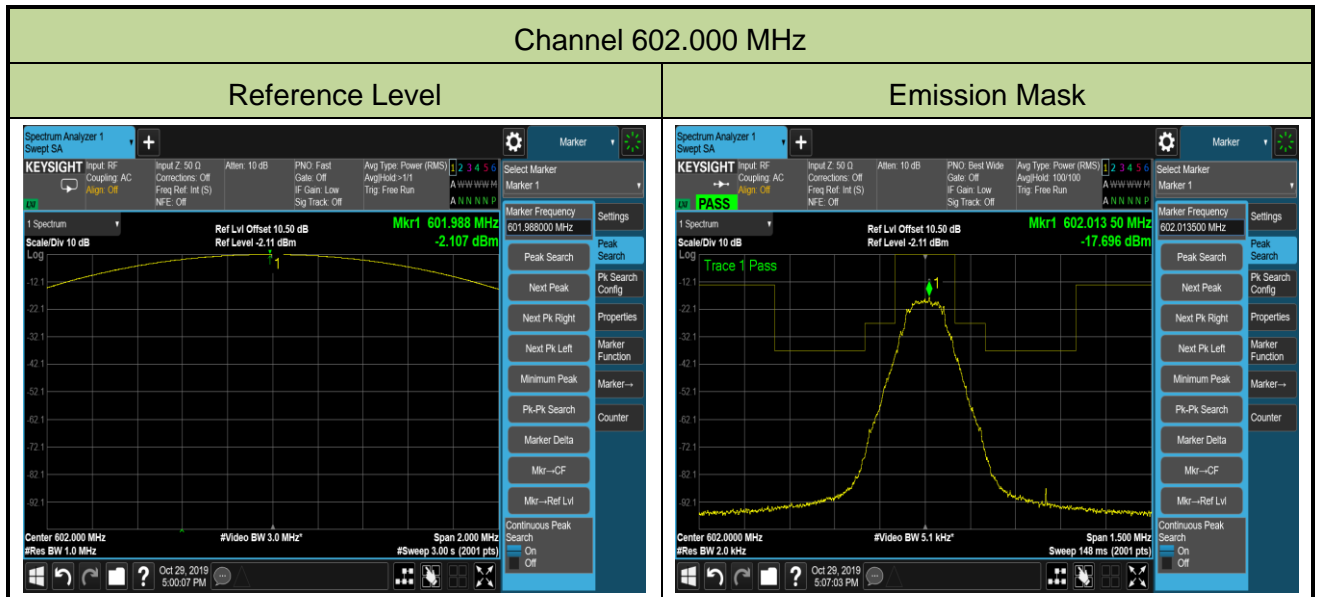

### J52 Band 10mW - Emission Mask

#### Channel 558.000MHz

##### Reference Level

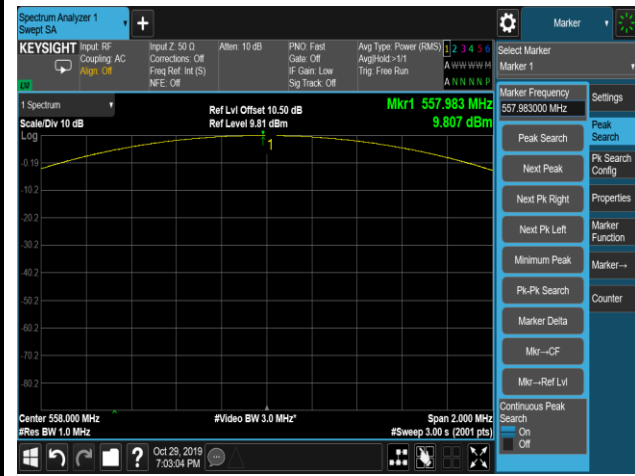

##### Emission Mask

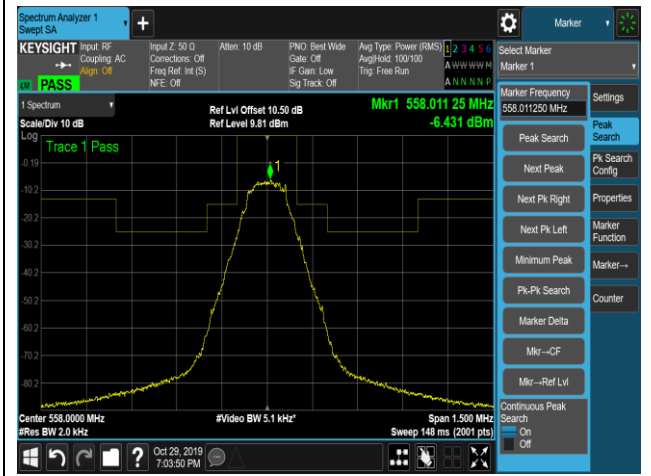

#### Channel 580.000 MHz

##### Reference Level



##### Emission Mask

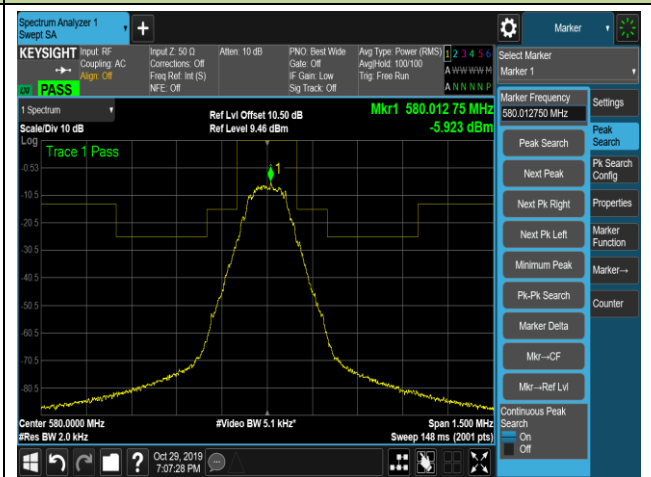

#### Channel 602.000 MHz

##### Reference Level



##### Emission Mask

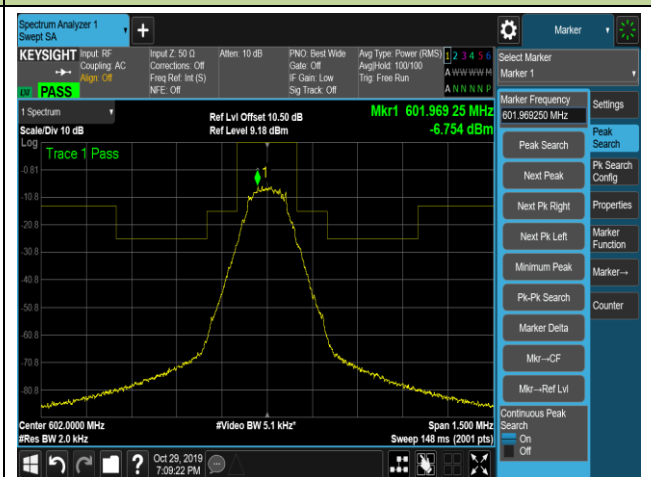

## 6.4. Necessary Bandwidth Measurement

### 6.4.1. Test Limit

Digital emissions within the band from one megahertz below to one megahertz above the carrier frequency shall comply with the emission mask in section 8.3.2.2 of the European Telecommunications Institute Standard ETSI EN 300 422-1 v1.4.2, the transmitter output spectrum shall be within the mask defined as below figure.

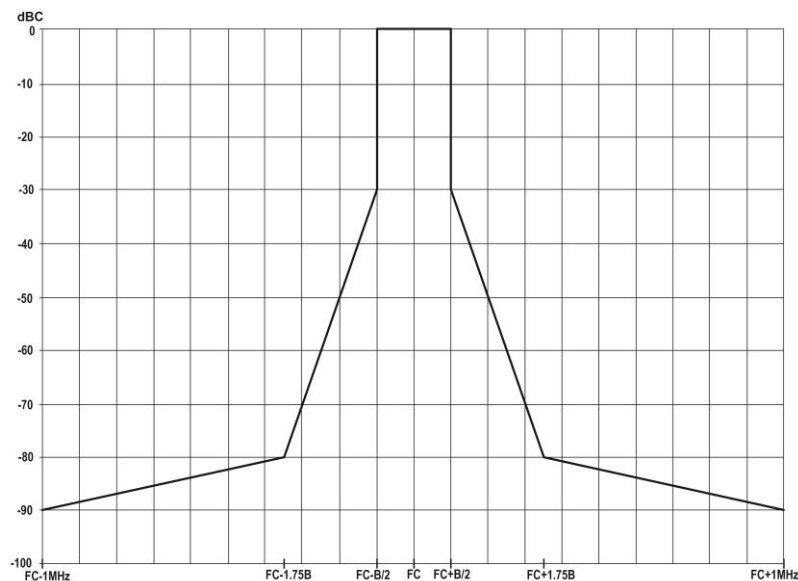

### 6.4.2. Test Procedure Used

EN 300 422-1 V1.4.2 clause 8.3.2.1.

### 6.4.3. Test Setting

The EUT was powered up and the transmit frequency & power output of the EUT were selected.

The spectrum analyzer center frequency is set to the nominal EUT channel center frequency.

Only lowest and highest channel is required, at an output power level of 1mW and 10mW.

### 6.4.4. Test Setup

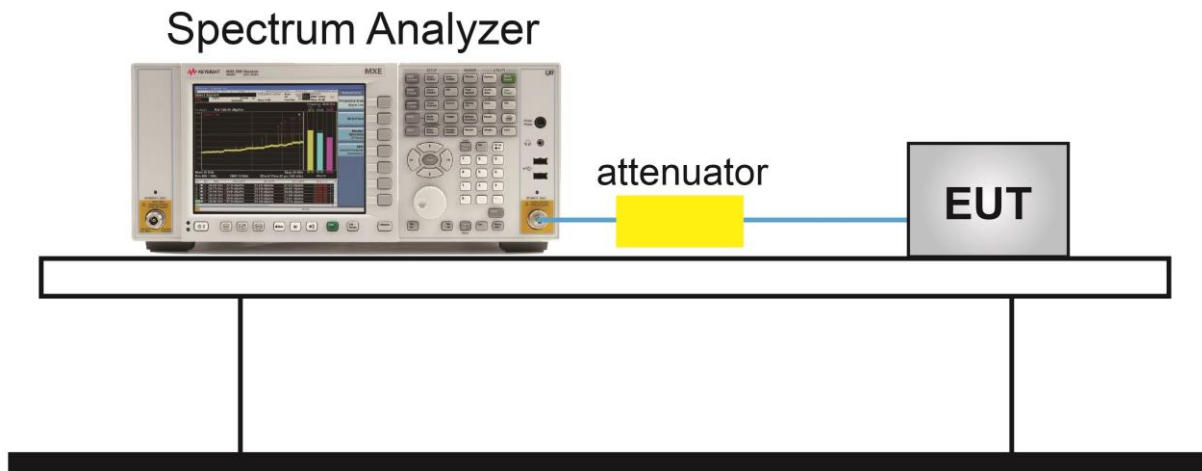

### 6.4.5. Test Result

|               |          |                   |                         |
|---------------|----------|-------------------|-------------------------|
| Test Site     | TR3      | Temperature       | 25°C                    |
| Test Engineer | Andy Zhu | Relative Humidity | 52%                     |
| Test Mode     | J52 Band | Test Date         | 2019/10/25 ~ 2019/11/21 |

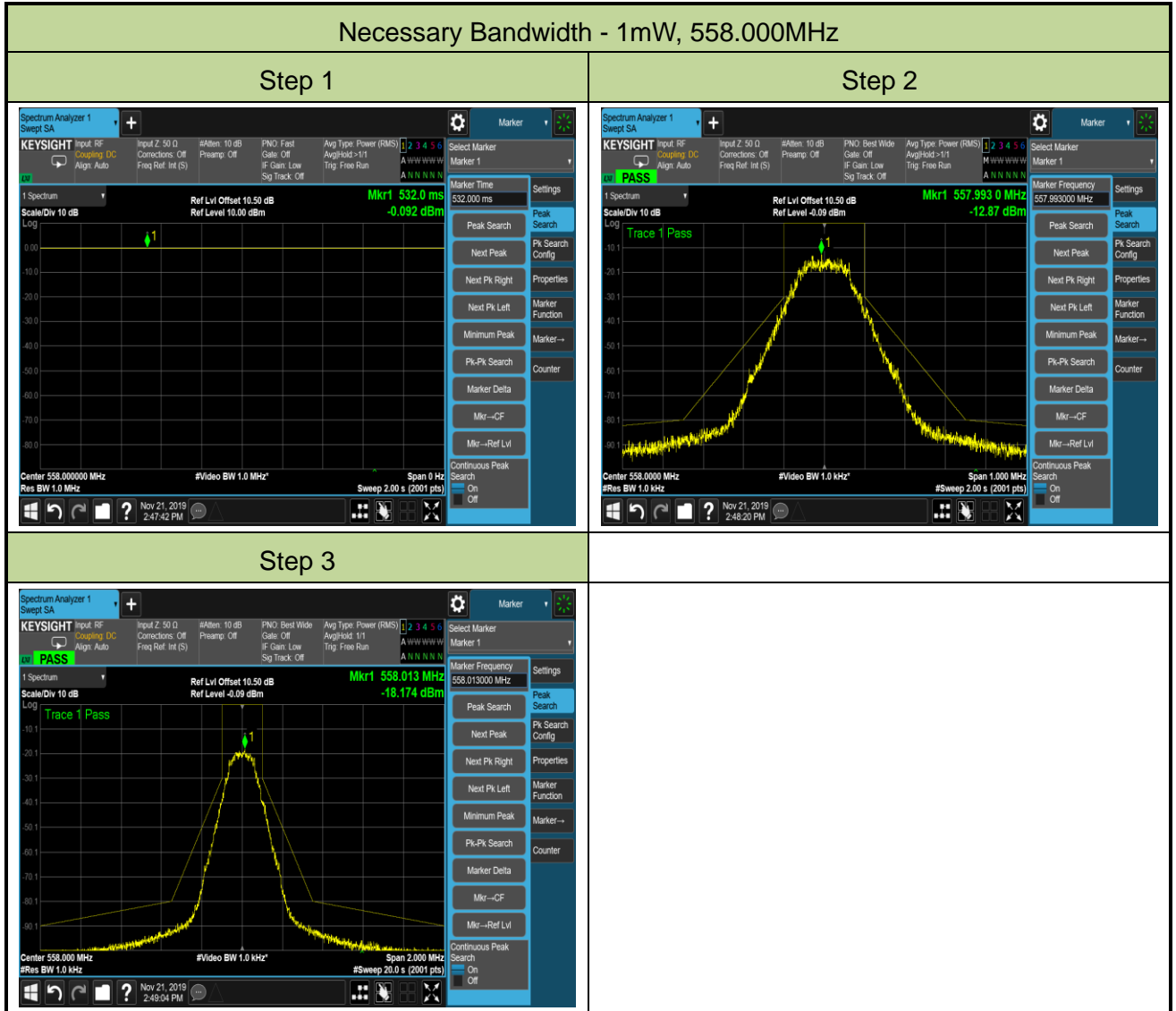

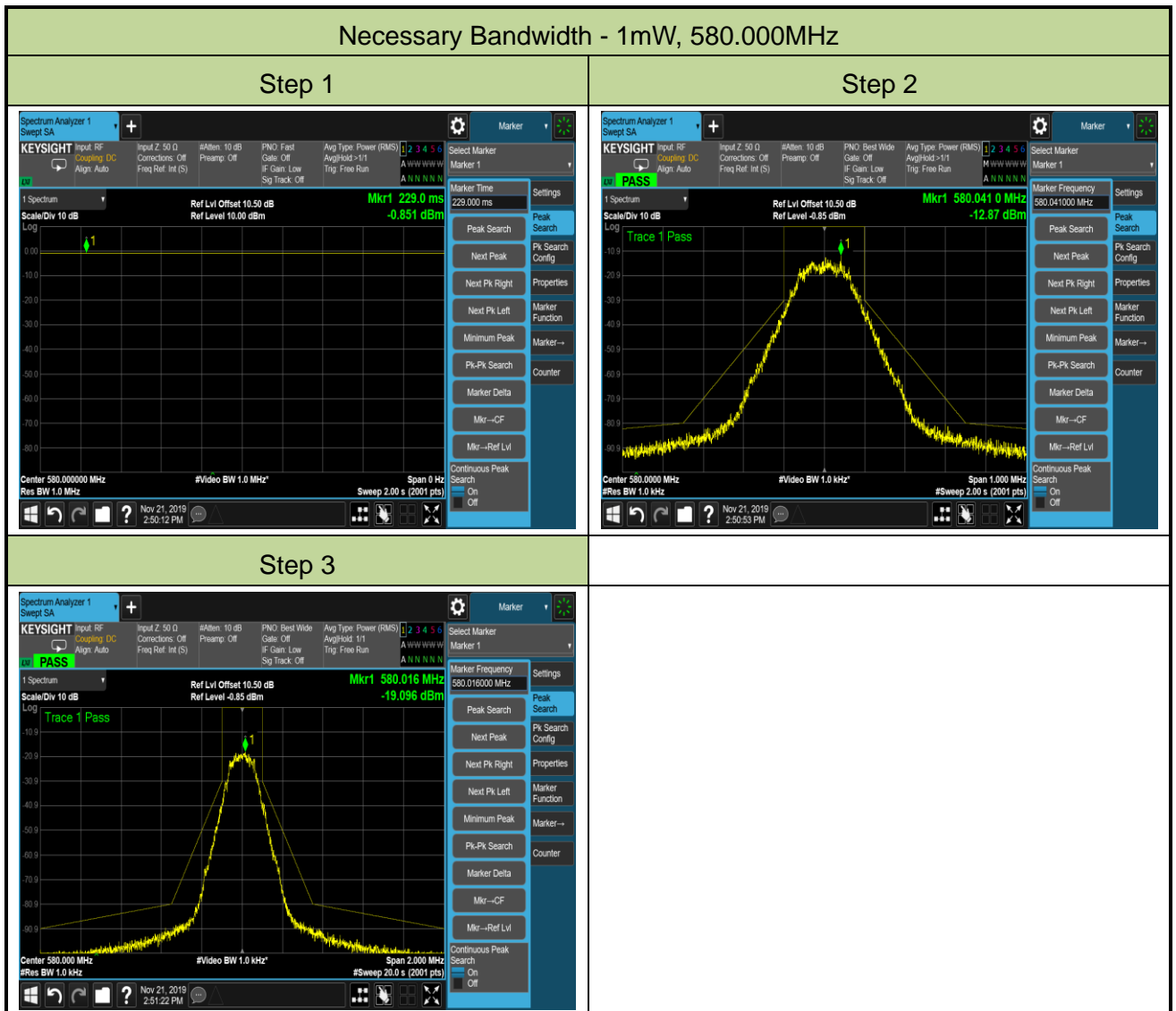

### Necessary Bandwidth - 1mW, 602.000MHz

#### Step 1



#### Step 2

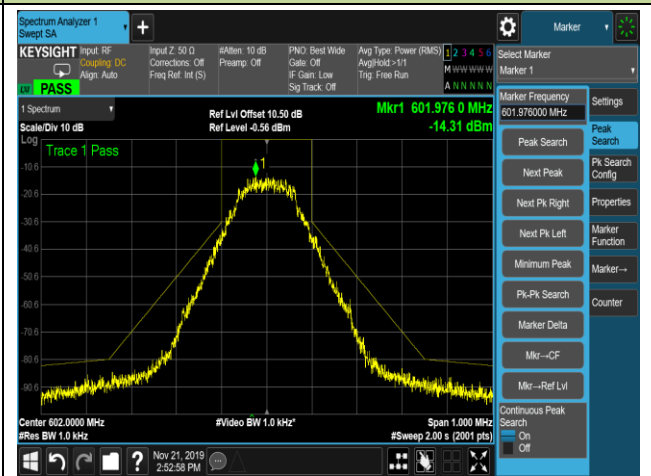

#### Step 3

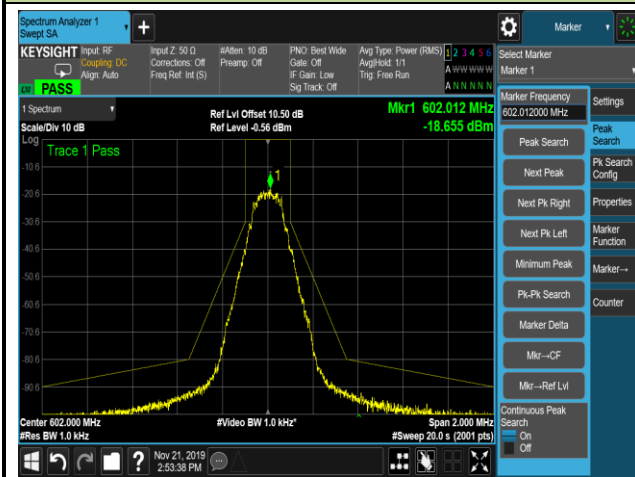

### Necessary Bandwidth - 10mW, 558.000MHz

#### Step 1



#### Step 2

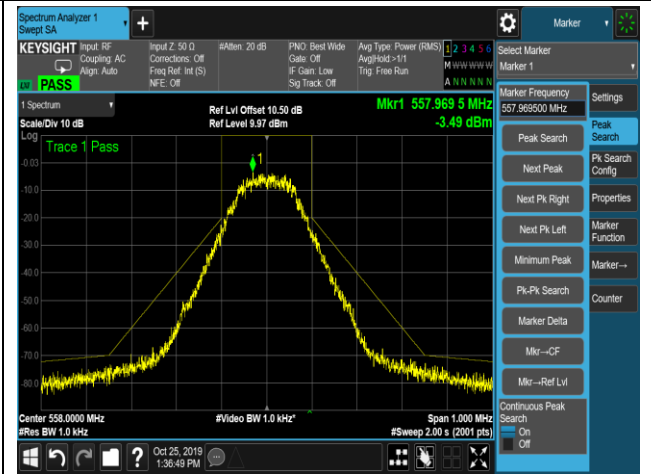

#### Step 3

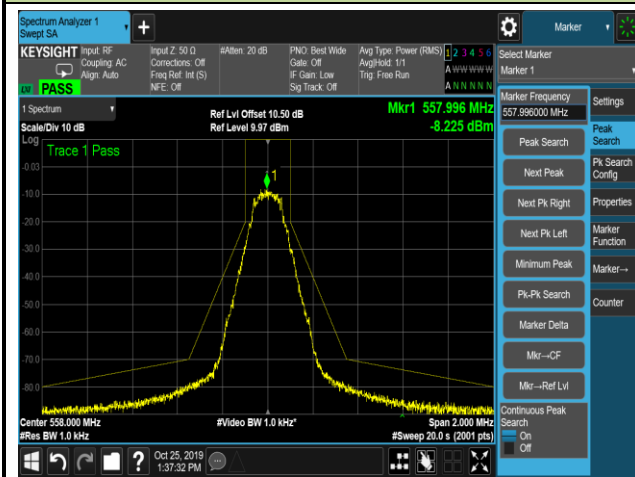



### Necessary Bandwidth - 10mW, 580.000MHz

#### Step 1



#### Step 2

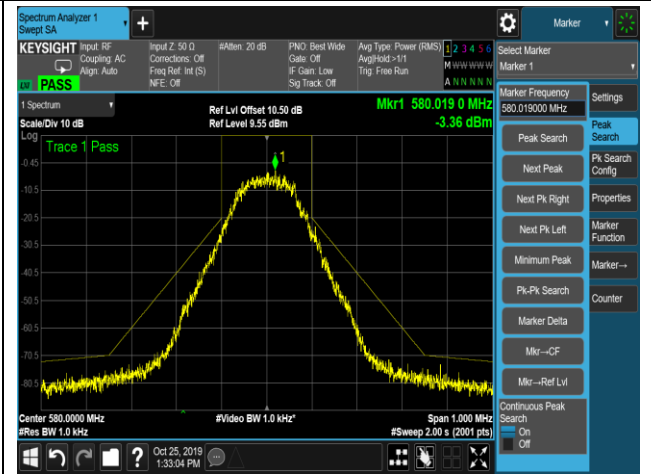

#### Step 3

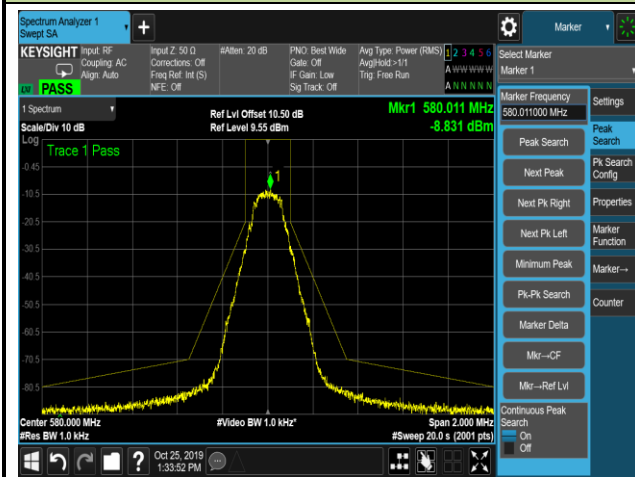

### Necessary Bandwidth - 10mW, 602.000MHz

#### Step 1



#### Step 2

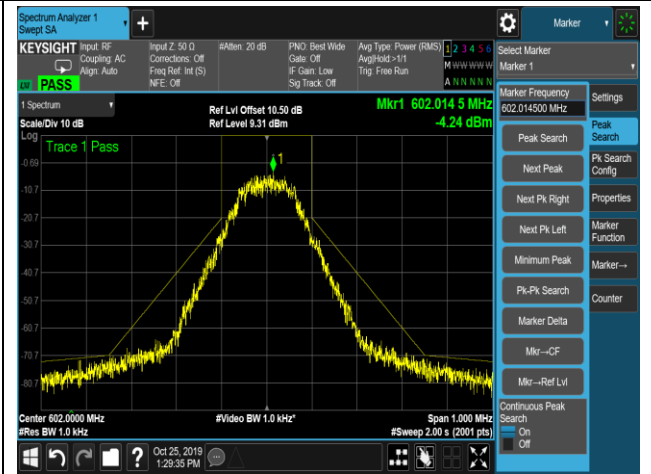

#### Step 3

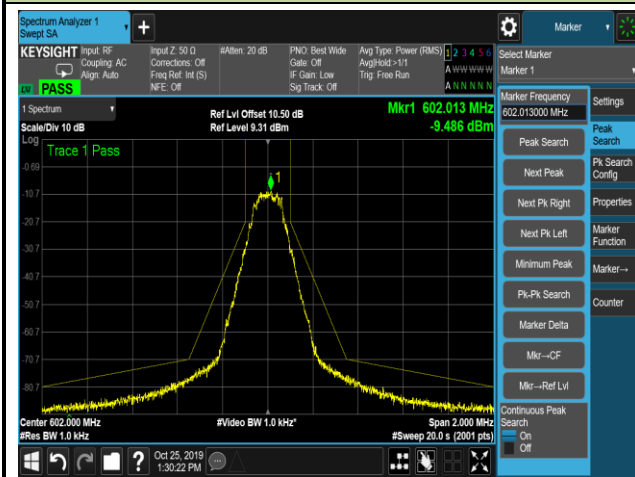

## 6.5. Radiated Spurious Emissions Measurement

### 6.5.1. Test Limit

According to FCC Part 74.861(e)(7), beyond one megahertz below and above the carrier frequency, emissions shall comply with the limits specified in section 8.4 of ETSI EN 300 422-1 v1.4.2.

| State     | Frequency Range   |                                    |                              |
|-----------|---|------------------------------------|------------------------------|
|           | 47MHz to 74MHz, 87.5MHz to 137MHz<br>174MHz to 230MHz, 470MHz to 862MHz | Other Frequencies<br>below 1000MHz | Frequencies above<br>1000MHz |
| Operation | 4nW   | 250nW                              | 1uW                          |
| Standby   | 2nW   | 2nW                                | 20nW                         |

### 6.5.2. Test Procedure Used

ETSI EN 300 422-1 V1.4.2 clause 8.4.2.

### 6.5.3. Test Setting

**Table 1 - RBW as a function of frequency**

| Frequency       | RBW     |
|-----------------|---------|
| 25 ~ 30 MHz     | 9 kHz   |
| 30 ~ 1000 MHz   | 100 kHz |
| 1000 ~ 6000 MHz | 1 MHz   |

Emissions shall be investigated up to the 10<sup>th</sup> harmonic of the fundamental.

Compliance with the emission limits shall be demonstrated using a RMS Average detector.

All significant broadband and narrowband signals found in the preliminary sweeps were measured using a peak detector at a test distance of 3 meters.

At each frequency at which a component is detected, the sample shall be rotated to obtain maximum response and the effective radiated power of that component determined by a substitution measurement.

### 6.5.4. Test Setup

#### Below 1GHz Test Setup:

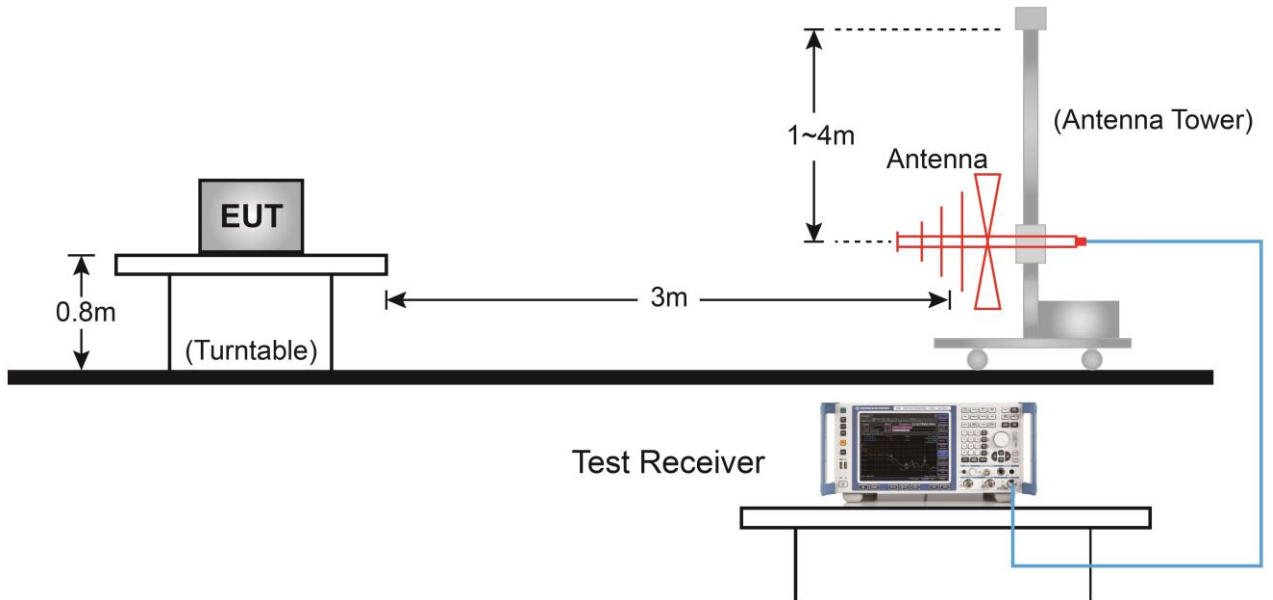

#### Above 1GHz Test Setup:

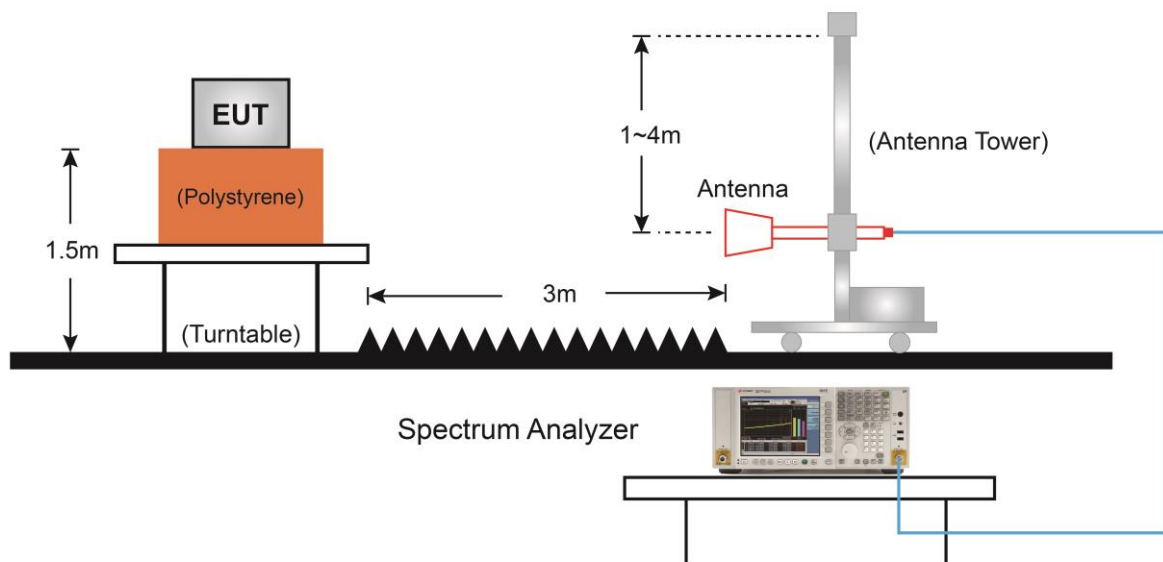

**6.5.5. Test Result**

|               |                |                   |            |
|---------------|----------------|-------------------|------------|
| Test Site     | TR3            | Temperature       | 25°C       |
| Test Engineer | Lewis Huang    | Relative Humidity | 54%        |
| Test Mode     | J52 Band - 1mW | Test Date         | 2019/11/10 |

| Test Channel (MHz) | Frequency (MHz) | Ant. Pol. (H/V) | SG Reading (dBm) | Cable Loss (dB) | Substitute Antenna Gain (dBi) | EIRP (dBm) | Limit (dBm) | Margin (dB) |
|--------------------|-----------------|-----------------|------------------|-----------------|-------------------------------|------------|-------------|-------------|
| 558.000            | 2232.00         | H               | -59.54           | 3.71            | 9.37                          | -53.88     | -30.00      | -23.88      |
|                    | 3906.00         | H               | -55.62           | 4.85            | 12.67                         | -47.80     | -30.00      | -17.80      |
|                    | 5022.00         | H               | -52.46           | 5.54            | 12.67                         | -45.33     | -30.00      | -15.33      |
|                    | 2232.00         | V               | -59.50           | 3.71            | 9.37                          | -53.84     | -30.00      | -23.84      |
|                    | 2790.00         | V               | -59.44           | 4.12            | 11.23                         | -52.33     | -30.00      | -22.33      |
|                    | 5022.00         | V               | -54.83           | 5.54            | 12.67                         | -47.70     | -30.00      | -17.70      |
| 580.000            | 2320.00         | H               | -60.43           | 3.77            | 9.76                          | -54.44     | -30.00      | -24.44      |
|                    | 2900.00         | H               | -59.88           | 4.19            | 11.45                         | -52.62     | -30.00      | -22.62      |
|                    | 5104.00         | H               | -50.45           | 5.55            | 12.76                         | -43.24     | -30.00      | -13.24      |
|                    | 1740.00         | V               | -64.83           | 3.29            | 10.22                         | -57.90     | -30.00      | -27.90      |
|                    | 2900.00         | V               | -59.63           | 4.19            | 11.45                         | -52.37     | -30.00      | -22.37      |
|                    | 5800.00         | V               | -55.72           | 6.02            | 13.09                         | -48.65     | -30.00      | -18.65      |
| 602.000            | 2408.00         | H               | -60.78           | 3.84            | 10.23                         | -54.39     | -30.00      | -24.39      |
|                    | 3010.00         | H               | -58.83           | 4.27            | 11.53                         | -51.57     | -30.00      | -21.57      |
|                    | 4214.00         | H               | -56.71           | 5.09            | 12.70                         | -49.10     | -30.00      | -19.10      |
|                    | 1806.00         | V               | -64.87           | 3.31            | 10.36                         | -57.82     | -30.00      | -27.82      |
|                    | 2408.00         | V               | -61.87           | 3.84            | 10.23                         | -55.48     | -30.00      | -25.48      |
|                    | 6020.00         | V               | -54.10           | 6.06            | 12.98                         | -47.18     | -30.00      | -17.18      |

Note 1:  $EIRP (dBm) = SG \text{ Reading (dBm)} - Cable \text{ Loss (dB)} + Substitute \text{ Antenna Gain (dBi)}$

Note 2:  $Margin (dB) = EIRP (dBm) - Limit (dBm)$

Note 3: All data in this table is based on peak detection. Due to peak detection will yield amplitudes equal to or greater than amplitudes measured with the RMS detector. Thus, the data measured using the peak detector of a spectrum analyzer or EMI receiver will represent the worst-case results.

|               |                 |                   |            |
|---------------|-----------------|-------------------|------------|
| Test Site     | TR3             | Temperature       | 25°C       |
| Test Engineer | Lewis Huang     | Relative Humidity | 54%        |
| Test Mode     | J52 Band - 10mW | Test Date         | 2019/11/10 |

| Test Channel (MHz) | Frequency (MHz) | Ant. Pol. (H/V) | SG Reading (dBm) | Cable Loss (dB) | Substitute Antenna Gain (dBi) | EIRP (dBm) | Limit (dBm) | Margin (dB) |
|--------------------|-----------------|-----------------|------------------|-----------------|-------------------------------|------------|-------------|-------------|
| 558.000            | 3906.00         | H               | -56.01           | 4.85            | 11.66                         | -49.19     | -30.00      | -19.19      |
|                    | 5022.00         | H               | -54.16           | 5.54            | 12.67                         | -47.03     | -30.00      | -17.03      |
|                    | 5580.00         | H               | -54.73           | 5.85            | 13.15                         | -47.44     | -30.00      | -17.44      |
|                    | 3906.00         | V               | -54.86           | 3.71            | 9.37                          | -49.19     | -30.00      | -19.19      |
|                    | 5022.00         | V               | -54.29           | 4.23            | 11.49                         | -47.03     | -30.00      | -17.03      |
|                    | 5580.00         | V               | -55.36           | 4.81            | 12.74                         | -47.44     | -30.00      | -17.44      |
| 580.000            | 3906.00         | H               | -55.18           | 3.77            | 9.76                          | -49.19     | -30.00      | -19.19      |
|                    | 5022.00         | H               | -54.30           | 5.35            | 12.62                         | -47.03     | -30.00      | -17.03      |
|                    | 5580.00         | H               | -54.65           | 5.92            | 13.14                         | -47.44     | -30.00      | -17.44      |
|                    | 3906.00         | V               | -56.45           | 4.19            | 11.45                         | -49.19     | -30.00      | -19.19      |
|                    | 5022.00         | V               | -54.10           | 6.02            | 13.09                         | -47.03     | -30.00      | -17.03      |
|                    | 5580.00         | V               | -53.52           | 6.32            | 12.40                         | -47.44     | -30.00      | -17.44      |
| 602.000            | 3906.00         | H               | -56.45           | 4.27            | 11.53                         | -49.19     | -30.00      | -19.19      |
|                    | 5022.00         | H               | -54.64           | 5.09            | 12.70                         | -47.03     | -30.00      | -17.03      |
|                    | 5580.00         | H               | -53.16           | 6.44            | 12.16                         | -47.44     | -30.00      | -17.44      |
|                    | 3906.00         | V               | -57.05           | 4.71            | 12.58                         | -49.19     | -30.00      | -19.19      |
|                    | 5022.00         | V               | -54.14           | 5.47            | 12.59                         | -47.03     | -30.00      | -17.03      |
|                    | 5580.00         | V               | -53.16           | 6.44            | 12.16                         | -47.44     | -30.00      | -17.44      |

Note 1:  $EIRP (dBm) = SG \text{ Reading (dBm)} - Cable \text{ Loss (dB)} + Substitute \text{ Antenna Gain (dBi)}$

Note 2:  $Margin (dB) = EIRP (dBm) - Limit (dBm)$

Note 3: All data in this table is based on peak detection. Due to peak detection will yield amplitudes equal to or greater than amplitudes measured with the RMS detector. Thus, the data measured using the peak detector of a spectrum analyzer or EMI receiver will represent the worst-case results.

## 7. CONCLUSION

The data collected relate only the item(s) tested and show that the unit compliance with all the requirements of Parts 74H of the FCC Rules.

————— The End —————

## **Appendix A – Test Setup Photograph**

Refer to “1910RSU041-UT” file.



## **Appendix B – EUT Photograph**

Refer to “1910RSU041-UE” file.