

SHURE®

Shure SLX™ Wireless Systems User Guide

SLX® Wireless Systems User Guide

SHURE®

SHURE Incorporated <http://www.shure.com>

United States, Canada, Latin America, Caribbean:

5800 W. Touhy Avenue, Niles, IL 60714-4608, U.S.A.

Phone: 847-600-2000 U.S. Fax: 847-600-1212 Int'l Fax: 847-600-6446

Europe, Middle East, Africa:

Shure Europe GmbH, Phone: 49-7131-72140 Fax: 49-7131-721414

Asia, Pacific:

Shure Asia Limited, Phone: 852-2893-4290 Fax: 852-2893-4055



Smart, Hard-working Wireless

Shure SLX Wireless

Smart, Hard-working Wireless

Congratulations! Welcome to Shure SLX Wireless. Your new system is rugged, reliable, easy to set up and operate, and produces outstanding audio clarity. Whether you're a vocalist, guitarist, or instrumentalist, your SLX Wireless system will show you how easy wireless can be, and how good wireless can sound.

This user guide and the Quick Setup guide included with your system will tell you all you need to know to get your system working right away.

Welcome to the world of SLX: smart, hard-working wireless.

Frequency Band Selection

Most countries closely regulate the radio frequencies used in the transmission of wireless information. These regulations state which devices can use which frequencies, and help to limit the amount of RF (radio frequency) interference in all wireless communications.

To be flexible enough to operate worldwide, SLX receivers are available in a number of models, each with a unique frequency range. Each frequency range, or band, spans up to 24 MHz of the wireless broadcast spectrum. Available bands are:

H5: 518–542 MHz	R5: 800–820 MHz
J3: 572–596 MHz	S6: 838–865 MHz
L4: 638–662 MHz	JB: 806–810 MHz
P4: 702–726 MHz	Q4: 740–752 MHz
R13: 794–806 MHz	

To facilitate system setup and protect against RF interference, each system comes with multiple predefined frequency **groups** and **channels**.

When using a single SLX system, the operating frequency will generally not have to be changed. In an installation with multiple receiver/transmitter systems, each system must operate on a separate channel. The group and channel system provides an optimum frequency spread when using multiple systems.

Within a single frequency band, up to 12 individual transmitter/receiver systems may be used in a single installation. In regions where additional frequency bands are available, it is possible to operate up to 20 systems simultaneously. Check with your local Shure retailer for information on which bands are available in your area.

What Do You Want to Do Now?

Learn about your SLX4 Receiver

Power, lock/unlock, front and back panel features: See [“SLX4 Receiver Features”](#) on page 5 and [“SLX4 Receiver Programming”](#) on page 9.

Learn about your SLX2 Handheld Transmitter

Power, mute, gain, lock/unlock, other features: See [“SLX2 Handheld Transmitter”](#) on page 6 and [“SLX1 and SLX2 Transmitter Programming”](#) on page 10.

Learn about your SLX1 Bodypack Transmitter

Power, mute, gain, lock/unlock, other features: See [“SLX1 Bodypack Transmitter”](#) on page 7 and [“SLX1 and SLX2 Transmitter Programming”](#) on page 10.

Program your SLX Receiver and Transmitter

Frequency selection, LCD features, using the **select** and **menu** buttons: See [“SLX Programming”](#) on page 9.

Learn how to use multiple systems in a single installation

See [“Multiple System Setup”](#) on page 8.

Troubleshoot your SLX system

See [“Troubleshooting”](#) on page 12.

Table of Contents

System Components	4
SLX4 Receiver Features	5
SLX2 Handheld Transmitter	6
SLX1 Bodypack Transmitter	7
Single System Setup	8
Multiple System Setup	8
SLX Programming	9
SLX4 Receiver Programming	9
SLX1 and SLX2 Transmitter Programming	10
The Master Frequency List	10
Rack-Mounting SLX Receivers	11
Receiver Volume Control	12
Tips for Improving System Performance	12
Troubleshooting	12
Specifications	13
Replacement Parts and Accessories	14
Microphone Specification	132
Frequency Ranges	135
Regulatory Statements	139

System Components

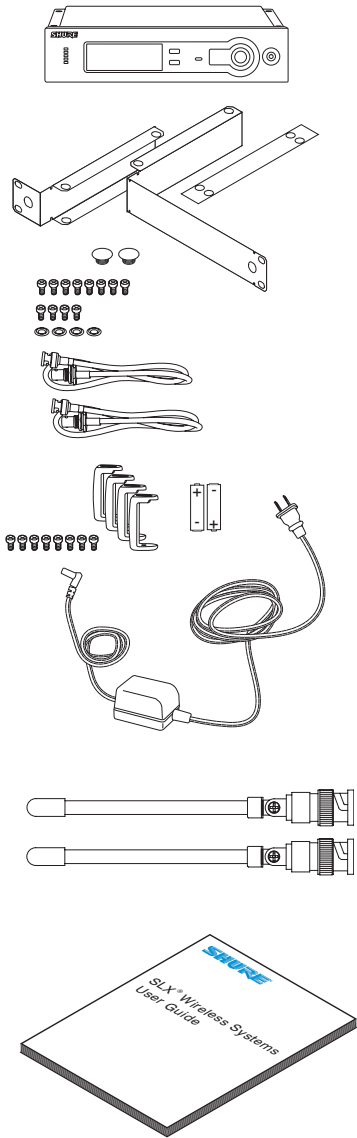

All systems include:

- SLX4 receiver
- Rack mount supplies
 - Short rack ear
 - Long rack ear
 - Link bar to mount to similar receiver
 - Extension cables and connectors for front-mounting antennas
 - 8 rack ear screws
 - 4 rack mount screws with washers
 - 2 antenna hole plugs
- Protective bumpers with 8 screws
- 2 AA batteries (4 in combo systems)
- Power supply
- 2 1/4 Wave Antennas
- User guide

Vocalist system includes:

- Microphone Head ① (choice of SM58®, SM86, Beta 58A®, Beta 87A™, or Beta 87C™)
- SLX2 handheld transmitter ②
- Microphone clip ③

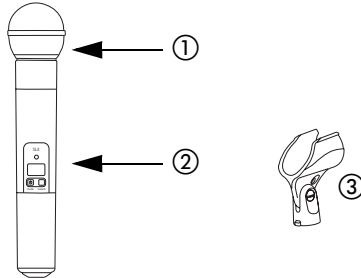

Lavalier, Headworn, and Instrument systems include:

- SLX1 bodypack transmitter
- Microphone (choice of WL93 ①, WL184 or WL185 ②, WH30 ③, or Beta 98H/C™ ④)

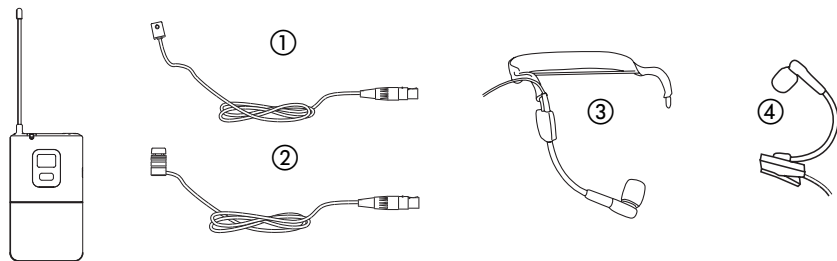

Guitar system includes:

- SLX1 bodypack transmitter
- 1/4" to mini 4-pin guitar cable

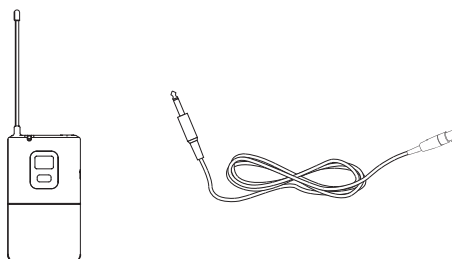

SLX4 Receiver Features

Front Panel

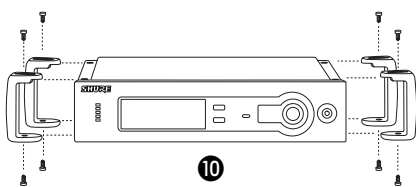
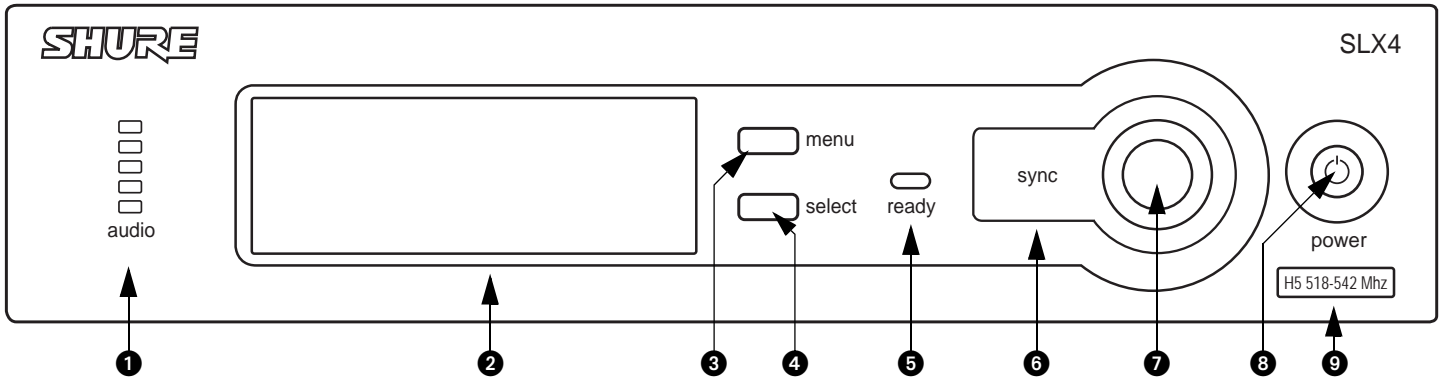

- 1** Audio LED
Indicates strength of incoming audio signal.
- 2** LCD panel
See “SLX Programming” on page 9.
- 3** Menu switch
Press to scroll through menu options. See “SLX Programming” on page 9.
- 4** Select switch
Press to select the currently displayed menu option. See “SLX Programming” on page 9.
- 5** Sync Ready Indicator
Illuminates when frequencies of receiver and transmitter are synchronized. See “SLX Programming” on page 9.
- 6** Infrared (IR) port
Broadcasts IR signal to transmitter to synchronize frequencies.
- 7** Sync Button
Press to initiate IR connection between receiver and transmitter. See “SLX Programming” on page 9.
- 8** On/Off switch
Tap to turn on, hold to turn off.
- 9** Frequency Band
Indicates the name and range of receiver frequency band.
- 10** Adding protective bumpers
Recommended if receiver is not rack mounted. Use supplied screws. For rack-mounting instructions, See “Rack-Mounting an SLX Receiver” on page 11.

Back Panel

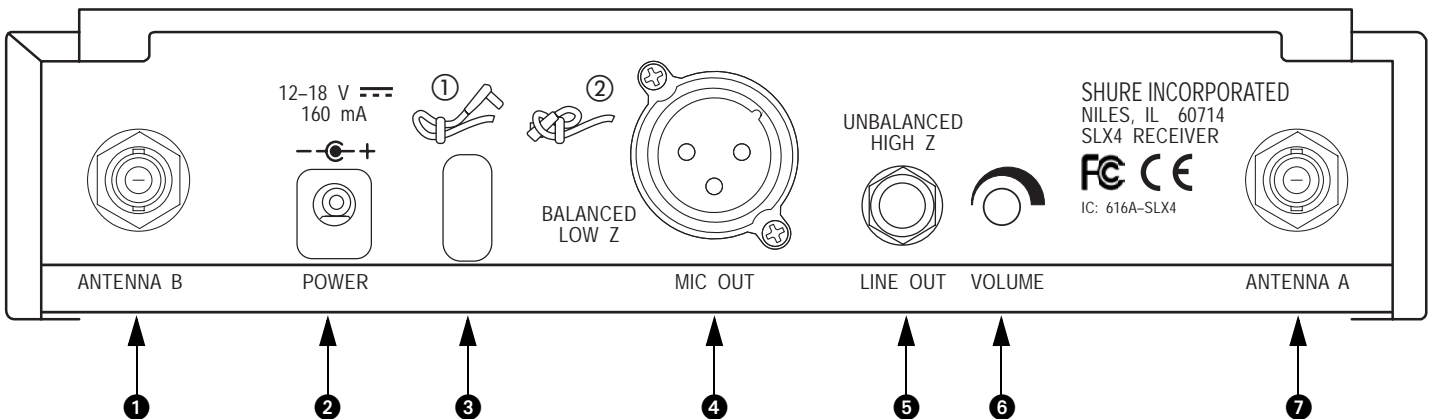

- 1** Antenna jack B
- 2** AC adapter jack
- 3** Adapter cord tie-off
Follow steps shown to secure cord to receiver body
- 4** XLR output jack
- 5** 1/4" output jack
- 6** Volume adjustment dial
Decreases receiver output level. See “Receiver Volume Control” on page 12.
- 7** Antenna jack A

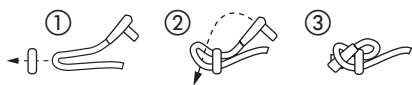

SLX2 Handheld Transmitter

Features

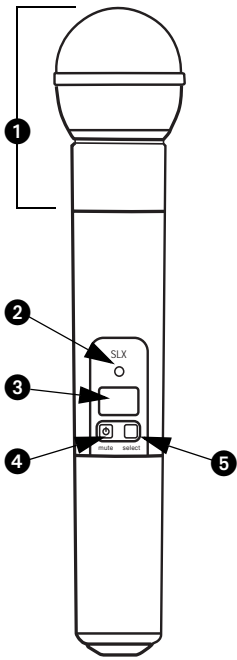

- ① Interchangeable microphone head (SM58 pictured)
- ② Power / Infrared (IR) / Mute indicator
Green: ready
Amber: mute on
Flashing red: IR transmission in process
Glowing red: battery power low
Pulsing red: battery dead (transmitter cannot be turned on until batteries are changed)
- ③ LCD screen
See "SLX1 and SLX2 Transmitter Programming" on page 10.
- ④ On-off / mute switch
Press and hold to turn on or off. Press and release to mute or unmute.

▶ **To avoid accidentally muting the microphone during a performance, lock the front panel while the microphone is in use.** See "Lock or Unlock Transmitter Settings" on page 10.

- ⑤ Select switch
See "SLX1 and SLX2 Transmitter Programming" on page 10.
- ⑥ IR port
Receives infrared beam to synchronize frequencies. **When using multiple systems, only one transmitter IR port should be exposed at a time.**

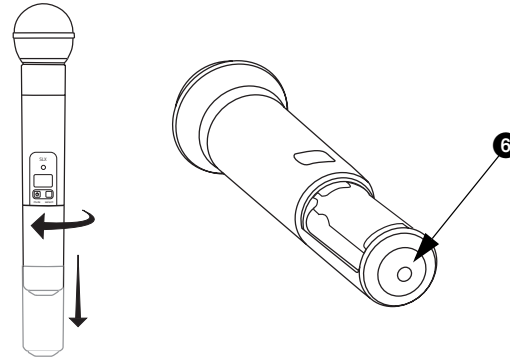
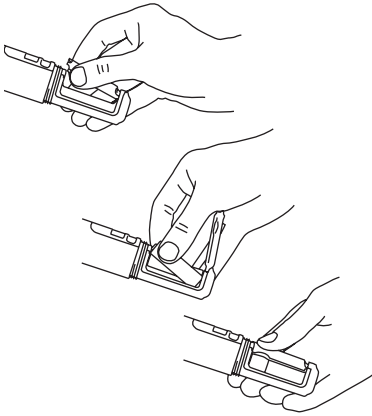

Changing Batteries

- Expected life for an Alkaline battery is approximately 8 hours.
- When the transmitter light glows red, the batteries should be changed immediately, as shown on the left.

Adjusting Gain

- Access the gain adjustment switch ① by unscrewing the head of the microphone.
- Two gain settings ② are available on the SLX2. Choose a setting appropriate for vocal volume and for the performing environment. Use the tip of a pen or a small screwdriver to move the switch.
 - **0dB:** For quiet to normal vocal performance.
 - **-10dB:** For loud vocal performance.

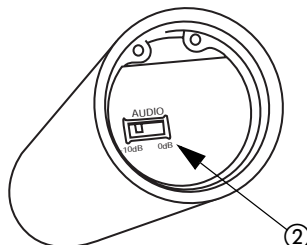
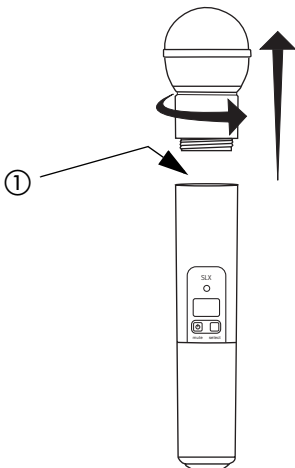

SLX1 Bodypack Transmitter

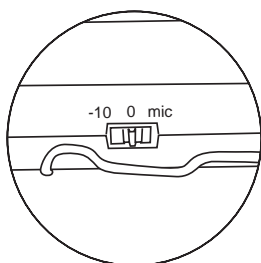
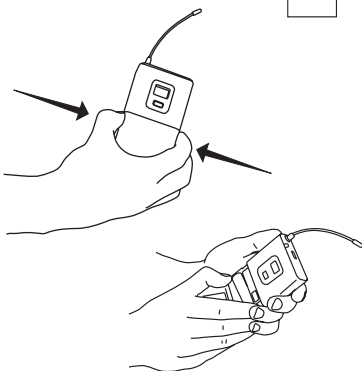
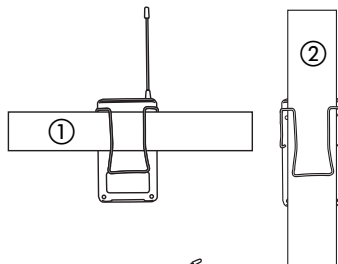
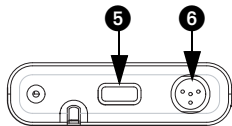
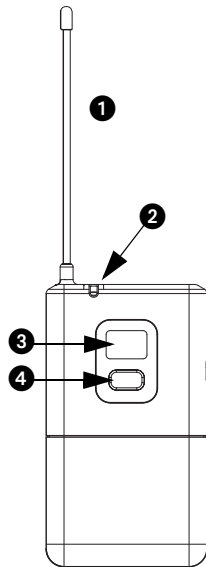

Features

- ❶ Antenna
- ❷ Power / Infrared (IR) / Mute indicator
 - Green: ready
 - Amber: mute on
 - Flashing red: IR transmission in process
 - Glowing red: battery power low
 - Pulsing red: battery dead (transmitter cannot be turned off until batteries are changed)
- ❸ LCD screen
 - See "SLX1 and SLX2 Transmitter Programming" on page 10.
- ❹ Select switch
 - See "SLX1 and SLX2 Transmitter Programming" on page 10.
- ❺ On-off / mute switch
 - Press and hold to turn on or off. Press and release to mute or unmute.
- ❻ 4-Pin Microphone Input Jack
- ❼ IR port
 - Receives infrared beam to synchronize frequencies. **When using multiple systems, only one transmitter IR port should be exposed at a time.**
- ❽ Gain adjustment switch (see below)

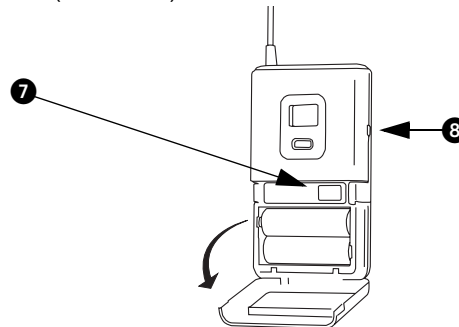

Wearing the Bodypack Transmitter

- Clip the transmitter to a belt ❶ or slide a guitar strap through the transmitter clip ❷ as shown.
- For best results, slide the transmitter until the belt ❶ is pressed against the base of the clip.

Changing Batteries

- Expected life for an Alkaline battery is approximately 8 hours.
- When the transmitter light glows red, the batteries should be changed immediately, as shown on the left.

Adjusting Gain

- Three gain settings are available on the SLX1. Choose the appropriate setting for your instrument.
 - **mic**: Microphone (higher amplification)
 - **0**: Guitar with passive pickups (medium amplification)
 - **-10**: Guitar with active pickups (lower amplification)
- If the receiver LED indicates the input volume is overloading the receiver, try switching the gain to a lower setting.

Single System Setup

Note: transmitting devices such as cellular phones and two-way radios may interfere with wireless audio transmissions. Keep your SLX transmitters and receivers away from these and other potential sources of interference.

Follow these steps when using a single SLX system:



1. Automatic Frequency Selection ① menu ② select

Scans for an available channel and sets the receiver to that channel.

2. Automatic Transmitter Setup sync

Turn **On** the transmitter.

Open the transmitter battery compartment to display the infrared (IR) port (see [page 6](#) and [page 7](#)).

With the IR port exposed to the receiver, press **sync**.

Hold the **sync** button until the red light stops flashing on both receiver and transmitter.

When the receiver **ready** light glows, the system is ready for use. Close the transmitter battery compartment.

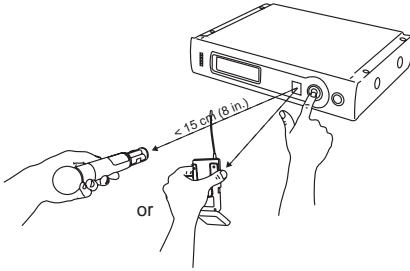

Multiple System Setup

Follow these steps when using multiple SLX systems in a single installation:

1. Turn all receivers **on** and all transmitters **off**.
2. Set all receivers to the same frequency group (see "[Group Selection](#)" on [page 9](#)).
3. Perform **Automatic Frequency Selection** from the Single System Setup section above.
4. Turn on the first transmitter.
5. Perform **Automatic Transmitter Setup** from the Single System Setup section above.

Repeat for each system.

▶ **Be sure that only one transmitter's IR port is exposed when synchronizing a system.**

SLX Programming

Any option displayed on screen will generally “time out” after five seconds.

SLX4 Receiver Programming



Group Selection ① 2x menu ② select ③ sync

Allows manual selection of a frequency group. Pressing **select** increases the group number by one. When the correct frequency is displayed, either wait five seconds for the screen to time out, or press **sync**. For best results when operating multiple systems, set all systems to a single group; then set each system to a unique channel within that group.

For more information on frequency groups and channels, see “[Frequency Band Selection](#)” on [page 2](#).



Manual Channel Selection ① 3x menu ② select ③ sync

Allows manual selection of a frequency channel. Pressing **select** increases the channel number by one. When the correct frequency is displayed, either wait five seconds for the screen to time out, or press **sync**.



Display Frequency ① 4x menu ② select

Displays the current frequency in MHz for approximately 5 seconds. Press and hold to increase display length.



Lock or Unlock Receiver Settings select + menu

Hold down the **select** key and press **menu** to lock or unlock the receiver. When locked, the current receiver settings cannot be changed.



Antenna Status

Indicates RF activity. Only one antenna is active at any one time.



Transmitter Battery Status

Indicates a low transmitter battery charge.



Full Group Warning

The **FULL** warning indicates that all available channels in the currently selected group are in use. When this occurs, reprogram all systems to an alternate group.

Press either the **menu** or **select** button to exit the warning screen.

SLX1 and SLX2 Transmitter Programming

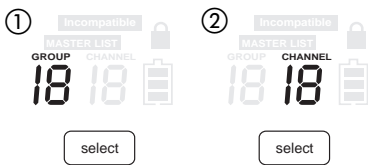

Manually Select a Group and/or Channel

1. Press and hold the **select** button until the **GROUP** and **CHANNEL** displays begin to alternate.
2. To change the group setting, release the **select** button while **GROUP** is displayed ①. While **GROUP** is flashing, pressing **select** increases the group setting by one.
3. To change the channel setting, release the **select** button while **CHANNEL** is displayed ②. While **CHANNEL** is flashing, pressing **select** increases the channel setting by one.

Lock or Unlock Transmitter Settings +

Press the **mute/⏏** and **select** buttons simultaneously to lock or unlock the transmitter settings. When locked, the current settings cannot be changed manually. **Locking the transmitter does not disable infrared synchronization.**

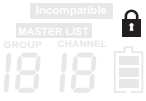

Battery Status

Indicates charge remaining in transmitter batteries.



Master List Indicator

Indicates that a master list frequency is currently in use. No group or channel information is displayed.

Note: the transmitter cannot be used to change master list settings.

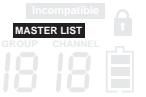

INCOMPATIBLE Frequency Warning

The **INCOMPATIBLE** warning indicates that the receiver and transmitter are set to incompatible frequency bands. Contact your Shure retailer for assistance.



The Master Frequency List

Using the Master List +

The “Master List” of frequencies should be accessed only by experienced users in situations which call for precise frequency selection. The “Master List” is a comprehensive index of all available frequencies in 25 kHz increments. (125 kHz increments in the JB band.)

To access the Master List, hold down the **menu** button while powering on the SLX receiver.



Select Frequencies in the Master List ① ② ③ ↑ ↓ ④

While **FREQUENCY SELECT** is flashing, the **select** button scrolls down through all available frequencies; the **menu** button scrolls up. Press and release to change the frequency in 25 kHz increments; press and hold to scroll quickly.

When the correct frequency is displayed, either wait five seconds for the screen to time out, or press **sync**.



Exit the Master List ① 2x ②

To exit the Master List and return to normal system operations, press **menu**, then **select**.



Rack-Mounting an SLX Receiver

The supplied mounting hardware allows an SLX receiver to be mounted in any standard 19" audio equipment rack.

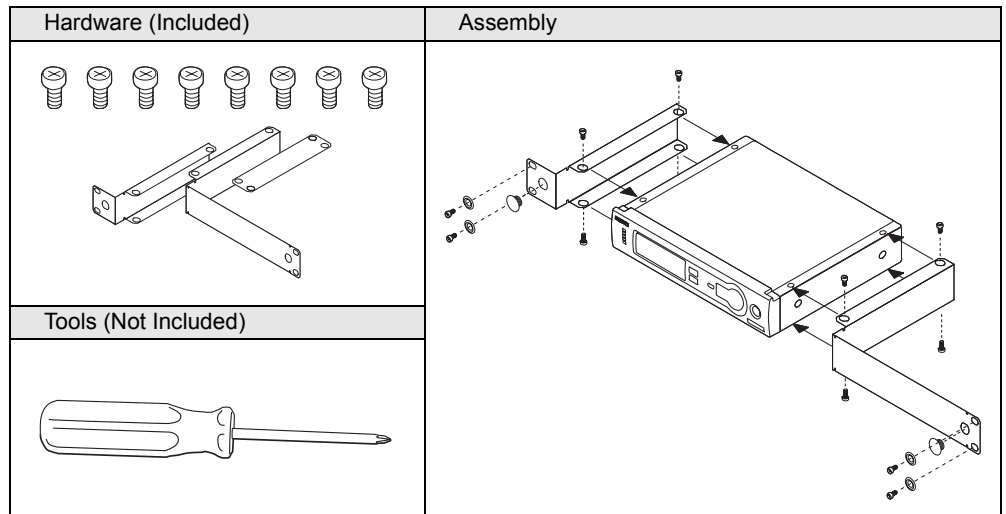

Rack-Mounting SLX Receivers

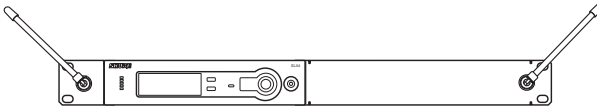
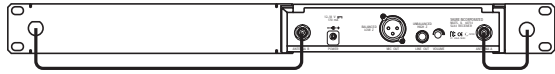
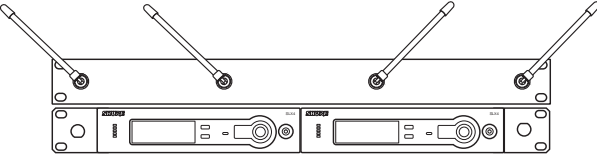
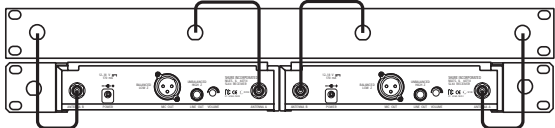
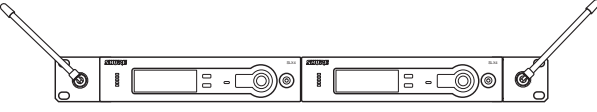
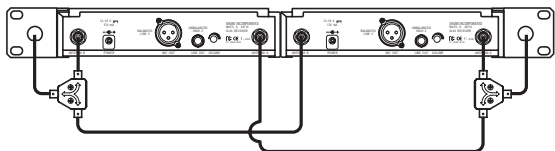
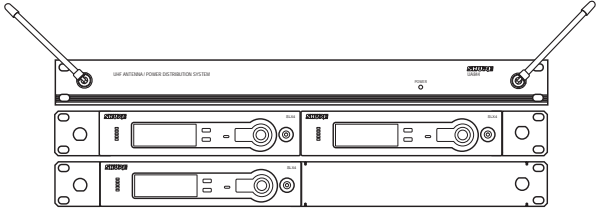
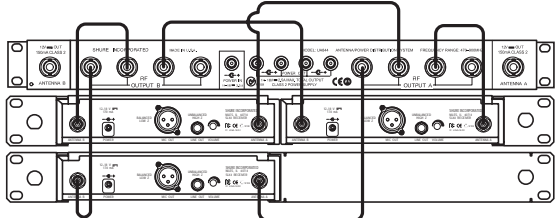
One Receiver	Wiring	Required Accessories
		<ul style="list-style-type: none"> All accessories supplied
<p>Two Receivers</p> 		<ul style="list-style-type: none"> 1 x UA440
<p>Two Receivers with UA221 Antenna Splitter/Combiner Kit</p> 		<ul style="list-style-type: none"> 1 x UA221
<p>Three or Four Receivers</p> 		<ul style="list-style-type: none"> 1 x UA844

Receiver Volume Control

The volume control dial should generally be left in the clockwise position. Turning the dial counter-clockwise decreases receiver output level.

If adjustments are necessary, use a small screwdriver to turn the dial.

Tips for Improving System Performance

- Maintain a line of sight between transmitter and antenna
- Avoid placing the receiver near metal surfaces or any digital equipment (CD players, computers, etc.)
- Secure the AC adapter cable to the receiver using the cable retainer loop
- If rack-mounting the receiver, front-mount the antennas as shown on [page 11](#).

Troubleshooting

Issue	Indicator Status	Solution
No sound or faint sound	Transmitter power light off	<ul style="list-style-type: none"> • Turn transmitter on (see pages 6 and 7) • Make sure the +/- indicators on battery match the transmitter terminals • Insert a fresh battery
	Receiver LCD off	<ul style="list-style-type: none"> • Make sure AC adapter is securely plugged into electrical outlet and into DC input connector on rear panel of receiver • Make sure AC electrical outlet works and is supplying proper voltage
	Receiver display indicates antenna activity	<ul style="list-style-type: none"> • Press mute switch on transmitter (see pages 6 and 7) • Turn up receiver volume control (see page 5) • Increase transmitter gain switch setting (see pages 6 and 7) • Check cable connection between receiver and amplifier or mixer
	Receiver display indicates no antenna activity; transmitter and receiver power lights glowing	<ul style="list-style-type: none"> • Extend receiver antennas vertically • Move receiver away from metal objects • Check for line of sight between transmitter and receiver • Move transmitter closer to receiver • Check that receiver and transmitter are using the same frequency
	Transmitter power light glowing or flashing red	<ul style="list-style-type: none"> • Replace transmitter batteries
	INCOMPATIBLE warning on transmitter	<ul style="list-style-type: none"> • The INCOMPATIBLE warning indicates that the receiver and transmitter are set to incompatible frequency bands. Contact your Shure retailer for assistance.
Distortion or unwanted noise bursts	Receiver display indicates antenna activity	<ul style="list-style-type: none"> • Remove nearby sources of RF interference (CD players, computers, digital effects, in-ear monitor systems, etc.) • Change receiver and transmitter to a different frequency (see page 9) • Reduce transmitter gain (see pages 6 and 7) • Replace transmitter battery • If using multiple systems, increase the frequency spread between systems (see page 9).
Distortion level increases gradually	Transmitter power light glowing or flashing red	<ul style="list-style-type: none"> • Replace transmitter batteries
Sound level different from cabled guitar or microphone, or when using different guitars		<ul style="list-style-type: none"> • Adjust transmitter gain (see pages 6 and 7) and receiver volume (see page 5) as necessary
FULL warning displays on receiver		<ul style="list-style-type: none"> • The FULL warning indicates that all available channels in the currently selected group are in use. When this occurs, reprogram all systems to an alternate group.
Cannot turn transmitter off	Transmitter light flashing red	<ul style="list-style-type: none"> • Replace transmitter batteries

Specifications

System

Frequency Range and Transmitter Output Level

Band	Range	Transmitter output
H5	518–542 MHz	30 mW
J3	572–596 MHz	30 mW
L4	638–662 MHz	30 mW
P4	702–726 MHz	30 mW
R13	794–806 MHz	20 mW
R5	800–820 MHz	20 mW
S6	838–865 MHz	10 mW
JB	806–810 MHz	10 mW
Q4	740–752 MHz	10 mW

NOTE: This Radio apparatus may be capable of operating on some frequencies not authorized in your region. Please contact your national authority to obtain information on authorized frequencies for wireless microphone products in your region.

Operating Range Under Typical Conditions

100m (300 ft.)

Note: actual range depends on RF signal absorption, reflection, and interference

Audio Frequency Response (+/- 2 dB)

Minimum: 45 Hz

Maximum: 15 kHz

(Overall system frequency depends on microphone element.)

Total Harmonic Distortion (ref. +/- 38 kHz deviation, 1 kHz tone)

0.5%, typical

Dynamic Range

>100 dB A-weighted

Operating Temperature Range

-18°C (0°F) to +57°C (+135°F)

Note: battery characteristics may limit this range

Transmitter Audio Polarity

Positive pressure on microphone diaphragm (or positive voltage applied to tip of WA302 phone plug) produces positive voltage on pin 2 (with respect to pin 3 of low impedance output) and the tip of the high impedance 1/4-inch output.

SLX1 Bodypack Transmitter

Audio Input Level

-10 dBV maximum at mic gain position

+10 dBV maximum at 0 dB gain position

+20 dBV maximum at -10 dB gain position

Gain Adjustment Range

30dB

Input Impedance

1 M Ω

RF Transmitter Output

30 mW maximum (dependent on applicable country regulations)

Dimensions

108 mm H x 64 mm W x 19 mm D (4.25 x 2.50 x 0.75 in.)

Weight

81 grams (3 oz.) without batteries

Housing

Molded ABS case

Power Requirements

2 "AA" size alkaline or rechargeable batteries

Battery Life

>8 hours (alkaline)

SLX2 Handheld Transmitter

Audio Input Level

+2 dBV maximum at -10dB position

-8 dBV maximum at 0dB position

Gain Adjustment Range

10dB

RF Transmitter Output

30 mW maximum (dependent on applicable country regulations)

Dimensions (including SM58 cartridge)

254 mm x 51 mm dia. (10 x 2 in.)

Weight

290 grams (10.2 oz.) without batteries

Housing

Molded PC/ABS handle and battery cup

Power Requirements

2 "AA" size alkaline or rechargeable batteries

Battery Life

>8 hours (alkaline)

SLX4 Receiver

Dimensions

42 mm H x 197 mm W x 134 mm D (1.65 x 7.76 x 5.28 in.)

Weight

816 g (1 lb. 13 oz.)

Housing

Galvanized steel

Audio Output Level (ref. +/- 38 kHz deviation with 1 kHz tone)

XLR connector (into 600 Ω load): -13 dBV

1/4 inch connector (into 3000 Ω load): -2 dBV

Output Impedance

XLR connector: 200 Ω

1/4 inch connector: 1k Ω

XLR output

Impedance balanced

Pin 1: Ground (cable shield)

Pin 2: Audio

Pin 3: No Audio

Sensitivity

-105 dBm for 12 dB SINAD, typical

Image Rejection

>70 dB, typical

Power Requirements

12–18 Vdc at 150 mA, supplied by external power supply

Replacement Parts and Accessories

Replacement Parts (all systems)

Microphone Stand Adapter (SLX2)	WA371
Zipper Bag (SLX1)	26A13
Zipper Bag (SLX2)	26A14
Short Rack Bar	53A8611
Long Rack Bar	53A8612
Link Bar	53B8443
Antenna extension cables (2)	95A9023
Protective Bumpers (SLX4 Receiver) (4)	90A8977

Replacement Parts (system-specific)

AC Adapter (120 VAC, 60 Hz)	PS20
AC Adapter (220 VAC, 50 Hz)	PS20AR
AC Adapter (230 VAC, 50/60 Hz, Europlug)	PS20E
AC Adapter (230 VAC, 50/60 Hz, UK)	PS20UK
AC Adapter (100 VAC, 50/60 Hz)	PS20J
SM58 Head with Grille (SLX2/SM58)	RPW112
SM86 Head with Grille (SLX2/SM86)	RPW114
BETA 58 Head with Grille (SLX2/BETA 58)	RPW118
BETA 87A Head with Grille (SLX2/BETA 87A)	RPW120
Beta 87C™ Head with Grille (SLX2/Beta 87C™)	RPW122
Matte Silver Grille (SLX2/SM58)	RK143G
Matte Silver Grille (SLX2/SM86)	RPM266
Matte Silver Grille (SLX2/BETA 58)	RK265G
Matte Silver Grille (SLX2/BETA 87A)	RK312
Matte Silver Grille (SLX2/Beta 87C™)	RK312
Belt Clip	44A8030
1/4-Wave Antenna (518–752 MHz)	UA400B
1/4-Wave Antenna (748–865 MHz)	UA400

Optional Accessories

Carrying Case	WA610
Black Grille (SLX2/BETA 58)	RK323G
Black Grille (SLX2/BETA 87A)	RK324G

Antenna Combiners and Accessories

Antennas and receivers must be from the same band.

The supplied 1/4 wave antennas can be used when mounted directly to the UA844. If antennas are remote mounted, 1/2 wave antennas must be used.

Antennas and cables are for use with UA844, and cannot be used with stand-alone SLX receivers.

Passive Antenna/Splitter Combiner Kit (recommended for 2 receivers)	UA221
UHF Antenna Power Distribution Amplifier (recommended for 3 or more receivers)	
U.S.A.	UA844US
Europe	UA844E
UK	UA844UK
1/2 Wave Antenna Remote Mount Kit	UA500
1/2 wave antenna	
H5 Band	UA820H
J3 Band	UA820F
L4 Band	UA820L
P4, Q4 Bands	UA820B
R13, R5, S6, JB Bands	UA820A
25' Antenna Cable	UA825
50' Antenna Cable	UA850
100' Antenna Cable	UA100

Microphone Specifications

WL183

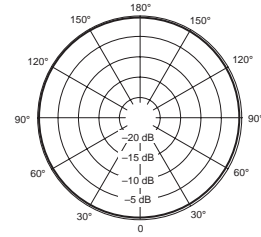
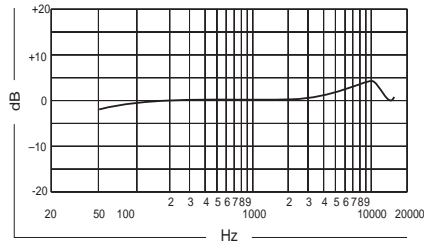

WL184

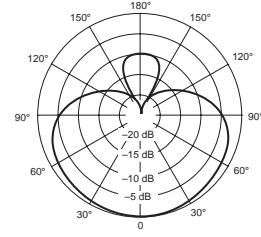
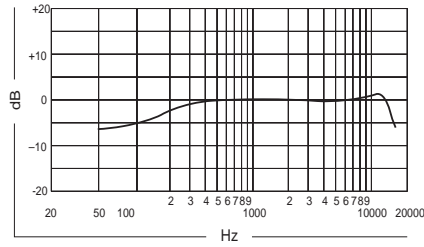

WL185

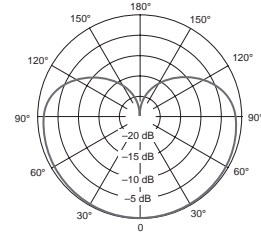
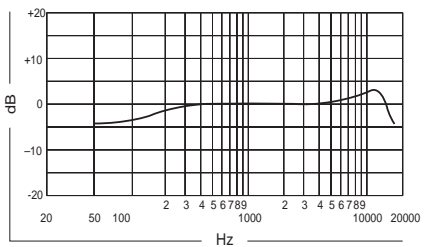

WL50

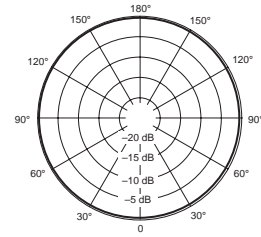
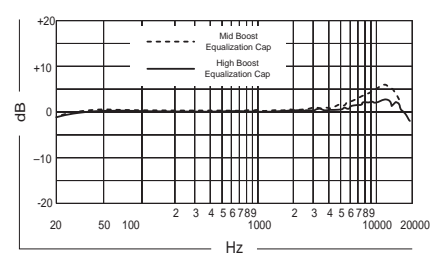

WL51

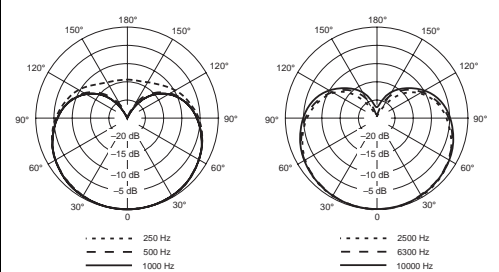
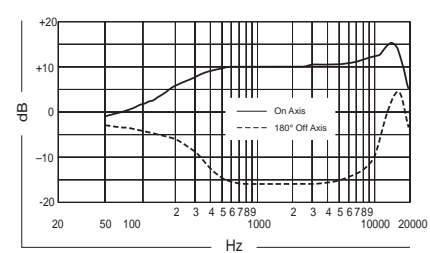

Microphone Specifications

WH20

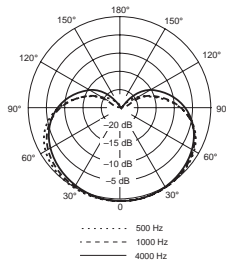
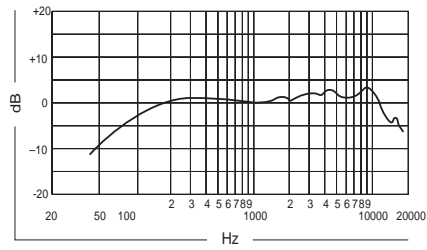

WH30

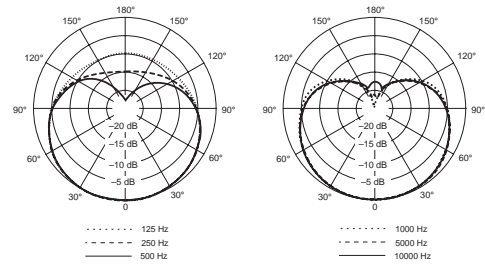
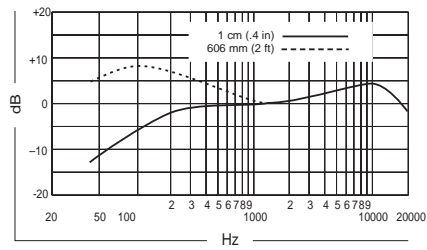

BETA98H/C

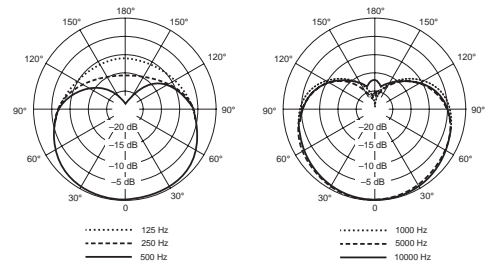
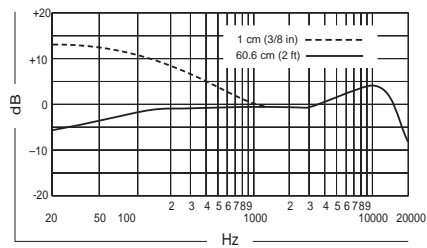

SM58

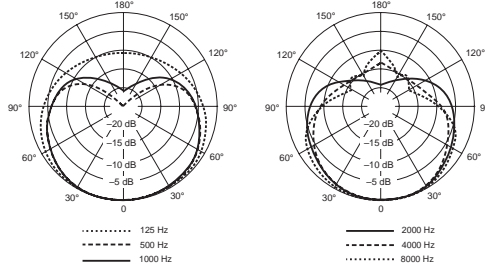
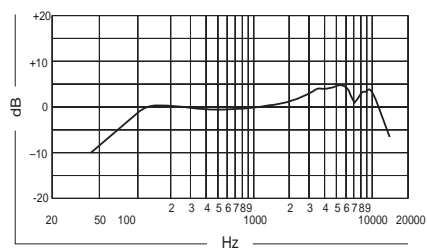

SM86

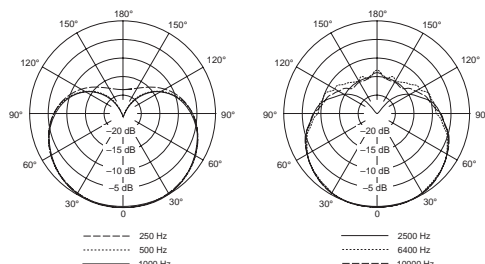
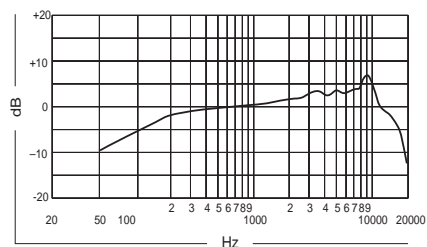

Microphone Specifications

BETA58

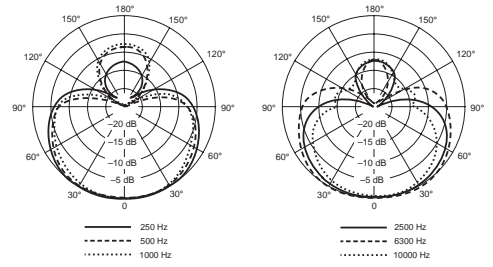
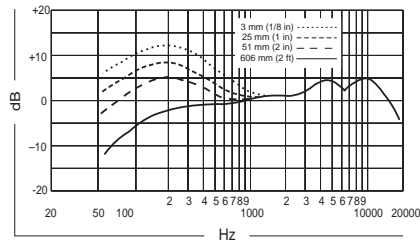

BETA87A

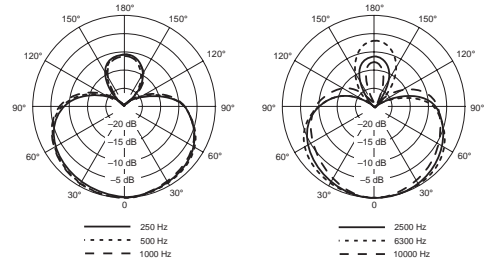
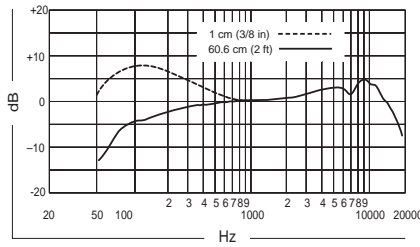

BETA87C

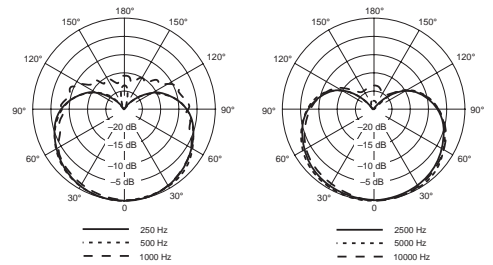
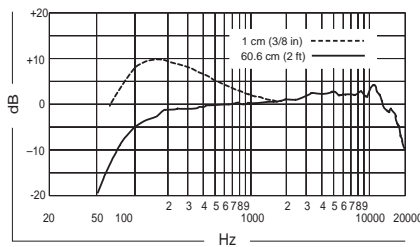

Frequency Ranges

H5: 518.000–542.000 MHz

	Group 1	Group 2	Group 3	Group 4	Group 5	Group 6
1	518.400	519.250	518.200	519.775	519.100	518.425
2	521.500	520.500	519.675	522.500	521.225	520.400
3	523.575	522.225	520.800	524.200	522.550	523.425
4	525.050	524.725	522.450	525.600	524.575	525.475
5	527.425	526.350	523.750	526.700	526.900	527.775
6	529.200	527.550	526.200	528.250	530.500	531.675
7	532.450	530.800	528.325	529.500	531.750	533.800
8	533.650	532.575	532.225	533.100	533.300	536.250
9	535.275	534.950	534.525	535.425	534.400	537.550
10	537.775	536.425	536.575	537.450	535.800	539.200
11	539.500	538.500	539.600	538.775	537.500	540.325
12	540.750	541.600	541.575	540.900	540.225	541.800
	Full Range - even distribution for each TV-CH	Full Range - even distribution for each TV-CH	Full Range - max. # of frequencies for CH- 22	Full Range - max. # of frequencies for CH- 23	Full Range - max. # of frequencies for CH- 24	Full Range - max. # of frequencies for CH- 25

J3: 572.000–596.000 MHz

	Group 1	Group 2	Group 3	Group 4	Group 5	Group 6
1	572.400	573.250	572.200	573.775	573.100	572.425
2	575.500	574.500	573.675	576.500	575.225	574.400
3	577.575	576.225	574.800	578.200	576.550	577.425
4	579.050	578.725	576.450	579.600	578.575	579.475
5	581.425	580.350	577.750	580.700	580.900	581.775
6	583.200	581.550	580.200	582.250	584.500	585.675
7	586.450	584.800	582.325	583.500	585.750	587.800
8	587.650	586.575	586.225	587.100	587.300	590.250
9	589.275	588.950	588.525	589.425	588.400	591.550
10	591.775	590.425	590.575	591.450	589.800	593.200
11	593.500	592.500	593.600	592.775	591.500	594.325
12	594.750	595.600	595.575	594.900	594.225	595.800
	Full Range - even distribution for each TV-CH	Full Range - even distribution for each TV-CH	Full Range - max. # of frequencies for CH- 31	Full Range - max. # of frequencies for CH- 32	Full Range - max. # of frequencies for CH- 33	Full Range - max. # of frequencies for CH- 34

L4: 638.000–662.000 MHz

	Group 1	Group 2	Group 3	Group 4	Group 5	Group 6
1	638.400	639.250	638.200	639.775	639.100	638.425
2	641.500	640.500	639.675	642.500	641.225	640.400
3	643.575	642.225	640.800	644.200	642.550	643.425
4	645.050	644.725	642.450	645.600	644.575	645.475
5	647.425	646.350	643.750	646.700	646.900	647.775
6	649.200	647.550	646.200	648.250	650.500	651.675
7	652.450	650.800	648.325	649.500	651.750	653.800
8	653.650	652.575	652.225	653.100	653.300	656.250
9	655.275	654.950	654.525	655.425	654.400	657.550
10	657.775	656.425	656.575	657.450	655.800	659.200
11	659.500	658.500	659.600	658.775	657.500	660.325
12	660.750	661.600	661.575	660.900	660.225	661.800
	Full Range - even distribution for each TV-CH	Full Range - even distribution for each TV-CH	Full Range - max. # of frequencies for CH- 42	Full Range - max. # of frequencies for CH- 43	Full Range - max. # of frequencies for CH- 44	Full Range - max. # of frequencies for CH- 45

Frequency Ranges

P4: 702.000–726.000 MHz

	Group 1	Group 2	Group 3	Group 4	Group 5	Group 6	Group 7	Group 8
1	702.200	703.750	703.650	702.750	703.750	702.100	704.775	702.300
2	704.200	705.975	705.650	704.500	705.750	704.025	706.225	704.975
3	707.200	707.200	708.650	705.750	708.250	705.500	710.500	706.775
4	709.425	708.850	710.875	708.250	711.750	708.500	712.025	709.100
5	711.000	710.950	712.450	711.250	714.500	710.100	714.225	710.300
6	713.675	712.425	715.125	712.500	715.750	712.025	716.900	712.225
7	715.575	714.325	717.025	715.250	718.750	713.500	718.500	714.775
8	717.050	717.000	718.500	718.750	721.250	717.300	720.775	716.700
9	719.150	718.575	720.600	721.250	722.500	725.300	725.300	724.000
10	720.800	720.800	722.250	723.250	724.250			725.900
11	722.025	723.800	723.475					
12	724.250	725.800	725.700					
	Full Range - max. # of compatible frequencies	Full Range - max. # of compatible frequencies	Full Range - max. # of compatible frequencies	France preferred: User Group A	France preferred: User Group A	France preferred: User Group B	France preferred: User Group B	France preferred: User Group C)

	Group 9	Group 10	Group 11	Group 12	Group 13	Group 14	Group 15	Group 16
1	703.000	702.200	710.200	718.200	702.550	702.100	702.700	702.500
2	706.025	703.300	711.300	719.300	705.600	704.700	704.700	705.500
3	708.000	704.700	712.700	720.700	707.500	710.300	709.450	707.000
4	710.300	705.800	713.800	721.800	709.000	712.400	711.500	712.200
5	712.225	707.675	715.675	723.675	711.500	714.000	714.500	714.100
6	716.000	708.775	716.775		715.100	716.500	716.550	716.400
7	717.100				717.000	719.400	719.900	719.500
8	719.000				720.000	721.300	722.000	722.200
9	720.225				723.500		724.700	
10	722.775				725.900		725.900	
11	724.700							
	France preferred: User Group C	Optimized TV channels: TV ch. 50 702-710 MHz	Optimized TV channels: TV ch. 51 710-718 MHz	Optimized TV channels: TV ch. 52 718-724 MHz	Compatible setup for use with PSM400-P3 (P4 > P3)	Compatible setup for use with PSM400-P3 (P4 = P3)	Compatible setup for use with PSM400-HF (P4 > HF)	Compatible setup for use with PSM400-HF (P4 = HF)

Frequency Ranges

R5: 800.100–819.900 MHz

	Group 1	Group 2	Group 3	Group 4	Group 5	Group 6	Group 7
1	801.250	801.225	800.950	800.525	801.475	800.600	800.650
2	804.825	804.800	802.950	801.925	803.025	802.050	803.125
3	806.975	806.950	804.325	803.650	805.800	804.275	804.450
4	808.800	808.775	806.425	804.850	806.950	805.750	806.150
5	810.325	810.300	808.050	807.400	809.125	806.850	807.250
6	811.550	811.525	809.275	808.525	810.575	808.550	808.725
7	813.175	813.150	810.800	810.275	811.725	809.875	810.950
8	815.275	815.250	812.625	811.550	813.800	812.350	812.400
9	816.650	816.625	814.775	813.775		813.450	813.500
10	818.650	818.625	818.350				
11	819.750	819.800	819.775				
	Full Range - max. # of comp. Frequencies & FIN / NOR / DEN	Full Range - max. # of comp. Frequencies & FIN / NOR / DEN	Full Range - max. # of comp. Frequencies & FIN / NOR / DEN	Germany preferred: User Group 4 800-814 MHz	Germany preferred: User Group 4 800-814 MHz	Sweden preferred: 800-814 MHz	Sweden preferred: 800-814 MHz

	Group 8	Group 9	Group 10	Group 11	Group 12	Group 13	Group 14
1	806.000	806.025	801.400	800.900	801.200	803.850	806.150
2	807.100	807.425	808.300	802.100	803.800	807.000	811.650
3	808.500	808.525	816.400	806.200	805.900	809.700	814.400
4	809.600	810.400		809.300	807.000	811.050	816.500
5	811.475	811.500		814.100	809.200	813.900	817.450
6	812.575	812.900		816.100	811.700	816.500	819.300
7	813.975	814.000		817.200		817.600	
8				819.600		819.500	
	Netherlands preferred: TV ch. 63 806-814 MHz	Netherlands preferred: TV ch. 63 806-814 MHz	Compatible setup for use with EUT-TL-TV (R5 > TL-TV)	Compatible setup for use with PSM400-MN (R5 > MN)	Compatible setup for use with PSM400-MN (R5 = MN)	Compatible setup for use with PSM200-R8 (R5 > R8)	Compatible setup for use with PSM200-R8 (R5 = R8)

Frequency Ranges

S6: 838.000–865.000 MHz

	Group 1	Group 2	Group 3	Group 4	Group 5	Group 6	Group 7	Group 8
1	838.200	838.150	838.550	854.200	855.475	855.075	854.750	854.750
2	841.450	839.375	839.775	855.300	857.425	857.775	855.850	855.850
3	843.275	841.300	841.700	856.700	860.600	860.725	857.250	857.250
4	846.225	842.475	842.875	857.800			858.350	858.350
5	847.350	846.400	846.800	859.675			860.225	860.225
6	850.125	848.025	848.425	860.775			861.325	861.325
7	852.575	850.025	850.425					
8	854.575	852.475	852.875					
9	856.200	855.250	855.650					
10	860.125	856.375	856.775					
11	861.300	859.325	859.725					
12	863.225	861.150	861.550					
13	864.450	864.400	864.800					
	Full Range - max. # of compatible frequencies	Full Range - max. # of compatible frequencies	Full Range - max. # of compatible frequencies	BEL / TUR preferred: opt. TV ch.69 854-862 MHz	U.K. preferred: "CH69 Co-ordinated" SET 1	U.K. preferred: "CH69 Co-ordinated" SET 2 or SET 3	U.K. preferred: "Co-ordinated frequencies" INDOORS	U.K. preferred: "Co-ordinated frequencies" OUTDOORS

	Group 9	Group 10	Group 11	Group 12	Group 13	Group 14	Group 15
1	854.425	863.200	838.200	838.900	838.100	838.700	838.400
2	855.525	864.500	839.900	842.600	841.100	842.800	840.600
3	857.400		841.000	845.900	842.700	844.800	842.100
4	858.500		842.375	847.500	847.000	846.300	844.700
5	859.900		844.400	848.600	849.200	847.400	846.600
6	861.000		846.100	850.100	850.400	849.200	848.100
7			847.350	852.100	852.500	851.300	850.700
8			849.400	853.300	854.100		851.850
9			851.800	855.100	855.300		853.700
10			853.200	857.200			
11				858.650			
12				859.800			
13				861.900			
	U.K. preferred: "Co-ordinated frequencies" OUTDOORS	European harmonized band: optimized for 863 - 865 MHz	Compatible setup for use with EUT-TW-TZ (S6 > TW-TZ)	Compatible setup for use with EUT-VR-VT (S6 > VR-VT)	Compatible setup for use with PSM400-KE (S6 > KE)	Compatible setup for use with PSM400-KE (S6 = KE)	Compatible setup for use with PSM200-S5 (S6 > S5)

Frequency Range**Q4: 740.000–752.000 MHz**

	Group 1	Group 2	Group 3	Group 4
1	740.125	740.125	740.125	740.125
2	741.500	741.950	741.225	740.800
3	743.375	743.500	742.925	741.825
4	744.600	745.675	744.325	743.075
5	746.325	747.400	745.425	745.125
6	748.500	748.625	746.875	746.575
7	750.050	750.500	748.925	747.675
8	751.875	751.875	750.175	749.075
9			751.200	750.775
10			751.875	751.875
	Full Range	Full Range	Full Range	Full Range

Frequency Range**JB: 806.000–810.000 MHz**



	Group 1	Group 2	Group 3	Group 4	Group 5	Group 6
1	806.250	806.375	806.125	806.500	806.125	806.250
2	807.500	808.625	807.375	807.375	807.375	807.250
3	809.625	809.750	809.500	808.625	808.375	808.500
4				809.625	809.750	809.375
	Full Range	Full Range	Full Range	Full Range	Full Range	Full Range

Frequency Ranges**R13: 794.000–806.000 MHz**

	GROUP 1	GROUP 2	GROUP 3	GROUP 4
1	795.150	794.375	794.100	794.900
2	796.850	795.600	795.300	796.100
3	798.100	797.425	797.200	798.000
4	800.750	799.725	798.550	799.350
5	802.200	803.025	800.625	801.425
6	805.350	804.475	802.150	802.950
7			803.350	804.150
8			804.925	805.725
	Full Range	Full Range	Full Range	Full Range

Regulatory and Licensing Information

SLX1 & SLX2 Transmitters:

Type Accepted under FCC Parts 74 (FCC ID: "DD4SLX1" & "DD4SLX2"). Certified by IC in Canada under RSS-123 and RSS-102 ("IC: 616A-SLX1" and "IC: 616A-SLX2"). Meets the essential requirements of the European R&TTE Directive 99/5/EC (ETSI EN 300-422 Parts 1 & 2, EN 301 489 Parts 1 & 9) and is eligible to carry the CE marking.  0682 

SLX4 Receiver:

Conforms to Australian EMC requirements and is eligible for C-Tick marking.  N108

Authorized under the Declaration Of Conformity provision of FCC Part 15 as a Class B Digital device. Certified under Industry Canada to RSS-123 ("IC: 616A-SLX4"). Meets the essential requirements of the European R&TTE Directive 99/5/EC (EN 301 489 Parts 1 & 2, EN 300 422 Parts 1 & 2) and is eligible to carry the CE marking. 

PS 20 Series Power Supplies:

Conform to Safety Standard IEC 60065. PS20E and PS20UK are eligible to bear CE marking.

PS20AR: Conforms to Safety Standard IEC 60065. Certified TÜV Rheinland Argentina, S.A. No. RA2681022.

A ministerial license may be required to operate this equipment in certain areas. Consult your national authority for possible requirements.

This radio equipment is intended for use in musical professional entertainment and similar applications.

Les transmetteurs modèle Shure SLX1 et SLX2 :

Type accepté sous FCC partie 74 (FCC ID : « DD4SLX1 » et « DD4SLX2 »). Certifié par IC au Canada sous RSS-123 et RSS-102. Conforme aux exigences essentielles de la directive européenne R&TTE 99/5/CE (ETSI EN 300 422, partie 1 et 2, ETSI EN 301 489, partie 1 et 9) et sont autorisés à porter la marque CE.

Le récepteur modèle Shure SLX4 :

Conforme aux exigences CEM australiennes, autorisé à porter la marque C-Tick.

Autorisé aux termes de la clause de Déclaration de conformité de la FCC section 15 comme appareil numérique de classe B. Certifié par IC au Canada sous RSS-123 (« IC: 616A-SLX4 »). Conforme aux exigences essentielles de la directive européenne R&TTE 99/5/CE (ETSI EN 300 422, partie 1 et 2, ETSI EN 301 489, partie 1 et 9) et sont autorisés à porter la marque CE.

Les blocs d'alimentation PS20E et PS20UK :

Conforme aux spécifications IEC 60065 et sont autorisés à porter la marque CE.

PS20AR : Conforme aux spécifications IEC 60065. Certifié TÜV Rheinland Argentina, S.A., No. RA2681022.

Autorisation d'utilisation : Une licence officielle d'utilisation de ce matériel peut être requise dans certains pays. Consulter les autorités compétentes pour les exigences possibles.

Ce matériel radio est prévu pour une utilisation en spectacles musicaux professionnels et applications similaires.

Regulatory and Licensing Information

Die Senders Modells SLX1 und SLX2:

Typenzulassung unter FCC Teil 74 (FCC ID: „DD4SLX1“ und „DD4SLX2“). Zugelassen durch die IC in Kanada unter RSS-123 und RSS-102. Entsprechen den Grundanforderungen der europäischen R&TTE-Richtlinie 99/5/EC (ETSI-Normen EN 300 422, Teile 1 und 2, ETSI-Normen EN 301 489, Teile 1 und 9) und sind zum Tragen des CE-Zeichens berechtigt.

Der Empfänger Modell SLX4:

Entspricht den Anforderungen für elektromagnetische Verträglichkeit von Australien, ist berechtigt zur C-Tick-Kennzeichnung.

Zugelassen unter der Übereinstimmungserklärung der FCC, Teil 15, als digitales Gerät der Klasse B. Zugelassen durch die IC in Kanada unter RSS-123 („IC: 616A-SLX4“). Entsprechen den Grundanforderungen der europäischen R&TTE-Richtlinie 99/5/EC (ETSI-Normen EN 300 422, Teile 1 und 2, ETSI-Normen EN 301 489, Teile 1 und 9) und sind zum Tragen des CE-Zeichens berechtigt.

Der netzteilen Modells PS20E und PS20UK:

Entsprechen den Grundanforderungen IEC 60065 und sind zum Tragen des CE-Zeichens berechtigt.

PS20AR: Entsprechen den Grundanforderungen IEC 60065. Bestätigt TÜV Rheinland Argentina, S.A., No. RA2681022.

Zulassung: In einigen Gebieten ist für den Betrieb dieses Geräts u.U. eine behördliche Zulassung erforderlich. Wenden Sie sich bitte an die zuständige Behörde, um Informationen über etwaige Anforderungen zu erhalten.

Diese Funkausrüstung ist zum Gebrauch bei professionellen Musikveranstaltungen und ähnlichen Anwendungen vorgesehen.

Los transmisores modelos SLX1 y SLX2:

Aceptado por especimen bajo las normas de la FCC (Comisión Federal de Comunicaciones de los EE.UU.) (FCC ID: "DD4SLX1" y "DD4SLX2"). Certificados en Canadá por la IC bajo la norma RSS-123 y RSS-102. Cumple con los requisitos esenciales de la directriz europea 99/5/EC de RTTE (ETSI EN 300-422, partes 1 y 2, ETSI EN 301 489, partes 1 y 9) y califican para llevar la marca CE.

El receptor modelo SLX4:

Cumple los requisitos australianos en materia de EMC, califica para llevar la marca "C-Tick".

Autorizado según la cláusula de Declaración de homologación de la parte 15 de las normas de la FCC como dispositivo digital de categoría B. Certificados en Canadá por la IC bajo la norma RSS-123 ("IC: 616A-SLX4"). Cumple con los requisitos esenciales de la directriz europea 99/5/EC de RTTE (ETSI EN 300-422, partes 1 y 2, ETSI EN 301 489, partes 1 y 9) y califican para llevar la marca CE.

Los fuentes de alimentación modelos PS20E y PS20UK:

Cumple la norma IEC 60065 y califican para llevar la marca CE.

PS20AR: Cumple la norma IEC 60065. Certificado TÜV Rheinland Argentina, S.A., No. RA2681022.

Licencia de uso: Se puede requerir una licencia ministerial para utilizar este equipo en algunas áreas. Consulte a la autoridad nacional sobre los posibles requisitos.

Este equipo de radio está destinado para uso en presentaciones musicales profesionales y situaciones similares.

Regulatory and Licensing Information

I trasmettitori Shure modellos SLX1 e SLX2:

Di tipo approvato secondo le norme FCC Parte 74 (FCC ID: "DD4SLX1" e "DD4SLX2"). Omologato dalla IC in Canada a norma RSS-123 e RSS-102. Conforme ai requisiti essenziali specificati nella direttiva europea R&TTE 99/5/EC (ETSI specificati nella norma EN 300 422, Parte 1 e Parte 2, ETSI specificati nella norma EN 301 489, Parte 1 e Parte 9) e possono essere contrassegnati con il marchio CE.

Il ricevitore Shure modello SLX4:

Conforme ai requisiti australiani relativi alla compatibilità elettromagnetica e contrassegnabile con il marchio C-Tick marking.

Omologato secondo la clausola di Dichiarazione di conformità delle norme FCC, Parte 15, come dispositivo digitale di Classe B. Omologato dalla IC in Canada a norma RSS-123 ("IC: 616A-SLX4"). Conforme ai requisiti essenziali specificati nella direttiva europea R&TTE 99/5/EC (ETSI specificati nella norma EN 300 422, Parte 1 e Parte 2, ETSI specificati nella norma EN 301 489, Parte 1 e Parte 9) e possono essere contrassegnati con il marchio CE.

Di alimentatori PS20E e PS20UK:

Conforme alle norme IEC 60065 e possono essere contrassegnati con il marchio CE.

PS20AR: Conforme alle norme IEC 60065. Certificato TÜV Rheinland Argentina, S.A., No. RA2681022.

Concessione della licenza all'uso: per usare questo apparecchio, in certe aree può essere necessaria una licenza ministeriale. Per i possibili requisiti, rivolgersi alle autorità competenti.

Questo apparecchio radio è inteso per intrattenimento a livello professionale ed applicazioni simili.

European Countries and Frequencies

H5 518–542 MHz, max. 30 mW	
Country Code	Frequency Range
Code de Pays	Gamme de frequences
Länder-Kürzel	Frequenzbereich
A, B, CH, CZ, D, E, EST	518–542 MHz *
F, GB, GR, H, I, IRL, L,	518–542 MHz *
LT, M, NL, P, PL, SLO	518–542 MHz *
DK, FIN, N, S	*
CY, LV, SK	*
all other countries	*

J3 572–596 MHz, max. 30 mW	
Country Code	Frequency Range
Code de Pays	Gamme de frequences
Länder-Kürzel	Frequenzbereich
A, B, CH, CZ, D, E, EST	572–596 MHz *
F, GB, GR, H, I, IRL, L,	572–596 MHz *
LT, M, NL, P, PL, SLO	572–596 MHz *
DK, FIN, N, S	*
CY, LV, SK	*
all other countries	*

L4 638–662 MHz, max. 30 mW	
Country Code	Frequency Range
Code de Pays	Gamme de frequences
Länder-Kürzel	Frequenzbereich
A, B, CH, CZ, D, E, EST	638–662 MHz *
F, GB, GR, H, I, IRL, L,	638–662 MHz *
LT, M, NL, P, PL, SLO	638–662 MHz *
DK, FIN, N, S	*
CY, LV, SK	*
all other countries	*

P4 702–726 MHz, max. 30 mW	
Country Code	Frequency Range
Code de Pays	Gamme de frequences
Länder-Kürzel	Frequenzbereich
A, B, CH, CZ, D, E, EST	702–726 MHz *
F, GB, GR, H, I, IRL, L,	702–726 MHz *
LT, M, NL, P, PL, SLO	702–726 MHz *
DK, FIN, N, S	*
CY, LV, SK	*
all other countries	*

European Countries and Frequencies

R5 800–820 MHz, max. 20 mW	
Country Code	Frequency Range
Code de Pays	Gamme de frequences
Länder-Kürzel	Frequenzbereich
A, B, CH, D, E, EST	800–820 MHz *
F, GB, GR, H, I, IRL, L,	800–820 MHz *
FIN, LT, N, NL, P, PL, SLO	800–820 MHz *
DK	800,1–819,9 MHz *
S	800–814 MHz *
CZ	815–820 MHz *
CY, LV, M, SK	*
all other countries	*

S6 838–865 MHz, max. 10 mW	
Country Code	Frequency Range
Code de Pays	Gamme de frequences
Länder-Kürzel	Frequenzbereich
A, B, CH, D, E, EST	838–865 MHz *
GB, H, I, IRL, L,	838–865 MHz *
LT, M, NL, P, PL, SLO	838–865 MHz *
CY, CZ, DK, F, FIN	*
GR, N, LV, S, SK	*
all other countries	*

Declarations

FCC DECLARATION OF CONFORMITY

We,
of

Shure Incorporated
5800 Touhy Avenue
Niles, Illinois 60714-4608, U.S.A
(847) 600-2000

Declare under our sole responsibility that the following product

Model: SLX4 Description: UHF FM Receiver

Has been tested and found to comply with the limits for an unintentional radiator device, and approved under the Declaration of Conformity provision of the Part 15 of the FCC rules.

Operation is subject to the following two conditions:

1. This device may not cause harmful interference.
2. This device must accept any interference received, including interference that may cause undesired operation.

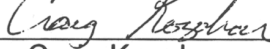
Signed  Date January 9, 2004
Name, Title Craig Kozokar
EMC Project Engineer, Corporate Quality, Shure Incorporated

EU DECLARATION OF CONFORMITY

We,
of

Shure Incorporated
5800 Touhy Ave
Niles, Illinois, 60714-4608 U.S.A
(847) 600-2000

Declare under our sole responsibility that the following product

Model: SLX1, SLX 2, SLX4 Description: Body Pack and Handheld UHF FM Transmitter and UHF FM Receiver
PS20E, PS20UK

to which this Declaration relates

- are in conformity to European Low Voltage Directive 73/23/EEC
- are in conformity to European EMC Directive 89/336/EEC
- are in conformity to European R&TTE Directive 1999/5/EC
- are in conformity to European CE Marking Directive 93/68/EEC

The product complies with the following product family, harmonized or national standards:

SLX1, SLX2, and SLX4: EN 301 489 Part 1 and 9, ETSI 300 422-1 and ETSI 300 422-2
PS20E, PS20UK: EN60065, EN61000-3-2, EN 61000-3-3

Manufacturer: Shure Incorporated

Signed  Date February 27, 2004
Name, Title Craig Kozokar
EMC Project Engineer, Corporate Quality, Shure Incorporated

European Contact: Shure Europe GmbH

Wannenacker Str. 28, 74078 Heilbronn, Germany
Phone: 49-7131-7214-0, Fax: 49-7131-7214-14