



MEASUREMENT REPORT

FCC PART 15 Subpart D

FCC ID: DD4MXW6W
Applicant: Shure Incorporated
Application Type: Certification
Product: Boundary Transmitter (DECT)
Model No.: MXW6/C Z10, MXW6/O Z10,
MXW6W/C Z10, MXW6W/O Z10
Brand Name: SHURE
FCC Classification: Unlicensed PCS Base Station (PUB)
FCC Rule Part(s): FCC Part 15, Subpart D
Test Procedure(s): ANSI C63.17-2013
Test Date: September 28, 2017 ~ April 26, 2018

Reviewed By : Jame Yuan
(Jame Yuan)
Approved By : Robin Wu
(Robin Wu)



The test results relate only to the samples tested.

This equipment has been shown to be capable of compliance with the applicable technical standards as indicated in the measurement report and was tested in accordance with the measurement procedures specified in ANSI C63.17. Test results reported herein relate only to the item(s) tested.

The test report shall not be reproduced except in full without the written approval of MRT Technology (Suzhou) Co., Ltd.

Revision History

Report No.	Version	Description	Issue Date	Note
1711RSU037-U1	Rev. 01	Initial Report	04-26-2017	Valid

CONTENTS

Description	Page
§2.1033 General Information	6
1. INTRODUCTION	7
1.1. Scope.....	7
1.2. MRT Test Location.....	7
2. PRODUCT INFORMATION	8
2.1. Feature of Equipment under Test.....	8
2.2. Product Specification Subjective to this Report.....	8
2.3. Working Frequencies.....	8
2.4. Test Software.....	8
2.5. EMI Suppression Device(s)/Modifications.....	8
2.6. Labeling Requirements.....	9
3. DESCRIPTION of TEST	10
3.1. Evaluation Procedure.....	10
3.2. AC Line Conducted Emissions.....	10
4. ANTENNA REQUIREMENTS	11
5. TEST EQUIPMENT CALIBRATION DATE	12
6. MEASUREMENT UNCERTAINTY	13
7. TEST RESULT	14
7.1. Summary.....	14
7.2. Power Line Conducted Emissions.....	15
7.2.1. Test Limit.....	15
7.2.2. Test Setup.....	15
7.2.3. Test Result.....	16
7.3. Emission Bandwidth Measurement.....	18
7.3.1. Test Limit.....	18
7.3.2. Test Procedure used.....	18
7.3.3. Test Setup.....	18
7.3.4. Test Result.....	19
7.4. Peak Power Output.....	22
7.4.1. Test Limit.....	22
7.4.2. Test Procedure Used.....	22
7.4.3. Test Setup.....	22
7.4.4. Test Result.....	23

7.5.	Power Spectral Density	26
7.5.1.	Test Limit	26
7.5.2.	Test Procedure Used	26
7.5.3.	Test Setup	26
7.5.4.	Test Result.....	27
7.6.	In-Band Unwanted Emissions.....	29
7.6.1.	Test Limit	29
7.6.2.	Test Procedure Used	29
7.6.3.	Test Setup	29
7.6.4.	Test Result.....	30
7.7.	Out-of-Band Emissions, Conducted.....	31
7.7.1.	Test Limit	31
7.7.2.	Test Procedure Used	31
7.7.3.	Test Setup	31
7.7.4.	Test Result.....	32
7.8.	Carrier Frequency Stability	35
7.8.1.	Test Limit	35
7.8.2.	Test Procedure Used	35
7.8.3.	Test Setup	35
7.8.4.	Test Result.....	36
7.9.	Automatic Discontinuation of Transmission	37
7.10.	Specific Requirements for UPCS Device	38
7.10.1.	Monitoring Time Requirements	38
7.10.1.1.	Test Procedure Used	38
7.10.1.2.	Test Setup	38
7.10.1.3.	Test Reslut.....	38
7.10.2.	Lowest Monitoring Threshold Requirements	39
7.10.2.1.	Test Procedure Used	39
7.10.2.2.	Test Reslut.....	39
7.10.3.	Acknowledgements and Transmission Duration Requirements.....	40
7.10.3.1.	Test Procedure Used	40
7.10.3.2.	Test Reslut.....	40
7.10.4.	Least Interfered Channel (LIC) Selection Requirements	41
7.10.4.1.	Test Procedure Used	41
7.10.4.2.	Test Reslut.....	41
7.10.5.	Random waiting Requirements.....	42
7.10.5.1.	Test Procedure Used	42
7.10.5.2.	Test Reslut.....	42
7.10.6.	Monitoring Bandwidth Requirements	42

7.10.6.1.	Test Procedure Used	42
7.10.6.2.	Test Reslut.....	42
7.10.7.	Monitoring Antenna Requirements.....	43
7.10.7.1.	Test Procedure Used	43
7.10.7.2.	Test Reslut.....	43
7.10.8.	Monitoring Antenna Requirements.....	43
7.10.8.1.	Test Procedure Used	43
7.10.8.2.	Test Reslut.....	43
7.10.9.	Dual Access Criteria Check Requirements	44
7.10.9.1.	Test Procedure Used	44
7.10.9.2.	Test Reslut.....	44
7.10.10.	Alternative monitoring interval for co-located devices Requirements.....	45
7.10.10.1.	Test Procedure Used	45
7.10.10.2.	Test Reslut.....	45
7.10.11.	Frame Repetition Stability and Period and Jitter	46
7.10.11.1.	Test Limit	46
7.10.11.2.	Test Procedure Used	46
7.10.11.3.	Test Setup	46
7.10.12.	Test Result.....	46
8.	CONCLUSION	47

§2.1033 General Information

Applicant:	Shure Incorporated
Applicant Address:	5800 West Touhy Avenue, Niles, IL 60714-4608, USA
Manufacturer:	Shure Incorporated
Manufacturer Address:	5800 West Touhy Avenue, Niles, IL 60714-4608, USA
Test Site:	MRT Technology (Suzhou) Co., Ltd
Test Site Address:	D8 Building, No.2 Tian'edang Rd., Wuzhong Economic Development Zone, Suzhou, China
FCC Registration No.:	893164
IC Registration No.:	11384A-1
Test Device Serial No.:	N/A <input type="checkbox"/> Production <input checked="" type="checkbox"/> Pre-Production <input type="checkbox"/> Engineering

Test Facility / Accreditations

Measurements were performed at MRT Laboratory located in Tian'edang Rd., Suzhou, China.

- MRT facility is a FCC registered (MRT Reg. No. 893164) test facility with the site description report on file and has met all the requirements specified in Section 2.948 of the FCC Rules.
- MRT facility is an IC registered (MRT Reg. No. 11384A-1) test laboratory with the site description on file at Industry Canada.
- MRT facility is a VCCI registered (R-20025, G-20034, C-20020, T-20020) test laboratory with the site description on file at VCCI Council.
- MRT Lab is accredited to ISO 17025 by the American Association for Laboratory Accreditation (A2LA) under the American Association for Laboratory Accreditation Program (A2LA Cert. No. 3628.01) in EMC, Telecommunications and Radio testing for FCC, Industry Canada, EU and TELEC Rules.



1. INTRODUCTION

1.1. Scope

Measurement and determination of electromagnetic emissions (EMC) of radio frequency devices including intentional and/or unintentional radiators for compliance with the technical rules and regulations of the Federal Communications Commission and the Industry Canada Certification and Engineering Bureau.

1.2. MRT Test Location

The map below shows the location of the MRT LABORATORY, its proximity to the Taihu Lake. These measurement tests were conducted at the MRT Technology (Suzhou) Co., Ltd. Facility located at D8 Building, No.2 Tian'edang Rd., Wuzhong Economic Development Zone, Suzhou, China. The detailed description of the measurement facility was found to be in compliance with the requirements of § 2.948 according to ANSI C63.4-2009 on September 30, 2013.



2. PRODUCT INFORMATION

2.1. Feature of Equipment under Test

Product Name:	Boundary Transmitter (DECT)
Model No.:	MXW6/C Z10, MXW6/O Z10, MXW6W/C Z10, MXW6W/O Z10
Brand Name:	SHURE

Note1: The difference between MXW6/C and MXW6/O is that the EUT has different built-in MIC.

Note2: MXW6/C Z10 and MXW6/O Z10 housing colour are black, but MXW6W/C Z10 and MXW6W/O Z10 housing colour is white, any others are same.

2.2. Product Specification Subjective to this Report

Frequency Range:	1921.536 ~ 1928.448MHz
Number of Channels:	5
Maximum Output Power:	21.09dBm
Type of Modulation:	Digital (Gaussian Frequency Shift Keying)
Antenna Gain:	-0.86dBi

2.3. Working Frequencies

UPCS Channel	Frequency (MHz)
Upper Band Edge	1930.000
0 (Highest)	1928.448
1	1926.720
2	1924.992
3	1923.264
4 (Lowest)	1921.536
Lowest Band Edge	1920.000

2.4. Test Software

The test utility software used during testing was "MXW MIC".

2.5. EMI Suppression Device(s)/Modifications

No EMI suppression device(s) were added and/or no modifications were made during testing.

2.6. Labeling Requirements

Per 2.1074 & 15.19; Docket 95-19

The label shall be permanently affixed at a conspicuous location on the device; instruction manual or pamphlet supplied to the user and be readily visible to the purchaser at the time of purchase.

However, when the device is so small wherein placement of the label with specified statement is not practical, only the FCC ID must be displayed on the device per Section 15.19(a)(5). Please see attachment for FCC ID label and label location.

3. DESCRIPTION of TEST

3.1. Evaluation Procedure

All measurements are traceable to national standards.

The tests were conducted on a sample of the equipment for the purpose of demonstrating compliance with FCC CFR47 Part 15D for Isochronous UPCS Devices and Industry Canada RSS-213 Issue 3 / RSS-GEN Issue 5 / RSP-100 Issue 11.

All tests were conducted in accordance with ANSI C63.4-2014 and ANSI C63.17-2013. Antenna Gain tests were made in a 3m fully-anechoic chamber.

3.2. AC Line Conducted Emissions

The line-conducted facility is located inside an 8'x4'x4' shielded enclosure. A 1m x 2m wooden table 80cm high is placed 40cm away from the vertical wall and 80cm away from the sidewall of the shielded room. Two 10kHz-30MHz, 50Ω/50uH Line-Impedance Stabilization Networks (LISNs) are bonded to the shielded room floor. Power to the LISNs is filtered by external high-current high-insertion loss power line filters. These filters attenuate ambient signal noise from entering the measurement lines. These filters are also bonded to the shielded enclosure.

The EUT is powered from one LISN and the support equipment is powered from the second LISN. All interconnecting cables more than 1 meter were shortened to a 1 meter length by non-inductive bundling (serpentine fashion) and draped over the back edge of the test table. All cables were at least 40cm above the horizontal reference ground-plane. Power cables for support equipment were routed down to the second LISN while ensuring that that cables were not draped over the second LISN.

Sufficient time for the EUT, support equipment, and test equipment was allowed in order for them to warm up to their normal operating condition. The RF output of the LISN was connected to the receiver and exploratory measurements were made to determine the frequencies producing the maximum emission from the EUT. The receiver was scanned from 150kHz to 30MHz. The detector function was set to peak mode for exploratory measurements while the bandwidth of the analyzer was set to 9kHz. The EUT, support equipment, and interconnecting cables were arranged and manipulated to maximize each emission. Each emission was also maximized by varying: power lines, the mode of operation or data exchange speed, or support equipment whichever determined the worst-case emission. Once the worst case emissions have been identified, the one EUT cable configuration/arrangement and mode of operation that produced these emissions are used for final measurements on the same test site. The analyzer is set to CISPR quasi-peak and average detectors with a 9kHz resolution bandwidth for final measurements.

An extension cord was used to connect to a single LISN which powered by EUT. The extension cord was calibrated with LISN, the impedance and insertion loss are compliance with the requirements as stated in ANSI C63.10-2013.

4. ANTENNA REQUIREMENTS

Excerpt from §15.203 of the FCC Rules/Regulations:

“An intentional radiator antenna shall be designed to ensure that no antenna other than that furnished by the responsible party can be used with the device. The use of a permanently attached antenna or of an antenna that uses a unique coupling to the intentional radiator shall be considered sufficient to comply with the provisions of this section.”

- The antenna of the **Boundary Transmitter (DECT)** is **permanently attached**.
- There are no provisions for connection to an external antenna.

Conclusion:

The **Boundary Transmitter (DECT)** unit complies with the requirement of §15.203.

5. TEST EQUIPMENT CALIBRATION DATE

Conducted Emissions - SR2

Instrument	Manufacturer	Type No.	Asset No.	Cali. Interval	Cali. Due Date
EMI Test Receiver	R&S	ESR7	MRTSUE06001	1 year	2018/06/21
Two-Line V-Network	R&S	ENV216	MRTSUE06002	1 year	2018/06/21
Two-Line V-Network	R&S	ENV216	MRTSUE06003	1 year	2018/06/21
Temperature/Humidity Meter	Yuhuaze	HTC-2	MRTSUE06179	1 year	2017/12/22
				1 year	2018/12/22
Shielding Anechoic Chamber	Mikebang	Chamber-SR2	MRTSUE06215	1 year	2018/05/10

Conducted Test Equipment - TR4

Instrument	Manufacturer	Type No.	Asset No.	Cali. Interval	Cali. Due Date
Spectrum Analyzer	Agilent	N9020A	MRTSUE06106	1 year	2018/04/25
				1 year	2019/04/25
Digital Radio Communication Tester	RTX	RTX2012	MRTSUE06399	1 year	2018/09/04
Temperature/Humidity Meter	Yuhuaze	HTC-2	MRTSUE06184	1 year	2017/12/22
				1 year	2018/12/22

Software	Version	Function
e3	V8.3.5	EMI Test Software

6. MEASUREMENT UNCERTAINTY

Where relevant, the following test uncertainty levels have been estimated for tests performed on the EUT as specified in CISPR 16-4-2. This uncertainty represents an expanded uncertainty expressed at approximately the 95% confidence level using a coverage factor of $k = 2$.

AC Conducted Emission Measurement - SR2
Measuring Uncertainty for a Level of Confidence of 95% ($U=2Uc(y)$): 150kHz~30MHz: $\pm 3.46\text{dB}$
Output Power - TR4
Measuring Uncertainty for a Level of Confidence of 95% ($U=2Uc(y)$): $\pm 0.52\text{dB}$
Power Spectral Density - TR4
Measuring Uncertainty for a Level of Confidence of 95% ($U=2Uc(y)$): $\pm 0.52\text{dB}$
Out of Band Emissions - TR4
Measuring Uncertainty for a Level of Confidence of 95% ($U=2Uc(y)$): $\pm 0.75\text{dB}$
Emission Bandwidth - TR4
Measuring Uncertainty for a Level of Confidence of 95% ($U=2Uc(y)$): 3.8%
Frequency error - TR4
Measuring Uncertainty for a Level of Confidence of 95% ($U=2Uc(y)$): $\pm 0.5\text{ppm}$
Acknowledgements and Transmission Duration - TR4
Measuring Uncertainty for a Level of Confidence of 95% ($U=2Uc(y)$): $\pm 1.9\text{ns}$
Timing and Jitter Measurements - TR4
Measuring Uncertainty for a Level of Confidence of 95% ($U=2Uc(y)$): $\pm 1.9\text{ns}$
Frame Timing Measurements - TR4
Measuring Uncertainty for a Level of Confidence of 95% ($U=2Uc(y)$): $\pm 0.8\text{ppm}$

7. TEST RESULT

7.1. Summary

Test Item	FCC CFR 47 Paragraph	Verdict
Power Line Conducted Emission	15.207(a)	Complies
Emission Bandwidth	15.323(a)	Complies
In-band emissions	15.323(d)	Complies
Out-of-band emissions	15.323(d)	Complies
Peak Transmit Power and Antenna Gain	15.319(c) & 15.319(e)	Complies
Power Spectral Density	15.319(d)	Complies
Carrier frequency stability	15.323(f)	Complies
Spurious Emissions (Radiated)	15.319(g) & 15.109(a) & 15.209(a)	Note
Automatic discontinuation of transmission	15.319(f)	Complies
Specific Requirements for UPCS	15.323(c)(e)	Complies

Note: Not required if the Conducted Out-of-Band Emissions test is passed, and assessed in the FCC 15B test report.

7.2. Power Line Conducted Emissions

7.2.1. Test Limit

FCC Part 15.107 Limits		
Frequency (MHz)	QP (dB μ V)	AV (dB μ V)
0.15 - 0.50	66 - 56	56 - 46
0.50 - 5.0	56	46
5.0 - 30	60	50

Note 1: The lower limit shall apply at the transition frequencies.

Note 2: The limit decreases linearly with the logarithm of the frequency in the range 0.15MHz to 0.5MHz.

7.2.2. Test Setup

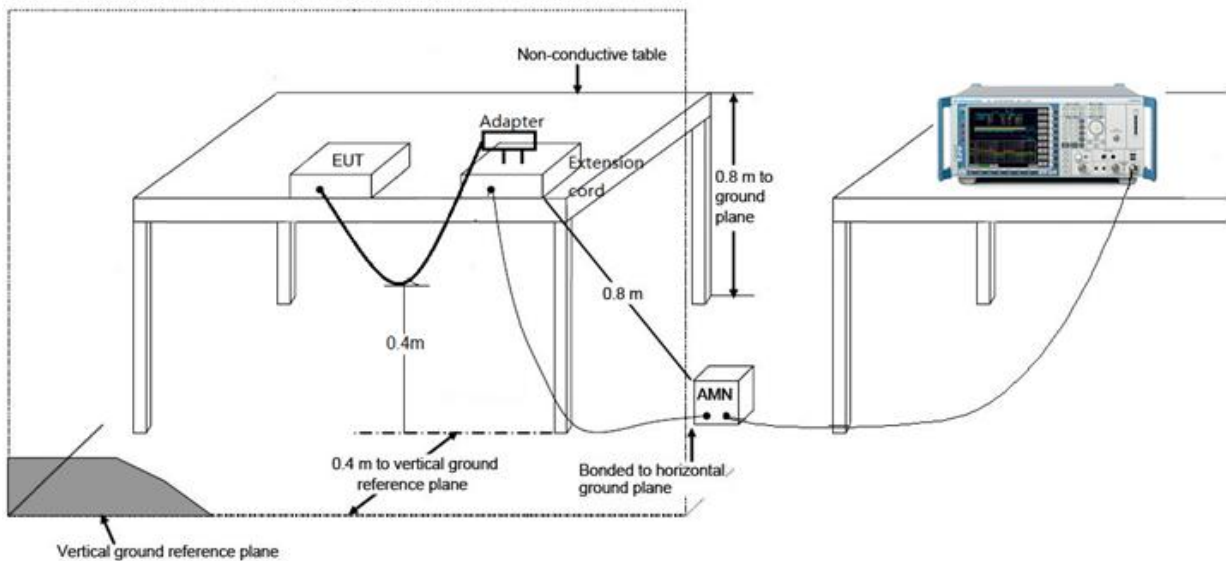

7.2.3. Test Result

Site: SR2	Time: 2018/04/13 - 13:23
Limit: FCC_Part15.107_CE_AC Power_ClassB	Engineer: Bacon Dong
Probe: ENV216_101683_Filter On	Polarity: Line
EUT: Boundary Transmitter (DECT)	Power: AC 120V/60Hz
Note: Mode 1	

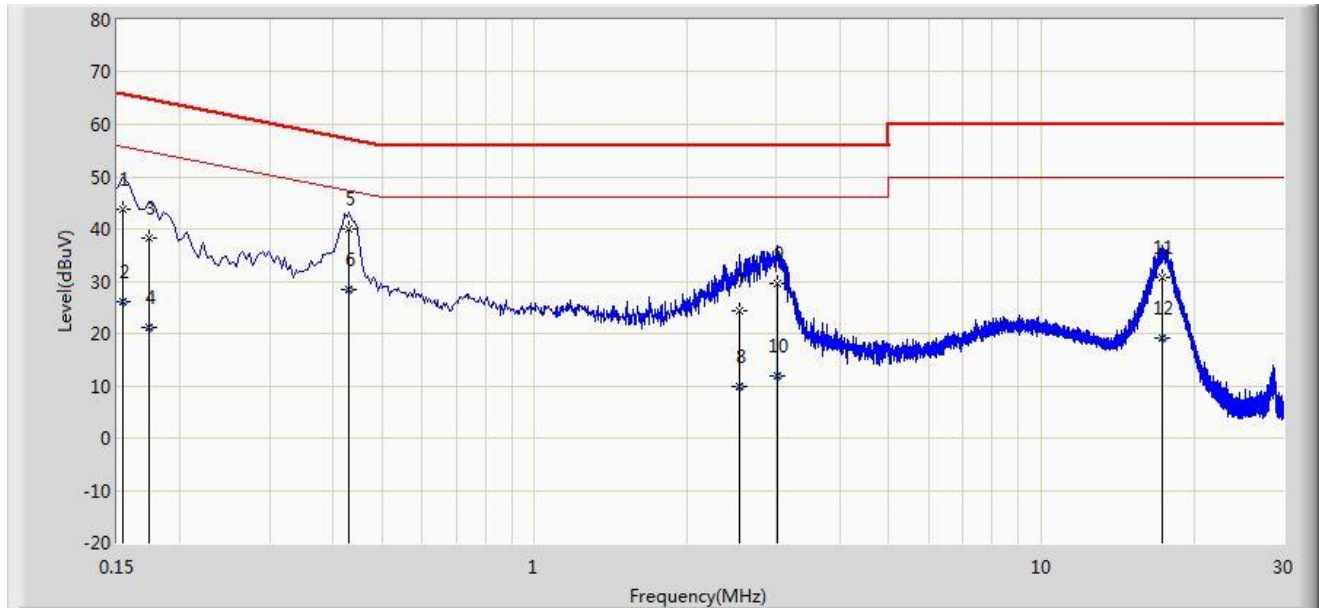

No	Flag	Mark	Frequency (MHz)	Measure Level (dBuV)	Reading Level (dBuV)	Over Limit (dB)	Limit (dBuV)	Factor (dB)	Type
1			0.154	43.752	33.013	-22.029	65.781	10.740	QP
2			0.154	26.165	15.425	-29.617	55.781	10.740	AV
3			0.174	38.397	28.329	-26.370	64.767	10.068	QP
4			0.174	21.115	11.047	-33.653	54.767	10.068	AV
5		*	0.430	39.865	29.755	-17.387	57.253	10.110	QP
6			0.430	28.533	18.422	-18.720	47.253	10.110	AV
7			2.534	24.340	14.484	-31.660	56.000	9.856	QP
8			2.534	9.818	-0.038	-36.182	46.000	9.856	AV
9			3.006	29.511	19.647	-26.489	56.000	9.864	QP
10			3.006	11.858	1.994	-34.142	46.000	9.864	AV
11			17.354	30.705	20.614	-29.295	60.000	10.091	QP
12			17.354	19.075	8.984	-30.925	50.000	10.091	AV

Note: Measure Level (dBμV) = Reading Level (dBμV) + Factor (dB)

Factor (dB) = Cable Loss (dB) + LISN Factor (dB)

Site: SR2	Time: 2018/04/13 - 13:31
Limit: FCC_Part15.107_CE_AC Power_ClassB	Engineer: Bacon Dong
Probe: ENV216_101683_Filter On	Polarity: Neutral
EUT: Boundary Transmitter (DECT)	Power: AC 120V/60Hz
Note: Mode 1	

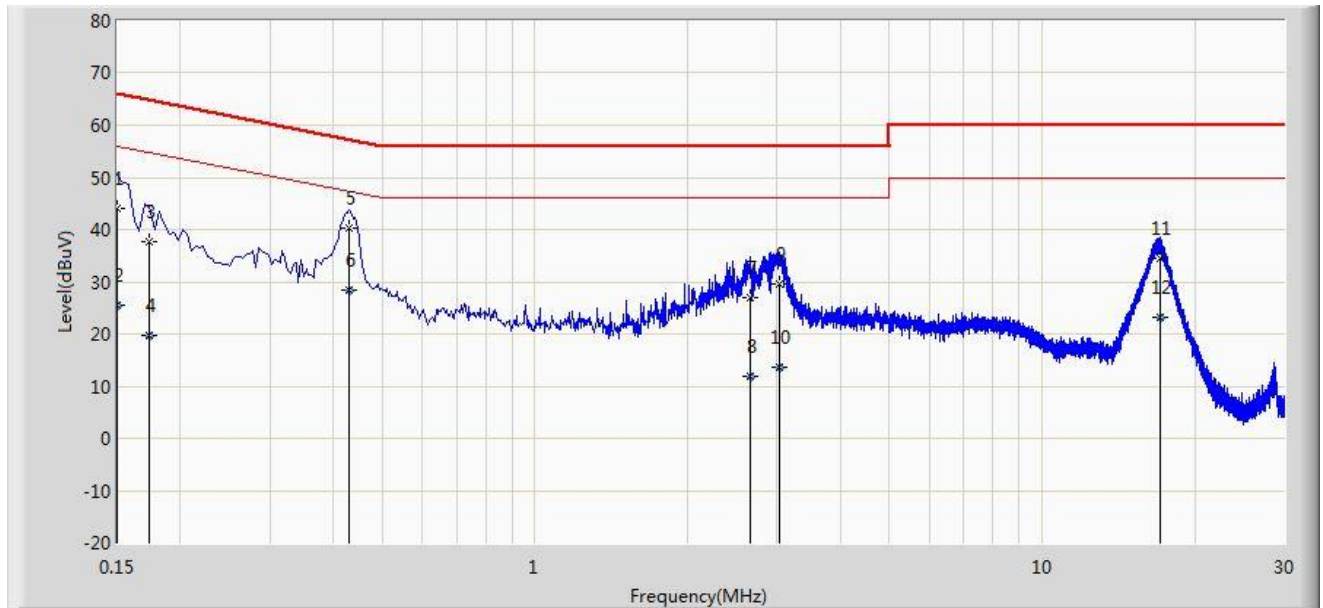

No	Flag	Mark	Frequency (MHz)	Measure Level (dBuV)	Reading Level (dBuV)	Over Limit (dB)	Limit (dBuV)	Factor (dB)	Type
1			0.150	44.030	32.888	-21.970	66.000	11.142	QP
2			0.150	25.554	14.411	-30.446	56.000	11.142	AV
3			0.174	37.656	27.599	-27.111	64.767	10.057	QP
4			0.174	19.675	9.618	-35.092	54.767	10.057	AV
5		*	0.430	40.181	30.045	-17.072	57.253	10.135	QP
6			0.430	28.468	18.333	-18.785	47.253	10.135	AV
7			2.654	27.043	17.187	-28.957	56.000	9.856	QP
8			2.654	11.806	1.950	-34.194	46.000	9.856	AV
9			3.042	29.599	19.732	-26.401	56.000	9.867	QP
10			3.042	13.570	3.703	-32.430	46.000	9.867	AV
11			17.042	34.403	24.282	-25.597	60.000	10.121	QP
12			17.042	23.297	13.176	-26.703	50.000	10.121	AV

Note: Measure Level (dBμV) = Reading Level (dBμV) + Factor (dB)

Factor (dB) = Cable Loss (dB) + LISN Factor (dB)

7.3. Emission Bandwidth Measurement

7.3.1. Test Limit

Requirement: FCC 15.323(a)

The 26 dB Bandwidth B shall be larger than 50 kHz and less than 2.5MHz.

7.3.2. Test Procedure used

ANSI C63.17, Clause 6.1.3

7.3.3. Test Setup

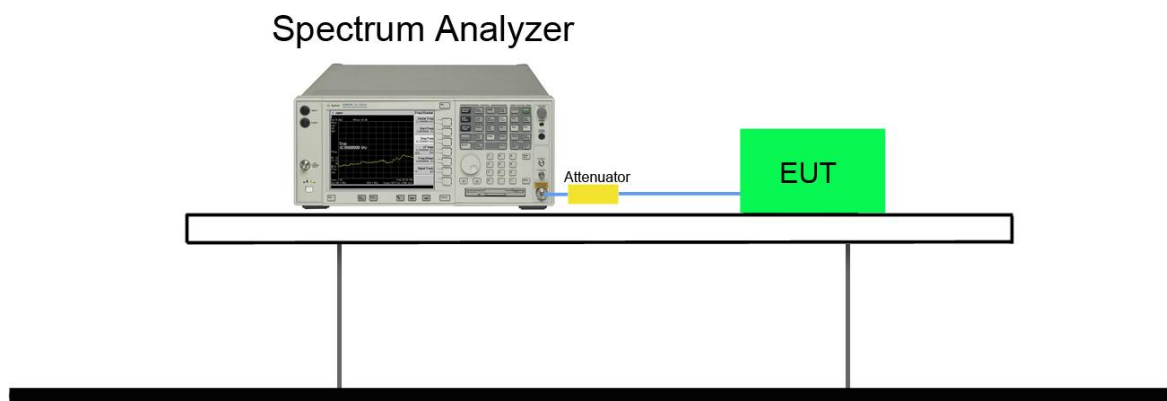

7.3.4. Test Result

Product	Boundary Transmitter (DECT)	Temperature	24°C
Test Engineer	Dandy Li	Relative Humidity	51%
Test Site	TR3	Test Date	2018/04/12

Channel No.	Frequency (MHz)	Emission Bandwidth (MHz)	Result
26dB Bandwidth			
4	1921.536	1.422	Pass
2	1924.992	1.418	Pass
0	1928.448	1.421	Pass
20dB Bandwidth			
4	1921.536	1.313	Pass
2	1924.992	1.312	Pass
0	1928.448	1.296	Pass
99% Bandwidth			
4	1921.536	1.221	Pass
2	1924.992	1.223	Pass
0	1928.448	1.216	Pass

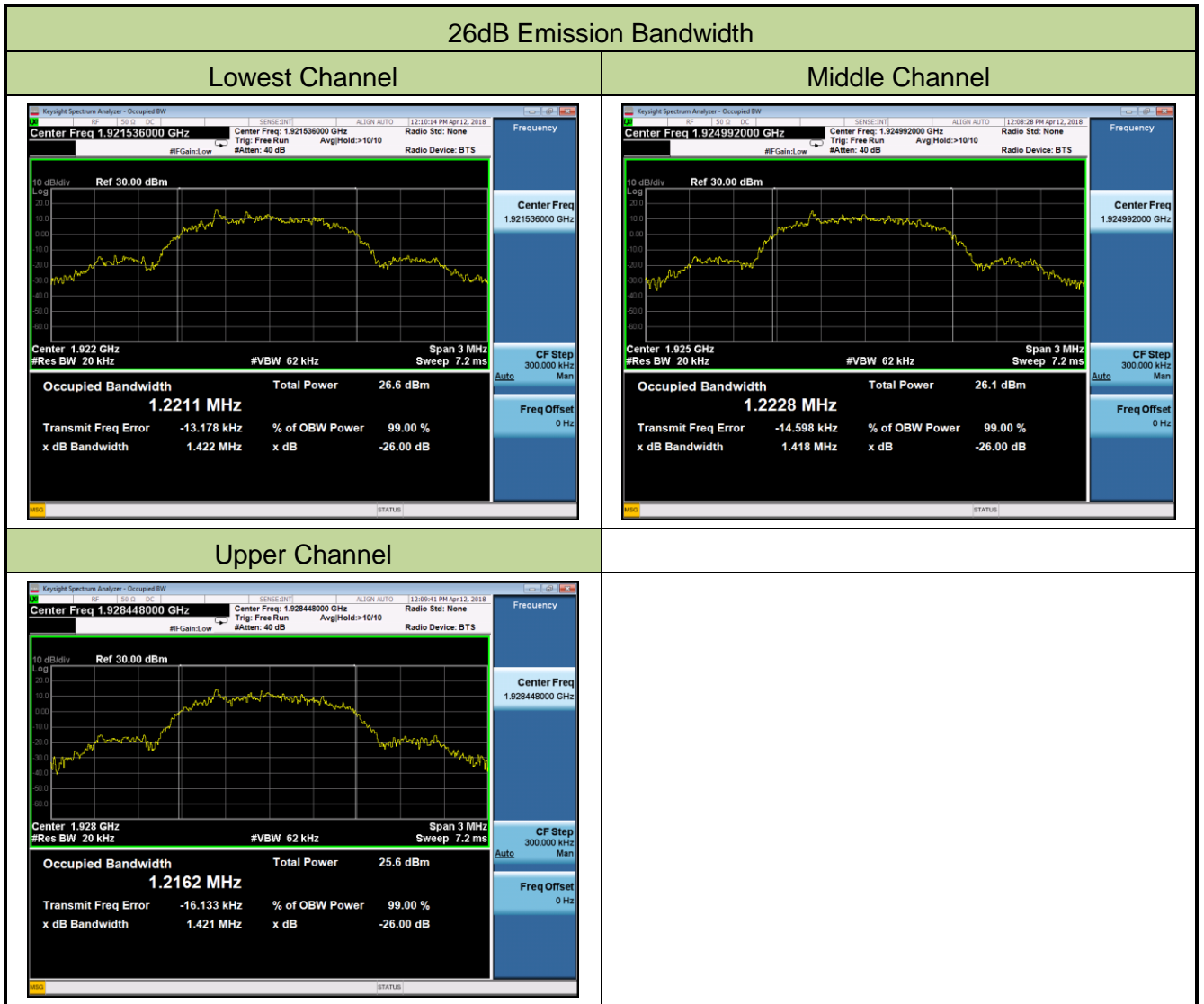



7.4. Peak Power Output

7.4.1. Test Limit

Peak transmit power shall not exceed 100 microwatts multiplied by the square root of the emission bandwidth in Hertz.

The peak transmit power shall be reduced by the amount in decibels that the maximum directional gain of the antenna exceeds 3dBi.

7.4.2. Test Procedure Used

ANSI C63.17, Clause 6.1.2

7.4.3. Test Setup

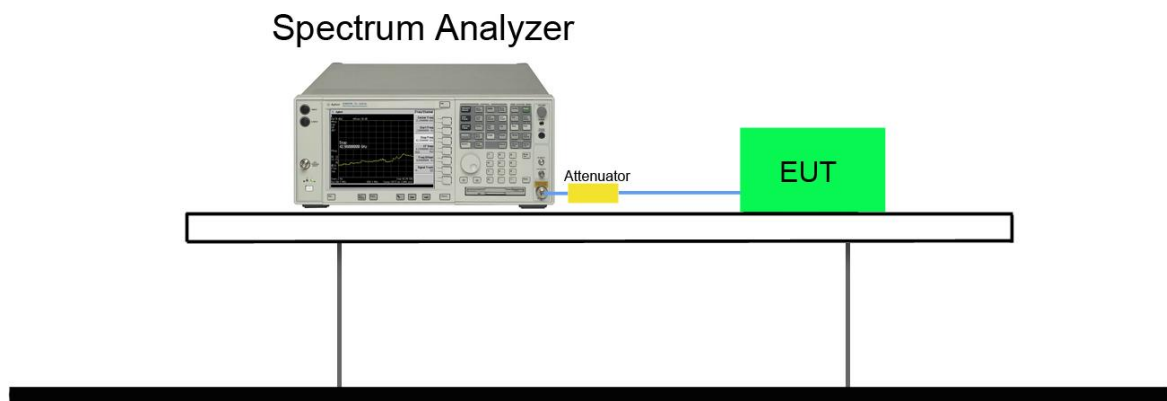

7.4.4. Test Result

Product	Boundary Transmitter (DECT)	Temperature	24°C
Test Engineer	Dandy Li	Relative Humidity	51%
Test Site	TR3	Test Date	2018/04/11

Channel No.	Frequency (MHz)	Conducted Output Power (dBm)	Antenna Gain (dBi)	EIRP (dBm)	Limit (dBm)
4	1921.536	21.09	-0.86	20.23	≤ 20.76
2	1924.992	20.69	-0.86	19.83	≤ 20.76
0	1928.448	20.24	-0.86	19.38	≤ 20.76

Note: The min EBW = 1418000Hz

Peak Transmit Power Limit = $10 \cdot \log(100 \mu\text{W} \times (\text{EBW})^{1/2} \div 1000) = 20.76 \text{dBm}$

Peak Output Power

Lowest Channel

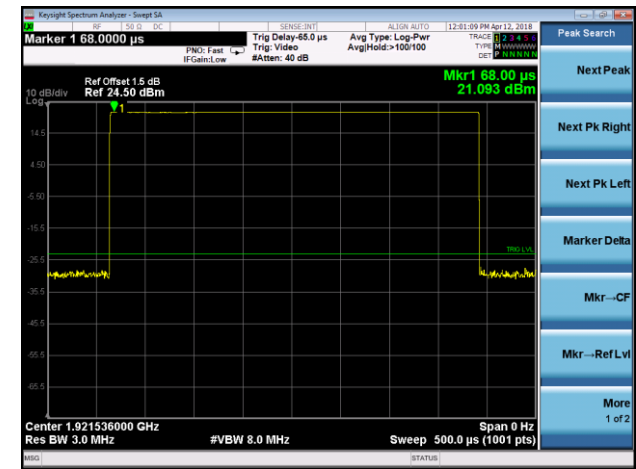

Middle Channel

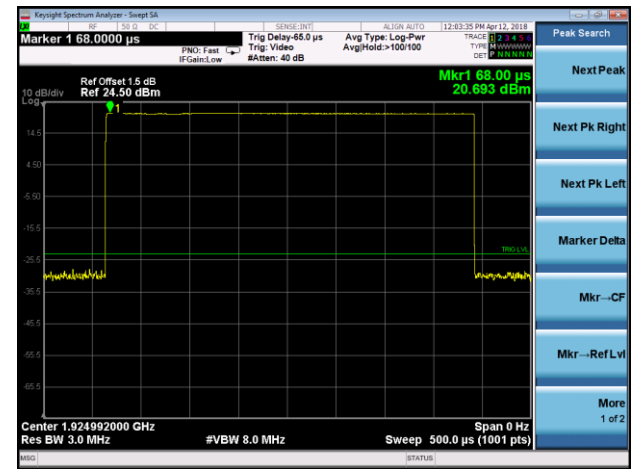

Upper Channel

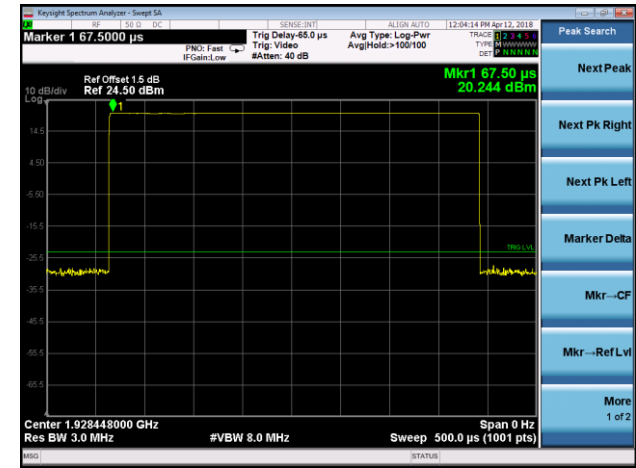

Antenna 3D and Polar Pattern

Maximum gain = -0.86 dBi

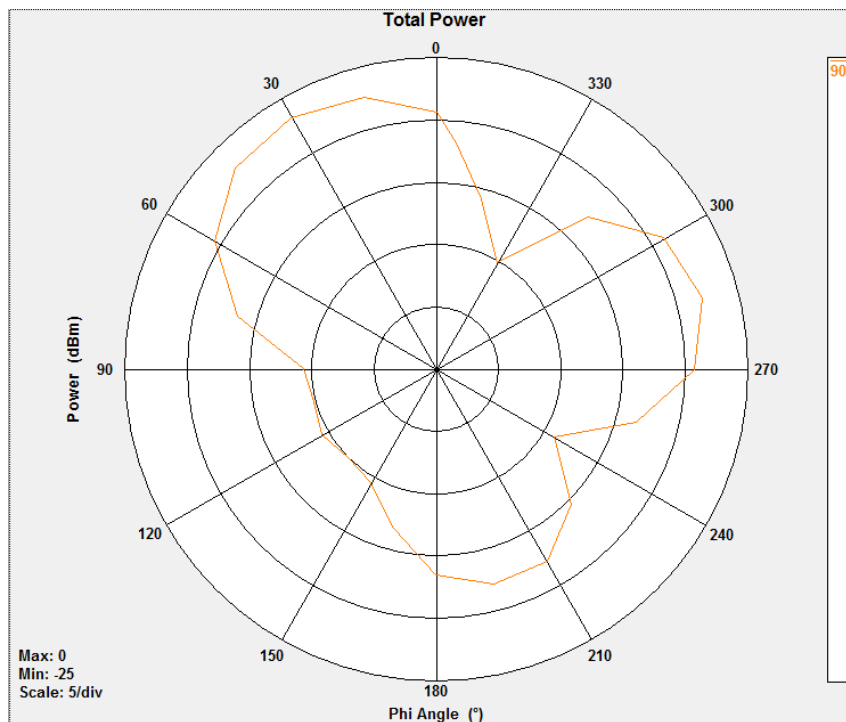
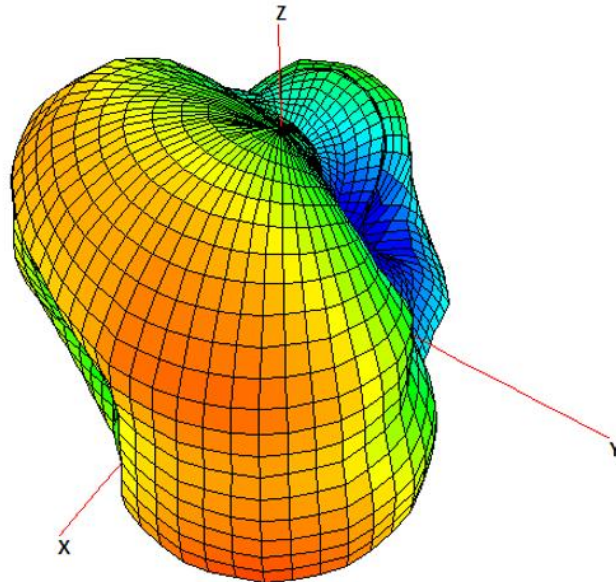

7.5. Power Spectral Density

7.5.1. Test Limit

Power spectral density shall not exceed 3 milliwatts in any 3 kHz bandwidth as measured with a spectrum analyzer having a resolution bandwidth of 3 kHz.

7.5.2. Test Procedure Used

ANSI C63.17, Clause 6.1.5

7.5.3. Test Setup

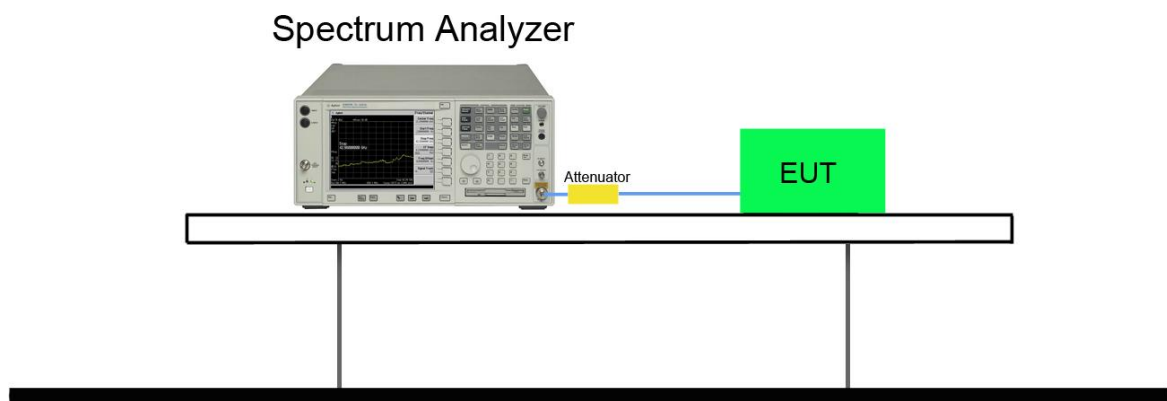

7.5.4. Test Result

Product	Boundary Transmitter (DECT)	Temperature	24°C
Test Engineer	Dandy Li	Relative Humidity	51%
Test Site	TR3	Test Date	2018/04/12

Channel No.	Frequency (MHz)	Measured PSD (dBm / 3kHz)	Limit (mW / 3kHz)	Result
4	1921.536	0.86	≤ 3.00	Pass
2	1924.992	1.54	≤ 3.00	Pass
0	1928.448	-0.91	≤ 3.00	Pass



7.6. In-Band Unwanted Emissions

7.6.1. Test Limit

B < f2 _2B: less than or equal to 30 dB below maximum permitted peak power level

2B < f2 _3B: less than or equal to 50 dB below maximum permitted peak power level

3B < f2 _UPCS Band Edge: less than or equal to 60 dB below maximum permitted peak power level.

7.6.2. Test Procedure Used

ANSI C63.17, Clause 6.1.

7.6.3. Test Setup

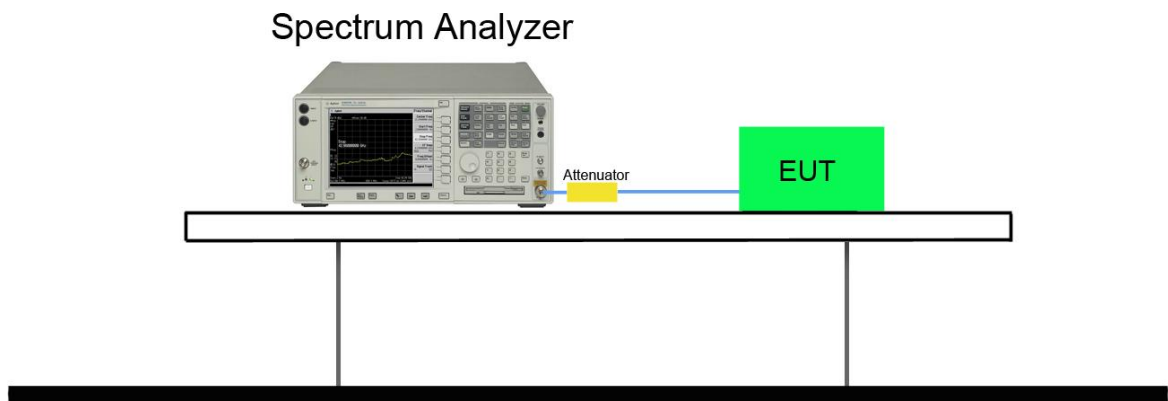

7.6.4. Test Result

Product	Boundary Transmitter (DECT)	Temperature	24°C
Test Engineer	Dandy Li	Relative Humidity	51%
Test Site	TR3	Test Date	2018/04/12

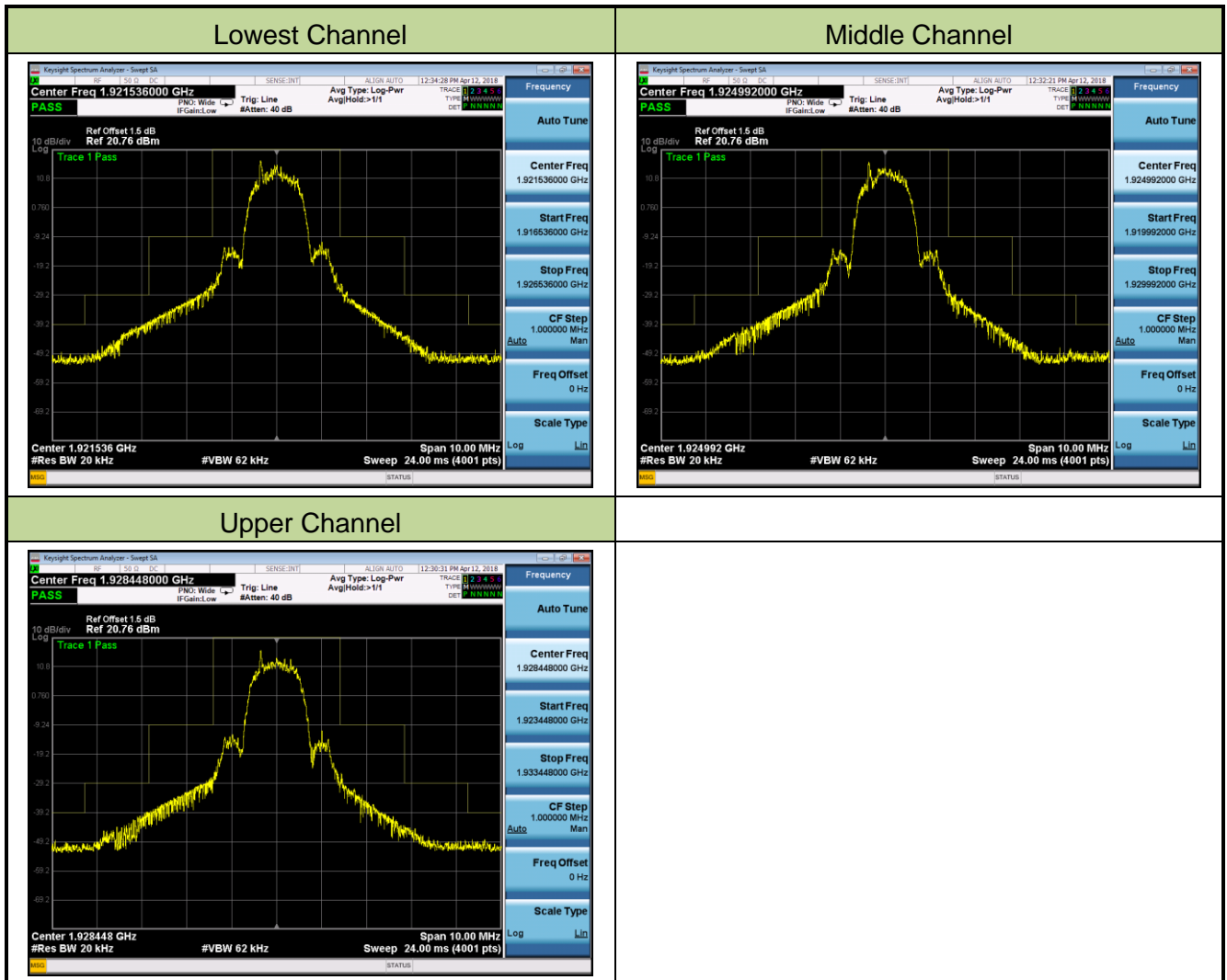

Note: The BS spurious in-band of Middle Channel transmission level is below the indicated limit.

7.7. Out-of-Band Emissions, Conducted

7.7.1. Test Limit

$f \leq 1.25$ MHz outside UPCS band: ≤ -9.5 dBm

1.25 MHz $\leq f \leq 2.5$ MHz outside UPCS band: ≤ -29.5 dBm

$f \leq 2.5$ MHz outside UPCS band: ≤ -39.5 dBm

7.7.2. Test Procedure Used

ANSI C63.17, Clause 6.1.

7.7.3. Test Setup

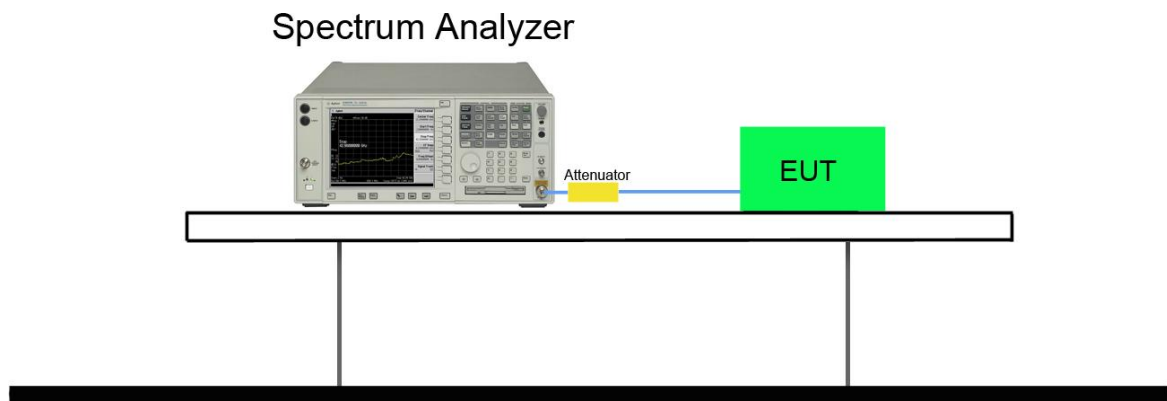

7.7.4. Test Result

Product	Boundary Transmitter (DECT)	Temperature	24°C
Test Engineer	Dandy Li	Relative Humidity	51%
Test Site	TR3	Test Date	2017/04/12

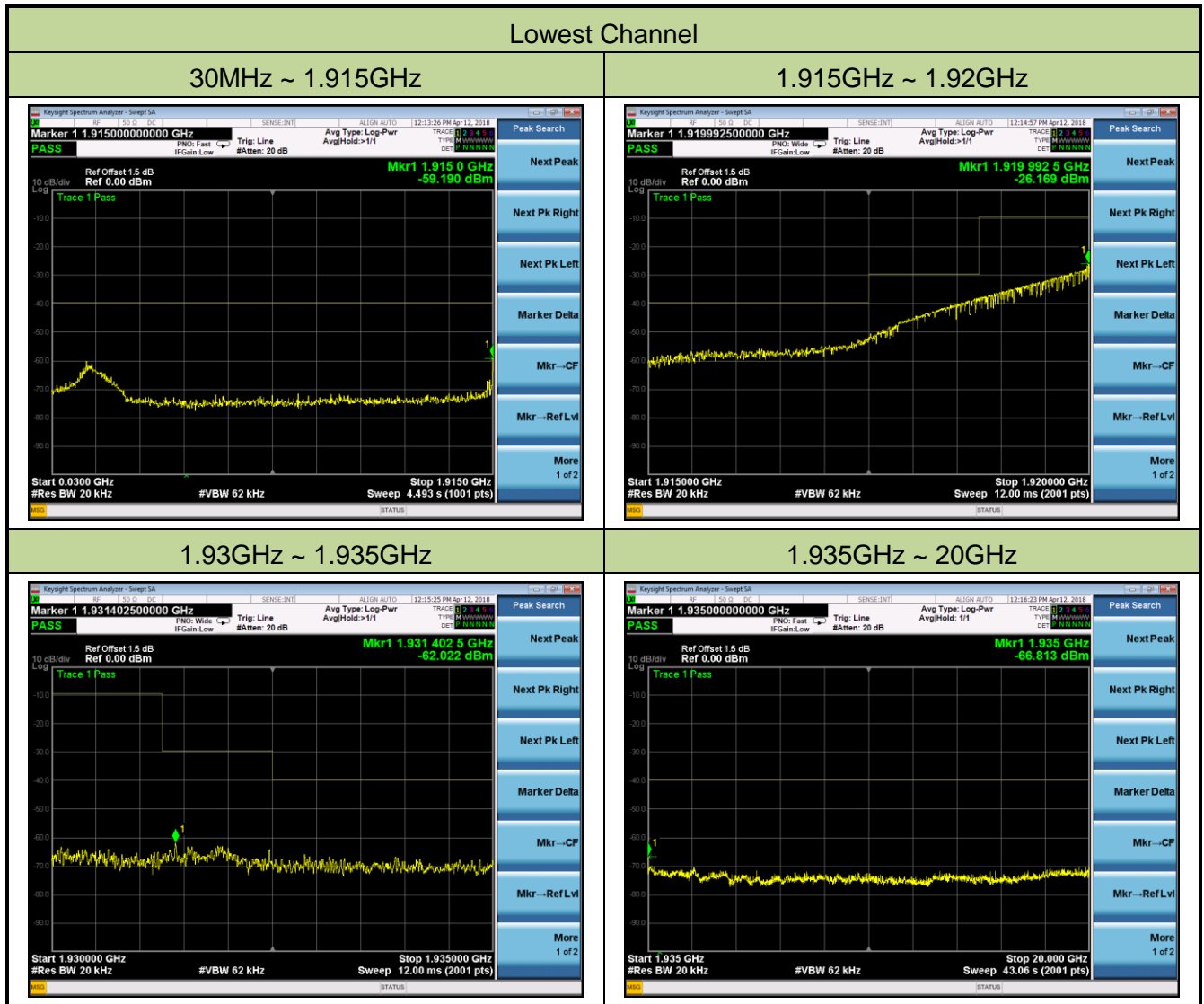

Middle Channel

30MHz ~ 1.915GHz

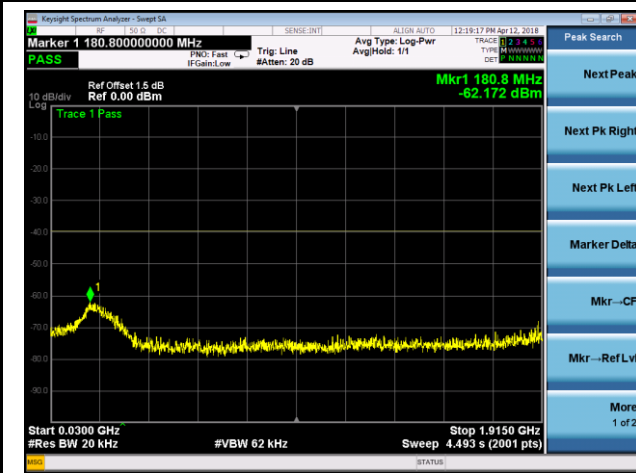

1.915GHz ~ 1.92GHz

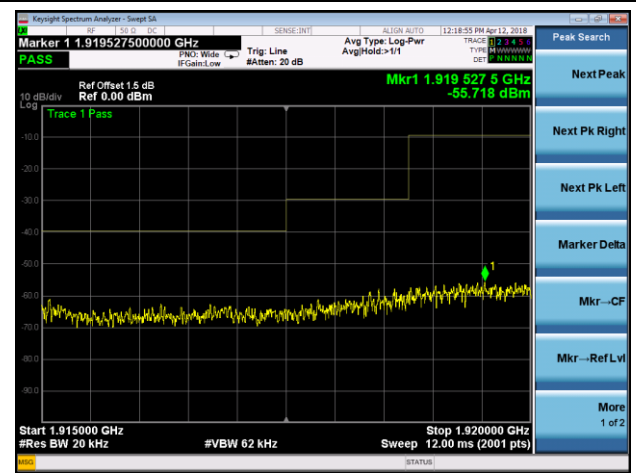

1.93GHz ~ 1.935GHz

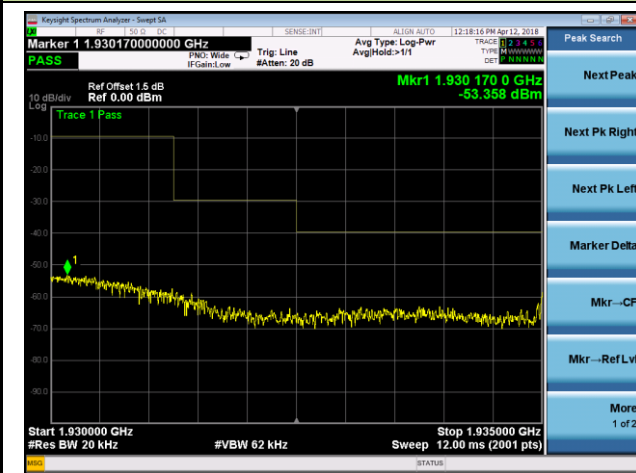

1.935GHz ~ 20GHz

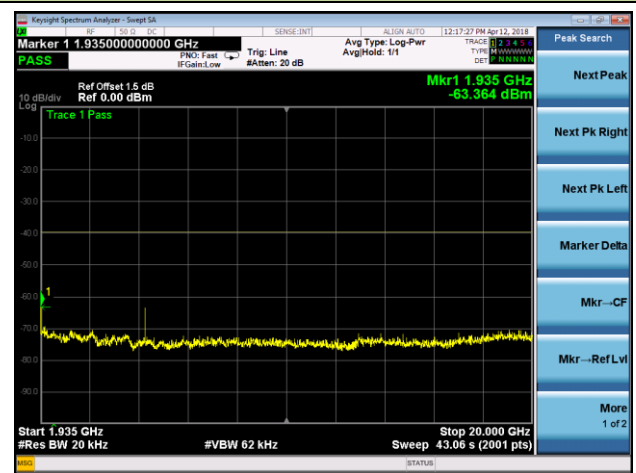

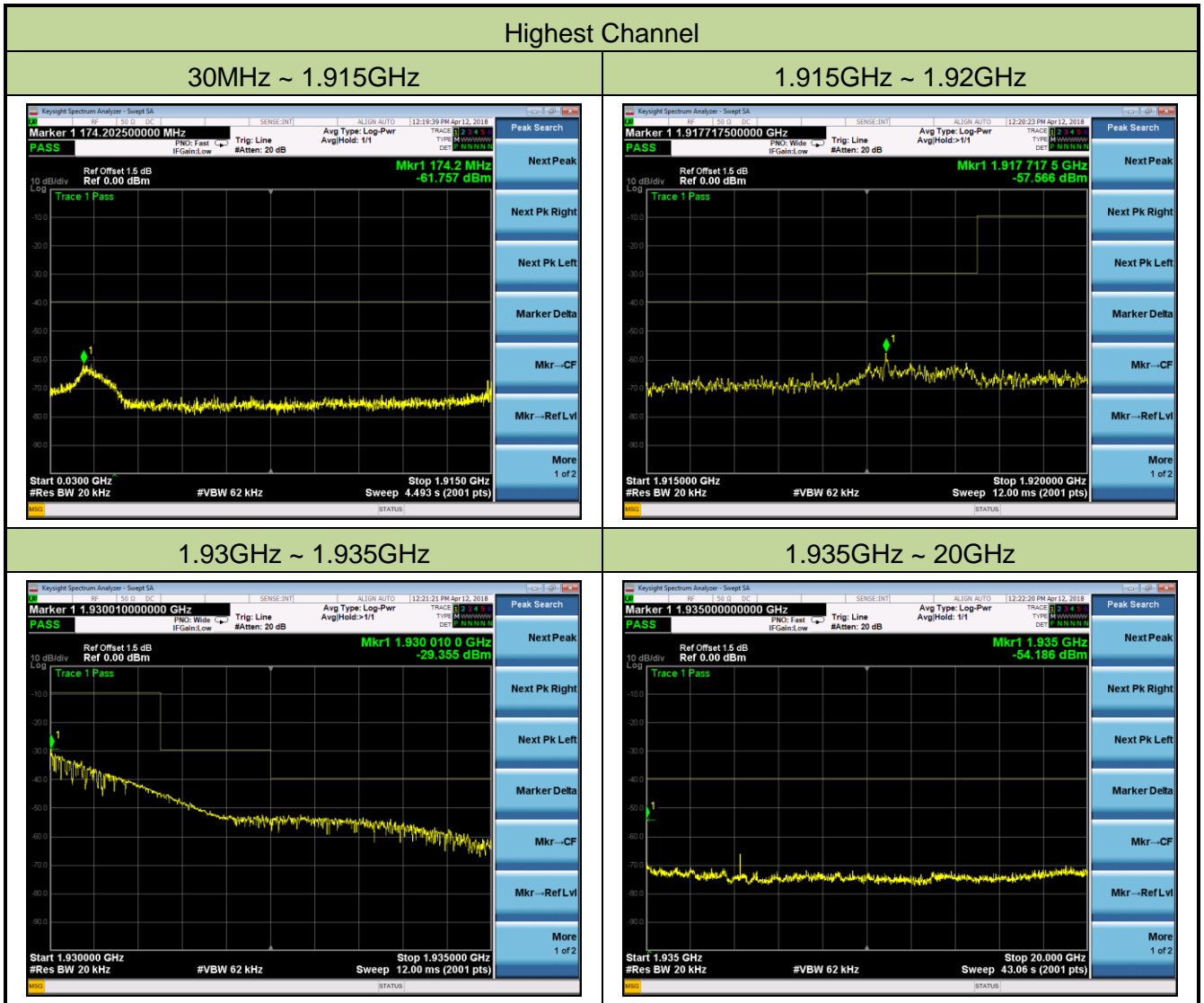

Note: The BS spurious out-of-band transmission level is below the indicated limit.

7.8. Carrier Frequency Stability

7.8.1. Test Limit

Per §15.323(f), the frequency stability of the carrier frequency of the intentional radiator shall be maintained within ± 10 ppm over 1 hour or the interval between channel access monitoring, whichever is shorter. The frequency stability shall be maintained over a temperature variation of -20°C to $+50^{\circ}\text{C}$ at normal supply voltage, and over a variation in the primary supply voltage of 85 percent to 115 percent of the rated supply voltage at a temperature of 20°C . For equipment that is capable only of operating from a battery, the frequency stability tests shall be performed using a new battery without any further requirement to vary supply voltage.

7.8.2. Test Procedure Used

ANSI C63.17, Clause 6.2.1

7.8.3. Test Setup

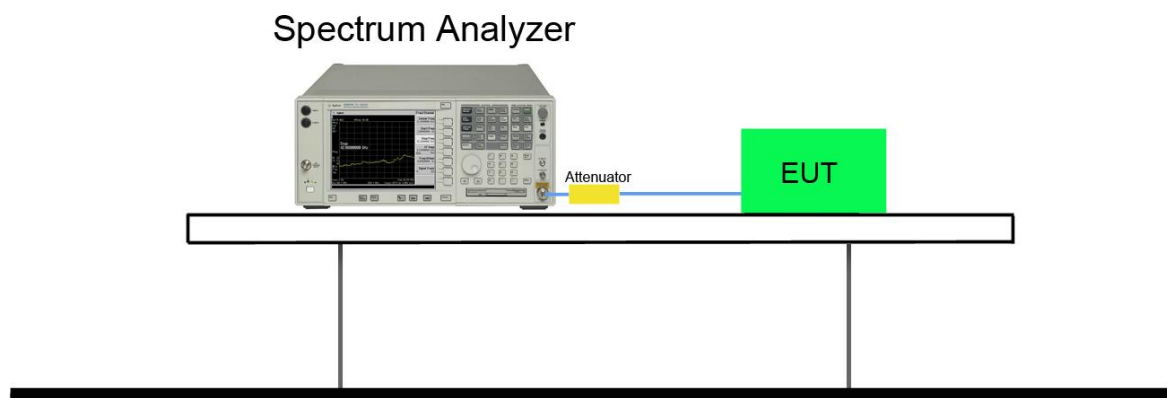

7.8.4. Test Result

The Frequency Stability is measured with the RTX. The RTX was logged by a computer programmed to get the new readings as fast as possible (about 3 readings per second) over the noted time period or number of readings. The peak-to-peak difference was recorded and the mean value and deviation in ppm was calculated.

The Carrier Frequency Stability over power Supply Voltage and over Temperature is measured also with the RTX.

Carrier Frequency Stability over Time at Nominal Temperature

Average Mean Carrier Frequency (MHz)	Max. Diff. (kHz)	Min. Diff. (kHz)	Max Dev. (ppm)	Limit (ppm)
1924.992125	4.8	-0.3	2.7	±10

$$\text{Deviation ppm} = ((\text{Max. Diff.} - \text{Mean. Diff.}) / \text{Mean Carrier Freq.}) \times 10^6$$

Deviation (ppm) is calculated from 3000 readings with the RTX.

Carrier Frequency Stability over Time at Nominal Temperature

Voltage	Measured Carrier Frequency (MHz)	Difference (kHz)	Deviation (ppm)	Limit (ppm)
Vnom	1924.9921	5.1	2.7	±10
85% of Vnom	1924.9925	5.7	3.0	
115% of Vnom	1924.9929	5.9	3.1	

$$\text{Deviation ppm} = ((\text{Mean} - \text{Measured frequency}) / \text{Mean}) \times 10^6$$

Carrier Frequency Stability over Temperature

Voltage	Measured Carrier Frequency (MHz)	Difference (kHz)	Deviation (ppm)	Limit (ppm)
T = +20°C	1924.9921	5.1	2.7	±10
T = -20°C	1924.9923	5.3	2.8	
T = +50°C	1924.9925	4.9	2.5	

$$\text{Deviation ppm} = ((\text{Mean} - \text{Measured frequency}) / \text{Mean}) \times 10^6$$

7.9. Automatic Discontinuation of Transmission

Does the EUT transmit Control and Signaling Information?	<input checked="" type="checkbox"/> YES	<input type="checkbox"/> NO
TYPE OF EUT :	<input checked="" type="checkbox"/> INITIATING DEVICE	<input type="checkbox"/> RESPONDING DEVICE

The following tests simulate the reaction of the EUT in case of either absence of information to transmit or operational failure after a connection with the companion device is established.

Number	Test	EUT Reaction	Verdict
1	Power Removed from EUT	A	Pass
2	Switch Off EUT	N/A	Pass
3	Hook-On by EUT	N/A	Pass
4	Power Removed from Companion Device	B	Pass
5	Switch Off Companion Device	B	Pass
6	Hook-On by Companion Device	B	Pass

A - Connection breakdown, Cease of all transmissions

B - Connection breakdown, EUT transmits control and signaling information

C - Connection breakdown, Companion Device transmits control and signaling information

N/A - Not Applicable (EUT does not have On/Off switch and cannot perform Hook-On)

Requirements, FCC 15.319(f)

The device shall automatically discontinue transmission in case of either absence of information to transmit or operational failure. These provisions are not intended to preclude transmission of control and signaling information or use of repetitive codes used by certain digital technologies to complete frame or burst intervals.

7.10. Specific Requirements for UPCS Device

7.10.1. Monitoring Time Requirements

Immediately prior to initiating transmission, devices must monitor the combined time and spectrum window in which they intend to transmit. For a period of at least 10 milliseconds for systems designed to use a 10 milliseconds or shorter frame period or at least 20 milliseconds for systems designed to use a 20 milliseconds frame period

7.10.1.1. Test Procedure Used

ANSI C63.17, Clause 7.5

7.10.1.2. Test Setup

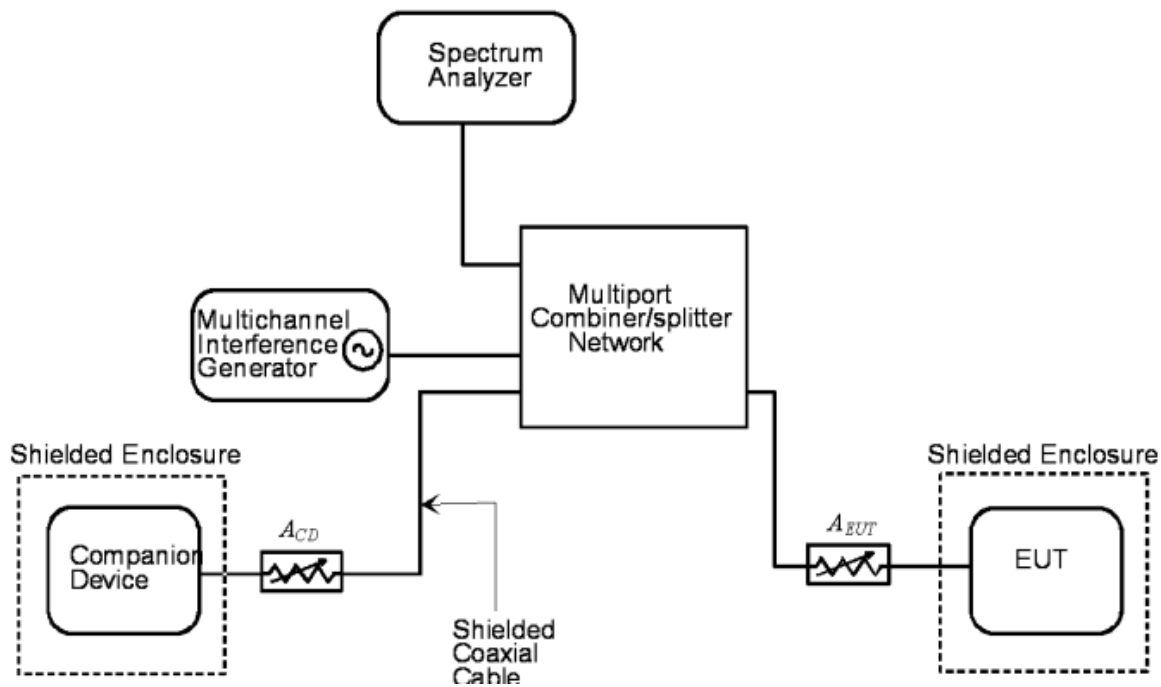

7.10.1.3. Test Result

Interference (Refer to ANSIC63.17 clause 7.3.4)	Reaction of EUT	Results
Apply the interference on f1 at level TU+UM, and no interference on f2. Initiate transmission and verify the transmission on f2.	EUT transmits on f2	Pass
Apply the interference on f2 at level TU+UM, at the same time, no interference on f1. After about 20ms, initiate transmission and verify the transmission on f1.	EUT transmits on f1	Pass

7.10.2.Lowest Monitoring Threshold Requirements

The monitoring threshold must not be more than 30 dB above the thermal noise power for a bandwidth equivalent to the emission bandwidth used by the device.

7.10.2.1. Test Procedure Used

ANSI C63.17, Clause 7.3.1

7.10.2.2. Test Result

Not Apply

7.10.3. Acknowledgements and Transmission Duration Requirements

Occupation of the same combined time and spectrum windows by a device or group of cooperating devices continuously over a period of time longer than 8 hours is not permitted without repeating the access criteria.

Once access to specific combined time and spectrum windows is obtained an acknowledgement from a system participant must be received by the initiating transmitter within one second or transmission must cease.

Periodic acknowledgements must be received at least every 30 seconds or transmission must cease. Channels used exclusively for control and signaling information may transmit continuously for 30 seconds without receiving an acknowledgement, at which time the access criteria must be repeated.

7.10.3.1. Test Procedure Used

ANSI C63.17, Clause 8.2.1 & 8.2.2

7.10.3.2. Test Result

Test ref. to ANSI C63.17 clause 8.2.1	Observation	Verdict
Initial transmission without acknowledgements	Not applicable for EUT that transmits control and signaling information	N/A
Transmission time after loss of acknowledgements	10.0	Pass

Test ref. to ANSI C63.17 clause 8.2.2	Observation	Verdict
Transmission duration on same time and frequency window	Only for initiating device that controls which time slot is used	N/A

7.10.4. Least Interfered Channel (LIC) Selection Requirements

If access to spectrum is not available as determined by the above, and a minimum of 40 duplex system access channels are defined for the system, the time and spectrum windows with the lowest power level below a monitoring threshold of 50 dB above the thermal noise power determined for the emission bandwidth may be accessed.

Calculation of monitoring threshold limits for isochroous devices:

Lowest threshold: $TL = -174 + 10 \log_{10} B + M_u + P_{MAX} - P_{EUT}$ (dBm)

Upper threshold: $TU = -174 + 10 \log_{10} B + M_u + P_{MAX} - P_{EUT}$ (dBm)

Where: B=Emission bandwidth (Hz)

M_u =dB the threshold may exceed thermal noise (30 for T_L & 50 for T_U)

$P_{MAX} = 5 * \log_{10} B - 10$ (dBm)

P_{EUT} =Transmitted power (dBm)

Monitor Threshold	B (MHz)	M_u (dB)	P_{MAX} (dBm)	P_{EUT} (dBm)	Threshold (dBm)
TL	1.418	30	20.76	19.83	-81.55
TU	1.418	50	20.76	19.83	-61.55

The EUT must not transmit until the interference level is less than or equal to:

Measured Threshold Level $\leq TU$

Where: TU =Upper threshold level

7.10.4.1. Test Procedure Used

ANSI C63.17, Clause 7.3.2 & 7.3.3 & 7.3.4

7.10.4.2. Test Result

Monitor threshold	Measured Threshold Level	Limit (dBm)
Lowest Threshold (dBm)	N/A	-81.55
Upper Threshold (dBm)	N/A	-61.55

Note: N/A Not applicable- EUT which supports at least of 40 duplex system access channels and implements Least Interfered Channel (LIC) algorithm is permitted to use an upper monitoring threshold.

7.10.5. Random waiting Requirements

If the selected combined time and spectrum windows are unavailable, the device may either monitor and select different windows or seek to use the same window after waiting an amount of time, randomly chosen from a uniform random distribution between 10 and 150 milliseconds, commencing when the channel becomes available.

7.10.5.1. Test Procedure Used

ANSI C63.17, Clause 8.1.3

7.10.5.2. Test Result

The manufacturer declares that this provision is not utilized by the EUT

7.10.6. Monitoring Bandwidth Requirements

The monitoring system bandwidth must be equal to or greater than the emission bandwidth of the intended transmission and have a maximum reaction time less than $50 \times \text{SQRT}(1.25/\text{emission bandwidth in MHz})$ microseconds for signals at the applicable threshold level but shall not be required to be less than 50 microseconds

7.10.6.1. Test Procedure Used

ANSI C63.17, Clause 7.5

7.10.6.2. Test Result

Test Equation (μs)	B (MHz)	Pulse width(μs)	Limit (us)	Result
$50 (1.25/B)^{1/2}$	1.418	46.94	50	Pass
$25 (1.25/B)^{1/2}$	1.418	23.47	35	Pass

7.10.7. Monitoring Antenna Requirements

The monitoring system shall use the same antenna used for transmission, or an antenna that yields equivalent reception at that location.

7.10.7.1. Test Procedure Used

ANSI C63.17 paragraph 4

7.10.7.2. Test Result

The antenna of the EUT used for transmission is the same interior antenna that used for monitoring.

7.10.8. Monitoring Antenna Requirements

Devices that have a power output Lowest than the maximum permitted under the rules can increase their monitoring detection threshold by one decibel for each one decibel that the transmitter power is below the maximum permitted

7.10.8.1. Test Procedure Used

ANSI C63.17 paragraph 4

7.10.8.2. Test Result

Not apply

7.10.9. Dual Access Criteria Check Requirements

An initiating device may attempt to establish a duplex connection by monitors both its intended transmit and receive time and spectrum windows. If both the intended transmit and receive time and spectrum windows meet the access criteria, then the initiating device can initiate a transmission in the intended transmit time and spectrum window. If the power detected by the responding device can be decoded as a duplex connection signal from the initiating device, then the responding device may immediately begin transmitting on the receive time and spectrum window monitored by the initiating device.

7.10.9.1. Test Procedure Used

ANSI C63.17, Clause 8.3.1 & 8.3.2

7.10.9.2. Test Result

EUT that do NOT implements the LIC procedure:

Test ref. to ANSI C63.17 clause 8.3.1	Observation	Verdict
b) EUT is restricted to a single carrier $f1$ for TDMA systems. The Test is Pass if EUT can transmit	EUT can transmit	Pass
c) d) Interference at level $T_L + U_M$ on all timeslots except one receive slot where interference is at least 10 dB below T_L	No connection possible	N/A
e) f) Interference at level $T_L + U_M$ on all timeslots except one transmit slot where interference is at least 10 dB below T_L	No connection possible	N/A

EUTs that implements the LIC procedure:

Test ref. to ANSI C63.17 clause 8.3.1	Observation	Verdict
b) EUT is restricted to a single carrier $f1$ for TDMA systems. The Test is Pass if EUT can transmit	EUT can transmit	Pass
c) d) Transmission on interference-free receive time/spectrum window	Connected on the target Rx window and its duplex mate.	Pass
e) f) Transmission on interference-free transmit time/spectrum window	Connected on the target Tx window and its duplex mate.	Pass

7.10.10. Alternative monitoring interval for co-located devices Requirements

An initiating device that is prevented from monitoring during its intended transmit window due to monitoring system blocking from the transmissions of a co-located (within one meter) transmitter of the same system, may monitor the portions of the time and spectrum windows in which they intend to receive over a period of at least 10 milliseconds. The monitored time and spectrum window must total at least 50 percent of the 10 millisecond frame interval and the monitored spectrum must be within 1.25 MHz of the center frequency of channel(s) already occupied by that device or co-located co-operating devices. If the access criteria is met for the intended receive time and spectrum window under the above conditions, then transmission in the intended transmit window by the initiating device may commence.

7.10.10.1. Test Procedure Used

ANSI C63.17, Clause 8.4

7.10.10.2. Test Result

The manufacturer declares that this provision is not utilized by the EUT.

7.10.11. Frame Repetition Stability and Period and Jitter

7.10.11.1. Test Limit

The frame period (a set of consecutive time slots in which the position of each time slot can be identified by reference to a synchronizing source) of an intentional radiator operating in this band shall be 20 milliseconds or 10 milliseconds/X where X is a positive whole number. Each device that implements time division for the purposes of maintaining a duplex connection on a given frequency carrier shall maintain a frame repetition rate with a frequency stability of at least 50 parts per million (ppm). Each device which further divides access in time in order to support multiple communication links on a given frequency carrier shall maintain a frame repetition rate with a frequency stability of at least 10 ppm. The jitter (time-related, abrupt, spurious variations in the duration of the frame interval) introduced at the two ends of such a communication link shall not exceed 25 microseconds for any two consecutive transmissions. Transmissions shall be continuous in every time and spectrum window during the frame period defined for the device.

7.10.11.2. Test Procedure Used

ANSI C63.17, Clause 6.2.2 & 6.2.3

7.10.11.3. Test Setup

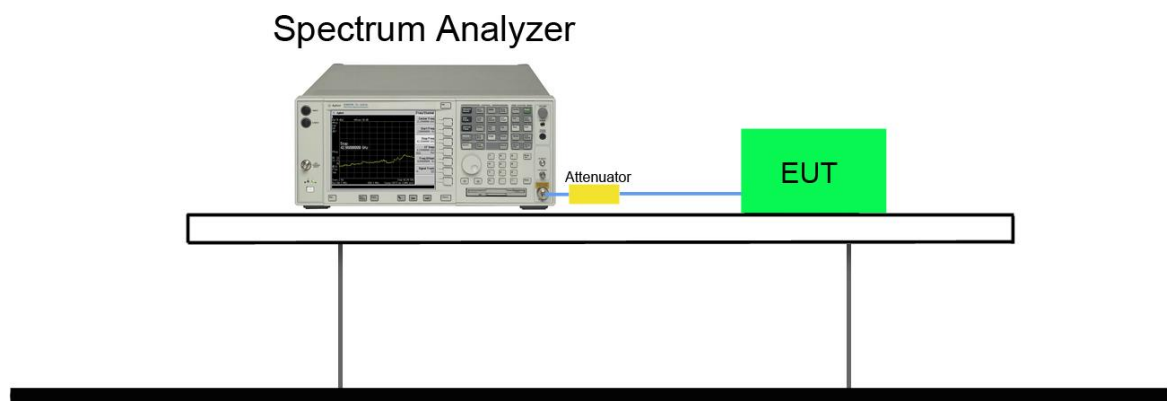

7.10.12. Test Result

Carrier Frequency (MHz)	Frame Jitter (us)					Limit of Δ
	min	mean	max	Δ min	Δ max	
1924.992	-0.7	0	0.7	-0.7	0.7	± 25

8. CONCLUSION

The data collected relate only the item(s) tested and show that the **Boundary Transmitter (DECT)** is in compliance with Part 15C of the FCC Rules & ISED Rules.

————— The End —————