

MEASUREMENT REPORT

FCC PART 15.407

FCC ID: DD4GLXD4Z3

Applicant: Shure Incorporated

Application Type: Certification

Product: Wireless Portable Receiver

Model No.: GLXD4+ Z3

Trade Mark: 

FCC Classification: Unlicensed National Information Infrastructure (UNII)

FCC Rule Part(s): Part15 Subpart E (Section 15.407)

Test Procedure(s): ANSI C63.10-2013, KDB 789033 D02v02r01

Test Date: November 22, 2020 ~ April 07, 2021

Reviewed By:

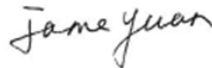

Jame Yuan

Approved By:

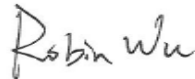

Robin Wu



The test results relate only to the samples tested.

This equipment has been shown to be capable of compliance with the applicable technical standards as indicated in the measurement report and was tested in accordance with the measurement procedures specified in KDB 789033 D02v02r01. Test results reported herein relate only to the item(s) tested.

The test report shall not be reproduced except in full without the written approval of MRT Technology (Suzhou) Co., Ltd.

Revision History

Report No.	Version	Description	Issue Date	Note
2103RSU001-U2	Rev. 01	Initial Report	04-13-2021	Valid

CONTENTS

Description	Page
1. General Information.....	5
1.1. Applicant.....	5
1.2. Manufacturer	5
1.3. Testing Facility	5
2. PRODUCT INFORMATION	6
2.1. Equipment Description.....	6
2.2. Radio Specification	6
2.3. Antenna Details	6
2.4. Test Frequencies.....	7
2.5. Test Mode	7
2.6. Duty Cycle	7
2.7. Test Configuration and Software.....	8
2.8. EMI Suppression Device(s)/Modifications	8
2.9. Labeling Requirements.....	8
2.10. Test Environment Condition.....	8
3. ANTENNA REQUIREMENTS.....	9
4. TEST EQUIPMENT CALIBRATION DATE	10
5. MEASUREMENT UNCERTAINTY.....	14
6. TEST RESULT	15
6.1. Summary	15
6.2. Emission Bandwidth Measurement.....	16
6.2.1. Test Limit	16
6.2.2. Test Procedure Used	16
6.2.3. Test Setting.....	16
6.2.4. Test Setup	16
6.2.5. Test Result.....	17
6.3. 6dB Bandwidth Measurement.....	20
6.3.1. Test Limit	20
6.3.2. Test Procedure Used	20
6.3.3. Test Setting.....	20
6.3.4. Test Setup	20
6.3.5. Test Result.....	21
6.4. Output Power Measurement.....	24
6.4.1. Test Limit	24

6.4.2. Test Procedure Used	24
6.4.3. Test Setting.....	24
6.4.4. Test Setup	24
6.4.5. Test Result.....	25
6.5. Power Spectral Density Measurement	26
6.5.1. Test Limit	26
6.5.2. Test Procedure Used	26
6.5.3. Test Setting.....	26
6.5.4. Test Setup	27
6.5.5. Test Result.....	28
6.6. Frequency Stability Measurement.....	31
6.6.1. Test Limit	31
6.6.2. Test Procedure Used	31
6.6.3. Test Setup	32
6.6.4. Test Result.....	33
6.7. Radiated Spurious Emission Measurement	34
6.7.1. Test Limit	34
6.7.2. Test Procedure Used	34
6.7.3. Test Setting.....	34
6.7.4. Test Setup	36
6.7.5. Test Result.....	37
6.8. Radiated Restricted Band Edge Measurement	45
6.8.1. Test Limit	45
6.8.2. Test Procedure Used	46
6.8.3. Test Setting.....	47
6.8.4. Test Setup	48
6.8.5. Test Result.....	49
6.9. AC Conducted Emissions Measurement.....	57
6.9.1. Test Limit	57
6.9.2. Test Setup	57
6.9.3. Test Result.....	58
7. CONCLUSION.....	60
Appendix A - Test Setup Photograph	61
Appendix B - EUT Photograph.....	62

2. PRODUCT INFORMATION

2.1. Equipment Description

Product Name	Wireless Portable Receiver
Model No.	GLXD4+ Z3
Test Device Label No.	Radiated Sample: 20210301Sample#16 Conducted Sample: 20210301Sample#18
Radio Specification	2.4GHz & 5.8GHz
Operating Temperature	0 ~ 45 °C
Power Type	AC/DC Adapter
Accessories	
AC/DC Adapter	Model No.: PS43US Input Power: 100 - 240V ~ 50/60Hz, Max. 250mA Output Power: 15VDC 600mA

2.2. Radio Specification

Frequency Range	5729 ~ 5846MHz
Bandwidth Mode	Full and Half
Channel Number	55
Channel Spacing	1MHz
Type of Modulation	2-level CPM with Gaussian shaping (basically GFSK)
Antenna Number	2

Note 1: For other features of this EUT, test report will be issued separately.

Note 2: Total working frequencies refer to operation description.

Note 3: Two RF paths and antenna are the same and only one antenna can work during normal operation, it is switchable.

Note 4: All product information is provided by the manufacturer.

2.3. Antenna Details

Antenna Type	Frequency Band (MHz)	Max Peak Gain (dBi)
Dipole Antenna	5729	4.70
	5788	3.93
	5846	3.57

2.4. Test Frequencies

Operating Bands (MHz)	Test Frequency (MHz)		
	Lowest	Middle	Highest
5729 ~ 5871	5729	5788	5846

2.5. Test Mode

Test Mode	Mode 1: Transmit by Full BW
	Mode 2: Transmit by Half BW

Note: Bandwidth abbreviation is BW.

2.6. Duty Cycle

The maximum achievable duty cycles for all modes were determined based on measurements performed on a spectrum analyzer in zero-span mode with RBW = 8MHz, VBW = 50MHz. The RBW and VBW were both greater than 50/T, where T is the minimum transmission duration, and the number of sweep points across T was greater than 100. The duty cycles are as follows:

Test Mode	Duty Cycle
Full BW	60.23%
Half BW	80.49%

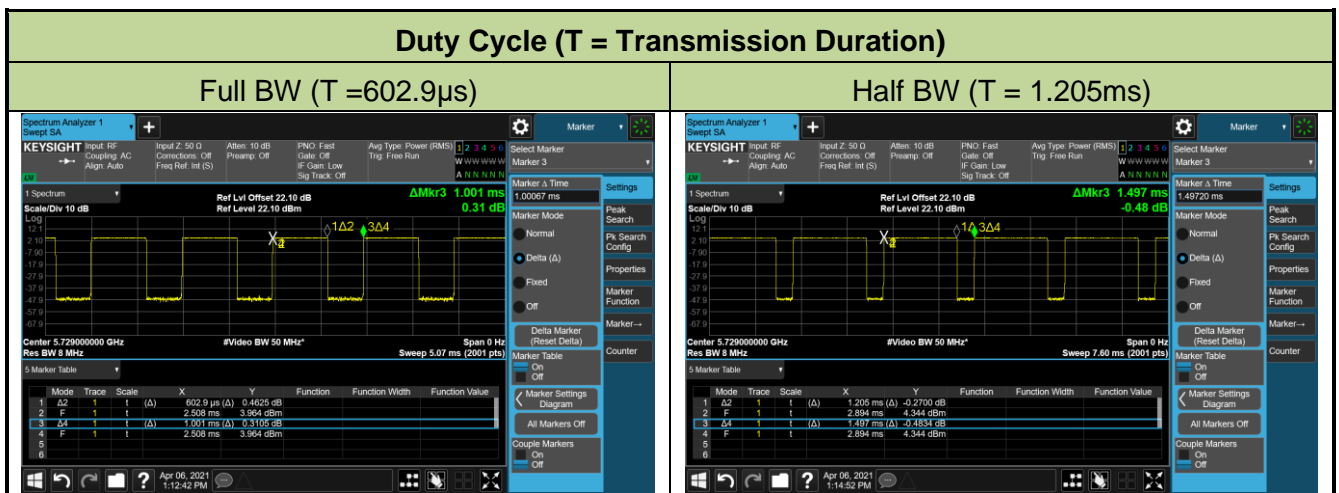

2.7. Test Configuration and Software

The device was tested per the guidance ANSI C63.10: 2013 that was used to reference the appropriate EUT setup for radiated spurious emissions and AC line conducted emission testing.

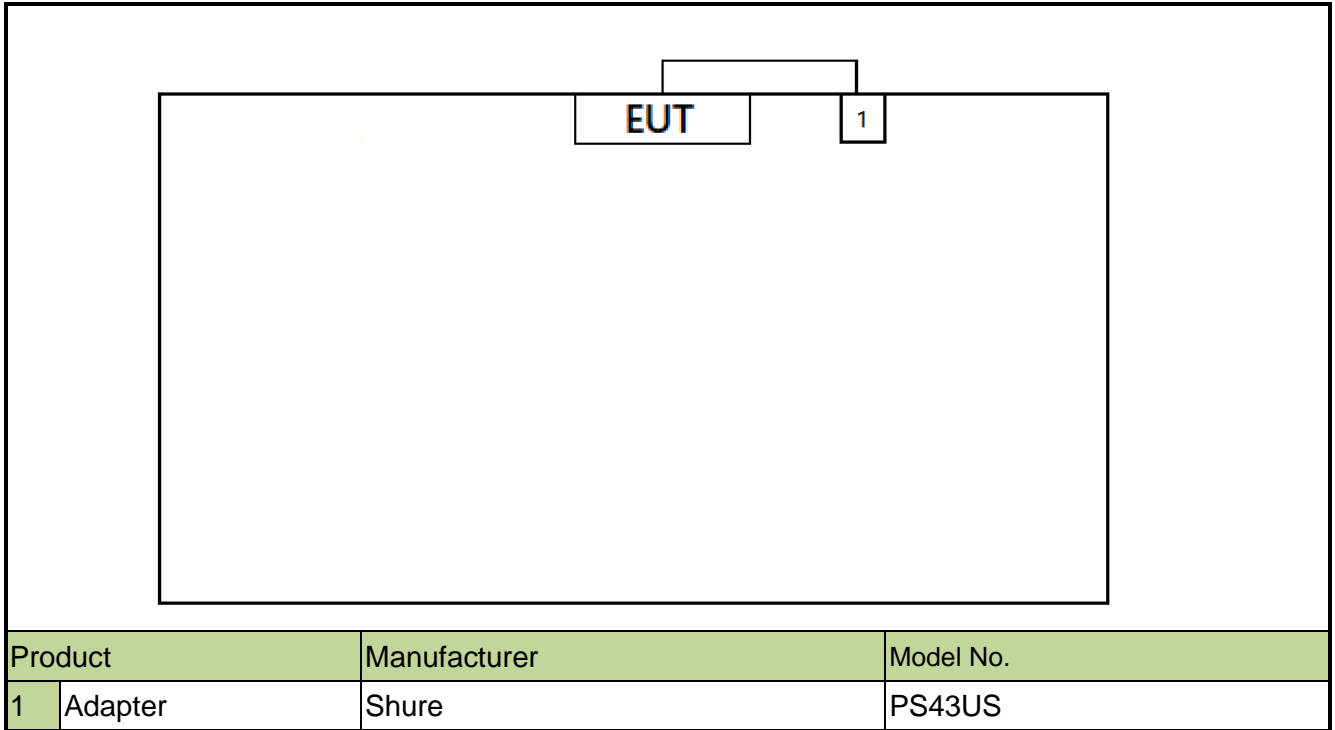

Note 1: The test utility software used during testing was “ttermpro.exe”, and the version was 4.78.

Note 2: Detail power setting refer to operation description.

2.8. EMI Suppression Device(s)/Modifications

No EMI suppression device(s) were added and/or no modifications were made during testing.

2.9. Labeling Requirements

Per 2.1074 & 15.19; Docket 95-19

The label shall be permanently affixed at a conspicuous location on the device; instruction manual or pamphlet supplied to the user and be readily visible to the purchaser at the time of purchase.

However, when the devices so small wherein placement of the label with specified statement is not practical, only the FCC ID must be displayed on the device per Section 15.19(a)(5). Please see attachment for FCC ID label and label location.

2.10. Test Environment Condition

Ambient Temperature	15 ~ 35 °C
Relative Humidity	20 ~ 75 %RH

3. ANTENNA REQUIREMENTS

Excerpt from §15.203 of the FCC Rules/Regulations:

“An intentional radiator antenna shall be designed to ensure that no antenna other than that furnished by the responsible party can be used with the device. The use of a permanently attached antenna or of an antenna that uses a unique coupling to the intentional radiator shall be considered sufficient to comply with the provisions of this section.”

- The antenna of the device is **permanently attached**.
- There are no provisions for connection to an external antenna.

Conclusion:

The unit complies with the requirement of §15.203.

4. TEST EQUIPMENT CALIBRATION DATE

Conducted Emission (WZ-SR2)

Instrument	Manufacturer	Type No.	Asset No.	Cali. Interval	Cali. Due Date
EMI Test Receiver	R&S	ESR3	MRTSUE06185	1 year	2022/01/12
Two-Line V-Network	R&S	ENV216	MRTSUE06002	1 year	2021/09/09
Thermal Hygrometer	testo	608-H1	MRTSUE06404	1 year	2021/07/26
Shielding Room	MIX-BEP	Chamber-SR2	MRTSUE06215	N/A	N/A

Conducted Emission (SIP-SR2)

Instrument	Manufacturer	Type No.	Asset No.	Cali. Interval	Cali. Due Date
EMI Test Receiver	R&S	ESR3	MRTSUE06613	1 year	2021/07/02
Two-Line V-Network	R&S	ENV216	MRTSUE06003	1 year	2021/09/09
Thermal Hygrometer	testo	608-H1	MRTSUE06621	1 year	2021/12/03

Radiated Emission (WZ-AC1)

Instrument	Manufacturer	Type No.	Asset No.	Cali. Interval	Cali. Due Date
EMI Test Receiver	R&S	ESR7	MRTSUE06001	1 year	2022/01/12
PXA Signal Analyzer	Keysight	N9030B	MRTSUE06395	1 year	2021/08/30
Loop Antenna	Schwarzbeck	FMZB 1519	MRTSUE06025	1 year	2021/10/22
Bilog Period Antenna	Schwarzbeck	VULB 9168	MRTSUE06172	1 year	2021/08/08
Horn Antenna	Schwarzbeck	BBHA 9120D	MRTSUE06023	1 year	2021/09/27
Horn Antenna	Schwarzbeck	BBHA9170	MRTSUE06597	1 year	2021/12/14
Microwave System Amplifier	Agilent	83017A	MRTSUE06076	1 year	2021/11/14
Preamplifier	Schwarzbeck	BBV 9721	MRTSUE06121	1 year	2021/06/11
Thermal Hygrometer	testo	608-H1	MRTSUE06403	1 year	2021/07/26
Anechoic Chamber	TDK	Chamber-AC1	MRTSUE06212	1 year	2021/04/30

Radiated Emission (WZ-AC2)

Instrument	Manufacturer	Type No.	Asset No.	Cali. Interval	Cali. Due Date
MXE EMI Receiver	Keysight	N9038A	MRTSUE06125	1 year	2021/07/02
Loop Antenna	Schwarzbeck	FMZB 1519	MRTSUE06025	1 year	2021/10/22
Bilog Period Antenna	Schwarzbeck	VULB 9162	MRTSUE06022	1 year	2021/05/26
Broad-Band Horn Antenna	Schwarzbeck	BBHA 9120D	MRTSUE06171	1 year	2021/10/25
Horn Antenna	Schwarzbeck	BBHA9170	MRTSUE06597	1 year	2021/12/14
Broadband Coaxial Preamplifier	Schwarzbeck	BBV 9718	MRTSUE06176	1 year	2021/11/14
Preamplifier	Schwarzbeck	BBV 9721	MRTSUE06121	1 year	2021/06/11
Thermal Hygrometer	Minggao	ETH529	MRTSUE06170	1 year	2021/12/08
Anechoic Chamber	RIKEN	Chamber-AC2	MRTSUE06213	1 year	2021/04/30

Radiated Emission (SIP-AC1)

Instrument	Manufacturer	Type No.	Asset No.	Cali. Interval	Cali. Due Date
EMI Test Receiver	R&S	ESR3	MRTSUE06612	1 year	2021/07/02
EXA Signal Analyzer	Keysight	N9010B	MRTSUE06559	1 year	2021/07/23
Loop Antenna	Schwarzbeck	FMZB 1519	MRTSUE06025	1 year	2021/10/22
Bilog Period Antenna	Schwarzbeck	VULB9168	MRTSUE06645	1 year	2021/08/30
Double Ridged Horn Antenna	R&S	HF907	MRTSUE06610	1 year	2021/08/30
Preamplifier	EMCI	EMC051845SE	MRTSUE06600	1 year	2021/11/09
Thermal Hygrometer	testo	608-H1	MRTSUE06620	1 year	2021/12/03
Anechoic Chamber	RIKEN	SIP-SIP-AC1	MRTSUE06554	1 year	2021/12/24

Radiated Emission (SIP-AC2)

Instrument	Manufacturer	Type No.	Asset No.	Cali. Interval	Cali. Due Date
EMI Test Receiver	R&S	ESR3	MRTSUE06613	1 year	2021/07/02
MXA Signal Analyzer	Keysight	N9020B	MRTSUE06604	1 year	2021/09/26
Loop Antenna	Schwarzbeck	FMZB 1519	MRTSUE06025	1 year	2021/10/22
Bilog Period Antenna	Schwarzbeck	VULB9168	MRTSUE06646	1 year	2021/08/30
Horn Antenna	Schwarzbeck	BBHA9120D	MRTSUE06648	1 year	2021/11/26
Horn Antenna	Schwarzbeck	BBHA9170	MRTSUE06599	1 year	2021/11/26
Preamplifier	EMCI	EMC051845SE	MRTSUE06644	1 year	2021/11/09
Preamplifier	EMCI	EMC184045SE	MRTSUE06602	1 year	2021/10/12
Thermal Hygrometer	testo	608-H1	MRTSUE06624	1 year	2021/12/03
Anechoic Chamber	RIKEN	SIP-AC2	MRTSUE06781	1 year	2021/12/24

Radiated Emission (SIP-AC3)

Instrument	Manufacturer	Type No.	Asset No.	Cali. Interval	Cali. Due Date
EMI Test Receiver	R&S	ESR3	MRTSUE06612	1 year	2021/07/02
EXA Signal Analyzer	Keysight	N9010B	MRTSUE06559	1 year	2021/07/23
Loop Antenna	Schwarzbeck	FMZB 1519	MRTSUE06025	1 year	2021/10/22
Bilog Period Antenna	Schwarzbeck	VULB9168	MRTSUE06647	1 year	2021/08/08
Double Ridged Horn Antenna	R&S	HF907	MRTSUE06611	1 year	2021/09/13
Horn Antenna	Schwarzbeck	BBHA9170	MRTSUE06598	1 year	2021/11/26
Preamplifier	EMCI	EMC012645SE	MRTSUE06642	1 year	2022/01/15
Preamplifier	EMCI	EMC184045SE	MRTSUE06641	1 year	2022/01/15
Thermal Hygrometer	testo	608-H1	MRTSUE06622	1 year	2021/12/03
Anechoic Chamber	RIKEN	SIP-AC3	MRTSUE06782	1 year	2021/12/24

Conducted Test Equipment (WZ-TR3)

Instrument	Manufacturer	Type No.	Asset No.	Cali. Interval	Cali. Due Date
EXA Signal Analyzer	Agilent	N9020A	MRTSUE06106	1 year	2022/04/13
EXA Signal Analyzer	Keysight	N9010B	MRTSUE06607	1 year	2022/01/07
Signal Analyzer	R&S	FSV40	MRTSUE06218	1 year	2022/04/13
Power Meter	Agilent	U2021XA	MRTSUE06030	1 year	2021/10/22
USB wideband power sensor	Keysight	U2021XA	MRTSUE06446	1 year	2021/08/30
USB wideband power sensor	Keysight	U2021XA	MRTSUE06447	1 year	2021/08/08
Bluetooth Test Set	Anritsu	MT8852B-042	MRTSUE06389	1 year	2021/06/11
Audio Analyzer	Agilent	U8903B	MRTSUE06143	1 year	2021/06/11
Modulation Analyzer	HP	HP8901A	MRTSUE06098	1 year	2021/09/26
Wideband Radio Communication Tester	R&S	CMW 500	MRTSUE06243	1 year	2021/10/20
DC Power Supply	GWINSTEK	DPS-3303C	MRTSUE06064	N/A	N/A
Temperature & Humidity Chamber	BAOYT	BYH-150CL	MRTSUE06051	1 year	2021/10/22
Thermal Hygrometer	testo	608-H1	MRTSUE06401	1 year	2021/07/26
Attenuator	MVE	6dB	MRTSUE06534	1 year	N/A
Attenuator	MVE	10dB	MRTSUE06543	1 year	N/A

Conducted Test Equipment (SIP-SR5)

Instrument	Manufacturer	Type No.	Asset No.	Cali. Interval	Cali. Due Date
Signal Analyzer	R&S	FSV40	MRTSUE06218	1 year	2022/04/13
PXA Signal Analyzer	Keysight	N9030B	MRTSUE06395	1 year	2021/08/30
USB wideband power sensor	Agilent	U2021XA	MRTSUE06595	1 year	2021/09/26
USB wideband power sensor	Agilent	U2021XA	MRTSUE06596	1 year	2021/09/26
Wideband Radio Communication Tester	R&S	CMW 500	MRTSUE06243	1 year	2021/10/20
Bluetooth Test Set	Anritsu	MT8852B-042	MRTSUE06389	1 year	2021/06/11
Temperature Chamber	BAOYT	BYG-408CS	MRTSUE06847	1 year	2022/02/23
Thermal Hygrometer	testo	622	MRTSUE06629	1 year	2021/11/25

Software	Version	Function
EMI Software	V3	EMI Test Software

5. MEASUREMENT UNCERTAINTY

Where relevant, the following test uncertainty levels have been estimated for tests performed on the EUT as specified in CISPR 16-4-2. This uncertainty represents an expanded uncertainty expressed at approximately the 95% confidence level using a coverage factor of $k = 2$.

AC Conducted Emission Measurement
Measurement Uncertainty for a Level of Confidence of 95% ($U=2Uc(y)$): 9kHz~150kHz: 3.74dB 150kHz~30MHz: 3.44dB
Radiated Disturbance
Measurement Uncertainty for a Level of Confidence of 95% ($U=2Uc(y)$): Horizontal: 30MHz~300MHz: 5.04dB 300MHz~1GHz: 4.95dB 1GHz~40GHz: 6.40dB Vertical: 30MHz~300MHz: 5.24dB 300MHz~1GHz: 6.03dB 1GHz~40GHz: 6.40dB
Spurious Emissions, Conducted
Measuring Uncertainty for a Level of Confidence of 95% ($U=2Uc(y)$): 0.78dB
Output Power
Measuring Uncertainty for a Level of Confidence of 95% ($U=2Uc(y)$): 1.13dB
Power Spectrum Density
Measuring Uncertainty for a Level of Confidence of 95% ($U=2Uc(y)$): 1.15dB
Occupied Bandwidth
Measuring Uncertainty for a Level of Confidence of 95% ($U=2Uc(y)$): 0.28%

6. TEST RESULT

6.1. Summary

FCC Section(s)	Test Description	Test Limit	Test Condition	Test Result	Reference
15.407(a)	26dB Bandwidth	N/A	Conducted	N/A	Section 6.2
15.407(e)	6dB Bandwidth	$\geq 500\text{kHz}$		Pass	Section 6.3
15.407(a) (3)	Maximum Conducted Output Power	$\leq 1\text{W}$		Pass	Section 6.4
15.407(a) (3)	Power Spectral Density	$\leq 30\text{dBm}/500\text{kHz}$		Pass	Section 6.6
15.407(g)	Frequency Stability	N/A		N/A	Section 6.7
15.407(b) (4)(i)	Undesirable Emissions	$\leq -27\text{dBm}/\text{MHz}$ EIRP Detail see section 6.9	Radiated	Pass	Section 6.8 Section 6.9
15.205, 15.209 15.407(b)(5), (6), (7)	General Field Strength (Restricted Bands and Radiated Emission)	Emissions in restricted bands must meet the radiated limits detailed in 15.209		Pass	
15.207	AC Conducted Emissions 150kHz-30MHz	< FCC 15.207 limits	Line Conducted	Pass	Section 6.10

Notes:

- 1) The analyzer plots shown in this section were all taken with a correction table loaded into the analyzer. The correction table was used to account for the losses of the cables and attenuators used as part of the system to connect the EUT to the analyzer at all frequencies of interest.
- 2) "N/A" means that the test item is not applicable, and the details refer to relevant section.
- 3) Test Item "Output Power" was assessed two antenna ports, any others test items were assessed the worst case antenna port.

6.2. Emission Bandwidth Measurement

6.2.1. Test Limit

N/A

6.2.2. Test Procedure Used

KDB 789033 D02v02r01 -Section C.1

6.2.3. Test Setting

1. Set RBW = approximately 1% of the emission bandwidth.
2. Set the VBW > RBW.
3. Detector = Peak.
4. Trace mode = max hold.
5. Measure the maximum width of the emission that is 26 dB down from the maximum of the emission. Compare this with the RBW setting of the analyzer. Readjust RBW and repeat measurement as needed until the RBW/EBW ratio is approximately 1%.

6.2.4. Test Setup

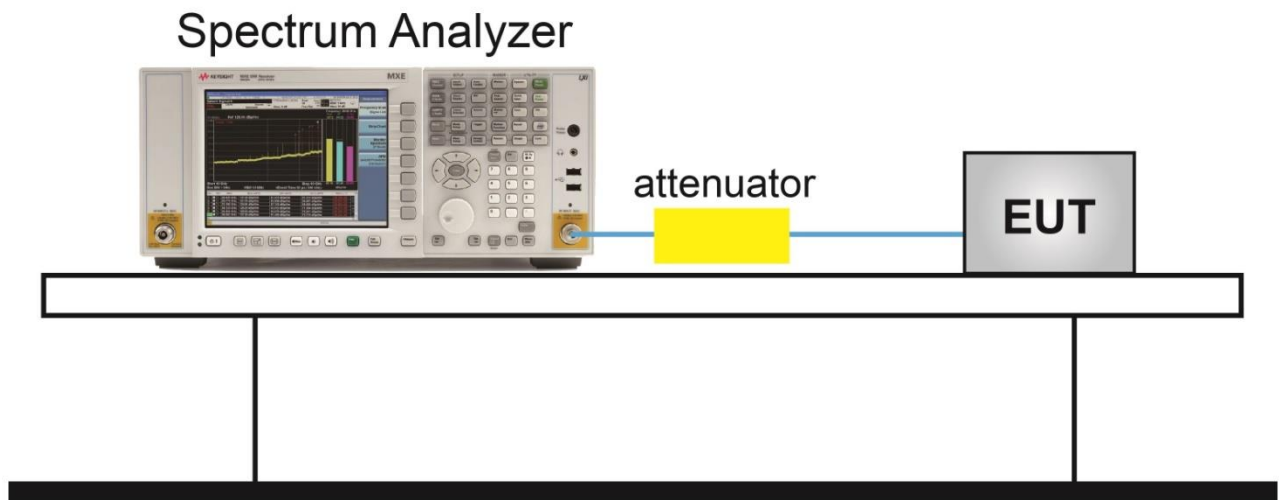

6.2.5. Test Result

Test Site	SIP-SR5	Test Engineer	Alisa Deng
Test Date	2021/04/06		
Antenna Port	Ant 0		

Test Mode	Frequency (MHz)	26dB Bandwidth (MHz)
Full BW	5729	4.00
Full BW	5788	4.00
Full BW	5846	4.00
Half BW	5729	2.00
Half BW	5788	2.00
Half BW	5846	2.00

Full BW 26dB Bandwidth

Channel 149 (5729MHz)

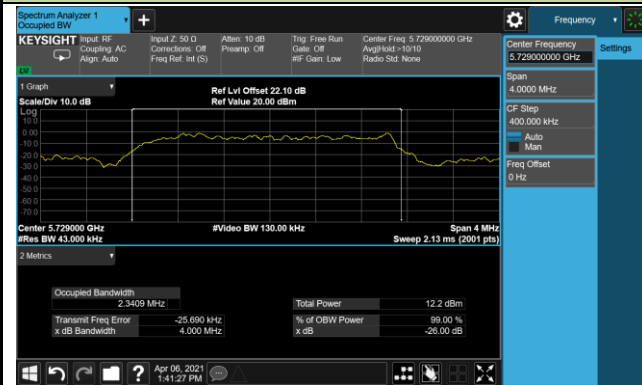

Channel 157 (5788MHz)



Channel 165 (5846MHz)



Half BW 26dB Bandwidth

Channel 149 (5729MHz)



Channel 157 (5788MHz)



Channel 165 (5846MHz)

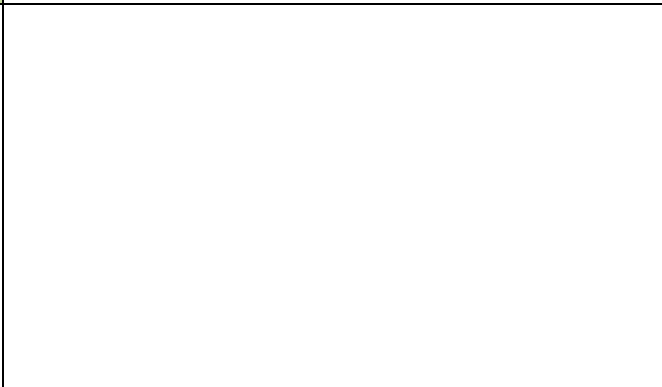
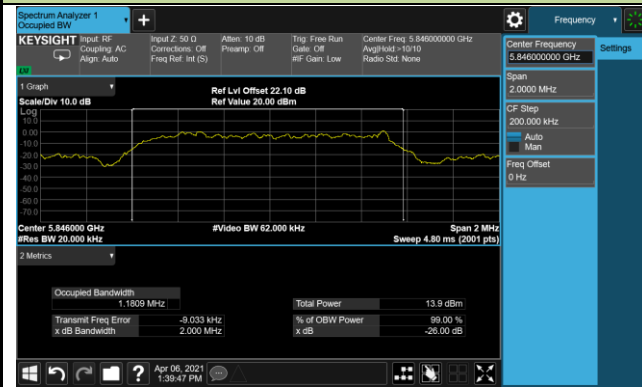

6.3. 6dB Bandwidth Measurement

6.3.1. Test Limit

The minimum 6dB bandwidth shall be at least 500 kHz.

6.3.2. Test Procedure Used

KDB 789033 D02v02r01 - Section C.2

6.3.3. Test Setting

1. Set center frequency to the nominal EUT channel center frequency.
2. RBW = 100 kHz.
3. VBW $\geq 3 \times$ RBW.
4. Detector = Peak.
5. Trace mode = Max hold.
6. Sweep = Auto couple.
7. Allow the trace to stabilize.
8. Measure the maximum width of the emission that is constrained by the frequencies associated with the two outermost amplitude points (upper and lower frequencies) that are attenuated by 6 dB relative to the maximum level measured in the fundamental emission.

6.3.4. Test Setup

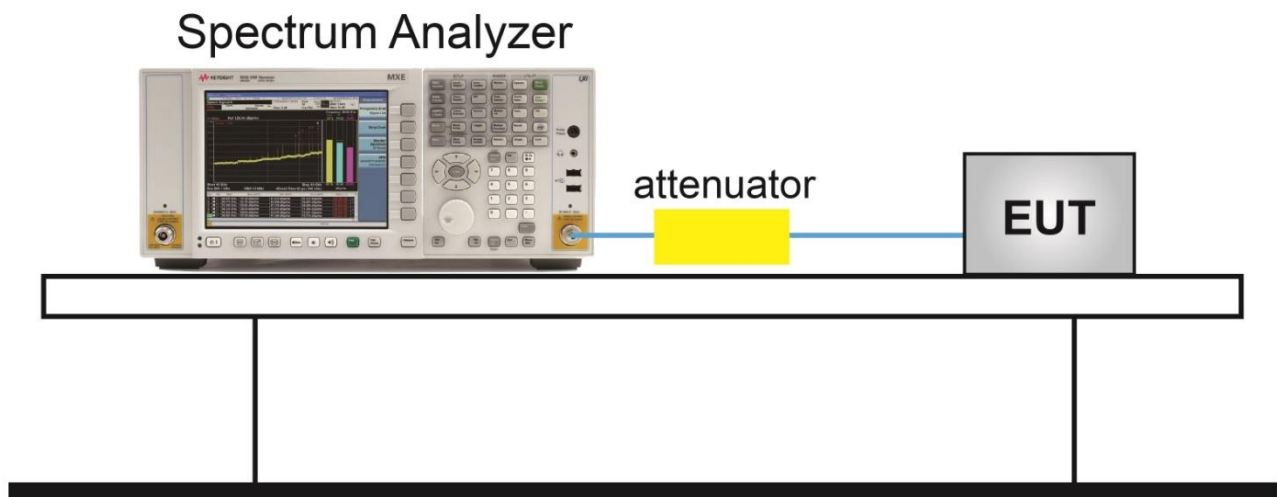

6.3.5. Test Result

Test Site	SIP-SR5	Test Engineer	Alisa Deng
Test Date	2021/04/06		
Antenna Port	Ant 0		

Test Mode	Frequency (MHz)	6dB Bandwidth (MHz)	Limit (MHz)	Result
Full BW	5729	2.037	≥ 0.5	Pass
Full BW	5788	2.041	≥ 0.5	Pass
Full BW	5846	2.028	≥ 0.5	Pass
Half BW	5729	1.032	≥ 0.5	Pass
Half BW	5788	1.025	≥ 0.5	Pass
Half BW	5846	1.027	≥ 0.5	Pass



Half BW 6dB Bandwidth

Channel 149 (5729MHz)

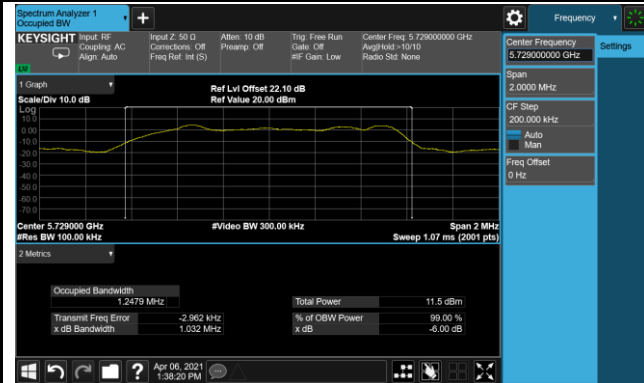

Channel 157 (5788MHz)

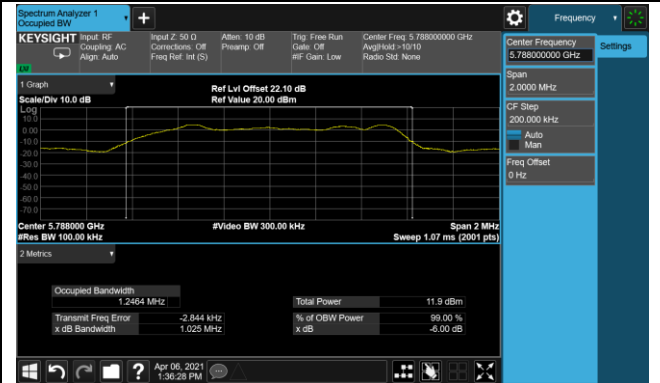

Channel 165 (5846MHz)

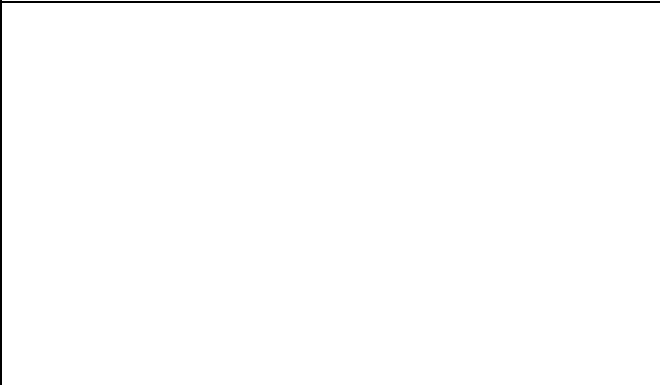
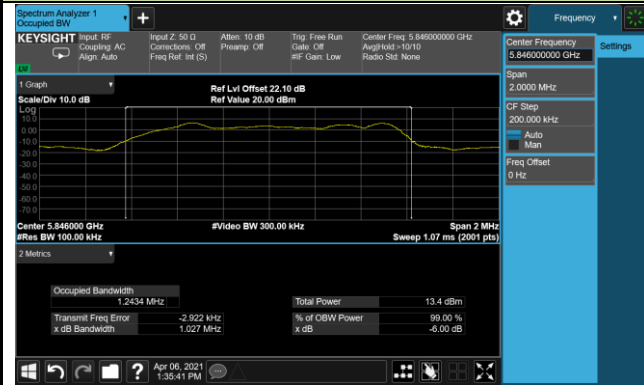

6.4. Output Power Measurement

6.4.1. Test Limit

For the band 5.725-5.85 GHz, the maximum conducted output power over the frequency band of operation shall not exceed 1 W (30dBm).

If transmitting antennas of directional gain greater than 6dBi are used, the maximum conducted output power shall be reduced by the amount in dB that the directional gain of the antenna exceeds 6dBi.

6.4.2. Test Procedure Used

KDB 789033D02v02r01- Section E)3)b) Method PM-G

6.4.3. Test Setting

Average power measurements were performed only when the EUT was transmitting at its maximum power control level using a broadband power meter with a pulse sensor. The power meter implemented triggering and gating capabilities which were set up such that power measurements were recorded only during the ON time of the transmitter.

6.4.4. Test Setup

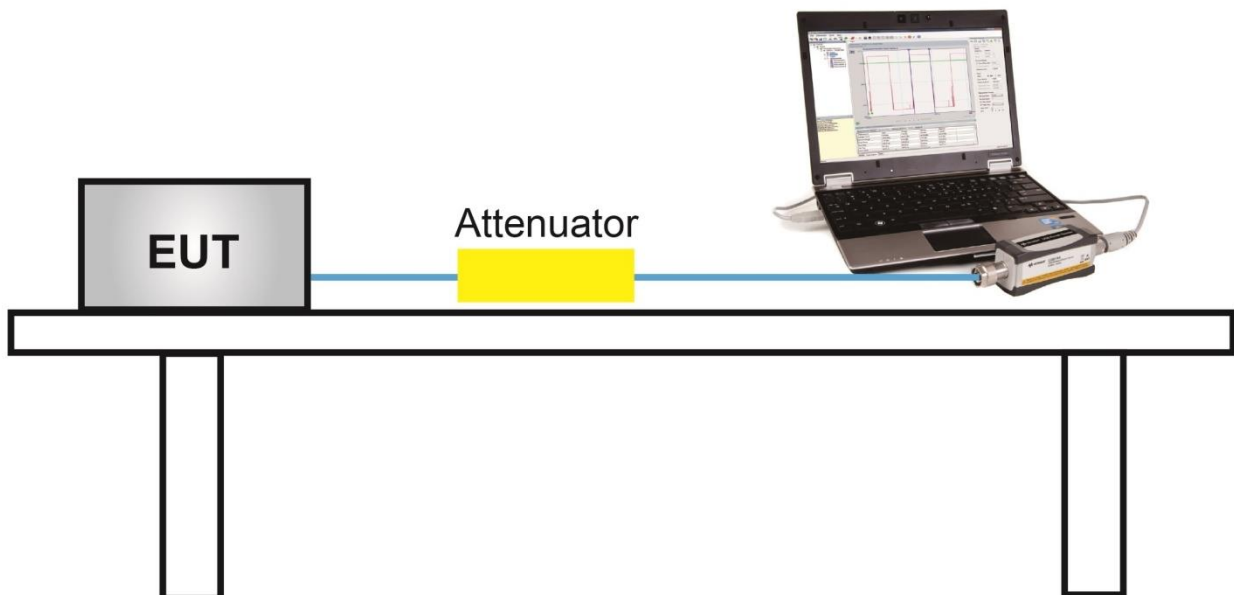

6.4.5. Test Result

Test Site	SIP-SR5	Test Engineer	Alisa Deng
Test Date	2021/03/24		

Test Mode	Freq. (MHz)	Average Power (dBm)		Average Power Limit (dBm)	Result
		Ant 0	Ant 1		
Full BW	5729	4.28	3.48	≤ 30.00	Pass
Full BW	5788	4.75	3.91	≤ 30.00	Pass
Full BW	5846	6.15	5.59	≤ 30.00	Pass
Half BW	5729	4.07	3.30	≤ 30.00	Pass
Half BW	5788	4.76	6.02	≤ 30.00	Pass
Half BW	5846	6.17	5.59	≤ 30.00	Pass

6.5. Power Spectral Density Measurement

6.5.1. Test Limit

For the band 5.725-5.85 GHz, the maximum power spectral density shall not exceed 30 dBm in any 500-kHz band.

If transmitting antennas of directional gain greater than 6dBi are used, the peak power spectral density shall be reduced by the amount in dB that the directional gain of the antenna exceeds 6dBi.

6.5.2. Test Procedure Used

KDB 789033 D02v02r01 - Section F

6.5.3. Test Setting

1. Analyzer was set to the center frequency of the UNII channel under investigation
2. Span was set to encompass the entire 26dB EBW of the signal.
RBW = 510kHz
VBW = 1.5MHz
3. Number of sweep points $\geq 2 \times (\text{span} / \text{RBW})$
4. Detector = Power averaging (Average)
5. Trace average at least 100 traces in power averaging (rms) mode
6. Sweep time = Auto
7. Trigger = Free run
8. Use the peak search function on the instrument to find the peak of the spectrum and record its value.
9. Add $10 \cdot \log(1/x)$, where x is the duty cycle, to the measured power in order to compute the average power during the actual transmission times (because the measurement represents an average over both the on and off times of the transmission). For example, add $10 \cdot \log(1/0.25) = 6$ dB if the duty cycle is 25 percent.

6.5.4. Test Setup

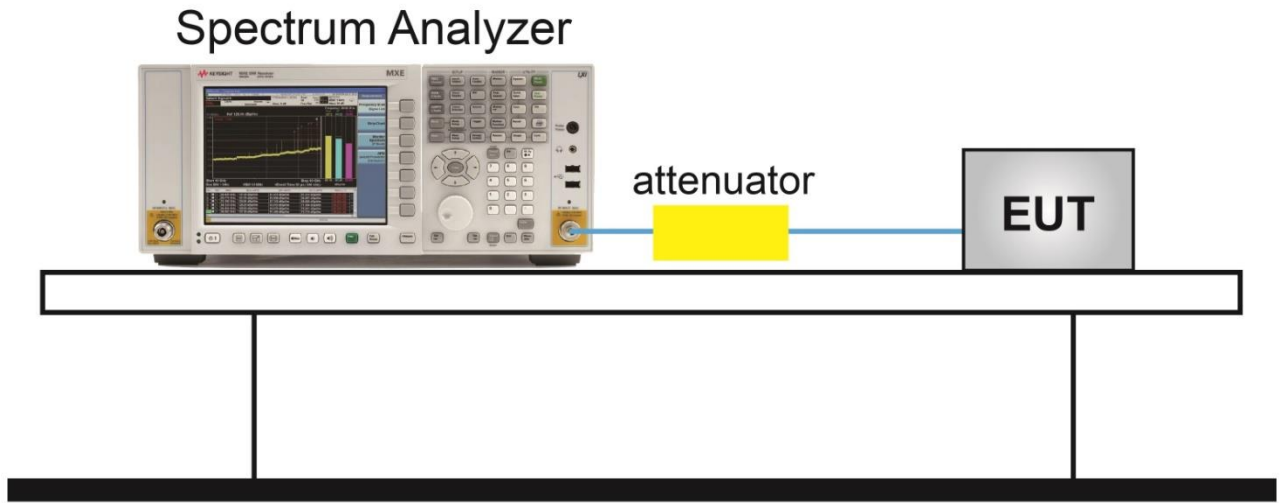

6.5.5. Test Result

Test Site	SIP-SR5	Test Engineer	Alisa Deng
Test Date	2021/04/06	Test Item	Power Spectral Density
Antenna Port	Ant 0		

Test Mode	Freq. (MHz)	Duty Cycle (%)	Final PSD (dBm/ 500kHz)	Limit (dBm/500kHz)	Result
Full BW	5729	60.23	-0.58	≤ 30.00	Pass
Full BW	5788	60.23	0.93	≤ 30.00	Pass
Full BW	5846	60.23	2.04	≤ 30.00	Pass
Half BW	5729	80.49	1.57	≤ 30.00	Pass
Half BW	5788	80.49	2.39	≤ 30.00	Pass
Half BW	5846	80.49	3.95	≤ 30.00	Pass

Note:

When EUT duty cycle > 98%, Final PSD (dBm / 500kHz) = PSD (dBm / 500kHz).

When EUT duty cycle < 98%, Final PSD (dBm / 500kHz) = PSD (dBm / 500kHz) + 10*log(1/Duty cycle)

Full BW Power Spectral Density

Channel 149 (5729MHz)



Channel 157 (5788MHz)

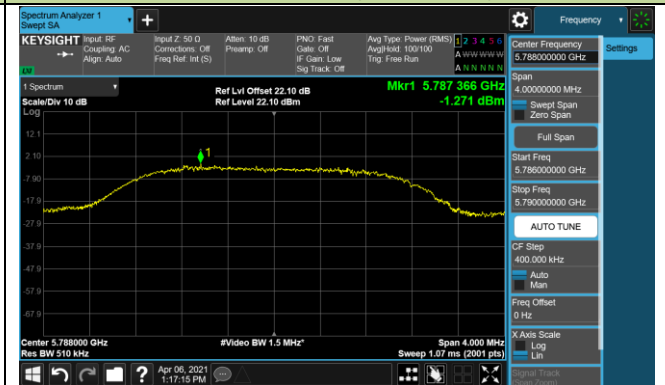

Channel 165 (5846MHz)

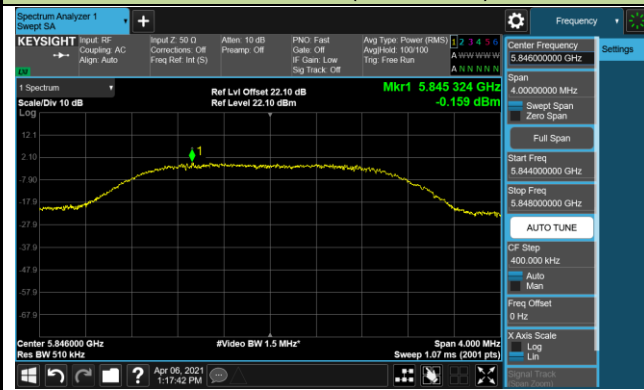

Half BW Power Spectral Density

Channel 149 (5729MHz)

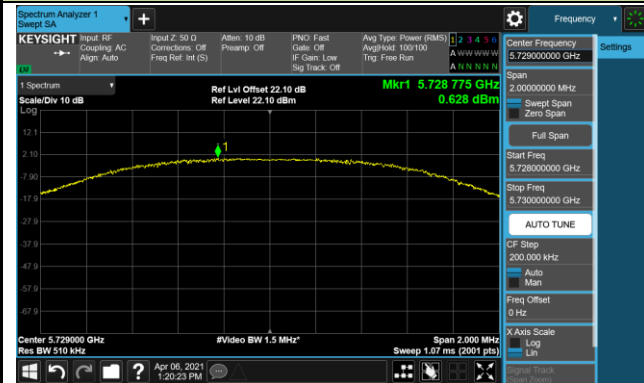

Channel 157 (5788MHz)



Channel 165 (5846MHz)



6.6. Frequency Stability Measurement

6.6.1. Test Limit

Manufacturers of U-NII devices are responsible for ensuring frequency stability such that an emission is maintained within the band of operation under all conditions of normal operation as specified in the user's manual.

6.6.2. Test Procedure Used

Frequency Stability Under Temperature Variations:

The equipment under test was connected to an external AC or DC power supply and input rated voltage. RF output was connected to a frequency counter or spectrum analyzer via feed through attenuators. The EUT was placed inside the temperature chamber. Set the spectrum analyzer RBW low enough to obtain the desired frequency resolution and measure EUT 20°C operating frequency as reference frequency. Turn EUT off and set the chamber temperature to highest. After the temperature stabilized for approximately 30 minutes recorded the frequency. Repeat step measure with 10°C decreased per stage until the lowest temperature reached.

Frequency Stability Under Voltage Variations:

Set chamber temperature to 20°C. Use a variable AC power supply / DC power source to power the EUT and set the voltage to rated voltage. Set the spectrum analyzer RBW low enough to obtain the desired frequency resolution and recorded the frequency.

Reduce the input voltage to specify extreme voltage variation ($\pm 15\%$) and endpoint, record the maximum frequency change. For hand-carried battery-powered equipment, primary supply voltage is reduced to the battery operating end point which shall be specified by the manufacturer.

6.6.3. Test Setup

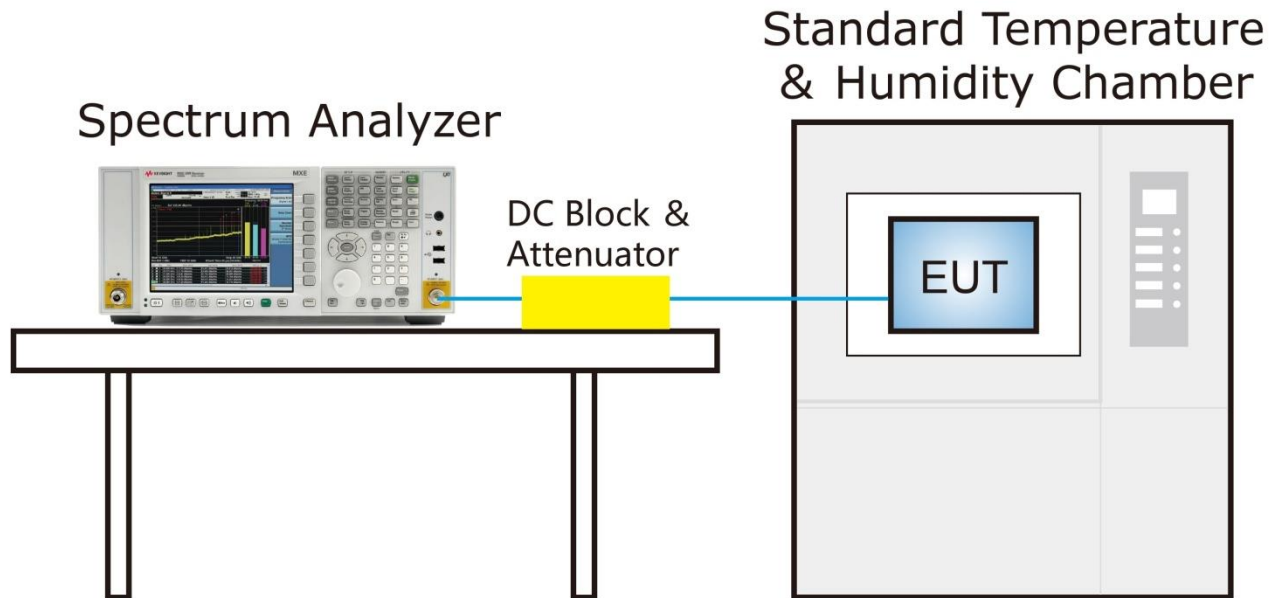

6.6.4. Test Result

Test Site	SIP-SR5	Test Engineer	Alisa Deng
Test Date	2021/04/06	Test Mode	5729MHz (Carrier Mode)

Voltage (%)	Power (V _{AC})	Temp (°C)	Frequency Tolerance (ppm)			
			0 minutes	2 minutes	5 minutes	10 minutes
100%	120	- 30	-3.39	-3.43	-3.48	-3.40
		- 20	-3.12	-3.12	-3.23	-3.16
		- 10	-2.36	-2.25	-2.31	-2.46
		0	-2.57	-2.81	-2.85	-2.65
		+ 10	-3.57	-3.44	-3.39	-3.55
		+ 20 (Ref)	-5.01	-4.97	-5.04	-4.98
		+ 30	-6.92	-6.81	-7.14	-7.06
		+ 40	-8.71	-8.62	-8.73	-8.66
		+ 50	-9.03	-9.18	-9.12	-9.00
110%	132	+ 20	-5.59	-5.51	-5.67	-5.67
90%	108	+ 20	-5.67	-5.64	-5.64	-5.60

Note 1: Frequency Tolerance (ppm) = {[Measured Frequency (MHz) - Declared Frequency (MHz)] / Declared Frequency (MHz)} * 10⁶.

6.7. Radiated Spurious Emission Measurement

6.7.1. Test Limit

All out of band emissions appearing in a restricted band as specified in Section 15.205 of the Title 47 CFR must not exceed the limits shown in Table per Section 15.209.

FCC Part 15 Subpart C Paragraph 15.209		
Frequency (MHz)	Field Strength ($\mu\text{V}/\text{m}$)	Measured Distance (m)
0.009 - 0.490	2400/F (kHz)	300
0.490 - 1.705	24000/F (kHz)	30
1.705 - 30	30	30
30 - 88	100	3
88 - 216	150	3
216 - 960	200	3
Above 960	500	3

6.7.2. Test Procedure Used

KDB 789033 D02v02r01- Section G

6.7.3. Test Setting

Table 1 - RBW as a function of frequency

Frequency	RBW
9 ~ 150 kHz	200 ~ 300 Hz
0.15 ~ 30 MHz	9 ~ 10 kHz
30 ~ 1000 MHz	100 ~ 120 kHz
> 1000 MHz	1 MHz

Quasi-Peak Measurements below 1GHz

1. Analyzer center frequency was set to the frequency of the radiated spurious emission of interest
2. Span was set greater than 1MHz
3. RBW = as specified in Table 1
4. Detector = CISPR quasi-peak
5. Sweep time = auto couple
6. Trace was allowed to stabilize

Peak Measurements above 1GHz

1. Analyzer center frequency was set to the frequency of the radiated spurious emission of interest
2. RBW = 1MHz
3. VBW = 3MHz
4. Detector = peak
5. Sweep time = auto couple
6. Trace mode = max hold
7. Trace was allowed to stabilize

Average Measurements above 1GHz (Method VB)

1. Analyzer center frequency was set to the frequency of the radiated spurious emission of interest
2. RBW = 1MHz
3. VBW; If the EUT is configured to transmit with duty cycle $\geq 98\%$, set VBW = 10Hz
If the EUT duty cycle is $< 98\%$, set VBW $\geq 1/T$. T is the minimum transmission duration
4. Detector = Peak
5. Sweep time = auto
6. Trace mode = max hold
7. Trace was allowed to stabilize

6.7.4. Test Setup

Below 1GHz Test Setup:

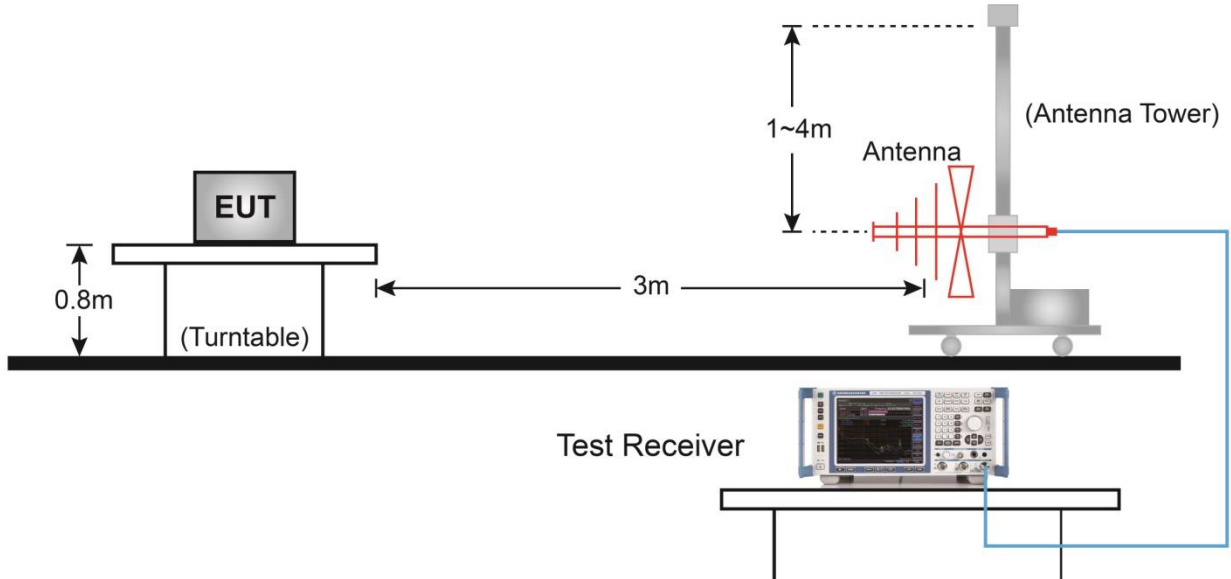

Above 1GHz Test Setup:

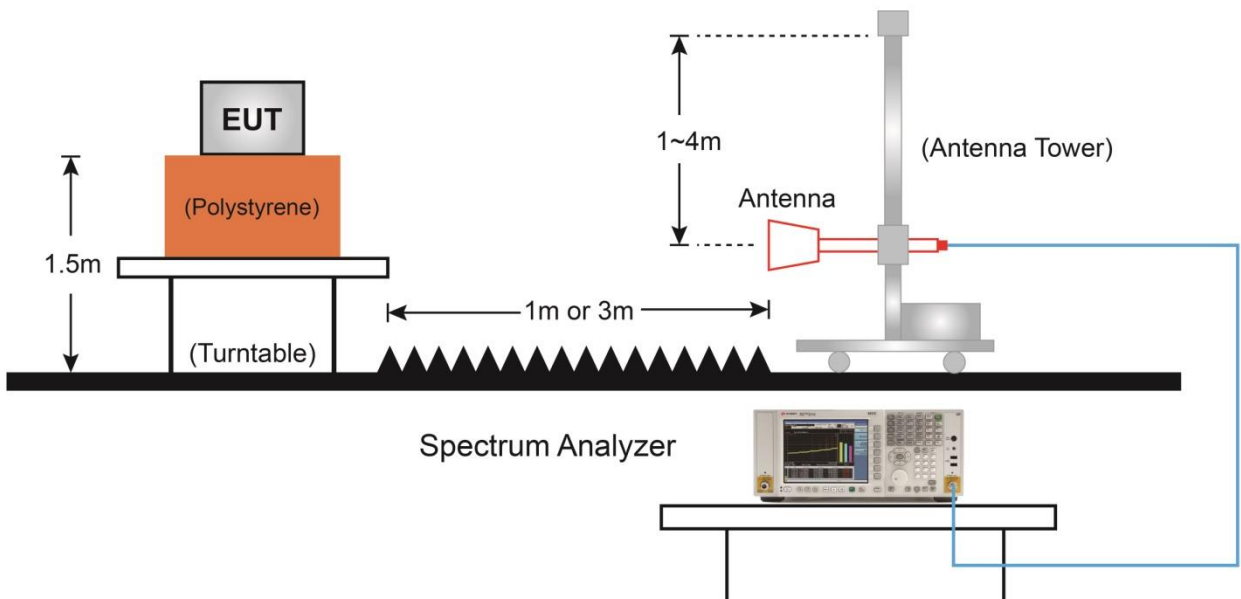

6.7.5. Test Result

Test Site	SIP-AC3	Test Engineer	White Wang
Test Date	2020/11/22	Test Frequency	5729MHz
Test Mode	Full BW, Ant 0		
Remark	1. Average measurement was not performed if peak level lower than average limit. 2. Other frequency was 20dB below limit line within 1-18GHz, there is not show in the report.		

Mark	Frequency (MHz)	Reading Level (dBμV)	Factor (dB)	Measure Level (dBμV/m)	Limit (dBμV/m)	Margin (dB)	Detector	Polarization
	11259.5	50.1	-3.7	46.4	74	-27.6	Peak	Horizontal
	12126.5	50.0	-3.2	46.8	74	-27.2	Peak	Horizontal
*	14141.0	49.3	1.2	50.5	68.2	-17.7	Peak	Horizontal
*	17422.0	48.2	5.4	53.6	68.2	-14.6	Peak	Horizontal
	11455.0	52.3	-4.1	48.2	74	-25.8	Peak	Vertical
	12118.0	49.7	-3.0	46.7	74	-27.3	Peak	Vertical
*	14353.5	48.6	1.6	50.2	68.2	-18.0	Peak	Vertical
*	17192.5	49.3	4.6	53.9	68.2	-14.3	Peak	Vertical

Test Mode 1: "*" is not in restricted band, its limit is -27dBm/MHz. At a distance of 3 meters, the field strength limit in dBμV/m can be determined by adding a "conversion" factor of 95.2dB to the EIRP limit of -27dBm/MHz to obtain the limit for out of band spurious emissions.

Test Mode 2: Measure Level (dBμV/m) = Reading Level (dBμV) + Factor (dB)

Factor (dB) = Cable Loss (dB) + Antenna Factor (dB/m) - Pre_Amplifier Gain (dB)

Test Site	SIP-AC3	Test Engineer	White Wang
Test Date	2020/11/22	Test Frequency	5788MHz
Test Mode	Full BW, Ant 0		
Remark	1. Average measurement was not performed if peak level lower than average limit. 2. Other frequency was 20dB below limit line within 1-18GHz, there is not show in the report.		

Mark	Frequency (MHz)	Reading Level (dBμV)	Factor (dB)	Measure Level (dBμV/m)	Limit (dBμV/m)	Margin (dB)	Detector	Polarization
	11455.0	52.3	-4.1	48.2	74	-25.8	Peak	Horizontal
	12118.0	49.7	-3.0	46.7	74	-27.3	Peak	Horizontal
*	14141.0	48.8	1.2	50.0	68.2	-18.2	Peak	Horizontal
*	17192.5	49.3	4.6	53.9	68.2	-14.3	Peak	Horizontal
	10928.0	49.9	-3.6	46.3	74	-27.7	Peak	Vertical
	11574.0	51.4	-3.7	47.7	74	-26.3	Peak	Vertical
*	14166.5	49.3	1.0	50.3	68.2	-17.9	Peak	Vertical
*	17371.0	48.3	5.5	53.8	68.2	-14.4	Peak	Vertical

Test Mode 1: "*" is not in restricted band, its limit is -27dBm/MHz. At a distance of 3 meters, the field strength limit in dBμV/m can be determined by adding a "conversion" factor of 95.2dB to the EIRP limit of -27dBm/MHz to obtain the limit for out of band spurious emissions.

Test Mode 2: Measure Level (dBμV/m) = Reading Level (dBμV) + Factor (dB)

Factor (dB) = Cable Loss (dB) + Antenna Factor (dB/m) - Pre_Amplifier Gain (dB)

Test Site	SIP-AC3	Test Engineer	White Wang
Test Date	2020/11/22	Test Frequency	5846MHz
Test Mode	Full BW, Ant 0		
Remark	1. Average measurement was not performed if peak level lower than average limit. 2. Other frequency was 20dB below limit line within 1-18GHz, there is not show in the report.		

Mark	Frequency (MHz)	Reading Level (dBμV)	Factor (dB)	Measure Level (dBμV/m)	Limit (dBμV/m)	Margin (dB)	Detector	Polarization
	10817.5	49.4	-3.3	46.1	74	-27.9	Peak	Horizontal
	11693.0	51.5	-3.8	47.7	74	-26.3	Peak	Horizontal
*	14974.0	47.5	2.3	49.8	68.2	-18.4	Peak	Horizontal
*	16776.0	48.1	5.1	53.2	68.2	-15.0	Peak	Horizontal
	11693.0	54.4	-3.8	50.6	74	-23.4	Peak	Vertical
	12407.0	49.0	-2.6	46.4	74	-27.6	Peak	Vertical
*	14710.5	47.9	1.9	49.8	68.2	-18.4	Peak	Vertical
*	16597.5	47.6	4.3	51.9	68.2	-16.3	Peak	Vertical

Test Mode 1: "*" is not in restricted band, its limit is -27dBm/MHz. At a distance of 3 meters, the field strength limit in dBμV/m can be determined by adding a "conversion" factor of 95.2dB to the EIRP limit of -27dBm/MHz to obtain the limit for out of band spurious emissions.

Test Mode 2: Measure Level (dBμV/m) = Reading Level (dBμV) + Factor (dB)

Factor (dB) = Cable Loss (dB) + Antenna Factor (dB/m) - Pre_Amplifier Gain (dB)

Test Site	SIP-AC3	Test Engineer	White Wang
Test Date	2020/11/22	Test Frequency	5729MHz
Test Mode	Half BW, Ant 0		
Remark	1. Average measurement was not performed if peak level lower than average limit. 2. Other frequency was 20dB below limit line within 1-18GHz, there is not show in the report.		

Mark	Frequency (MHz)	Reading Level (dBμV)	Factor (dB)	Measure Level (dBμV/m)	Limit (dBμV/m)	Margin (dB)	Detector	Polarization
	10885.5	50.8	-3.5	47.3	74	-26.7	Peak	Horizontal
	11829.0	49.8	-3.7	46.1	74	-27.9	Peak	Horizontal
*	14251.5	48.8	1.3	50.1	68.2	-18.1	Peak	Horizontal
*	17201.0	49.0	5.0	54.0	68.2	-14.2	Peak	Horizontal
	11455.0	51.1	-4.1	47.0	74	-27.0	Peak	Vertical
	12101.0	50.9	-3.2	47.7	74	-26.3	Peak	Vertical
*	14353.5	47.9	1.6	49.5	68.2	-18.7	Peak	Vertical
*	17422.0	47.9	5.4	53.3	68.2	-14.9	Peak	Vertical

Test Mode 1: "*" is not in restricted band, its limit is -27dBm/MHz. At a distance of 3 meters, the field strength limit in dBμV/m can be determined by adding a "conversion" factor of 95.2dB to the EIRP limit of -27dBm/MHz to obtain the limit for out of band spurious emissions.

Test Mode 2: Measure Level (dBμV/m) = Reading Level (dBμV) + Factor (dB)

Factor (dB) = Cable Loss (dB) + Antenna Factor (dB/m) - Pre_Amplifier Gain (dB)

Test Site	SIP-AC3	Test Engineer	White Wang
Test Date	2020/11/22	Test Frequency	5788MHz
Test Mode	Half BW, Ant 0		
Remark	1. Average measurement was not performed if peak level lower than average limit. 2. Other frequency was 20dB below limit line within 1-18GHz, there is not show in the report.		

Mark	Frequency (MHz)	Reading Level (dB μ V)	Factor (dB)	Measure Level (dB μ V/m)	Limit (dB μ V/m)	Margin (dB)	Detector	Polarization
	11064.0	49.4	-3.3	46.1	74	-27.9	Peak	Horizontal
	12058.5	50.3	-3.5	46.8	74	-27.2	Peak	Horizontal
*	14821.0	47.2	2.5	49.7	68.2	-18.5	Peak	Horizontal
*	17226.5	47.8	4.2	52.0	68.2	-16.2	Peak	Horizontal
	10630.5	49.1	-3.2	45.9	74	-28.1	Peak	Vertical
	11574.0	51.2	-3.7	47.5	74	-26.5	Peak	Vertical
*	14931.5	47.1	2.6	49.7	68.2	-18.5	Peak	Vertical
*	17320.0	47.5	5.1	52.6	68.2	-15.6	Peak	Vertical

Test Mode 1: "*" is not in restricted band, its limit is -27dBm/MHz. At a distance of 3 meters, the field strength limit in dB μ V/m can be determined by adding a "conversion" factor of 95.2dB to the EIRP limit of -27dBm/MHz to obtain the limit for out of band spurious emissions.

Test Mode 2: Measure Level (dB μ V/m) = Reading Level (dB μ V) + Factor (dB)

Factor (dB) = Cable Loss (dB) + Antenna Factor (dB/m) - Pre_Amplifier Gain (dB)

Test Site	SIP-AC3	Test Engineer	White Wang
Test Date	2020/11/22	Test Frequency	5846MHz
Test Mode	Half BW, Ant 0		
Remark	1. Average measurement was not performed if peak level lower than average limit. 2. Other frequency was 20dB below limit line within 1-18GHz, there is not show in the report.		

Mark	Frequency (MHz)	Reading Level (dB μ V)	Factor (dB)	Measure Level (dB μ V/m)	Limit (dB μ V/m)	Margin (dB)	Detector	Polarization
	10673.0	49.3	-3.1	46.2	74	-27.8	Peak	Horizontal
	11982.0	50.3	-3.5	46.8	74	-27.2	Peak	Horizontal
*	14345.0	48.1	1.6	49.7	68.2	-18.5	Peak	Horizontal
*	16835.5	47.2	4.7	51.9	68.2	-16.3	Peak	Horizontal
	10894.0	49.7	-3.3	46.4	74	-27.6	Peak	Vertical
	11693.0	54.4	-3.8	50.6	74	-23.4	Peak	Vertical
*	14251.5	49.1	1.3	50.4	68.2	-17.8	Peak	Vertical
*	16368.0	47.5	4.2	51.7	68.2	-16.5	Peak	Vertical

Test Mode 1: "*" is not in restricted band, its limit is -27dBm/MHz. At a distance of 3 meters, the field strength limit in dB μ V/m can be determined by adding a "conversion" factor of 95.2dB to the EIRP limit of -27dBm/MHz to obtain the limit for out of band spurious emissions.

Test Mode 2: Measure Level (dB μ V/m) = Reading Level (dB μ V) + Factor (dB)

Factor (dB) = Cable Loss (dB) + Antenna Factor (dB/m) - Pre_Amplifier Gain (dB)

The Result of Radiated Emission below 1GHz:

Site: SIP-AC3	Time: 2021/04/07
Limit: FCC_Part15.209_RE(3m)	Engineer: White Wang
Probe: SIP-AC3_VULB 9168 _30-1000MHz	Polarity: Horizontal
EUT: Wireless Portable Receiver	Power: AC 120V/60Hz
Test Mode: Transmit by Full mode bandwidth at channel 5729MHz at Ant 0	

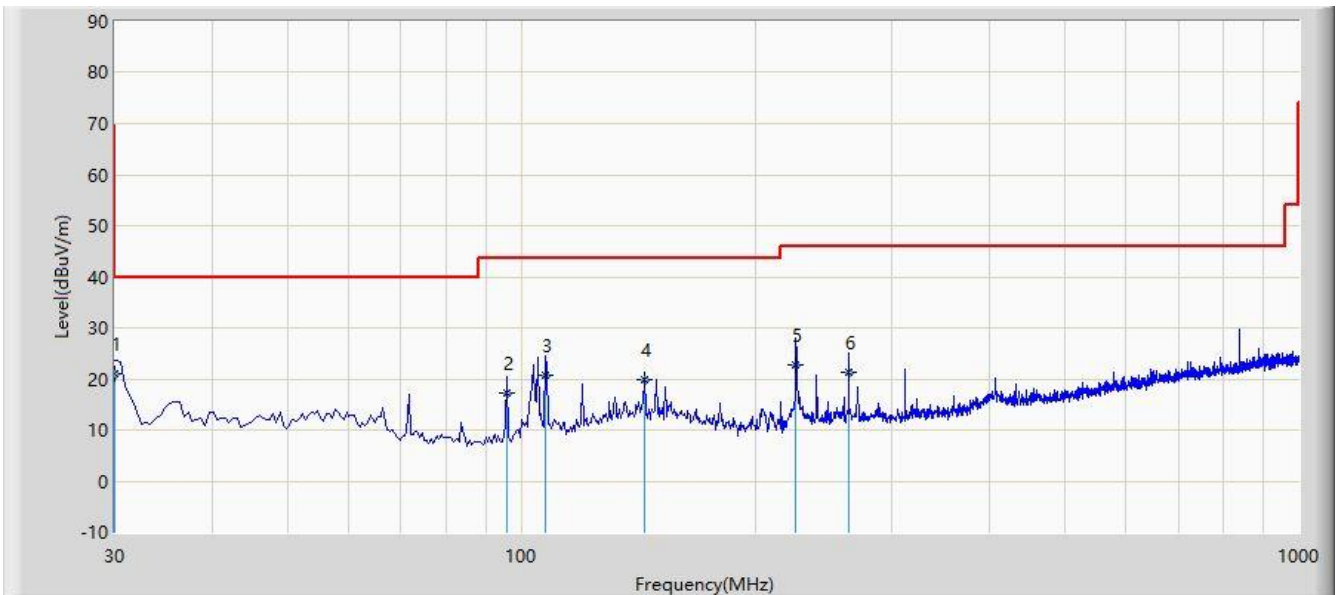

No	Flag	Mark	Frequency (MHz)	Measure Level (dBuV/m)	Reading Level (dBuV)	Margin (dB)	Limit (dBuV/m)	Factor (dB)	Type
1		*	30.000	20.903	4.100	-19.097	40.000	16.803	QP
2			95.960	17.209	4.500	-26.291	43.500	12.709	QP
3			107.600	20.819	6.200	-22.681	43.500	14.619	QP
4			143.975	19.786	1.900	-23.714	43.500	17.887	QP
5			225.455	22.692	8.100	-23.308	46.000	14.592	QP
6			263.770	21.323	4.200	-24.677	46.000	17.123	QP

Note 1: Measure Level (dB μ V/m) = Reading Level (dB μ V) + Factor (dB)

Factor (dB) = Cable Loss (dB) + Antenna Factor (dB/m)

Note 2: The amplitude of radiated emissions (frequency range from 9kHz to 30MHz and 18GHz to 40GHz) is that proximity to ambient noise, which also are attenuated more than 20 dB below the permissible value.

Therefore, the data is not presented in the report.

Site: SIP-AC3	Time: 2021/04/07
Limit: FCC_Part15.209_RE(3m)	Engineer: White Wang
Probe: SIP-AC3_VULB 9168 _30-1000MHz	Polarity: Vertical
EUT: Wireless Portable Receiver	Power: AC 120V/60Hz
Worst Case Mode: Transmit by Full mode bandwidth at channel 5729MHz at Ant 0	

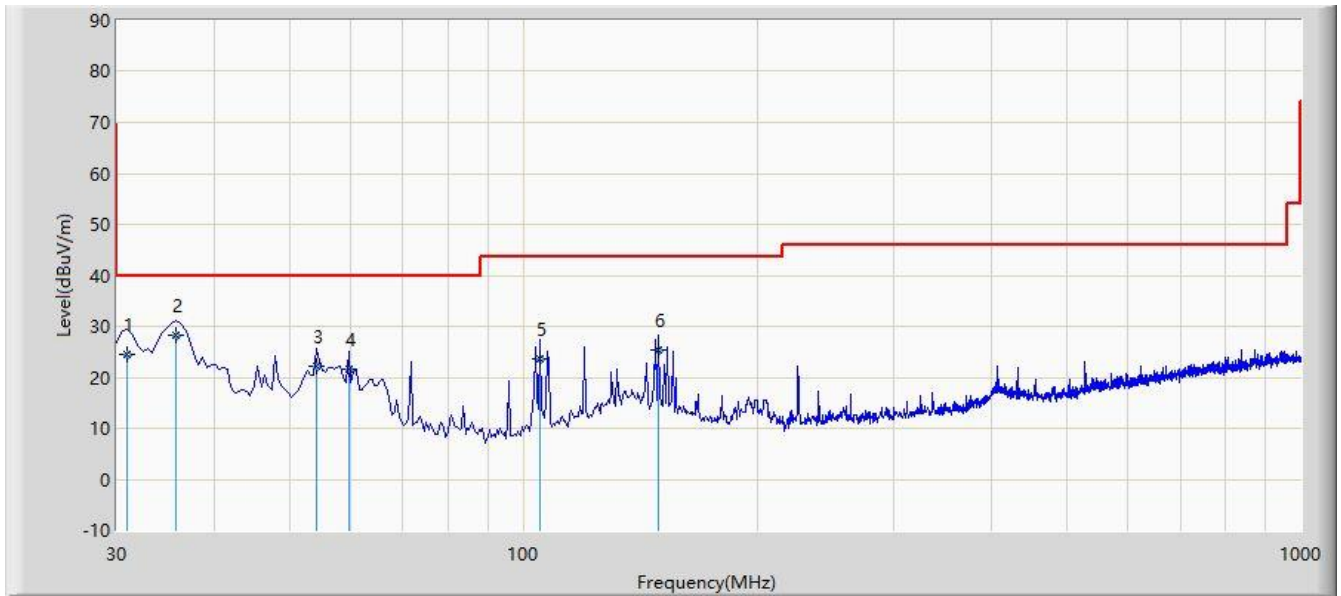

No	Flag	Mark	Frequency (MHz)	Measure Level (dBuV/m)	Reading Level (dBuV)	Margin (dB)	Limit (dBuV/m)	Factor (dB)	Type
1			30.970	24.374	7.800	-15.626	40.000	16.574	QP
2		*	35.820	28.298	11.200	-11.702	40.000	17.098	QP
3			54.250	22.044	4.300	-17.956	40.000	17.744	QP
4			59.585	21.610	4.300	-18.390	40.000	17.310	QP
5			105.175	23.520	9.300	-19.980	43.500	14.221	QP
6			149.341	25.352	7.200	-18.148	43.500	18.152	QP

Note 1: Measure Level (dB μ V/m) = Reading Level (dB μ V) + Factor (dB)

Factor (dB) = Cable Loss (dB) + Antenna Factor (dB/m)

Note 2: The amplitude of radiated emissions (frequency range from 9kHz to 30MHz and 18GHz to 40GHz) is that proximity to ambient noise, which also are attenuated more than 20 dB below the permissible value.

Therefore, the data is not presented in the report.

6.8. Radiated Restricted Band Edge Measurement

6.8.1. Test Limit

For 15.205 Requirement:

Radiated emissions which fall in the restricted bands, as defined in Section 15.205(a) of FCC part 15, must also comply with the radiated emission limits specified in Section 15.209(a).

Frequency (MHz)	Frequency (MHz)	Frequency (MHz)	Frequency (GHz)
0.090 - 0.110	16.42-16.423	399.9 - 410	4.5-5.15
¹ 0.495 - 0.505	16.69475-16.69525	608 - 614	5.35-5.46
2.1735-2.1905	16.80425-16.80475	960 - 1240	7.25-7.75
4.125-4.128	25.5 -25.67	1300 - 1427	8.025 - 8.5
4.17725-4.17775	37.5-38.25	1435-1626.5	9.0-9.2
4.20725-4.20775	73-74.6	1645.5-1646.5	9.3-9.5
6.215-6.218	74.8-75.2	1660 - 1710	10.6-12.7
6.26775-6.26825	108-121.94	1718.8-1722.2	13.25-13.4
6.31175-6.31225	123 - 138	2200 - 2300	14.47-14.5
8.291-8.294	149.9-150.05	2310–2390	15.35-16.2
8.362-8.366	156.52475-156.52525	2483.5 - 2500	17.7-21.4
8.37625-8.38675	156.7-156.9	2690 - 2900	22.01-23.12
8.41425-8.41475	162.0125-167.17	3260 - 3267	23.6-24.0
12.29-12.293	167.72-173.2	3332 - 3339	31.2-31.8
12.51975-12.52025	240 - 285	3345.8 - 3358	36.43-36.5
12.57675-12.57725	322-335.4	3600 - 4400	(²)
13.36-13.41	--	--	--

For 15.407(b) Requirement:

For transmitters operating in the 5.725-5.85 GHz band: All emissions within the frequency range from the band edge to 10 MHz above or below the band edge shall not exceed an e.i.r.p. of -17 dBm/MHz; for frequencies 10 MHz or greater above or below the band edge, emissions shall not exceed an e.i.r.p. of -27 dBm/MHz.

Refer to KDB 789033 D02v02r01 G)2)c), as specified in § 15.407(b), emissions above 1000 MHz that are outside of the restricted bands are subject to a maximum emission limit of -27 dBm/MHz (or -17 dBm/MHz as specified in § 15.407(b)(4)). However, an out-of-band emission that complies with

both the peak and average limits of § 15.209 is not required to satisfy the -27 dBm/MHz or -17 dBm/MHz maximum emission limit.

All out of band emissions appearing in a restricted band as specified in Section 15.205 of the Title 47CFR must not exceed the limits shown in Table per Section 15.209.

FCC Part 15 Subpart C Paragraph 15.209		
Frequency (MHz)	Field Strength ($\mu\text{V}/\text{m}$)	Measured Distance (m)
0.009 - 0.490	2400/F (kHz)	300
0.490 - 1.705	24000/F (kHz)	30
1.705 - 30	30	30
30 - 88	100	3
88 - 216	150	3
216 - 960	200	3
Above 960	500	3

6.8.2. Test Procedure Used

KDB 789033 D02v02r01- Section G

6.8.3. Test Setting

Peak Measurements above 1GHz

1. Analyzer center frequency was set to the frequency of the radiated spurious emission of interest
2. RBW = 1MHz
3. VBW = 3MHz
4. Detector = Peak
5. Sweep time = Auto couple
6. Trace mode = Max hold
7. Trace was allowed to stabilize

Average Measurements above 1GHz (Method VB)

1. Analyzer center frequency was set to the frequency of the radiated spurious emission of interest
2. RBW = 1MHz
3. VBW; if the EUT is configured to transmit with duty cycle $\geq 98\%$, set VBW = 10Hz
4. If the EUT duty cycle is $< 98\%$, set VBW $\geq 1/T$. T is the minimum transmission duration
5. Detector = Peak
6. Sweep time = Auto
7. Trace mode = Max hold
8. Trace was allowed to stabilize

6.8.4. Test Setup

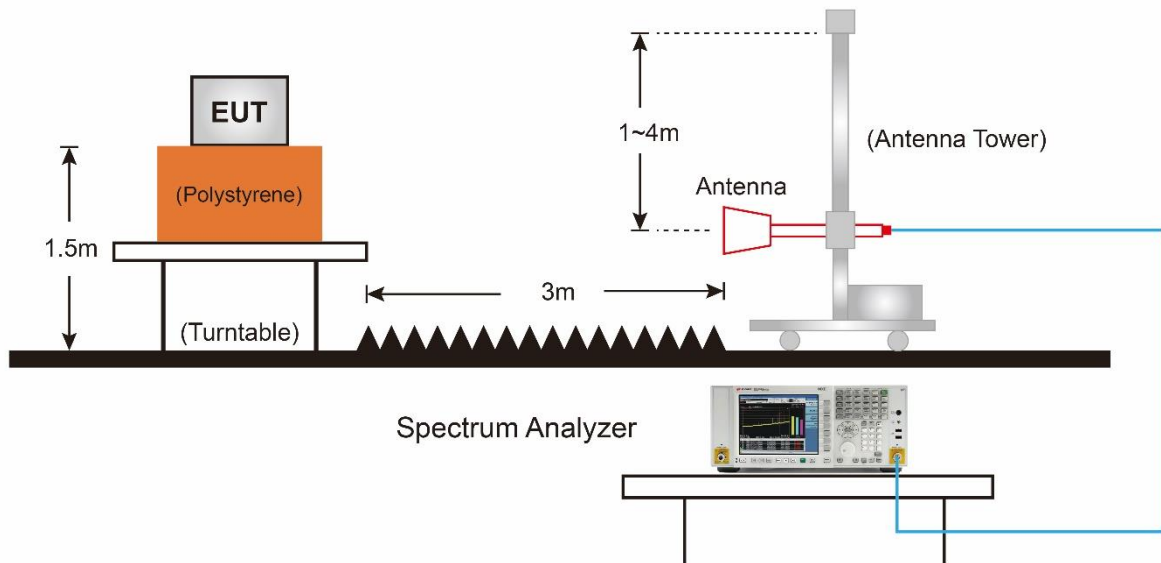

6.8.5. Test Result

Site: SIP-AC2	Time: 2021/03/16 - 18:55
Limit: FCC_Part15_15.407 RE(3m)	Engineer: Allen Zou
Probe: SIP-AC2_BBHA9120D_1-18GHz	Polarity: Horizontal
EUT: Wireless Portable Receiver	Power: AC 120V/60Hz
Test Mode: Transmit by Full BW at channel 5729MHz at Ant 0	

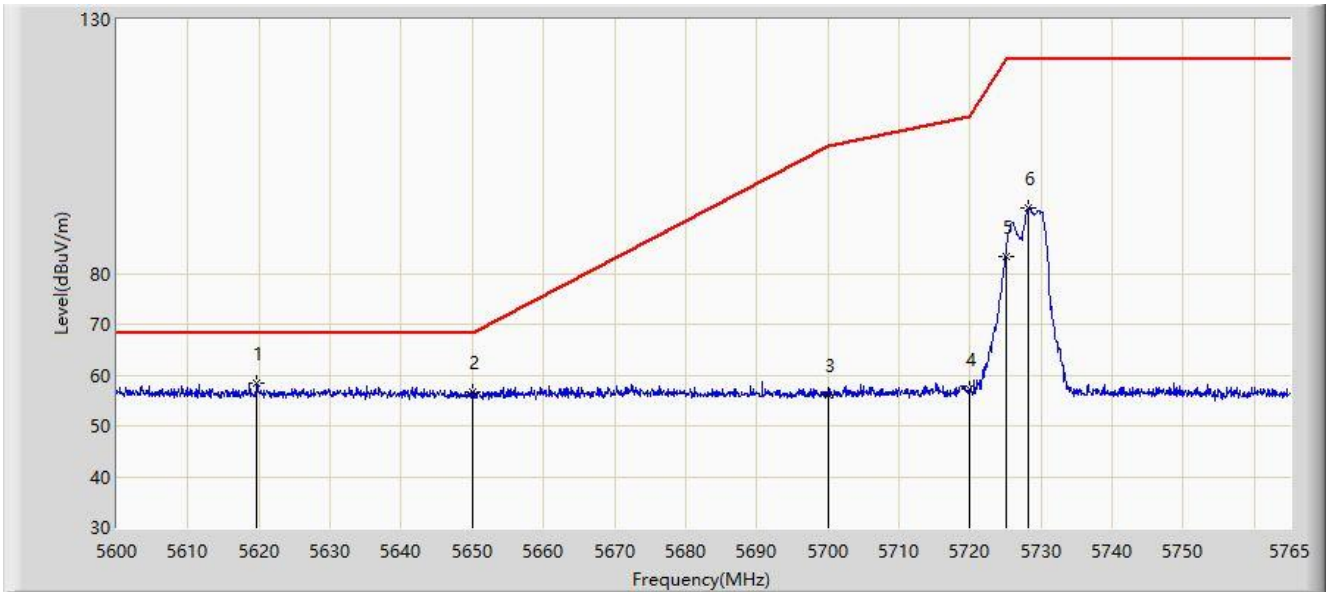

No	Flag	Mark	Frequency (MHz)	Measure Level (dBuV/m)	Reading Level (dBuV)	Margin (dB)	Limit (dBuV/m)	Factor (dB)	Type
1		*	5619.717	58.455	69.348	-9.745	68.200	-10.893	PK
2			5650.000	56.523	67.371	-11.677	68.200	-10.849	PK
3			5700.000	56.171	66.957	-49.029	105.200	-10.786	PK
4			5720.000	57.253	67.992	-53.547	110.800	-10.739	PK
5			5725.000	83.356	94.075	-38.844	122.200	-10.718	PK
6			5728.205	92.934	103.638	N/A	N/A	-10.704	PK

Note: Measure Level (dB μ V/m) = Reading Level (dB μ V) + Factor (dB)

Factor (dB) = Cable Loss (dB) + Antenna Factor (dB/m) - Pre_Amplifier Gain (dB).

Site: SIP-AC2	Time: 2021/03/16 - 19:04
Limit: FCC_Part15_15.407 RE(3m)	Engineer: Allen Zou
Probe: SIP-AC2_BBHA9120D_1-18GHz	Polarity: Vertical
EUT: Wireless Portable Receiver	Power: AC 120V/60Hz
Test Mode: Transmit by Full BW at channel 5729MHz at Ant 0	

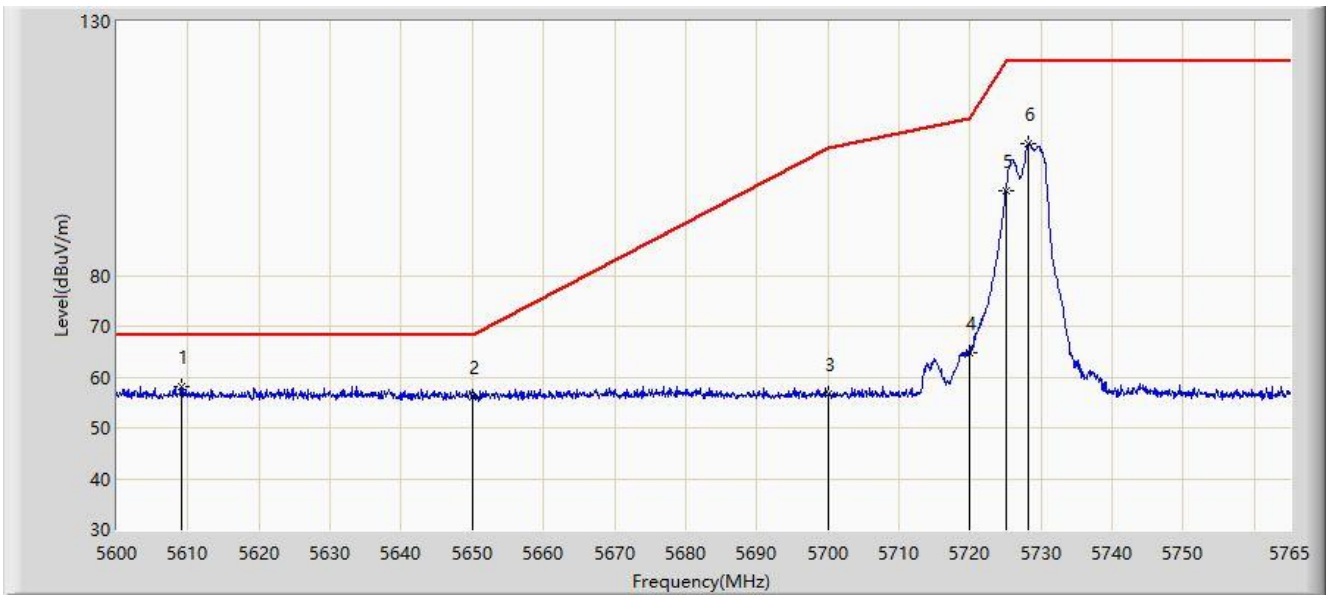

No	Flag	Mark	Frequency (MHz)	Measure Level (dBuV/m)	Reading Level (dBuV)	Margin (dB)	Limit (dBuV/m)	Factor (dB)	Type
1		*	5609.158	58.050	68.817	-10.150	68.200	-10.768	PK
2			5650.000	56.038	66.886	-12.162	68.200	-10.849	PK
3			5700.000	56.760	67.546	-48.440	105.200	-10.786	PK
4			5720.000	64.817	75.556	-45.983	110.800	-10.739	PK
5			5725.000	96.589	107.308	-25.611	122.200	-10.718	PK
6			5728.205	106.073	116.777	N/A	N/A	-10.704	PK

Note: Measure Level (dB μ V/m) = Reading Level (dB μ V) + Factor (dB)

Factor (dB) = Cable Loss (dB) + Antenna Factor (dB/m) - Pre_Amplifier Gain (dB).

Site: SIP-AC2	Time: 2021/03/16 - 19:17
Limit: FCC_Part15_15.407 RE(3m)	Engineer: Allen Zou
Probe: SIP-AC2_BBHA9120D_1-18GHz	Polarity: Horizontal
EUT: Wireless Portable Receiver	Power: AC 120V/60Hz
Test Mode: Transmit by Full BW at channel 5846MHz at Ant 0	

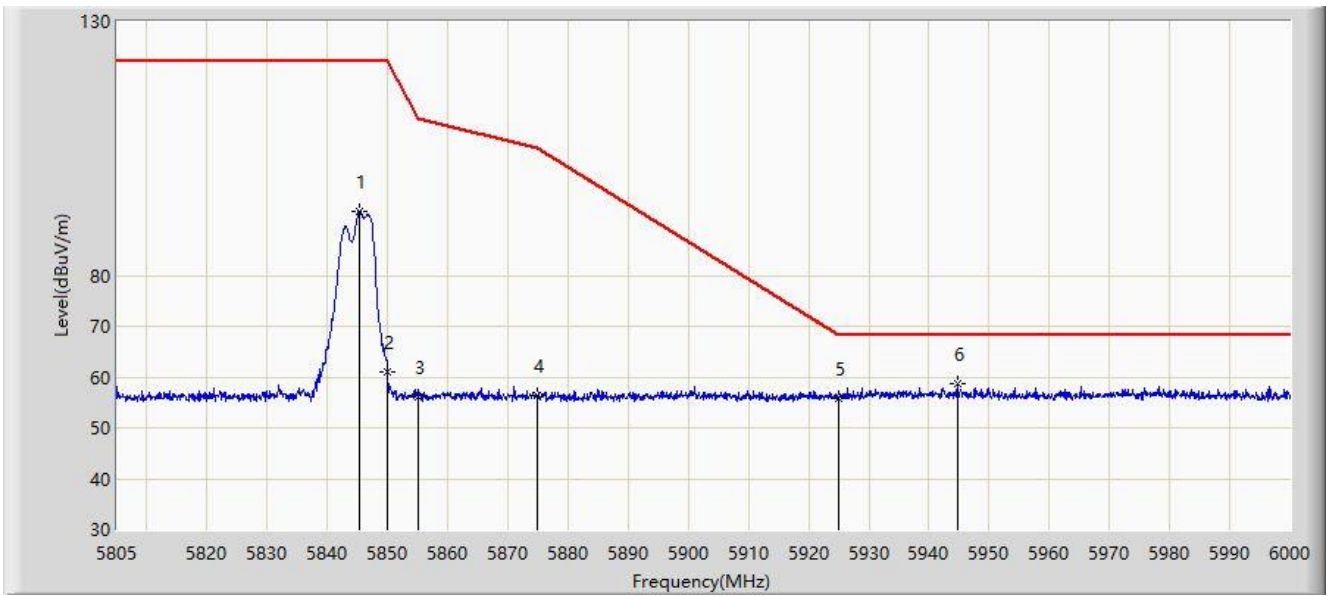

No	Flag	Mark	Frequency (MHz)	Measure Level (dBuV/m)	Reading Level (dBuV)	Margin (dB)	Limit (dBuV/m)	Factor (dB)	Type
1			5845.268	92.738	103.143	N/A	N/A	-10.405	PK
2			5850.000	60.929	71.316	-61.271	122.200	-10.387	PK
3			5855.000	56.142	66.510	-54.658	110.800	-10.369	PK
4			5875.000	56.411	66.737	-48.789	105.200	-10.326	PK
5			5925.000	55.766	65.798	-12.434	68.200	-10.032	PK
6		*	5944.717	58.801	68.752	-9.399	68.200	-9.951	PK

Note: Measure Level (dBμV/m) = Reading Level (dBμV) + Factor (dB)

Factor (dB) = Cable Loss (dB) + Antenna Factor (dB/m) - Pre_Amplifier Gain (dB).

Site: SIP-AC2	Time: 2021/03/16 - 19:19
Limit: FCC_Part15_15.407 RE(3m)	Engineer: Allen Zou
Probe: SIP-AC2_BBHA9120D_1-18GHz	Polarity: Vertical
EUT: Wireless Portable Receiver	Power: AC 120V/60Hz
Test Mode: Transmit by Full BW at channel 5846MHz at Ant 0	

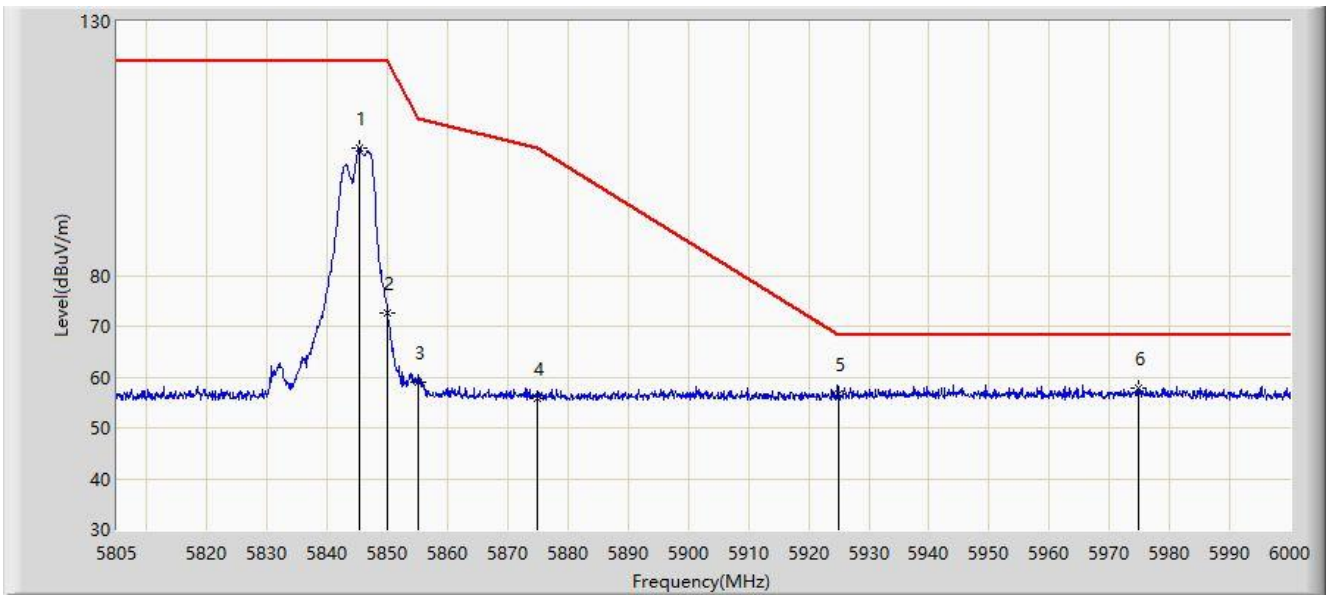

No	Flag	Mark	Frequency (MHz)	Measure Level (dBuV/m)	Reading Level (dBuV)	Margin (dB)	Limit (dBuV/m)	Factor (dB)	Type
1			5845.268	105.095	115.500	N/A	N/A	-10.405	PK
2			5850.000	72.723	83.110	-49.477	122.200	-10.387	PK
3			5855.000	58.990	69.358	-51.810	110.800	-10.369	PK
4			5875.000	55.777	66.103	-49.423	105.200	-10.326	PK
5			5925.000	56.632	66.664	-11.568	68.200	-10.032	PK
6		*	5974.748	57.870	67.811	-10.330	68.200	-9.941	PK

Note: Measure Level (dB μ V/m) = Reading Level (dB μ V) + Factor (dB)

Factor (dB) = Cable Loss (dB) + Antenna Factor (dB/m) - Pre_Amplifier Gain (dB).

Site: SIP-AC2	Time: 2021/03/16 - 19:24
Limit: FCC_Part15_15.407 RE(3m)	Engineer: Allen Zou
Probe: SIP-AC2_BBHA9120D_1-18GHz	Polarity: Horizontal
EUT: Wireless Portable Receiver	Power: AC 120V/60Hz
Test Mode: Transmit by Half BW at channel 5729MHz at Ant 0	

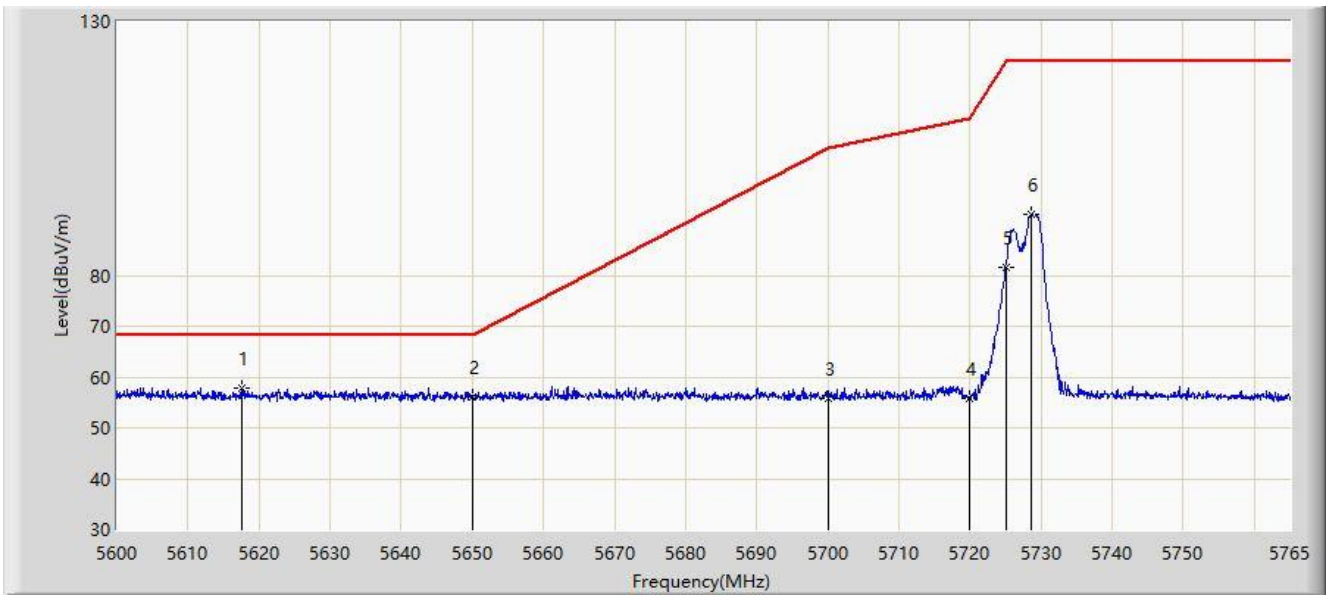

No	Flag	Mark	Frequency (MHz)	Measure Level (dBuV/m)	Reading Level (dBuV)	Margin (dB)	Limit (dBuV/m)	Factor (dB)	Type
1		*	5617.655	57.931	68.800	-10.269	68.200	-10.870	PK
2			5650.000	55.982	66.830	-12.218	68.200	-10.849	PK
3			5700.000	55.703	66.489	-49.497	105.200	-10.786	PK
4			5720.000	55.810	66.549	-54.990	110.800	-10.739	PK
5			5725.000	81.701	92.420	-40.499	122.200	-10.718	PK
6			5728.618	92.077	102.779	N/A	N/A	-10.702	PK

Note: Measure Level (dB μ V/m) = Reading Level (dB μ V) + Factor (dB)

Factor (dB) = Cable Loss (dB) + Antenna Factor (dB/m) - Pre_Amplifier Gain (dB).

Site: SIP-AC2	Time: 2021/03/16 - 19:26
Limit: FCC_Part15_15.407 RE(3m)	Engineer: Allen Zou
Probe: SIP-AC2_BBHA9120D_1-18GHz	Polarity: Vertical
EUT: Wireless Portable Receiver	Power: AC 120V/60Hz
Test Mode: Transmit by Half BW at channel 5729MHz at Ant 0	

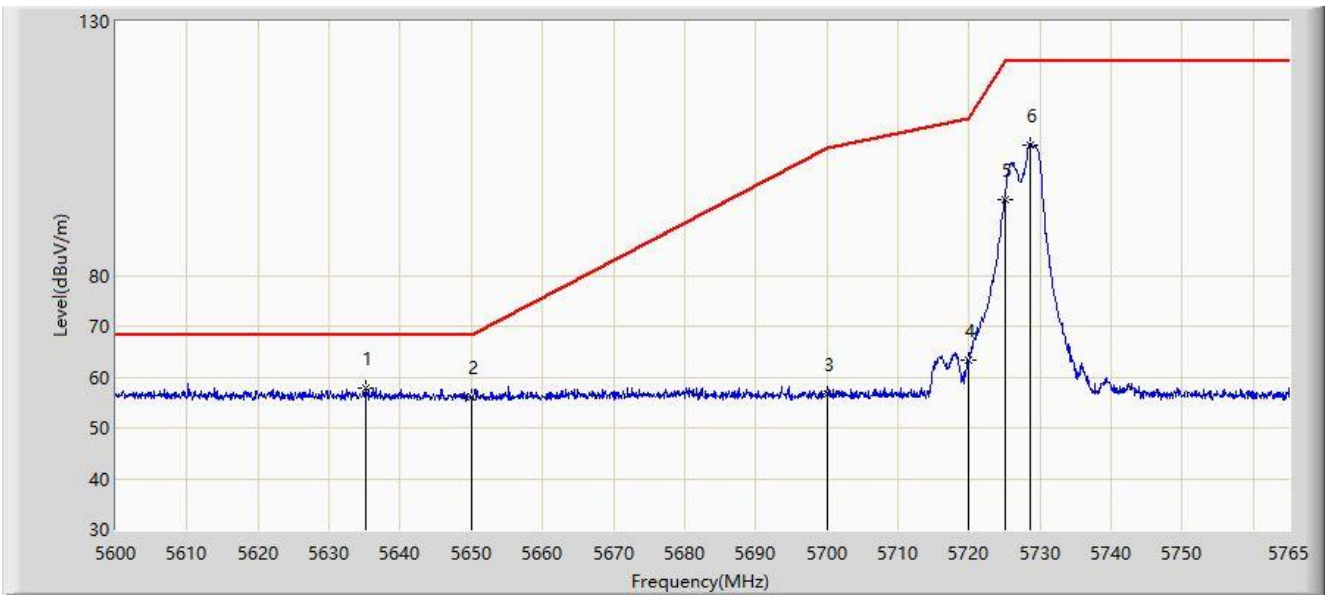

No	Flag	Mark	Frequency (MHz)	Measure Level (dBuV/m)	Reading Level (dBuV)	Margin (dB)	Limit (dBuV/m)	Factor (dB)	Type
1		*	5635.145	57.821	68.706	-10.379	68.200	-10.884	PK
2			5650.000	56.096	66.944	-12.104	68.200	-10.849	PK
3			5700.000	56.811	67.597	-48.389	105.200	-10.786	PK
4			5720.000	63.372	74.111	-47.428	110.800	-10.739	PK
5			5725.000	95.014	105.733	-27.186	122.200	-10.718	PK
6			5728.700	105.792	116.494	N/A	N/A	-10.701	PK

Note: Measure Level (dB μ V/m) = Reading Level (dB μ V) + Factor (dB)

Factor (dB) = Cable Loss (dB) + Antenna Factor (dB/m) - Pre_Amplifier Gain (dB).

Site: SIP-AC2	Time: 2021/03/16 - 19:36
Limit: FCC_Part15_15.407 RE(3m)	Engineer: Allen Zou
Probe: SIP-AC2_BBHA9120D_1-18GHz	Polarity: Horizontal
EUT: Wireless Portable Receiver	Power: AC 120V/60Hz
Test Mode: Transmit by Half BW at channel 5846MHz at Ant 0	

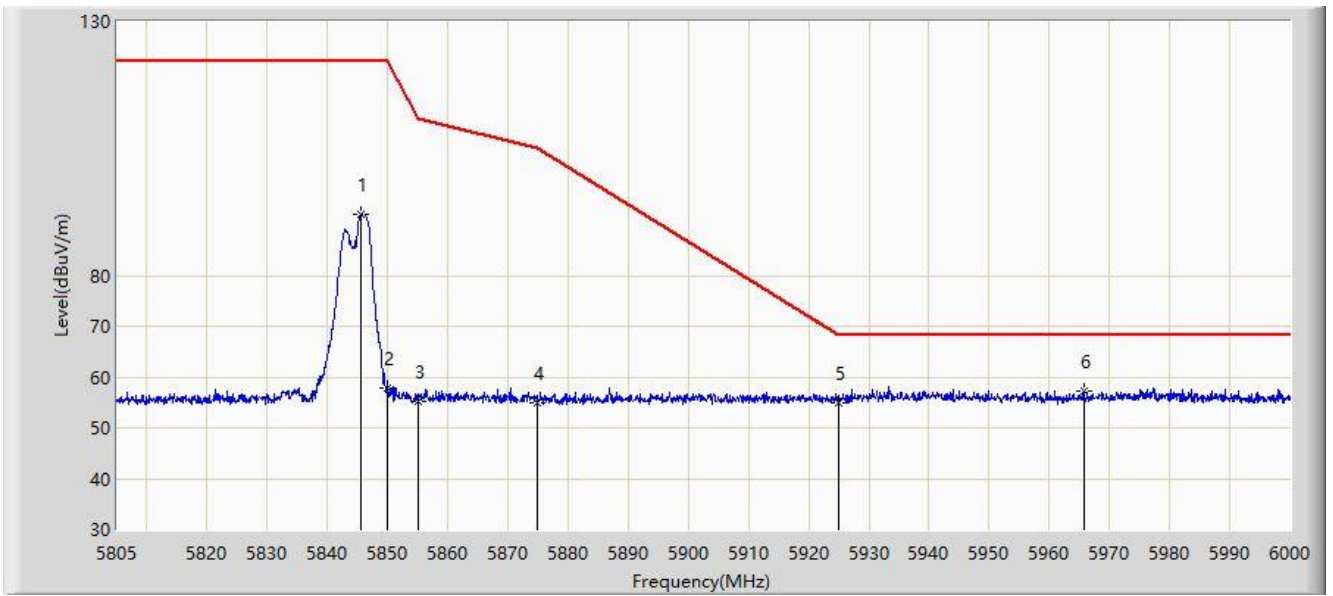

No	Flag	Mark	Frequency (MHz)	Measure Level (dBuV/m)	Reading Level (dBuV)	Margin (dB)	Limit (dBuV/m)	Factor (dB)	Type
1			5845.658	92.006	102.409	N/A	N/A	-10.404	PK
2			5850.000	57.877	68.264	-64.323	122.200	-10.387	PK
3			5855.000	55.323	65.691	-55.477	110.800	-10.369	PK
4			5875.000	54.937	65.263	-50.263	105.200	-10.326	PK
5			5925.000	55.070	65.102	-13.130	68.200	-10.032	PK
6		*	5965.680	57.292	67.289	-10.908	68.200	-9.998	PK

Note: Measure Level (dB μ V/m) = Reading Level (dB μ V) + Factor (dB)

Factor (dB) = Cable Loss (dB) + Antenna Factor (dB/m) - Pre_Amplifier Gain (dB).

Site: SIP-AC2	Time: 2021/03/16 - 19:39
Limit: FCC_Part15_15.407 RE(3m)	Engineer: Allen Zou
Probe: SIP-AC2_BBHA9120D_1-18GHz	Polarity: Vertical
EUT: Wireless Portable Receiver	Power: AC 120V/60Hz
Test Mode: Transmit by Half BW at channel 5846MHz at Ant 0	

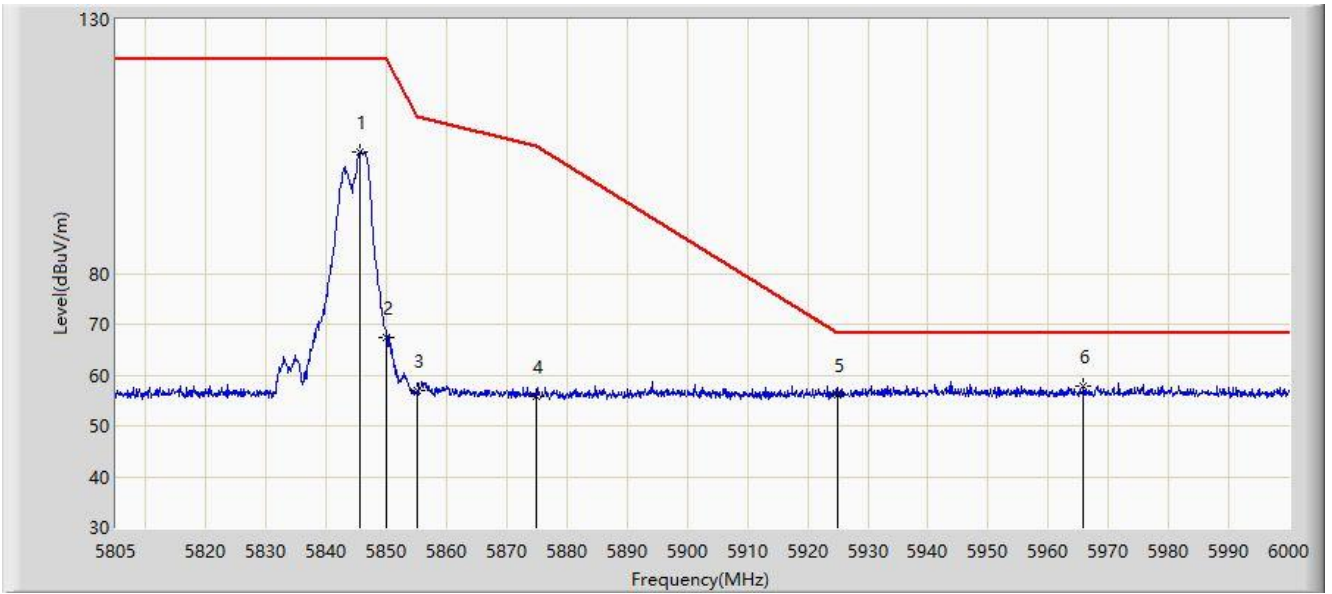

No	Flag	Mark	Frequency (MHz)	Measure Level (dBuV/m)	Reading Level (dBuV)	Margin (dB)	Limit (dBuV/m)	Factor (dB)	Type
1			5845.462	103.838	114.242	N/A	N/A	-10.404	PK
2			5850.000	67.389	77.776	-54.811	122.200	-10.387	PK
3			5855.000	56.975	67.343	-53.825	110.800	-10.369	PK
4			5875.000	55.767	66.093	-49.433	105.200	-10.326	PK
5			5925.000	56.207	66.239	-11.993	68.200	-10.032	PK
6		*	5965.875	57.965	67.961	-10.235	68.200	-9.995	PK

Note: Measure Level (dB μ V/m) = Reading Level (dB μ V) + Factor (dB)

Factor (dB) = Cable Loss (dB) + Antenna Factor (dB/m) - Pre_Amplifier Gain (dB).

6.9. AC Conducted Emissions Measurement

6.9.1. Test Limit

FCC Part 15 Subpart C Paragraph 15.207 Limits		
Frequency (MHz)	QP (dB μ V)	Average (dB μ V)
0.15 - 0.50	66 - 56	56 - 46
0.50 - 5.0	56	46
5.0 - 30	60	50

Note 1: The lower limit shall apply at the transition frequencies.

Note 2: The limit decreases linearly with the logarithm of the frequency in the range 0.15MHz to 0.5MHz.

6.9.2. Test Setup

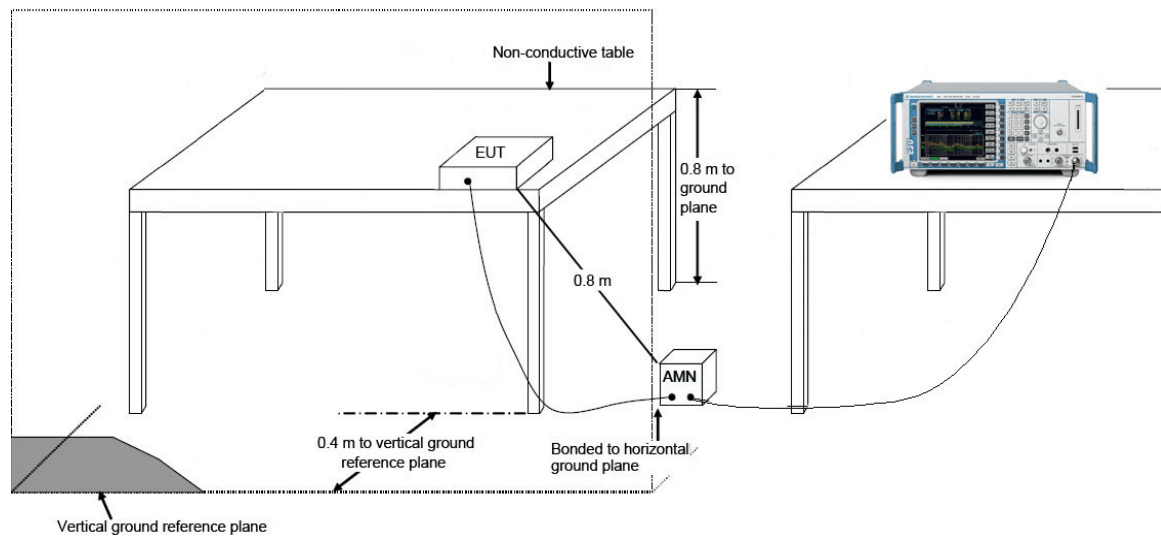

6.9.3. Test Result

Site: SIP-SR2	Time: 2021/03/31
Limit: FCC_Part15.207_CE_AC Power	Engineer: Rupert Wang
Probe: SIP-SR2-ENV216_101684_With Connect	Polarity: Line
EUT: Wireless Portable Receiver	Power: AC 120V/60Hz
Worst Case Mode: Transmit by Full BW at channel 5788MHz at Ant 0	

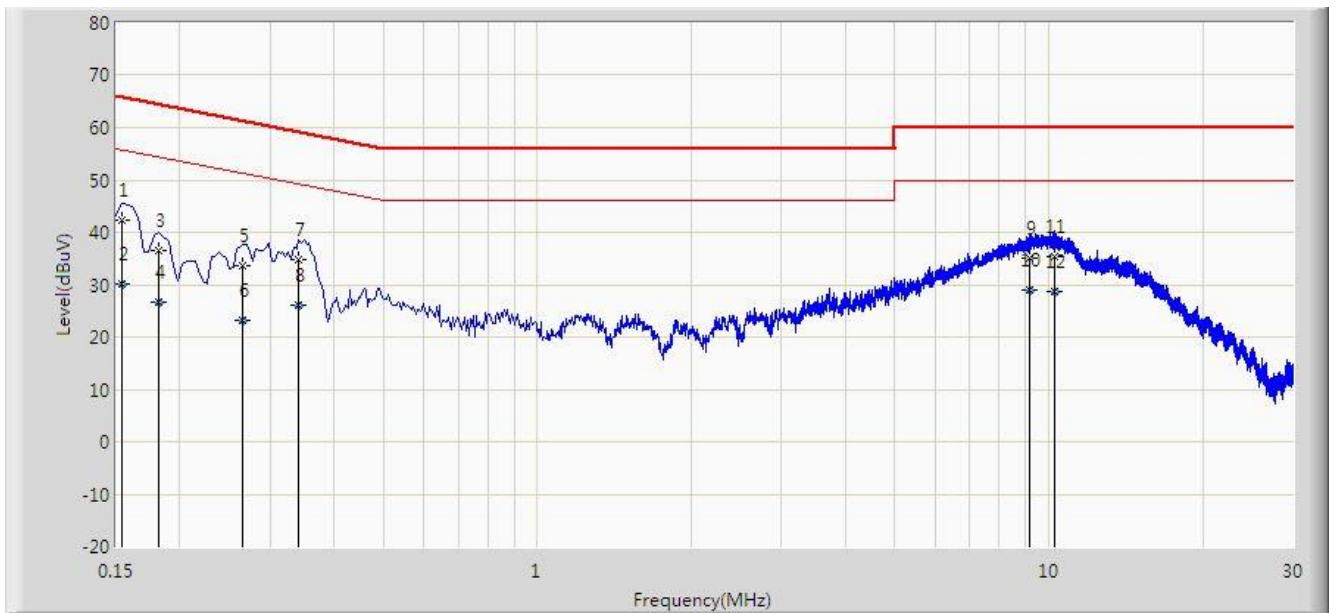

No	Flag	Mark	Frequency (MHz)	Measure Level (dBuV)	Reading Level (dBuV)	Margin (dB)	Limit (dBuV)	Factor (dB)	Type
1			0.154	42.305	32.854	-23.476	65.781	9.452	QP
2			0.154	30.236	20.784	-25.546	55.781	9.452	AV
3			0.182	36.460	27.000	-27.934	64.394	9.460	QP
4			0.182	26.549	17.090	-27.845	54.394	9.460	AV
5			0.266	33.514	23.990	-27.728	61.242	9.524	QP
6			0.266	23.215	13.691	-28.026	51.242	9.524	AV
7			0.342	34.909	25.364	-24.246	59.155	9.545	QP
8			0.342	26.109	16.564	-23.046	49.155	9.545	AV
9			9.138	35.015	25.048	-24.985	60.000	9.967	QP
10			9.138	29.036	19.068	-20.964	50.000	9.967	AV
11			10.294	35.270	25.245	-24.730	60.000	10.025	QP
12		*	10.294	28.831	18.807	-21.169	50.000	10.025	AV

Note: Measure Level (dBμV) = Reading Level (dBμV) + Factor (dB)

Factor (dB) = Cable Loss (dB) + LISN Factor (dB)

Site: SIP-SR2	Time: 2021/03/31
Limit: FCC_Part15.207_CE_AC Power	Engineer: Rupert Wang
Probe: SIP-SR2-ENV216_101684_With Connect	Polarity: Neutral
EUT: Wireless Portable Receiver	Power: AC 120V/60Hz
Worst Case Mode: Transmit by Full BW at channel 5788MHz at Ant 0	

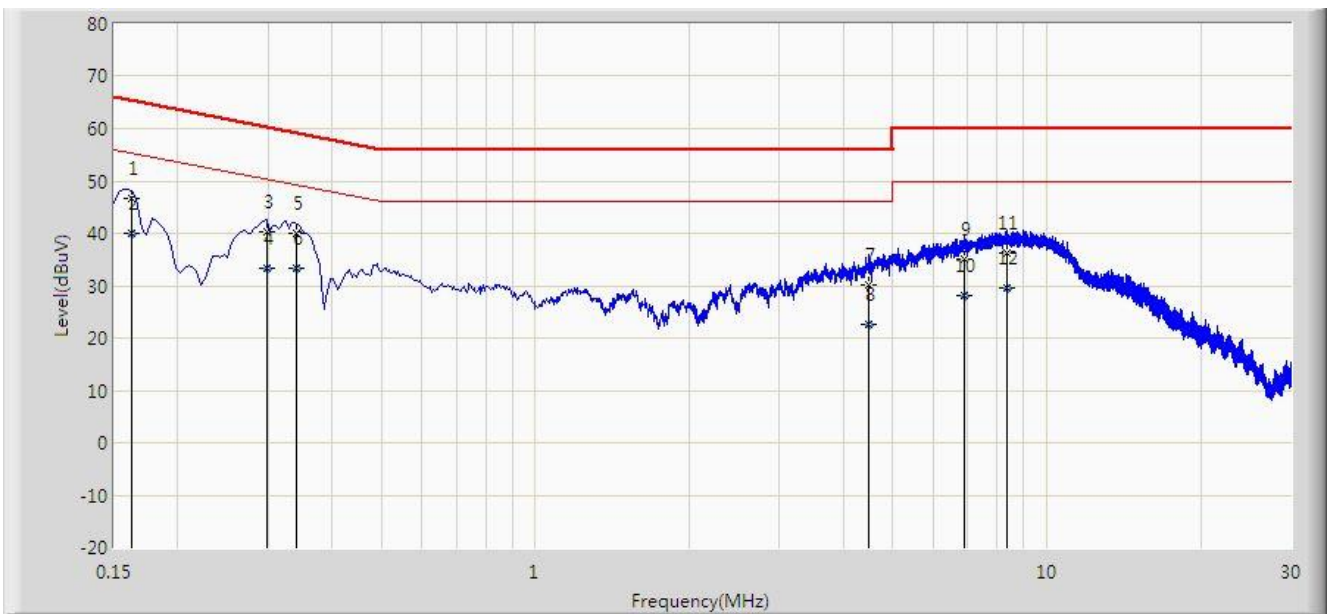

No	Flag	Mark	Frequency (MHz)	Measure Level (dBuV)	Reading Level (dBuV)	Margin (dB)	Limit (dBuV)	Factor (dB)	Type
1			0.162	46.800	37.368	-18.561	65.361	9.433	QP
2		*	0.162	40.077	30.644	-15.284	55.361	9.433	AV
3			0.298	40.281	30.765	-20.017	60.298	9.516	QP
4			0.298	33.244	23.728	-17.055	50.298	9.516	AV
5			0.342	40.086	30.561	-19.068	59.155	9.525	QP
6			0.342	33.296	23.771	-15.858	49.155	9.525	AV
7			4.490	30.263	20.585	-25.737	56.000	9.678	QP
8			4.490	22.553	12.874	-23.447	46.000	9.678	AV
9			6.914	35.099	25.282	-24.901	60.000	9.817	QP
10			6.914	28.017	18.200	-21.983	50.000	9.817	AV
11			8.342	36.087	26.196	-23.913	60.000	9.892	QP
12			8.342	29.549	19.658	-20.451	50.000	9.892	AV

Note: Measure Level (dBuV) = Reading Level (dBuV) + Factor (dB)

Factor (dB) = Cable Loss (dB) + LISN Factor (dB)

7. CONCLUSION

The data collected relate only the item(s) tested and show that the device is compliance with Part 15E of the FCC rules.

The End

Appendix A - Test Setup Photograph

Refer to "2103RSU001-UT" file.

Appendix B - EUT Photograph

Refer to "2103RSU001-UE" file.