

MEASUREMENT REPORT

FCC PART 15C

FCC ID: DD4GLXD4Z3

Applicant: Shure Incorporated

Application Type: Certification

Product: Wireless Portable Receiver

Model No.: GLXD4+ Z3

Trade Mark: 

FCC Classification: Digital Transmission System (DTS)

FCC Rule Part(s): Part 15 Subpart C (Section 15.247)

Test Procedure(s): ANSI C63.10-2013

Test Date: November 21, 2020 ~ April 07, 2021

Reviewed By: 

Jame Yuan

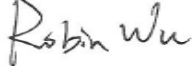
Approved By: 

Robin Wu



The test results relate only to the samples tested.

This equipment has been shown to be capable of compliance with the applicable technical standards as indicated in the measurement report and was tested in accordance with the measurement procedures specified in ANSI C63.10-2013. Test results reported herein relate only to the item(s) tested.

The test report shall not be reproduced except in full without the written approval of MRT Technology (Suzhou) Co., Ltd.

Revision History

Report No.	Version	Description	Issue Date	Note
2103RSU001-U1	Rev. 01	Initial Report	04-13-2021	Valid

CONTENTS

Description	Page
1. General Information	5
1.1. Applicant	5
1.2. Manufacturer	5
1.3. Testing Facility	5
2. PRODUCT INFORMATION	6
2.1. Equipment Description	6
2.2. Radio Specification	6
2.3. Test Frequencies	6
2.4. Antennas Details	7
2.5. Test Mode	7
2.6. Test Configuration and Software	7
2.7. Duty Cycle	8
2.8. EMI Suppression Device(s)/Modifications	8
2.9. Labeling Requirements	8
2.10. Test Environment Condition	8
3. ANTENNA REQUIREMENTS	9
4. TEST EQUIPMENT CALIBRATION DATE	10
5. MEASUREMENT UNCERTAINTY	14
6. TEST RESULT	15
6.1. Summary	15
6.2. 6dB Bandwidth Measurement	16
6.2.1. Test Limit	16
6.2.2. Test Procedure used	16
6.2.3. Test Setting	16
6.2.4. Test Setup	16
6.2.5. Test Result	17
6.3. Output Power Measurement	20
6.3.1. Test Limit	20
6.3.2. Test Procedure Used	20
6.3.3. Test Setting	20
6.3.4. Test Setup	21
6.3.5. Test Result	22
6.4. Power Spectral Density Measurement	23
6.4.1. Test Limit	23

6.4.2.	Test Procedure Used	23
6.4.3.	Test Setting.....	23
6.4.4.	Test Setup	23
6.4.5.	Test Result.....	24
6.5.	Conducted Band Edge and Out-of-Band Emissions	27
6.5.1.	Test Limit	27
6.5.2.	Test Procedure Used	27
6.5.3.	Test Setting.....	27
6.5.4.	Test Setup	28
6.5.5.	Test Result.....	29
6.6.	Radiated Spurious Emission Measurement	34
6.6.1.	Test Limit	34
6.6.2.	Test Procedure Used	34
6.6.3.	Test Setting.....	34
6.6.4.	Test Setup	36
6.6.5.	Test Result.....	37
6.7.	Radiated Restricted Band Edge Measurement.....	45
6.7.1.	Test Limit	45
6.7.2.	Test Procedure Used	46
6.7.3.	Test Setting.....	46
6.7.4.	Test Setup	47
6.7.5.	Test Result.....	48
6.8.	AC Conducted Emissions Measurement	64
6.8.1.	Test Limit	64
6.8.2.	Test Setup	64
6.8.3.	Test Result.....	65
7.	CONCLUSION	67
	Appendix A - Test Setup Photograph	68
	Appendix B - EUT Photograph.....	69

2. PRODUCT INFORMATION

2.1. Equipment Description

Product Name	Wireless Portable Receiver
Model No.	GLXD4+ Z3
Test Device Label No.	Radiated Sample: 20210301Sample#16 Conducted Sample: 20210301Sample#18
Radio Specification	2.4GHz & 5.8GHz
Operating Temperature	0 ~ 45 °C
Power Type	AC/DC Adapter
Accessories	
AC/DC Adapter	Model No.: PS43US Input Power: 100 - 240V ~ 50/60Hz, Max. 250mA Output Power: 15VDC 600mA

2.2. Radio Specification

Frequency Range	2404 ~ 2478MHz
Declared Channel Bandwidth	Full Bandwidth Mode: 2 MHz Half Bandwidth Mode: 1 MHz
Channel Number	36
Channel Spacing	1MHz
Type of Modulation	2-level CPM with Gaussian shaping (basically GFSK)
Antenna Number	2

Note 1: For other features of this EUT, test report will be issued separately.

Note 2: Total working frequencies refer to operation description.

Note 3: Two RF paths and antenna are the same and only one antenna can work during normal operation, it is switchable.

Note 4: All product information is provided by the manufacturer.

2.3. Test Frequencies

Operating Bands (MHz)	Test Frequency (MHz)		
	Lowest	Middle	Highest
2404 ~ 2478	2404	2442	2478

2.4. Antennas Details

Antenna Type	Frequency Band (MHz)	Max Peak Gain (dBi)
Dipole Antenna	2404	1.86
	2442	2.56
	2478	3.46

2.5. Test Mode

Test Mode	Mode 1: Transmit by Full BW
	Mode 2: Transmit by Half BW

Note: Bandwidth abbreviation is BW.

2.6. Test Configuration and Software

The device was tested per the guidance ANSI C63.10: 2013 that was used to reference the appropriate EUT setup for radiated spurious emissions and AC line conducted emission testing.

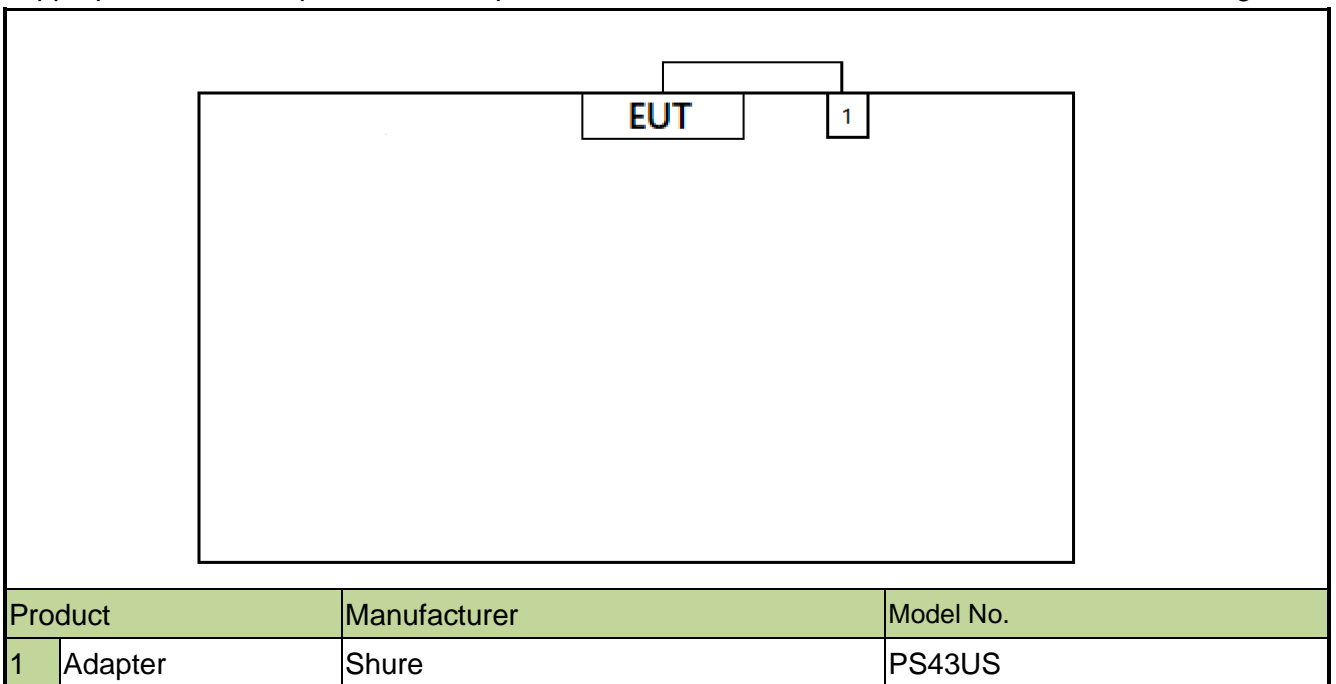

Note 1: The test utility software used during testing was "ttermpro.exe", and the version was 4.78.

Note 2: Detail power setting refer to operation description.

2.7. Duty Cycle

The maximum achievable duty cycles for all modes were determined based on measurements performed on a spectrum analyzer in zero-span mode with RBW = 8MHz, VBW = 50MHz. The RBW and VBW were both greater than 50/T, where T is the minimum transmission duration, and the number of sweep points across T was greater than 100. The duty cycles are as follows:

Test Mode	Duty Cycle (%)
Full BW	60.15
Half BW	80.33

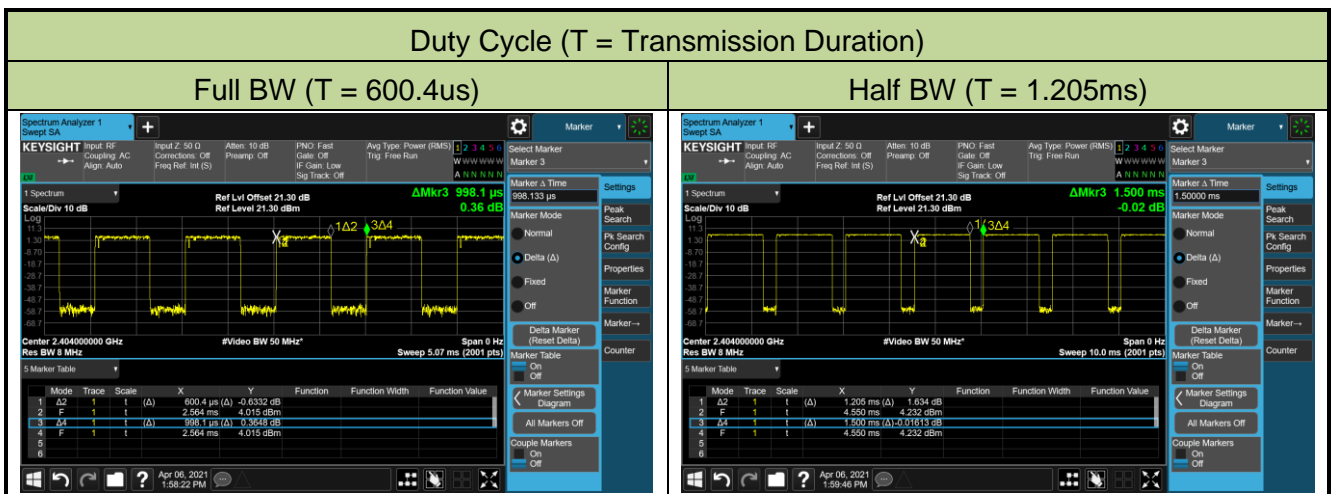

2.8. EMI Suppression Device(s)/Modifications

No EMI suppression device(s) were added and/or no modifications were made during testing.

2.9. Labeling Requirements

Per 2.1074 & 15.19; Docket 95-19

The label shall be permanently affixed at a conspicuous location on the device; instruction manual or pamphlet supplied to the user and be readily visible to the purchaser at the time of purchase.

However, when the device is so small wherein placement of the label with specified statement is not practical, only the FCC ID must be displayed on the device per Section 15.19(a)(5). Please see attachment for FCC ID label and label location.

2.10. Test Environment Condition

Ambient Temperature	15 ~ 35 °C
Relative Humidity	20 ~ 75 %RH

3. ANTENNA REQUIREMENTS

Excerpt from §15.203 of the FCC Rules/Regulations:

“An intentional radiator antenna shall be designed to ensure that no antenna other than that furnished by the responsible party can be used with the device. The use of a permanently attached antenna or of an antenna that uses a unique coupling to the intentional radiator shall be considered sufficient to comply with the provisions of this section.”

- The antenna of the device is **permanently attached**.
- There are no provisions for connection to an external antenna.

Conclusion:

The unit complies with the requirement of §15.203.

4. TEST EQUIPMENT CALIBRATION DATE

Conducted Emission (WZ-SR2)

Instrument	Manufacturer	Type No.	Asset No.	Cali. Interval	Cali. Due Date
EMI Test Receiver	R&S	ESR3	MRTSUE06185	1 year	2022/01/12
Two-Line V-Network	R&S	ENV216	MRTSUE06002	1 year	2021/09/09
Thermal Hygrometer	testo	608-H1	MRTSUE06404	1 year	2021/07/26
Shielding Room	MIX-BEP	Chamber-SR2	MRTSUE06215	N/A	N/A

Conducted Emission (SIP-SR2)

Instrument	Manufacturer	Type No.	Asset No.	Cali. Interval	Cali. Due Date
EMI Test Receiver	R&S	ESR3	MRTSUE06613	1 year	2021/07/02
Two-Line V-Network	R&S	ENV216	MRTSUE06003	1 year	2021/09/09
Thermal Hygrometer	testo	608-H1	MRTSUE06621	1 year	2021/12/03

Radiated Emission (WZ-AC1)

Instrument	Manufacturer	Type No.	Asset No.	Cali. Interval	Cali. Due Date
EMI Test Receiver	R&S	ESR7	MRTSUE06001	1 year	2022/01/12
PXA Signal Analyzer	Keysight	N9030B	MRTSUE06395	1 year	2021/08/30
Loop Antenna	Schwarzbeck	FMZB 1519	MRTSUE06025	1 year	2021/10/22
Bilog Period Antenna	Schwarzbeck	VULB 9168	MRTSUE06172	1 year	2021/08/08
Horn Antenna	Schwarzbeck	BBHA 9120D	MRTSUE06023	1 year	2021/09/27
Horn Antenna	Schwarzbeck	BBHA9170	MRTSUE06597	1 year	2021/12/14
Microwave System Amplifier	Agilent	83017A	MRTSUE06076	1 year	2021/11/14
Preamplifier	Schwarzbeck	BBV 9721	MRTSUE06121	1 year	2021/06/11
Thermal Hygrometer	testo	608-H1	MRTSUE06403	1 year	2021/07/26
Anechoic Chamber	TDK	Chamber-AC1	MRTSUE06212	1 year	2021/04/30

Radiated Emission (WZ-AC2)

Instrument	Manufacturer	Type No.	Asset No.	Cali. Interval	Cali. Due Date
MXE EMI Receiver	Keysight	N9038A	MRTSUE06125	1 year	2021/07/02
Loop Antenna	Schwarzbeck	FMZB 1519	MRTSUE06025	1 year	2021/10/22
Bilog Period Antenna	Schwarzbeck	VULB 9162	MRTSUE06022	1 year	2021/05/26
Broad-Band Horn Antenna	Schwarzbeck	BBHA 9120D	MRTSUE06171	1 year	2021/10/25
Horn Antenna	Schwarzbeck	BBHA9170	MRTSUE06597	1 year	2021/12/14
Broadband Coaxial Preamplifier	Schwarzbeck	BBV 9718	MRTSUE06176	1 year	2021/11/14
Preamplifier	Schwarzbeck	BBV 9721	MRTSUE06121	1 year	2021/06/11
Thermal Hygrometer	Minggao	ETH529	MRTSUE06170	1 year	2021/12/08
Anechoic Chamber	RIKEN	Chamber-AC2	MRTSUE06213	1 year	2021/04/30

Radiated Emission (SIP-AC1)

Instrument	Manufacturer	Type No.	Asset No.	Cali. Interval	Cali. Due Date
EMI Test Receiver	R&S	ESR3	MRTSUE06612	1 year	2021/07/02
EXA Signal Analyzer	Keysight	N9010B	MRTSUE06559	1 year	2021/07/23
Loop Antenna	Schwarzbeck	FMZB 1519	MRTSUE06025	1 year	2021/10/22
Bilog Period Antenna	Schwarzbeck	VULB9168	MRTSUE06645	1 year	2021/08/30
Double Ridged Horn Antenna	R&S	HF907	MRTSUE06610	1 year	2021/08/30
Preamplifier	EMCI	EMC051845SE	MRTSUE06600	1 year	2021/11/09
Thermal Hygrometer	testo	608-H1	MRTSUE06620	1 year	2021/12/03
Anechoic Chamber	RIKEN	SIP-SIP-AC1	MRTSUE06554	1 year	2021/12/24

Radiated Emission (SIP-AC2)

Instrument	Manufacturer	Type No.	Asset No.	Cali. Interval	Cali. Due Date
EMI Test Receiver	R&S	ESR3	MRTSUE06613	1 year	2021/07/02
MXA Signal Analyzer	Keysight	N9020B	MRTSUE06604	1 year	2021/09/26
Loop Antenna	Schwarzbeck	FMZB 1519	MRTSUE06025	1 year	2021/10/22
Bilog Period Antenna	Schwarzbeck	VULB9168	MRTSUE06646	1 year	2021/08/30
Horn Antenna	Schwarzbeck	BBHA9120D	MRTSUE06648	1 year	2021/11/26
Horn Antenna	Schwarzbeck	BBHA9170	MRTSUE06599	1 year	2021/11/26
Preamplifier	EMCI	EMC051845SE	MRTSUE06644	1 year	2021/11/09
Preamplifier	EMCI	EMC184045SE	MRTSUE06602	1 year	2021/10/12
Thermal Hygrometer	testo	608-H1	MRTSUE06624	1 year	2021/12/03
Anechoic Chamber	RIKEN	SIP-AC2	MRTSUE06781	1 year	2021/12/24

Radiated Emission (SIP-AC3)

Instrument	Manufacturer	Type No.	Asset No.	Cali. Interval	Cali. Due Date
EMI Test Receiver	R&S	ESR3	MRTSUE06612	1 year	2021/07/02
EXA Signal Analyzer	Keysight	N9010B	MRTSUE06559	1 year	2021/07/23
Loop Antenna	Schwarzbeck	FMZB 1519	MRTSUE06025	1 year	2021/10/22
Bilog Period Antenna	Schwarzbeck	VULB9168	MRTSUE06647	1 year	2021/08/08
Double Ridged Horn Antenna	R&S	HF907	MRTSUE06611	1 year	2021/09/13
Horn Antenna	Schwarzbeck	BBHA9170	MRTSUE06598	1 year	2021/11/26
Preamplifier	EMCI	EMC012645SE	MRTSUE06642	1 year	2022/01/15
Preamplifier	EMCI	EMC184045SE	MRTSUE06641	1 year	2022/01/15
Thermal Hygrometer	testo	608-H1	MRTSUE06622	1 year	2021/12/03
Anechoic Chamber	RIKEN	SIP-AC3	MRTSUE06782	1 year	2021/12/24

Conducted Test Equipment (WZ-TR3)

Instrument	Manufacturer	Type No.	Asset No.	Cali. Interval	Cali. Due Date
EXA Signal Analyzer	Agilent	N9020A	MRTSUE06106	1 year	2022/04/13
EXA Signal Analyzer	Keysight	N9010B	MRTSUE06607	1 year	2022/01/07
Signal Analyzer	R&S	FSV40	MRTSUE06218	1 year	2022/04/13
Power Meter	Agilent	U2021XA	MRTSUE06030	1 year	2021/10/22
USB wideband power sensor	Keysight	U2021XA	MRTSUE06446	1 year	2021/08/30
USB wideband power sensor	Keysight	U2021XA	MRTSUE06447	1 year	2021/08/08
Bluetooth Test Set	Anritsu	MT8852B-042	MRTSUE06389	1 year	2021/06/11
Audio Analyzer	Agilent	U8903B	MRTSUE06143	1 year	2021/06/11
Modulation Analyzer	HP	HP8901A	MRTSUE06098	1 year	2021/09/26
Wideband Radio Communication Tester	R&S	CMW 500	MRTSUE06243	1 year	2021/10/20
DC Power Supply	GWINSTEK	DPS-3303C	MRTSUE06064	N/A	N/A
Temperature & Humidity Chamber	BAOYT	BYH-150CL	MRTSUE06051	1 year	2021/10/22
Thermal Hygrometer	testo	608-H1	MRTSUE06401	1 year	2021/07/26
Attenuator	MVE	6dB	MRTSUE06534	1 year	N/A
Attenuator	MVE	10dB	MRTSUE06543	1 year	N/A

Conducted Test Equipment (SIP-SR5)

Instrument	Manufacturer	Type No.	Asset No.	Cali. Interval	Cali. Due Date
Signal Analyzer	R&S	FSV40	MRTSUE06218	1 year	2022/04/13
PXA Signal Analyzer	Keysight	N9030B	MRTSUE06395	1 year	2021/08/30
USB wideband power sensor	Agilent	U2021XA	MRTSUE06595	1 year	2021/09/26
USB wideband power sensor	Agilent	U2021XA	MRTSUE06596	1 year	2021/09/26
Wideband Radio Communication Tester	R&S	CMW 500	MRTSUE06243	1 year	2021/10/20
Bluetooth Test Set	Anritsu	MT8852B-042	MRTSUE06389	1 year	2021/06/11
Temperature Chamber	BAOYT	BYG-408CS	MRTSUE06847	1 year	2022/02/23
Thermal Hygrometer	testo	622	MRTSUE06629	1 year	2021/11/25

Software	Version	Function
EMI Software	V3	EMI Test Software

5. MEASUREMENT UNCERTAINTY

Where relevant, the following test uncertainty levels have been estimated for tests performed on the EUT as specified in CISPR 16-4-2. This uncertainty represents an expanded uncertainty expressed at approximately the 95% confidence level using a coverage factor of $k = 2$.

AC Conducted Emission Measurement
Measurement Uncertainty for a Level of Confidence of 95% ($U=2Uc(y)$): 9kHz~150kHz: 3.74dB 150kHz~30MHz: 3.44dB
Radiated Disturbance
Measurement Uncertainty for a Level of Confidence of 95% ($U=2Uc(y)$): Horizontal: 9kHz~300MHz: 5.04dB 300MHz~1GHz: 4.95dB 1GHz~40GHz: 6.40dB Vertical: 9kHz~300MHz: 5.24dB 300MHz~1GHz: 6.03dB 1GHz~40GHz: 6.40dB
Spurious Emissions, Conducted
Measuring Uncertainty for a Level of Confidence of 95% ($U=2Uc(y)$): 0.78dB
Output Power
Measuring Uncertainty for a Level of Confidence of 95% ($U=2Uc(y)$): 1.13dB
Power Spectrum Density
Measuring Uncertainty for a Level of Confidence of 95% ($U=2Uc(y)$): 1.15dB
Occupied Bandwidth
Measuring Uncertainty for a Level of Confidence of 95% ($U=2Uc(y)$): 0.28%

6. TEST RESULT

6.1. Summary

FCC Part Section(s)	Test Description	Test Limit	Test Condition	Test Result	Reference
15.247(a)(2)	6dB Bandwidth	$\geq 500\text{kHz}$	Conducted	Pass	Section 6.2
15.247(b)(3)	Output Power	$\leq 1\text{Watt}$		Pass	Section 6.3
15.247(e)	Power Spectral Density	$\leq 8\text{dBm} / 3\text{kHz}$		Pass	Section 6.4
15.247(d)	Band Edge / Out-of-Band Emissions	$\geq 20\text{dBc (Peak)}$		Pass	Section 6.5
15.205 15.209	General Field Strength Limits (Restricted Bands and Radiated Emission Limits)	Emissions in restricted bands must meet the radiated limits detailed in 15.209	Radiated	Pass	Section 6.6 & 6.7
15.207	AC Conducted Emissions 150kHz - 30MHz	$< \text{FCC 15.207 limits}$	Line Conducted	Pass	Section 6.8

Notes:

- 1) The analyzer plots shown in this section were all taken with a correction table loaded into the analyzer. The correction table was used to account for the losses of the cables and attenuators used as part of the system to connect the EUT to the analyzer at all frequencies of interest.
- 2) Test Item "Output Power" was assessed two antenna ports, any others test items were assessed the worst case antenna port.

6.2. 6dB Bandwidth Measurement

6.2.1. Test Limit

The minimum 6dB bandwidth shall be at least 500 kHz.

6.2.2. Test Procedure used

ANSI C63.10-2013 - Section 11.8

6.2.3. Test Setting

1. The Spectrum's automatic bandwidth measurement capability was used to perform the 6dB bandwidth measurement. The "X" dB bandwidth parameter was set to $X = 6$. The bandwidth measurement was not influenced by any intermediate power nulls in the fundamental emission.
2. Set RBW = 100 kHz
3. $VBW \geq 3 \times RBW$
4. Detector = Peak
5. Trace mode = Max hold
6. Sweep = Auto couple
7. Allow the trace was allowed to stabilize

6.2.4. Test Setup

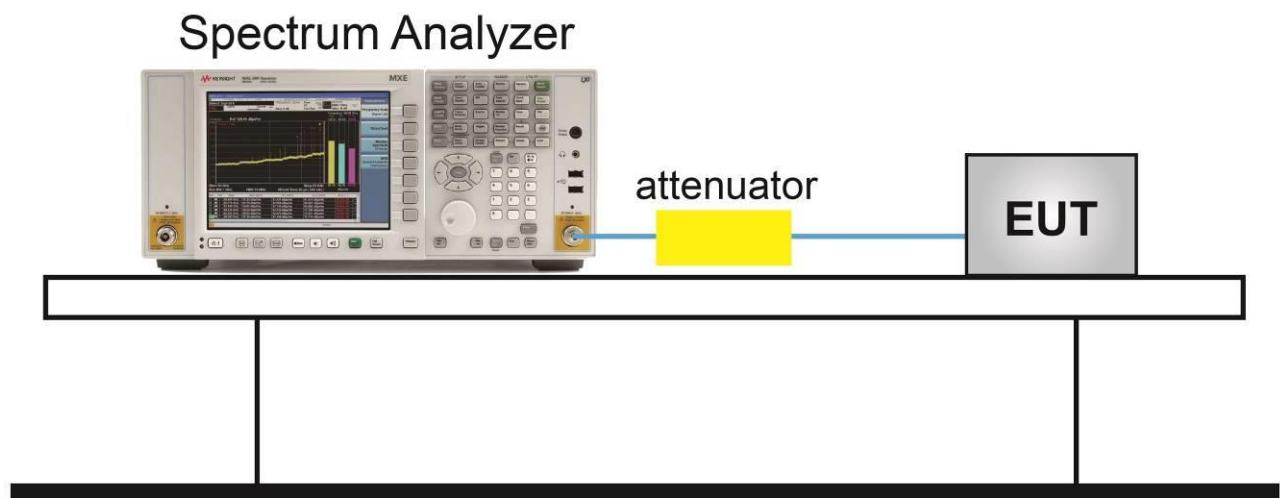

6.2.5. Test Result

Test Site	SIP-SR5	Test Engineer	Alisa Deng
Test Date	2021/04/06		
Antenna Port	Ant 0		

Test Mode	Frequency (MHz)	6dB Bandwidth (MHz)	Limit (MHz)	Result
Full BW	2404	1.905	≥ 0.5	Pass
Full BW	2442	2.025	≥ 0.5	Pass
Full BW	2478	2.024	≥ 0.5	Pass
Half BW	2404	1.015	≥ 0.5	Pass
Half BW	2442	1.035	≥ 0.5	Pass
Half BW	2478	1.031	≥ 0.5	Pass

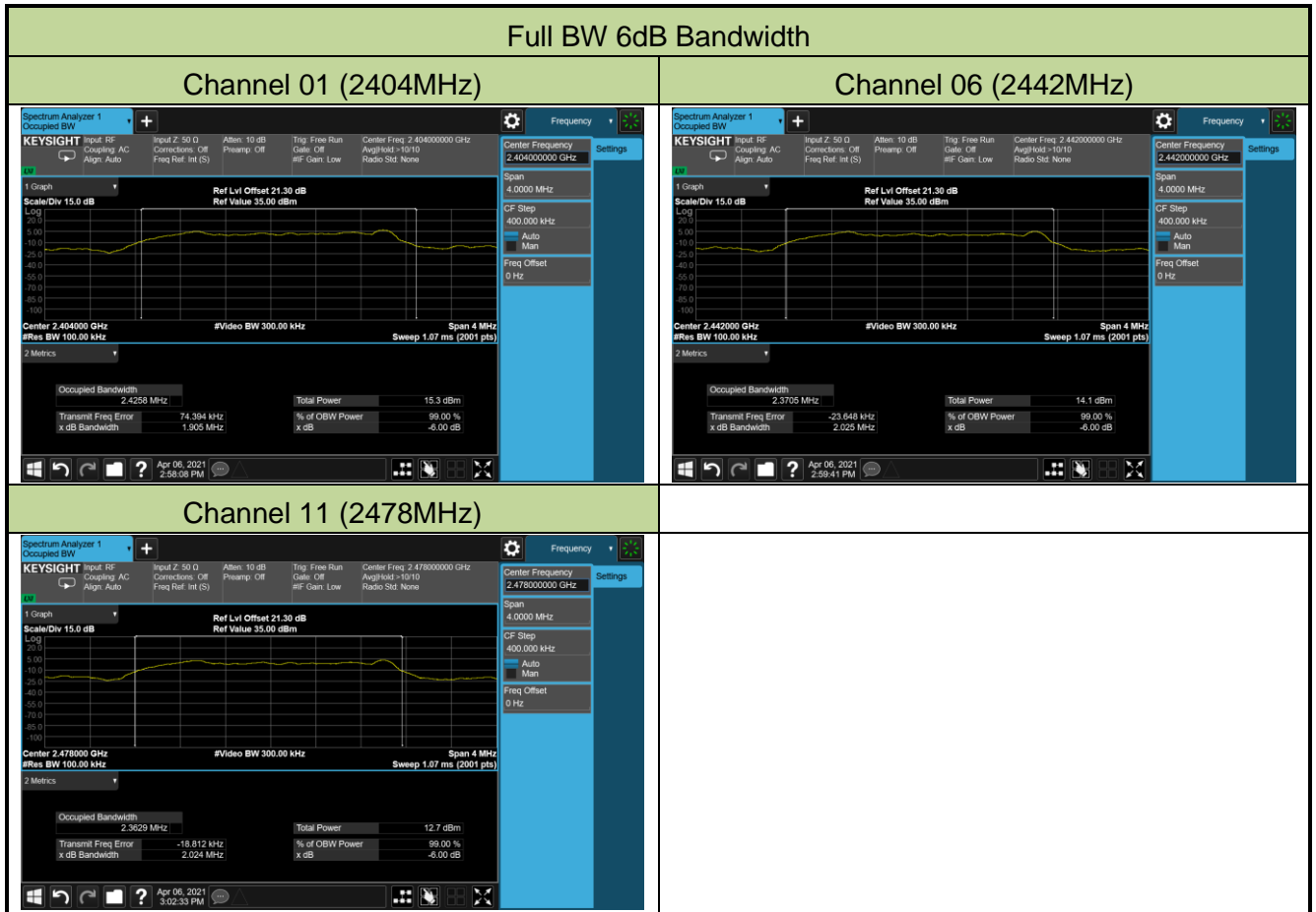

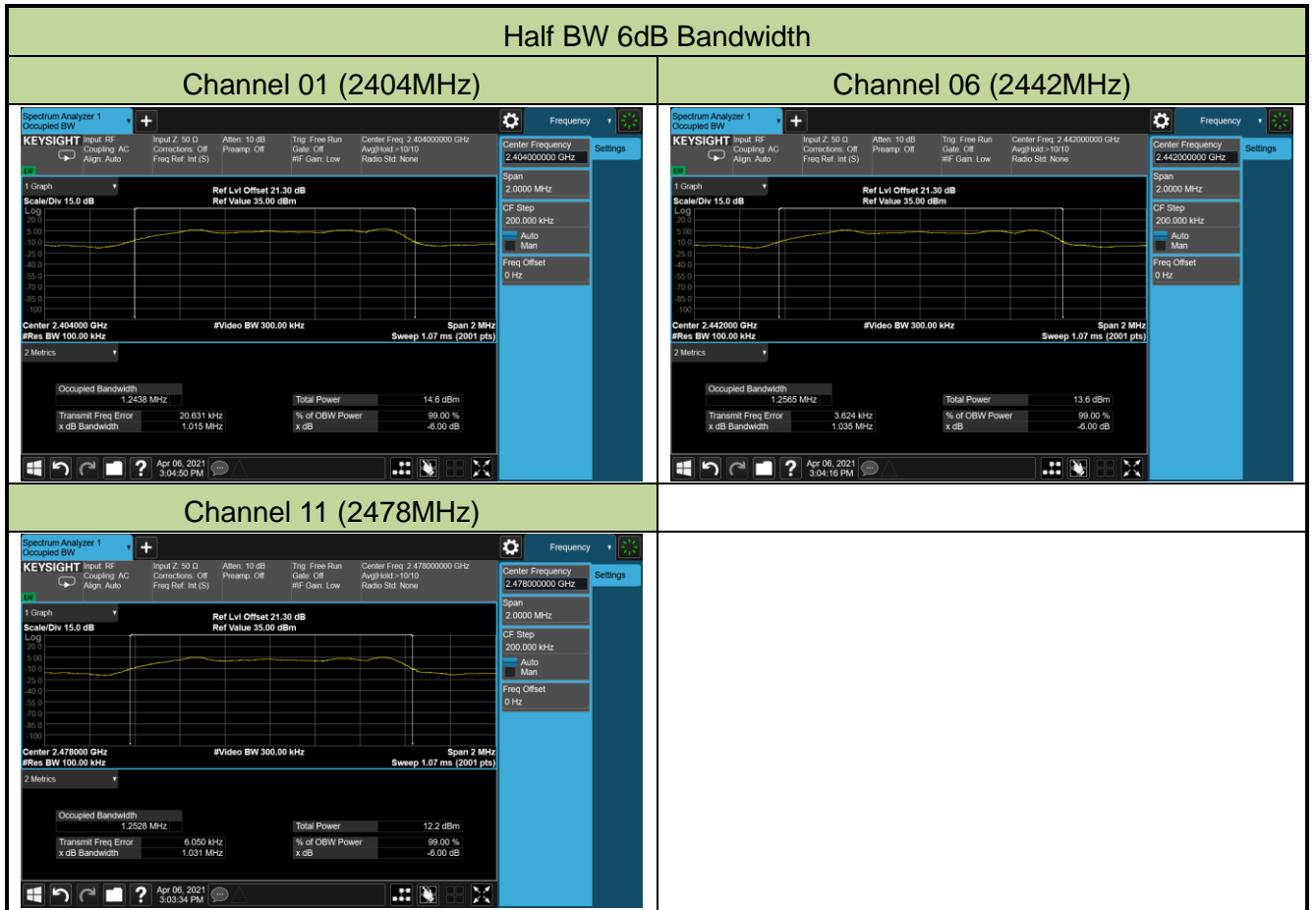

6.3. Output Power Measurement

6.3.1. Test Limit

The maximum out power shall be less 1 Watt (30dBm).

The conducted output power limit specified in paragraph FCC Part 15.247(b) of this section is based on the use of antennas with directional gains that do not exceed 6 dBi. If transmitting antennas of directional gain greater than 6 dBi are used, the conducted output power from the intentional radiator shall be reduced below the stated values in paragraphs FCC Part 15.247(b)(3) of this section, as appropriate, by the amount in dB that the directional gain of the antenna exceeds 6 dBi.

6.3.2. Test Procedure Used

ANSI C63.10-2013 Section 11.9.1.3

ANSI C63.10-2013 Section 11.9.2.3

6.3.3. Test Setting

Method PKPM1 (Peak Power Measurement of Signals with DTS BW \leq 50MHz)

Peak power measurements were performed only when the EUT was transmitting at its maximum power control level using a broadband power meter with a pulse sensor. The pulse sensor employs a VBW = 50MHz so this method was only used for signals whose DTS bandwidth was less than or equal to 50MHz.

Average Power Measurement

Average power measurements were performed only when the EUT was transmitting at its maximum power control level using a broadband power meter with a pulse sensor. The power meter implemented triggering and gating capabilities which were set up such that power measurements were recorded only during the ON time of the transmitter.

6.3.4. Test Setup

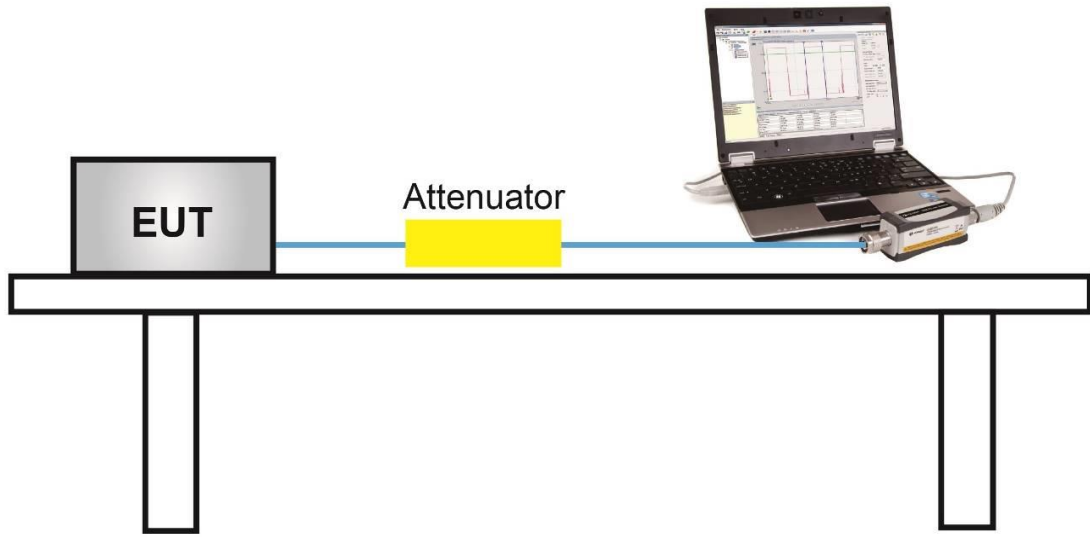

6.3.5. Test Result

Test Site	SIP-SR5	Test Engineer	Alisa Deng
Test Date	2021/03/24		

Test Mode	Freq. (MHz)	Peak Power (dBm)		Limit (dBm)	Result
		Ant 0	Ant 1		
Full BW	2404	8.24	7.11	≤ 30.00	Pass
Full BW	2442	7.05	6.51	≤ 30.00	Pass
Full BW	2478	5.70	6.25	≤ 30.00	Pass
Half BW	2404	8.06	7.03	≤ 30.00	Pass
Half BW	2442	6.92	6.39	≤ 30.00	Pass
Half BW	2478	5.61	6.04	≤ 30.00	Pass

Test Result of Average Output Power (Reporting Only)

Test Mode	Freq. (MHz)	Average Power (dBm)		Limit (dBm)	Result
		Ant 0	Ant 1		
Full BW	2404	7.18	6.28	≤ 30.00	Pass
Full BW	2442	6.10	5.54	≤ 30.00	Pass
Full BW	2478	4.62	5.29	≤ 30.00	Pass
Half BW	2404	7.28	6.33	≤ 30.00	Pass
Half BW	2442	6.16	5.55	≤ 30.00	Pass
Half BW	2478	4.75	5.29	≤ 30.00	Pass

6.4. Power Spectral Density Measurement

6.4.1. Test Limit

The maximum permissible power spectral density is 8dBm in any 3 kHz band.

The same method of determining the conducted output power shall be used to determine the power spectral density.

6.4.2. Test Procedure Used

ANSI C63.10-2013 - Section 11.10.2

6.4.3. Test Setting

1. Analyzer was set to the center frequency of the DTS channel under investigation
2. Span ≥ 1.5 times the OBW
3. RBW = 3kHz
4. VBW = 10kHz
5. Detector = Peak
6. Sweep time = auto couple
7. Trace mode = max hold
8. Trace was allowed to stabilize

6.4.4. Test Setup

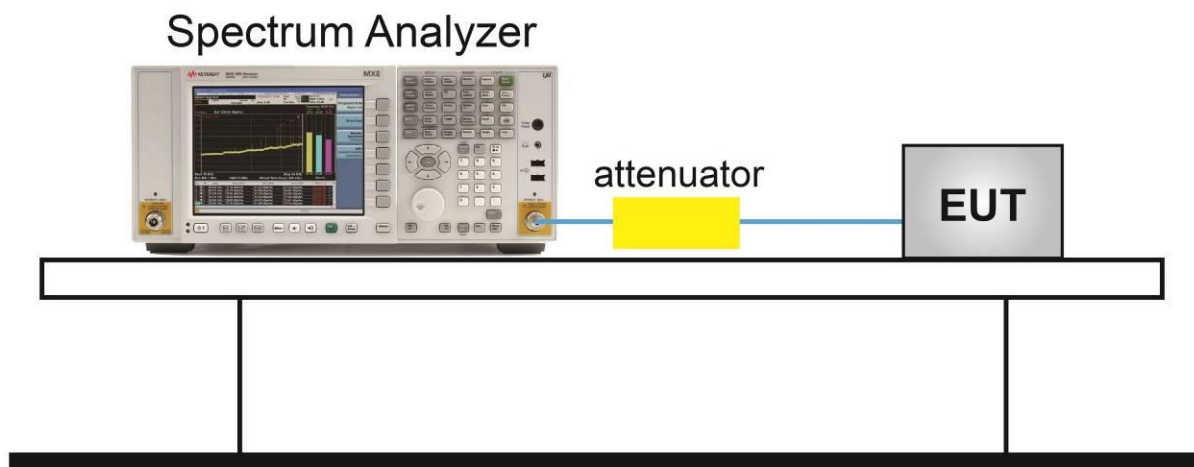

6.4.5. Test Result

Test Site	SIP-SR5	Test Engineer	Alisa Deng
Test Date	2020/04/06		
Antenna Port	Ant 0		

Test Mode	Freq. (MHz)	PKPSD (dBm / 3kHz)	Limit (dBm / 3kHz)	Result
Full BW	2404	-10.94	≤ 8.00	Pass
Full BW	2442	-12.01	≤ 8.00	Pass
Full BW	2478	-13.33	≤ 8.00	Pass
Half BW	2404	-7.57	≤ 8.00	Pass
Half BW	2442	-8.70	≤ 8.00	Pass
Half BW	2478	-10.06	≤ 8.00	Pass

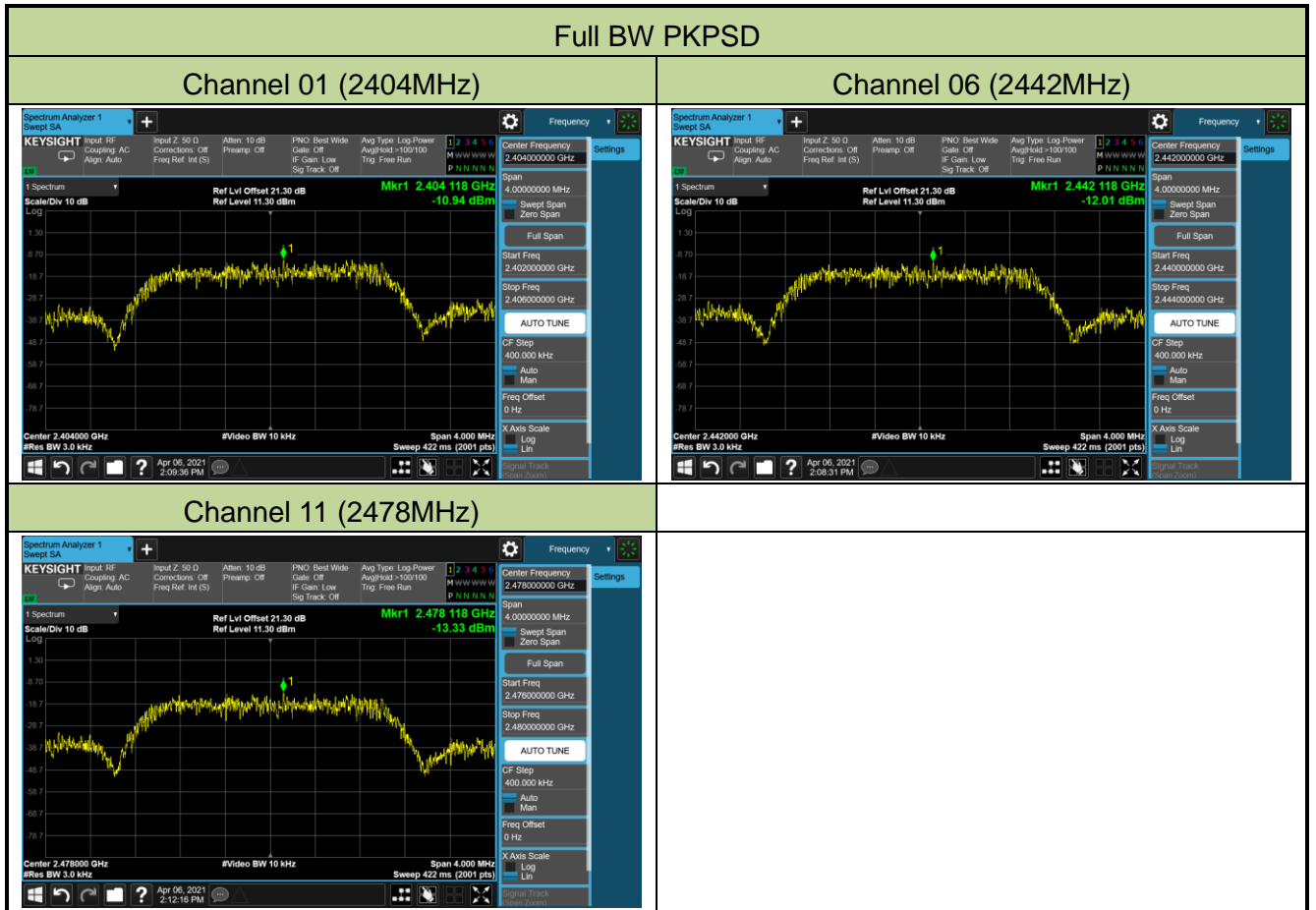

Half BW PKPSD

Channel 01 (2404MHz)

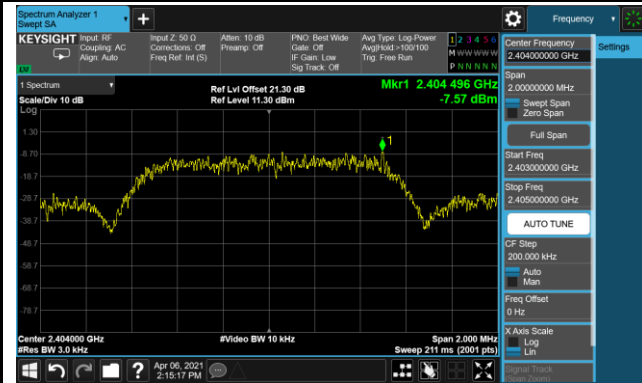

Channel 06 (2442MHz)

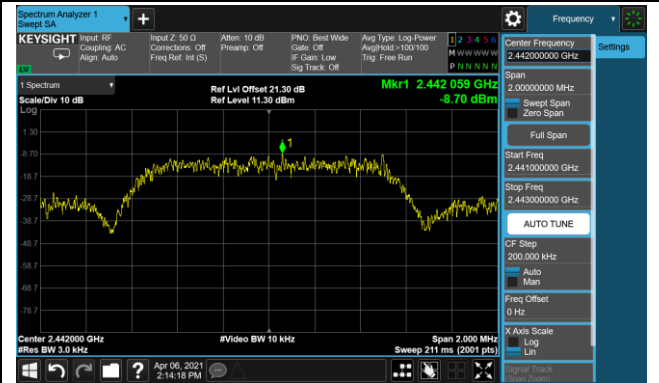

Channel 11 (2478MHz)

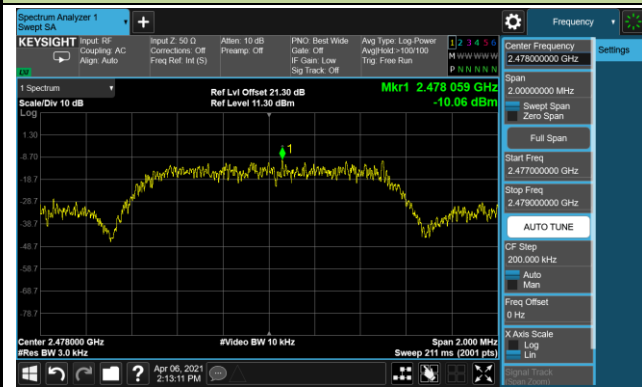

6.5. Conducted Band Edge and Out-of-Band Emissions

6.5.1. Test Limit

The limit for out-of-band spurious emissions at the band edge is 20dB below the fundamental emission level, as determined from the in-band power measurement of the DTS channel performed in a 100 kHz bandwidth per the PSD procedure.

6.5.2. Test Procedure Used

ANSI C63.10-2013 - Section 11.11

6.5.3. Test Setting

Reference level measurement

1. Set instrument center frequency to DTS channel center frequency
2. Set the span to ≥ 1.5 times the DTS bandwidth
3. Set the RBW = 100 kHz
4. Set the VBW $\geq 3 \times$ RBW
5. Detector = peak
6. Sweep time = auto couple
7. Trace mode = max hold
8. Allow trace to fully stabilize

Emission level measurement

1. Set the center frequency and span to encompass frequency range to be measured
2. RBW = 100kHz
3. VBW = 300kHz
4. Detector = Peak
5. Trace mode = max hold
6. Sweep time = auto couple
7. The trace was allowed to stabilize

6.5.4. Test Setup

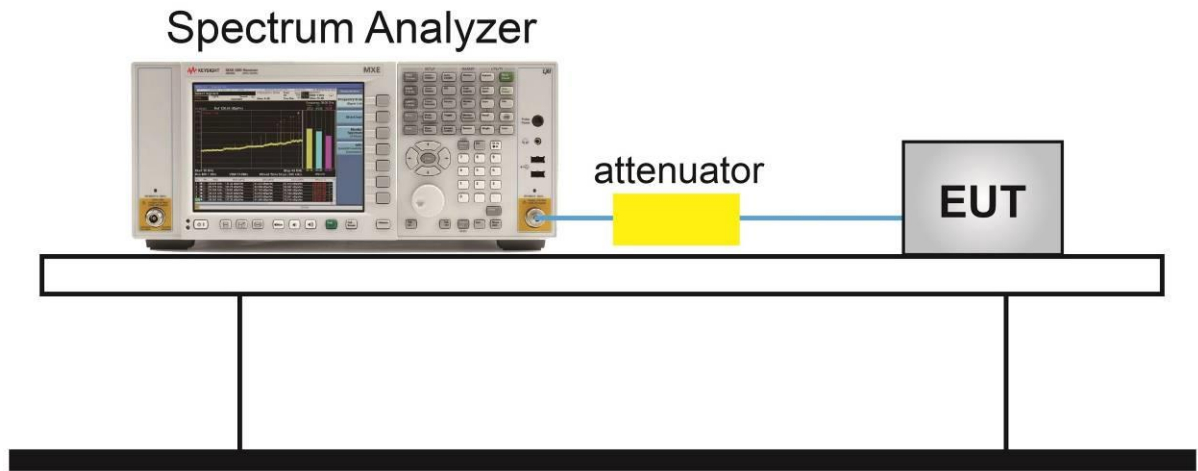

6.5.5. Test Result

Test Site	SIP-SR5	Test Engineer	Alisa Deng
Test Date	2021/04/06		
Antenna Port	Ant 0		

Test Mode	Frequency (MHz)	Limit (dBc)	Result
Full BW	2404	20	Pass
Full BW	2442	20	Pass
Full BW	2478	20	Pass
Half BW	2404	20	Pass
Half BW	2442	20	Pass
Half BW	2478	20	Pass

Full BW Out-of-Band Emissions

2404MHz

100kHz PSD Reference Level



Low Band Edge



Spurious Emission



2442MHz

100kHz PSD Reference Level

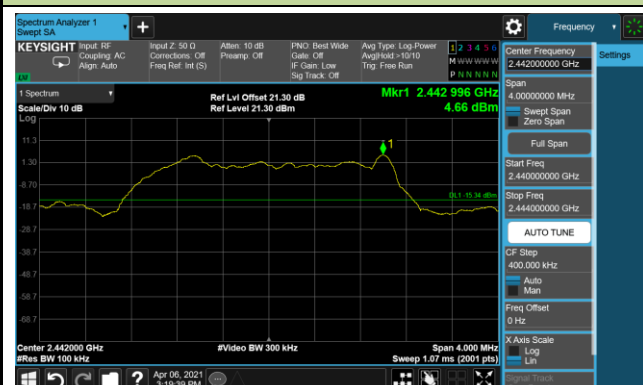

Spurious Emission

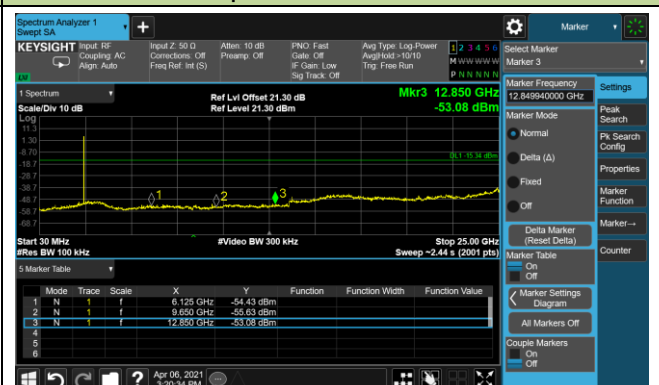

Full BW Out-of-Band Emissions

2478MHz

100kHz PSD Reference Level

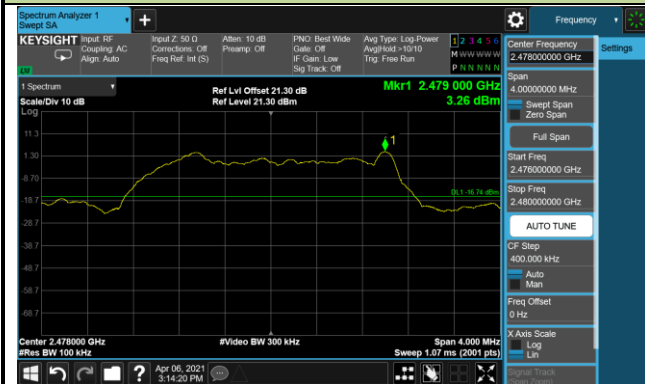

High Band Edge



Spurious Emission



Half BW Out-of-Band Emissions

2404MHz

100kHz PSD Reference Level

Low Band Edge

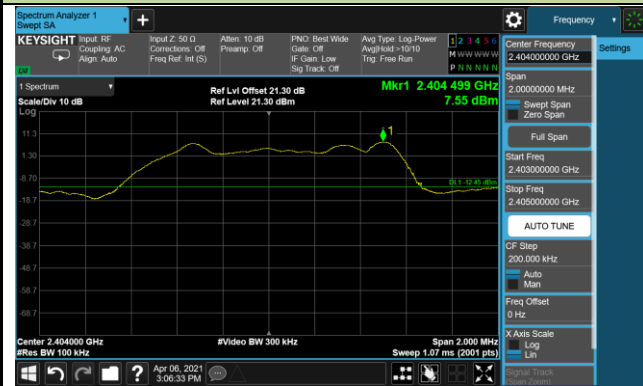

Spurious Emission



2442MHz

100kHz PSD Reference Level

Spurious Emission



Half BW Out-of-Band Emissions

2478MHz

100kHz PSD Reference Level

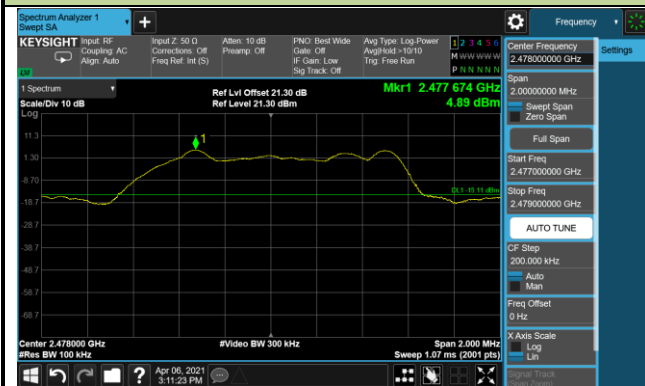

High Band Edge



Spurious Emission

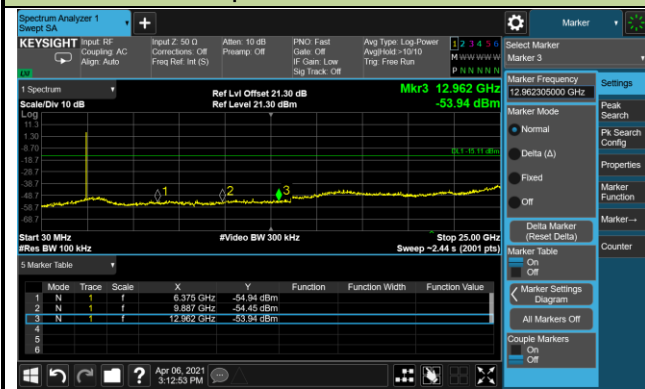

6.6. Radiated Spurious Emission Measurement

6.6.1. Test Limit

All out of band emissions appearing in a restricted band as specified in Section 15.205 of the Title 47 CFR must not exceed the limits shown in Table per Section 15.209.

FCC Part 15 Subpart C Paragraph 15.209		
Frequency [MHz]	Field Strength [uV/m]	Measured Distance [Meters]
0.009 - 0.490	2400/F (kHz)	300
0.490 - 1.705	24000/F (kHz)	30
1.705 - 30	30	30
30 - 88	100	3
88 - 216	150	3
216 - 960	200	3
Above 960	500	3

6.6.2. Test Procedure Used

ANSI C63.10-2013 - Section 6.3 & 6.4 & 6.5 & 6.6

6.6.3. Test Setting

Table 1 - RBW as a function of frequency

Frequency	RBW
9 ~ 150 kHz	200 ~ 300 Hz
0.15 ~ 30 MHz	9 ~ 10 kHz
30 ~ 1000 MHz	100 ~ 120 kHz
> 1000MHz	1MHz

Quasi-Peak Measurements below 1GHz

1. Analyzer center frequency was set to the frequency of the radiated spurious emission of interest
2. Span was set greater than 1MHz
3. RBW = as specified in Table 1
4. Detector = CISPR quasi-peak
5. Sweep time = auto couple
6. Trace was allowed to stabilize

Peak Measurements above 1GHz

1. Analyzer center frequency was set to the frequency of the radiated spurious emission of interest
2. RBW = 1MHz
3. VBW = 3MHz
4. Detector = peak
5. Sweep time = auto couple
6. Trace mode = max hold
7. Trace was allowed to stabilize

Average Measurements above 1GHz (Method VB)

1. Analyzer center frequency was set to the frequency of the radiated spurious emission of interest
2. RBW = 1MHz
3. VBW; If the EUT is configured to transmit with duty cycle $\geq 98\%$, set VBW = 10 Hz.
If the EUT duty cycle is $< 98\%$, set VBW $\geq 1/T$. T is the minimum transmission duration.
4. Detector = Peak
5. Sweep time = auto
6. Trace mode = max hold
7. Trace was allowed to stabilize

6.6.4. Test Setup

Below 1GHz Test Setup:

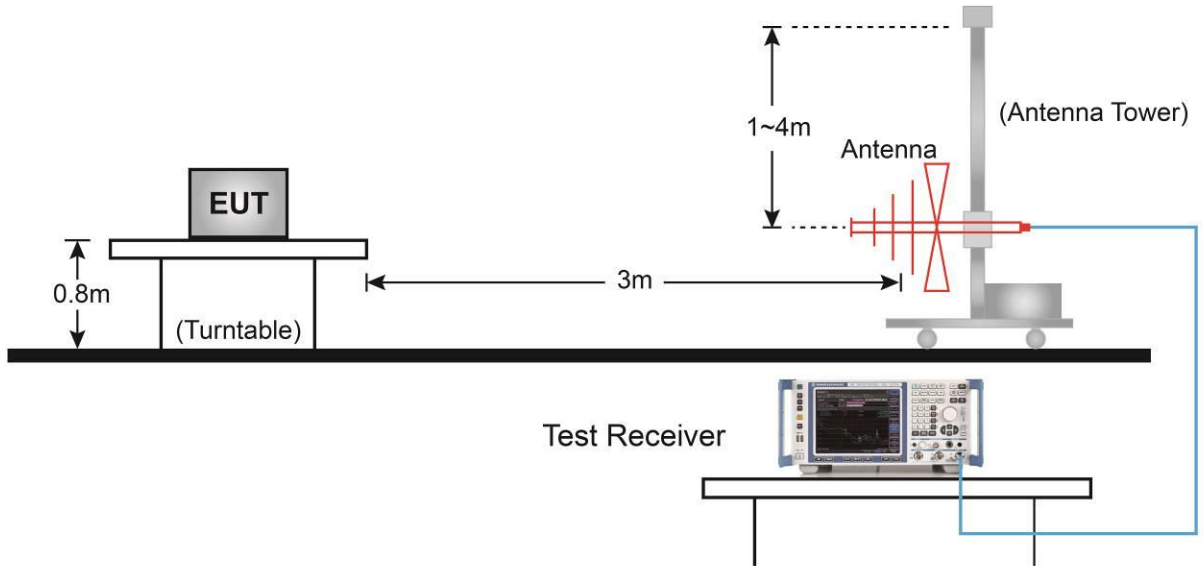

Above 1GHz Test Setup:

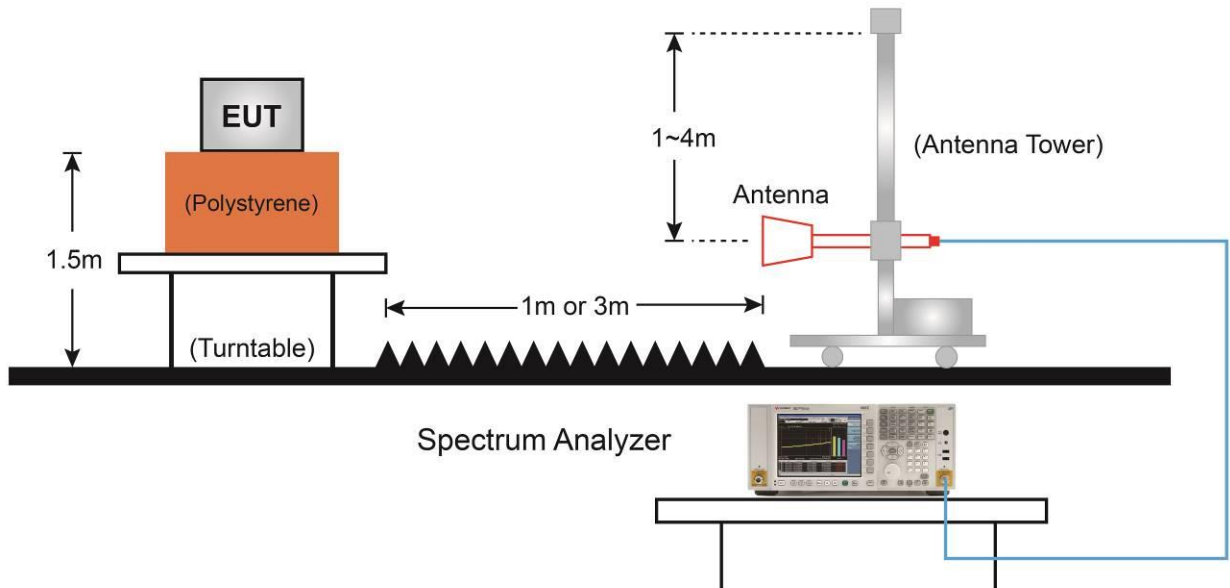

6.6.5. Test Result

Test Site	SIP-AC3	Test Engineer	Allen Zou
Test Date	2020/11/21	Test Frequency	2404MHz
Test Mode	Full BW, Ant 0		
Remark	1. Average measurement was not performed if peak level lower than average limit. 2. Other frequency was 20dB below limit line within 1-18GHz, there is not show in the report.		

Mark	Frequency (MHz)	Reading Level (dB μ V)	Factor (dB)	Measure Level (dB μ V/m)	Limit (dB μ V/m)	Margin (dB)	Detector	Polarization
*	9806.0	49.6	-3.4	46.2	74	-27.8	Peak	Horizontal
*	10282.0	49.3	-2.8	46.5	74	-27.5	Peak	Horizontal
	11582.5	49.9	-3.7	46.2	74	-27.8	Peak	Horizontal
	12526.0	49.6	-2.6	47.0	74	-27.0	Peak	Horizontal
*	9619.0	55.7	-3.6	52.1	74	-21.9	Peak	Vertical
*	10231.0	49.3	-3.1	46.2	74	-27.8	Peak	Vertical
	11540.0	50.6	-3.8	46.8	74	-27.2	Peak	Vertical
	12084.0	49.2	-3.4	45.8	74	-28.2	Peak	Vertical

Note 1: "*" means test frequency didn't fall into restricted band.

Note 2: Measure Level (dB μ V/m) = Reading Level (dB μ V) + Factor (dB)

Factor (dB) = Cable Loss (dB) + Antenna Factor (dB/m) - Pre_Amplifier Gain (dB)

Test Site	SIP-AC3	Test Engineer	Allen Zou
Test Date	2020/11/21	Test Frequency	2442MHz
Test Mode	Full BW, Ant 0		
Remark	1. Average measurement was not performed if peak level lower than average limit. 2. Other frequency was 20dB below limit line within 1-18GHz, there is not show in the report.		

Mark	Frequency (MHz)	Reading Level (dB μ V)	Factor (dB)	Measure Level (dB μ V/m)	Limit (dB μ V/m)	Margin (dB)	Detector	Polarization
*	9763.5	51.9	-3.4	48.5	74	-25.5	Peak	Horizontal
*	10222.5	49.3	-3.2	46.1	74	-27.9	Peak	Horizontal
	11030.0	50.1	-3.3	46.8	74	-27.2	Peak	Horizontal
	11999.0	49.4	-2.9	46.5	74	-27.5	Peak	Horizontal
	7324.0	55.2	-6.9	48.3	74	-25.7	Peak	Vertical
	7672.5	51.1	-5.9	45.2	74	-28.8	Peak	Vertical
*	9763.5	56.1	-3.4	52.7	74	-21.3	Peak	Vertical
*	9993.0	49.5	-2.9	46.6	74	-27.4	Peak	Vertical

Note 1: "*" means test frequency didn't fall into restricted band.

Note 2: Measure Level (dB μ V/m) = Reading Level (dB μ V) + Factor (dB)

Factor (dB) = Cable Loss (dB) + Antenna Factor (dB/m) - Pre_Amplifier Gain (dB)

Test Site	SIP-AC3	Test Engineer	Allen Zou
Test Date	2020/11/21	Test Frequency	2478MHz
Test Mode	Full BW, Ant 0		
Remark	1. Average measurement was not performed if peak level lower than average limit. 2. Other frequency was 20dB below limit line within 1-18GHz, there is not show in the report.		

Mark	Frequency (MHz)	Reading Level (dB μ V)	Factor (dB)	Measure Level (dB μ V/m)	Limit (dB μ V/m)	Margin (dB)	Detector	Polarization
*	9831.5	49.5	-3.6	45.9	74	-28.1	Peak	Horizontal
*	10214.0	48.7	-3.3	45.4	74	-28.6	Peak	Horizontal
	11608.0	50.2	-3.6	46.6	74	-27.4	Peak	Horizontal
	12067.0	48.9	-3.4	45.5	74	-28.5	Peak	Horizontal
	7434.5	56.7	-6.7	50.0	74	-24.0	Peak	Vertical
	7630.0	51.2	-6.0	45.2	74	-28.8	Peak	Vertical
*	9908.0	53.5	-3.5	50.0	74	-24.0	Peak	Vertical
*	10418.0	49.8	-3.2	46.6	74	-27.4	Peak	Vertical

Note 1: "*" means test frequency didn't fall into restricted band.

Note 2: Measure Level (dB μ V/m) = Reading Level (dB μ V) + Factor (dB)

Factor (dB) = Cable Loss (dB) + Antenna Factor (dB/m) - Pre_Amplifier Gain (dB)

Test Site	SIP-AC3	Test Engineer	Allen Zou
Test Date	2020/11/21	Test Frequency	2404MHz
Test Mode	Half BW, Ant 0		
Remark	1. Average measurement was not performed if peak level lower than average limit. 2. Other frequency was 20dB below limit line within 1-18GHz, there is not show in the report.		

Mark	Frequency (MHz)	Reading Level (dBμV)	Factor (dB)	Measure Level (dBμV/m)	Limit (dBμV/m)	Margin (dB)	Detector	Polarization
*	9619.0	50.4	-3.6	46.8	74	-27.2	Peak	Horizontal
*	10341.5	50.7	-3.2	47.5	74	-26.5	Peak	Horizontal
	11055.5	50.1	-3.5	46.6	74	-27.4	Peak	Horizontal
	11888.5	50.4	-3.6	46.8	74	-27.2	Peak	Horizontal
*	9619.0	54.7	-3.6	51.1	74	-22.9	Peak	Vertical
*	9882.5	49.9	-3.2	46.7	74	-27.3	Peak	Vertical
	10885.5	50.0	-3.5	46.5	74	-27.5	Peak	Vertical
	11659.0	50.2	-3.2	47.0	74	-27.0	Peak	Vertical

Note 1: "*" means test frequency didn't fall into restricted band.

Note 2: Measure Level (dBμV/m) = Reading Level (dBμV) + Factor (dB)

Factor (dB) = Cable Loss (dB) + Antenna Factor (dB/m) - Pre_Amplifier Gain (dB)

Test Site	SIP-AC3	Test Engineer	Allen Zou
Test Date	2020/11/21	Test Frequency	2442MHz
Test Mode	Half BW, Ant 0		
Remark	1. Average measurement was not performed if peak level lower than average limit. 2. Other frequency was 20dB below limit line within 1-18GHz, there is not show in the report.		

Mark	Frequency (MHz)	Reading Level (dB μ V)	Factor (dB)	Measure Level (dB μ V/m)	Limit (dB μ V/m)	Margin (dB)	Detector	Polarization
*	9763.5	51.2	-3.4	47.8	74	-26.2	Peak	Horizontal
*	10511.5	49.7	-3.2	46.5	74	-27.5	Peak	Horizontal
	11540.0	49.3	-3.8	45.5	74	-28.5	Peak	Horizontal
	12177.5	49.4	-3.4	46.0	74	-28.0	Peak	Horizontal
	7324.0	55.7	-6.9	48.8	74	-25.2	Peak	Vertical
	7468.5	51.2	-6.6	44.6	74	-29.4	Peak	Vertical
*	9763.5	55.7	-3.4	52.3	74	-21.7	Peak	Vertical
*	10197.0	49.5	-2.9	46.6	74	-27.4	Peak	Vertical

Note 1: "*" means test frequency didn't fall into restricted band.

Note 2: Measure Level (dB μ V/m) = Reading Level (dB μ V) + Factor (dB)

Factor (dB) = Cable Loss (dB) + Antenna Factor (dB/m) - Pre_Amplifier Gain (dB)

Test Site	SIP-AC3	Test Engineer	Allen Zou
Test Date	2020/11/21	Test Frequency	2478MHz
Test Mode	Half BW, Ant 0		
Remark	1. Average measurement was not performed if peak level lower than average limit. 2. Other frequency was 20dB below limit line within 1-18GHz, there is not show in the report.		

Mark	Frequency (MHz)	Reading Level (dBμV)	Factor (dB)	Measure Level (dBμV/m)	Limit (dBμV/m)	Margin (dB)	Detector	Polarization
	11463.5	50.3	-4.0	46.3	74	-27.7	Peak	Horizontal
	12594.0	49.3	-2.7	46.6	74	-27.4	Peak	Horizontal
*	13818.0	48.4	0.2	48.6	74	-25.4	Peak	Horizontal
*	14073.0	48.8	1.0	49.8	74	-24.2	Peak	Horizontal
	7434.5	57.3	-6.7	50.6	74	-23.4	Peak	Vertical
	7689.5	50.2	-6.1	44.1	74	-29.9	Peak	Vertical
*	9908.0	54.6	-3.5	51.1	74	-22.9	Peak	Vertical
*	10409.5	49.2	-3.0	46.2	74	-27.8	Peak	Vertical

Note 1: "*" means test frequency didn't fall into restricted band.

Note 2: Measure Level (dBμV/m) = Reading Level (dBμV) + Factor (dB)

Factor (dB) = Cable Loss (dB) + Antenna Factor (dB/m) - Pre_Amplifier Gain (dB)

The Result of Radiated Emission below 1GHz:

Site: SIP-AC3	Time: 2021/04/07
Limit: FCC_Part15.209_RE(3m)	Engineer: White Wang
Probe: SIP-AC3_VULB 9168 _30-1000MHz	Polarity: Horizontal
EUT: Wireless Portable Receiver	Power: AC 120V/60Hz
Test Mode: Transmit by Full mode bandwidth at channel 2442MHz at Ant 0	

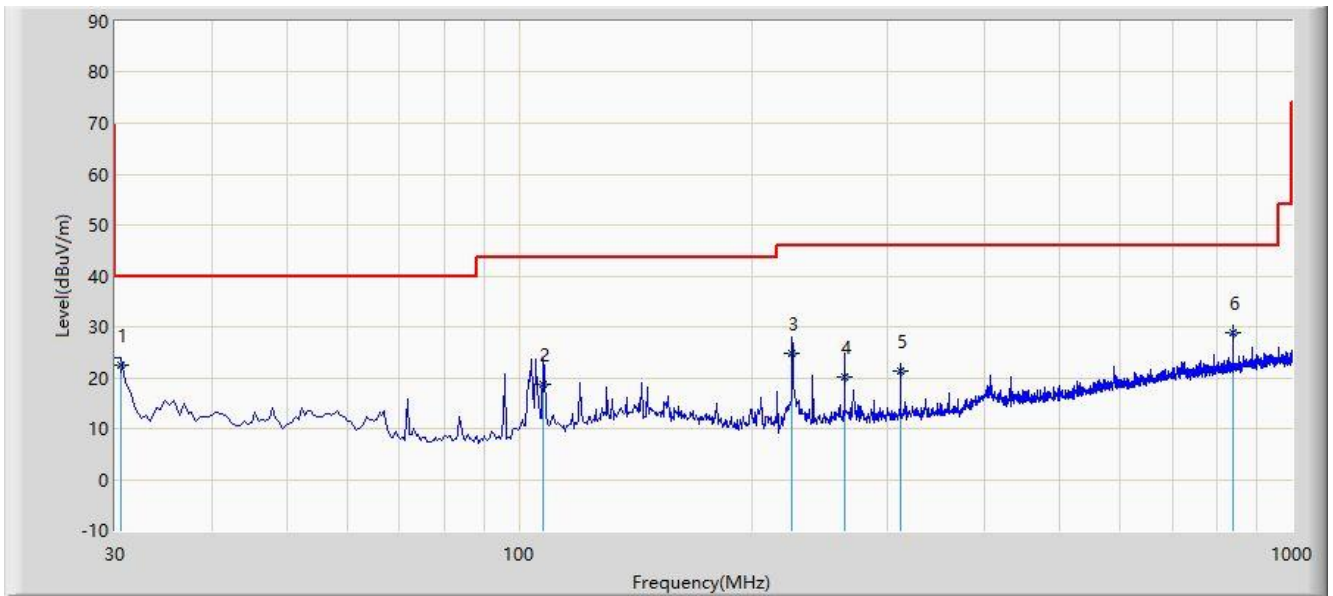

No	Flag	Mark	Frequency (MHz)	Measure Level (dBuV/m)	Reading Level (dBuV)	Margin (dB)	Limit (dBuV/m)	Factor (dB)	Type
1			30.485	22.389	5.700	-17.611	40.000	16.689	QP
2			107.600	18.819	4.200	-24.681	43.500	14.619	QP
3			225.455	24.892	10.300	-21.108	46.000	14.592	QP
4			263.770	20.223	3.100	-25.777	46.000	17.123	QP
5			311.785	21.429	2.600	-24.571	46.000	18.828	QP
6		*	839.950	28.857	0.500	-17.143	46.000	28.357	QP

Note 1: Measure Level (dB μ V/m) = Reading Level (dB μ V) + Factor (dB)

Factor (dB) = Cable Loss (dB) + Antenna Factor (dB/m)

Note 2: The amplitude of radiated emissions (frequency range from 9kHz to 30MHz and 18GHz to 25GHz) is that proximity to ambient noise, which also are attenuated more than 20 dB below the permissible value.

Therefore, the data is not presented in the report.

Site: SIP-AC3	Time: 2021/04/07 - 15:04
Limit: FCC_Part15.209_RE(3m)	Engineer: White Wang
Probe: SIP-AC3_VULB 9168 _30-1000MHz	Polarity: Vertical
EUT: Wireless Portable Receiver	Power: AC 120V/60Hz
Test Mode: Transmit by Full mode bandwidth at channel 2442MHz at Ant 0	

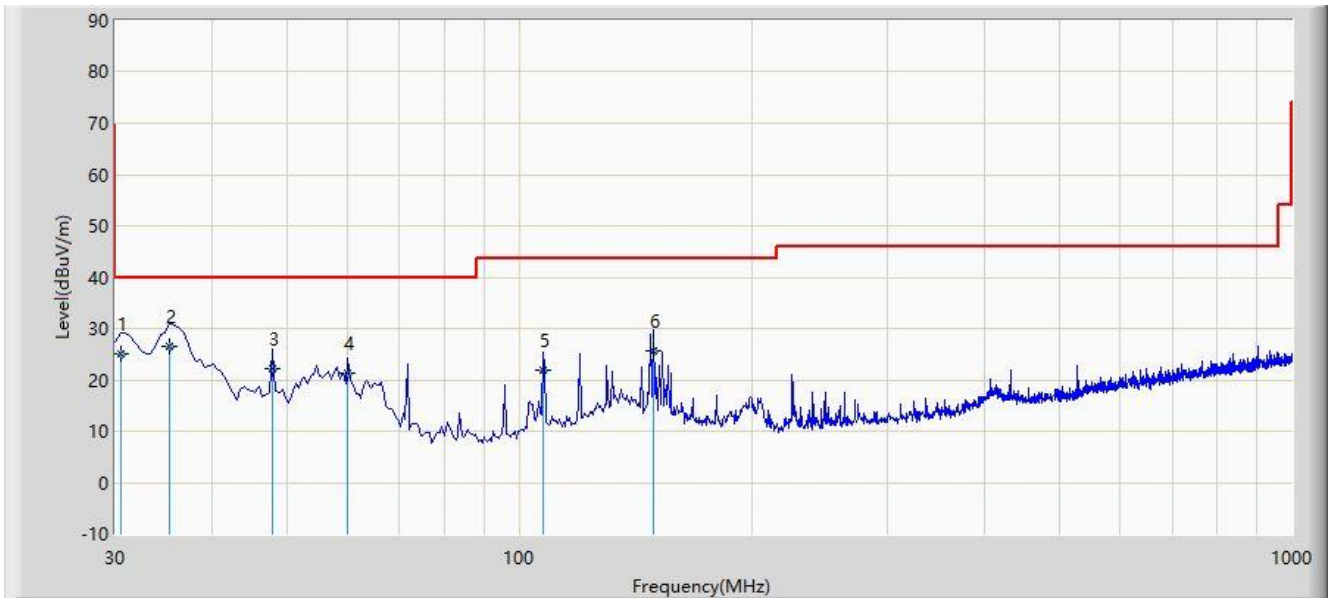

No	Flag	Mark	Frequency (MHz)	Measure Level (dBuV/m)	Reading Level (dBuV)	Margin (dB)	Limit (dBuV/m)	Factor (dB)	Type
1			30.485	25.089	8.400	-14.911	40.000	16.689	QP
2		*	35.335	26.550	9.500	-13.450	40.000	17.051	QP
3			47.945	22.288	4.300	-17.712	40.000	17.988	QP
4			60.070	21.336	4.100	-18.664	40.000	17.236	QP
5			107.600	21.919	7.300	-21.581	43.500	14.619	QP
6			149.310	25.653	7.500	-17.847	43.500	18.153	QP

Note 1: Measure Level (dB μ V/m) = Reading Level (dB μ V) + Factor (dB)

Factor (dB) = Cable Loss (dB) + Antenna Factor (dB/m)

Note 2: The amplitude of radiated emissions (frequency range from 9kHz to 30MHz and 18GHz to 25GHz) is that proximity to ambient noise, which also are attenuated more than 20 dB below the permissible value.

Therefore, the data is not presented in the report.

6.7. Radiated Restricted Band Edge Measurement

6.7.1. Test Limit

For 15.205 requirement:

Radiated emissions which fall in the restricted bands, as defined in Section 15.205(a) of FCC part 15, must also comply with the radiated emission limits specified in Section 15.209(a).

Frequency (MHz)	Frequency (MHz)	Frequency (MHz)	Frequency (GHz)
0.090 - 0.110	16.42 - 16.423	399.9 - 410	4.5 - 5.15
¹ 0.495 - 0.505	16.69475 - 16.69525	608 - 614	5.35 - 5.46
2.1735 - 2.1905	16.80425 - 16.80475	960 - 1240	7.25 - 7.75
4.125 - 4.128	25.5 - 25.67	1300 - 1427	8.025 - 8.5
4.17725 - 4.17775	37.5 - 38.25	1435 - 1626.5	9.0 - 9.2
4.20725 - 4.20775	73 - 74.6	1645.5 - 1646.5	9.3 - 9.5
6.215 - 6.218	74.8 - 75.2	1660 - 1710	10.6 - 12.7
6.26775 - 6.26825	108 - 121.94	1718.8 - 1722.2	13.25 - 13.4
6.31175 - 6.31225	123 - 138	2200 - 2300	14.47 - 14.5
8.291 - 8.294	149.9 - 150.05	2310 - 2390	15.35 - 16.2
8.362 - 8.366	156.52475 - 156.52525	2483.5 - 2500	17.7 - 21.4
8.37625 - 8.38675	156.7 - 156.9	2690 - 2900	22.01 - 23.12
8.41425 - 8.41475	162.0125 - 167.17	3260 - 3267	23.6 - 24.0
12.29 - 12.293	167.72 - 173.2	3332 - 3339	31.2 - 31.8
12.51975 - 12.52025	240 - 285	3345.8 - 3358	36.43 - 36.5
12.57675 - 12.57725	322 - 335.4	3600 - 4400	(²)
13.36 - 13.41	--	--	--

All out of band emissions appearing in a restricted band as specified in Section 15.205 of the Title 47CFR must not exceed the limits shown in Table per Section 15.209.

FCC Part 15 Subpart C Paragraph 15.209		
Frequency [MHz]	Field Strength [uV/m]	Measured Distance [Meters]
0.009 - 0.490	2400/F (kHz)	300
0.490 - 1.705	24000/F (kHz)	30
1.705 - 30	30	30
30 - 88	100	3
88 - 216	150	3
216 - 960	200	3
Above 960	500	3

6.7.2. Test Procedure Used

ANSI C63.10-2013 Section 6.3

ANSI C63.10-2013 Section 6.6

ANSI C63.10-2013 Section 11.13

6.7.3. Test Setting

Peak Field Strength Measurements

1. Analyzer center frequency was set to the frequency of the radiated spurious emission of interest
2. RBW = 1MHz
3. VBW = 3MHz
4. Detector = peak
5. Sweep time = auto couple
6. Trace mode = max hold
7. Trace was allowed to stabilize

Average Field Strength Measurements

1. Analyzer center frequency was set to the frequency of the radiated spurious emission of interest
2. RBW = 1MHz
3. VBW $\geq 1/T$
4. As an alternative, the instrument may be set to linear detector mode. Ensure that video filtering is applied in linear voltage domain (rather than in a log or dB domain). Some instruments require linear display mode in order to accomplish this. Others have a setting for Average-VBW Type, which can be set to "Voltage" regardless of the display mode
5. Detector = Peak
6. Sweep time = auto
7. Trace mode = max hold
8. Allow max hold to run for at least 50 times (1/duty cycle) traces

6.7.4. Test Setup

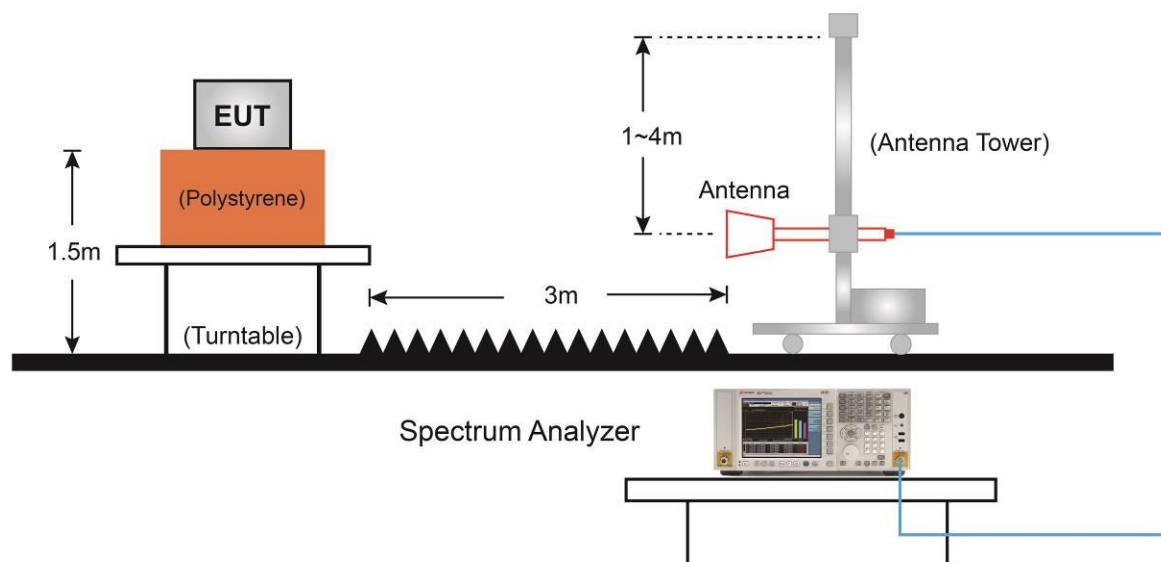

6.7.5. Test Result

Site: SIP-AC2	Time: 2021/03/16 - 17:16
Limit: FCC_Part15_15.209 RE(3m)	Engineer: Allen Zou
Probe: SIP-AC2_BBHA9120D_1-18GHz	Polarity: Horizontal
EUT: Wireless Portable Receiver	Power: AC 120V/60Hz
Test Mode: Transmit by Full BW at channel 2404MHz at Ant 0	

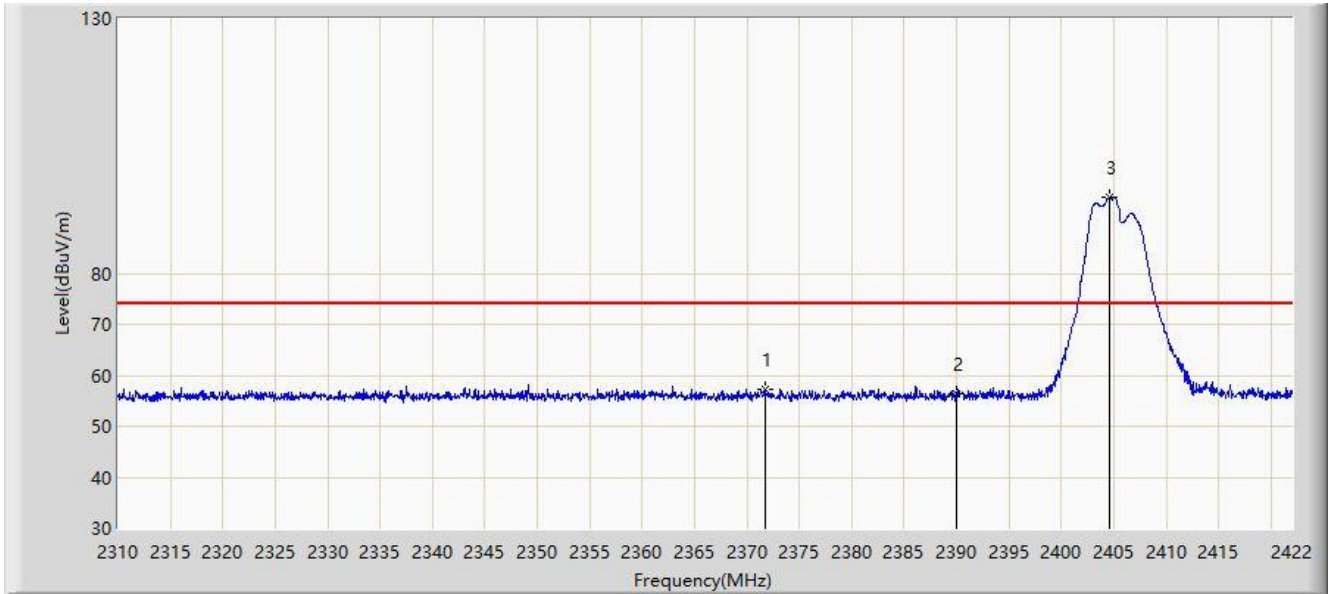

No	Flag	Mark	Frequency (MHz)	Measure Level (dBuV/m)	Reading Level (dBuV)	Margin (dB)	Limit (dBuV/m)	Factor (dB)	Type
1			2371.712	57.212	25.826	-16.788	74.000	31.386	PK
2			2390.000	56.396	25.060	-17.604	74.000	31.336	PK
3		*	2404.528	94.789	63.484	NA	NA	31.305	PK

Note: Measure Level (dB μ V/m) = Reading Level (dB μ V) + Factor (dB)

Factor (dB) = Cable Loss (dB) + Antenna Factor (dB/m).

Site: SIP-AC2	Time: 2021/03/16 - 17:23
Limit: FCC_Part15_15.209 RE(3m)	Engineer: Allen Zou
Probe: SIP-AC2_BBHA9120D_1-18GHz	Polarity: Horizontal
EUT: Wireless Portable Receiver	Power: AC 120V/60Hz
Test Mode: Transmit by Full BW at channel 2404MHz at Ant 0	

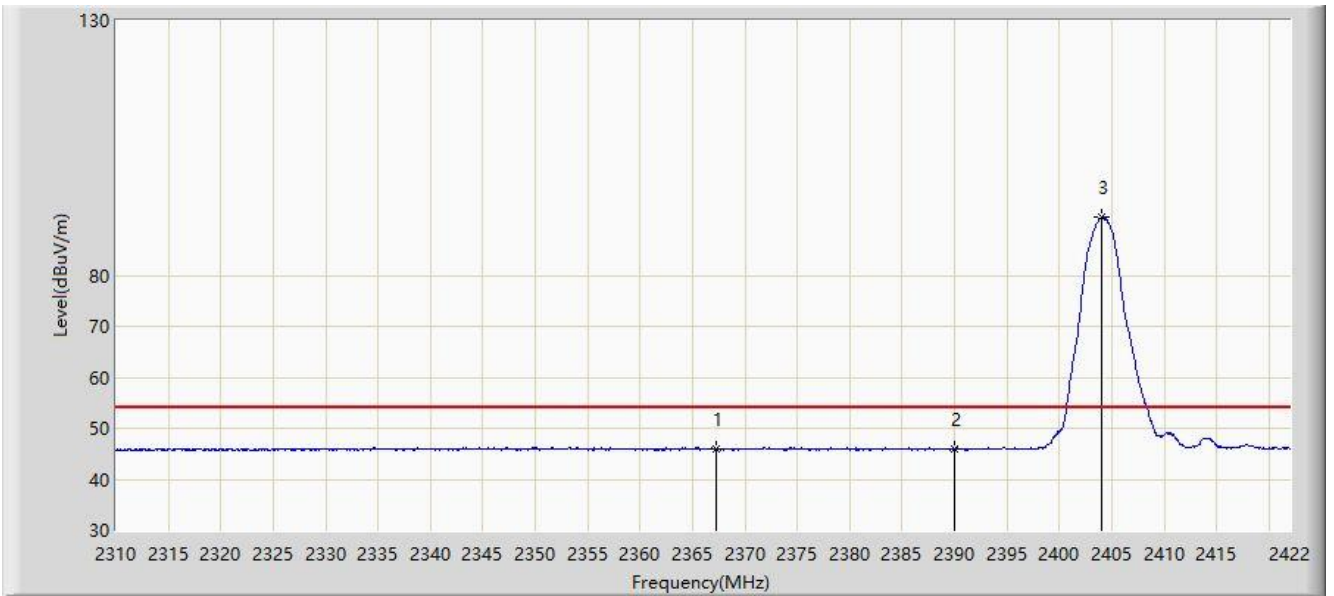

No	Flag	Mark	Frequency (MHz)	Measure Level (dBuV/m)	Reading Level (dBuV)	Margin (dB)	Limit (dBuV/m)	Factor (dB)	Type
1			2367.232	46.000	14.600	-8.000	54.000	31.400	AV
2			2390.000	45.872	14.536	-8.128	54.000	31.336	AV
3		*	2403.968	91.415	60.109	NA	NA	31.306	AV

Note: Measure Level (dB μ V/m) = Reading Level (dB μ V) + Factor (dB)

Factor (dB) = Cable Loss (dB) + Antenna Factor (dB/m).

Site: SIP-AC2	Time: 2021/03/16 - 17:26
Limit: FCC_Part15_15.209 RE(3m)	Engineer: Allen Zou
Probe: SIP-AC2_BBHA9120D_1-18GHz	Polarity: Vertical
EUT: Wireless Portable Receiver	Power: AC 120V/60Hz
Test Mode: Transmit by Full BW at channel 2404MHz at Ant 0	

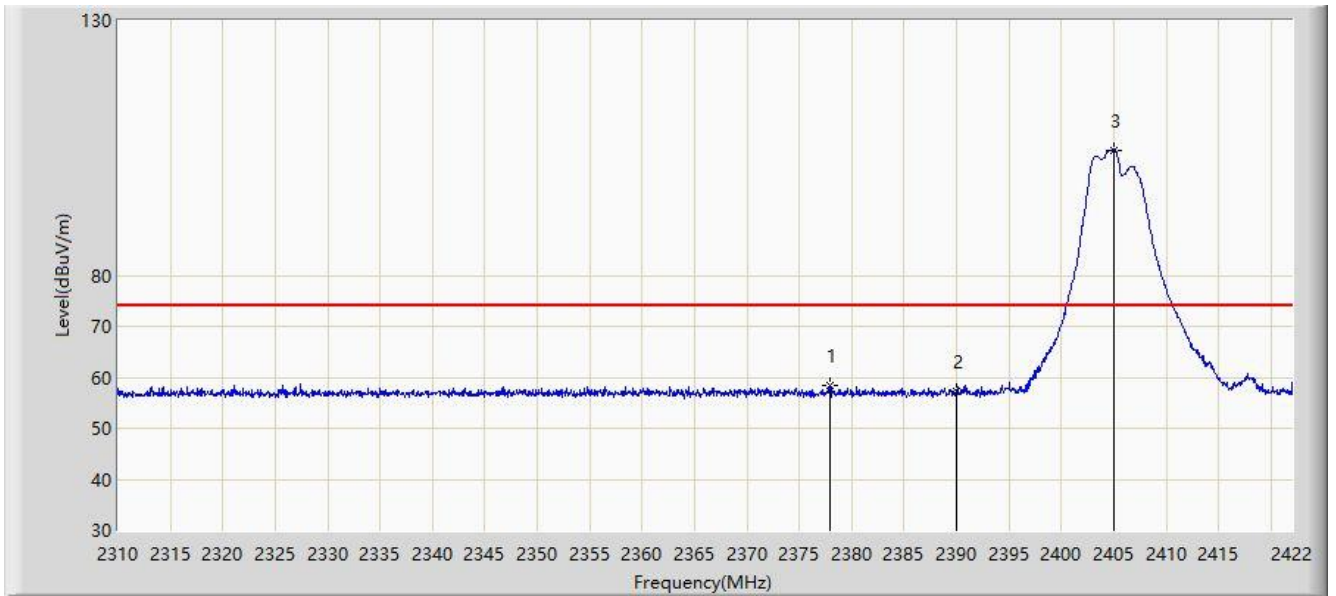

No	Flag	Mark	Frequency (MHz)	Measure Level (dBuV/m)	Reading Level (dBuV)	Margin (dB)	Limit (dBuV/m)	Factor (dB)	Type
1			2377.984	58.329	26.962	-15.671	74.000	31.367	PK
2			2390.000	57.235	25.899	-16.765	74.000	31.336	PK
3		*	2405.032	104.599	73.295	NA	NA	31.304	PK

Note: Measure Level (dB μ V/m) = Reading Level (dB μ V) + Factor (dB)

Factor (dB) = Cable Loss (dB) + Antenna Factor (dB/m).

Site: SIP-AC2	Time: 2021/03/16 - 17:32
Limit: FCC_Part15_15.209 RE(3m)	Engineer: Allen Zou
Probe: SIP-AC2_BBHA9120D_1-18GHz	Polarity: Vertical
EUT: Wireless Portable Receiver	Power: AC 120V/60Hz
Test Mode: Transmit by Full BW at channel 2404MHz at Ant 0	

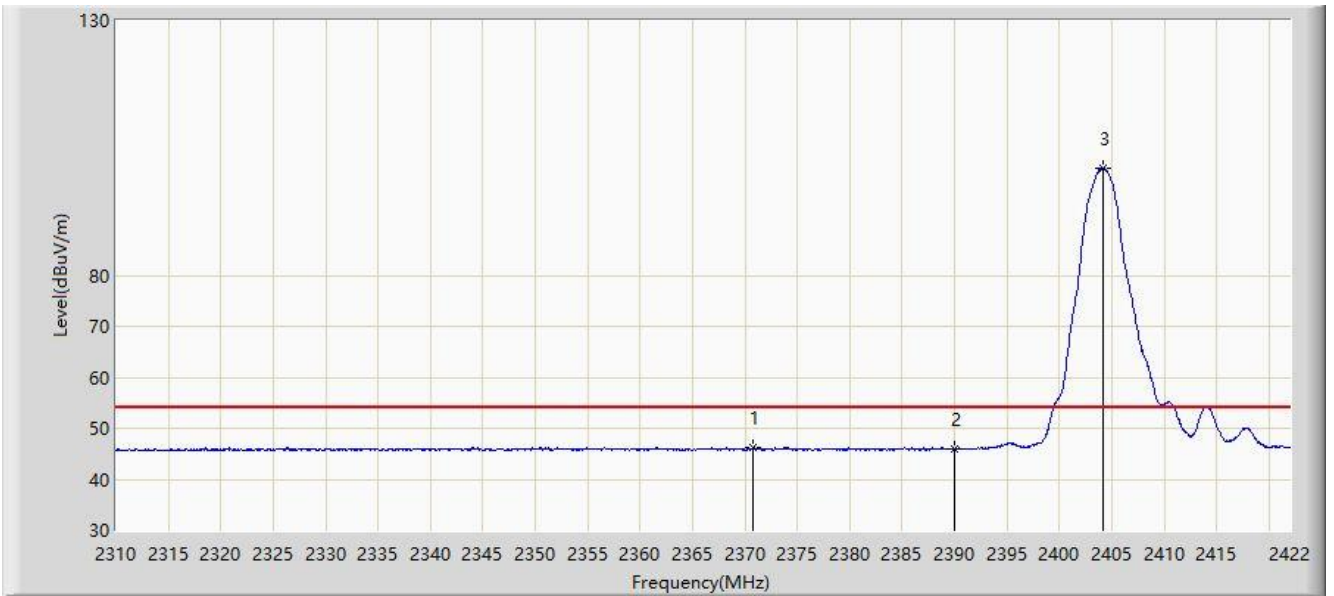

No	Flag	Mark	Frequency (MHz)	Measure Level (dBuV/m)	Reading Level (dBuV)	Margin (dB)	Limit (dBuV/m)	Factor (dB)	Type
1			2370.816	46.313	14.924	-7.687	54.000	31.388	AV
2			2390.000	46.055	14.719	-7.945	54.000	31.336	AV
3		*	2404.192	101.129	69.823	NA	NA	31.306	AV

Note: Measure Level (dB μ V/m) = Reading Level (dB μ V) + Factor (dB)

Factor (dB) = Cable Loss (dB) + Antenna Factor (dB/m).

Site: SIP-AC2	Time: 2021/03/16 - 17:43
Limit: FCC_Part15_15.209 RE(3m)	Engineer: Allen Zou
Probe: SIP-AC2_BBHA9120D_1-18GHz	Polarity: Horizontal
EUT: Wireless Portable Receiver	Power: AC 120V/60Hz
Test Mode: Transmit by Full BW at channel 2478MHz at Ant 0	

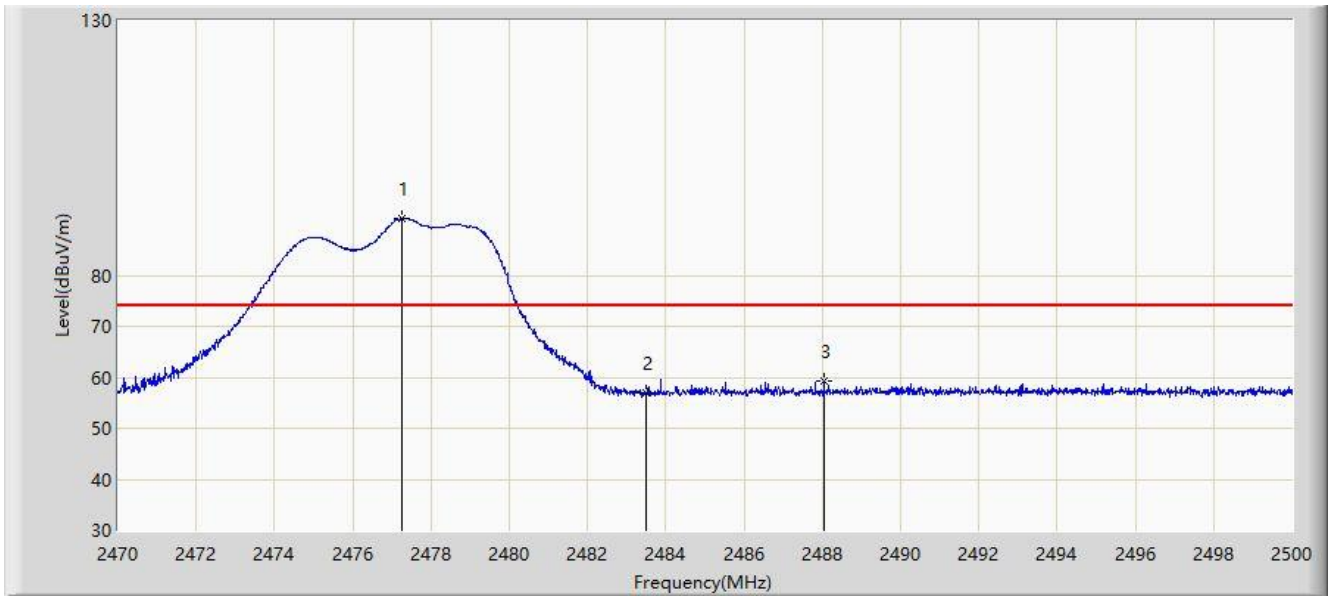

No	Flag	Mark	Frequency (MHz)	Measure Level (dBuV/m)	Reading Level (dBuV)	Margin (dB)	Limit (dBuV/m)	Factor (dB)	Type
1		*	2477.260	91.079	59.934	NA	NA	31.146	PK
2			2483.500	57.018	25.875	-16.982	74.000	31.143	PK
3			2488.045	59.173	28.031	-14.827	74.000	31.141	PK

Note: Measure Level (dBuV/m) = Reading Level (dBuV) + Factor (dB)

Factor (dB) = Cable Loss (dB) + Antenna Factor (dB/m).

Site: SIP-AC2	Time: 2021/03/16 - 17:46
Limit: FCC_Part15_15.209 RE(3m)	Engineer: Allen Zou
Probe: SIP-AC2_BBHA9120D_1-18GHz	Polarity: Horizontal
EUT: Wireless Portable Receiver	Power: AC 120V/60Hz
Test Mode: Transmit by Full BW at channel 2478MHz at Ant 0	

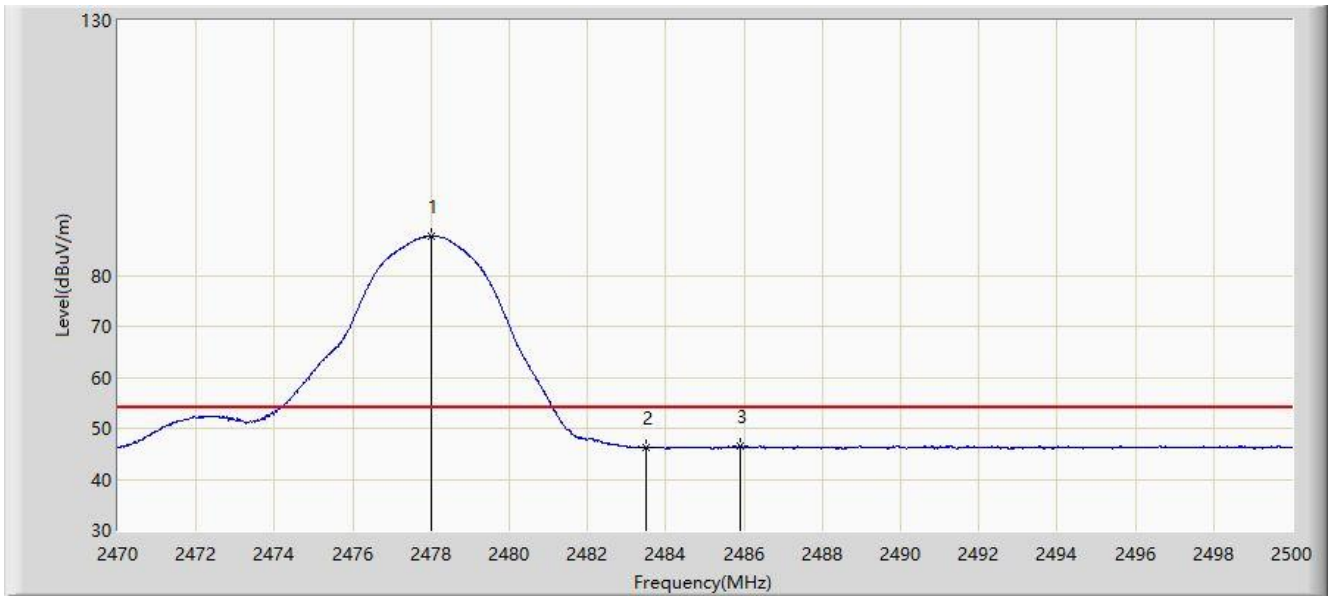

No	Flag	Mark	Frequency (MHz)	Measure Level (dBuV/m)	Reading Level (dBuV)	Margin (dB)	Limit (dBuV/m)	Factor (dB)	Type
1		*	2478.010	87.663	56.518	NA	NA	31.145	AV
2			2483.500	46.221	15.078	-7.779	54.000	31.143	AV
3			2485.915	46.634	15.492	-7.366	54.000	31.142	AV

Note: Measure Level (dB μ V/m) = Reading Level (dB μ V) + Factor (dB)

Factor (dB) = Cable Loss (dB) + Antenna Factor (dB/m).

Site: SIP-AC2	Time: 2021/03/16 - 17:47
Limit: FCC_Part15_15.209 RE(3m)	Engineer: Allen Zou
Probe: SIP-AC2_BBHA9120D_1-18GHz	Polarity: Vertical
EUT: Wireless Portable Receiver	Power: AC 120V/60Hz
Test Mode: Transmit by Full BW at channel 2478MHz at Ant 0	

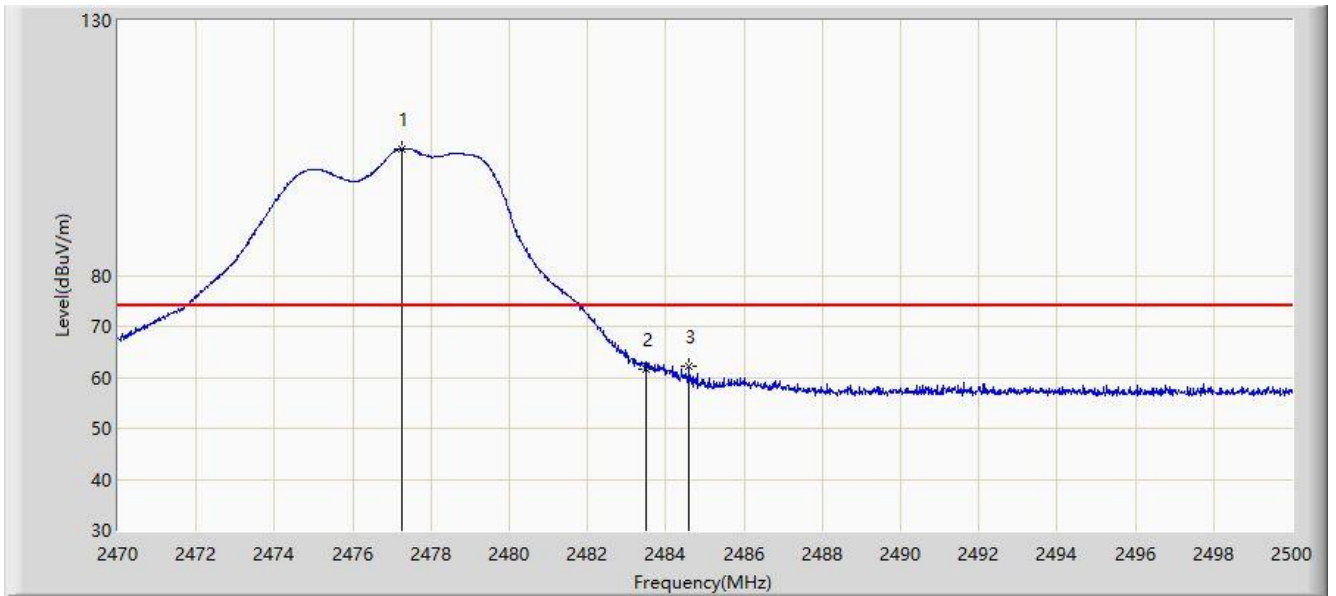

No	Flag	Mark	Frequency (MHz)	Measure Level (dBuV/m)	Reading Level (dBuV)	Margin (dB)	Limit (dBuV/m)	Factor (dB)	Type
1		*	2477.260	104.778	73.633	NA	NA	31.146	PK
2			2483.500	61.669	30.526	-12.331	74.000	31.143	PK
3			2484.595	62.178	31.035	-11.822	74.000	31.143	PK

Note: Measure Level (dB μ V/m) = Reading Level (dB μ V) + Factor (dB)

Factor (dB) = Cable Loss (dB) + Antenna Factor (dB/m).

Site: SIP-AC2	Time: 2021/03/16 - 17:49
Limit: FCC_Part15_15.209 RE(3m)	Engineer: Allen Zou
Probe: SIP-AC2_BBHA9120D_1-18GHz	Polarity: Vertical
EUT: Wireless Portable Receiver	Power: AC 120V/60Hz
Test Mode: Transmit by Full BW at channel 2478MHz at Ant 0	

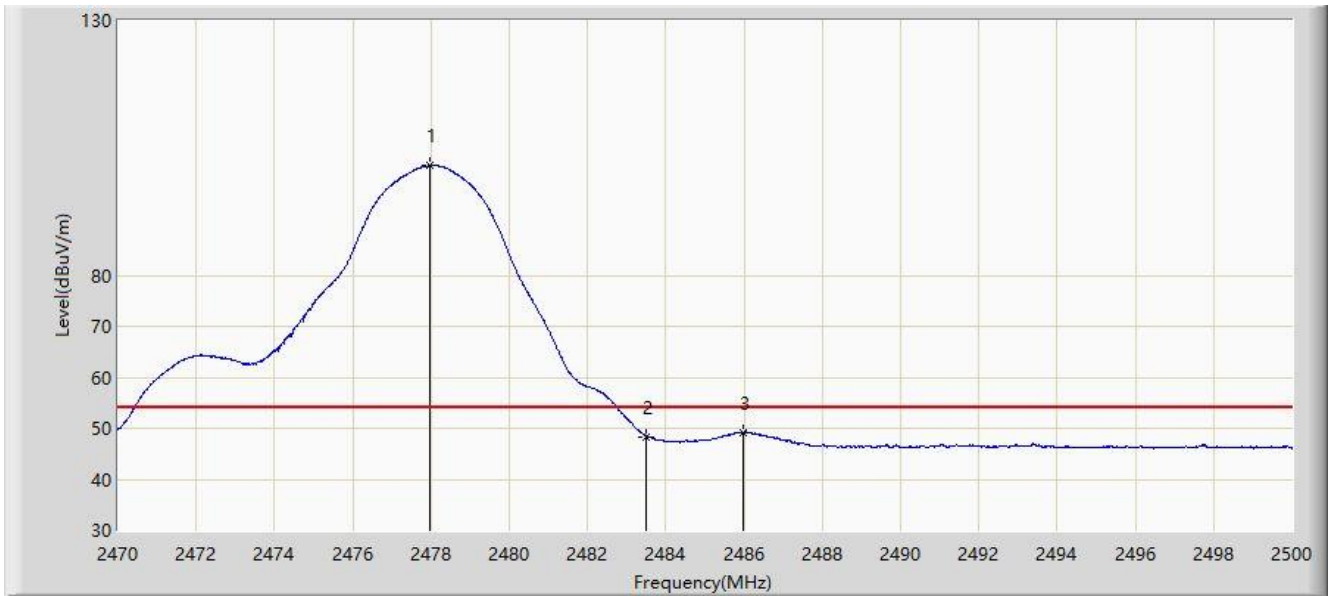

No	Flag	Mark	Frequency (MHz)	Measure Level (dBuV/m)	Reading Level (dBuV)	Margin (dB)	Limit (dBuV/m)	Factor (dB)	Type
1		*	2477.965	101.503	70.358	NA	NA	31.145	AV
2			2483.500	48.401	17.258	-5.599	54.000	31.143	AV
3			2485.990	49.114	17.972	-4.886	54.000	31.142	AV

Note: Measure Level (dB μ V/m) = Reading Level (dB μ V) + Factor (dB)

Factor (dB) = Cable Loss (dB) + Antenna Factor (dB/m).

Site: SIP-AC2	Time: 2021/03/16 - 17:51
Limit: FCC_Part15_15.209 RE(3m)	Engineer: Allen Zou
Probe: SIP-AC2_BBHA9120D_1-18GHz	Polarity: Horizontal
EUT: Wireless Portable Receiver	Power: AC 120V/60Hz
Test Mode: Transmit by Half BW at channel 2404MHz at Ant 0	

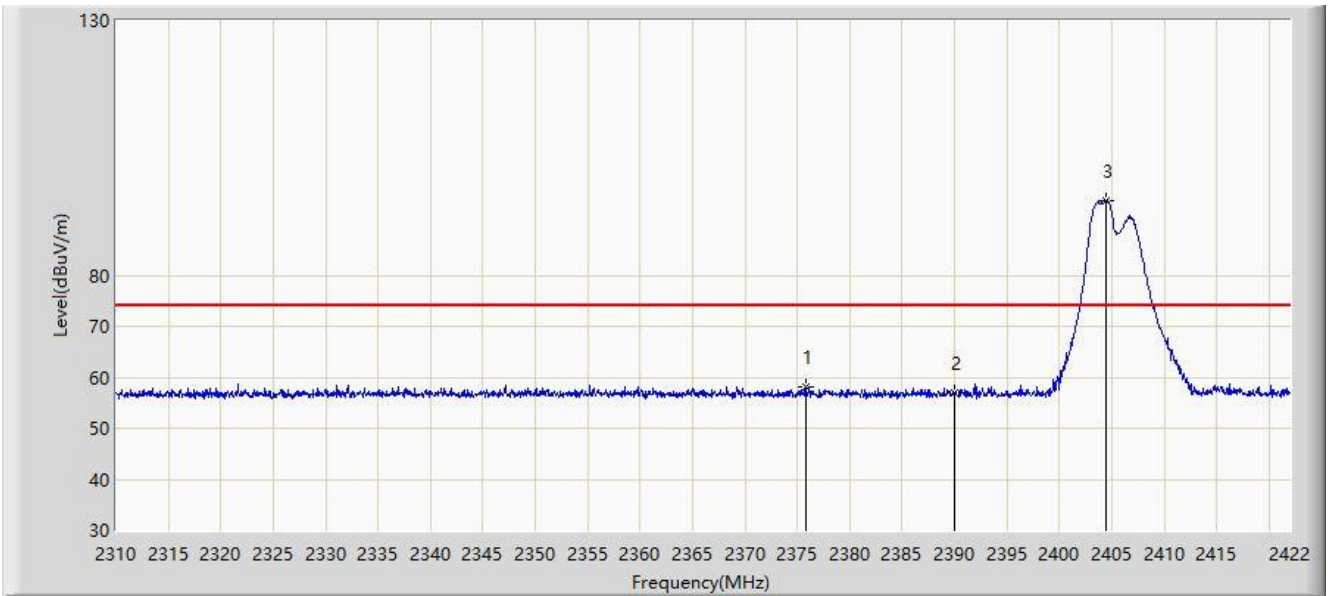

No	Flag	Mark	Frequency (MHz)	Measure Level (dBuV/m)	Reading Level (dBuV)	Margin (dB)	Limit (dBuV/m)	Factor (dB)	Type
1			2375.856	58.234	26.861	-15.766	74.000	31.373	PK
2			2390.000	56.916	25.580	-17.084	74.000	31.336	PK
3		*	2404.416	94.770	63.465	NA	NA	31.305	PK

Note: Measure Level (dBμV/m) = Reading Level (dBμV) + Factor (dB)

Factor (dB) = Cable Loss (dB) + Antenna Factor (dB/m).

Site: SIP-AC2	Time: 2021/03/16 - 17:54
Limit: FCC_Part15_15.209 RE(3m)	Engineer: Allen Zou
Probe: SIP-AC2_BBHA9120D_1-18GHz	Polarity: Horizontal
EUT: Wireless Portable Receiver	Power: AC 120V/60Hz
Test Mode: Transmit by Half BW at channel 2404MHz at Ant 0	

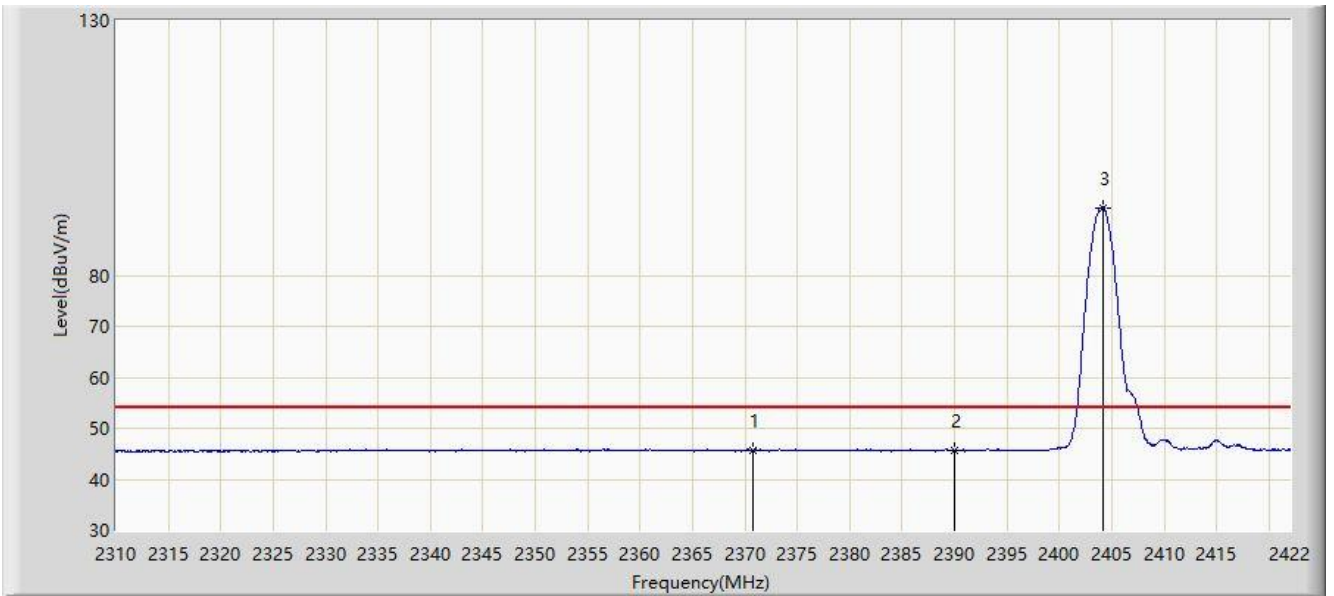

No	Flag	Mark	Frequency (MHz)	Measure Level (dBuV/m)	Reading Level (dBuV)	Margin (dB)	Limit (dBuV/m)	Factor (dB)	Type
1			2370.704	45.699	14.310	-8.301	54.000	31.389	AV
2			2390.000	45.619	14.283	-8.381	54.000	31.336	AV
3		*	2404.192	93.237	61.931	NA	NA	31.306	AV

Note: Measure Level (dB μ V/m) = Reading Level (dB μ V) + Factor (dB)

Factor (dB) = Cable Loss (dB) + Antenna Factor (dB/m).

Site: SIP-AC2	Time: 2021/03/16 - 17:57
Limit: FCC_Part15_15.209 RE(3m)	Engineer: Allen Zou
Probe: SIP-AC2_BBHA9120D_1-18GHz	Polarity: Vertical
EUT: Wireless Portable Receiver	Power: AC 120V/60Hz
Test Mode: Transmit by Half BW at channel 2404MHz at Ant 0	

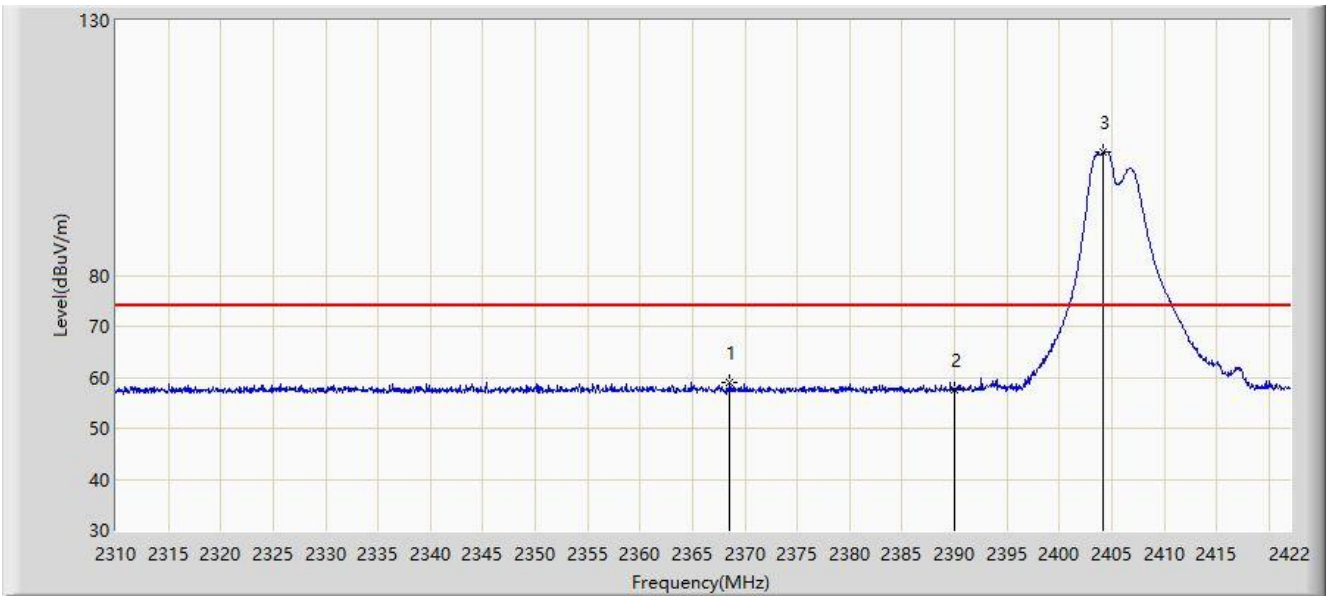

No	Flag	Mark	Frequency (MHz)	Measure Level (dBuV/m)	Reading Level (dBuV)	Margin (dB)	Limit (dBuV/m)	Factor (dB)	Type
1			2368.520	58.941	27.545	-15.059	74.000	31.395	PK
2			2390.000	57.679	26.343	-16.321	74.000	31.336	PK
3		*	2404.136	104.197	72.891	NA	NA	31.306	PK

Note: Measure Level (dB μ V/m) = Reading Level (dB μ V) + Factor (dB)

Factor (dB) = Cable Loss (dB) + Antenna Factor (dB/m).

Site: SIP-AC2	Time: 2021/03/16 - 18:24
Limit: FCC_Part15_15.209 RE(3m)	Engineer: Allen Zou
Probe: SIP-AC2_BBHA9120D_1-18GHz	Polarity: Vertical
EUT: Wireless Portable Receiver	Power: AC 120V/60Hz
Test Mode: Transmit by Half BW at channel 2404MHz at Ant 0	

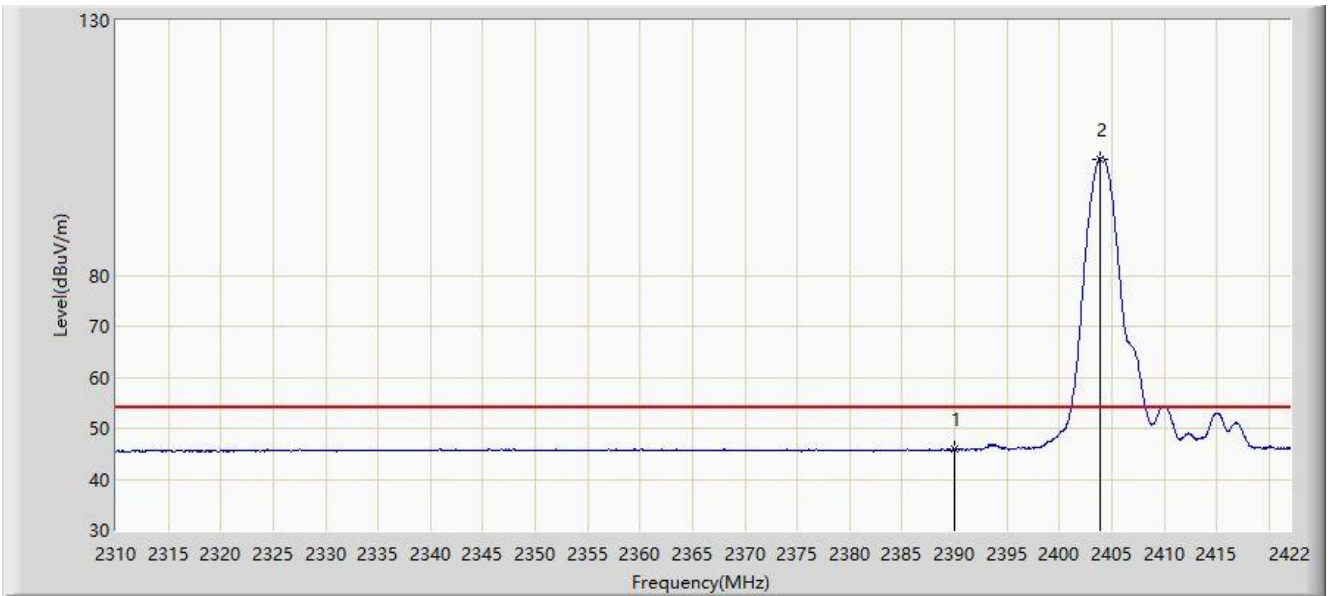

No	Flag	Mark	Frequency (MHz)	Measure Level (dBuV/m)	Reading Level (dBuV)	Margin (dB)	Limit (dBuV/m)	Factor (dB)	Type
1			2390.000	45.879	14.543	-8.121	54.000	31.336	AV
2		*	2403.856	102.849	71.543	NA	NA	31.307	AV

Note: Measure Level (dBμV/m) = Reading Level (dBμV) + Factor (dB)

Factor (dB) = Cable Loss (dB) + Antenna Factor (dB/m).

Site: SIP-AC2	Time: 2021/03/16 - 18:38
Limit: FCC_Part15_15.209 RE(3m)	Engineer: Allen Zou
Probe: SIP-AC2_BBHA9120D_1-18GHz	Polarity: Horizontal
EUT: Wireless Portable Receiver	Power: AC 120V/60Hz
Test Mode: Transmit by Half BW at channel 2478MHz at Ant 0	

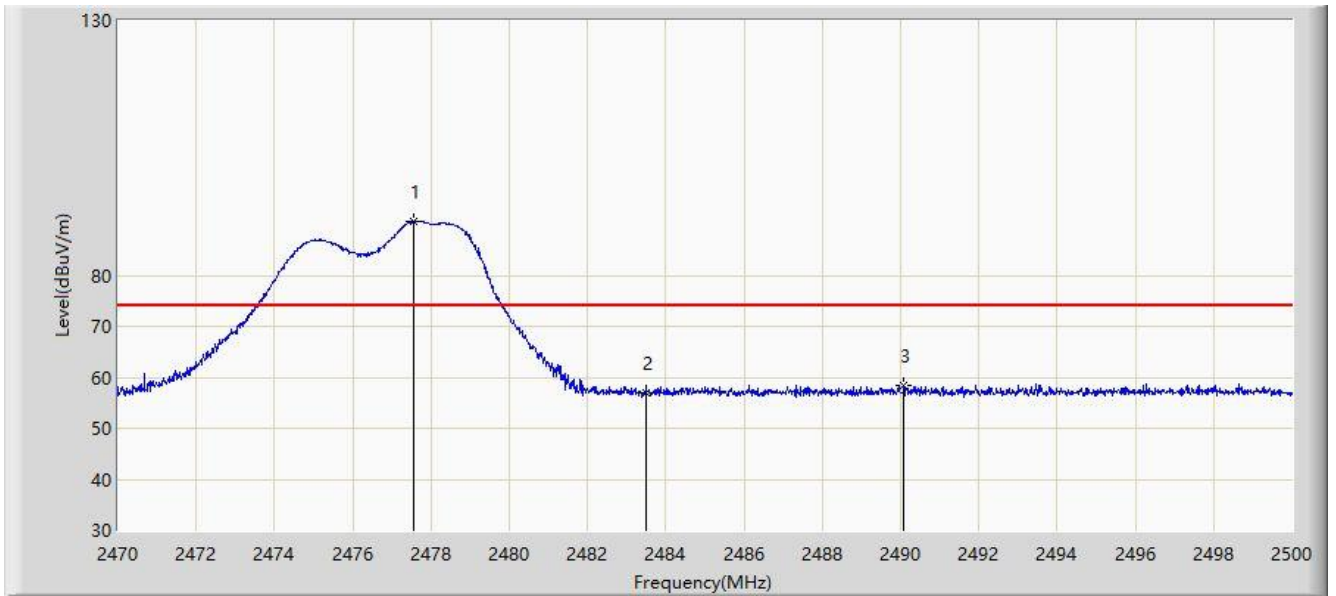

No	Flag	Mark	Frequency (MHz)	Measure Level (dBuV/m)	Reading Level (dBuV)	Margin (dB)	Limit (dBuV/m)	Factor (dB)	Type
1		*	2477.545	90.572	59.427	NA	NA	31.145	PK
2			2483.500	57.089	25.946	-16.911	74.000	31.143	PK
3			2490.085	58.442	27.301	-15.558	74.000	31.142	PK

Note: Measure Level (dB μ V/m) = Reading Level (dB μ V) + Factor (dB)

Factor (dB) = Cable Loss (dB) + Antenna Factor (dB/m).

Site: SIP-AC2	Time: 2021/03/16 - 18:41
Limit: FCC_Part15_15.209 RE(3m)	Engineer: Allen Zou
Probe: SIP-AC2_BBHA9120D_1-18GHz	Polarity: Horizontal
EUT: Wireless Portable Receiver	Power: AC 120V/60Hz
Test Mode: Transmit by Half BW at channel 2478MHz at Ant 0	

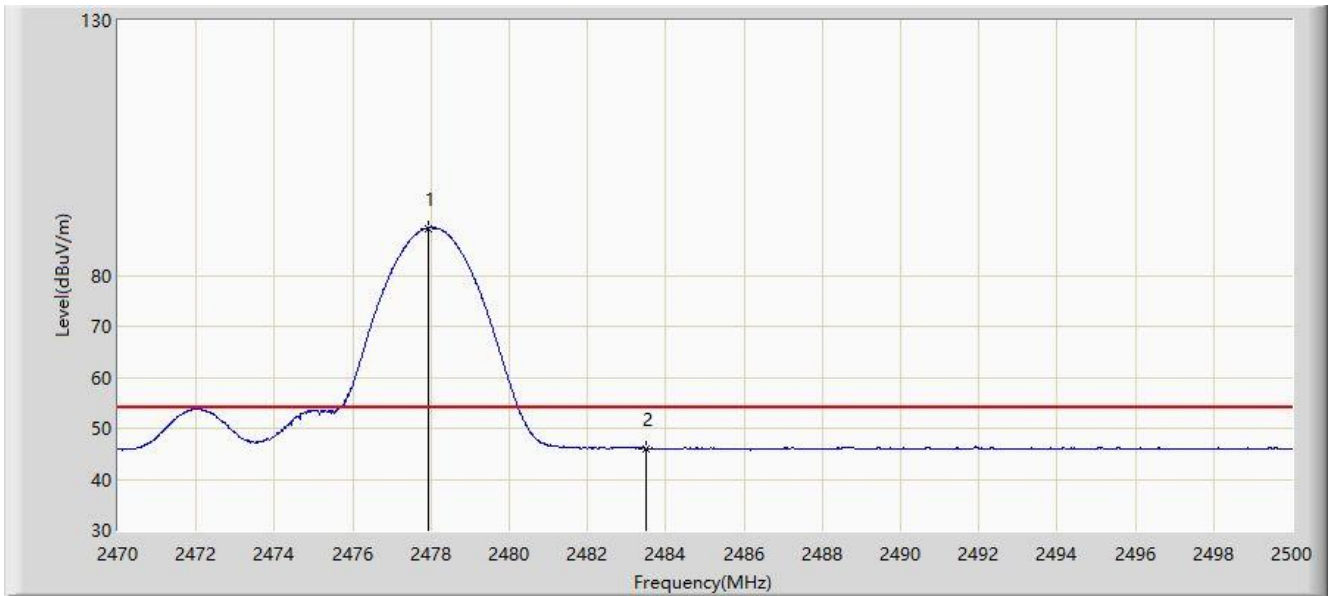

No	Flag	Mark	Frequency (MHz)	Measure Level (dBuV/m)	Reading Level (dBuV)	Margin (dB)	Limit (dBuV/m)	Factor (dB)	Type
1		*	2477.920	89.273	58.128	NA	NA	31.145	AV
2			2483.500	46.037	14.894	-7.963	54.000	31.143	AV

Note: Measure Level (dB μ V/m) = Reading Level (dB μ V) + Factor (dB)

Factor (dB) = Cable Loss (dB) + Antenna Factor (dB/m).

Site: SIP-AC2	Time: 2021/03/16 - 18:42
Limit: FCC_Part15_15.209 RE(3m)	Engineer: Allen Zou
Probe: SIP-AC2_BBHA9120D_1-18GHz	Polarity: Vertical
EUT: Wireless Portable Receiver	Power: AC 120V/60Hz
Test Mode: Transmit by Half BW at channel 2478MHz at Ant 0	

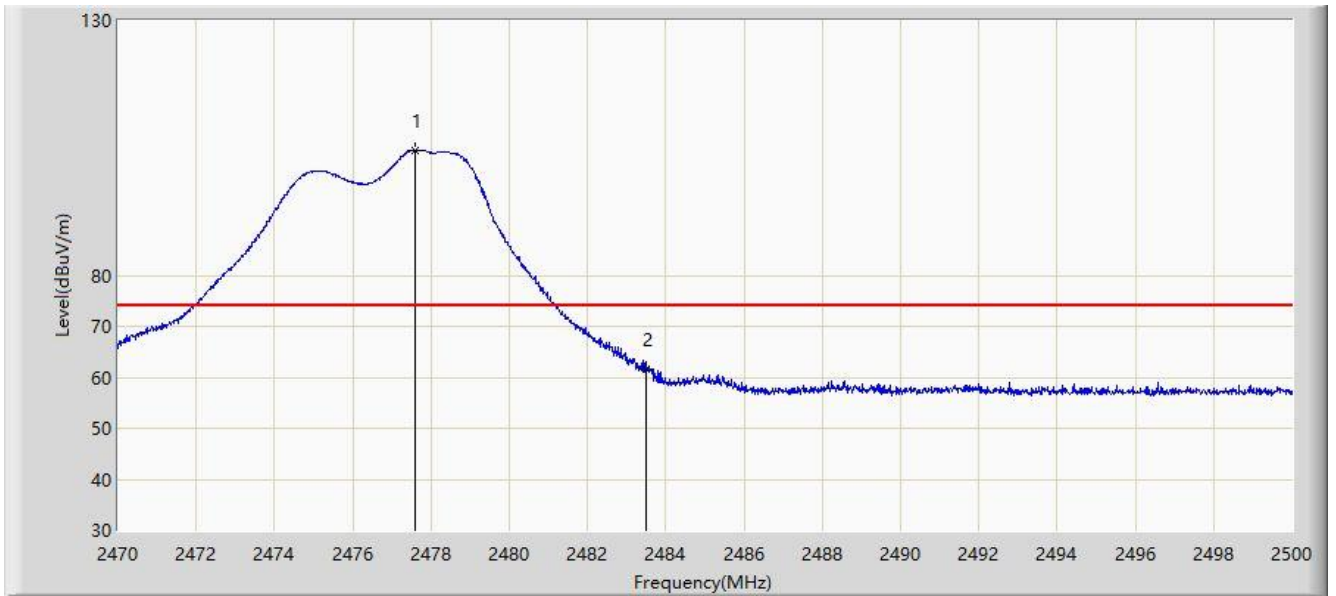

No	Flag	Mark	Frequency (MHz)	Measure Level (dBuV/m)	Reading Level (dBuV)	Margin (dB)	Limit (dBuV/m)	Factor (dB)	Type
1		*	2477.590	104.581	73.436	NA	NA	31.145	PK
2			2483.500	61.630	30.487	-12.370	74.000	31.143	PK

Note: Measure Level (dBuV/m) = Reading Level (dBuV) + Factor (dB)

Factor (dB) = Cable Loss (dB) + Antenna Factor (dB/m).

Site: SIP-AC2	Time: 2021/03/16 - 18:45
Limit: FCC_Part15_15.209 RE(3m)	Engineer: Allen Zou
Probe: SIP-AC2_BBHA9120D_1-18GHz	Polarity: Vertical
EUT: Wireless Portable Receiver	Power: AC 120V/60Hz
Test Mode: Transmit by Half BW at channel 2478MHz at Ant 0	

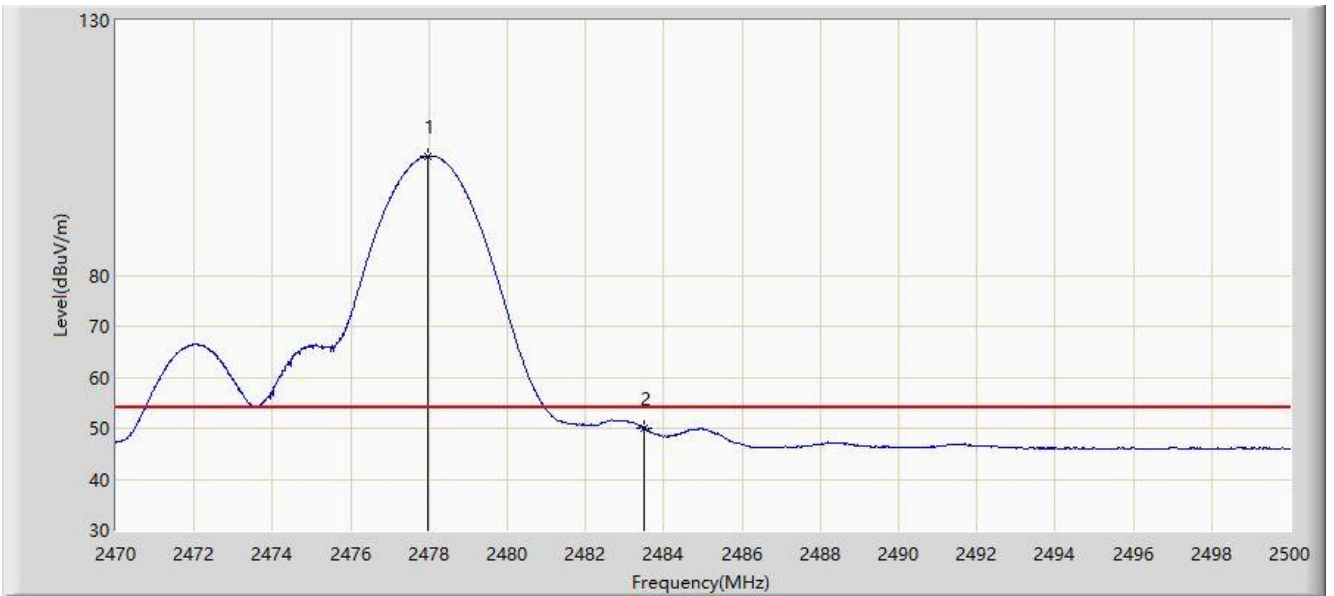

No	Flag	Mark	Frequency (MHz)	Measure Level (dBuV/m)	Reading Level (dBuV)	Margin (dB)	Limit (dBuV/m)	Factor (dB)	Type
1		*	2477.965	103.383	72.238	NA	NA	31.145	AV
2			2483.500	50.040	18.897	-3.960	54.000	31.143	AV

Note: Measure Level (dB μ V/m) = Reading Level (dB μ V) + Factor (dB)

Factor (dB) = Cable Loss (dB) + Antenna Factor (dB/m).

6.8. AC Conducted Emissions Measurement

6.8.1. Test Limit

FCC Part 15 Subpart C Paragraph 15.207 Limits		
Frequency (MHz)	QP (dBuV)	AV (dBuV)
0.15 - 0.50	66 - 56	56 - 46
0.50 - 5.0	56	46
5.0 - 30	60	50

Note 1: The lower limit shall apply at the transition frequencies.

Note 2: The limit decreases linearly with the logarithm of the frequency in the range 0.15MHz to 0.5MHz.

6.8.2. Test Setup

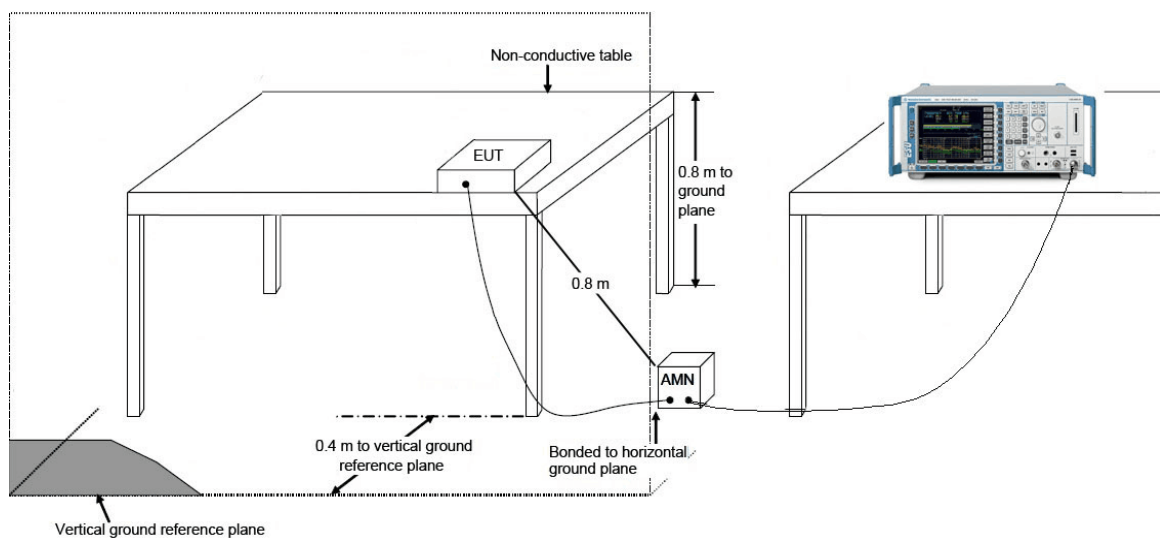

6.8.3. Test Result

Site: SIP-SR2	Time: 2021/04/07
Limit: FCC_Part15.207_CE_AC Power	Engineer: Rupert Wang
Probe: SIP-SR2-ENV216_101684_With Connect	Polarity: Line
EUT: Wireless Portable Receiver	Power: AC 120V/60Hz
Test Mode: Transmit by Full BW at channel 2442MHz at Ant 0	

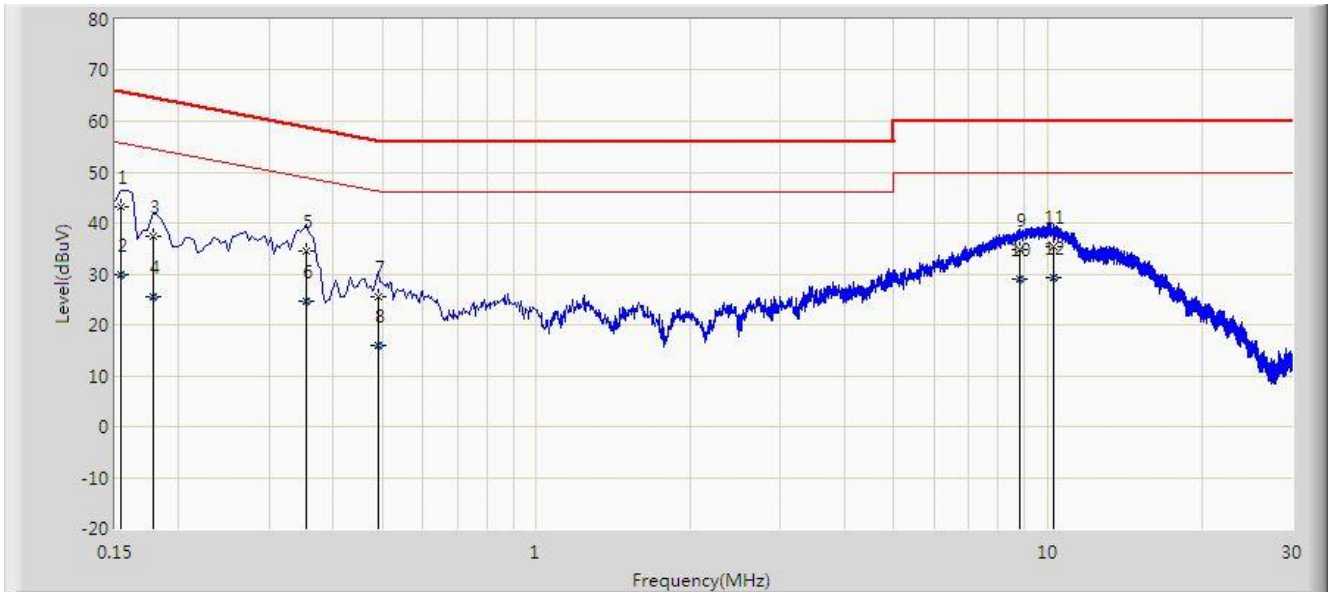

No	Flag	Mark	Frequency (MHz)	Measure Level (dBuV)	Reading Level (dBuV)	Margin (dB)	Limit (dBuV)	Factor (dB)	Type
1			0.154	43.310	33.859	-22.471	65.781	9.452	QP
2			0.154	29.932	20.480	-25.849	55.781	9.452	AV
3			0.178	37.337	27.882	-27.241	64.578	9.456	QP
4			0.178	25.555	16.099	-29.024	54.578	9.456	AV
5			0.354	34.421	24.879	-24.447	58.868	9.542	QP
6			0.354	24.685	15.143	-24.183	48.868	9.542	AV
7			0.490	25.437	15.878	-30.731	56.168	9.559	QP
8			0.490	15.862	6.303	-30.306	46.168	9.559	AV
9			8.834	34.835	24.877	-25.165	60.000	9.958	QP
10			8.834	28.926	18.967	-21.074	50.000	9.958	AV
11			10.242	35.504	25.480	-24.496	60.000	10.024	QP
12		*	10.242	29.236	19.212	-20.764	50.000	10.024	AV

Note: Measure Level (dBμV) = Reading Level (dBμV) + Factor (dB)

Factor (dB) = Cable Loss (dB) + LISN Factor (dB)

Site: SIP-SR2	Time: 2021/04/07
Limit: FCC_Part15.207_CE_AC Power	Engineer: Rupert Wang
Probe: SIP-SR2-ENV216_101684_With Connect	Polarity: Neutral
EUT: Wireless Portable Receiver	Power: AC 120V/60Hz
Test Mode: Transmit by Full BW at channel 2442MHz at Ant 0	

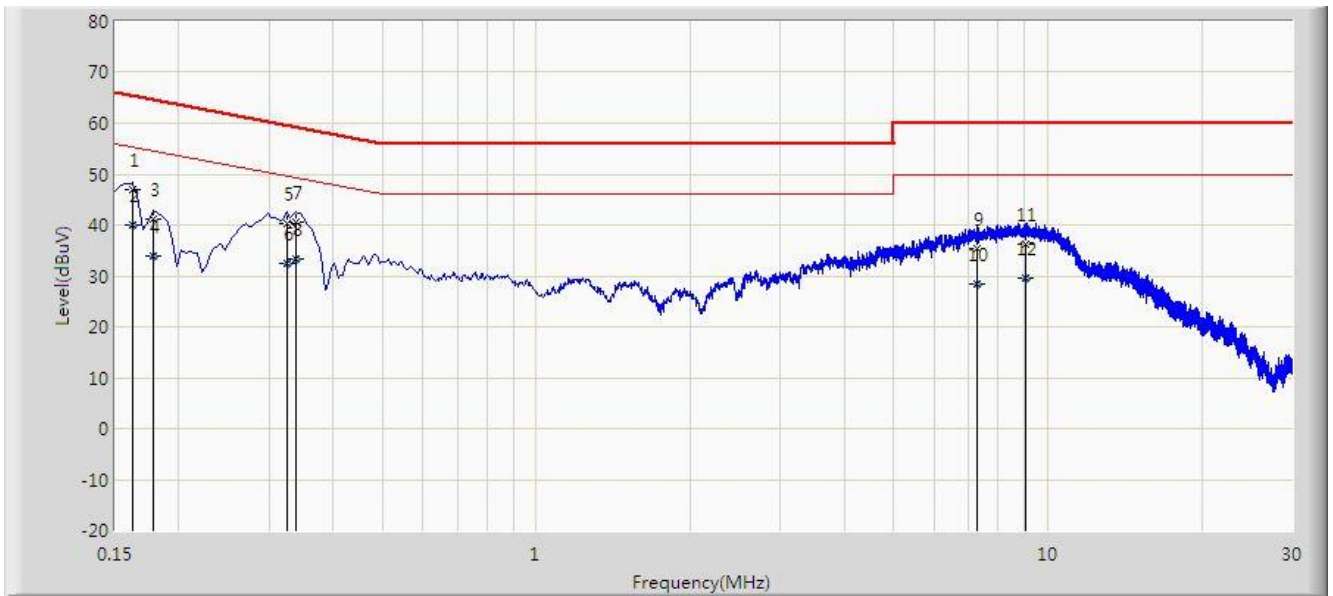

No	Flag	Mark	Frequency (MHz)	Measure Level (dBuV)	Reading Level (dBuV)	Margin (dB)	Limit (dBuV)	Factor (dB)	Type
1			0.162	47.063	37.630	-18.298	65.361	9.433	QP
2		*	0.162	39.885	30.452	-15.476	55.361	9.433	AV
3			0.178	41.166	31.731	-23.412	64.578	9.436	QP
4			0.178	33.911	24.475	-20.667	54.578	9.436	AV
5			0.326	40.225	30.698	-19.328	59.552	9.527	QP
6			0.326	32.375	22.848	-17.177	49.552	9.527	AV
7			0.338	40.597	31.071	-18.655	59.252	9.526	QP
8			0.338	33.367	23.841	-15.885	49.252	9.526	AV
9			7.258	35.321	25.484	-24.679	60.000	9.837	QP
10			7.258	28.414	18.577	-21.586	50.000	9.837	AV
11			9.054	36.142	26.208	-23.858	60.000	9.935	QP
12			9.054	29.650	19.716	-20.350	50.000	9.935	AV

Note: Measure Level (dBμV) = Reading Level (dBμV) + Factor (dB)

Factor (dB) = Cable Loss (dB) + LISN Factor (dB)

7. CONCLUSION

The data collected relate only the item(s) tested and show that the device is compliance with Part 15C of the FCC rules.

The End

Appendix A - Test Setup Photograph

Refer to "2103RSU001-UT" file.

Appendix B - EUT Photograph

Refer to "2103RSU001-UE" file.