

MEASUREMENT REPORT

FCC PART 15C

FCC ID: DD4GLXD4RZ3
Applicant: Shure Incorporated
Product: Wireless Receiver
Model No.: GLXD4R+ Z3
Trademark: 
FCC Classification: Digital Transmission System (DTS)
FCC Rule Part(s): Part 15 Subpart C (Section 15.247)
Test Result: Complies
Test Date: August 02 ~ 20, 2021

Reviewed By:

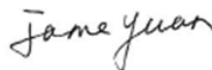

Jame Yuan

Approved By:

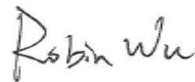

Robin Wu



The test results relate only to the samples tested.

This equipment has been shown to be capable of compliance with the applicable technical standards as indicated in the measurement report and was tested in accordance with the measurement procedures specified in ANSI C63.10-2013. Test results reported herein relate only to the item(s) tested.

The test report shall not be reproduced except in full without the written approval of MRT Technology (Suzhou) Co., Ltd.

Revision History

Report No.	Version	Description	Issue Date	Note
2107RSU058-U1	Rev. 01	Initial Report	08-21-2021	Valid

CONTENTS

Description	Page
1. General Information	5
1.1. Applicant	5
1.2. Manufacturer	5
1.3. Testing Facility	5
1.4. Equipment Description	6
1.5. Radio Specification under Test	6
1.6. Test Frequencies	7
1.7. Antennas Details	7
2. Test Configuration	8
2.1. Test Mode	8
2.2. Test Setup and Software	8
2.3. Duty Cycle	9
2.4. Applicable Standards	9
2.5. Test Environment Condition	9
3. Antenna Requirement	10
4. Test Equipment Calibration	11
5. Measurement Uncertainty	14
6. Test Result	15
6.1. Summary	15
6.2. 6dB Bandwidth Measurement	16
6.2.1. Test Limit	16
6.2.2. Test Procedure used	16
6.2.3. Test Setting	16
6.2.4. Test Setup	16
6.2.5. Test Result	17
6.3. Output Power Measurement	19
6.3.1. Test Limit	19
6.3.2. Test Procedure Used	19
6.3.3. Test Setting	19
6.3.4. Test Setup	20
6.3.5. Test Result	21
6.4. Power Spectral Density Measurement	22
6.4.1. Test Limit	22
6.4.2. Test Procedure Used	22

6.4.3.	Test Setting	22
6.4.4.	Test Setup	22
6.4.5.	Test Result	23
6.5.	Conducted Band Edge and Out-of-Band Emissions	25
6.5.1.	Test Limit.....	25
6.5.2.	Test Procedure Used.....	25
6.5.3.	Test Setting	25
6.5.4.	Test Setup	26
6.5.5.	Test Result	27
6.6.	Radiated Spurious Emission Measurement.....	36
6.6.1.	Test Limit.....	36
6.6.2.	Test Procedure Used.....	36
6.6.3.	Test Setting	36
6.6.4.	Test Setup	38
6.6.5.	Test Result	39
6.7.	Radiated Restricted Band Edge Measurement.....	47
6.7.1.	Test Limit.....	47
6.7.2.	Test Procedure Used.....	48
6.7.3.	Test Setting	48
6.7.4.	Test Setup	49
6.7.5.	Test Result	50
6.8.	AC Conducted Emissions Measurement.....	66
6.8.1.	Test Limit.....	66
6.8.2.	Test Setup	66
6.8.3.	Test Result	67
7.	Conclusion.....	69
	Appendix A - Test Setup Photograph.....	70
	Appendix B - EUT Photograph.....	71

1. General Information

1.1. Applicant

Shure Incorporated
5800 West Touhy Avenue, Niles, IL 60714-4608, USA

1.2. Manufacturer

Shure Incorporated
5800 West Touhy Avenue, Niles, IL 60714-4608, USA

1.3. Testing Facility

<input checked="" type="checkbox"/>	<p>Test Site - MRT Suzhou Laboratory</p> <p>Laboratory Location (Suzhou - Wuzhong) D8 Building, No.2 Tian'edang Rd., Wuzhong Economic Development Zone, Suzhou, China</p> <p>Laboratory Location (Suzhou - SIP) 4b Building, Liando U Valley, No.200 Xingpu Rd., Shengpu Town, Suzhou Industrial Park, China</p> <p>Laboratory Accreditations</p> <table border="0" style="width: 100%;"> <tr> <td>A2LA: 3628.01</td> <td>CNAS: L10551</td> </tr> <tr> <td>FCC: CN1166</td> <td>ISED: CN0001</td> </tr> <tr> <td colspan="2">VCCI: R-20025, R-20141, G-20034, G-20134, C-20020, C-20103, T-20020, T-20104</td> </tr> </table>	A2LA: 3628.01	CNAS: L10551	FCC: CN1166	ISED: CN0001	VCCI: R-20025, R-20141, G-20034, G-20134, C-20020, C-20103, T-20020, T-20104	
A2LA: 3628.01	CNAS: L10551						
FCC: CN1166	ISED: CN0001						
VCCI: R-20025, R-20141, G-20034, G-20134, C-20020, C-20103, T-20020, T-20104							
<input type="checkbox"/>	<p>Test Site - MRT Shenzhen Laboratory</p> <p>Laboratory Location (Shenzhen) 1G, Building A, Junxiangda Building, Zhongshanyuan Road West, Nanshan District, Shenzhen, China</p> <p>Laboratory Accreditations</p> <table border="0" style="width: 100%;"> <tr> <td>A2LA: 3628.02</td> <td>CNAS: L10551</td> </tr> <tr> <td>FCC: CN1284</td> <td>ISED: CN0105</td> </tr> </table>	A2LA: 3628.02	CNAS: L10551	FCC: CN1284	ISED: CN0105		
A2LA: 3628.02	CNAS: L10551						
FCC: CN1284	ISED: CN0105						
<input type="checkbox"/>	<p>Test Site - MRT Taiwan Laboratory</p> <p>Laboratory Location (Taiwan) No. 38, Fuxing 2nd Rd., Guishan Dist., Taoyuan City 333, Taiwan (R.O.C.)</p> <p>Laboratory Accreditations</p> <table border="0" style="width: 100%;"> <tr> <td>TAF: L3261-190725</td> <td></td> </tr> <tr> <td>FCC: 291082, TW3261</td> <td>ISED: TW3261</td> </tr> </table>	TAF: L3261-190725		FCC: 291082, TW3261	ISED: TW3261		
TAF: L3261-190725							
FCC: 291082, TW3261	ISED: TW3261						

1.4. Equipment Description

Product Name	Wireless Receiver
Model No.	GLXD4R+ Z3
Serial No.	3AE19575369
Radio Specification	2.4GHz & 5.8GHz
Antenna Specification	Refer to clause 1.7
Power Type	AC/DC Adapter
Accessory	
AC/DC Adapter	Model No.: PS43US Input: 100 ~ 240V, 50/60Hz, 0.25A Output: 15.0V=0.6A

Note: The information of EUT was provided by the manufacturer, and the accuracy of the information shall be the responsibility of the manufacturer.

1.5. Radio Specification under Test

Frequency Range	2404 ~ 2478MHz
Declared Channel Bandwidth	Full Bandwidth Mode: 2 MHz Half Bandwidth Mode: 1 MHz
Channel Number	36
Channel Spacing	1MHz
Type of Modulation	2-level CPM with Gaussian shaping (basically GFSK)
Antenna Number	2

Note 1: For other features of this EUT, test report will be issued separately.

Note 2: Two RF paths and antenna are the same and only one antenna can work during normal operation, it is switchable.

1.6. Test Frequencies

Frequency Bands (MHz)	Test Frequency (MHz)		
	Lowest	Middle	Highest
2404 ~ 2478	2404	2442	2478

Note: Detail working frequencies refer to operation description.

1.7. Antennas Details

Antenna Type	Frequency Band (MHz)	Max Peak Gain (dBi)
Dipole Antenna	2404	0.59
	2442	1.44
	2478	3.16

Note: The two antennas are identical.

2. Test Configuration

2.1. Test Mode

Test Mode	Mode 1: Transmit by Full BW
	Mode 2: Transmit by Half BW

Note: Bandwidth abbreviation is BW.

2.2. Test Setup and Software

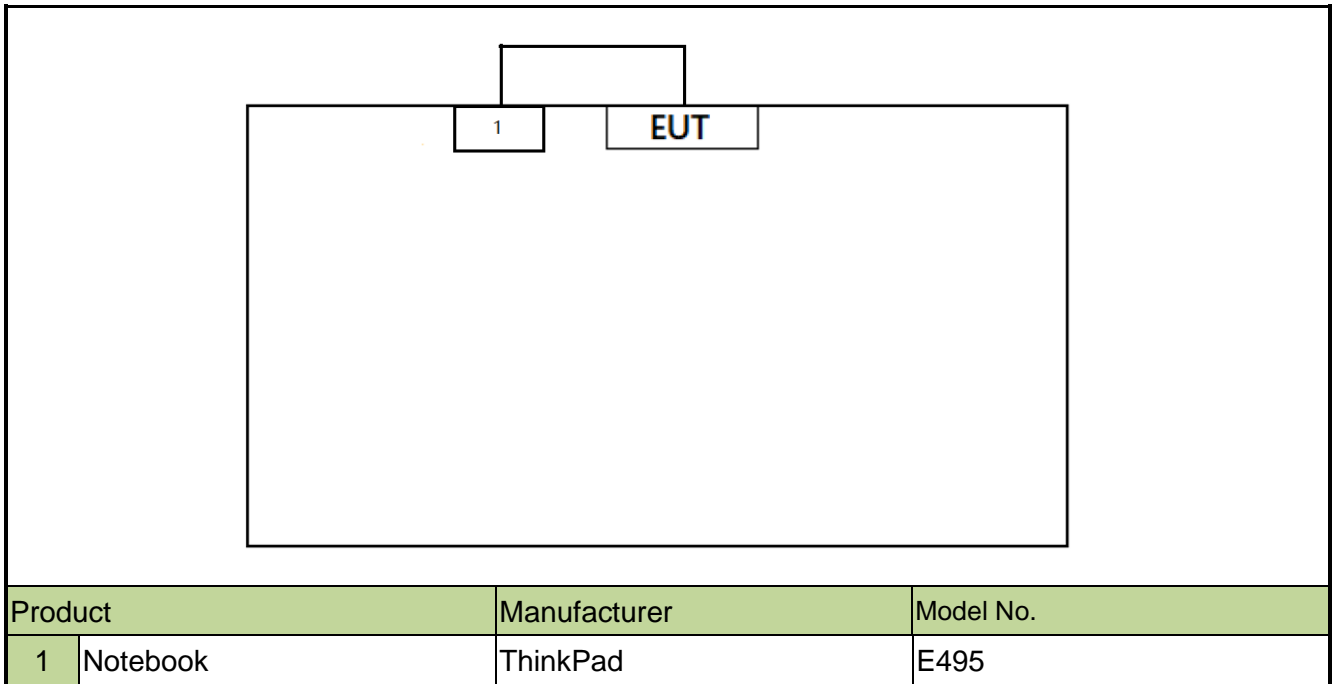

Note 1: The test utility software used during testing was “ttermpro.exe”, and the version was 4.78.

Note 2: Detail power setting refer to operation description.

2.3. Duty Cycle

The maximum achievable duty cycles for all modes were determined based on measurements performed on a spectrum analyzer in zero-span mode with RBW = 8MHz, VBW = 50MHz. The RBW and VBW were both greater than 50/T, where T is the minimum transmission duration, and the number of sweep points across T was greater than 100. The duty cycles are as follows:

Test Mode	Duty Cycle (%)
Full BW	60.23
Half BW	80.28

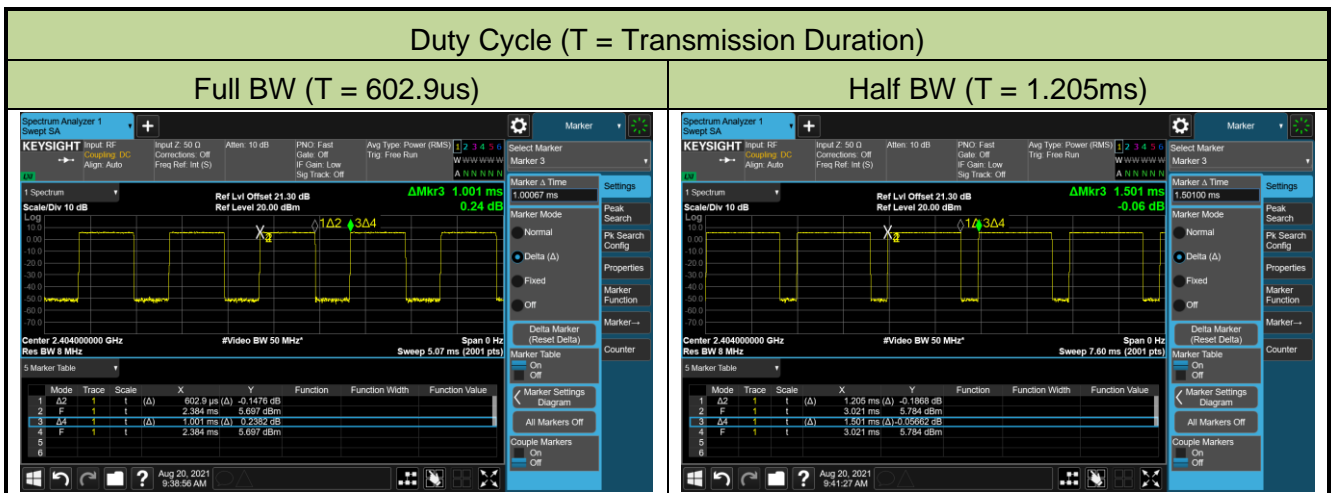

2.4. Applicable Standards

According to the specifications of the manufacturer, the EUT must comply with the requirements of the following standards:

- ANSI C63.10-2013

2.5. Test Environment Condition

Ambient Temperature	15 ~ 35 °C
Relative Humidity	20 ~ 75 %RH

3. Antenna Requirement

Excerpt from §15.203 of the FCC Rules/Regulations:

“An intentional radiator antenna shall be designed to ensure that no antenna other than that furnished by the responsible party can be used with the device. The use of a permanently attached antenna or of an antenna that uses a unique coupling to the intentional radiator shall be considered sufficient to comply with the provisions of this section.”

- The antenna of the device is **permanently attached**.
- There are no provisions for connection to an external antenna.

Conclusion:

The unit complies with the requirement of §15.203.

4. Test Equipment Calibration

Conducted Emission (WZ-SR2)

Instrument	Manufacturer	Type No.	Asset No.	Cali. Interval	Cali. Due Date
EMI Test Receiver	R&S	ESR3	MRTSUE06909	1 year	2021/11/22
Two-Line V-Network	R&S	ENV216	MRTSUE06002	1 year	2022/06/08
Thermal Hygrometer	testo	608-H1	MRTSUE06404	1 year	2022/06/28
Shielding Room	MIX-BEP	Chamber-SR2	MRTSUE06215	N/A	N/A

Conducted Emission (SIP-SR2)

Instrument	Manufacturer	Type No.	Asset No.	Cali. Interval	Cali. Due Date
EMI Test Receiver	R&S	ESR3	MRTSUE06613	1 year	2022/06/24
Two-Line V-Network	R&S	ENV216	MRTSUE06003	1 year	2022/06/08
Thermal Hygrometer	testo	608-H1	MRTSUE06621	1 year	2021/12/03

Radiated Emission (WZ-AC1)

Instrument	Manufacturer	Type No.	Asset No.	Cali. Interval	Cali. Due Date
EMI Test Receiver	R&S	ESR7	MRTSUE06001	1 year	2022/01/04
Loop Antenna	Schwarzbeck	FMZB 1519	MRTSUE06025	1 year	2021/11/08
Bilog Period Antenna	Schwarzbeck	VULB 9168	MRTSUE06172	1 year	2022/08/05
Horn Antenna	Schwarzbeck	BBHA 9120D	MRTSUE06023	1 year	2021/09/27
Horn Antenna	Schwarzbeck	BBHA9170	MRTSUE06597	1 year	2021/12/14
Microwave System Amplifier	Agilent	83017A	MRTSUE06076	1 year	2021/11/14
Preamplifier	Schwarzbeck	BBV 9721	MRTSUE06121	1 year	2022/06/09
Thermal Hygrometer	testo	608-H1	MRTSUE06403	1 year	2022/06/28
Anechoic Chamber	TDK	Chamber-AC1	MRTSUE06212	1 year	2022/04/29

Radiated Emission (WZ-AC2)

Instrument	Manufacturer	Type No.	Asset No.	Cali. Interval	Cali. Due Date
MXE EMI Receiver	Keysight	N9038A	MRTSUE06125	1 year	2022/06/24
Loop Antenna	Schwarzbeck	FMZB 1519	MRTSUE06025	1 year	2021/11/08
Bilog Period Antenna	Schwarzbeck	VULB 9162	MRTSUE06022	1 year	2022/05/24
Broad-Band Horn Antenna	Schwarzbeck	BBHA 9120D	MRTSUE06171	1 year	2021/10/25
Horn Antenna	Schwarzbeck	BBHA9170	MRTSUE06597	1 year	2021/12/14
Broadband Coaxial Preamplifier	Schwarzbeck	BBV 9718	MRTSUE06176	1 year	2021/11/14
Thermal Hygrometer	Minggao	ETH529	MRTSUE06170	1 year	2021/12/08
Anechoic Chamber	RIKEN	Chamber-AC2	MRTSUE06213	1 year	2022/04/29

Radiated Emission (SIP-AC1)

Instrument	Manufacturer	Type No.	Asset No.	Cali. Interval	Cali. Due Date
EMI Test Receiver	R&S	ESR3	MRTSUE06612	1 year	2022/06/24
EXA Signal Analyzer	Keysight	N9010B	MRTSUE06559	1 year	2022/06/24
Loop Antenna	Schwarzbeck	FMZB 1519 B	MRTSUE06937	1 year	2022/03/09
Bilog Period Antenna	Schwarzbeck	VULB9168	MRTSUE06645	1 year	2021/08/30
Double Ridged Horn Antenna	R&S	HF907	MRTSUE06610	1 year	2021/08/30
Preamplifier	EMCI	EMC051845SE	MRTSUE06600	1 year	2021/11/09
Thermal Hygrometer	testo	608-H1	MRTSUE06620	1 year	2021/12/03
Anechoic Chamber	RIKEN	SIP-AC1	MRTSUE06554	1 year	2021/12/24

Radiated Emission (SIP-AC2)

Instrument	Manufacturer	Type No.	Asset No.	Cali. Interval	Cali. Due Date
EMI Test Receiver	R&S	ESR3	MRTSUE06613	1 year	2022/06/24
MXA Signal Analyzer	Keysight	N9020B	MRTSUE06604	1 year	2021/09/26
Loop Antenna	Schwarzbeck	FMZB 1519 B	MRTSUE06937	1 year	2022/03/09
Bilog Period Antenna	Schwarzbeck	VULB9168	MRTSUE06646	1 year	2021/08/30
Horn Antenna	Schwarzbeck	BBHA9120D	MRTSUE06648	1 year	2021/11/26
Horn Antenna	Schwarzbeck	BBHA9170	MRTSUE06599	1 year	2021/11/26
Preamplifier	EMCI	EMC051845SE	MRTSUE06644	1 year	2021/11/09
Preamplifier	EMCI	EMC184045SE	MRTSUE06602	1 year	2021/10/12
Thermal Hygrometer	testo	608-H1	MRTSUE06624	1 year	2021/12/03
Anechoic Chamber	RIKEN	SIP-AC2	MRTSUE06781	1 year	2021/12/24

Radiated Emission (SIP-AC3)

Instrument	Manufacturer	Type No.	Asset No.	Cali. Interval	Cali. Due Date
Preamplifier	Schwarzbeck	BBV 9721	MRTSUE06121	1 year	2022/06/09
EMI Test Receiver	R&S	ESR3	MRTSUE06612	1 year	2022/06/24
EXA Signal Analyzer	Keysight	N9010B	MRTSUE06559	1 year	2022/06/24
Loop Antenna	Schwarzbeck	FMZB 1519	MRTSUE06025	1 year	2021/11/08
Bilog Period Antenna	Schwarzbeck	VULB9168	MRTSUE06646	1 year	2021/08/30
Double Ridged Horn Antenna	R&S	HF907	MRTSUE06611	1 year	2021/09/13
Horn Antenna	Schwarzbeck	BBHA9170	MRTSUE06598	1 year	2021/11/26
Preamplifier	EMCI	EMC012645SE	MRTSUE06642	1 year	2022/01/14
Thermal Hygrometer	testo	608-H1	MRTSUE06622	1 year	2021/12/03
Anechoic Chamber	RIKEN	SIP-AC3	MRTSUE06782	1 year	2021/12/24

Conducted Test Equipment (WZ-TR3)

Instrument	Manufacturer	Type No.	Asset No.	Cali. Interval	Cali. Due Date
EXA Signal Analyzer	Agilent	N9020A	MRTSUE06106	1 year	2022/04/13
EXA Signal Analyzer	Keysight	N9010B	MRTSUE06607	1 year	2022/01/06
Power Meter	Agilent	U2021XA	MRTSUE06030	1 year	2021/10/22
USB wideband power sensor	Keysight	U2021XA	MRTSUE06446	1 year	2022/06/08
USB wideband power sensor	Keysight	U2021XA	MRTSUE06447	1 year	2022/06/08
Bluetooth Test Set	Anritsu	MT8852B-042	MRTSUE06389	1 year	2022/06/08
Modulation Analyzer	HP	HP8901A	MRTSUE06098	1 year	2021/09/26
DC Power Supply	GWINSTEK	DPS-3303C	MRTSUE06064	N/A	N/A
Temperature & Humidity Chamber	BAOYT	BYH-150CL	MRTSUE06051	1 year	2021/10/22
Thermal Hygrometer	testo	608-H1	MRTSUE06401	1 year	2022/06/28
Attenuator	MVE	6dB	MRTSUE06534	1 year	N/A
Attenuator	MVE	10dB	MRTSUE06543	1 year	N/A

Conducted Test Equipment (SIP-TR1)

Instrument	Manufacturer	Type No.	Asset No.	Cali. Interval	Cali. Due Date
EXA Signal Analyzer	KEYSIGHT	N9010B	MRTSUE06603	1 year	2021/11/23
PXA Signal Analyzer	Keysight	N9030B	MRTSUE06395	1 year	2021/08/30
USB wideband power sensor	Agilent	U2021XA	MRTSUE06595	1 year	2021/09/26
USB wideband power sensor	Agilent	U2021XA	MRTSUE06596	1 year	2021/09/26
Temperature Chamber	BAOYT	BYG-408CS	MRTSUE06847	1 year	2022/02/23
Thermal Hygrometer	testo	608-H1	MRTSUE11022	1 year	2021/11/25
Attenuator	MVE	6dB	MRTSUE06534	1 year	N/A
Attenuator	MVE	10dB	MRTSUE06543	1 year	N/A

Software	Version	Function
EMI Software	V3	EMI Test Software

5. Measurement Uncertainty

Where relevant, the following test uncertainty levels have been estimated for tests performed on the EUT as specified in CISPR 16-4-2. This uncertainty represents an expanded uncertainty expressed at approximately the 95% confidence level using a coverage factor of $k = 2$.

AC Conducted Emission Measurement
Measurement Uncertainty for a Level of Confidence of 95% ($U=2Uc(y)$): 9kHz~150kHz: 3.74dB 150kHz~30MHz: 3.44dB
Radiated Disturbance
Measurement Uncertainty for a Level of Confidence of 95% ($U=2Uc(y)$): Horizontal: 9kHz~300MHz: 5.04dB 300MHz~1GHz: 4.95dB 1GHz~40GHz: 6.40dB Vertical: 9kHz~300MHz: 5.24dB 300MHz~1GHz: 6.03dB 1GHz~40GHz: 6.40dB
Spurious Emissions, Conducted
Measuring Uncertainty for a Level of Confidence of 95% ($U=2Uc(y)$): 0.78dB
Output Power
Measuring Uncertainty for a Level of Confidence of 95% ($U=2Uc(y)$): 1.13dB
Power Spectrum Density
Measuring Uncertainty for a Level of Confidence of 95% ($U=2Uc(y)$): 1.15dB
Occupied Bandwidth
Measuring Uncertainty for a Level of Confidence of 95% ($U=2Uc(y)$): 0.28%

6. Test Result

6.1. Summary

FCC Part Section(s)	Test Description	Test Condition	Test Result	Reference
15.247(a)(2)	6dB Bandwidth	Conducted	Pass	Section 6.2
15.247(b)(3)	Output Power		Pass	Section 6.3
15.247(e)	Power Spectral Density		Pass	Section 6.4
15.247(d)	Band Edge / Out-of-Band Emissions		Pass	Section 6.5
15.205 15.209	General Field Strength (Restricted Bands and Radiated Emission)	Radiated	Pass	Section 6.6 & 6.7
15.207	AC Conducted Emissions 150kHz - 30MHz	Line Conducted	Pass	Section 6.8

Notes:

- 1) The analyzer plots shown in this section were all taken with a correction table loaded into the analyzer. The correction table was used to account for the losses of the cables and attenuators used as part of the system to connect the EUT to the analyzer at all frequencies of interest.
- 2) All modes of operation and data rates were investigated. For radiated emission test, every axis (X, Y, Z) was also verified. The test results shown in the following sections represent the worst case emissions.
- 3) Test Item "Output Power" and "Band Edge / Out-of-Band Emissions" were assessed two antenna ports, any others test items were assessed the worst-case antenna port.

6.2. 6dB Bandwidth Measurement

6.2.1. Test Limit

The minimum 6dB bandwidth shall be at least 500 kHz.

6.2.2. Test Procedure used

ANSI C63.10-2013 - Section 11.8

6.2.3. Test Setting

1. The Spectrum's automatic bandwidth measurement capability was used to perform the 6dB bandwidth measurement. The "X" dB bandwidth parameter was set to $X = 6$. The bandwidth measurement was not influenced by any intermediate power nulls in the fundamental emission.
2. Set RBW = 100 kHz
3. $VBW \geq 3 \times RBW$
4. Detector = Peak
5. Trace mode = Max hold
6. Sweep = Auto couple
7. Allow the trace was allowed to stabilize

6.2.4. Test Setup

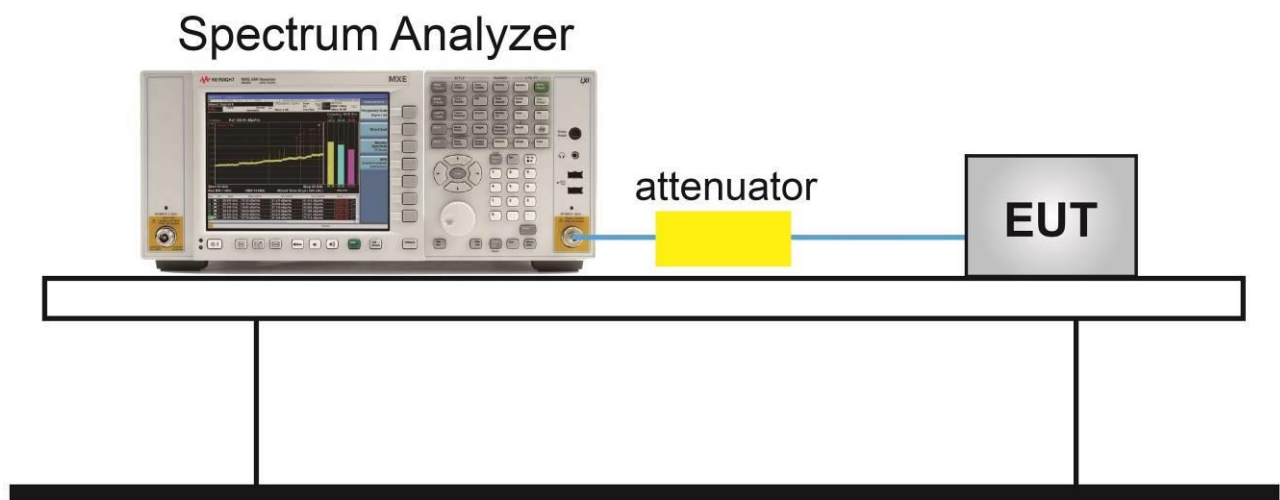

6.2.5. Test Result

Test Site	SIP-TR1	Test Engineer	Alisa Deng
Test Date	2021/08/03		

Test Mode	Frequency (MHz)	6dB Bandwidth (MHz)	Limit (MHz)	Result
Full BW	2404	1.957	≥ 0.5	Pass
Full BW	2442	2.061	≥ 0.5	Pass
Full BW	2478	2.065	≥ 0.5	Pass
Half BW	2404	1.043	≥ 0.5	Pass
Half BW	2442	1.037	≥ 0.5	Pass
Half BW	2478	1.080	≥ 0.5	Pass



Half BW 6dB Bandwidth

2404MHz

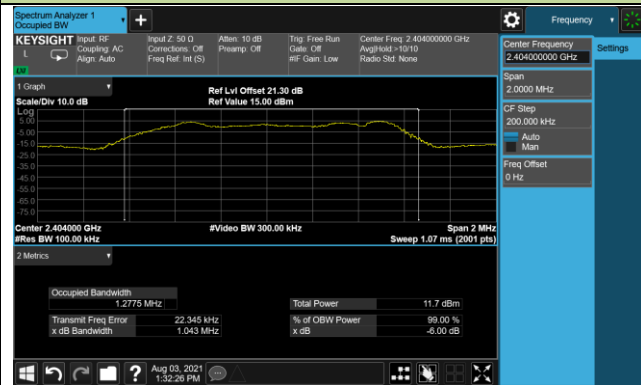

2442MHz

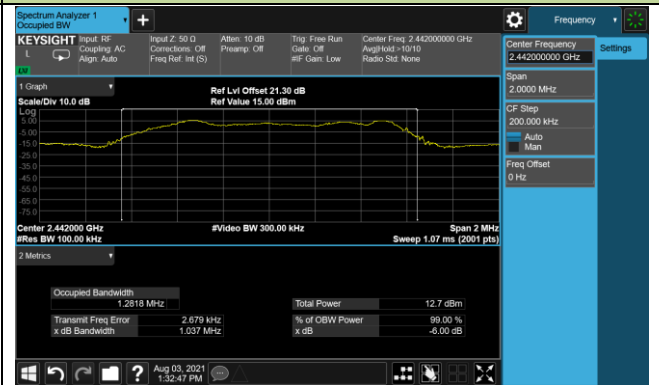

2478MHz

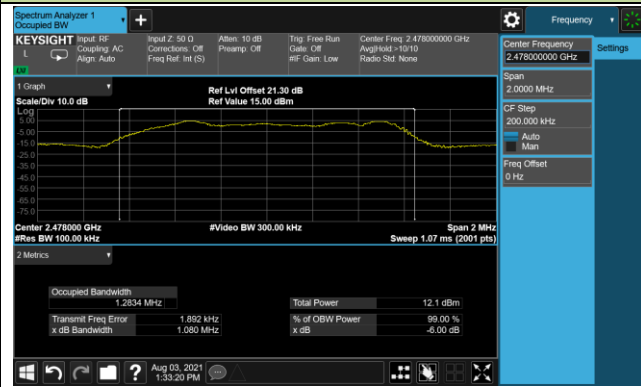

6.3. Output Power Measurement

6.3.1. Test Limit

The maximum out power shall be less 1 Watt (30dBm).

The conducted output power limit specified in paragraph FCC Part 15.247(b) of this section is based on the use of antennas with directional gains that do not exceed 6 dBi. If transmitting antennas of directional gain greater than 6 dBi are used, the conducted output power from the intentional radiator shall be reduced below the stated values in paragraphs FCC Part 15.247(b)(3) of this section, as appropriate, by the amount in dB that the directional gain of the antenna exceeds 6 dBi.

6.3.2. Test Procedure Used

ANSI C63.10-2013 Section 11.9.1.3

ANSI C63.10-2013 Section 11.9.2.3

6.3.3. Test Setting

Method PKPM1 (Peak Power Measurement of Signals with DTS BW \leq 50MHz)

Peak power measurements were performed only when the EUT was transmitting at its maximum power control level using a broadband power meter with a pulse sensor. The pulse sensor employs a VBW = 50MHz so this method was only used for signals whose DTS bandwidth was less than or equal to 50MHz.

Average Power Measurement

Average power measurements were performed only when the EUT was transmitting at its maximum power control level using a broadband power meter with a pulse sensor. The power meter implemented triggering and gating capabilities which were set up such that power measurements were recorded only during the ON time of the transmitter.

6.3.4. Test Setup

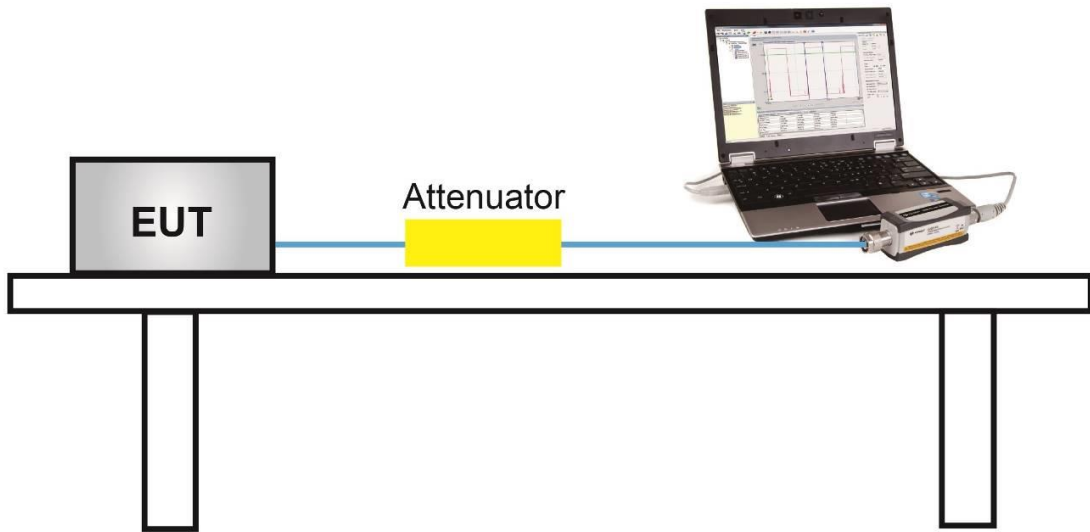

6.3.5. Test Result

Test Site	SIP-TR1	Test Engineer	Alisa Deng
Test Date	2021/08/02		

Test Mode	Freq. (MHz)	Peak Power (dBm)		Limit (dBm)	Result
		Ant a	Ant b		
Full BW	2404	5.03	5.43	≤ 30.00	Pass
Full BW	2442	6.27	6.40	≤ 30.00	Pass
Full BW	2478	5.36	5.65	≤ 30.00	Pass
Half BW	2404	4.87	5.45	≤ 30.00	Pass
Half BW	2442	6.02	6.30	≤ 30.00	Pass
Half BW	2478	5.12	5.51	≤ 30.00	Pass

Test Result of Average Output Power (Reporting Only)

Test Mode	Freq. (MHz)	Average Power (dBm)		Limit (dBm)	Result
		Ant a	Ant b		
Full BW	2404	4.12	4.62	≤ 30.00	Pass
Full BW	2442	5.34	5.58	≤ 30.00	Pass
Full BW	2478	4.32	4.83	≤ 30.00	Pass
Half BW	2404	4.10	4.78	≤ 30.00	Pass
Half BW	2442	5.30	5.61	≤ 30.00	Pass
Half BW	2478	4.23	4.84	≤ 30.00	Pass

6.4. Power Spectral Density Measurement

6.4.1. Test Limit

The maximum permissible power spectral density is 8dBm in any 3 kHz band.

The same method of determining the conducted output power shall be used to determine the power spectral density.

6.4.2. Test Procedure Used

ANSI C63.10-2013 - Section 11.10.2

6.4.3. Test Setting

1. Analyzer was set to the center frequency of the DTS channel under investigation
2. Span ≥ 1.5 times the OBW
3. RBW = 3kHz
4. VBW = 10kHz
5. Detector = Peak
6. Sweep time = auto couple
7. Trace mode = max hold
8. Trace was allowed to stabilize

6.4.4. Test Setup

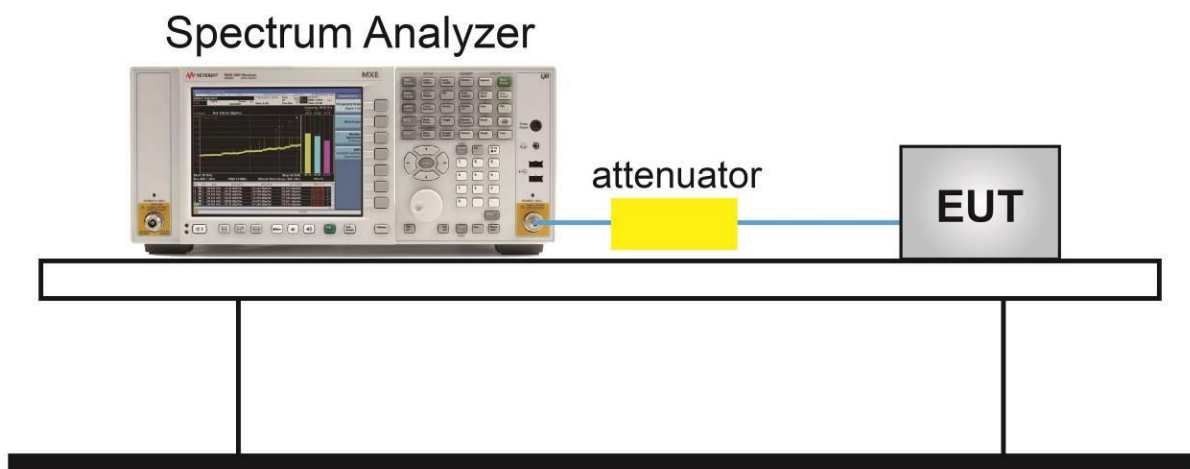

6.4.5. Test Result

Test Site	SIP-TR1	Test Engineer	Alisa Deng
Test Date	2021/08/03		

Test Mode	Freq. (MHz)	PKPSD (dBm / 3kHz)	Limit (dBm / 3kHz)	Result
Full BW	2404	-13.64	≤ 8.00	Pass
Full BW	2442	-12.88	≤ 8.00	Pass
Full BW	2478	-13.57	≤ 8.00	Pass
Half BW	2404	-10.33	≤ 8.00	Pass
Half BW	2442	-9.41	≤ 8.00	Pass
Half BW	2478	-9.99	≤ 8.00	Pass

Full BW PKPSD - Ant b

2404MHz



2442MHz

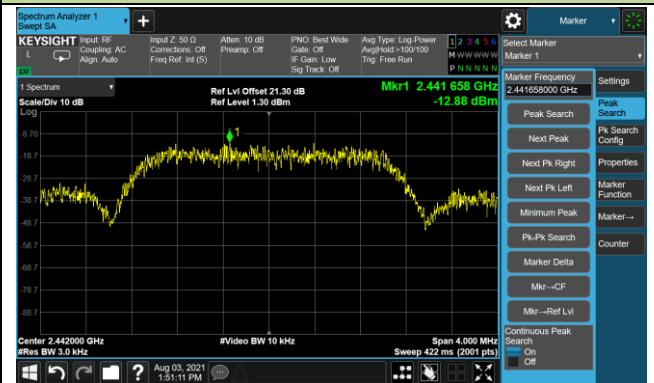

2478MHz



Half BW PKPSD - Ant b

2404MHz

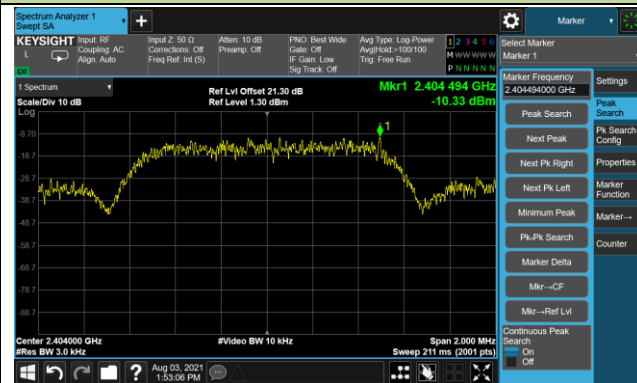

2442MHz



2478MHz

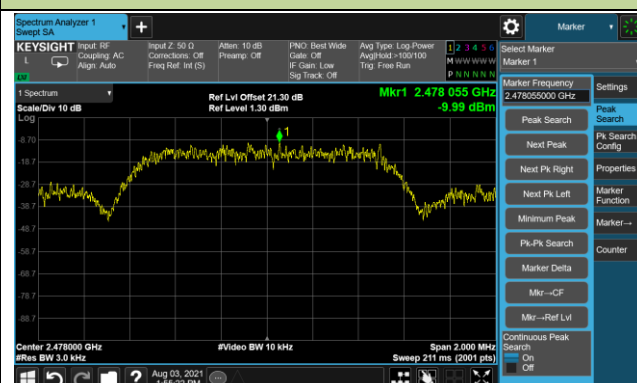

6.5. Conducted Band Edge and Out-of-Band Emissions

6.5.1. Test Limit

The limit for out-of-band spurious emissions at the band edge is 20dB below the fundamental emission level, as determined from the in-band power measurement of the DTS channel performed in a 100 kHz bandwidth per the PSD procedure.

6.5.2. Test Procedure Used

ANSI C63.10-2013 - Section 11.11

6.5.3. Test Setting

Reference level measurement

1. Set instrument center frequency to DTS channel center frequency
2. Set the span to ≥ 1.5 times the DTS bandwidth
3. Set the RBW = 100 kHz
4. Set the VBW $\geq 3 \times$ RBW
5. Detector = peak
6. Sweep time = auto couple
7. Trace mode = max hold
8. Allow trace to fully stabilize

Emission level measurement

1. Set the center frequency and span to encompass frequency range to be measured
2. RBW = 100kHz
3. VBW = 300kHz
4. Detector = Peak
5. Trace mode = max hold
6. Sweep time = auto couple
7. The trace was allowed to stabilize

6.5.4. Test Setup

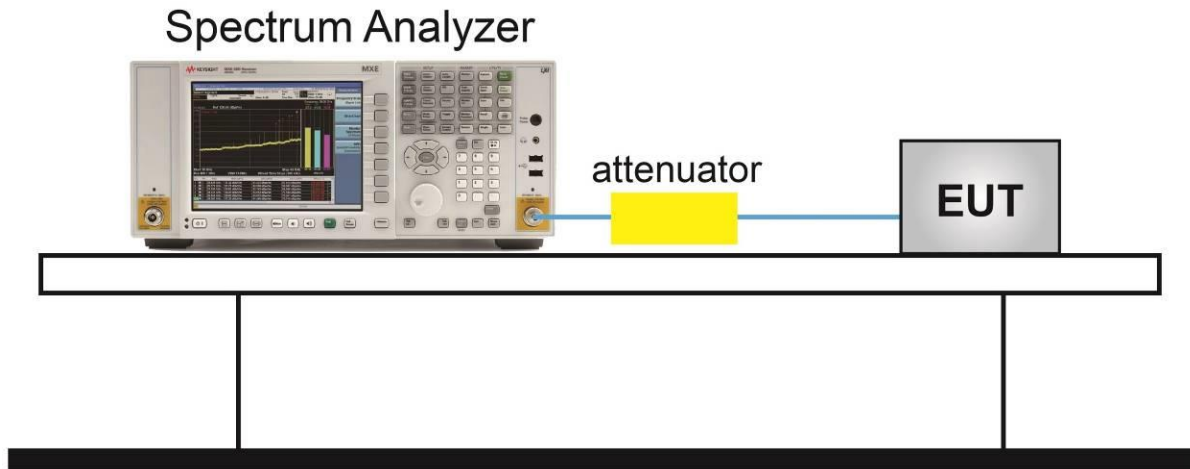

6.5.5. Test Result

Test Site	SIP-TR1	Test Engineer	Alisa Deng
Test Date	2021/08/03		

Test Mode	Frequency (MHz)	Limit	Result
Full BW	2404	20dBc	Pass
Full BW	2442	20dBc	Pass
Full BW	2478	20dBc	Pass
Half BW	2404	20dBc	Pass
Half BW	2442	20dBc	Pass
Half BW	2478	20dBc	Pass

Full BW Out-of-Band Emissions - Ant a

2404MHz

100kHz PSD Reference Level

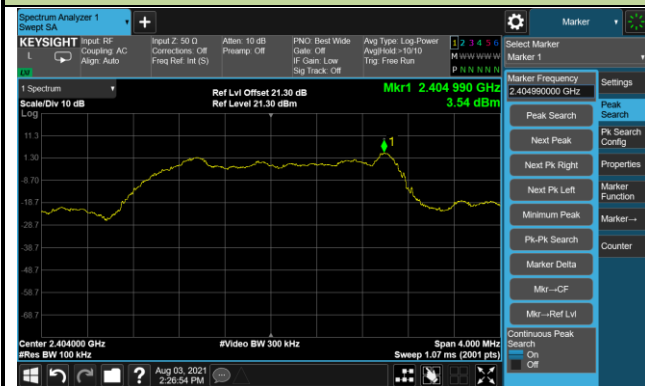

Low Band Edge



Spurious Emission

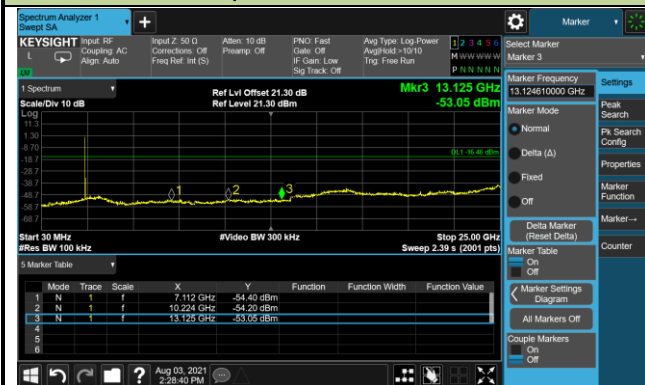

2442MHz

100kHz PSD Reference Level



Spurious Emission



Full BW Out-of-Band Emissions - Ant a

2478MHz

100kHz PSD Reference Level

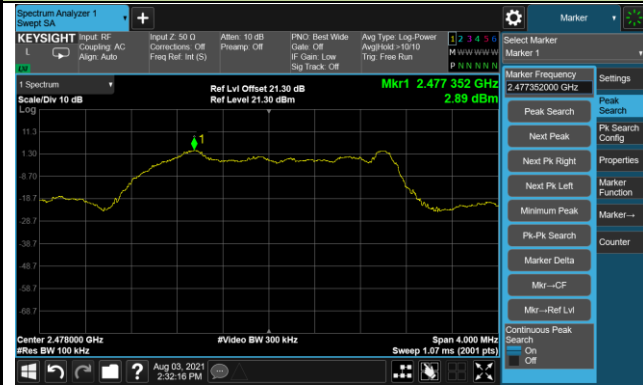

High Band Edge

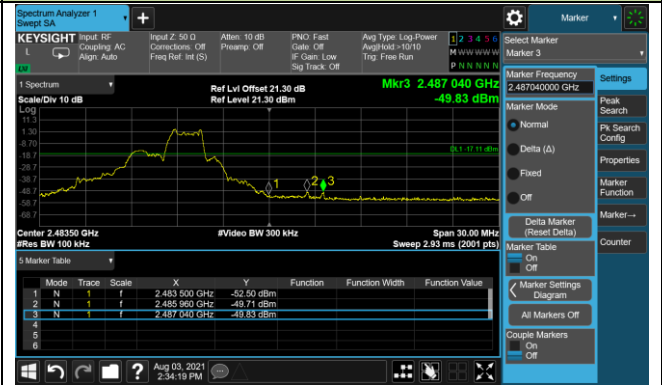

Spurious Emission



Half BW Out-of-Band Emissions - Ant a

2404MHz

100kHz PSD Reference Level



Low Band Edge



Spurious Emission

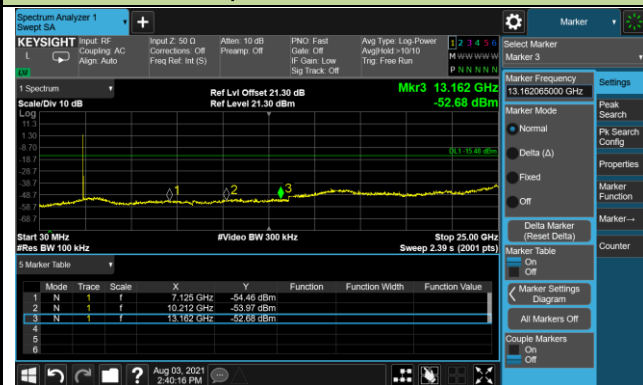

2442MHz

100kHz PSD Reference Level



Spurious Emission



Half BW Out-of-Band Emissions - Ant a

2478MHz

100kHz PSD Reference Level

High Band Edge

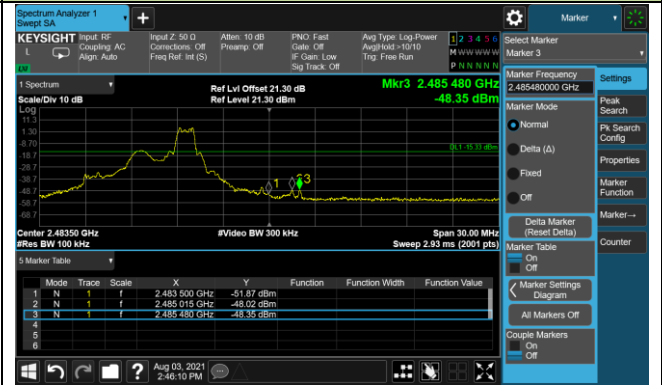
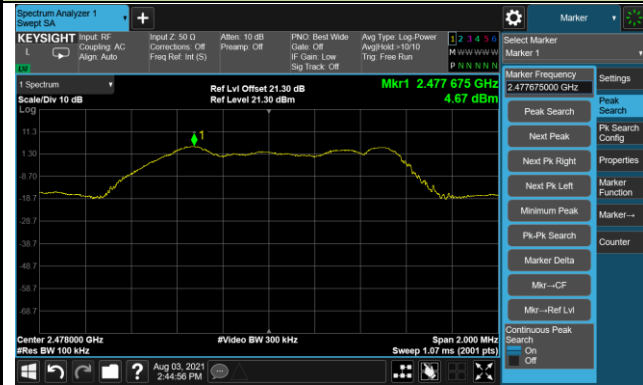

Spurious Emission



Full BW Out-of-Band Emissions - Ant b

2404MHz

100kHz PSD Reference Level

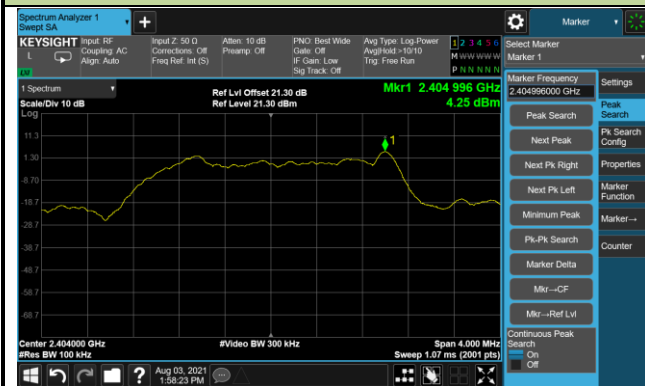

Low Band Edge



Spurious Emission



2442MHz

100kHz PSD Reference Level

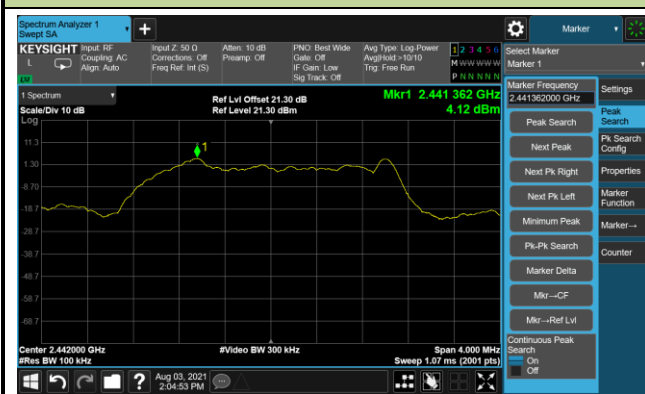

Spurious Emission



Full BW Out-of-Band Emissions - Ant b

2478MHz

100kHz PSD Reference Level

High Band Edge

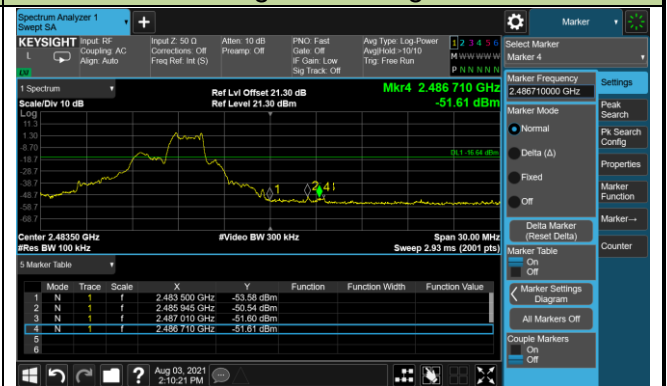
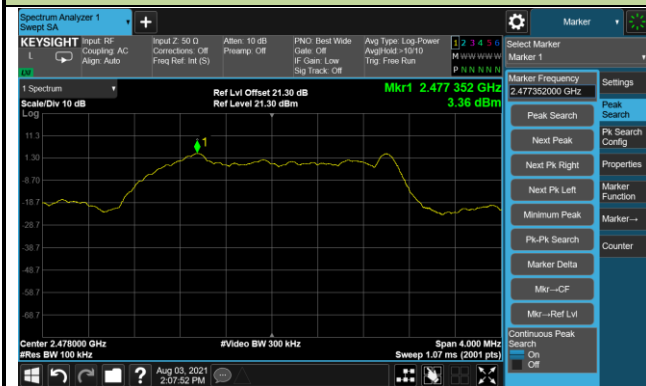

Spurious Emission

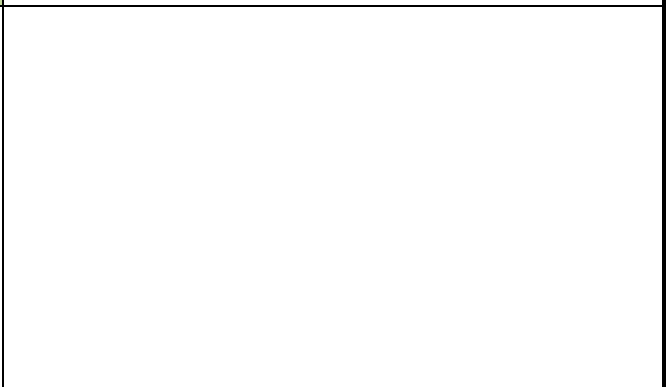

Half BW Out-of-Band Emissions - Ant b

2404MHz

100kHz PSD Reference Level



Low Band Edge



Spurious Emission

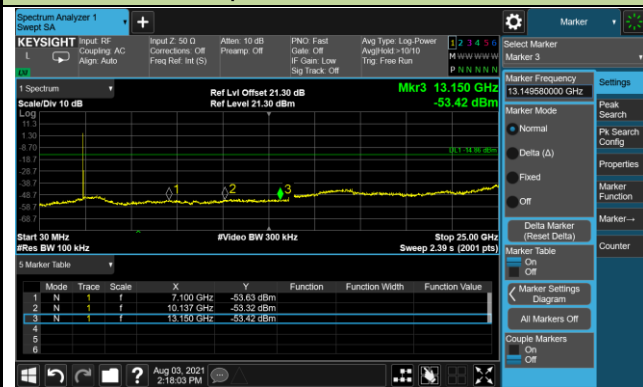

2442MHz

100kHz PSD Reference Level



Spurious Emission



Half BW Out-of-Band Emissions - Ant b

2478MHz

100kHz PSD Reference Level

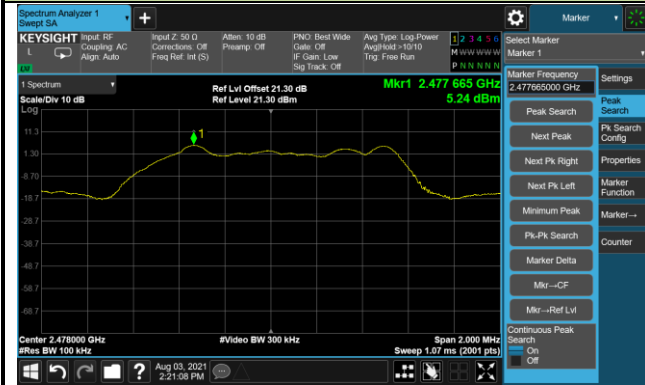

High Band Edge

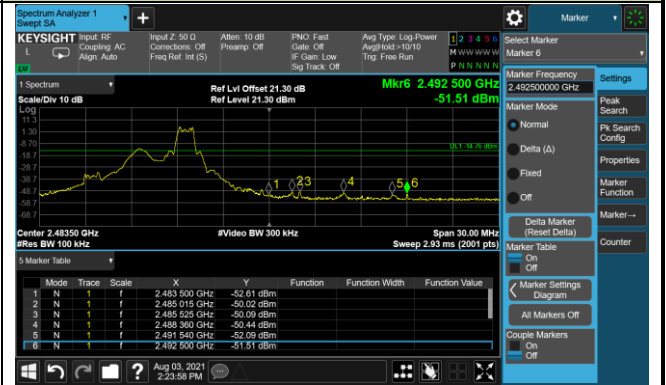

Spurious Emission



6.6. Radiated Spurious Emission Measurement

6.6.1. Test Limit

All out of band emissions appearing in a restricted band as specified in Section 15.205 of the Title 47 CFR must not exceed the limits shown in Table per Section 15.209.

FCC Part 15 Subpart C Paragraph 15.209		
Frequency [MHz]	Field Strength [uV/m]	Measured Distance [Meters]
0.009 - 0.490	2400/F (kHz)	300
0.490 - 1.705	24000/F (kHz)	30
1.705 - 30	30	30
30 - 88	100	3
88 - 216	150	3
216 - 960	200	3
Above 960	500	3

6.6.2. Test Procedure Used

ANSI C63.10-2013 - Section 6.3 & 6.4 & 6.5 & 6.6

6.6.3. Test Setting

Table 1 - RBW as a function of frequency

Frequency	RBW
9 ~ 150 kHz	200 ~ 300 Hz
0.15 ~ 30 MHz	9 ~ 10 kHz
30 ~ 1000 MHz	100 ~ 120 kHz
> 1000MHz	1MHz

Quasi-Peak Measurements below 1GHz

1. Analyzer center frequency was set to the frequency of the radiated spurious emission of interest
2. Span was set greater than 1MHz
3. RBW = as specified in Table 1
4. Detector = CISPR quasi-peak
5. Sweep time = auto couple
6. Trace was allowed to stabilize

Peak Measurements above 1GHz

1. Analyzer center frequency was set to the frequency of the radiated spurious emission of interest
2. RBW = 1MHz
3. VBW = 3MHz
4. Detector = peak
5. Sweep time = auto couple
6. Trace mode = max hold
7. Trace was allowed to stabilize

Average Measurements above 1GHz (Method VB)

1. Analyzer center frequency was set to the frequency of the radiated spurious emission of interest
2. RBW = 1MHz
3. VBW; If the EUT is configured to transmit with duty cycle $\geq 98\%$, set VBW = 10 Hz.
If the EUT duty cycle is $< 98\%$, set VBW $\geq 1/T$. T is the minimum transmission duration.
4. Detector = Peak
5. Sweep time = auto
6. Trace mode = max hold
7. Trace was allowed to stabilize

6.6.4. Test Setup

Below 1GHz Test Setup:

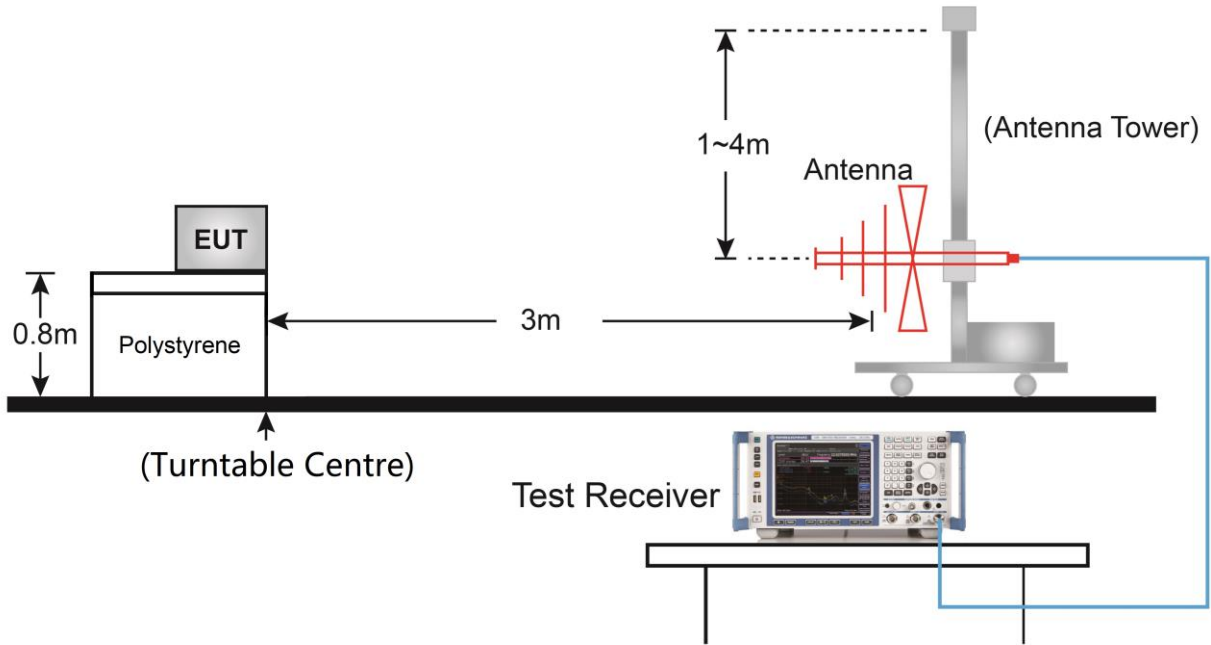

Above 1GHz Test Setup:

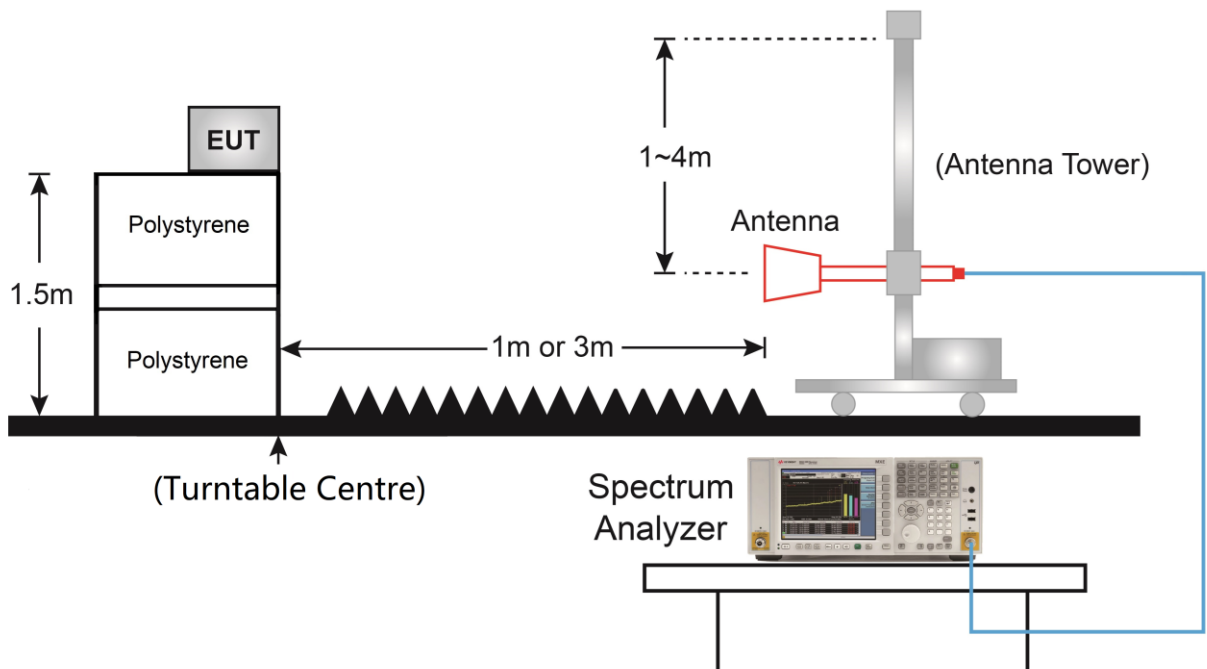

6.6.5. Test Result

Test Site	SIP-AC3	Test Engineer	Yien Qian
Test Date	2021/08/14	Test Frequency	2404MHz
Test Mode	Full BW		
Remark	<ol style="list-style-type: none"> 1. Average measurement was not performed if peak level lower than average limit. 2. Other frequency was 20dB below limit line within 1-18GHz, there is not show in the report. 		

Frequency (MHz)	Reading Level (dB μ V)	Factor (dB)	Measure Level (dB μ V/m)	Limit (dB μ V/m)	Margin (dB)	Detector	Polarization
7681.0	51.0	-5.1	45.9	74.0	-28.1	Peak	Horizontal
8216.5	51.2	-4.2	47.0	74.0	-27.0	Peak	Horizontal
12203.0	50.3	-2.0	48.3	74.0	-25.7	Peak	Horizontal
8259.0	50.2	-4.1	46.1	74.0	-27.9	Peak	Vertical
11761.0	50.6	-2.9	47.7	74.0	-26.3	Peak	Vertical
15747.5	47.7	4.3	52.0	74.0	-22.0	Peak	Vertical

Note: Measure Level (dB μ V/m) = Reading Level (dB μ V) + Factor (dB)
 Factor (dB) = Cable Loss (dB) + Antenna Factor (dB/m) - Pre_Amplifier Gain (dB)

Test Site	SIP-AC3	Test Engineer	Yien Qian
Test Date	2021/08/14	Test Frequency	2442MHz
Test Mode	Full BW		
Remark	1. Average measurement was not performed if peak level lower than average limit. 2. Other frequency was 20dB below limit line within 1-18GHz, there is not show in the report.		

Frequency (MHz)	Reading Level (dB μ V)	Factor (dB)	Measure Level (dB μ V/m)	Limit (dB μ V/m)	Margin (dB)	Detector	Polarization
7647.0	51.5	-5.0	46.5	74.0	-27.5	Peak	Horizontal
8369.5	50.3	-4.0	46.3	74.0	-27.7	Peak	Horizontal
11812.0	50.4	-2.6	47.8	74.0	-26.2	Peak	Horizontal
7655.5	50.5	-5.0	45.5	74.0	-28.5	Peak	Vertical
8276.0	48.7	-4.1	44.6	74.0	-29.4	Peak	Vertical
12016.0	49.6	-2.2	47.4	74.0	-26.6	Peak	Vertical

Note: Measure Level (dB μ V/m) = Reading Level (dB μ V) + Factor (dB)

Factor (dB) = Cable Loss (dB) + Antenna Factor (dB/m) - Pre_Amplifier Gain (dB)

Test Site	SIP-AC3	Test Engineer	Yien Qian
Test Date	2021/08/14	Test Frequency	2478MHz
Test Mode	Full BW		
Remark	1. Average measurement was not performed if peak level lower than average limit. 2. Other frequency was 20dB below limit line within 1-18GHz, there is not show in the report.		

Frequency (MHz)	Reading Level (dB μ V)	Factor (dB)	Measure Level (dB μ V/m)	Limit (dB μ V/m)	Margin (dB)	Detector	Polarization
7638.5	50.6	-5.1	45.5	74.0	-28.5	Peak	Horizontal
8352.5	49.0	-4.1	44.9	74.0	-29.1	Peak	Horizontal
12237.0	49.8	-2.1	47.7	74.0	-26.3	Peak	Horizontal
8174.0	49.6	-4.3	45.3	74.0	-28.7	Peak	Vertical
11888.5	49.9	-2.4	47.5	74.0	-26.5	Peak	Vertical
15832.5	47.1	4.5	51.6	74.0	-22.4	Peak	Vertical

Note: Measure Level (dB μ V/m) = Reading Level (dB μ V) + Factor (dB)

Factor (dB) = Cable Loss (dB) + Antenna Factor (dB/m) - Pre_Amplifier Gain (dB)

Test Site	SIP-AC3	Test Engineer	Yien Qian
Test Date	2021/08/14	Test Frequency	2404MHz
Test Mode	Half BW		
Remark	1. Average measurement was not performed if peak level lower than average limit. 2. Other frequency was 20dB below limit line within 1-18GHz, there is not show in the report.		

Frequency (MHz)	Reading Level (dB μ V)	Factor (dB)	Measure Level (dB μ V/m)	Limit (dB μ V/m)	Margin (dB)	Detector	Polarization
8216.5	49.5	-4.2	45.3	74.0	-28.7	Peak	Horizontal
12177.5	50.1	-2.3	47.8	74.0	-26.2	Peak	Horizontal
15841.0	47.0	4.5	51.5	74.0	-22.5	Peak	Horizontal
8182.5	51.0	-4.3	46.7	74.0	-27.3	Peak	Vertical
11982.0	50.7	-2.3	48.4	74.0	-25.6	Peak	Vertical
15807.0	47.3	4.2	51.5	74.0	-22.5	Peak	Vertical

Note: Measure Level (dB μ V/m) = Reading Level (dB μ V) + Factor (dB)

Factor (dB) = Cable Loss (dB) + Antenna Factor (dB/m) - Pre_Amplifier Gain (dB)

Test Site	SIP-AC3	Test Engineer	Yien Qian
Test Date	2021/08/14	Test Frequency	2442MHz
Test Mode	Half BW		
Remark	1. Average measurement was not performed if peak level lower than average limit. 2. Other frequency was 20dB below limit line within 1-18GHz, there is not show in the report.		

Frequency (MHz)	Reading Level (dB μ V)	Factor (dB)	Measure Level (dB μ V/m)	Limit (dB μ V/m)	Margin (dB)	Detector	Polarization
7604.5	51.3	-5.2	46.1	74.0	-27.9	Peak	Horizontal
8216.5	51.9	-4.2	47.7	74.0	-26.3	Peak	Horizontal
11642.0	50.5	-2.7	47.8	74.0	-26.2	Peak	Horizontal
8429.0	50.0	-4.2	45.8	74.0	-28.2	Peak	Vertical
12143.5	49.7	-2.3	47.4	74.0	-26.6	Peak	Vertical
15654.0	47.2	3.7	50.9	74.0	-23.1	Peak	Vertical

Note: Measure Level (dB μ V/m) = Reading Level (dB μ V) + Factor (dB)

Factor (dB) = Cable Loss (dB) + Antenna Factor (dB/m) - Pre_Amplifier Gain (dB)

Test Site	SIP-AC3	Test Engineer	Yien Qian
Test Date	2021/08/14	Test Frequency	2478MHz
Test Mode	Half BW		
Remark	1. Average measurement was not performed if peak level lower than average limit. 2. Other frequency was 20dB below limit line within 1-18GHz, there is not show in the report.		

Frequency (MHz)	Reading Level (dB μ V)	Factor (dB)	Measure Level (dB μ V/m)	Limit (dB μ V/m)	Margin (dB)	Detector	Polarization
8276.0	49.7	-4.1	45.6	74.0	-28.4	Peak	Horizontal
12271.0	50.0	-2.4	47.6	74.0	-26.4	Peak	Horizontal
15756.0	47.2	4.4	51.6	74.0	-22.4	Peak	Horizontal
7562.0	48.5	-5.3	43.2	74.0	-30.8	Peak	Vertical
8055.0	50.9	-4.5	46.4	74.0	-27.6	Peak	Vertical
11327.5	50.0	-3.0	47.0	74.0	-27.0	Peak	Vertical

Note: Measure Level (dB μ V/m) = Reading Level (dB μ V) + Factor (dB)

Factor (dB) = Cable Loss (dB) + Antenna Factor (dB/m) - Pre_Amplifier Gain (dB)

The Result of Radiated Emission below 1GHz:

Site: SIP-AC1	Time: 2021/08/11 - 16:52
Limit: FCC_Part15.209_RE(3m)	Engineer: Yien Qian
Probe: SIP-AC1_VULB 9168 _30-1000MHz	Polarity: Horizontal
EUT: Wireless Receiver	Power: AC 120V/60Hz
Test Mode: Transmit by Full Band at Channel 2404MHz	

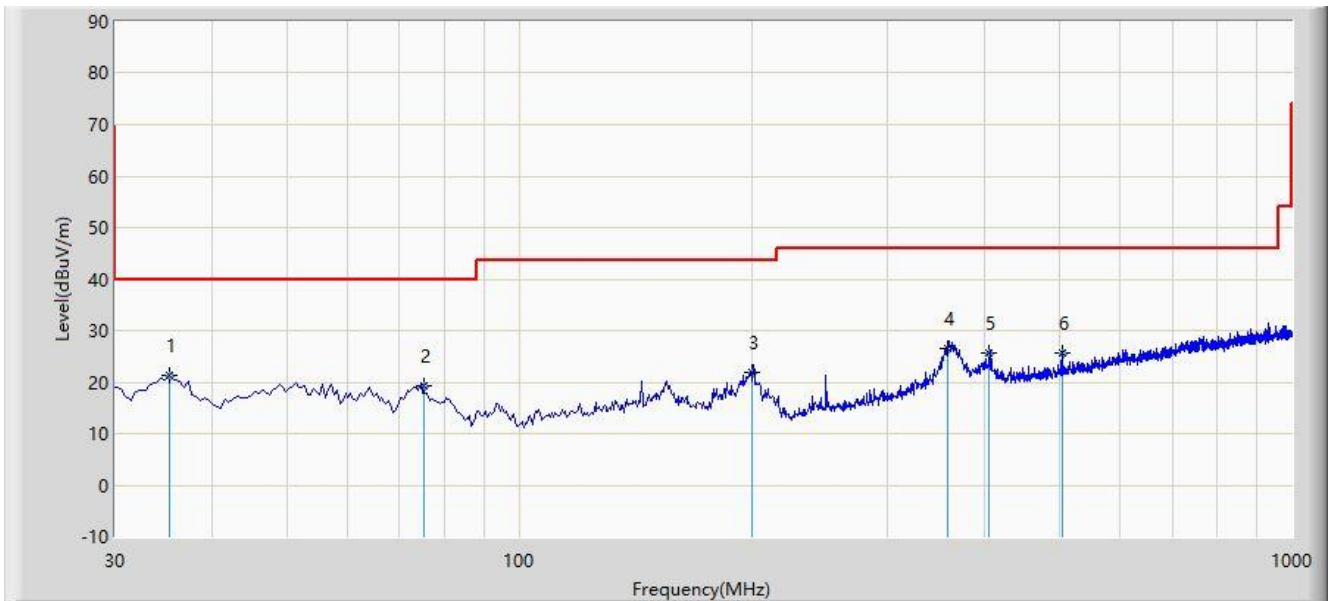

No	Flag	Mark	Frequency (MHz)	Measure Level (dBuV/m)	Reading Level (dBuV)	Margin (dB)	Limit (dBuV/m)	Factor (dB)	Type
1		*	35.241	21.221	4.216	-18.779	40.000	17.005	QP
2			75.163	19.389	4.971	-20.611	40.000	14.417	QP
3			200.316	22.010	7.460	-21.490	43.500	14.551	QP
4			358.490	26.564	7.136	-19.436	46.000	19.428	QP
5			405.167	25.655	4.976	-20.345	46.000	20.679	QP
6			505.316	25.736	2.870	-20.264	46.000	22.866	QP

Note 1: Measure Level (dBuV/m) = Reading Level (dBuV) + Factor (dB)

Factor (dB) = Cable Loss (dB) + Antenna Factor (dB/m)

Note 2: The amplitude of radiated emissions (frequency range from 9kHz to 30MHz and 18GHz to 25GHz) is that proximity to ambient noise, which also are attenuated more than 20 dB below the permissible value.

Therefore, the data is not presented in the report.

Site: SIP-AC1	Time: 2021/08/11 - 17:01
Limit: FCC_Part15.209_RE(3m)	Engineer: Yien Qian
Probe: SIP-AC1_VULB 9168 _30-1000MHz	Polarity: Vertical
EUT: Wireless Receiver	Power: AC 120V/60Hz
Test Mode: Transmit by Full Band at Channel 2404MHz	

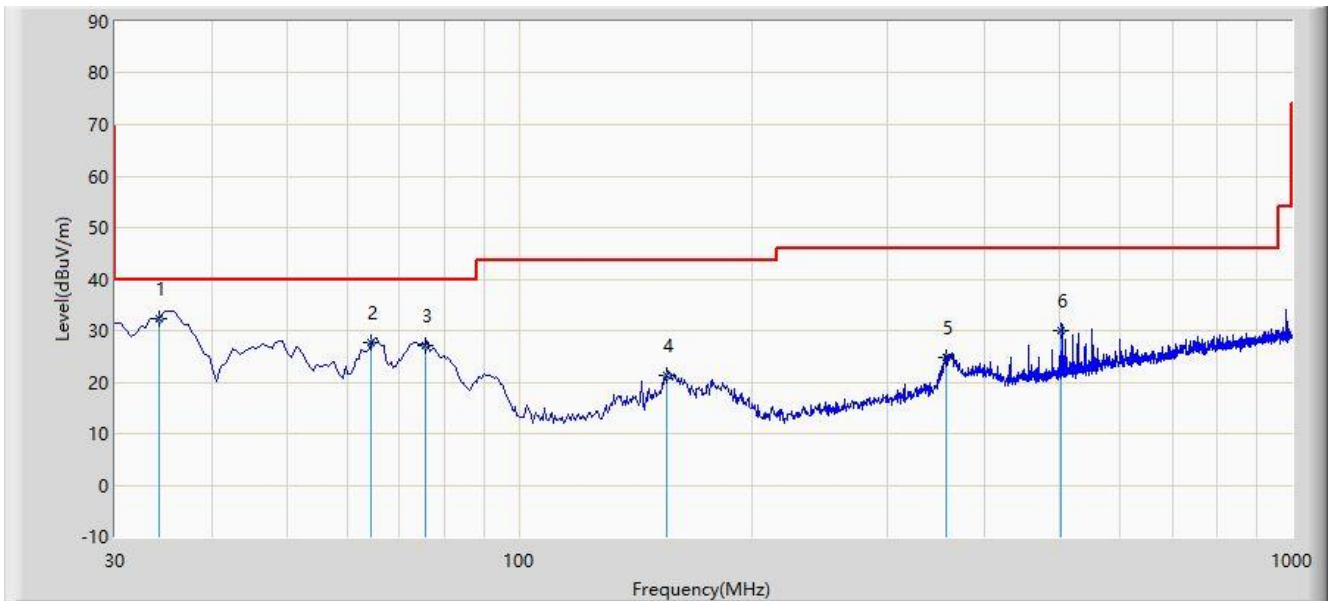

No	Flag	Mark	Frequency (MHz)	Measure Level (dBuV/m)	Reading Level (dBuV)	Margin (dB)	Limit (dBuV/m)	Factor (dB)	Type
1		*	34.278	32.346	15.430	-7.654	40.000	16.916	QP
2			64.210	27.758	11.270	-12.242	40.000	16.488	QP
3			75.641	27.072	12.746	-12.928	40.000	14.325	QP
4			155.260	21.214	3.167	-22.286	43.500	18.047	QP
5			356.220	24.891	5.530	-21.109	46.000	19.360	QP
6			503.234	29.965	7.160	-16.035	46.000	22.805	QP

Note 1: Measure Level (dB μ V/m) = Reading Level (dB μ V) + Factor (dB)

Factor (dB) = Cable Loss (dB) + Antenna Factor (dB/m)

Note 2: The amplitude of radiated emissions (frequency range from 9kHz to 30MHz and 18GHz to 25GHz) is that proximity to ambient noise, which also are attenuated more than 20 dB below the permissible value.

Therefore, the data is not presented in the report.

6.7. Radiated Restricted Band Edge Measurement

6.7.1. Test Limit

For 15.205 requirement:

Radiated emissions which fall in the restricted bands, as defined in Section 15.205(a) of FCC part 15, must also comply with the radiated emission limits specified in Section 15.209(a).

Frequency (MHz)	Frequency (MHz)	Frequency (MHz)	Frequency (GHz)
0.090 - 0.110	16.42 - 16.423	399.9 - 410	4.5 - 5.15
¹ 0.495 - 0.505	16.69475 - 16.69525	608 - 614	5.35 - 5.46
2.1735 - 2.1905	16.80425 - 16.80475	960 - 1240	7.25 - 7.75
4.125 - 4.128	25.5 - 25.67	1300 - 1427	8.025 - 8.5
4.17725 - 4.17775	37.5 - 38.25	1435 - 1626.5	9.0 - 9.2
4.20725 - 4.20775	73 - 74.6	1645.5 - 1646.5	9.3 - 9.5
6.215 - 6.218	74.8 - 75.2	1660 - 1710	10.6 - 12.7
6.26775 - 6.26825	108 - 121.94	1718.8 - 1722.2	13.25 - 13.4
6.31175 - 6.31225	123 - 138	2200 - 2300	14.47 - 14.5
8.291 - 8.294	149.9 - 150.05	2310 - 2390	15.35 - 16.2
8.362 - 8.366	156.52475 - 156.52525	2483.5 - 2500	17.7 - 21.4
8.37625 - 8.38675	156.7 - 156.9	2690 - 2900	22.01 - 23.12
8.41425 - 8.41475	162.0125 - 167.17	3260 - 3267	23.6 - 24.0
12.29 - 12.293	167.72 - 173.2	3332 - 3339	31.2 - 31.8
12.51975 - 12.52025	240 - 285	3345.8 - 3358	36.43 - 36.5
12.57675 - 12.57725	322 - 335.4	3600 - 4400	(²)
13.36 - 13.41	--	--	--

All out of band emissions appearing in a restricted band as specified in Section 15.205 of the Title 47CFR must not exceed the limits shown in Table per Section 15.209.

FCC Part 15 Subpart C Paragraph 15.209		
Frequency [MHz]	Field Strength [uV/m]	Measured Distance [Meters]
0.009 - 0.490	2400/F (kHz)	300
0.490 - 1.705	24000/F (kHz)	30
1.705 - 30	30	30
30 - 88	100	3
88 - 216	150	3
216 - 960	200	3
Above 960	500	3

6.7.2. Test Procedure Used

ANSI C63.10-2013 Section 6.3

ANSI C63.10-2013 Section 6.6

ANSI C63.10-2013 Section 11.13

6.7.3. Test Setting

Peak Field Strength Measurements

1. Analyzer center frequency was set to the frequency of the radiated spurious emission of interest
2. RBW = 1MHz
3. VBW = 3MHz
4. Detector = peak
5. Sweep time = auto couple
6. Trace mode = max hold
7. Trace was allowed to stabilize

Average Field Strength Measurements

1. Analyzer center frequency was set to the frequency of the radiated spurious emission of interest
2. RBW = 1MHz
3. VBW $\geq 1/T$
4. As an alternative, the instrument may be set to linear detector mode. Ensure that video filtering is applied in linear voltage domain (rather than in a log or dB domain). Some instruments require linear display mode in order to accomplish this. Others have a setting for Average-VBW Type, which can be set to "Voltage" regardless of the display mode
5. Detector = Peak
6. Sweep time = auto
7. Trace mode = max hold
8. Allow max hold to run for at least 50 times (1/duty cycle) traces

6.7.4. Test Setup

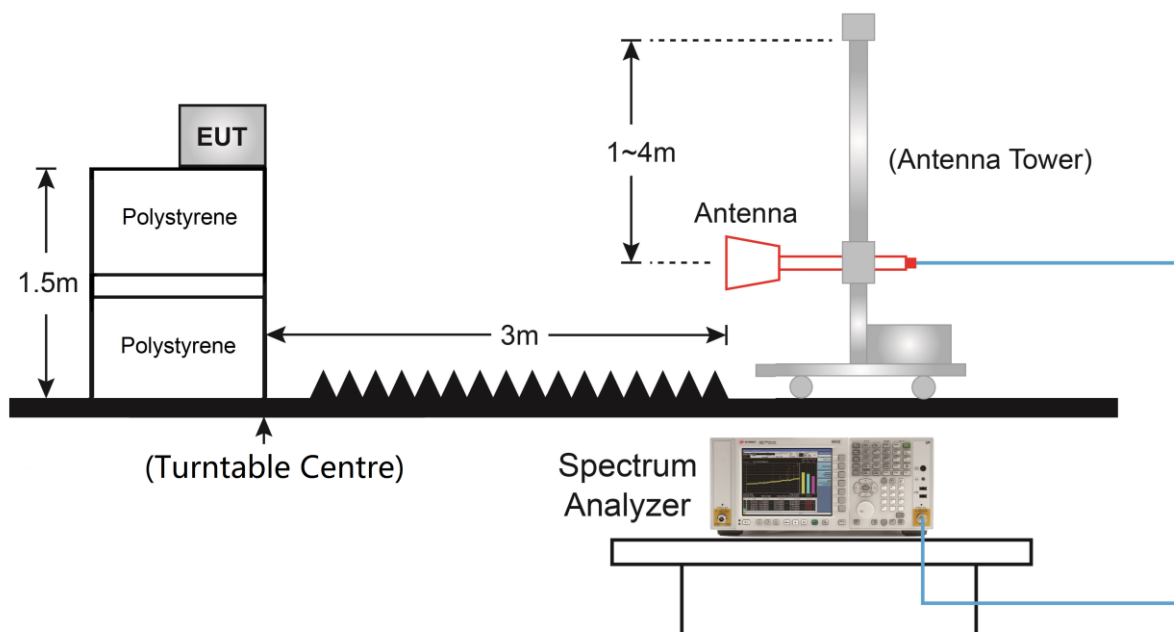

6.7.5. Test Result

Site: SIP-AC3	Time: 2021/08/14 - 15:22
Limit: FCC_Part15.209 RE(3m)	Engineer: Yien Qian
Probe: SIP-AC3_HF907_102861_1-18GHz	Polarity: Horizontal
EUT: Wireless Receiver	Power: AC 120V/60Hz
Test Mode: Transmit by Full Band at Channel 2404MHz	

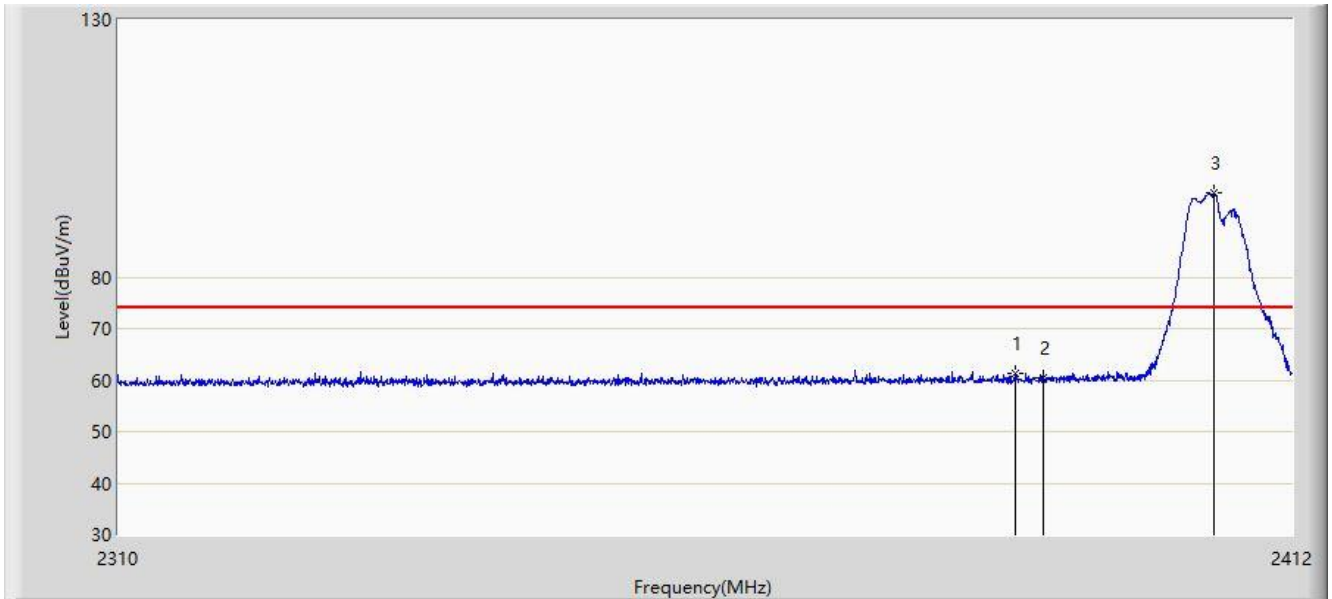

No	Flag	Mark	Frequency (MHz)	Measure Level (dBuV/m)	Reading Level (dBuV)	Margin (dB)	Limit (dBuV/m)	Factor (dB/m)	Type
1			2387.622	61.276	29.024	-12.724	74.000	32.252	PK
2			2390.000	60.473	28.208	-13.527	74.000	32.265	PK
3		*	2405.064	96.245	63.902	N/A	N/A	32.343	PK

Note: Measure Level (dB μ V/m) = Reading Level (dB μ V) + Factor (dB)

Factor (dB) = Cable Loss (dB) + Antenna Factor (dB/m).

Site: SIP-AC3	Time: 2021/08/14 - 15:44
Limit: FCC_Part15.209 RE(3m)	Engineer: Yien Qian
Probe: SIP-AC3_HF907_102861_1-18GHz	Polarity: Horizontal
EUT: Wireless Receiver	Power: AC 120V/60Hz
Test Mode: Transmit by Full Band at Channel 2404MHz	

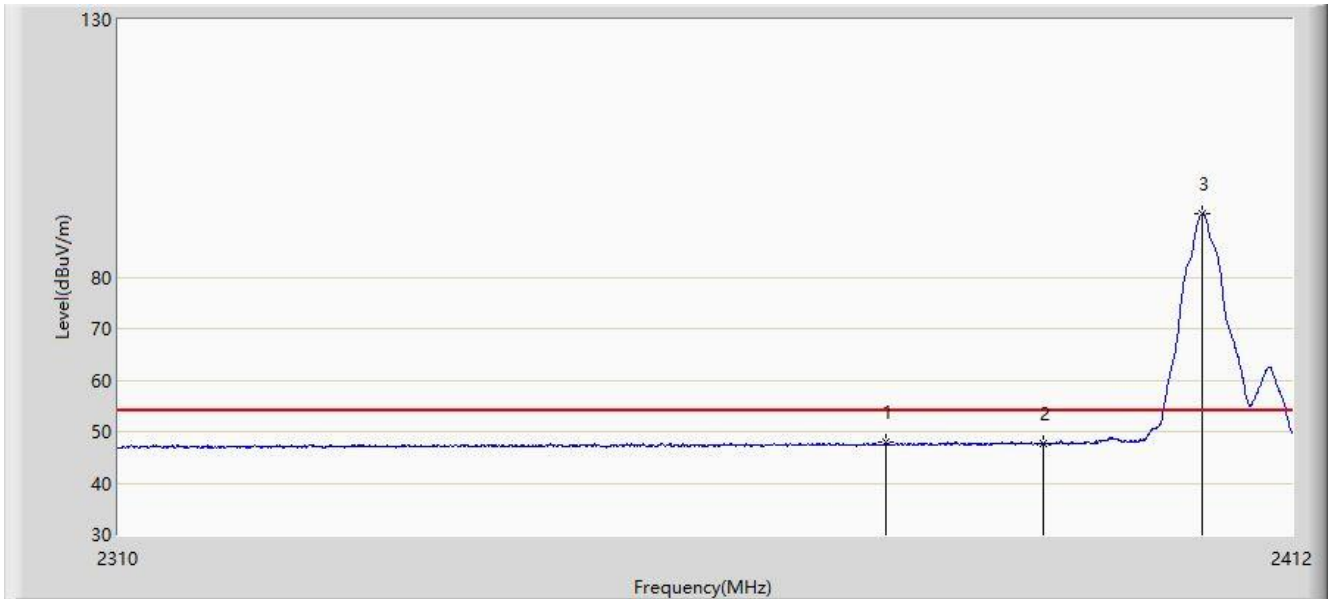

No	Flag	Mark	Frequency (MHz)	Measure Level (dBuV/m)	Reading Level (dBuV)	Margin (dB)	Limit (dBuV/m)	Factor (dB/m)	Type
1			2376.198	47.860	15.667	-6.140	54.000	32.192	AV
2			2390.000	47.660	15.395	-6.340	54.000	32.265	AV
3		*	2404.044	92.358	60.020	N/A	N/A	32.337	AV

Note: Measure Level (dB μ V/m) = Reading Level (dB μ V) + Factor (dB)

Factor (dB) = Cable Loss (dB) + Antenna Factor (dB/m).

Site: SIP-AC3	Time: 2021/08/14 - 15:48
Limit: FCC_Part15.209 RE(3m)	Engineer: Yien Qian
Probe: SIP-AC3_HF907_102861_1-18GHz	Polarity: Vertical
EUT: Wireless Receiver	Power: AC 120V/60Hz
Test Mode: Transmit by Full Band at Channel 2404MHz	

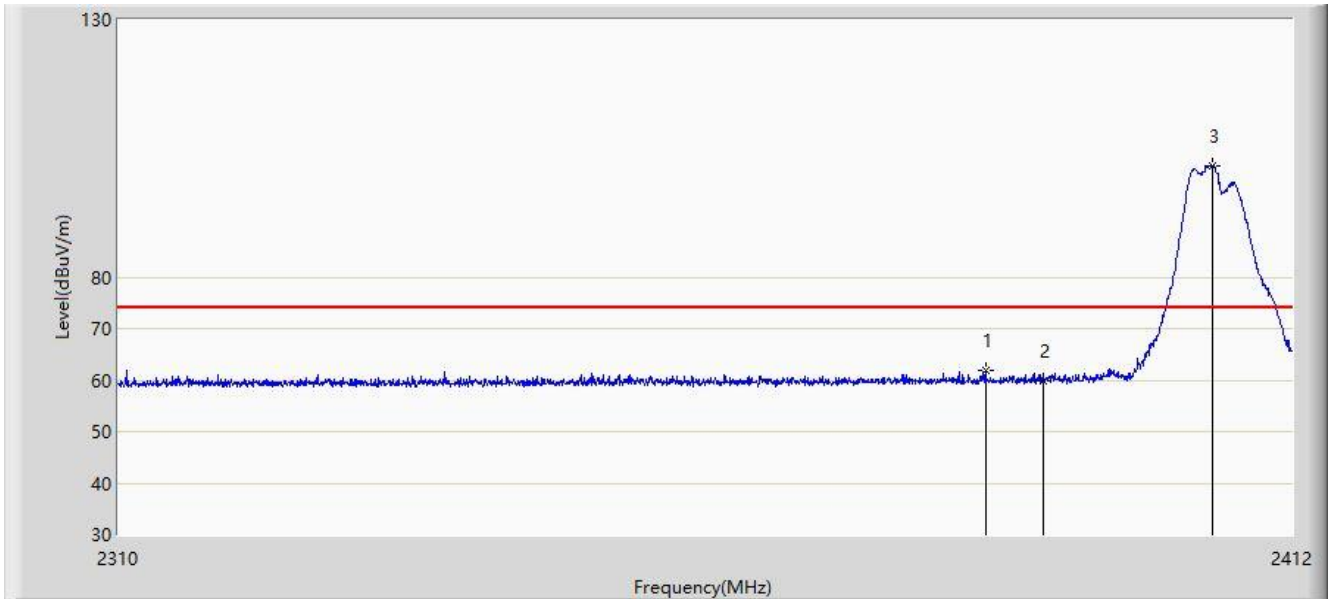

No	Flag	Mark	Frequency (MHz)	Measure Level (dBuV/m)	Reading Level (dBuV)	Margin (dB)	Limit (dBuV/m)	Factor (dB/m)	Type
1			2384.970	61.909	29.671	-12.091	74.000	32.237	PK
2			2390.000	59.836	27.571	-14.164	74.000	32.265	PK
3		*	2404.962	101.724	69.382	N/A	N/A	32.343	PK

Note: Measure Level (dB μ V/m) = Reading Level (dB μ V) + Factor (dB)

Factor (dB) = Cable Loss (dB) + Antenna Factor (dB/m).

Site: SIP-AC3	Time: 2021/08/14 - 15:51
Limit: FCC_Part15.209 RE(3m)	Engineer: Yien Qian
Probe: SIP-AC3_HF907_102861_1-18GHz	Polarity: Vertical
EUT: Wireless Receiver	Power: AC 120V/60Hz
Test Mode: Transmit by Full Band at Channel 2404MHz	

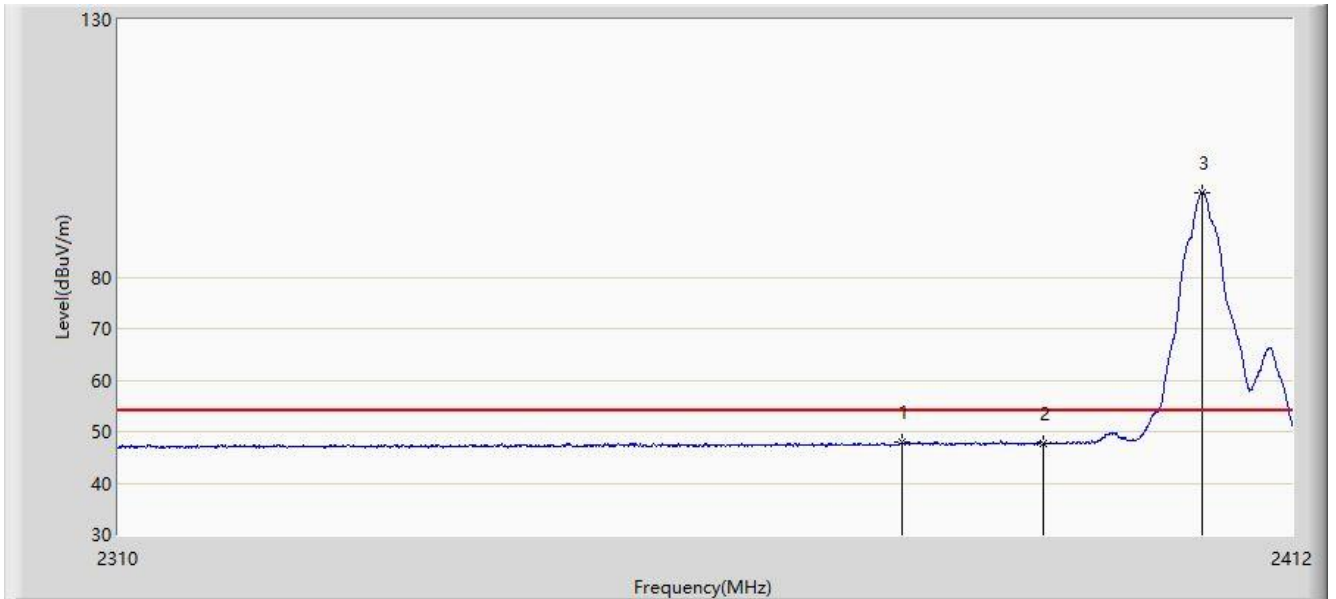

No	Flag	Mark	Frequency (MHz)	Measure Level (dBuV/m)	Reading Level (dBuV)	Margin (dB)	Limit (dBuV/m)	Factor (dB/m)	Type
1			2377.626	47.929	15.732	-6.071	54.000	32.197	AV
2			2390.000	47.699	15.434	-6.301	54.000	32.265	AV
3		*	2403.993	96.325	63.987	N/A	N/A	32.337	AV

Note: Measure Level (dB μ V/m) = Reading Level (dB μ V) + Factor (dB)

Factor (dB) = Cable Loss (dB) + Antenna Factor (dB/m).

Site: SIP-AC3	Time: 2021/08/14 - 15:57
Limit: FCC_Part15.209 RE(3m)	Engineer: Yien Qian
Probe: SIP-AC3_HF907_102861_1-18GHz	Polarity: Horizontal
EUT: Wireless Receiver	Power: AC 120V/60Hz
Test Mode: Transmit by Full Band at Channel 2478MHz	

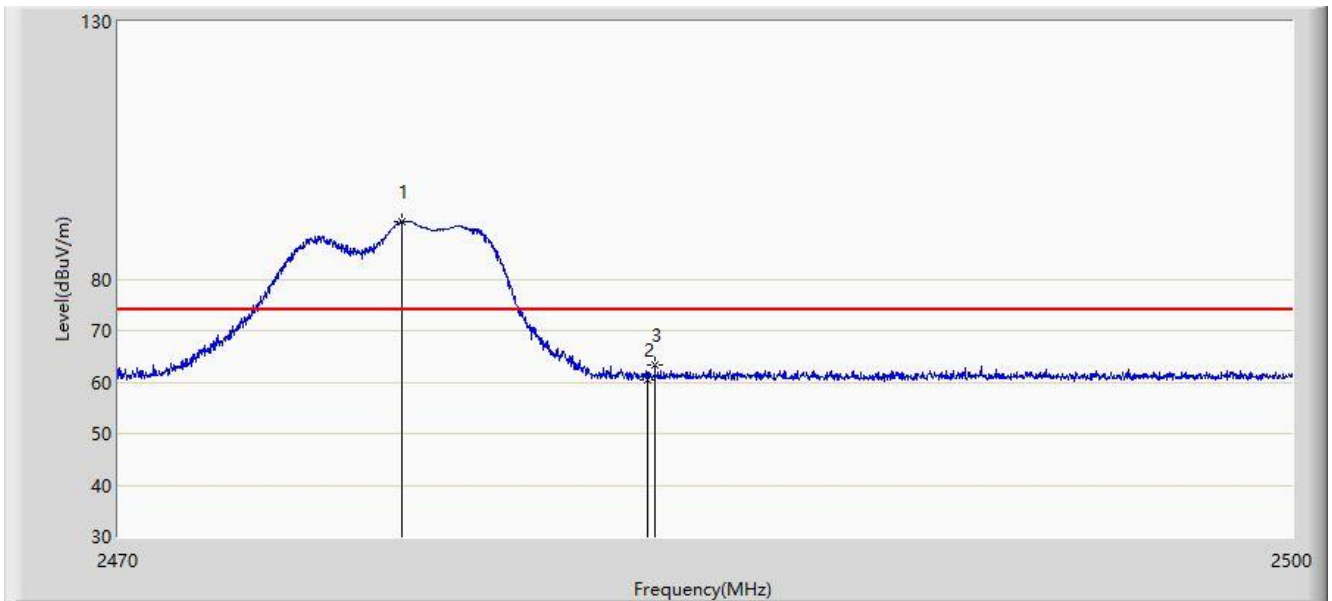

No	Flag	Mark	Frequency (MHz)	Measure Level (dBuV/m)	Reading Level (dBuV)	Margin (dB)	Limit (dBuV/m)	Factor (dB/m)	Type
1		*	2477.215	91.053	58.319	N/A	N/A	32.734	PK
2			2483.500	60.506	27.734	-13.494	74.000	32.772	PK
3			2483.680	63.423	30.650	-10.577	74.000	32.773	PK

Note: Measure Level (dB μ V/m) = Reading Level (dB μ V) + Factor (dB)

Factor (dB) = Cable Loss (dB) + Antenna Factor (dB/m).

Site: SIP-AC3	Time: 2021/08/14 - 16:00
Limit: FCC_Part15.209 RE(3m)	Engineer: Yien Qian
Probe:	Polarity: Horizontal
EUT: Wireless Receiver	Power: AC 120V/60Hz
Test Mode: Transmit by Full Band at Channel 2478MHz	

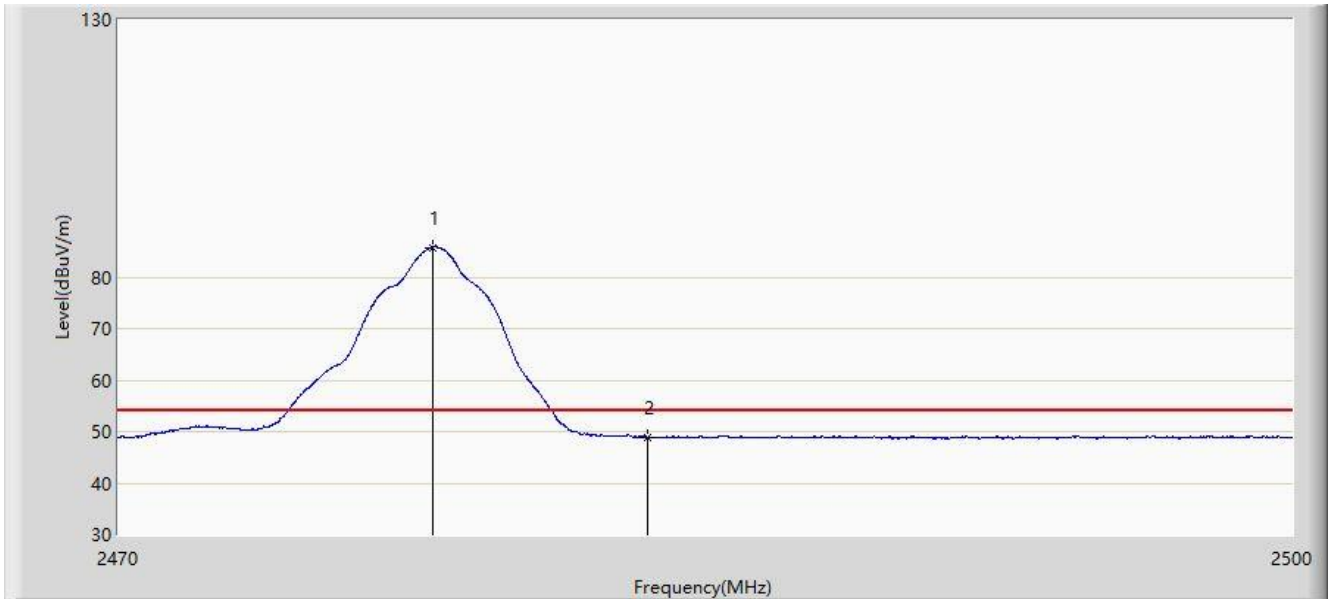

No	Flag	Mark	Frequency (MHz)	Measure Level (dBuV/m)	Reading Level (dBuV)	Margin (dB)	Limit (dBuV/m)	Factor (dB/m)	Type
1		*	2478.025	85.797	53.058	N/A	N/A	32.739	AV
2			2483.500	48.831	16.059	-5.169	54.000	32.772	AV

Note: Measure Level (dB μ V/m) = Reading Level (dB μ V) + Factor (dB)

Factor (dB) = Cable Loss (dB) + Antenna Factor (dB/m).

Site: SIP-AC3	Time: 2021/08/14 - 15:52
Limit: FCC_Part15.209 RE(3m)	Engineer: Yien Qian
Probe: SIP-AC3_HF907_102861_1-18GHz	Polarity: Vertical
EUT: Wireless Receiver	Power: AC 120V/60Hz
Test Mode: Transmit by Full Band at Channel 2478MHz	

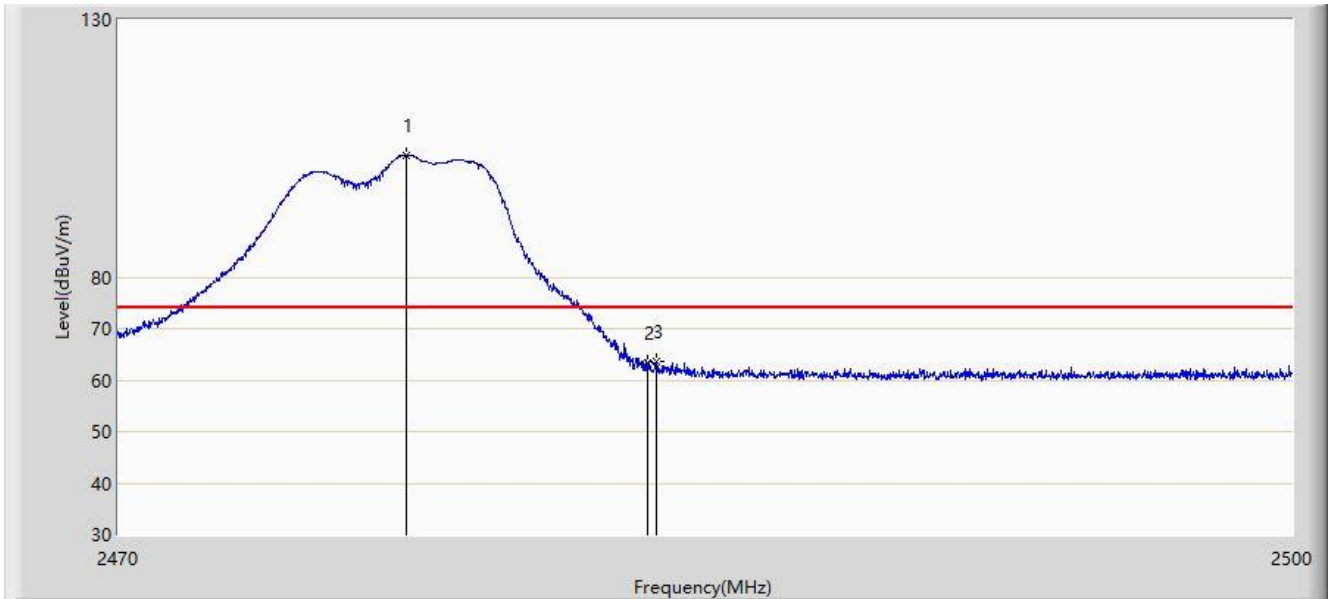

No	Flag	Mark	Frequency (MHz)	Measure Level (dBuV/m)	Reading Level (dBuV)	Margin (dB)	Limit (dBuV/m)	Factor (dB/m)	Type
1		*	2477.320	103.700	70.966	N/A	N/A	32.734	PK
2			2483.500	63.465	30.693	-10.535	74.000	32.772	PK
3			2483.710	63.626	30.853	-10.374	74.000	32.773	PK

Note: Measure Level (dB μ V/m) = Reading Level (dB μ V) + Factor (dB)

Factor (dB) = Cable Loss (dB) + Antenna Factor (dB/m).

Site: SIP-AC3	Time: 2021/08/14 - 15:56
Limit: FCC_Part15.209 RE(3m)	Engineer: Yien Qian
Probe: SIP-AC3_HF907_102861_1-18GHz	Polarity: Vertical
EUT: Wireless Receiver	Power: AC 120V/60Hz
Test Mode: Transmit by Full Band at Channel 2478MHz	

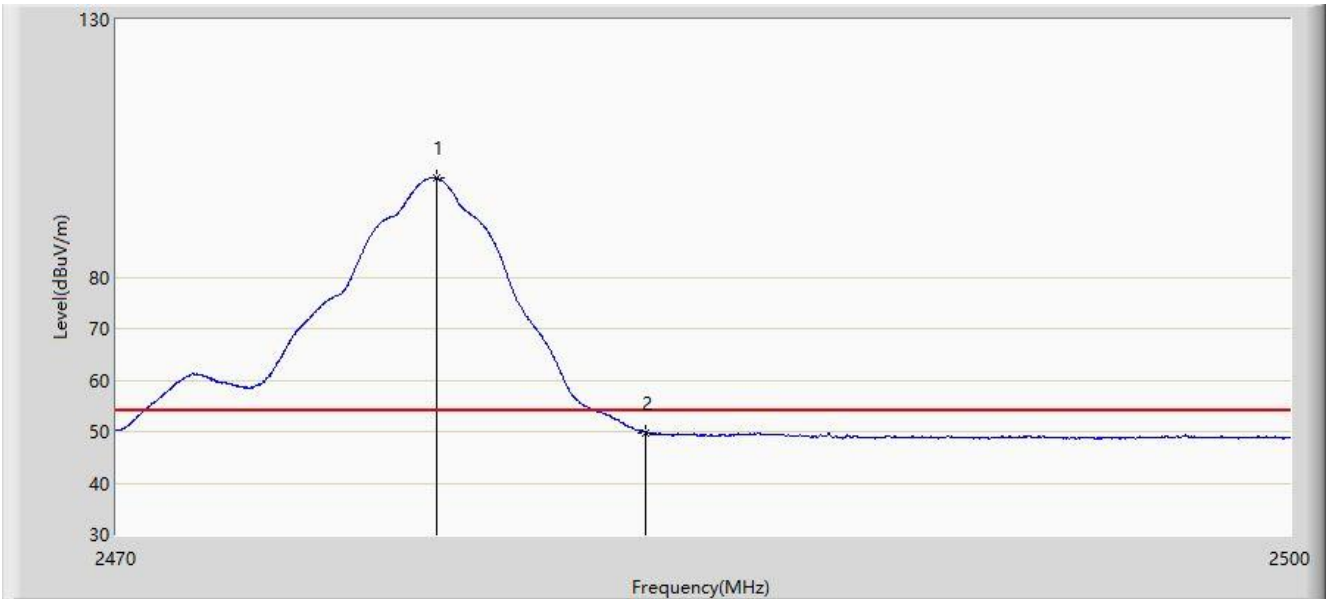

No	Flag	Mark	Frequency (MHz)	Measure Level (dBuV/m)	Reading Level (dBuV)	Margin (dB)	Limit (dBuV/m)	Factor (dB/m)	Type
1		*	2478.160	99.198	66.458	N/A	N/A	32.740	AV
2			2483.500	49.819	17.047	-4.181	54.000	32.772	AV

Note: Measure Level (dB μ V/m) = Reading Level (dB μ V) + Factor (dB)

Factor (dB) = Cable Loss (dB) + Antenna Factor (dB/m).

Site: SIP-AC3	Time: 2021/08/14 - 16:02
Limit: FCC_Part15.209 RE(3m)	Engineer: Yien Qian
Probe: SIP-AC3_HF907_102861_1-18GHz	Polarity: Horizontal
EUT: Wireless Receiver	Power: AC 120V/60Hz
Test Mode: Transmit by Half Band at Channel 2404MHz	

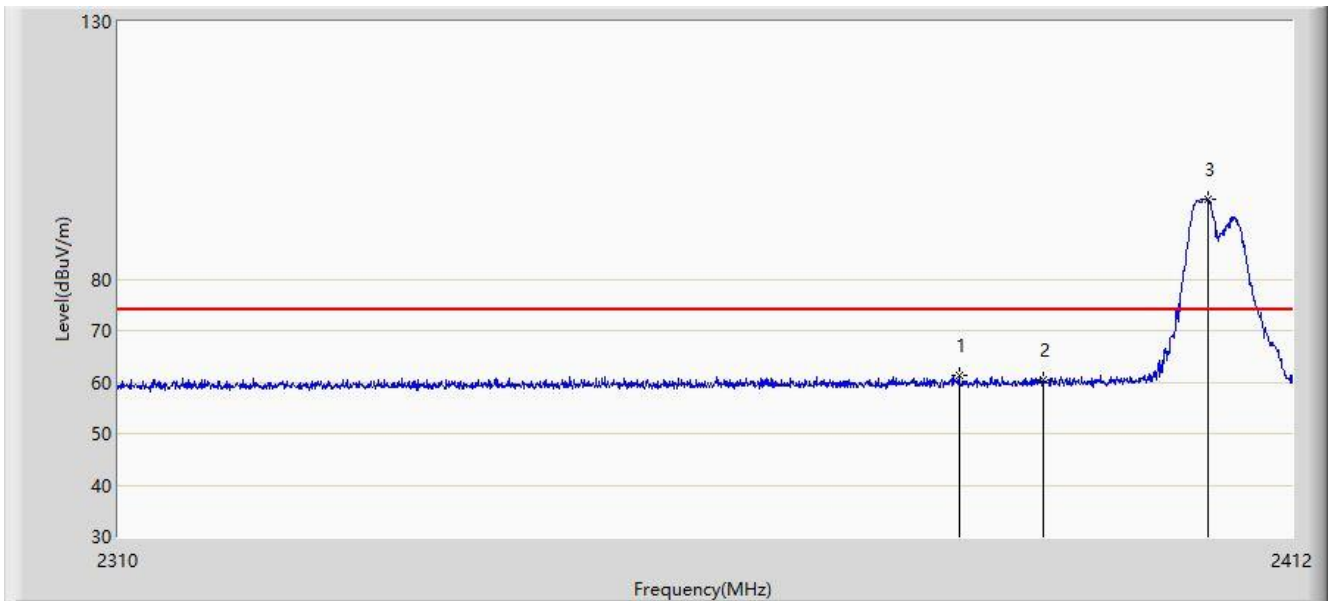

No	Flag	Mark	Frequency (MHz)	Measure Level (dBuV/m)	Reading Level (dBuV)	Margin (dB)	Limit (dBuV/m)	Factor (dB/m)	Type
1			2382.624	61.218	28.993	-12.782	74.000	32.225	PK
2			2390.000	60.415	28.150	-13.585	74.000	32.265	PK
3		*	2404.605	95.488	63.147	N/A	N/A	32.341	PK

Note: Measure Level (dB μ V/m) = Reading Level (dB μ V) + Factor (dB)

Factor (dB) = Cable Loss (dB) + Antenna Factor (dB/m).

Site: SIP-AC3	Time: 2021/08/14 - 16:04
Limit: FCC_Part15.209 RE(3m)	Engineer: Yien Qian
Probe: SIP-AC3_HF907_102861_1-18GHz	Polarity: Horizontal
EUT: Wireless Receiver	Power: AC 120V/60Hz
Test Mode: Transmit by Half Band at Channel 2404MHz	

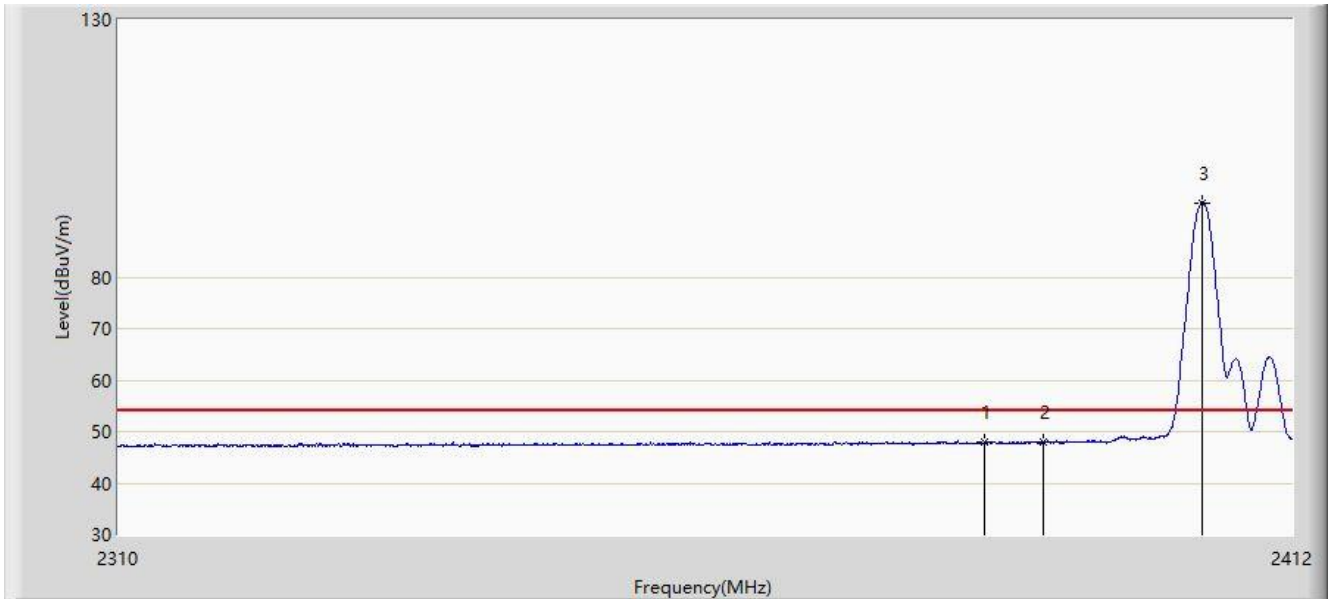

No	Flag	Mark	Frequency (MHz)	Measure Level (dBuV/m)	Reading Level (dBuV)	Margin (dB)	Limit (dBuV/m)	Factor (dB/m)	Type
1			2384.919	48.105	15.868	-5.895	54.000	32.237	AV
2			2390.000	48.031	15.766	-5.969	54.000	32.265	AV
3		*	2403.993	94.452	62.114	N/A	N/A	32.337	AV

Note: Measure Level (dB μ V/m) = Reading Level (dB μ V) + Factor (dB)

Factor (dB) = Cable Loss (dB) + Antenna Factor (dB/m).

Site: SIP-AC3	Time: 2021/08/14 - 16:05
Limit: FCC_Part15.209 RE(3m)	Engineer: Yien Qian
Probe: SIP-AC3_HF907_102861_1-18GHz	Polarity: Vertical
EUT: Wireless Receiver	Power: AC 120V/60Hz
Test Mode: Transmit by Half Band at Channel 2404MHz	

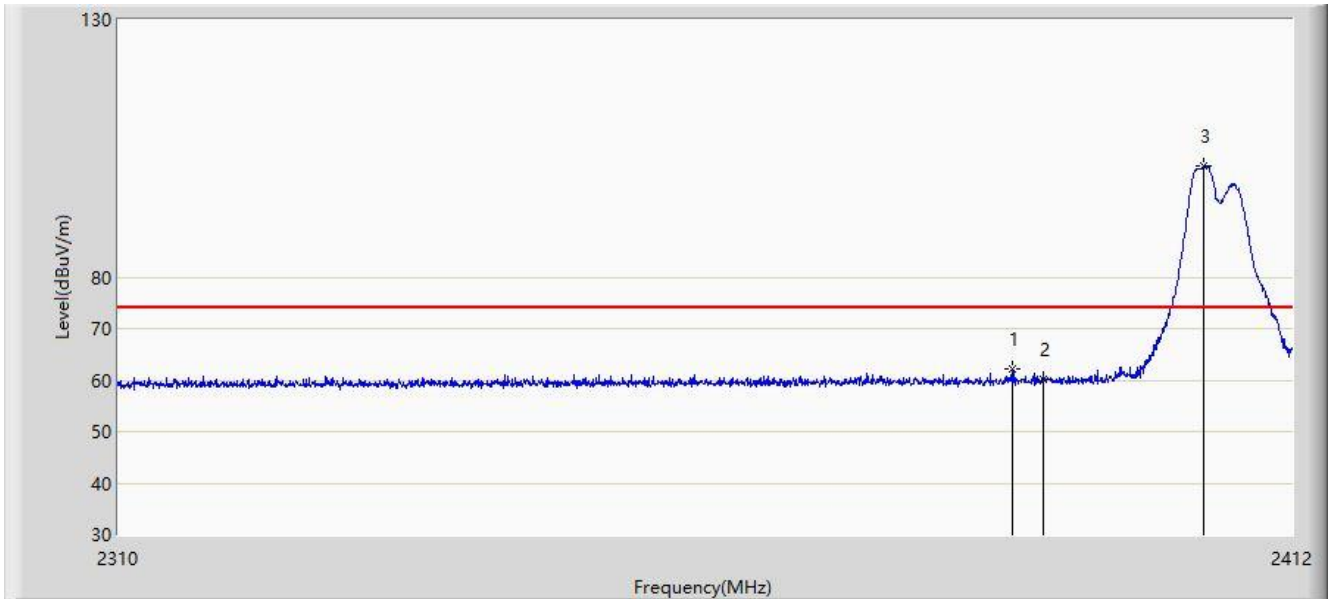

No	Flag	Mark	Frequency (MHz)	Measure Level (dBuV/m)	Reading Level (dBuV)	Margin (dB)	Limit (dBuV/m)	Factor (dB/m)	Type
1			2387.265	62.196	29.946	-11.804	74.000	32.250	PK
2			2390.000	60.170	27.905	-13.830	74.000	32.265	PK
3		*	2404.197	101.473	69.134	N/A	N/A	32.338	PK

Note: Measure Level (dB μ V/m) = Reading Level (dB μ V) + Factor (dB)

Factor (dB) = Cable Loss (dB) + Antenna Factor (dB/m).

Site: SIP-AC3	Time: 2021/08/14 - 16:07
Limit: FCC_Part15.209 RE(3m)	Engineer: Yien Qian
Probe: SIP-AC3_HF907_102861_1-18GHz	Polarity: Vertical
EUT: Wireless Receiver	Power: AC 120V/60Hz
Test Mode: Transmit by Half Band at Channel 2404MHz	

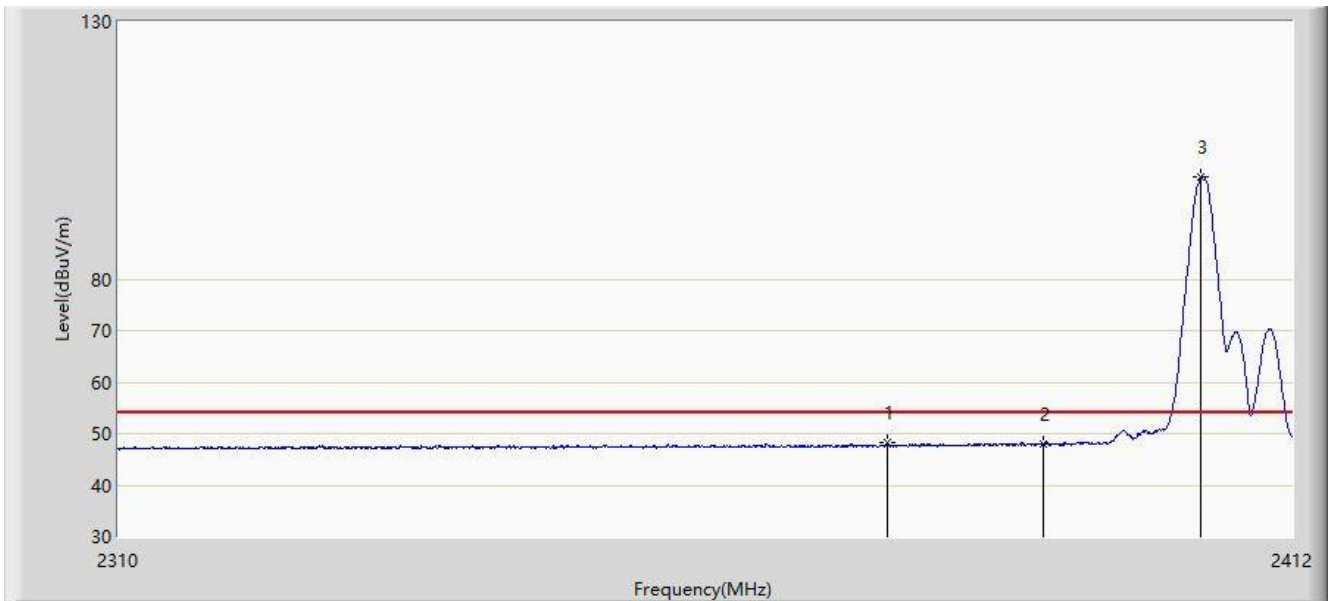

No	Flag	Mark	Frequency (MHz)	Measure Level (dBuV/m)	Reading Level (dBuV)	Margin (dB)	Limit (dBuV/m)	Factor (dB/m)	Type
1			2376.300	48.170	15.977	-5.830	54.000	32.192	AV
2			2390.000	48.059	15.794	-5.941	54.000	32.265	AV
3		*	2403.942	99.765	67.428	N/A	N/A	32.337	AV

Note: Measure Level (dB μ V/m) = Reading Level (dB μ V) + Factor (dB)

Factor (dB) = Cable Loss (dB) + Antenna Factor (dB/m).

Site: SIP-AC3	Time: 2021/08/14 - 16:09
Limit: FCC_Part15.209 RE(3m)	Engineer: Yien Qian
Probe: SIP-AC3_HF907_102861_1-18GHz	Polarity: Horizontal
EUT: Wireless Receiver	Power: AC 120V/60Hz
Test Mode: Transmit by Half Band at Channel 2478MHz	

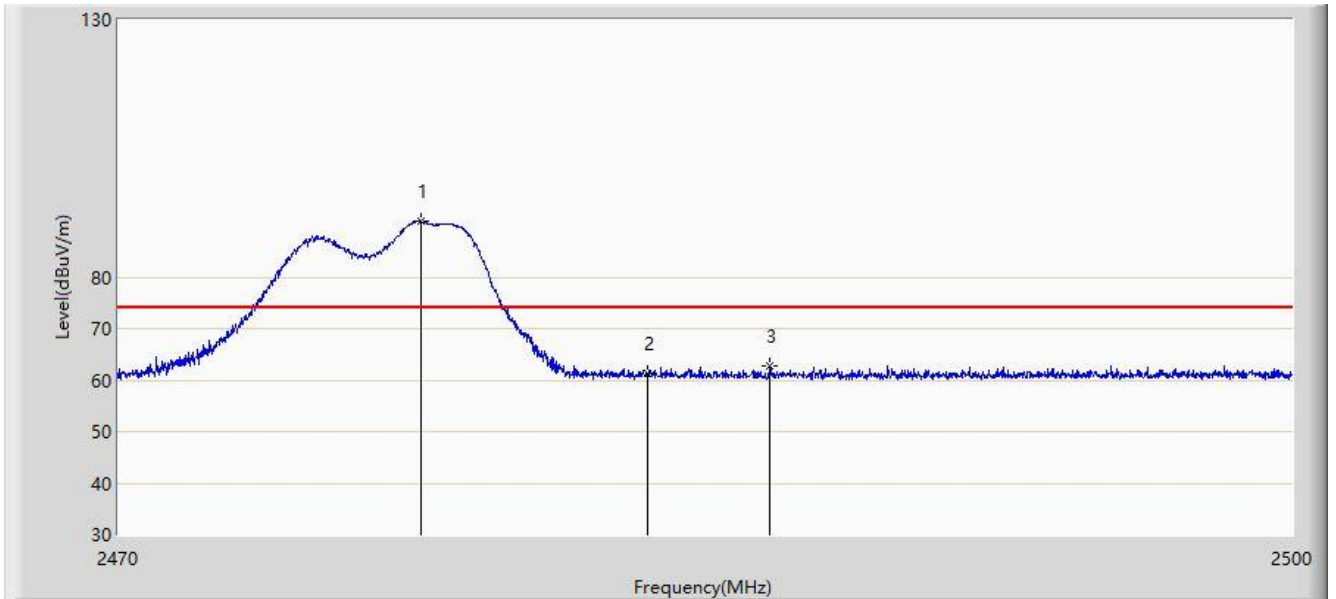

No	Flag	Mark	Frequency (MHz)	Measure Level (dBuV/m)	Reading Level (dBuV)	Margin (dB)	Limit (dBuV/m)	Factor (dB/m)	Type
1		*	2477.695	90.797	58.060	N/A	N/A	32.737	PK
2			2483.500	61.425	28.653	-12.575	74.000	32.772	PK
3			2486.620	62.824	30.034	-11.176	74.000	32.790	PK

Note: Measure Level (dB μ V/m) = Reading Level (dB μ V) + Factor (dB)

Factor (dB) = Cable Loss (dB) + Antenna Factor (dB/m).

Site: SIP-AC3	Time: 2021/08/14 - 16:12
Limit: FCC_Part15.209 RE(3m)	Engineer: Yien Qian
Probe: SIP-AC3_HF907_102861_1-18GHz	Polarity: Horizontal
EUT: Wireless Receiver	Power: AC 120V/60Hz
Test Mode: Transmit by Half Band at Channel 2478MHz	

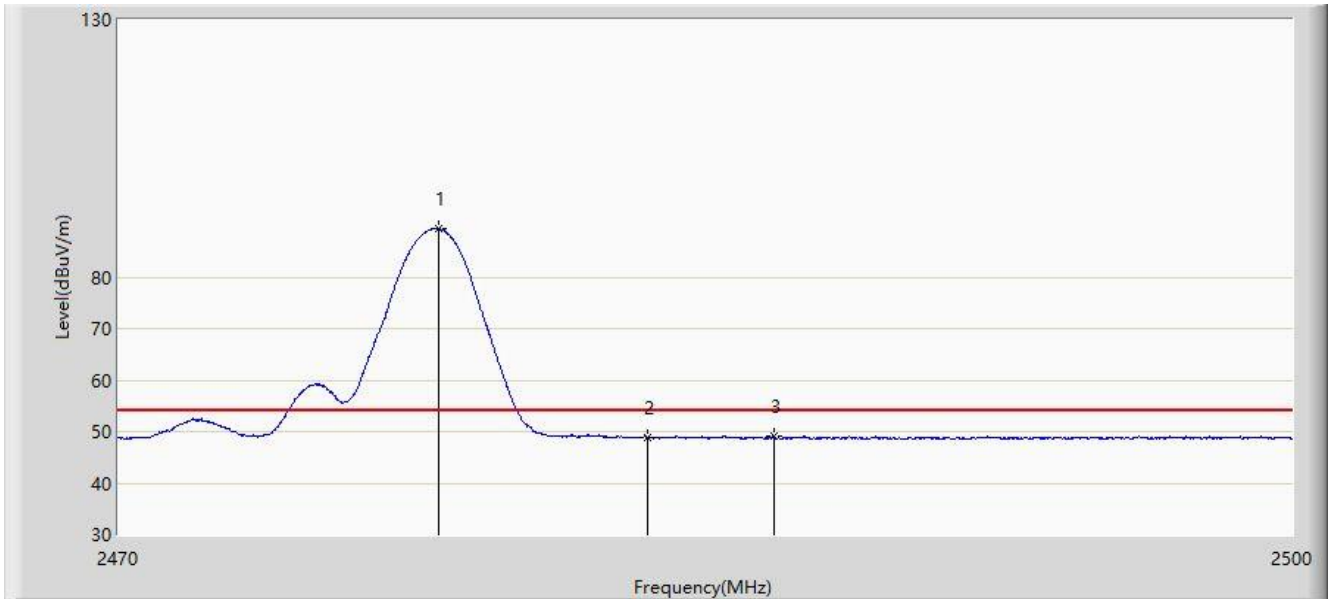

No	Flag	Mark	Frequency (MHz)	Measure Level (dBuV/m)	Reading Level (dBuV)	Margin (dB)	Limit (dBuV/m)	Factor (dB/m)	Type
1		*	2478.160	89.405	56.665	N/A	N/A	32.740	AV
2			2483.500	48.891	16.119	-5.109	54.000	32.772	AV
3			2486.710	49.141	16.350	-4.859	54.000	32.790	AV

Note: Measure Level (dB μ V/m) = Reading Level (dB μ V) + Factor (dB)

Factor (dB) = Cable Loss (dB) + Antenna Factor (dB/m).

Site: SIP-AC3	Time: 2021/08/14 - 16:12
Limit: FCC_Part15.209 RE(3m)	Engineer: Yien Qian
Probe: SIP-AC3_HF907_102861_1-18GHz	Polarity: Vertical
EUT: Wireless Receiver	Power: AC 120V/60Hz
Test Mode: Transmit by Half Band at Channel 2478MHz	

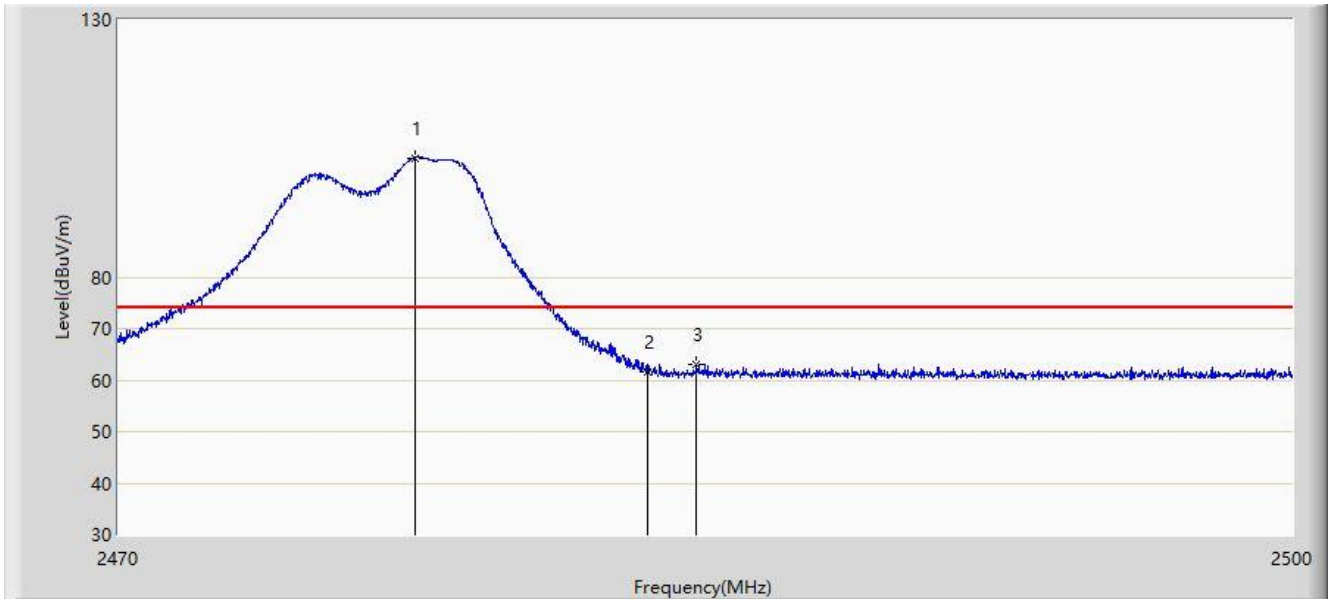

No	Flag	Mark	Frequency (MHz)	Measure Level (dBuV/m)	Reading Level (dBuV)	Margin (dB)	Limit (dBuV/m)	Factor (dB/m)	Type
1		*	2477.545	103.148	70.412	N/A	N/A	32.736	PK
2			2483.500	61.479	28.707	-12.521	74.000	32.772	PK
3			2484.745	63.005	30.226	-10.995	74.000	32.779	PK

Note: Measure Level (dB μ V/m) = Reading Level (dB μ V) + Factor (dB)

Factor (dB) = Cable Loss (dB) + Antenna Factor (dB/m).

Site: SIP-AC3	Time: 2021/08/14 - 16:15
Limit: FCC_Part15.209 RE(3m)	Engineer: Yien Qian
Probe: SIP-AC3_HF907_102861_1-18GHz	Polarity: Vertical
EUT: Wireless Receiver	Power: AC 120V/60Hz
Test Mode: Transmit by Half Band at Channel 2478MHz	

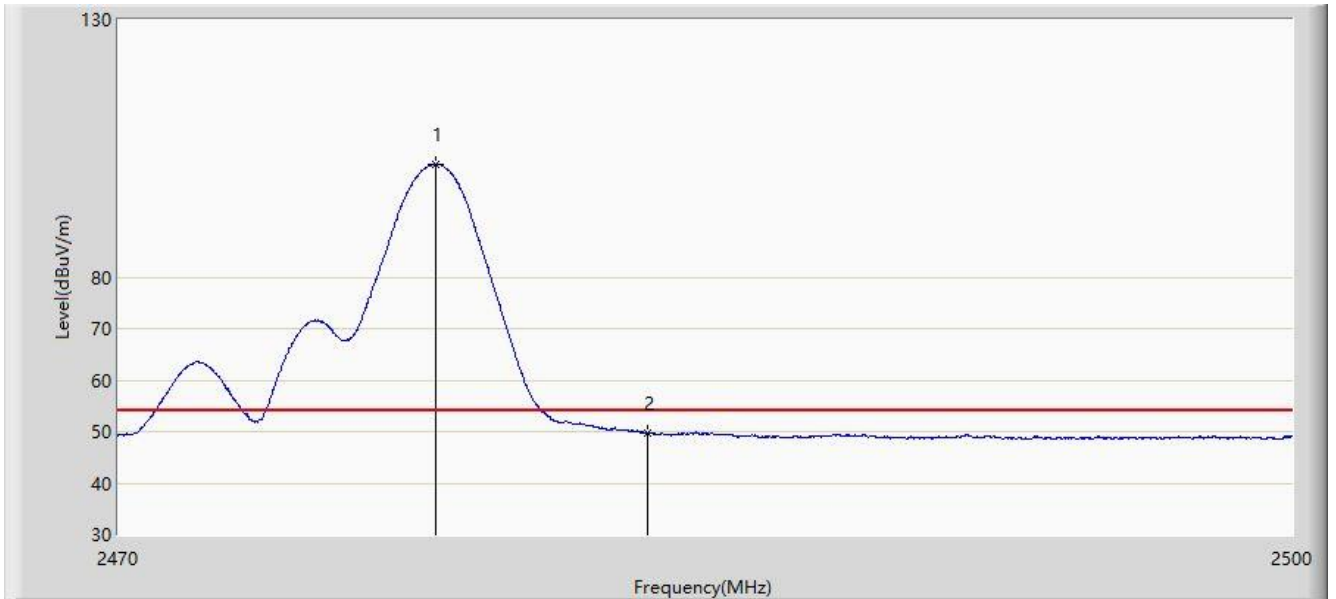

No	Flag	Mark	Frequency (MHz)	Measure Level (dBuV/m)	Reading Level (dBuV)	Margin (dB)	Limit (dBuV/m)	Factor (dB/m)	Type
1		*	2478.070	101.862	69.123	N/A	N/A	32.739	AV
2			2483.500	49.755	16.983	-4.245	54.000	32.772	AV

Note: Measure Level (dB μ V/m) = Reading Level (dB μ V) + Factor (dB)

Factor (dB) = Cable Loss (dB) + Antenna Factor (dB/m).

6.8. AC Conducted Emissions Measurement

6.8.1. Test Limit

FCC Part 15 Subpart C Paragraph 15.207 Limits		
Frequency (MHz)	QP (dBuV)	AV (dBuV)
0.15 - 0.50	66 - 56	56 - 46
0.50 - 5.0	56	46
5.0 - 30	60	50

Note 1: The lower limit shall apply at the transition frequencies.

Note 2: The limit decreases linearly with the logarithm of the frequency in the range 0.15MHz to 0.5MHz.

6.8.2. Test Setup

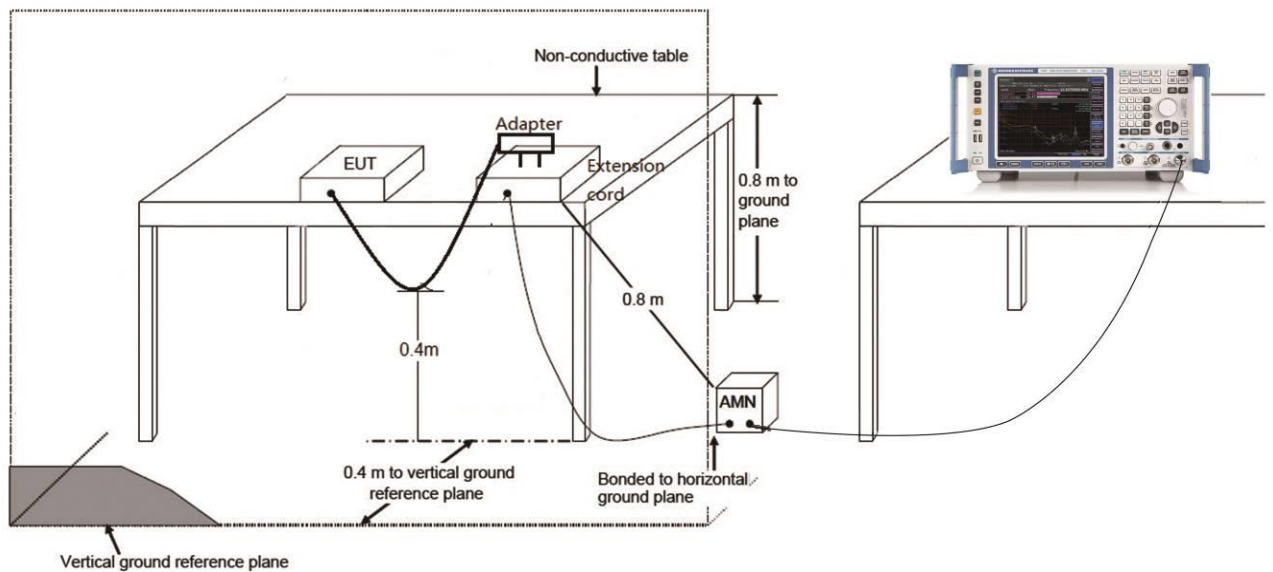

6.8.3. Test Result

Site: SIP-SR2	Time: 2021/08/10 - 15:41
Limit: FCC_Part15.207_CE_AC Power	Engineer: Rupert Wang
Probe: SIP-SR2-ENV216_101684_C	Polarity: Neutral
EUT: Wireless Receiver	Power: AC 120V/60Hz
Test Mode: Transmit	

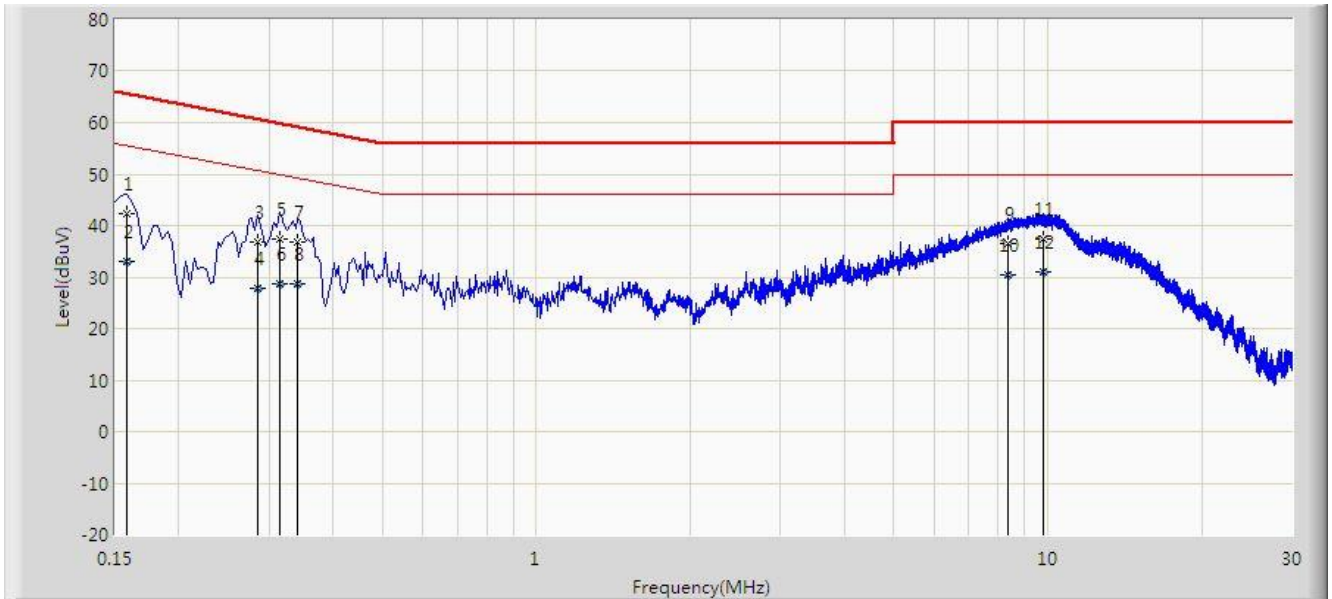

No	Flag	Mark	Frequency (MHz)	Measure Level (dBuV)	Reading Level (dBuV)	Margin (dB)	Limit (dBuV)	Factor (dB)	Type
1			0.158	42.385	32.746	-23.184	65.568	9.638	QP
2			0.158	33.019	23.380	-22.550	55.568	9.638	AV
3			0.286	36.812	27.117	-23.828	60.640	9.696	QP
4			0.286	27.757	18.061	-22.883	50.640	9.696	AV
5			0.314	37.530	27.825	-22.334	59.864	9.705	QP
6			0.314	28.770	19.065	-21.094	49.864	9.705	AV
7			0.342	36.764	27.059	-22.390	59.155	9.706	QP
8			0.342	28.697	18.991	-20.457	49.155	9.706	AV
9			8.350	36.622	26.651	-23.378	60.000	9.971	QP
10			8.350	30.572	20.601	-19.428	50.000	9.971	AV
11			9.766	37.504	27.467	-22.496	60.000	10.037	QP
12		*	9.766	31.073	21.036	-18.927	50.000	10.037	AV

Note: Measure Level (dBμV) = Reading Level (dBμV) + Factor (dB)

Factor (dB) = Cable Loss (dB) + LISN Factor (dB).

Site: SIP-SR2	Time: 2021/08/10 - 15:45
Limit: FCC_Part15.207_CE_AC Power	Engineer: Rupert Wang
Probe: SIP-SR2-ENV216_101684_C	Polarity: Line
EUT: Wireless Receiver	Power: AC 120V/60Hz
Test Mode: Transmit	

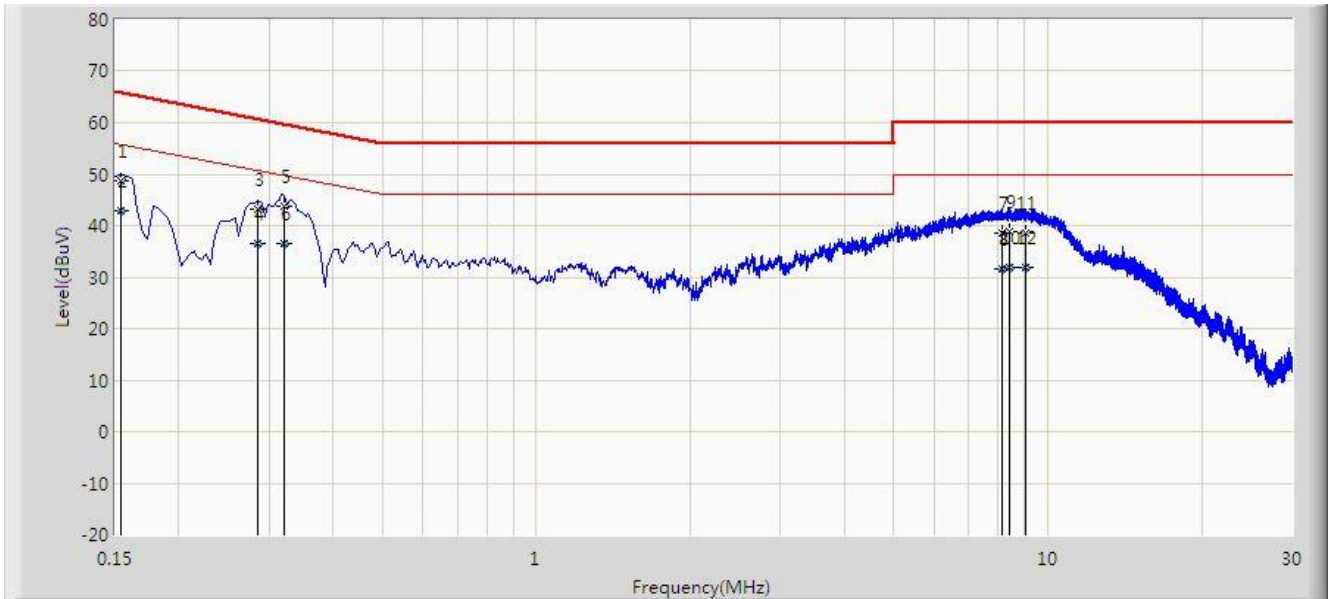

No	Flag	Mark	Frequency (MHz)	Measure Level (dBuV)	Reading Level (dBuV)	Margin (dB)	Limit (dBuV)	Factor (dB)	Type
1			0.154	48.773	39.124	-17.008	65.781	9.649	QP
2		*	0.154	42.983	33.334	-12.799	55.781	9.649	AV
3			0.286	43.055	33.350	-17.585	60.640	9.706	QP
4			0.286	36.500	26.794	-14.140	50.640	9.706	AV
5			0.322	43.821	34.103	-15.834	59.655	9.718	QP
6			0.322	36.502	26.784	-13.153	49.655	9.718	AV
7			8.122	38.642	28.661	-21.358	60.000	9.981	QP
8			8.122	31.694	21.713	-18.306	50.000	9.981	AV
9			8.406	38.696	28.712	-21.304	60.000	9.984	QP
10			8.406	31.830	21.846	-18.170	50.000	9.984	AV
11			9.058	38.503	28.493	-21.497	60.000	10.011	QP
12			9.058	31.782	21.771	-18.218	50.000	10.011	AV

Note: Measure Level (dBμV) = Reading Level (dBμV) + Factor (dB)

Factor (dB) = Cable Loss (dB) + LISN Factor (dB).

7. Conclusion

The data collected relate only the item(s) tested and show that the device is compliance with Part 15C of the FCC rules.

————— The End —————

Appendix A - Test Setup Photograph

Refer to "2107RSU058-UT" file.

Appendix B - EUT Photograph

Refer to "2107RSU058-UE" file.