

RF MEASUREMENT REPORT

Applicant: Shure Incorporated
Product: Wireless Microphone Transmitter
Model No.: BLX2
Trademark: 
FCC Rule Part(s): Part 74 Subpart H Section 74.861
Clause (e)(1)(ii) & (e)(6) & (e)(7)
Result: Complies
Test Date: April 25 ~ May 19, 2022

Reviewed By:

Jame Yuan

Approved By:

Robin Wu



The test results relate only to the samples tested.

This equipment has been shown to be capable of compliance with the applicable technical standards as indicated in the measurement report and was tested in accordance with the measurement procedures specified in ANSI C63.26-2015 and EN 300 422-1 V1.4.2. Test results reported herein relate only to the item(s) tested.

The test report shall not be reproduced except in full without the written approval of MRT Technology (Suzhou) Co., Ltd.

Revision History

Report No.	Version	Description	Issue Date	Note
2204RSU033-U4	Rev. 01	Initial Report	06-09-2022	Valid

CONTENTS

Description	Page
1. General Information	5
1.1. Applicant	5
1.2. Manufacturer	5
1.3. Testing Facility	5
1.4. Product Information.....	6
1.5. Radio Specification	6
1.6. Working Frequencies	6
2. Test Configuration	7
2.1. Test Mode.....	7
2.2. Test Software	7
2.3. Applied Standards.....	7
2.4. Test Environment Condition	7
3. Measuring Instrument	8
4. Measurement Uncertainty.....	9
5. Test Result.....	10
5.1. Summary	10
5.2. Output Power Measurement	11
5.2.1. Test Limit	11
5.2.2. Test Procedure	11
5.2.3. Test Setting	11
5.2.4. Test Setup	11
5.2.5. Test Result	11
5.3. Necessary Bandwidth Measurement	12
5.3.1. Test Limit	12
5.3.2. Test Procedure	12
5.3.3. Test Setting	12
5.3.4. Test Setup	13
5.3.5. Test Result	13
5.4. Radiated Spurious Emission Measurement.....	14
5.4.1. Test Limit	14
5.4.2. Test Procedure	14
5.4.3. Test Setting	14
5.4.4. Test Setup	15
5.4.5. Test Result	15
Appendix A – Test Result.....	16

A.1	Output Power Test Result	16
A.2	Necessary Bandwidth Test Result	17
A.3	Radiated Spurious Emission Test Result	19
Appendix B – Test Setup Photograph		21
Appendix C – EUT Photograph		22

1. General Information

1.1. Applicant

Shure Incorporated
5800 West Touhy Avenue, Niles, IL 60714-4608, USA

1.2. Manufacturer

Shure Incorporated
5800 West Touhy Avenue, Niles, IL 60714-4608, USA

1.3. Testing Facility

<input checked="checked" type="checkbox"/>	<p>Test Site – MRT Suzhou Laboratory</p> <hr/> <p>Laboratory Location (Suzhou - Wuzhong) D8 Building, No.2 Tian'edang Rd., Wuzhong Economic Development Zone, Suzhou, China</p> <p>Laboratory Location (Suzhou - SIP) 4b Building, Liando U Valley, No.200 Xingpu Rd., Shengpu Town, Suzhou Industrial Park, China</p> <hr/> <p>Laboratory Accreditations</p> <p>A2LA: 3628.01 CNAS: L10551</p> <p>FCC: CN1166 ISED: CN0001</p> <p>VCCI: <input type="checkbox"/>R-20025 <input type="checkbox"/>G-20034 <input type="checkbox"/>C-20020 <input type="checkbox"/>T-20020</p> <p style="margin-left: 180px;"><input type="checkbox"/>R-20141 <input type="checkbox"/>G-20134 <input type="checkbox"/>C-20103 <input type="checkbox"/>T-20104</p>
<input type="checkbox"/>	<p>Test Site – MRT Shenzhen Laboratory</p> <hr/> <p>Laboratory Location (Shenzhen) 1G, Building A, Junxiangda Building, Zhongshanyuan Road West, Nanshan District, Shenzhen, China</p> <hr/> <p>Laboratory Accreditations</p> <p>A2LA: 3628.02 CNAS: L10551</p> <p>FCC: CN1284 ISED: CN0105</p>
<input type="checkbox"/>	<p>Test Site – MRT Taiwan Laboratory</p> <hr/> <p>Laboratory Location (Taiwan) No. 38, Fuxing 2nd Rd., Guishan Dist., Taoyuan City 333, Taiwan (R.O.C.)</p> <hr/> <p>Laboratory Accreditations</p> <p>TAF: L3261-190725</p> <p>FCC: 291082, TW3261 ISED: TW3261</p>

1.4. Product Information

Product Name	Wireless Microphone Transmitter
Model No.	BLX2
EUT Identification No.	H11: 20220420Sample#24 (Radiated), 20220420Sample#16 (Conducted) J11: 20220420Sample#15 (Radiated), 20220420Sample#21 (Conducted)
Working Voltage	2pcs AA Batteries (DC 3.0V)
Remark: The information of EUT was provided by the manufacturer, and the accuracy of the information shall be the responsibility of the manufacturer.	

1.5. Radio Specification

Frequency Range	H11 Band: 572.125 - 595.850MHz J11 Band: 596.125 - 607.875MHz
Declared Power Level	10mW
Type of Modulation	FM
Channel Spacing	25kHz

1.6. Working Frequencies

Groups	Channel	Frequency	Groups	Channel	Frequency
H11 Band	Low	572.125 MHz	J11 Band	Low	596.125 MHz

	Mid	584.125 MHz		Mid	602.000 MHz

	High	595.850 MHz		High	607.850 MHz

2. Test Configuration

2.1. Test Mode

Mode 1: Transmit at Low Channel 572.125MHz (H11 Band)
Mode 2: Transmit at Mid Channel 584.125MHz (H11 Band)
Mode 3: Transmit at High Channel 595.850MHz (H11 Band)
Mode 4: Transmit at Low Channel 596.125MHz (J11 Band)
Mode 5: Transmit at Mid Channel 602.000MHz (J11 Band)
Mode 6: Transmit at High Channel 607.850MHz (J11 Band)

2.2. Test Software

There is no test utility software used during testing. Radio frequency can be set by the button on the device.

2.3. Applied Standards

According to the specifications of the manufacturer, the EUT must comply with the requirements of the following standards:

- FCC Part 74.861
- ANSI C63.26-2015
- KDB 206256 D01v02
- ETSI EN 300 422-1 V1.4.2 (2011-08)

2.4. Test Environment Condition

Ambient Temperature	15 ~ 35°C
Relative Humidity	20 ~ 75%RH

3. Measuring Instrument

Instrument	Manufacturer	Model No.	Asset No.	Cali. Interval	Cali. Due Date	Test Site
EMI Test Receiver	R&S	ESR7	MRTSUE06001	1 year	2022/12/29	WZ-AC1
Horn Antenna	Schwarzbeck	BBHA 9120D	MRTSUE06023	1 year	2022/9/16	WZ-AC1
Preamplifier	Agilent	83017A	MRTSUE06076	1 year	2022/11/12	WZ-AC1
TRILOG Antenna	Schwarzbeck	VULB 9168	MRTSUE06172	1 year	2022/8/5	WZ-AC1
Anechoic Chamber	TDK	WZ-AC1	MRTSUE06212	1 year	2023/4/21	WZ-AC1
Thermohygrometer	testo	608-H1	MRTSUE06403	1 year	2022/6/28	WZ-AC1
Signal Analyzer	Keysight	N9010B	MRTSUE06607	1 year	2022/12/29	WZ-AC1
Thermohygrometer	testo	Testo 608-H1	MRTSUE11039	1 year	2022/11/11	WZ-AC1
USB Power Sensor	Keysight	U2021XA	MRTSUE06582	1 year	2022/8/8	WZ-SR5
Signal Analyzer	Agilent	N9020A	MRTSUE06106	1 year	2023/4/6	WZ-SR5
Shielding Room	HUAMING	WZ-SR5	MRTSUE06442	N/A	N/A	WZ-SR5
Signal Analyzer	Keysight	N9010B	MRTSUE06457	1 year	2022/6/24	WZ-SR5
Audio Analyzer	R&S	UPV	MRTSUE06357	1 year	2023/4/28	WZ-SR5
Modulation Analyzer	HP	HP8901A	MRTSUE06098	1 year	2022/9/12	WZ-SR5
Thermohygrometer	testo	608-H1	MRTSUE06402	1 year	2022/6/28	WZ-SR5

Software	Version	Function
EMI V3	V 3.0.0	EMI Test Software
Controller_MF 7802BS	1.02	RE Antenna & Turntable

4. Measurement Uncertainty

Where relevant, the following test uncertainty levels have been estimated for tests performed on the EUT as specified in CISPR 16-4-2. This uncertainty represents an expanded uncertainty expressed at approximately the 95% confidence level using a coverage factor of $k = 2$.

Radiated Disturbance
Measurement Uncertainty for a Level of Confidence of 95% ($U=2Uc(y)$): Horizontal: 30MHz~300MHz: 5.04dB 300MHz~1GHz: 4.95dB 1GHz~40GHz: 6.40dB Vertical: 30MHz~300MHz: 5.24dB 300MHz~1GHz: 6.03dB 1GHz~40GHz: 6.40dB
Output Power
Measuring Uncertainty for a Level of Confidence of 95% ($U=2Uc(y)$): 1.13dB

5. Test Result

5.1. Summary

FCC Section(s)	Test Description	Test Condition	Verdict
74.861(e)(1)(ii)	Output Power	Conducted	Pass
74.861(e)(7)	Necessary Bandwidth		Pass
74.861(e)(7)	Radiated Spurious Emission	Radiated	Pass

Remark:

1. The analyzer plots shown in this section were all taken with a correction table loaded into the analyzer. The correction table was used to account for the losses of the cables and attenuators used as part of the system to connect the EUT to the analyzer at all frequencies of interest.
2. For radiated emission tests, every axis (X, Y, Z) was also verified. The test results shown in the following sections represent the worst-case emissions.

5.2. Output Power Measurement

5.2.1. Test Limit

The conducted power may not exceed 250mW in 470 ~ 608 and 614 ~ 698 MHz band.

5.2.2. Test Procedure

ANSI C63.26 - 2015 - Section 5.2.4.2

5.2.3. Test Setting

Average power measurements were performed only when the EUT was transmitting at its maximum power control level using a broadband power meter with a pulse sensor. The power meter implemented triggering and gating capabilities which were set up such that power measurements were recorded only during the ON time of the transmitter.

5.2.4. Test Setup

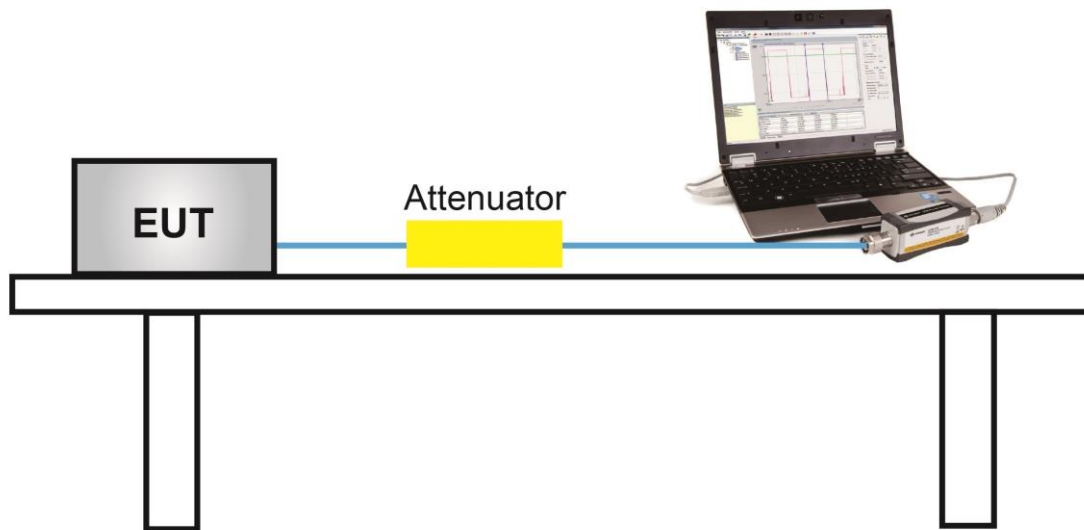

5.2.5. Test Result

Refer to Appendix A.1.

5.3. Necessary Bandwidth Measurement

5.3.1. Test Limit

Digital emissions within the band from one megahertz below to one megahertz above the carrier frequency shall comply with the emission mask in section 8.3.1.2 (Figure 3) of the European Telecommunications Institute Standard ETSI EN 300 422-1 v1.4.2, as shown below.

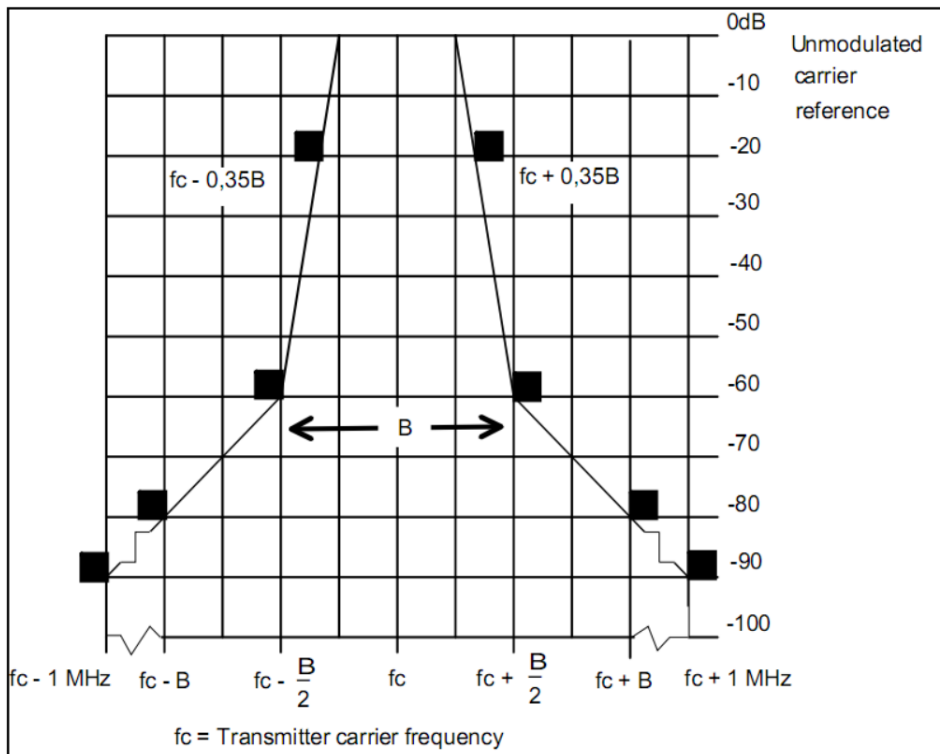

5.3.2. Test Procedure

EN 300 422-1 V1.4.2 Clause 8.3.1.1.

5.3.3. Test Setting

The EUT was powered up and the transmit frequency & power output of the EUT were selected.

The spectrum analyzer center frequency is set to the nominal EUT channel center frequency.

Inject the 1kHz audio signal to the EUT to meet EN 300 422-1 requirements.

Only lowest and highest channel is required, at an output power level of 10mW.

5.3.4. Test Setup

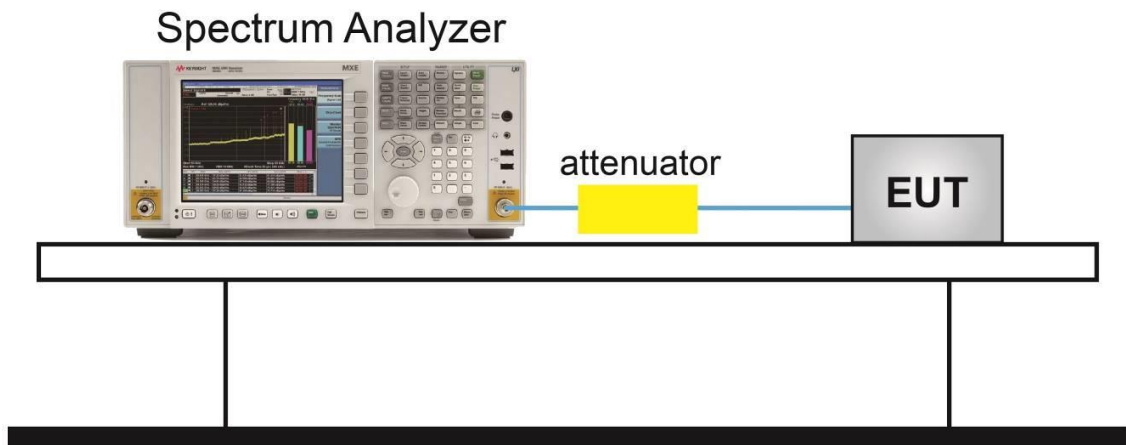

5.3.5. Test Result

Refer to Appendix A.2.

5.4. Radiated Spurious Emission Measurement

5.4.1. Test Limit

Beyond one megahertz below and above the carrier frequency, emissions shall comply with the limits specified in section 8.4 of ETSI EN 300 422-1 v1.4.2, as shown below.

State	Frequency		
	47 MHz to 74 MHz, 87.5 MHz to 137 MHz 174 MHz to 230 MHz, 470 MHz to 862 MHz	Other frequencies below 1000 MHz	Frequencies above 1000 MHz
Operation	4 nW	250 nW	1 μ W
Standby	2 nW	2 nW	20 nW

5.4.2. Test Procedure

EN 300 422-1 V1.4.2 Clause 8.4.2.

5.4.3. Test Setting

Table 1 - RBW as a function of frequency

Frequency	RBW
25 ~ 30 MHz	9 ~ 10 kHz
30 ~ 1000 MHz	100 ~ 120 kHz
> 1000MHz	1MHz

Emissions shall be investigated up to the 10 harmonic of the fundamental.

Compliance with the emission limits shall be demonstrated using a RMS Average detector.

All significant broadband and narrowband signals found in the preliminary sweeps were measured using a peak detector at a test distance of 3 meters.

At each frequency at which a component is detected, the sample shall be rotated to obtain maximum response and the effective radiated power of that component determined by a substitution measurement.

5.4.4. Test Setup

Below 1GHz Test Setup:

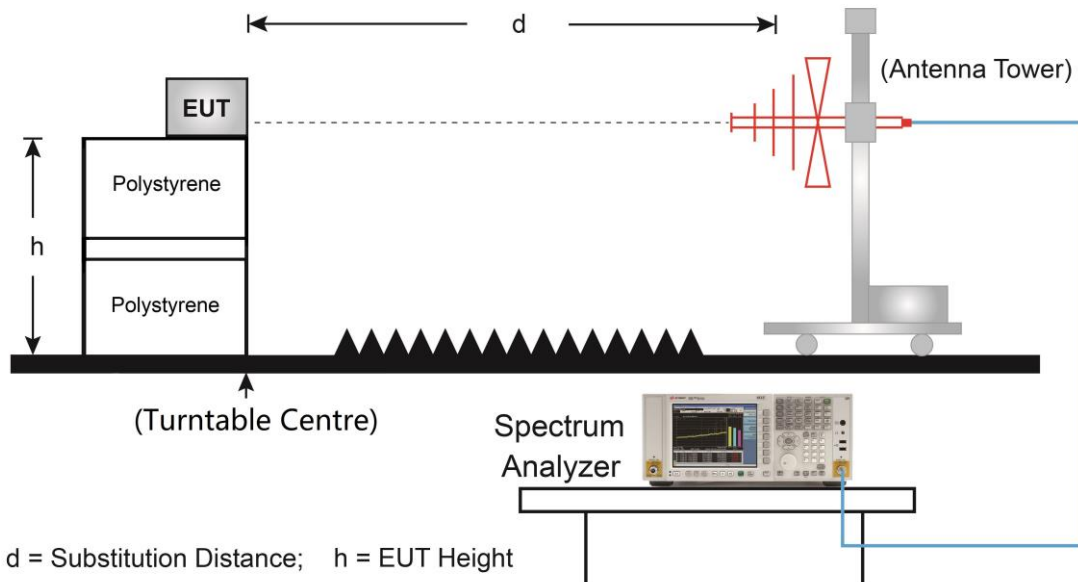

Above 1GHz Test Setup:

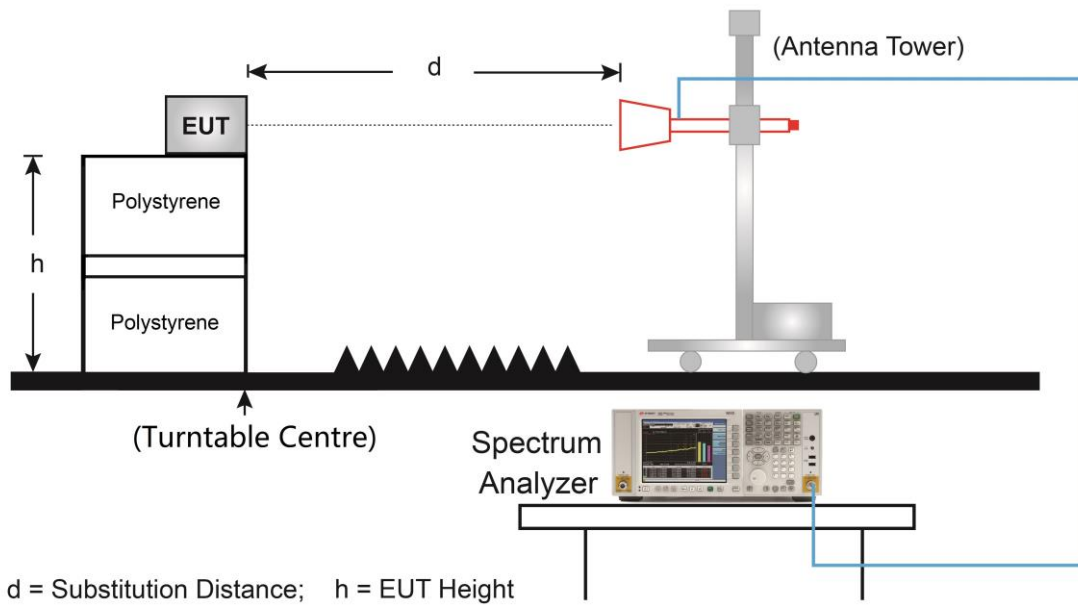

5.4.5. Test Result

Refer to Appendix A.3.

Appendix A – Test Result

A.1 Output Power Test Result

Test Site	WZ-SR5	Test Engineer	Luis Yang
Test Date	2022/04/29 ~ 2022/06/15		

Groups	Channel No.	Frequency (MHz)	Average Power (dBm)	Limit (dBm)
H11 Band	Low	572.125	11.42	≤ 23.98
	Mid	584.125	11.47	≤ 23.98
	High	595.850	11.36	≤ 23.98
J11 Band	Low	596.125	10.13	≤ 23.98
	Mid	602.000	9.88	≤ 23.98
	High	607.850	9.81	≤ 23.98

Note: Limit (dBm) = $10 \cdot \log(250 \text{ mW}) = 23.98 \text{ dBm}$.

A.2 Necessary Bandwidth Test Result

Test Site	WZ-SR5	Test Engineer	Luis Yang
Test Date	2022/05/19 ~ 2022/06/15		

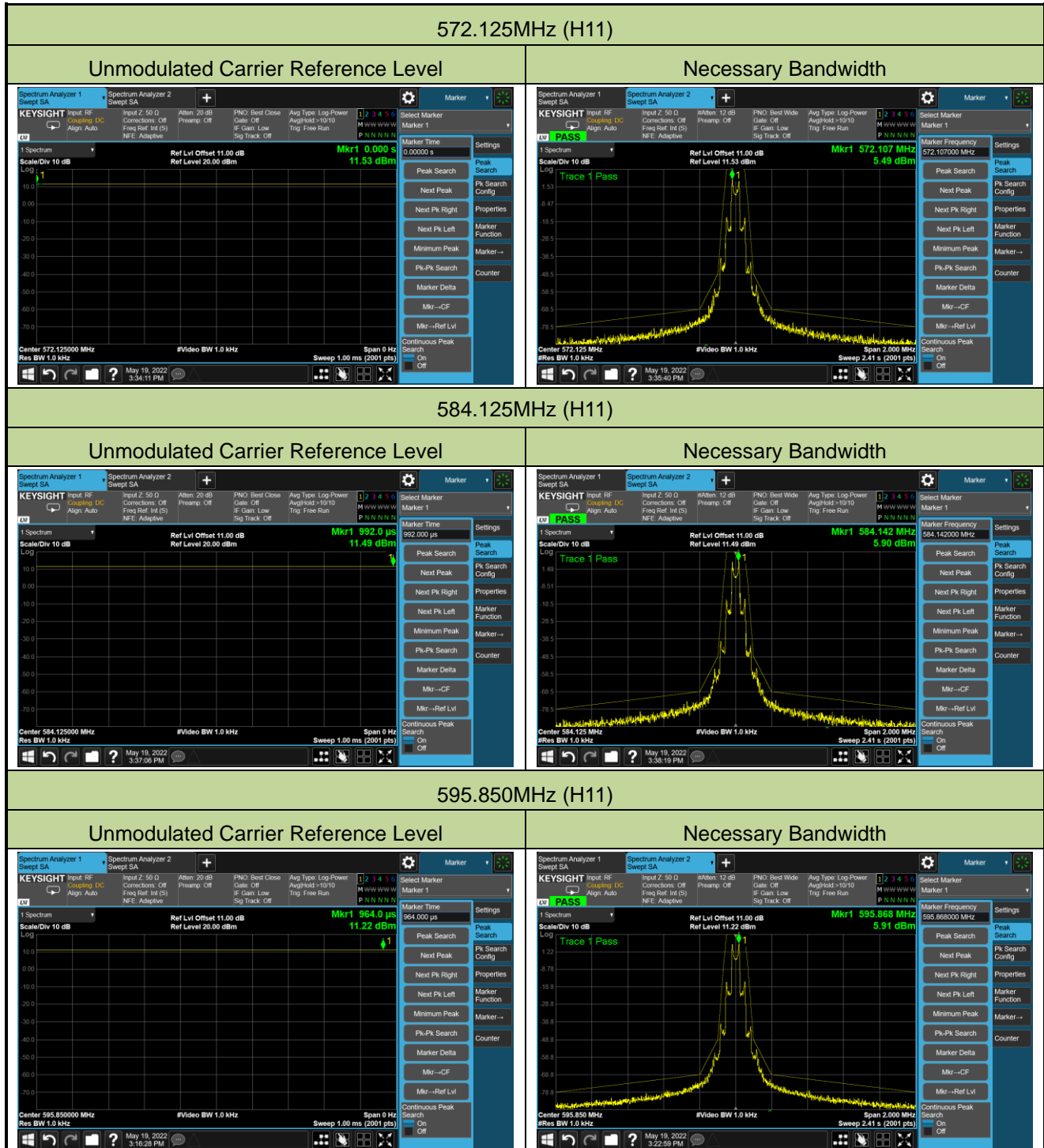

596.125MHz (J11)

Unmodulated Carrier Reference Level

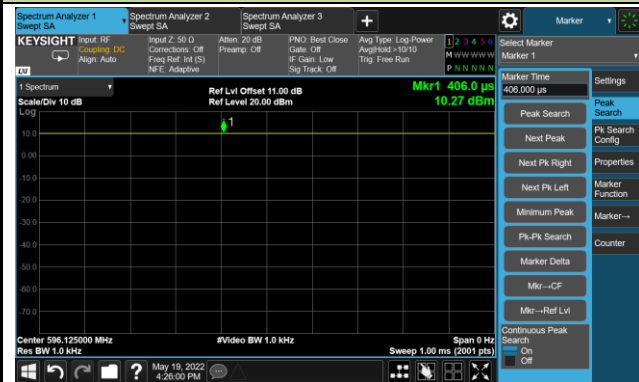

Necessary Bandwidth

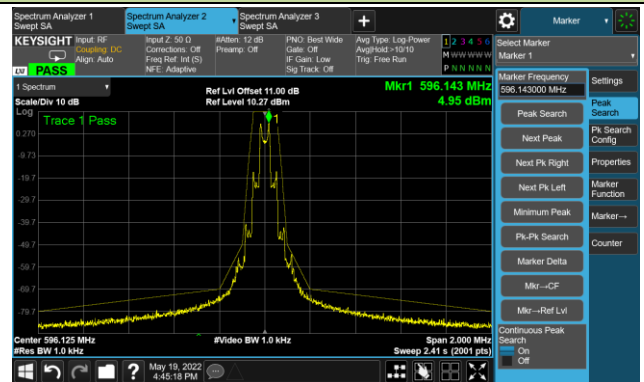

602.000MHz (J11)

Unmodulated Carrier Reference Level

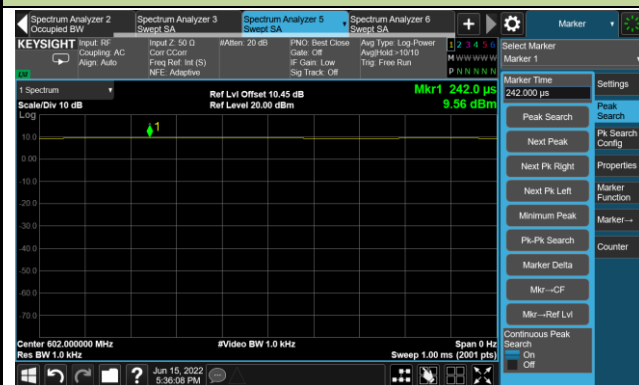

Necessary Bandwidth

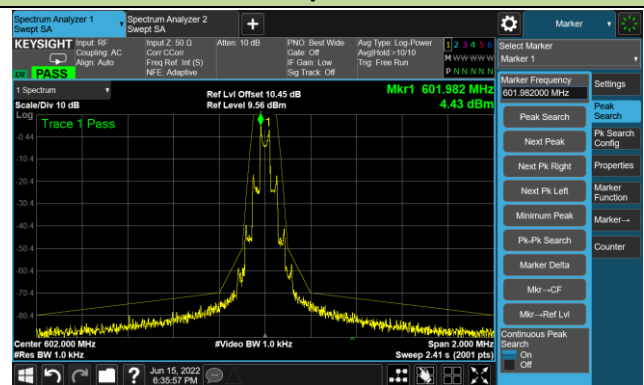

607.850MHz (J11)

Unmodulated Carrier Reference Level

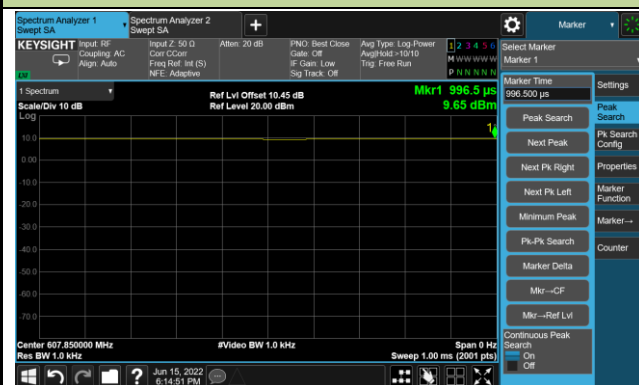

Necessary Bandwidth

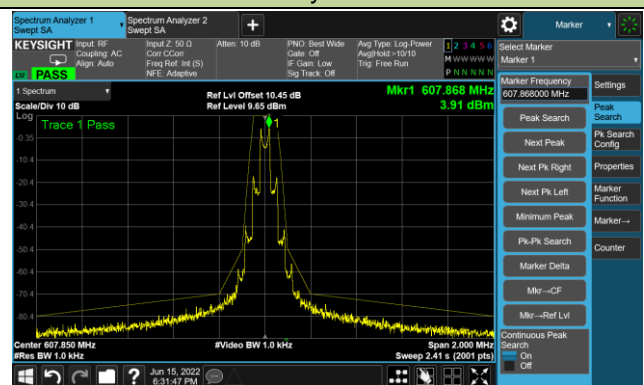

A.3 Radiated Spurious Emission Test Result

Test Site	WZ-AC1	Test Engineer	Carl Jiang
Test Date	2022/04/25	Group	BLX2 H11

Test Frequency (MHz)	Frequency (MHz)	Reading Level (dBm)	Substitution Factor (dB)	Measure Level (dBm)	Limit (dBm)	Margin (dB)	Detector	Polarization
572.125	720.2	-103.6	37.9	-65.7	-54.0	-11.7	RMS	Horizontal
	840.1	-102.5	37.9	-64.6	-54.0	-10.6	RMS	Horizontal
	718.2	-97.8	36.7	-61.1	-54.0	-7.1	Peak	Vertical
	836.7	-102.5	38.1	-64.4	-54.0	-10.4	RMS	Vertical
	2860.0	-50.8	9.9	-40.9	-30.0	-10.9	Peak	Horizontal
	6838.0	-68.0	18.2	-49.8	-30.0	-19.8	Peak	Horizontal
	2860.0	-56.6	10.5	-46.1	-30.0	-16.1	Peak	Vertical
	6967.0	-68.8	19.3	-49.5	-30.0	-19.5	Peak	Vertical
584.125	714.3	-102.3	37.6	-64.7	-54.0	-10.7	RMS	Horizontal
	836.2	-103.7	38.0	-65.7	-54.0	-11.7	RMS	Horizontal
	747.5	-97.2	36.7	-60.5	-54.0	-6.5	Peak	Vertical
	830.4	-102.8	37.9	-64.9	-54.0	-10.9	RMS	Vertical
	2920.0	-50.5	9.9	-40.6	-30.0	-10.6	Peak	Horizontal
	6934.0	-67.6	18.8	-48.8	-30.0	-18.8	Peak	Horizontal
	2920.0	-55.6	10.4	-45.2	-30.0	-15.2	Peak	Vertical
	6982.0	-68.6	19.1	-49.5	-30.0	-19.5	Peak	Vertical
595.850	714.3	-101.8	37.6	-64.2	-54.0	-10.2	RMS	Horizontal
	851.3	-100.6	37.4	-63.2	-54.0	-9.2	RMS	Horizontal
	719.2	-97.3	36.8	-60.5	-54.0	-6.5	Peak	Vertical
	834.7	-102.8	38.1	-64.7	-54.0	-10.7	RMS	Vertical
	2980.0	-54.4	9.9	-44.5	-30.0	-14.5	Peak	Horizontal
	6520.0	-66.7	17.7	-49.0	-30.0	-19.0	Peak	Horizontal
	2980.0	-58.9	10.4	-48.5	-30.0	-18.5	Peak	Vertical
	6934.0	-68.9	19.5	-49.4	-30.0	-19.4	Peak	Vertical

Note 1: Measure Level (dBm) = Reading Level (dBm) + Substitution Factor (dB)

Note 2: For emission up to 1GHz:

Substitution Factor (dB) = Cable Loss (dB) + Space Attenuation (dB) - Antenna Gain (dBi) - 2.15 (dB)

For emission above to 1GHz:

Substitution Factor (dB) = Cable Loss (dB) + Space Attenuation (dB) - Antenna Gain (dBi) -

Pre_Amplifier Gain (dB)

Note 3: RMS measurement was not performed when peak level was lower than 6dB below the RMS limit.

Test Site	WZ-AC1	Test Engineer	Carl Jiang
Test Date	2022/04/25 ~ 2022/06/15	Group	BLX2 J11

Test Frequency (MHz)	Frequency (MHz)	Reading Level (dBm)	Substitution Factor (dB)	Measure Level (dBm)	Limit (dBm)	Margin (dB)	Detector	Polarization
596.125	720.2	-103.6	37.9	-65.7	-54.0	-11.7	Peak	Horizontal
	858.1	-102.3	37.6	-64.7	-54.0	-10.7	Peak	Horizontal
	755.8	-101.9	36.1	-65.8	-54.0	-11.8	Peak	Vertical
	836.7	-103.5	38.1	-65.4	-54.0	-11.4	Peak	Vertical
	2980.0	-60.3	9.9	-50.4	-30.0	-20.4	Peak	Horizontal
	6985.0	-69.3	18.7	-50.6	-30.0	-20.6	Peak	Horizontal
	2980.0	-56.7	10.4	-46.3	-30.0	-16.3	Peak	Vertical
	6757.0	-68.8	18.9	-49.9	-30.0	-19.9	Peak	Vertical
602.000	53.3	-92.9	25.5	-67.4	-54.0	-13.4	Peak	Horizontal
	842.1	-102.9	37.8	-65.1	-54.0	-11.1	Peak	Horizontal
	53.3	-85.4	24.0	-61.4	-54.0	-7.4	Peak	Vertical
	828.4	-103.2	37.7	-65.5	-54.0	-11.5	Peak	Vertical
	3010.0	-60.5	10.4	-50.1	-30.0	-20.1	Peak	Horizontal
	6964.0	-68.9	21.0	-47.9	-30.0	-17.9	Peak	Horizontal
	3010.0	-55.6	11.0	-44.6	-30.0	-14.6	Peak	Vertical
	6676.0	-68.3	20.7	-47.6	-30.0	-17.6	Peak	Vertical
607.850	53.3	-94.3	25.5	-68.8	-54.0	-14.8	Peak	Horizontal
	839.6	-102.9	37.9	-65.0	-54.0	-11.0	Peak	Horizontal
	53.3	-85.7	24.0	-61.7	-54.0	-7.7	Peak	Vertical
	809.9	-102.9	37.4	-65.5	-54.0	-11.5	Peak	Vertical
	3040.0	-61.3	10.6	-50.7	-30.0	-20.7	Peak	Horizontal
	6964.0	-68.3	21.0	-47.3	-30.0	-17.3	Peak	Horizontal
	3040.0	-57.9	11.0	-46.9	-30.0	-16.9	Peak	Vertical
	6850.0	-68.3	20.7	-47.6	-30.0	-17.6	Peak	Vertical

Note 1: Measure Level (dBm) = Reading Level (dBm) + Substitution Factor (dB)

Note 2: For emission up to 1GHz:

Substitution Factor (dB) = Cable Loss (dB) + Space Attenuation (dB) - Antenna Gain (dBi) - 2.15 (dB)

For emission above to 1GHz:

Substitution Factor (dB) = Cable Loss (dB) + Space Attenuation (dB) - Antenna Gain (dBi) - Pre_Amplifier Gain (dB)

Note 3: RMS measurement was not performed when peak level was lower than 6dB below the RMS limit.

Appendix B – Test Setup Photograph

Description: Radiated Spurious Emission Test Setup Below 1GHz



Description: Radiated Spurious Emission Test Setup Above 1GHz

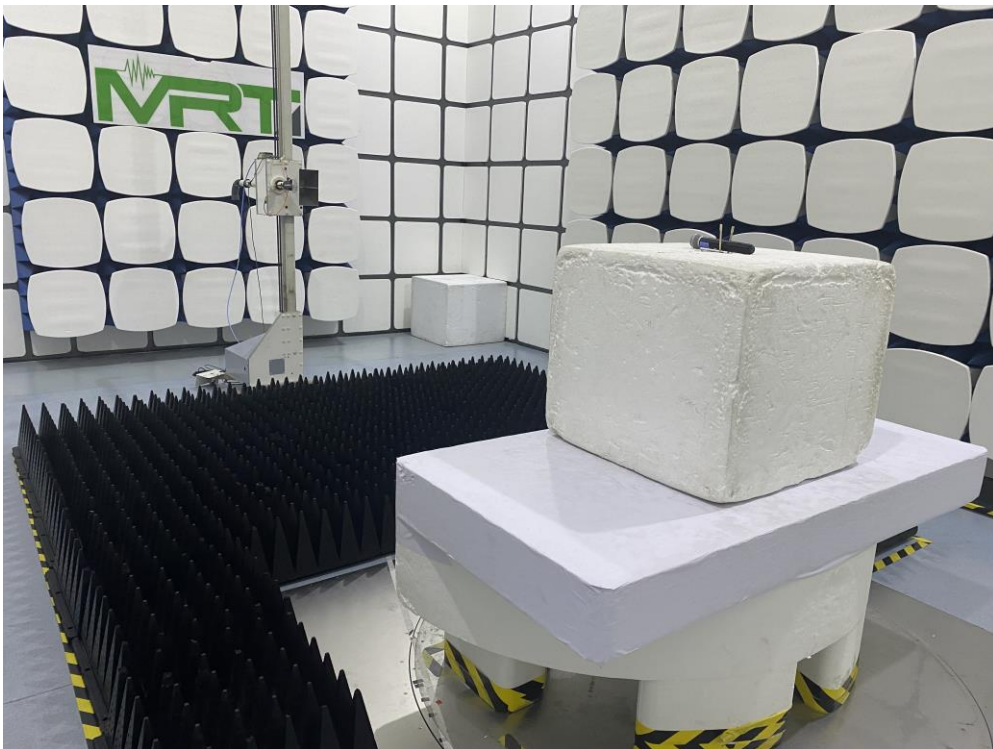

Appendix C – EUT Photograph

(1) EUT Photo



(2) EUT Photo



(3) EUT Photo



(4) EUT Photo

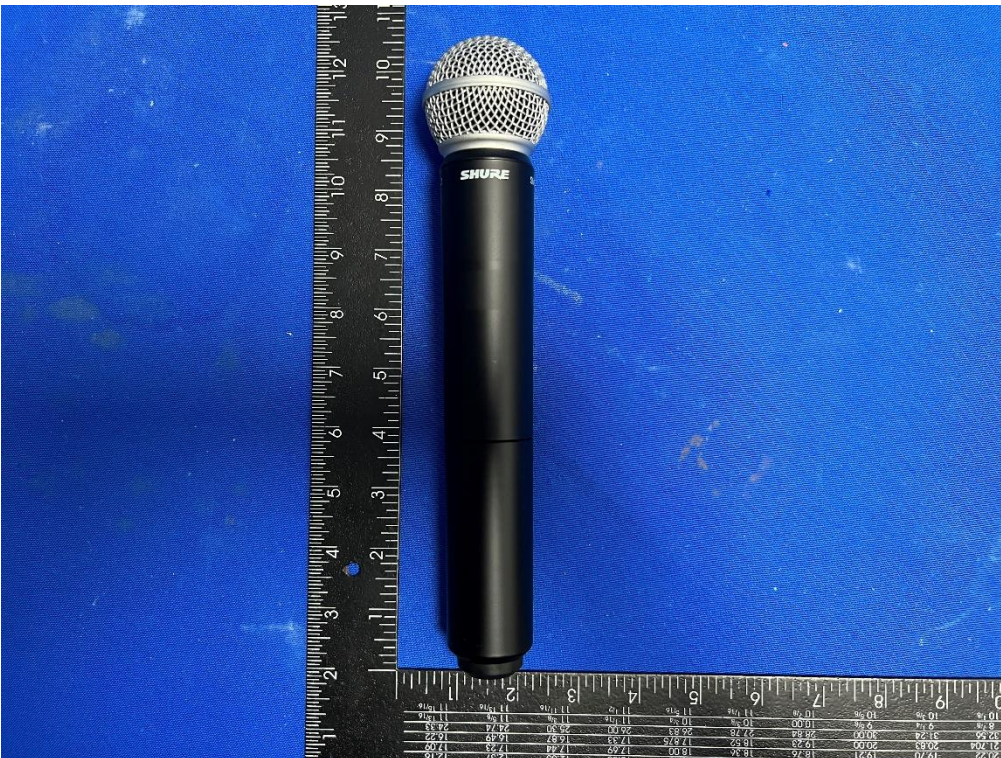

The End