

RF MEASUREMENT REPORT

FCC ID: DD4ADX3G57
Applicant: Shure Incorporated
Product: Digital Plug-on Transmitter
Model No.: ADX3 G57, ADX3 G57+
Brand Name: 
FCC Classification: Digital Transmission System (DTS)
FCC Rule Part(s): Part 15 Subpart C (Section 15.247)
Result: Complies
Received Date: 2022-07-19
Test Date: 2023-01-09 ~ 2023-01-31

Reviewed By:

Jame Yuan

Approved By:

Robin Wu



The test results relate only to the samples tested.

The test results shown in the test report are traceable to the national/international standards through the calibration of the equipment and evaluated measurement uncertainty herein.

The test report shall not be reproduced except in full without the written approval of MRT Technology (Suzhou) Co., Ltd.

Revision History

Report No.	Version	Description	Issue Date	Note
2211RSU077-U3	V01	Initial Report	2023-02-16	Valid

CONTENTS

Description	Page
1. General Information	5
1.1. Applicant	5
1.2. Manufacturer	5
1.3. Testing Facility	5
1.4. Product Information.....	6
1.5. Radio Specification under Test	6
1.6. Working Frequencies	6
2. Test Configuration	7
2.1. Test Mode.....	7
2.2. Test System Connection Diagram.....	7
2.3. Test Software	7
2.4. Applied Standards.....	8
2.5. Test Environment Condition	8
3. Antenna Requirements	9
4. Measuring Instrument	10
5. Decision Rules and Measurement Uncertainty	11
5.1. Decision Rules	11
5.2. Measurement Uncertainty	11
6. Test Result.....	12
6.1. Summary	12
6.2. 6dB Bandwidth Measurement.....	13
6.2.1. Test Limit	13
6.2.2. Test Procedure	13
6.2.3. Test Setting	13
6.2.4. Test Setup	13
6.2.5. Test Result	13
6.3. Output Power Measurement	14
6.3.1. Test Limit	14
6.3.2. Test Procedure	14
6.3.3. Test Setting	14
6.3.4. Test Setup	14
6.3.5. Test Result	14
6.4. Power Spectral Density Measurement	15
6.4.1. Test Limit	15
6.4.2. Test Procedure	15

6.4.3.	Test Setting	15
6.4.4.	Test Setup	15
6.4.5.	Test Result	15
6.5.	Conducted Band Edge and Out-of-Band Emissions Measurement	16
6.5.1.	Test Limit	16
6.5.2.	Test Procedure	16
6.5.3.	Test Settintg	16
6.5.4.	Test Setup	17
6.5.5.	Test Result	17
6.6.	Radiated Spurious Emission Measurement.....	18
6.6.1.	Test Limit	18
6.6.2.	Test Procedure	18
6.6.3.	Test Setting	18
6.6.4.	Test Setup	20
6.6.5.	Test Result	21
6.7.	Radiated Restricted Band Edge Measurement	22
6.7.1.	Test Limit	22
6.7.2.	Test Procedure	23
6.7.3.	Test Setting	23
6.7.4.	Test Setup	24
6.7.5.	Test Result	24
6.8.	AC Conducted Emissions Measurement	25
6.8.1.	Test Limit	25
6.8.2.	Test Setup	25
6.8.3.	Test Result	25
Appendix A – Test Result		26
A.1	Duty Cycle Test Result	26
A.2	6dB Bandwidth Test Result	27
A.3	Output Power Test Result	28
A.4	Power Spectral Density Test Result.....	29
A.5	Conducted Band Edge and Out-of-Band Emissions Test Result.....	30
A.6	Radiated Spurious Emission Test Result.....	33
A.7	Radiated Restricted Band Edge Test Result.....	36
A.8	AC Conducted Emissions Test Result	40
Appendix B – Test Setup Photograph		42
Appendix C – EUT Photograph		43

1.4. Product Information

Product Name	Digital Plug-on Transmitter
Model No.	ADX3 G57, ADX3 G57+
Serial No.	190A62368 00 (Conducted Testing) 3BF07090816 (Radiated Testing)
ZigBee Specification	802.15.4, 2405 ~ 2480 MHz
Wireless Microphone	UHF band, 470 ~ 608 MHz & 614 ~ 616 MHz
Power Type	Two AA batteries (3.0Vdc) or Li-ion battery
Operating Temperature	-10 ~ 50°C
Antenna Information	Refer to selection 1.5
Accessories	
Rechargeable Li-ion Battery	Model: SB900B Output: 3.7Vdc, 1240mAh, 4.59Wh

Note: The information of EUT was provided by the manufacturer, and the accuracy of the information shall be the responsibility of the manufacturer.

1.5. Radio Specification under Test

Zigbee Specification	802.15.4
Frequency Range	2405 ~ 2480MHz
Channel Number	16
Type of Modulation	O-QPSK
Antenna Type	Dipole
Antenna Gain	1.62dBi

1.6. Working Frequencies

Channel	Frequency	Channel	Frequency	Channel	Frequency
11	2405 MHz	12	2410 MHz	13	2415 MHz
14	2420 MHz	15	2425 MHz	16	2430 MHz
17	2435 MHz	18	2440 MHz	19	2445 MHz
20	2450 MHz	21	2455 MHz	22	2460 MHz
23	2465 MHz	24	2470 MHz	25	2475 MHz
26	2480 MHz	--	--	--	--

2. Test Configuration

2.1. Test Mode

Mode 1: Transmit by 802.15.4

2.2. Test System Connection Diagram

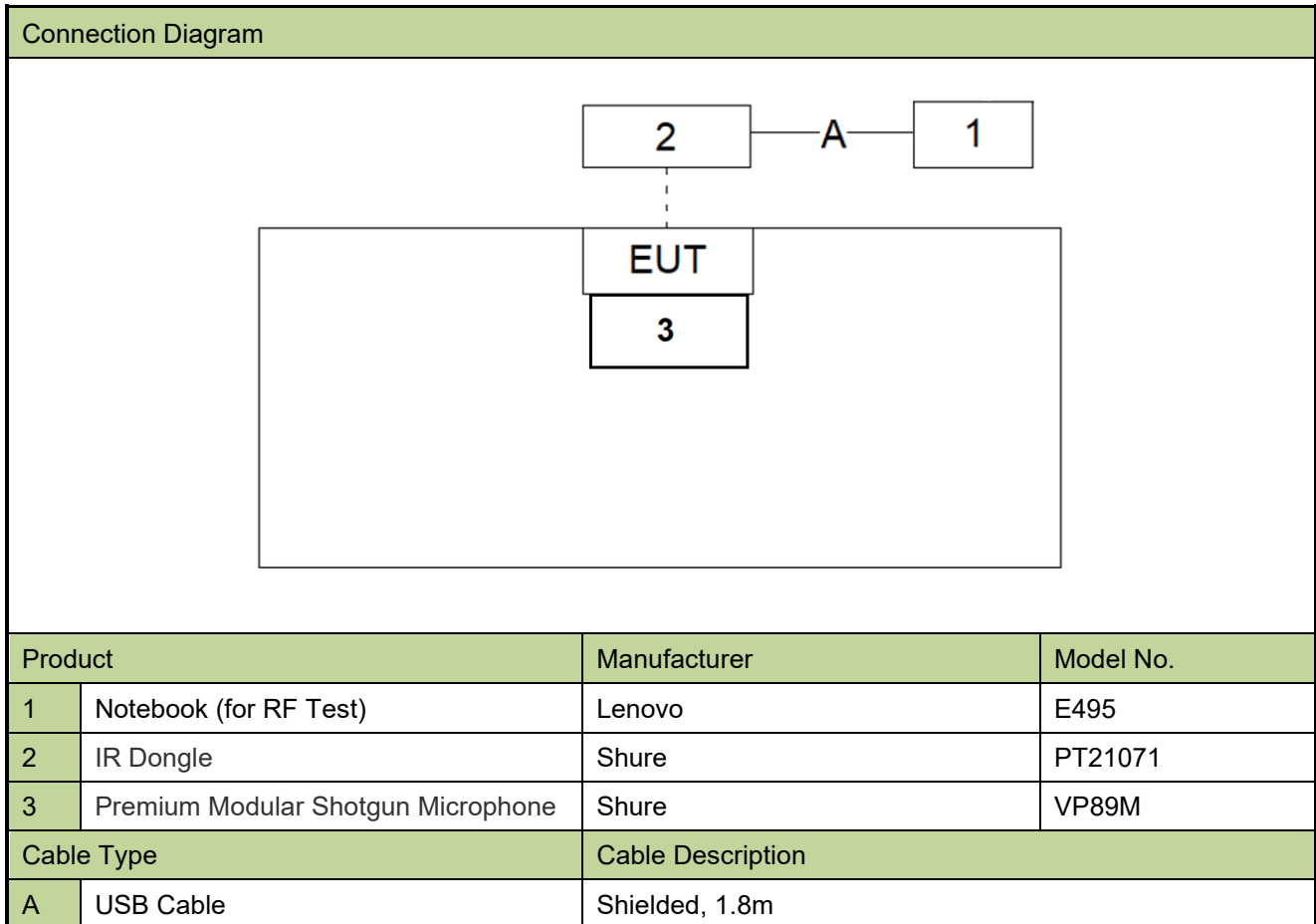

2.3. Test Software

The test utility software used during testing was "TeraTerm.exe" and the version was 4.106.

2.4. Applied Standards

According to the specifications of the manufacturer, the EUT must comply with the requirements of the following standards:

- FCC Part 15.247
- KDB 558074 D01v05r02
- ANSI C63.10-2013

2.5. Test Environment Condition

Ambient Temperature	15 ~ 35°C
Relative Humidity	20 ~ 75%RH

3. Antenna Requirements

Excerpt from §15.203 of the FCC Rules/Regulations:

“An intentional radiator antenna shall be designed to ensure that no antenna other than that furnished by the responsible party can be used with the device. The use of a permanently attached antenna or of an antenna that uses a unique coupling to the intentional radiator shall be considered sufficient to comply with the provisions of this section.”

- The antenna of the device is **permanently attached**.
- There are no provisions for connection to an external antenna.

Conclusion:

The unit complies with the requirement of §15.203.

4. Measuring Instrument

Instrument	Manufacturer	Model No.	Asset No.	Cali. Interval	Cali. Due Date	Test Site
EMI Test Receiver	R&S	ESR3	MRTSUE06185	1 year	2023-12-28	SIP-AC3
Loop Antenna	Schwarzbeck	FMZB 1519 B	MRTSUE06937	1 year	2023-03-14	SIP-AC3
Signal Analyzer	Keysight	N9020B	MRTSUE06604	1 year	2023-11-07	SIP-AC3
Horn Antenna	Schwarzbeck	BBHA 9170	MRTSUE06599	1 year	2023-10-13	SIP-AC3
Preamplifier	Schwarzbeck	BBV 9721	MRTSUE06121	1 year	2023-06-08	SIP-AC3
Horn Antenna	R&S	HF907	MRTSUE06611	1 year	2023-07-30	SIP-AC3
Thermohygrometer	testo	608-H1	MRTSUE06619	1 year	2023-11-01	SIP-AC3
Thermohygrometer	testo	608-H1	MRTSUE06622	1 year	2023-11-27	SIP-AC3
Preamplifier	EMCI	EMC012645SE	MRTSUE06642	1 year	2024-01-12	SIP-AC3
TRILOG Antenna	Schwarzbeck	VULB 9168	MRTSUE06646	1 year	2023-08-16	SIP-AC3
Anechoic Chamber	RIKEN	SIP-AC3	MRTSUE06782	1 year	2023-12-22	SIP-AC3
Two-Line V-Network	R&S	ENV216	MRTSUE06003	1 year	2023-06-01	SIP-SR2
EMI Test Receiver	R&S	ESR3	MRTSUE06612	1 year	2023-06-01	SIP-SR2
Thermohygrometer	testo	608-H1	MRTSUE06621	1 year	2023-11-27	SIP-SR2
Shielding Room	MIX-BEP	SIP-SR2	MRTSUE06949	5 years	2024-10-23	SIP-SR2
Signal Analyzer	Keysight	N9010B	MRTSUE06558	1 year	2023-06-01	SIP-TR1
USB Power Sensor	Keysight	U2021XA	MRTSUE06596	1 year	2023-08-23	SIP-TR1
Thermohygrometer	testo	608-H1	MRTSUE11022	1 year	2023-11-01	SIP-TR1

Software	Version	Function
EMI Software	V3.0.0	EMI Test Software
Controller_MF 7802BS	1.02	RE Antenna & Turntable
Agilent Power Analyzer/Agilent Power Panel	V R03.09.00	Power

5. Decision Rules and Measurement Uncertainty

5.1. Decision Rules

The Decision Rule is based on Simple Acceptance in accordance with ISO Guide 98-4: 2012 Clause 8.2. (Measurement uncertainty is not taken into account when stating conformity with a specified requirement.)

5.2. Measurement Uncertainty

Where relevant, the following test uncertainty levels have been estimated for tests performed on the EUT as specified in CISPR 16-4-2. This uncertainty represents an expanded uncertainty expressed at approximately the 95% confidence level using a coverage factor of $k = 2$.

AC Conducted Emission Measurement
Measurement Uncertainty for a Level of Confidence of 95% ($U=2Uc(y)$): 9kHz~150kHz: 3.58dB 150kHz~30MHz: 3.20dB
Radiated Disturbance
Measurement Uncertainty for a Level of Confidence of 95% ($U=2Uc(y)$): Coaxial: 9kHz~30MHz: 2.59dB Coplanar: 9kHz~30MHz: 2.60dB Horizontal: 30MHz~200MHz: 3.85dB 200MHz~1GHz: 4.36dB 1GHz~40GHz: 4.98dB Vertical: 30MHz~200MHz: 4.06dB 200MHz~1GHz: 5.28Db 1GHz~40GHz: 4.91dB
Spurious Emissions, Conducted
Measuring Uncertainty for a Level of Confidence of 95% ($U=2Uc(y)$): 2.3dB
Output Power
Measuring Uncertainty for a Level of Confidence of 95% ($U=2Uc(y)$): 1.5dB
Power Spectrum Density
Measuring Uncertainty for a Level of Confidence of 95% ($U=2Uc(y)$): 2.3dB
Occupied Bandwidth
Measuring Uncertainty for a Level of Confidence of 95% ($U=2Uc(y)$): 3.2%

6. Test Result

6.1. Summary

FCC Section(s)	Test Description	Test Condition	Verdict
15.247(a)(2)	6dB Bandwidth	Conducted	Pass
15.247(b)(3)	Output Power		Pass
15.247(e)	Power Spectral Density		Pass
15.247(d)	Band Edge / Out-of-Band Emissions		Pass
15.205 15.209	General Field Strength (Restricted Bands and Radiated Emission)	Radiated	Pass
15.207	AC Conducted Emissions 150kHz - 30MHz	Line Conducted	Pass

Notes:

- The analyzer plots shown in this section were all taken with a correction table loaded into the analyzer. The correction table was used to account for the losses of the cables and attenuators used as part of the system to connect the EUT to the analyzer at all frequencies of interest.
- For radiated emission tests, every axis (X, Y, Z) was also verified. The test results shown in the following sections represent the worst-case emissions.

6.2. 6dB Bandwidth Measurement

6.2.1. Test Limit

The minimum 6dB bandwidth shall be at least 500 kHz.

6.2.2. Test Procedure

ANSI C63.10 - 2013 - Section 11.8

6.2.3. Test Setting

1. The Spectrum's automatic bandwidth measurement capability was used to perform the 6dB bandwidth measurement. The "X" dB bandwidth parameter was set to $X = 6$. The bandwidth measurement was not influenced by any intermediate power nulls in the fundamental emission.
2. Set RBW = 100 kHz
3. VBW $\geq 3 \times$ RBW
4. Detector = Peak
5. Trace mode = Max hold
6. Sweep = Auto couple
7. Allow the trace to stabilize

6.2.4. Test Setup

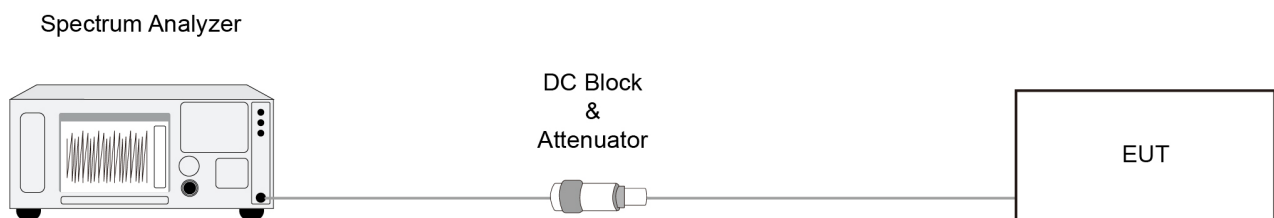

6.2.5. Test Result

Refer to Appendix A.2.

6.3. Output Power Measurement

6.3.1. Test Limit

The maximum output power shall be less 1 Watt (30dBm).

The conducted output power limit specified in paragraph FCC Part 15.247(b) of this section is based on the use of antennas with directional gains that do not exceed 6 dBi. If transmitting antennas of directional gain greater than 6 dBi are used, the conducted output power from the intentional radiator shall be reduced below the stated values in paragraphs FCC Part 15.247(b)(3) of this section, as appropriate, by the amount in dB that the directional gain of the antenna exceeds 6 dBi.

6.3.2. Test Procedure

ANSI C63.10-2013 Section 11.9.1.3

ANSI C63.10-2013 Section 11.9.2.3

6.3.3. Test Setting

Method PKPM1 (Peak Power Measurement)

Peak power measurements were performed only when the EUT was transmitting at its maximum power control level using a broadband power meter with a pulse sensor. The pulse sensor employs a VBW = 50MHz so this method was only used for signals whose DTS bandwidth was less than or equal to 50MHz.

Average Power Measurement

Average power measurements were performed only when the EUT was transmitting at its maximum power control level using a broadband power meter with a pulse sensor. The power meter implemented triggering and gating capabilities which were set up such that power measurements were recorded only during the ON time of the transmitter.

6.3.4. Test Setup

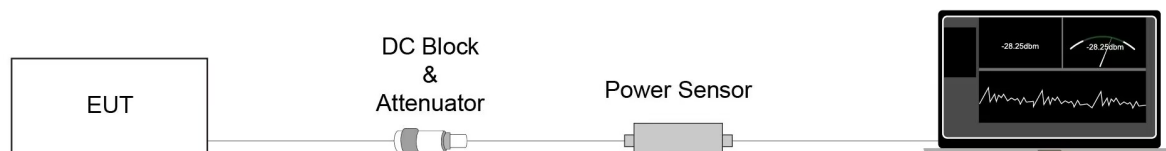

6.3.5. Test Result

Refer to Appendix A.3.

6.4. Power Spectral Density Measurement

6.4.1. Test Limit

The maximum permissible power spectral density is 8dBm in any 3 kHz band.

The same method of determining the conducted output power shall be used to determine the power spectral density.

6.4.2. Test Procedure

ANSI C63.10 - 2013 - Section 11.10.5

6.4.3. Test Setting

1. Set instrument center frequency to DTS channel center frequency.
2. Set the span > 1.5 times the DTS bandwidth.
3. Set the RBW = 3 kHz.
4. Set the VBW $\geq [3 \times \text{RBW}]$.
5. Detector = peak.
6. Sweep time = No faster than coupled (auto) time.
7. Trace mode = max-hold.
8. Allow trace to fully stabilize.
9. Use the peak marker function to determine the maximum amplitude level within the RBW.
10. If measured value exceeds requirement, then reduce RBW (but no less than 3 kHz) and repeat.

6.4.4. Test Setup

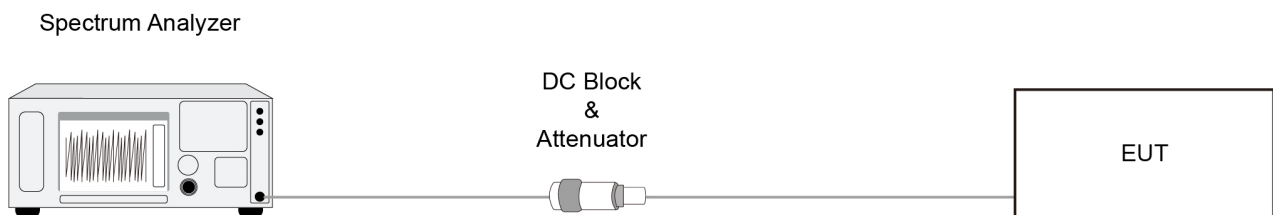

6.4.5. Test Result

Refer to Appendix A.4.

6.5. Conducted Band Edge and Out-of-Band Emissions Measurement

6.5.1. Test Limit

The limit for out-of-band spurious emissions at the band edge is 20dB below the fundamental emission level, as determined from the in-band power measurement of the DTS channel performed in a 100 kHz bandwidth per the PSD procedure.

6.5.2. Test Procedure

ANSI C63.10-2013 - Section 11.11

6.5.3. Test Setting

Reference level measurement

1. Set instrument center frequency to DTS channel center frequency
2. Set the span to ≥ 1.5 times the DTS bandwidth
3. Set the RBW = 100 kHz
4. Set the VBW $\geq 3 \times$ RBW
5. Detector = peak
6. Sweep time = auto couple
7. Trace mode = max hold
8. Allow trace to fully stabilize

Emission level measurement

1. Set the center frequency and span to encompass frequency range to be measured
2. RBW = 100kHz
3. VBW = 300kHz
4. Detector = Peak
5. Trace mode = max hold
6. Sweep time = auto couple
7. The trace was allowed to stabilize

6.5.4. Test Setup

Spectrum Analyzer

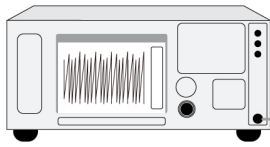

DC Block
&
Attenuator



6.5.5. Test Result

Refer to Appendix A.5.

6.6. Radiated Spurious Emission Measurement

6.6.1. Test Limit

All out of band emissions appearing in a restricted band as specified in Section 15.205 of the Title 47 CFR must not exceed the limits shown in Table per Section 15.209.

FCC Part 15 Subpart C Paragraph 15.209		
Frequency [MHz]	Field Strength [uV/m]	Measured Distance [Meters]
0.009 - 0.490	2400/F (kHz)	300
0.490 - 1.705	24000/F (kHz)	30
1.705 - 30	30	30
30 - 88	100	3
88 - 216	150	3
216 - 960	200	3
Above 960	500	3

6.6.2. Test Procedure

ANSI C63.10 - 2013 - Section 11.11 & 11.12

ANSI C63.10 - 2013 - Section 6.3 (General Requirements)

ANSI C63.10 - 2013 - Section 6.4 (Standard test method below 30MHz)

ANSI C63.10 - 2013 - Section 6.5 (Standard test method above 30MHz to 1GHz)

ANSI C63.10 - 2013 - Section 6.6 (Standard test method above 1GHz)

6.6.3. Test Setting

Table 1 - RBW as a function of frequency

Frequency	RBW
9 ~ 150 kHz	200 ~ 300 Hz
0.15 ~ 30 MHz	9 ~ 10 kHz
30 ~ 1000 MHz	100 ~ 120 kHz
> 1000MHz	1MHz

Quasi-Peak Measurements below 1GHz

1. Analyzer center frequency was set to the frequency of the radiated spurious emission of interest
2. Span was set greater than 1MHz
3. RBW = as specified in Table 1
4. Detector = CISPR quasi-peak
5. Sweep time = auto couple
6. Trace was allowed to stabilize

Peak Measurements above 1GHz

1. Analyzer center frequency was set to the frequency of the radiated spurious emission of interest
2. RBW = 1MHz
3. VBW = 3MHz
4. Detector = peak
5. Sweep time = auto couple
6. Trace mode = max hold
7. Trace was allowed to stabilize

Average Measurements above 1GHz (Method VB)

1. Analyzer center frequency was set to the frequency of the radiated spurious emission of interest
2. RBW = 1MHz
3. VBW; If the EUT is configured to transmit with duty cycle $\geq 98\%$, set VBW = 10 Hz.
If the EUT duty cycle is $< 98\%$, set VBW $\geq 1/T$. T is the minimum transmission duration.
4. Detector = Peak
5. Sweep time = auto
6. Trace mode = max hold
7. Trace was allowed to stabilize

6.6.4. Test Setup

Below 30MHz Test Setup:

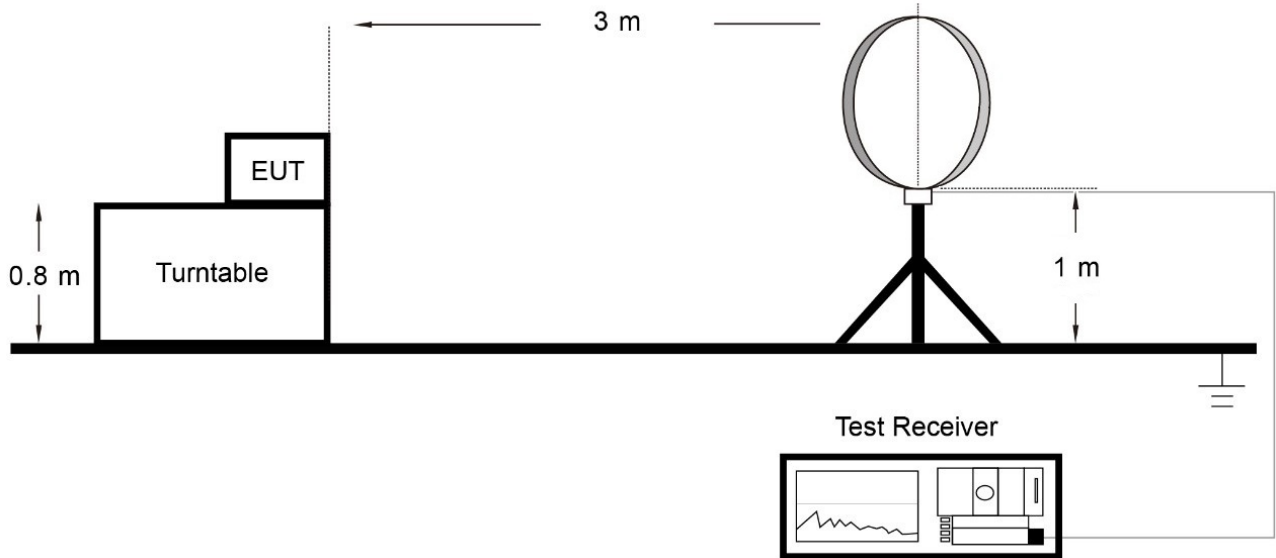

Below 1GHz Test Setup:

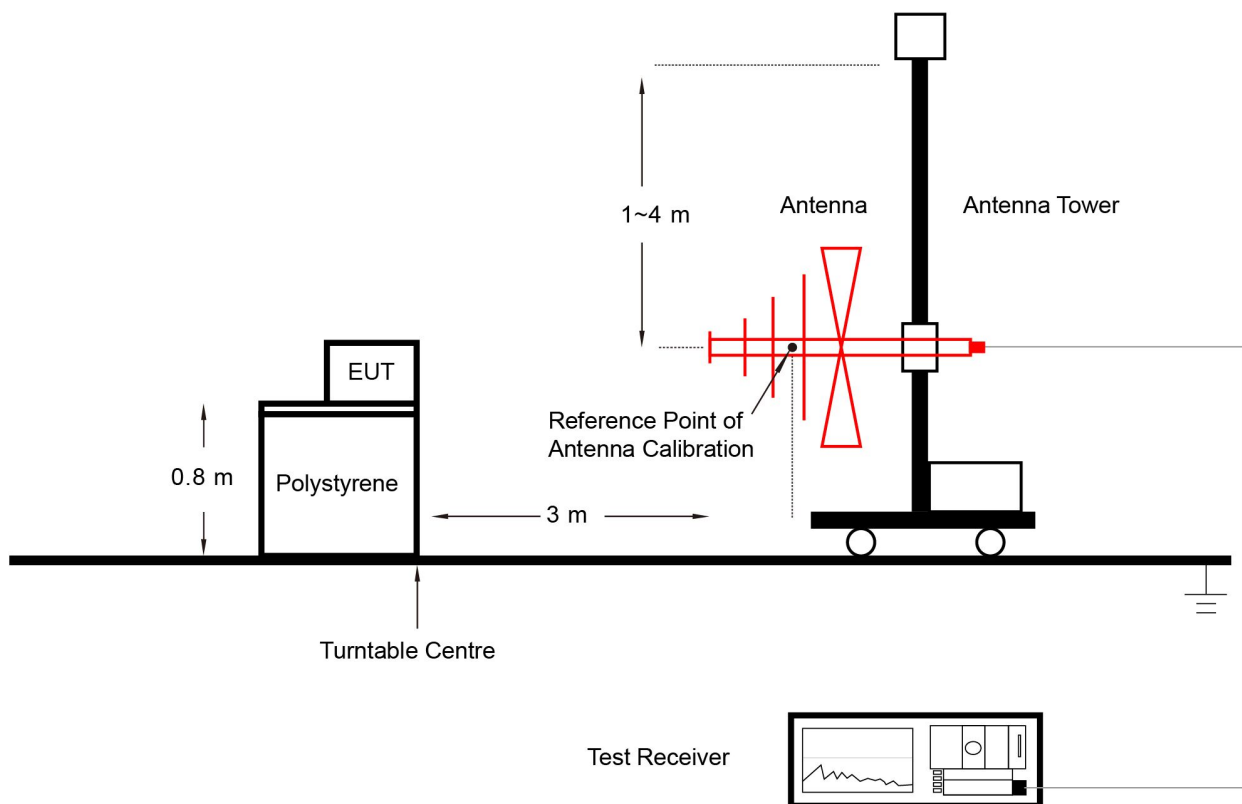

Above 1GHz Test Setup:

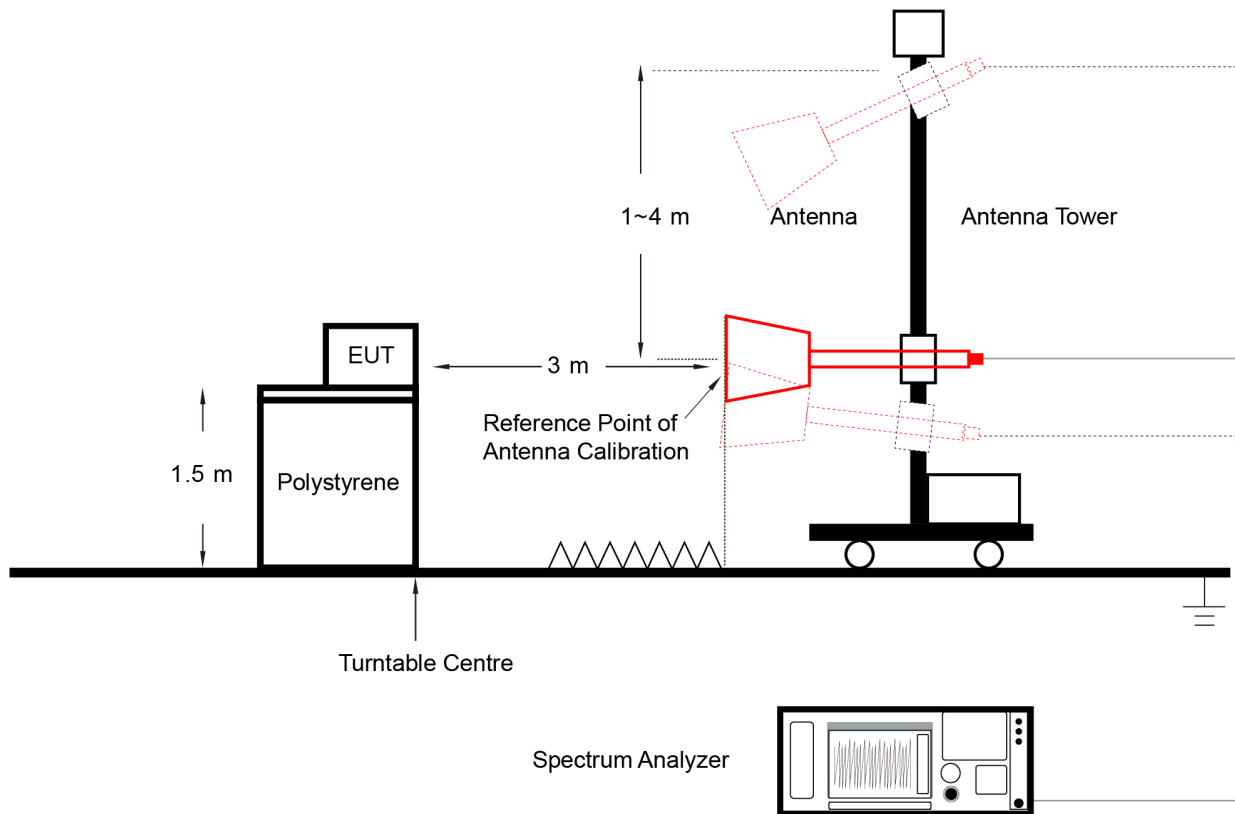

6.6.5. Test Result

Refer to Appendix A.6.

6.7. Radiated Restricted Band Edge Measurement

6.7.1. Test Limit

For 15.205 requirement:

Radiated emissions which fall in the restricted bands, as defined in Section 15.205(a) of FCC part 15, must also comply with the radiated emission limits specified in Section 15.209(a).

Frequency (MHz)	Frequency (MHz)	Frequency (MHz)	Frequency (GHz)
0.090 - 0.110	16.42 - 16.423	399.9 - 410	4.5 - 5.15
¹ 0.495 - 0.505	16.69475 - 16.69525	608 - 614	5.35 - 5.46
2.1735 - 2.1905	16.80425 - 16.80475	960 - 1240	7.25 - 7.75
4.125 - 4.128	25.5 - 25.67	1300 - 1427	8.025 - 8.5
4.17725 - 4.17775	37.5 - 38.25	1435 - 1626.5	9.0 - 9.2
4.20725 - 4.20775	73 - 74.6	1645.5 - 1646.5	9.3 - 9.5
6.215 - 6.218	74.8 - 75.2	1660 - 1710	10.6 - 12.7
6.26775 - 6.26825	108 - 121.94	1718.8 - 1722.2	13.25 - 13.4
6.31175 - 6.31225	123 - 138	2200 - 2300	14.47 - 14.5
8.291 - 8.294	149.9 - 150.05	2310 - 2390	15.35 - 16.2
8.362 - 8.366	156.52475 - 156.52525	2483.5 - 2500	17.7 - 21.4
8.37625 - 8.38675	156.7 - 156.9	2690 - 2900	22.01 - 23.12
8.41425 - 8.41475	162.0125 - 167.17	3260 - 3267	23.6 - 24.0
12.29 - 12.293	167.72 - 173.2	3332 - 3339	31.2 - 31.8
12.51975 - 12.52025	240 - 285	3345.8 - 3358	36.43 - 36.5
12.57675 - 12.57725	322 - 335.4	3600 - 4400	(²)
13.36 - 13.41	--	--	--

All out of band emissions appearing in a restricted band as specified in Section 15.205 of the Title 47CFR must not exceed the limits shown in Table per Section 15.209.

FCC Part 15 Subpart C Paragraph 15.209		
Frequency [MHz]	Field Strength [uV/m]	Measured Distance [Meters]
0.009 - 0.490	2400/F (kHz)	300
0.490 - 1.705	24000/F (kHz)	30
1.705 - 30	30	30
30 - 88	100	3
88 - 216	150	3
216 - 960	200	3
Above 960	500	3

6.7.2. Test Procedure

ANSI C63.10-2013 Section 6.3 & 6.6 & 11.13

6.7.3. Test Setting

Peak Field Strength Measurements

1. Analyzer center frequency was set to the frequency of the radiated spurious emission of interest
2. RBW = 1MHz
3. VBW = 3MHz
4. Detector = peak
5. Sweep time = auto couple
6. Trace mode = max hold
7. Trace was allowed to stabilize

Average Field Strength Measurements

1. Analyzer center frequency was set to the frequency of the radiated spurious emission of interest
2. RBW = 1MHz
3. VBW $\geq 1/T$
4. As an alternative, the instrument may be set to linear detector mode. Ensure that video filtering is applied in linear voltage domain (rather than in a log or dB domain). Some instruments require linear display mode in order to accomplish this. Others have a setting for Average-VBW Type, which can be set to "Voltage" regardless of the display mode
5. Detector = Peak
6. Sweep time = auto
7. Trace mode = max hold
8. Allow max hold to run for at least 50 times (1/duty cycle) traces

6.7.4. Test Setup

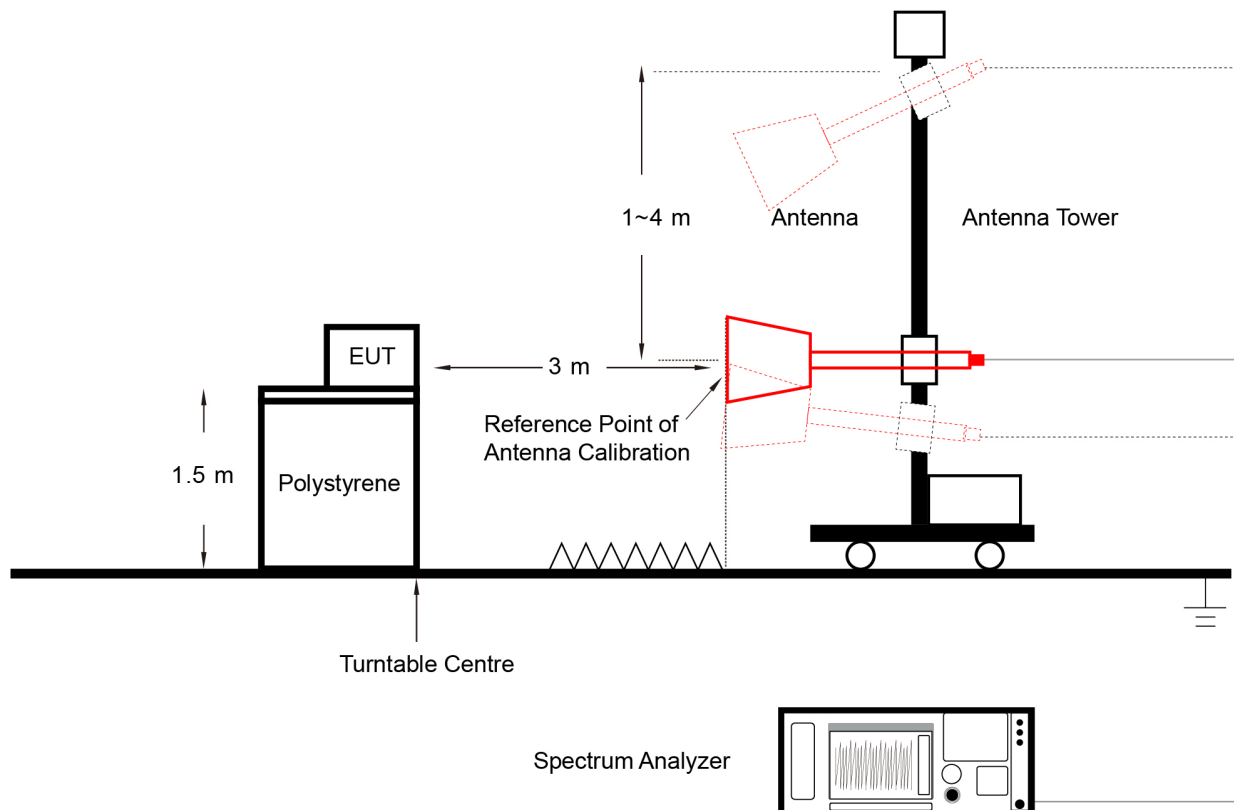

6.7.5. Test Result

Refer to Appendix A.7.

6.8. AC Conducted Emissions Measurement

6.8.1. Test Limit

FCC Part 15 Subpart C Paragraph 15.207 Limits		
Frequency (MHz)	QP (dBuV)	AV (dBuV)
0.15 - 0.50	66 - 56	56 - 46
0.50 - 5.0	56	46
5.0 - 30	60	50

Note 1: The lower limit shall apply at the transition frequencies.

Note 2: The limit decreases linearly with the logarithm of the frequency in the range 0.15MHz to 0.5MHz.

6.8.2. Test Setup

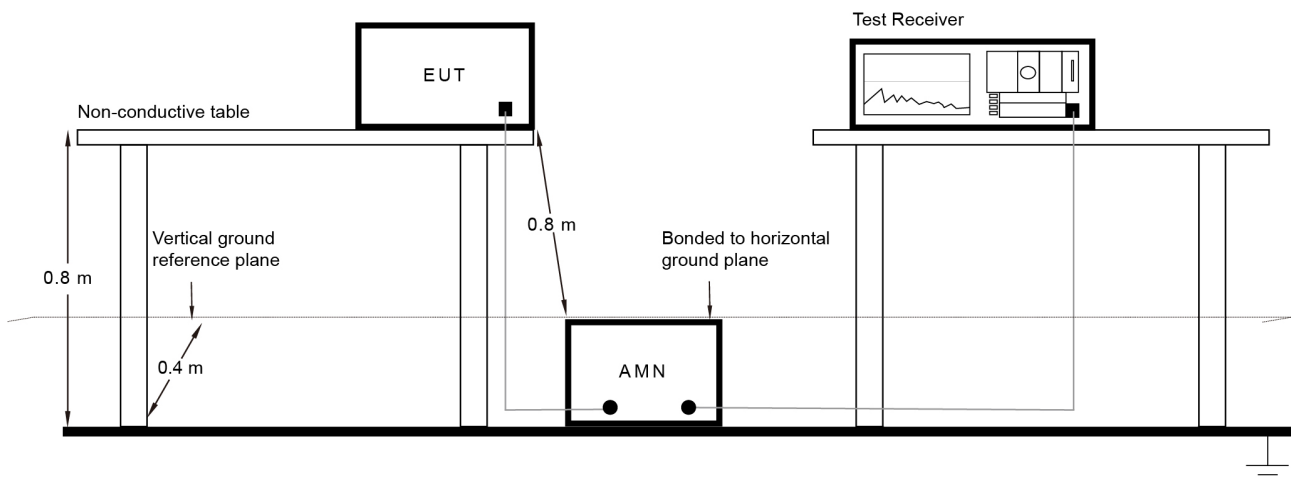

6.8.3. Test Result

Refer to Appendix A.8.

Appendix A – Test Result

A.1 Duty Cycle Test Result

Test Site	SIP-TR1	Test Engineer	Nandy Zhang
Test Date	2023-01-09		

Test Mode	Modulation Type	Duty Cycle
802.15.4	O-QPSK	100.0%
		

Note 1: This duty cycle was only suitable for continuous transmission of signals via commands.

Note 2: The manufacturer, declared that the ZigBee operation, when implemented, will be limited to a max duty cycle of 0.48% or less in any 100ms period (Detail see operation description). So -46.38dB correction factor was used during the radiated emission testing.

A.2 6dB Bandwidth Test Result

Test Site	SIP-TR1	Test Engineer	Nandy Zhang
Test Date	2023-01-09		

Test Mode	Modulation Type	Channel No.	Frequency (MHz)	6dB Bandwidth (MHz)	Limit (MHz)	Result
802.15.4	O-QPSK	11	2405	1.443	≥ 0.5	Pass
802.15.4	O-QPSK	19	2445	1.482	≥ 0.5	Pass
802.15.4	O-QPSK	26	2480	1.486	≥ 0.5	Pass

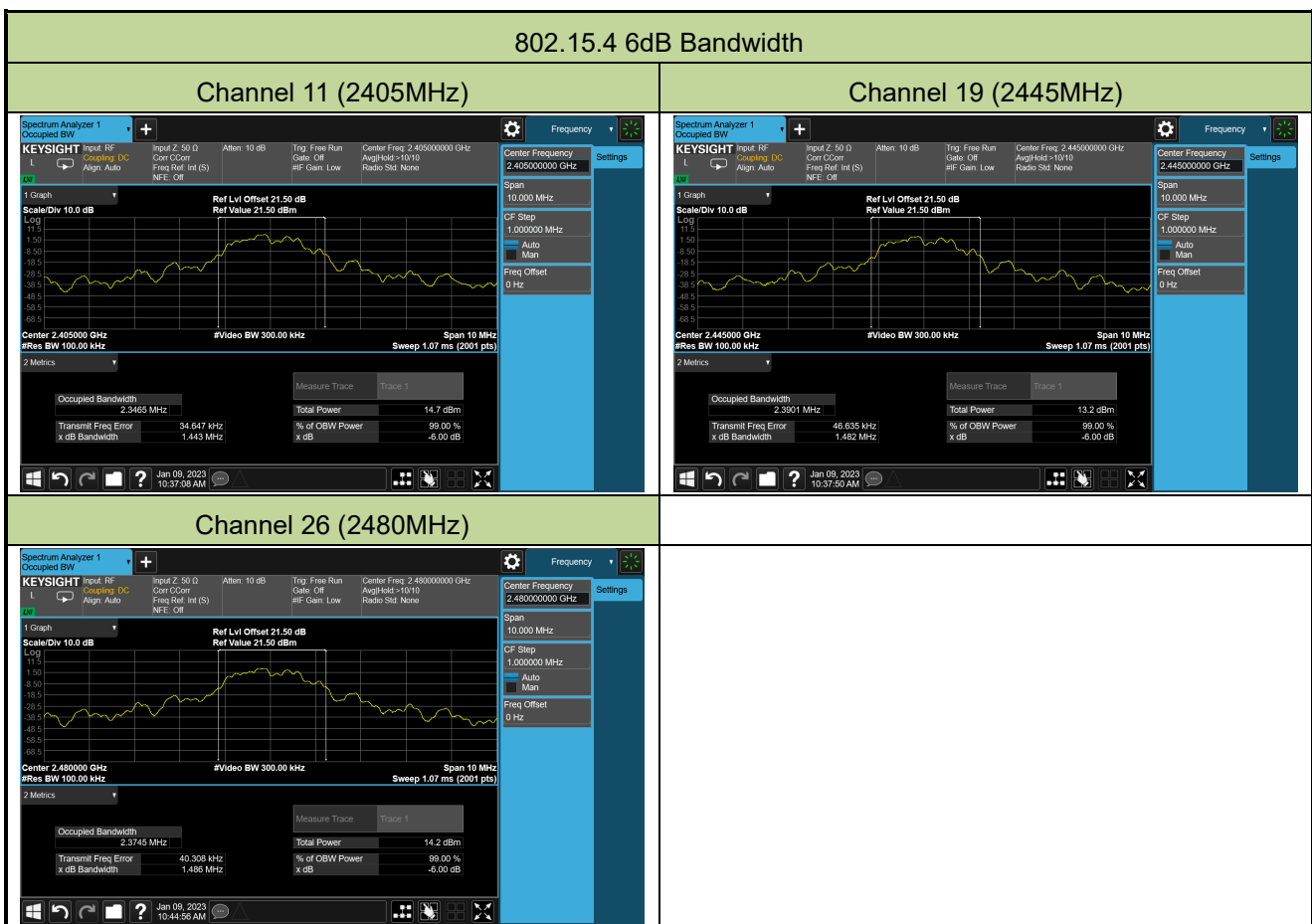

A.3 Output Power Test Result

Test Site	SIP-TR1	Test Engineer	Nandy Zhang
Test Date	2023-01-09		

Test Result of Peak Output Power

Test Mode	Modulation Type	Channel No.	Freq. (MHz)	Peak Power (dBm)	Limit (dBm)	Result
802.15.4	O-QPSK	11	2405	10.47	≤ 30.00	Pass
802.15.4	O-QPSK	19	2445	9.45	≤ 30.00	Pass
802.15.4	O-QPSK	26	2480	10.00	≤ 30.00	Pass

Test Result of Average Output Power (Reporting Only)

Test Mode	Modulation Type	Channel No.	Freq. (MHz)	Average Power (dBm)	Limit (dBm)	Result
802.15.4	O-QPSK	11	2405	9.91	≤ 30.00	Pass
802.15.4	O-QPSK	19	2445	9.16	≤ 30.00	Pass
802.15.4	O-QPSK	26	2480	9.73	≤ 30.00	Pass

A.4 Power Spectral Density Test Result

Test Site	SIP-TR1	Test Engineer	Nandy Zhang
Test Date	2023-01-09		

Test Mode	Modulation Type	Channel No.	Frequency (MHz)	PK PSD (dBm / 3kHz)	Limit (dBm / 3kHz)	Result
802.15.4	O-QPSK	11	2405	0.36	≤ 8.00	Pass
802.15.4	O-QPSK	19	2445	-1.11	≤ 8.00	Pass
802.15.4	O-QPSK	26	2480	0.11	≤ 8.00	Pass

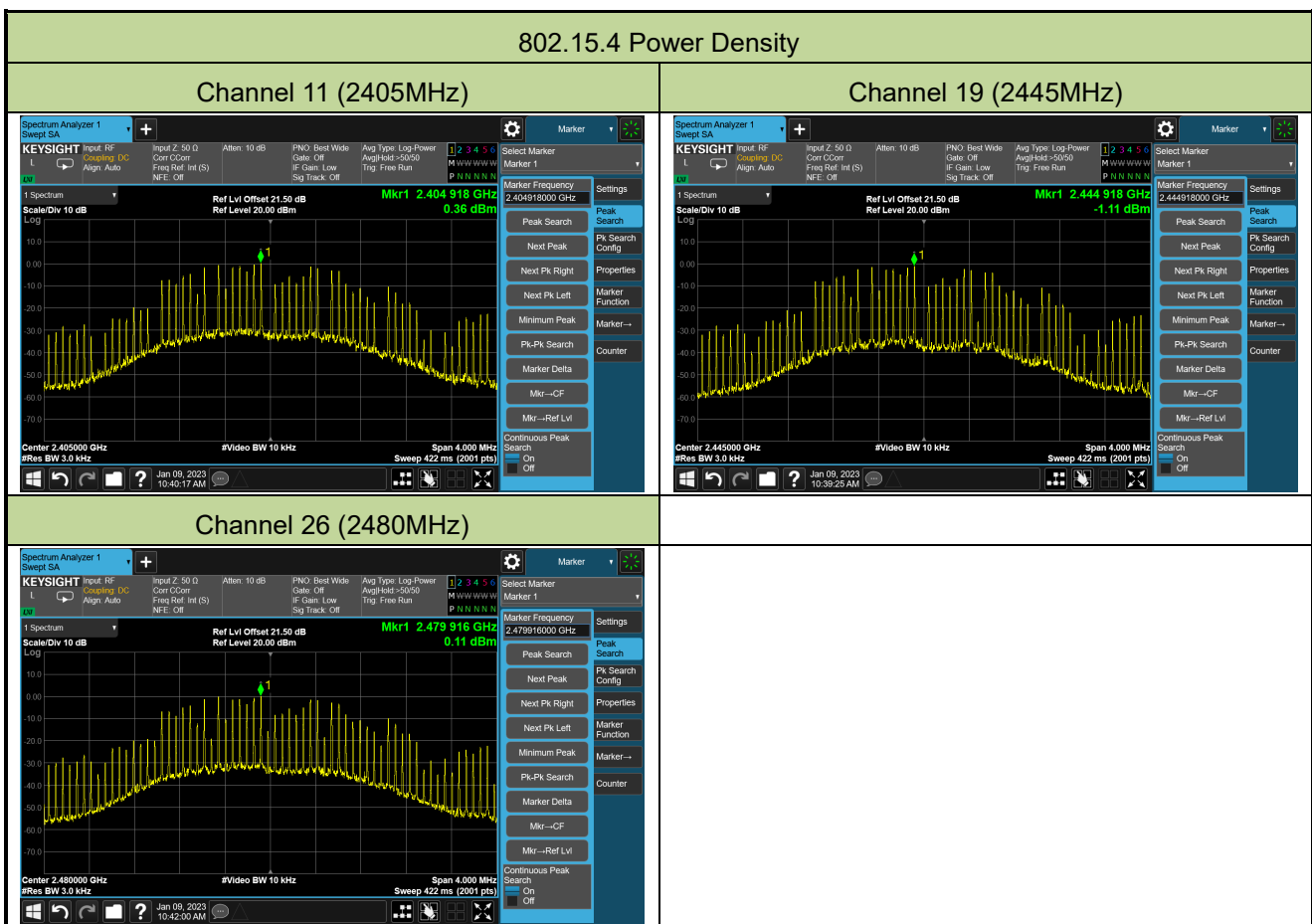

A.5 Conducted Band Edge and Out-of-Band Emissions Test Result

Test Site	SIP-TR1	Test Engineer	Nandy Zhang
Test Date	2023-01-09		

Test Mode	Modulation Type	Channel No.	Frequency (MHz)	Limit (dBc)	Result
802.15.4	O-QPSK	11	2405	> 20	Pass
802.15.4	O-QPSK	19	2445	> 20	Pass
802.15.4	O-QPSK	26	2480	> 20	Pass

802.15.4 Out-of-Band Emissions

Channel 11 (2405MHz)

100kHz PSD Reference Level

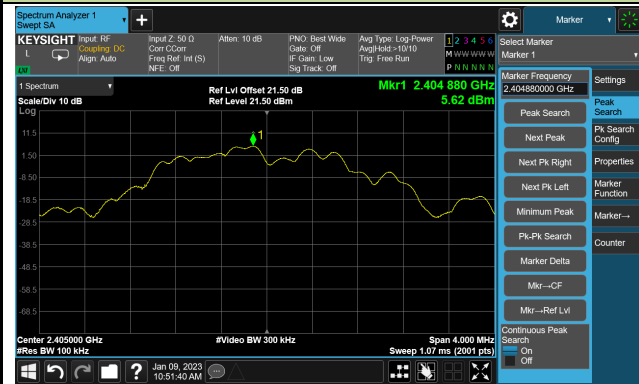

Low Band Edge



Spurious Emission

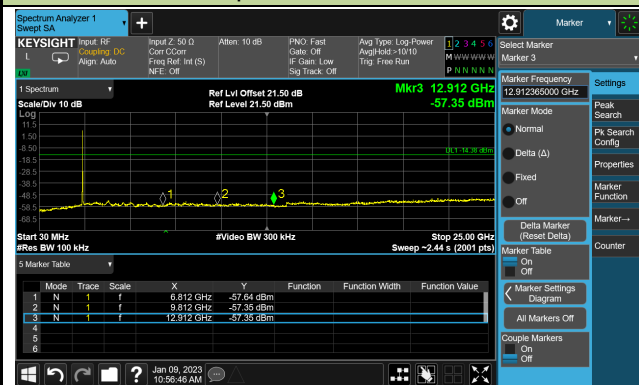

Channel 19 (2445MHz)

100kHz PSD Reference Level



Spurious Emission

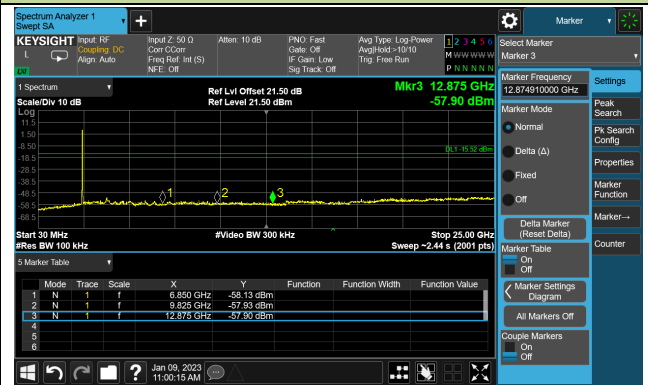

Channel 26 (2480MHz)

100kHz PSD Reference Level



High Band Edge



Spurious Emission

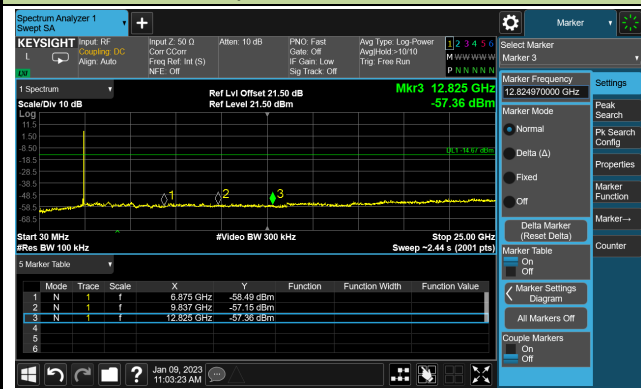

A.6 Radiated Spurious Emission Test Result

Test Site	SIP-AC3	Test Engineer	Arvin Ding
Test Date	2023-01-11		
Remark:	1. Average measurement was not performed if peak level lower than average limit. 2. Other frequency was 20dB below limit line within 1-18GHz, there is not show in the report.		

Test Channel	Frequency (MHz)	Reading Level (dB μ V)	Factor (dB/m)	Measure Level (dB μ V/m)	Limit (dB μ V/m)	Margin (dB)	Detector	Polarization
00	8352.5	48.5	-4.0	44.5	74.0	-29.5	Peak	Horizontal
	11905.5	48.8	-2.8	46.0	74.0	-28.0	Peak	Horizontal
	15705.0	44.0	4.3	48.3	74.0	-25.7	Peak	Horizontal
	8259.0	48.5	-4.0	44.5	74.0	-29.5	Peak	Vertical
	11480.5	48.1	-3.1	45.0	74.0	-29.0	Peak	Vertical
	15662.5	43.8	4.1	47.9	74.0	-26.1	Peak	Vertical
19	8395.0	47.9	-4.0	43.9	74.0	-30.1	Peak	Horizontal
	11718.5	48.5	-3.1	45.4	74.0	-28.6	Peak	Horizontal
	15671.0	45.9	4.2	50.1	74.0	-23.9	Peak	Horizontal
	8403.5	48.6	-4.0	44.6	74.0	-29.4	Peak	Vertical
	10749.5	47.9	-2.6	45.3	74.0	-28.7	Peak	Vertical
	15628.5	45.7	4.2	49.9	74.0	-24.1	Peak	Vertical
26	8165.5	48.4	-4.5	43.9	74.0	-30.1	Peak	Horizontal
	11174.5	48.2	-2.9	45.3	74.0	-28.7	Peak	Horizontal
	15433.0	45.5	4.2	49.7	74.0	-24.3	Peak	Horizontal
	8395.0	48.3	-4.0	44.3	74.0	-29.7	Peak	Vertical
	11047.0	47.9	-2.4	45.5	74.0	-28.5	Peak	Vertical
	15892.0	45.3	4.2	49.5	74.0	-24.5	Peak	Vertical

Note: Measure Level (dB μ V/m) = Reading Level (dB μ V) + Factor (dB/m)

Factor ((dB/m) = Cable Loss (dB) + Antenna Factor (dB/m) - Pre_Amplifier Gain (dB)

The Result of Radiated Emission below 1GHz:

Site: SIP-AC3	Test Date: 2023-01-11
Limit: FCC_Part15.209_RSE(3m)	Engineer: Wayne Wang
Probe: VULB 9168_00997_25-2000MHz	Polarity: Horizontal
EUT: Digital Plug-on Transmitter	Power: By Battery
Test Mode: Transmit by Zigbee at 2405MHz	

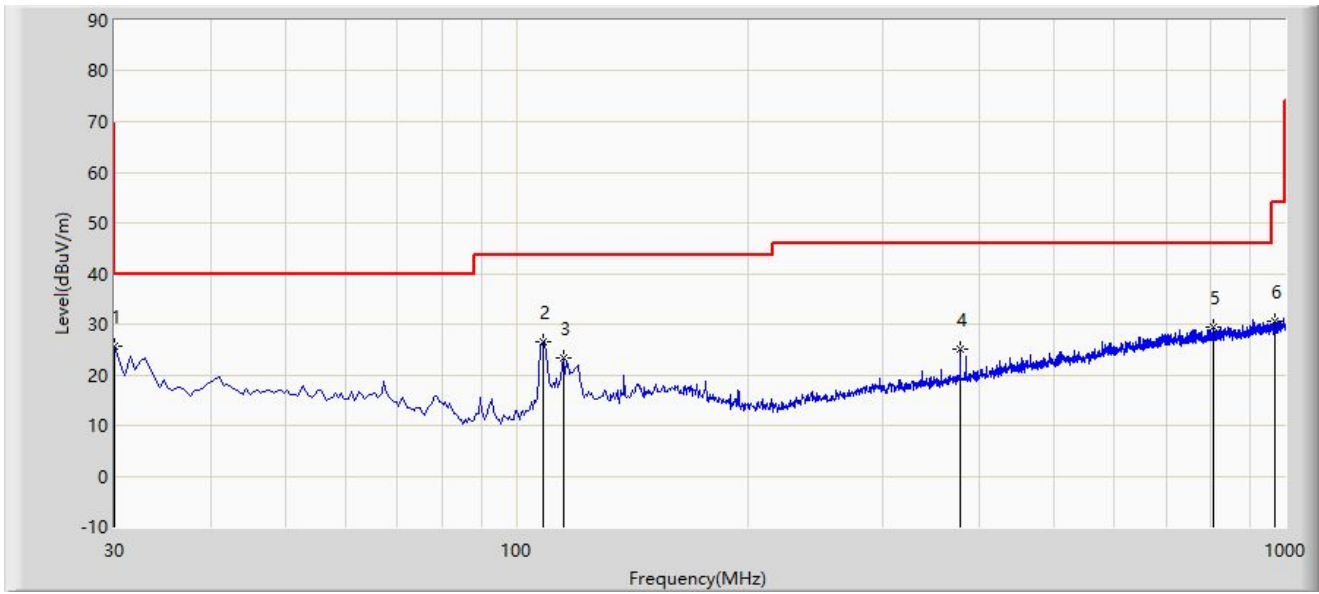

No	Mark	Frequency (MHz)	Measure Level (dB μ V/m)	Reading Level (dB μ V)	Margin (dB)	Limit (dB μ V/m)	Factor (dB/m)	Type
1	*	30.000	25.715	9.524	-14.285	40.000	16.191	PK
2		108.570	26.592	11.915	-16.908	43.500	14.677	PK
3		115.360	23.305	7.999	-20.195	43.500	15.306	PK
4		377.745	25.049	4.655	-20.951	46.000	20.394	PK
5		807.455	29.426	0.859	-16.574	46.000	28.567	PK
6		970.900	30.687	0.808	-23.313	54.000	29.879	PK

Note 1: " * ", means this data is the worst emission level.

Note 2: Measure Level (dB μ V/m) = Reading Level (dB μ V) + Factor (dB/m).

Note 3: Factor (dB/m) = Cable Loss (dB) + Antenna Factor (dB/m).

Note 4: Quasi-Peak measurement was not performed when peak measure level was lower than the quasi-peak limit.

Note 5: The amplitude of radiated emissions (frequency range from 9kHz to 30MHz and 18GHz to 25GHz) is that proximity to ambient noise, which also are attenuated more than 20 dB below the permissible value.

Therefore, the data is not presented in the report.

Site: SIP-AC3	Test Date: 2023-01-11
Limit: FCC_Part15.209_RSE(3m)	Engineer: Wayne Wang
Probe: VULB 9168_00997_25-2000MHz	Polarity: Vertical
EUT: Digital Plug-on Transmitter	Power: By Battery
Test Mode: Transmit by Zigbee at 2405MHz	

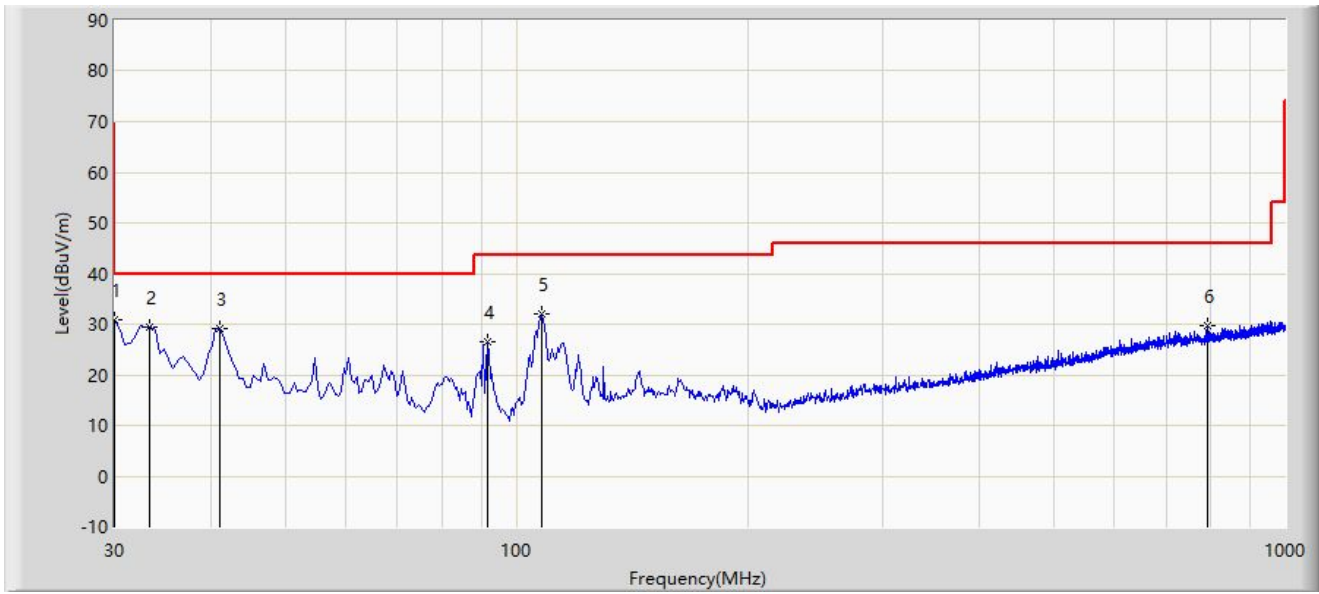

No	Mark	Frequency (MHz)	Measure Level (dBμV/m)	Reading Level (dBμV)	Margin (dB)	Limit (dBμV/m)	Factor (dB/m)	Type
1	*	30.000	30.812	14.621	-9.188	40.000	16.191	PK
2		33.395	29.306	12.491	-10.694	40.000	16.816	PK
3		41.155	29.148	11.449	-10.852	40.000	17.700	PK
4		91.595	26.506	14.360	-16.994	43.500	12.146	PK
5		108.085	31.948	17.323	-11.552	43.500	14.625	PK
6		792.905	29.767	1.397	-16.233	46.000	28.370	PK

Note 1: " * ", means this data is the worst emission level.

Note 2: Measure Level (dBμV/m) = Reading Level (dBμV) + Factor (dB/m).

Note 3: Factor (dB/m) = Cable Loss (dB) + Antenna Factor (dB/m).

Note 4: Quasi-Peak measurement was not performed when peak measure level was lower than the quasi-peak limit.

Note 5: The amplitude of radiated emissions (frequency range from 9kHz to 30MHz and 18GHz to 25GHz) is that proximity to ambient noise, which also are attenuated more than 20 dB below the permissible value.

Therefore, the data is not presented in the report.

A.7 Radiated Restricted Band Edge Test Result

Site: SIP-AC3	Test Date: 2023-01-10
Limit: FCC_2.4G_RE(3m)	Engineer: Wayne Wang
Probe: HF907_102861_1-18GHz	Polarity: Horizontal
EUT: Digital Plug-on Transmitter	Power: By Battery
Test Mode: Transmit at 2405M by Zigbee	

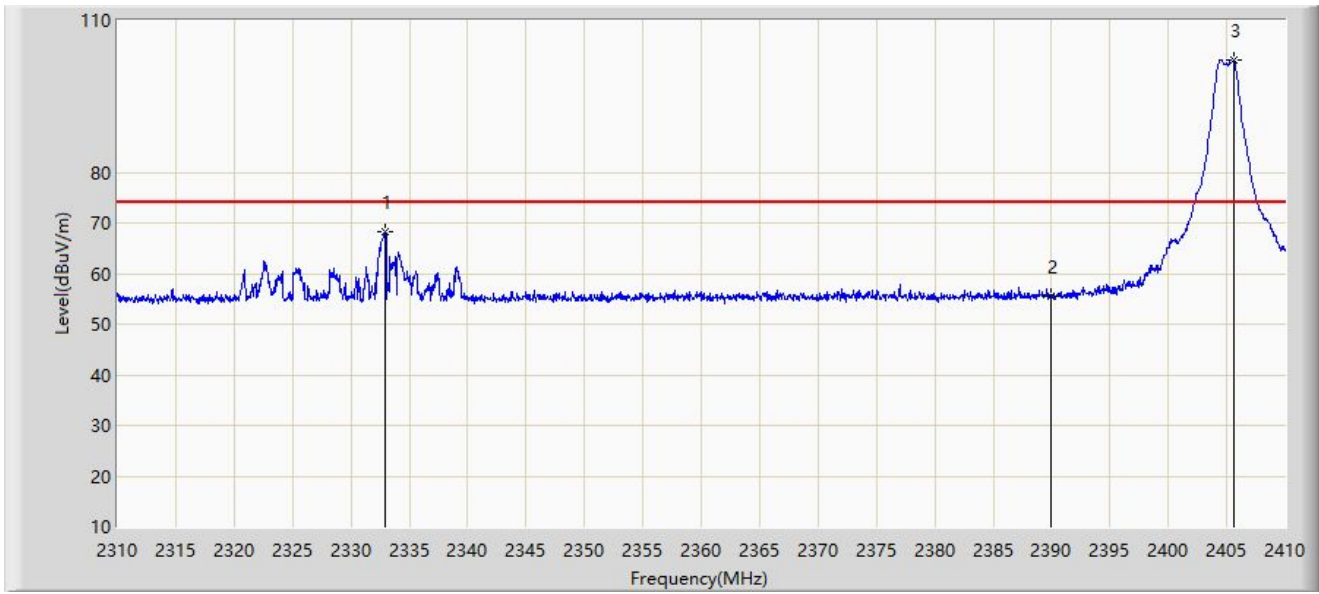

No	Mark	Frequency (MHz)	Measure Level (dB μ V/m)	Reading Level (dB μ V)	Duty cycle Factor (dB)	Margin (dB)	Limit (dB μ V/m)	Factor (dB/m)	Type
1	*	2332.950	68.374	36.586	N/A	-5.626	74.000	31.787	PK
1	*	2332.950	21.994	N/A	-46.38	-32.006	54.000	N/A	AV
2		2390.000	55.470	23.541	N/A	-18.530	74.000	31.929	PK
2		2390.000	9.090	N/A	-46.38	-44.910	54.000	N/A	AV
3		2405.600	102.237	70.198	N/A	N/A	N/A	32.039	PK

Note 1: " * ", means this data is the worst emission level.

Note 2: Measure Level (dB μ V/m) = Reading Level (dB μ V) + Factor (dB/m).

Note 3: Factor (dB/m) = Cable Loss (dB) + Antenna Factor (dB/m).

Note 4: Average Measure Level (dB μ V/m) = Peak Measure Level (dB μ V/m) + Duty cycle Factor (dB)

Site: SIP-AC3	Test Date: 2023-01-10
Limit: FCC_2.4G_RE(3m)	Engineer: Wayne Wang
Probe: HF907_102861_1-18GHz	Polarity: Vertical
EUT: Digital Plug-on Transmitter	Power: By Battery
Test Mode: Transmit at 2405M by Zigbee	

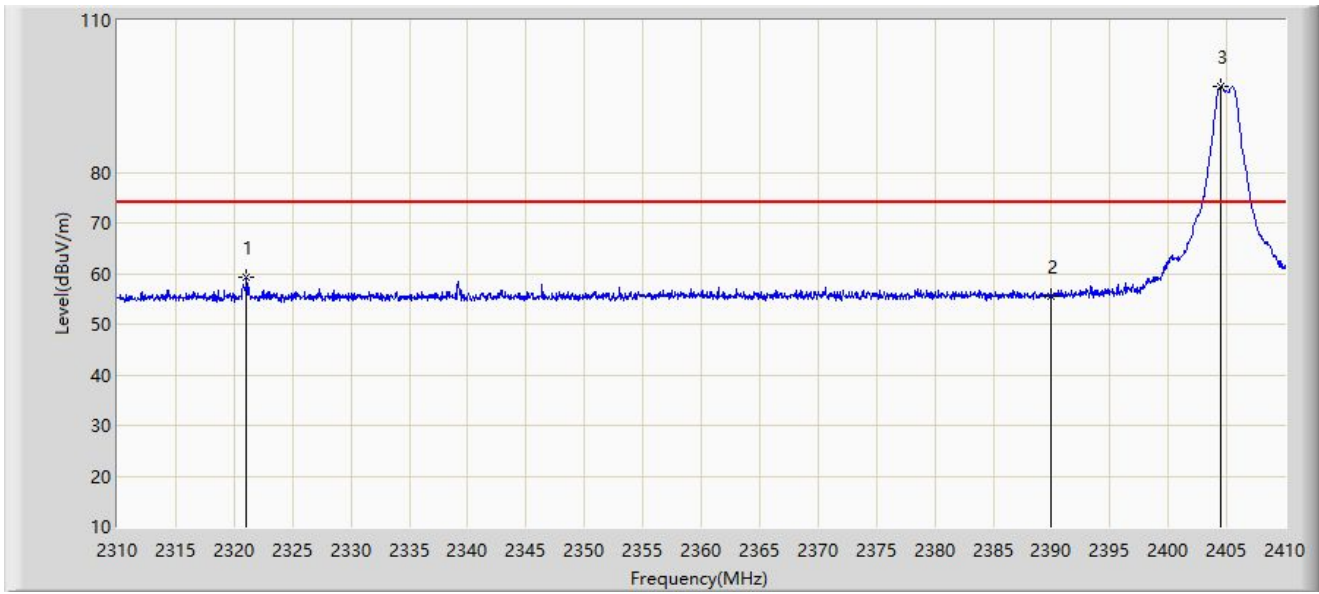

No	Mark	Frequency (MHz)	Measure Level (dBμV/m)	Reading Level (dBμV)	Duty cycle Factor (dB)	Margin (dB)	Limit (dBμV/m)	Factor (dB/m)	Type
1	*	2321.050	59.201	27.445	N/A	-14.799	74.000	31.756	PK
1	*	2321.050	12.821	N/A	-46.38	-41.179	54.000	N/A	AV
2		2390.000	55.386	23.457	N/A	-18.614	74.000	31.929	PK
2		2390.000	9.006	N/A	-46.38	-44.994	54.000	N/A	AV
3		2404.450	96.875	64.845	N/A	N/A	N/A	32.030	PK

Note 1: " * ", means this data is the worst emission level.

Note 2: Measure Level (dBμV/m) = Reading Level (dBμV) + Factor (dB/m).

Note 3: Factor (dB/m) = Cable Loss (dB) + Antenna Factor (dB/m).

Note 4: Average Measure Level (dBμV/m) = Peak Measure Level (dBμV/m) + Duty cycle Factor (dB)

Site: SIP-AC3	Test Date: 2023-01-10
Limit: FCC_2.4G_RE(3m)	Engineer: Wayne Wang
Probe: HF907_102861_1-18GHz	Polarity: Horizontal
EUT: Digital Plug-on Transmitter	Power: By Battery
Test Mode: Transmit at 2480M by Zigbee	

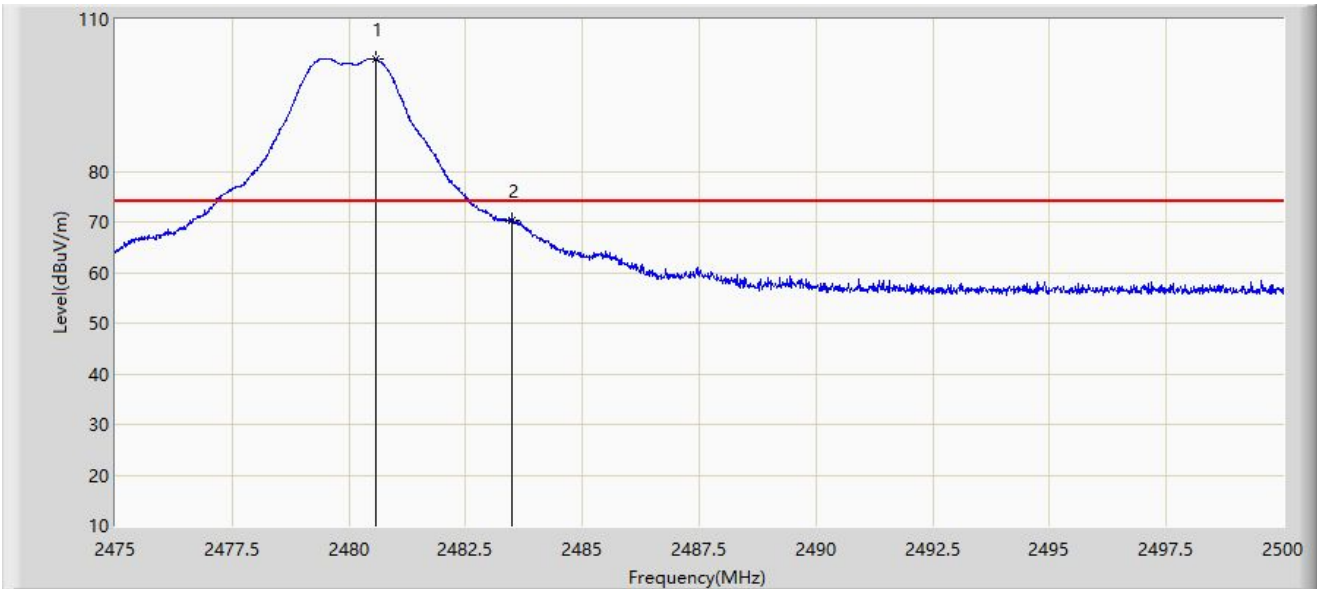

No	Mark	Frequency (MHz)	Measure Level (dB μ V/m)	Reading Level (dB μ V)	Duty cycle Factor (dB)	Margin (dB)	Limit (dB μ V/m)	Factor (dB/m)	Type
1		2480.587	102.110	69.820	N/A	N/A	N/A	32.290	PK
2	*	2483.500	70.175	37.870	N/A	-3.825	74.000	32.305	PK
2	*	2483.500	23.795	N/A	-46.38	-30.205	54.000	N/A	AV

Note 1: " * ", means this data is the worst emission level.

Note 2: Measure Level (dB μ V/m) = Reading Level (dB μ V) + Factor (dB/m).

Note 3: Factor (dB/m) = Cable Loss (dB) + Antenna Factor (dB/m).

Note 4: Average Measure Level (dB μ V/m) = Peak Measure Level (dB μ V/m) + Duty cycle Factor (dB)

Site: SIP-AC3	Test Date: 2023-01-10
Limit: FCC_2.4G_RE(3m)	Engineer: Wayne Wang
Probe: HF907_102861_1-18GHz	Polarity: Vertical
EUT: Digital Plug-on Transmitter	Power: By Battery
Test Mode: Transmit at 2480M by Zigbee	

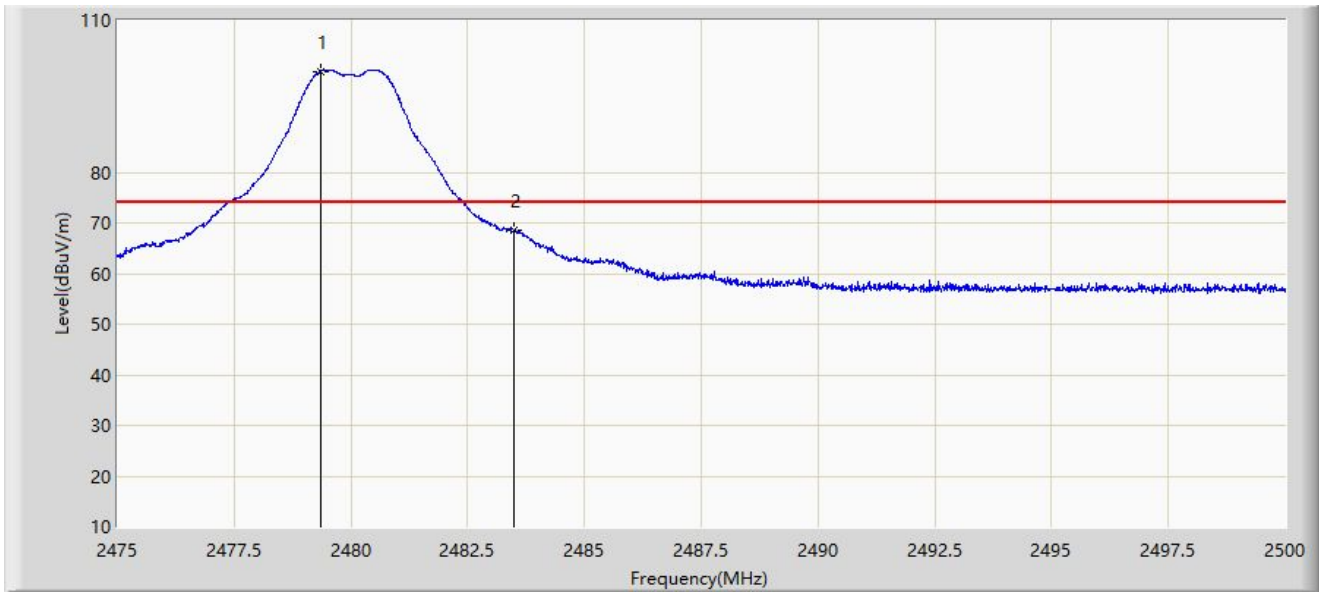

No	Mark	Frequency (MHz)	Measure Level (dBμV/m)	Reading Level (dBμV)	Duty cycle Factor (dB)	Margin (dB)	Limit (dBμV/m)	Factor (dB/m)	Type
1		2479.350	99.982	71.225	N/A	N/A	N/A	28.757	PK
2	*	2483.500	68.620	36.315	N/A	-5.380	74.000	32.305	PK
2	*	2483.500	22.240	N/A	-46.38	-31.760	54.000	N/A	AV

Note 1: " * ", means this data is the worst emission level.

Note 2: Measure Level (dBμV/m) = Reading Level (dBμV) + Factor (dB/m).

Note 3: Factor (dB/m) = Cable Loss (dB) + Antenna Factor (dB/m).

Note 4: Average Measure Level (dBμV/m) = Peak Measure Level (dBμV/m) + Duty cycle Factor (dB)

A.8 AC Conducted Emissions Test Result

Site: SIP-SR2	Test Date: 2023-01-31
Temperature: 20.7°C	Humidity: 30.4%
Limit: FCC_Part15.207_CE_AC Power	Engineer: Miron Ding
Probe: SIP-SR2-ENV216_101684_E	Polarity: Line
EUT: Digital Plug-on Transmitter	Power: AC 120V/60Hz
Test Mode: Transmit at 2405MHz by Zigbee	

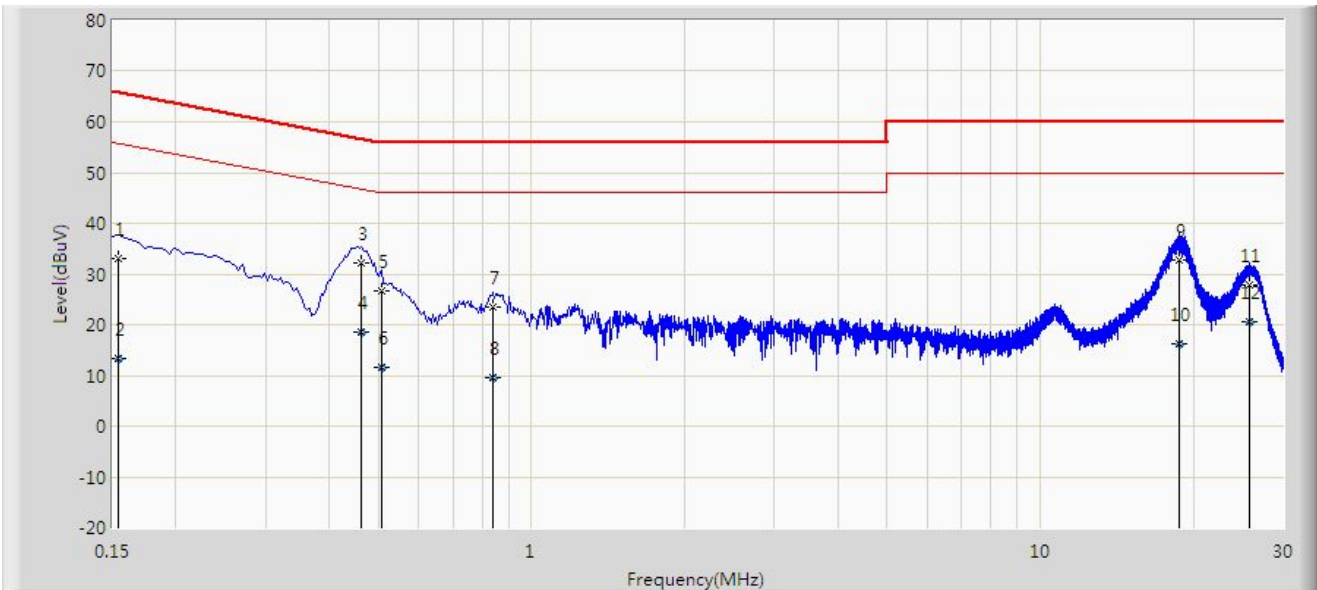

No	Mark	Frequency (MHz)	Measure Level (dBμV)	Reading Level (dBμV)	Margin (dB)	Limit (dBμV)	Factor (dB)	Type
1		0.154	33.167	23.386	-32.615	65.781	9.781	QP
2		0.154	13.298	3.517	-42.483	55.781	9.781	AV
3	*	0.462	32.286	22.426	-24.371	56.657	9.860	QP
4		0.462	18.431	8.571	-28.225	46.657	9.860	AV
5		0.506	26.585	16.725	-29.415	56.000	9.861	QP
6		0.506	11.727	1.866	-34.273	46.000	9.861	AV
7		0.842	23.526	13.659	-32.474	56.000	9.867	QP
8		0.842	9.703	-0.163	-36.297	46.000	9.867	AV
9		18.746	32.760	21.883	-27.240	60.000	10.877	QP
10		18.746	16.237	5.360	-33.763	50.000	10.877	AV
11		25.774	27.844	16.680	-32.156	60.000	11.164	QP
12		25.774	20.539	9.374	-29.461	50.000	11.164	AV

Note 1: " * ", means this data is the worst emission level.

Note 2: Measure Level (dBμV) = Reading Level (dBμV) + Factor (dB).

Note 3: Factor (dB) = Cable Loss (dB) + LISN Factor (dB).

Site: SIP-SR2	Test Date: 2023-01-31
Temperature: 20.7°C	Humidity: 30.4%
Limit: FCC_Part15.207_CE_AC Power	Engineer: Miron Ding
Probe: SIP-SR2-ENV216_101684_E	Polarity: Neutral
EUT: Digital Plug-on Transmitter	Power: AC 120V/60Hz
Test Mode: Transmit at 2405MHz by Zigbee	

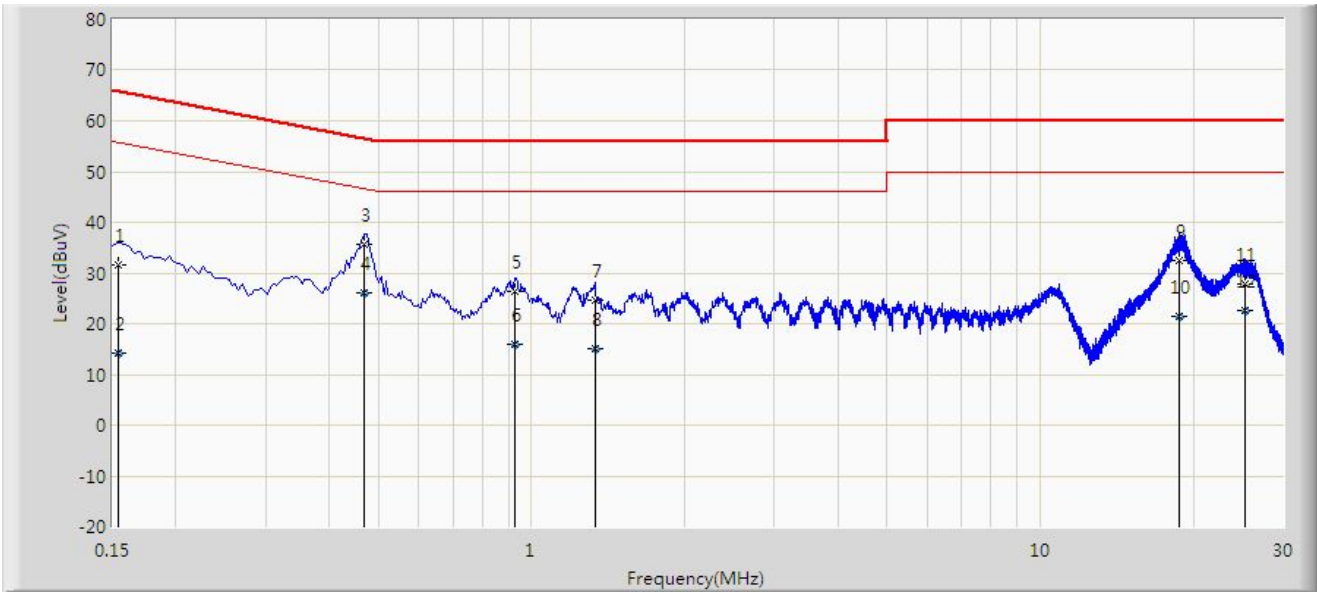

No	Mark	Frequency (MHz)	Measure Level (dBμV)	Reading Level (dBμV)	Margin (dB)	Limit (dBμV)	Factor (dB)	Type
1		0.154	31.597	21.806	-34.184	65.781	9.791	QP
2		0.154	14.347	4.555	-41.435	55.781	9.791	AV
3		0.470	35.602	25.732	-20.912	56.514	9.870	QP
4	*	0.470	26.083	16.213	-20.431	46.514	9.870	AV
5		0.930	26.427	16.557	-29.573	56.000	9.870	QP
6		0.930	15.871	6.001	-30.129	46.000	9.870	AV
7		1.330	24.773	14.883	-31.227	56.000	9.890	QP
8		1.330	14.937	5.047	-31.063	46.000	9.890	AV
9		18.802	32.541	21.635	-27.459	60.000	10.906	QP
10		18.802	21.314	10.407	-28.686	50.000	10.906	AV
11		25.270	27.693	16.428	-32.307	60.000	11.266	QP
12		25.270	22.510	11.245	-27.490	50.000	11.266	AV

Note 1: " * ", means this data is the worst emission level.

Note 2: Measure Level (dBμV) = Reading Level (dBμV) + Factor (dB).

Note 3: Factor (dB) = Cable Loss (dB) + LISN Factor (dB).

Appendix B – Test Setup Photograph

Refer to “2211RSU077-UT” file.

Appendix C – EUT Photograph

Refer to “2211RSU077-UE” file.

_____ The End _____