



MEASUREMENT REPORT

FCC PART 74 Subpart H

FCC ID: DD4AD3G57
APPLICANT: Shure Incorporated
Application Type: Certification
Product: Digital Plug-on Transmitter
Model No.: AD3 G57, AD3 G57+
Brand Name: 
FCC Classification: Licensed LPAS Device (TLD)
FCC Rule Part(s): Part 74 Subpart H (Section 74.861)
Test Procedure(s): ANSI C63.26-2015, KDB 206256 D01v02
ETSI EN 300 422-1 V1.4.2 (2011-08)
Test Date: April 24 ~ May 27, 2020

Reviewed By:

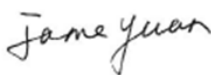

(Jame Yuan)

Approved By:

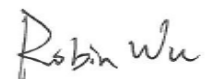

(Robin Wu)



The test results relate only to the samples tested.

The test results shown in the test report are traceable to the national/international standards through the calibration of the equipment and evaluated measurement uncertainty herein.

The test report shall not be reproduced except in full without the written approval of MRT Technology (Suzhou) Co., Ltd.

Revision History

Report No.	Version	Description	Issue Date	Note
2004RSU052-U2	Rev. 01	Initial Report	05-27-2020	Valid

CONTENTS

Description	Page
1. INTRODUCTION	6
1.1. Scope	6
1.2. MRT Test Location	6
2. PRODUCT INFORMATION	7
2.1. Equipment Description.....	7
2.2. Product Specification Subjective to this Report.....	7
2.3. Working Frequencies for this report	7
2.4. Test Software	8
2.5. EMI Suppression Device(s) / Modifications	8
2.6. Labeling Requirements	8
3. DESCRIPTION OF TEST	9
3.1. Evaluation Procedure	9
3.2. Radiated Measurement.....	9
4. TEST EQUIPMENT CALIBRATION DATE	11
5. MEASUREMENT UNCERTAINTY	13
6. TEST RESULT	14
6.1. Summary	14
6.2. RF Output Power Measurement	15
6.2.1. Test Limit	15
6.2.2. Test Procedure Used	15
6.2.3. Test Setting.....	15
6.2.4. Test Setup.....	15
6.2.5. Test Result.....	16
6.3. Frequency Tolerance Measurement	17
6.3.1. Test Limit	17
6.3.2. Test Procedure	17
6.3.3. Test Setting.....	17
6.3.4. Test Setup.....	18
6.3.5. Test Result.....	19
6.4. 99% Occupied Bandwidth Measurement	21
6.4.1. Test Limit	21
6.4.2. Test Procedure used.....	21
6.4.3. Test Setting.....	21
6.4.4. Test Setup.....	21

6.4.5. Test Result.....	22
6.5. Out-of-band Emission Mask Measurement.....	25
6.5.1. Test Limit	25
6.5.2. Test Procedure Used	25
6.5.3. Test Setting.....	25
6.5.4. Test Setup.....	26
6.5.5. Test Result.....	27
6.6. Necessary Bandwidth Measurement.....	32
6.6.1. Test Limit	32
6.6.2. Test Procedure Used	32
6.6.3. Test Setting.....	32
6.6.4. Test Setup.....	33
6.6.5. Test Result.....	34
6.7. Radiated Spurious Emissions Measurement.....	46
6.7.1. Test Limit	46
6.7.2. Test Procedure Used	46
6.7.3. Test Setting.....	46
6.7.4. Test Setup.....	47
6.7.5. Test Result.....	48
7. CONCLUSION.....	50
Appendix A – Test Setup Photograph.....	51
Appendix B – EUT Photograph	52

General Information

Applicant:	Shure Incorporated
Applicant Address:	5800 West Touhy Avenue, Niles, IL 60714-4608, USA
Manufacturer:	Shure Incorporated
Manufacturer Address:	5800 West Touhy Avenue, Niles, IL 60714-4608, USA
Test Site:	MRT Technology (Suzhou) Co., Ltd
Test Site Address:	D8 Building, No.2 Tian'edang Rd., Wuzhong Economic Development Zone, Suzhou, China
Test Device Serial No.:	N/A <input type="checkbox"/> Production <input checked="" type="checkbox"/> Pre-Production <input type="checkbox"/> Engineering

Test Facility / Accreditations

Measurements were performed at MRT Laboratory located in Tian'edang Rd., Suzhou, China.

- MRT facility is a FCC accredited (MRT Designation No. CN1166) test facility with the site description report on file and has met all the requirements specified in ANSI C63.4-2014.
- MRT facility is an IC registered (MRT Reg. No. 11384A-1) test laboratory with the site description on file at Industry Canada.
- MRT facility is a VCCI registered (R-20025, G-20034, C-20020, T-20020) test laboratory with the site description on file at VCCI Council.
- MRT Lab is accredited to ISO 17025 by the American Association for Laboratory Accreditation (A2LA) under the American Association for Laboratory Accreditation Program (A2LA Cert. No. 3628.01) in EMC, Telecommunications, Radio and SAR testing.



1. INTRODUCTION

1.1. Scope

Measurement and determination of electromagnetic emissions (EMC) of radio frequency devices including intentional and/or unintentional radiators for compliance with the technical rules and regulations of the Federal Communications Commission and the Innovation, Science and Economic Development Canada and Certification and Engineering Bureau.

1.2. MRT Test Location

The map below shows the location of the MRT LABORATORY, its proximity to the Taihu Lake. These measurement tests were conducted at the MRT Technology (Suzhou) Co., Ltd. Facility located at D8 Building, No.2 Tian'edang Rd., Wuzhong Economic Development Zone, Suzhou, China. The measurement facility compliant with the test site requirements specified in ANSI C63.4-2014.



2. PRODUCT INFORMATION

2.1. Equipment Description

Product Name	Digital Plug-on Transmitter
Model No.	AD3 G57, AD3 G57+
Frequency Range	470 ~ 608 MHz, 614 ~ 616 MHz
Power Type	Two AA batteries (3.0Vdc) or SB900A Li-ion battery
Working Voltage	1.9 ~ 4.2 Vdc
Working Mode	STD Mode and HD Mode (Note 3)
Operating Temperature	-10 ~ 50°C
Accessories	
Rechargeable	Model: SB900A
Li-ion Battery	Output: 3.7Vdc, 1320mAh, 4.88Wh

Note 1: Difference between models is only for different market, any others are same.

Note 2: We selected AD3 G57+ to perform all RF testing.

Note 3: STD means normal channel bandwidth mode, HD means high density channel bandwidth.

End user can switch working modes through the digital wireless receiver.

2.2. Product Specification Subjective to this Report

Frequency Range	470 ~ 608 MHz
Declared Power Level	STD: 2mW & 10mW & 35mW, HD: 2mW
Type of Modulation	16QAM
Channel Spacing	25kHz

Note 1: For other features of this EUT, test report will be issued separately.

Note 2: Power level and transmit frequency can be selected using the front panel controls.

2.3. Working Frequencies for this report

Bottom Channel (MHz)	Middle Channel (MHz)	Top Channel (MHz)
470.125	539.000	607.875

2.4. Test Software

The test utility software used during testing was “IPOP”, and the version was V4.1, all test commands were provided by the manufacturer.

2.5. EMI Suppression Device(s) / Modifications

No EMI suppression device(s) were added and no modifications were made during testing.

2.6. Labeling Requirements

Per 2.1074 & 15.19; Docket 95-19

The label shall be permanently affixed at a conspicuous location on the device; instruction manual or pamphlet supplied to the user and be readily visible to the purchaser at the time of purchase. However, when the device is so small wherein placement of the label with specified statement is not practical, only the FCC ID must be displayed on the device per Section 15.19(a)(5). Please see attachment for FCC ID label and label location.

3. DESCRIPTION OF TEST

3.1. Evaluation Procedure

The measurement procedure described in the document titled “American National Standard for Compliance Testing of Transmitters used in Licensed Radio Services” (ANSI C63.26-2015) was used in the measurement.

3.2. Radiated Measurement

The radiated test facilities consisted of an indoor 3 meter semi-anechoic chamber used for final measurements and exploratory measurements, when necessary. The measurement area is contained within the semi-anechoic chamber which is shielded from any ambient interference. For measurements above 1GHz absorbers are arranged on the floor between the turn table and the antenna mast in such a way so as to maximize the reduction of reflections. For measurements below 1GHz, the absorbers are removed. A turntable is used for radiated measurement. It is a continuously rotatable, remote controlled, metallic turntable and 2 meters (6.56 ft.) in diameter. The turn table is flush with the raised floor of the chamber in order to maintain its function as a ground plane. An 80cm high PVC support structure is placed on top of the turntable.

For all measurements, the spectrum was scanned through all EUT azimuths and from 1 to 4 meter receive antenna height using a broadband antenna from 30MHz up to the upper frequency shown in 15.33(b)(1) depending on the highest frequency generated or used in the device or on which the device operates or tunes. For frequencies above 1GHz, linearly polarized double ridge horn antennas were used. For frequencies below 30MHz, a calibrated loop antenna was used. When exploratory measurements were necessary, they were performed at 1 meter test distance inside the semi-anechoic chamber using broadband antennas, broadband amplifiers, and spectrum analyzers to determine the frequencies and modes producing the maximum emissions. Sufficient time for the EUT, support equipment, and test equipment was allowed in order for them to warm up to their normal operating condition. The test set-up for frequencies below 1GHz was placed on top of the 0.8 meter high, 1 x 1.5 meter table; and test set-up for frequencies 1-40GHz was placed on top of the 1.5 meter high, 1 x 1.5 meter table. The EUT, support equipment, and interconnecting cables were arranged and manipulated to maximize each emission. Appropriate precaution was taken to ensure that all emissions from the EUT were maximized and investigated. The system configuration, clock speed, mode of operation or video resolution, if applicable, turntable azimuth, and receive antenna height was noted for each frequency found.

Final measurements were made in the semi-anechoic chamber using calibrated, linearly polarized broadband and horn antennas. The test setup was configured to the setup that produced the worst case emissions. The spectrum analyzer was set to investigate all frequencies required for testing to compare the highest radiated disturbances with respect to the specified limits. The turntable containing the EUT was rotated through 360 degrees and the height of the receive antenna was

varied 1 to 4 meters and stopped at the azimuth and height producing the maximum emission. Each emission was maximized by changing the orientation of the EUT through three orthogonal planes and changing the polarity of the receive antenna, which produced the worst-case emissions.

According to 3dB Beam-Width of horn antenna, the horn antenna should be always directed to the EUT when rising height.

4. TEST EQUIPMENT CALIBRATION DATE

Conducted Emissions - SR2

Instrument	Manufacturer	Type No.	Asset No.	Cali. Interval	Cali. Due Date
EMI Test Receiver	R&S	ESR3	MRTSUE06185	1 year	2021/01/18
Two-Line V-Network	R&S	ENV 216	MRTSUE06002	1 year	2020/06/13
Two-Line V-Network	R&S	ENV 216	MRTSUE06003	1 year	2020/06/13
Thermohygrometer	Testo	608-H1	MRTSUE06404	1 year	2020/08/08
Shielding Room	MIX-BEP	Chamber-SR2	MRTSUE06215	N/A	N/A

Radiated Emissions - AC1

Instrument	Manufacturer	Type No.	Asset No.	Cali. Interval	Cali. Due Date
EMI Test Receiver	R&S	ESR7	MRTSUE06001	1 year	2020/08/01
PXA Signal Analyzer	Keysight	9030B	MRTSUE06395	1 year	2020/09/03
Loop Antenna	Schwarzbeck	FMZB 1519	MRTSUE06025	1 year	2020/11/10
Bilog Period Antenna	Schwarzbeck	VULB 9168	MRTSUE06172	1 year	2021/04/03
Broad Band Horn Antenna	Schwarzbeck	BBHA 9120D	MRTSUE06023	1 year	2020/10/13
Broad Band Horn Antenna	Schwarzbeck	BBHA 9170	MRTSUE06024	1 year	2020/12/29
Microwave System Amplifier	Agilent	83017A	MRTSUE06076	1 year	2020/11/15
Preamplifier	Schwarzbeck	BBV 9721	MRTSUE06121	1 year	2020/06/11
Thermohygrometer	Testo	608-H1	MRTSUE06403	1 year	2020/08/08
Anechoic Chamber	TDK	Chamber-AC1	MRTSUE06212	1 year	2021/04/30

Radiated Emission - AC2

Instrument	Manufacturer	Type No.	Asset No.	Cali. Interval	Cali. Due Date
Spectrum Analyzer	Keysight	N9038A	MRTSUE06125	1 year	2020/08/01
Loop Antenna	Schwarzbeck	FMZB 1519	MRTSUE06025	1 year	2020/11/10
Bilog Period Antenna	Schwarzbeck	VULB 9162	MRTSUE06022	1 year	2020/10/13
Horn Antenna	Schwarzbeck	BBHA9120D	MRTSUE06171	1 year	2020/10/27
Broad Band Horn Antenna	Schwarzbeck	BBHA 9170	MRTSUE06024	1 year	2020/12/29
Broadband Coaxial Preamplifier	Schwarzbeck	BBV 9718	MRTSUE06176	1 year	2020/11/15
Preamplifier	Schwarzbeck	BBV 9721	MRTSUE06121	1 year	2020/06/11
Temperature/Humidity Meter	Minggao	ETH529	MRTSUE06170	1 year	2020/12/15
Anechoic Chamber	RIKEN	Chamber-AC2	MRTSUE06213	1 year	2021/04/30

Conducted Test Equipment - TR3

Instrument	Manufacturer	Type No.	Asset No.	Cali. Interval	Cali. Due Date
EXA Signal Analyzer	Agilent	N9020A	MRTSUE06106	1 year	2021/04/14
EXA Signal Analyzer	Keysight	N9010B	MRTSUE06452	1 year	2020/07/11
Signal Analyzer	R&S	FSV40	MRTSUE06218	1 year	2021/04/14
Power Meter	Agilent	U2021XA	MRTSUE06030	1 year	2020/11/18
USB wideband power sensor	Keysight	U2021XA	MRTSUE06446	1 year	2020/06/30
USB wideband power sensor	Keysight	U2021XA	MRTSUE06447	1 year	2020/06/30
Bluetooth Test Set	Anritsu	MT8852B-042	MRTSUE06389	1 year	2020/06/13
Audio Analyzer	Agilent	U8903B	MRTSUE06143	1 year	2020/06/13
Modulation Analyzer	HP	8901A	MRTSUE06098	1 year	2020/10/10
Wideband Radio Communication Tester	R&S	CMW 500	MRTSUE06243	1 year	2020/11/07
DC Power Supply	GWINSTEK	DPS-3303C	MRTSUE06064	N/A	N/A
Temperature & Humidity Chamber	BAOYT	BYH-150CL	MRTSUE06051	1 year	2020/11/07
Thermohygrometer	testo	608-H1	MRTSUE06401	1 year	2020/08/08

Software	Version	Function
EMI Software	V3	EMI Test Software

5. MEASUREMENT UNCERTAINTY

Where relevant, the following test uncertainty levels have been estimated for tests performed on the EUT as specified in CISPR 16-4-2. This uncertainty represents an expanded uncertainty expressed at approximately the 95% confidence level using a coverage factor of $k = 2$.

Conducted Emission Measurement - SR2
The maximum measurement uncertainty is evaluated as: 9kHz~150kHz: 3.84dB 150kHz~30MHz: 3.46dB
Radiated Emission Measurement - AC1
The maximum measurement uncertainty is evaluated as: Horizontal: 30MHz~300MHz: 4.07dB 300MHz~1GHz: 3.63dB 1GHz~18GHz: 4.16dB Vertical: 30MHz~300MHz: 4.18dB 300MHz~1GHz: 3.60dB 1GHz~18GHz: 4.76dB
Radiated Emission Measurement - AC2
The maximum measurement uncertainty is evaluated as: Horizontal: 30MHz~300MHz: 3.75dB 300MHz~1GHz: 3.53dB 1GHz~18GHz: 4.28dB Vertical: 30MHz~300MHz: 3.86dB 300MHz~1GHz: 3.53dB 1GHz~18GHz: 4.33dB

6. TEST RESULT

6.1. Summary

FCC Part Section(s)	Test Description	Test Limit	Test Condition	Test Result	Reference
74.861(e)(1)(ii)	RF Output Power	$\leq 250\text{mW}$ Conducted	Conducted	Pass	Section 6.2
74.861(e)(4)	Frequency Stability	$\pm 0.005\%$		Pass	Section 6.3
74.861(e)(5)	Occupied Bandwidth	$< 200\text{kHz}$		Pass	Section 6.4
74.861(e)(6)	Emission Mask	The mean power of emissions shall be attenuated below the mean output power of the transmitter as below: $(50\% \sim 100\%)*\text{OBW} \geq 25\text{dB}$ $(100\% \sim 250\%)*\text{OBW} \geq 35\text{dB}$ More than $250\%*\text{OBW} \geq 43 + 10*\log(P)\text{dB}$		Pass	Section 6.5
74.861(e)(7)	Necessary Bandwidth	Refer to clause 6.6.1		Pass	Section 6.6
74.861(e)(7)	Radiated Spurious Emission	Refer to clause 6.7.1	Radiated	Pass	Section 6.7

Notes:

- 1) The analyzer plots shown in this section were all taken with a correction table loaded into the analyzer. The correction table was used to account for the losses of the cables and attenuators used as part of the system to connect the EUT to the analyzer at all frequencies of interest.
- 2) All modes of operation and data rates were investigated. For radiated emission test, every axis (X, Y, Z) was also verified. The test results shown in the following sections represent the worst emissions.
- 3) For STD mode, besides necessary bandwidth & emission mask test items were assessed three power levels, any others test items were only assessed max power level.

6.2. RF Output Power Measurement

6.2.1. Test Limit

The conducted power may not exceed 250mW in 470 ~ 608 MHz band.

6.2.2. Test Procedure Used

ANSI C63.26-2015 - Section 5.2.4.2

6.2.3. Test Setting

The output of the EUT was connected to an RF average power meter through fixed attenuation.

The EUT was set to transmit on the low, middle, and high frequencies in each power level.

Measure the average power of the transmitter. This EUT's duty cycle is 100%.

6.2.4. Test Setup

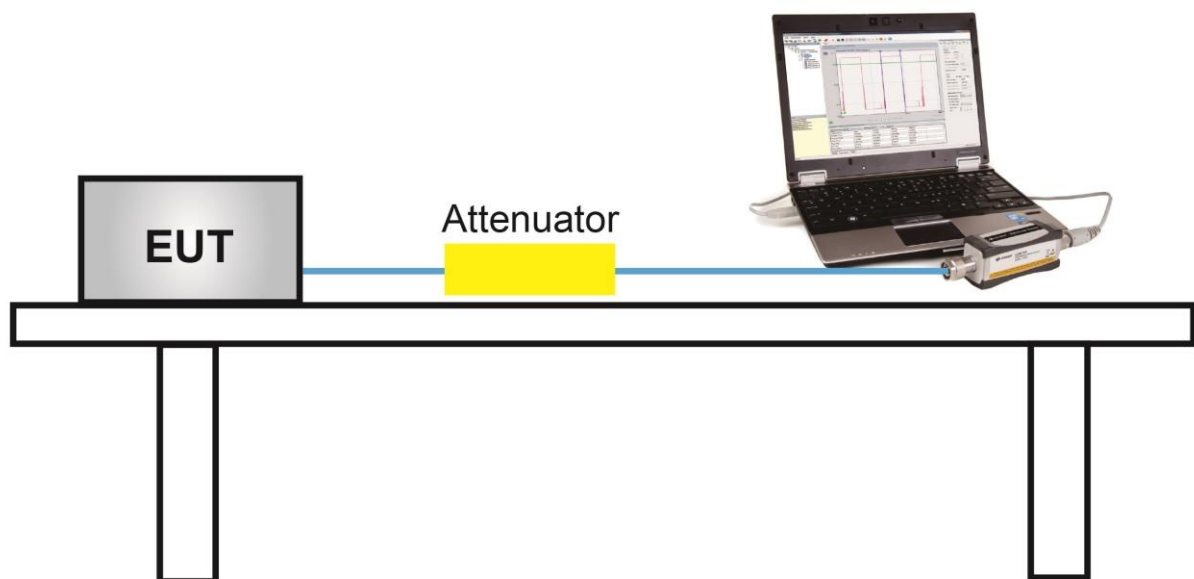

6.2.5. Test Result

Test Engineer	Buter Shi	Temperature	25°C
Test Site	AC1	Relative Humidity	44 ~ 68%
Model No.	AD3 G57+	Test Date	2020/05/11

Frequency (MHz)	Conducted Output Power (dBm)	Limit (dBm)	Test Result
STD Mode - 35mW			
470.125	15.12	≤ 23.98	Pass
539.000	15.07	≤ 23.98	Pass
607.875	14.74	≤ 23.98	Pass
HD Mode			
470.125	4.76	≤ 23.98	Pass
539.000	4.23	≤ 23.98	Pass
607.875	3.40	≤ 23.98	Pass

Note: Limit = $10 \cdot \log(250\text{mW}) = 23.98 \text{ dBm}$.

6.3. Frequency Tolerance Measurement

6.3.1. Test Limit

The frequency tolerance of the transmitter shall be 0.005 percent.

6.3.2. Test Procedure

ANSI C63.26 - Section 5.6.3

6.3.3. Test Setting

Frequency Stability Under Temperature Variations:

The equipment under test was connected to an external AC or DC power supply and input rated voltage. RF output was connected to a frequency counter or spectrum analyzer via feed through attenuators. The EUT was placed inside the temperature chamber. Set the spectrum analyzer RBW low enough to obtain the desired frequency resolution and measure EUT 20°C operating frequency as reference frequency. Turn EUT off and set the chamber temperature to highest. After the temperature stabilized for approximately 30 minutes recorded the frequency. Repeat step measure with 10°C decreased per stage until the lowest temperature reached.

Frequency Stability Under Voltage Variations:

Set chamber temperature to 20°C. Use a variable AC power supply / DC power source to power the EUT and set the voltage to rated voltage. Set the spectrum analyzer RBW low enough to obtain the desired frequency resolution and recorded the frequency.

Reduce the input voltage to specify extreme voltage variation ($\pm 15\%$) and endpoint (If a product is specified to operate over a range of input voltage then the -15% variation is applied to the lowermost voltage and the $+15\%$ is applied to the uppermost voltage), record the maximum frequency change.

6.3.4. Test Setup

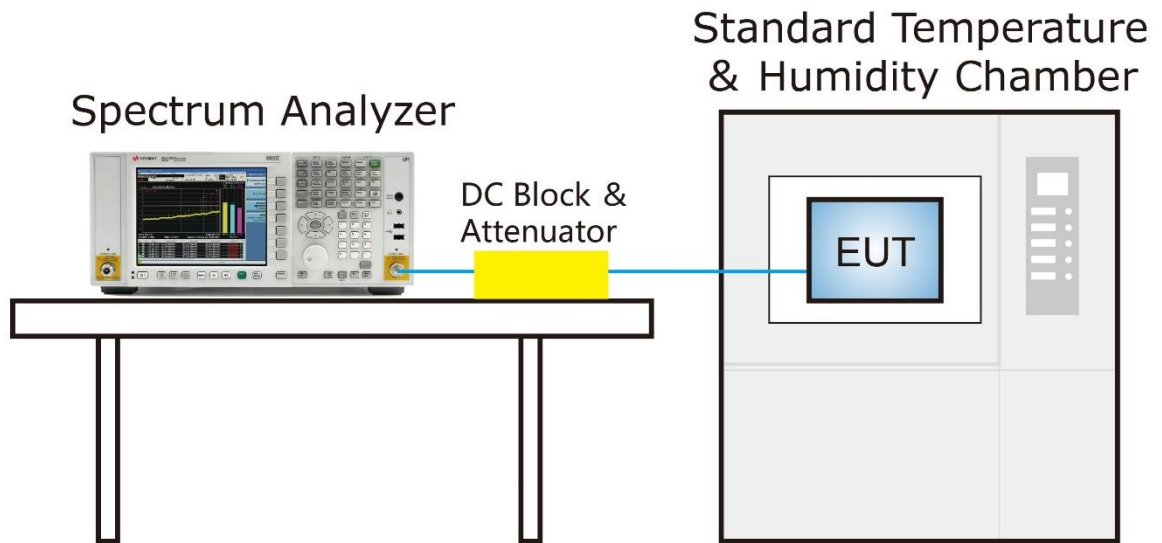

6.3.5. Test Result

Test Site	TR3	Temperature	-20 ~ 50°C
Test Engineer	Eric Xu	Relative Humidity	48 ~ 55%RH
Test Mode	Carrier Wave	Test Date	2020/05/06

Voltage (%)	Power (V _{DC})	Temp (°C)	Nominal Frequency (MHz)	Measured Frequency (MHz)	Deviation (%)	Limit (%)	Result
100%	3.70	-20	470.125	470.125079	0.000017	-/+0.005	Pass
			539.000	539.000093	0.000017	-/+0.005	Pass
			607.875	607.874942	-0.000010	-/+0.005	Pass
		-10	470.125	470.125079	0.000017	-/+0.005	Pass
			539.000	539.000093	0.000017	-/+0.005	Pass
			607.875	607.874944	-0.000009	-/+0.005	Pass
		0	470.125	470.125079	0.000017	-/+0.005	Pass
			539.000	539.000094	0.000017	-/+0.005	Pass
			607.875	607.874942	-0.000010	-/+0.005	Pass
		+10	470.125	470.125079	0.000017	-/+0.005	Pass
			539.000	539.000093	0.000017	-/+0.005	Pass
			607.875	607.874944	-0.000009	-/+0.005	Pass
		+20 (Ref)	470.125	470.125080	0.000017	-/+0.005	Pass
			539.000	539.000094	0.000017	-/+0.005	Pass
			607.875	607.874942	-0.000010	-/+0.005	Pass
		+30	470.125	470.125080	0.000017	-/+0.005	Pass
			539.000	539.000094	0.000017	-/+0.005	Pass
			607.875	607.874943	-0.000009	-/+0.005	Pass
		+40	470.125	470.125081	0.000017	-/+0.005	Pass
			539.000	539.000094	0.000017	-/+0.005	Pass
			607.875	607.874945	-0.000009	-/+0.005	Pass
		+50	470.125	470.125080	0.000017	-/+0.005	Pass
			539.000	539.000093	0.000017	-/+0.005	Pass
			607.875	607.874945	-0.000009	-/+0.005	Pass

115%	4.2	+20	470.125	470.125081	0.000017	-/+0.005	Pass
			539.000	539.000094	0.000017	-/+0.005	Pass
			607.875	607.874944	-0.000009	-/+0.005	Pass
85%	3.1	+20	470.125	470.125081	0.000017	-/+0.005	Pass
			539.000	539.000094	0.000017	-/+0.005	Pass
			607.875	607.874944	-0.000009	-/+0.005	Pass

Note 1: Frequency Tolerance (%) = $\{[\text{Measured Frequency (MHz)} - \text{Nominal Frequency (MHz)}] / \text{Nominal Frequency (MHz)}\} * 10^2$.

6.4. 99% Occupied Bandwidth Measurement

6.4.1. Test Limit

The operating bandwidth shall not exceed 200 kHz.

6.4.2. Test Procedure used

ANSI C63.26-2015 - Section 5.4.4

6.4.3. Test Setting

1. The signal analyzer's automatic bandwidth measurement capability was used to perform the 99% occupied bandwidth. The bandwidth measurement was not influenced by any intermediate power nulls in the fundamental emission.
2. RBW = 1 - 5% of the expected OBW
3. VBW $\geq 3 \times$ RBW
4. Detector = Peak
5. Trace mode = max hold
6. Sweep = auto couple
7. The trace was allowed to stabilize
8. Reported the measured 99% occupied bandwidth

6.4.4. Test Setup

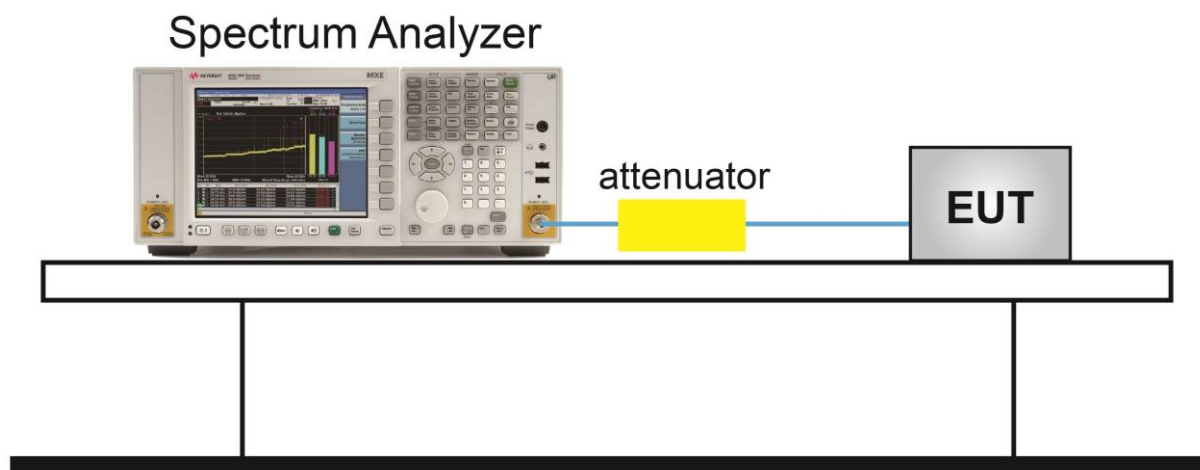

6.4.5. Test Result

Test Site	TR3	Temperature	25°C
Test Engineer	Eric Xu	Relative Humidity	52%
Model No.	AD3 G57+	Test Date	2020/04/30

Test Mode	Frequency (MHz)	99% Bandwidth (kHz)	Limit (kHz)	Result
STD Mode (35mW)	470.125	180.32	< 200	Pass
	539.000	180.30	< 200	Pass
	607.875	180.94	< 200	Pass
HD Mode (2mW)	470.125	97.77	< 200	Pass
	539.000	97.26	< 200	Pass
	607.875	97.36	< 200	Pass

99% Occupied Bandwidth - STD Mode

470.125 MHz

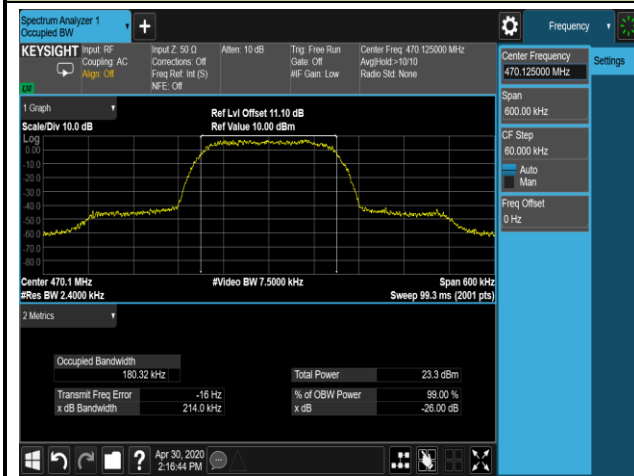

539.000MHz

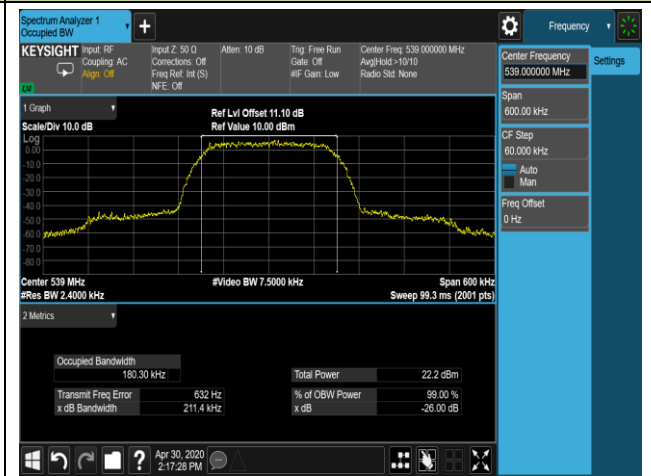

607.875MHz

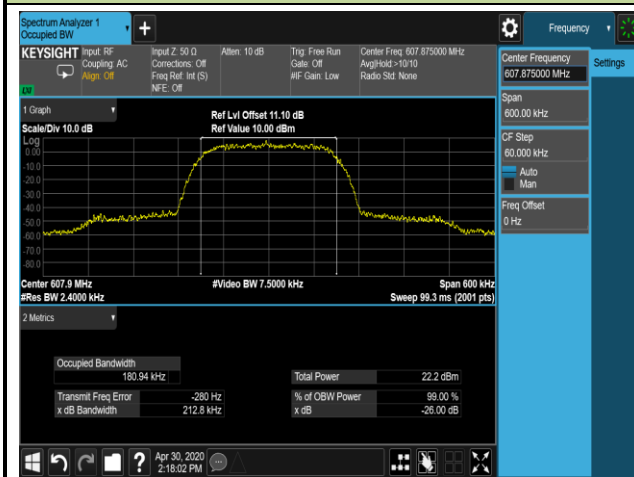

99% Occupied Bandwidth - HD Mode

470.125 MHz

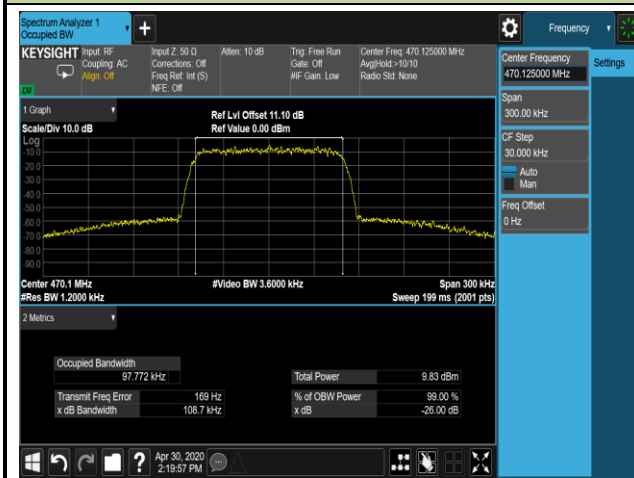

539.000MHz

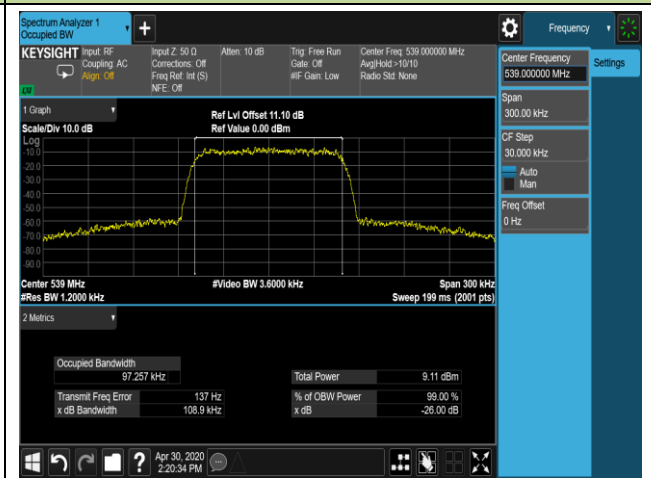

607.875MHz

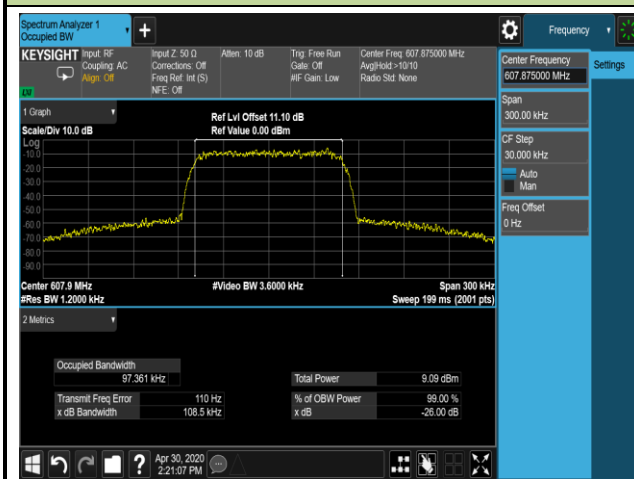

6.5. Out-of-band Emission Mask Measurement

6.5.1. Test Limit

The mean power of emissions shall be attenuated below the mean output power of the transmitter in accordance with the following schedule:

- (i) On any frequency removed from the operating frequency by more than 50 percent up to and including 100 percent of the authorized bandwidth: at least 25 dB;
- (ii) On any frequency removed from the operating frequency by more than 100 percent up to and including 250 percent of the authorized bandwidth: at least 35 dB;
- (iii) On any frequency removed from the operating frequency by more than 250 percent of the authorized bandwidth: at least $43 + 10 \log_{10}$ (mean output power in watts) dB.

6.5.2. Test Procedure Used

ANSI C63.26 - Section 5.7

6.5.3. Test Setting

Emission Mask

- a) The EUT was connected to a spectrum analyzer. The un-modulated carrier signal level was measured and recorded.
- b) The EUT was modulated with typical digital modulation.
- c) The spectrum analyzer center frequency was set to the EUT operating frequency; span was set to 2 MHz; resolution bandwidth was set to 1 MHz; video bandwidth set to 3 MHz; sweep time set to 3 s; after clear/write, max-hold was set; Marker 1 was set to RMS, then Marker 1 was set to reference value.
- d) The RMS output power was recorded and used to set the reference level on the spectrum analyzer.
- e) The spectrum analyzer span was then set to 1.5 MHz; resolution bandwidth set to 2 kHz, video bandwidth set to 5 kHz, sweep time to Auto.

6.5.4. Test Setup

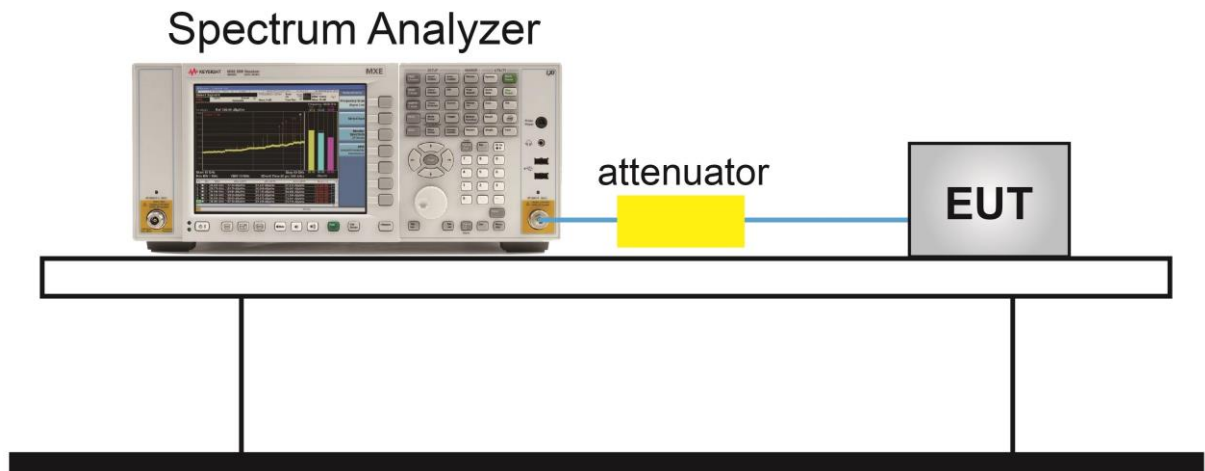

6.5.5. Test Result

Test Site	TR3	Temperature	25°C
Test Engineer	Eric Xu	Relative Humidity	52%
Model No.	AD3 G57+	Test Date	2020/05/07 ~ 2020/05/08

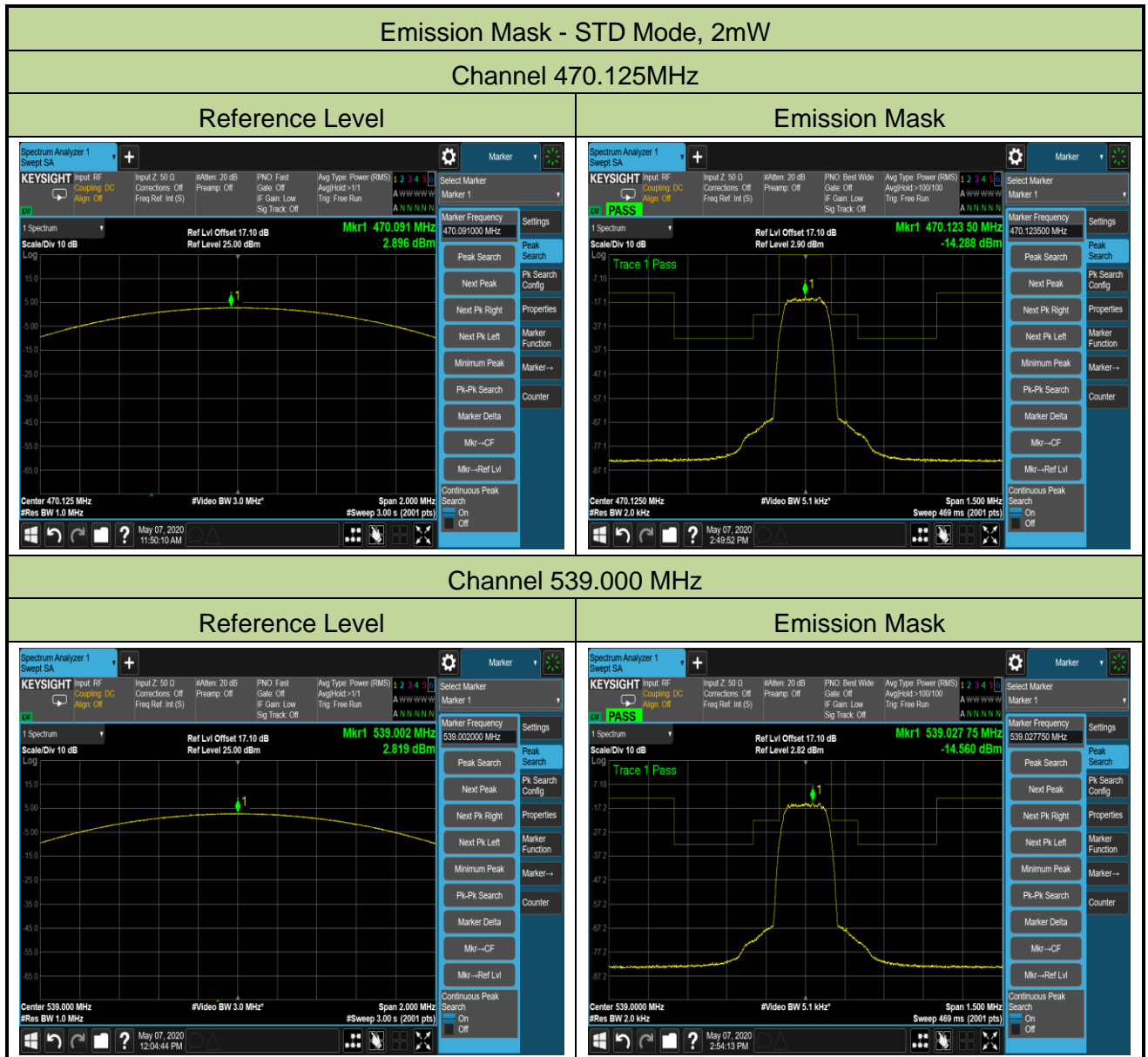

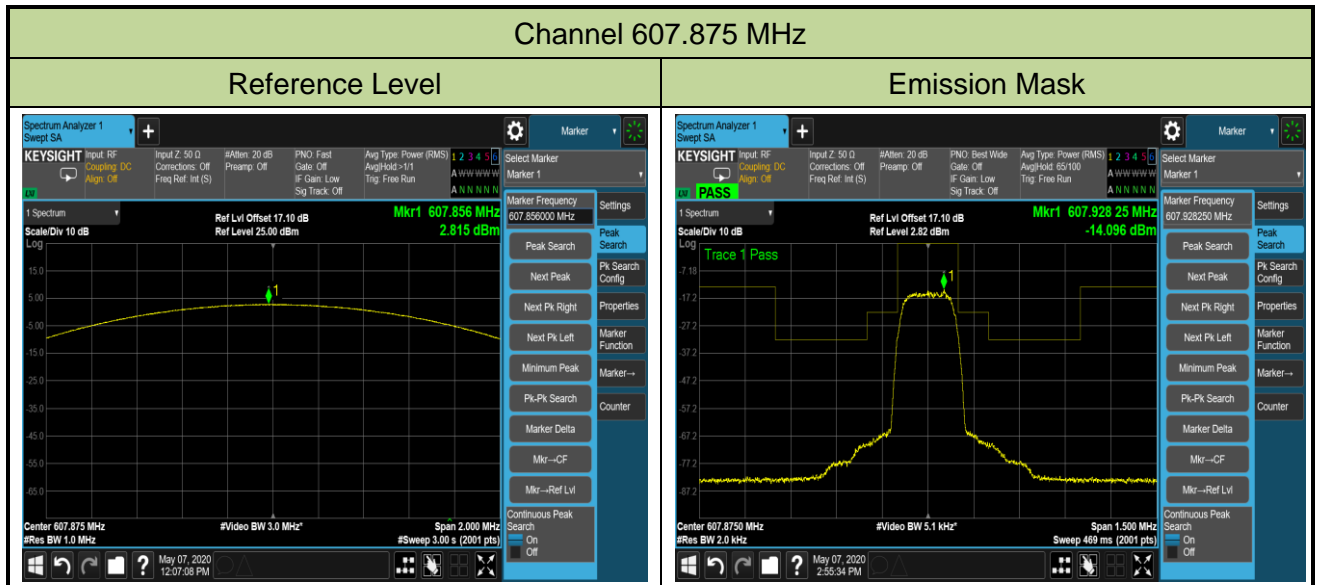

Emission Mask - STD Mode, 10mW

Channel 470.125MHz

Reference Level



Emission Mask



Channel 539.000 MHz

Reference Level



Emission Mask

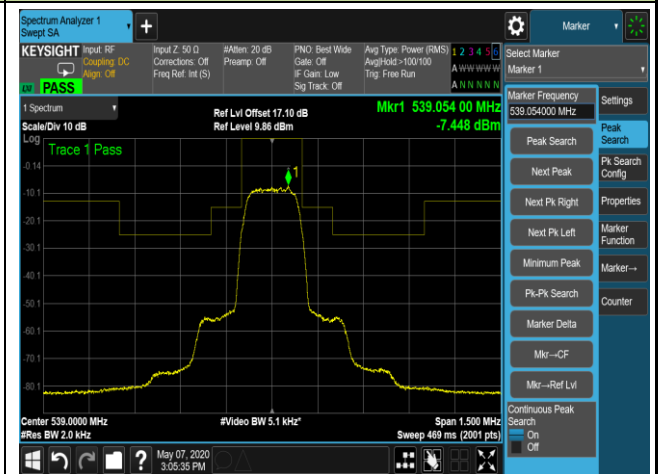

Channel 607.875 MHz

Reference Level



Emission Mask

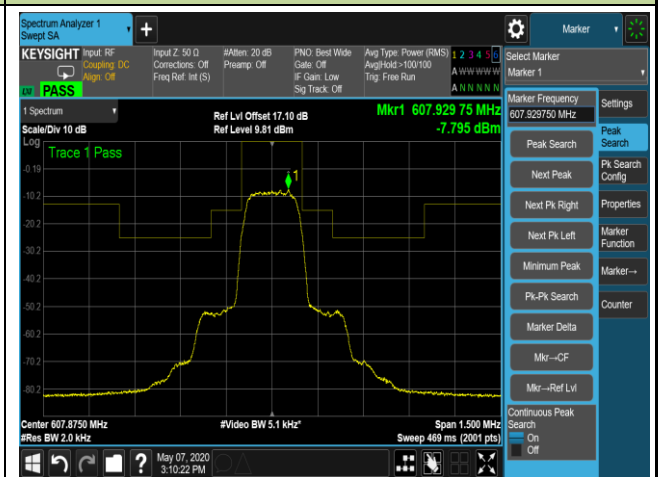

Emission Mask - STD Mode, 35mW

Channel 470.125MHz

Reference Level



Emission Mask

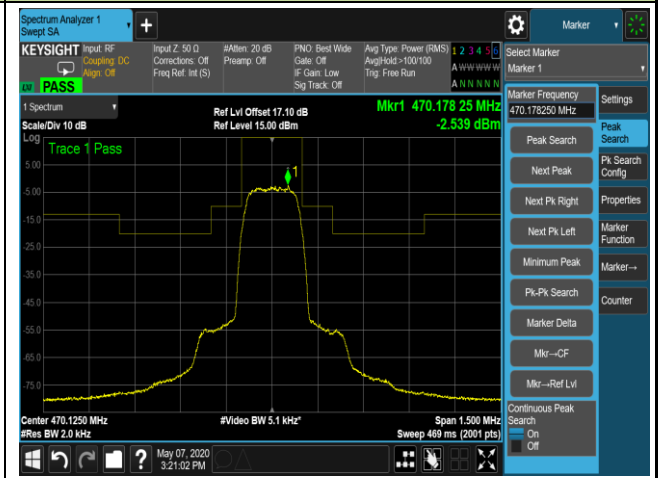

Channel 539.000 MHz

Reference Level



Emission Mask

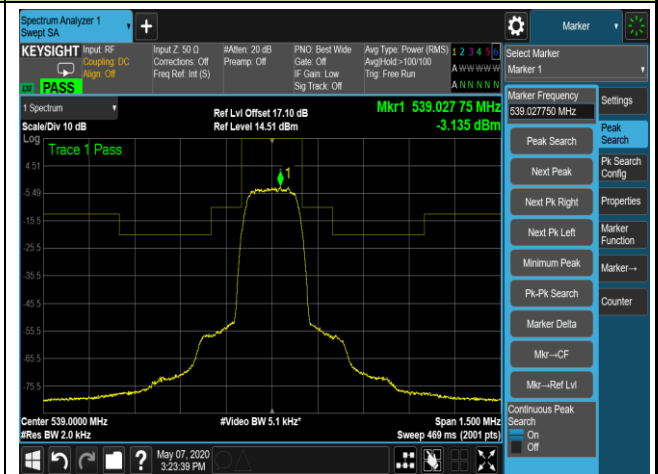

Channel 607.875 MHz

Reference Level



Emission Mask

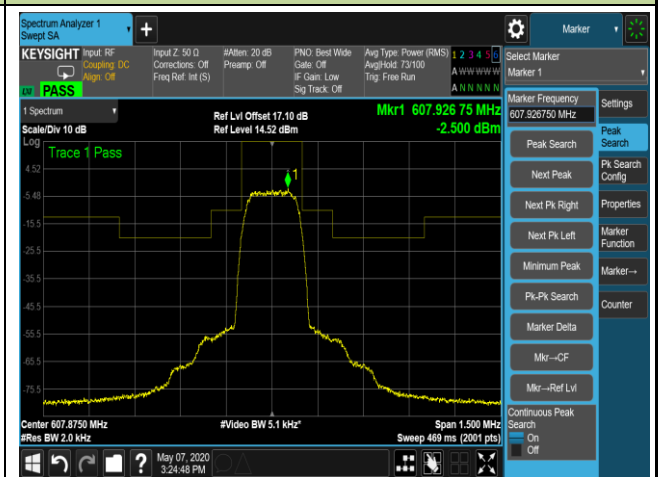

Emission Mask - HD Mode

Channel 470.125MHz

Reference Level

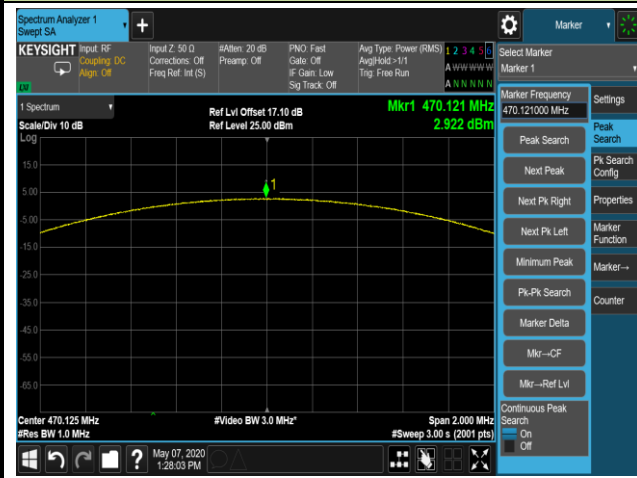

Emission Mask



Channel 539.000 MHz

Reference Level

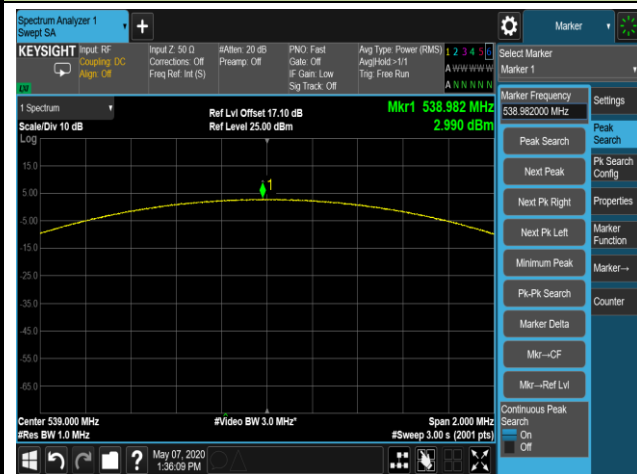

Emission Mask

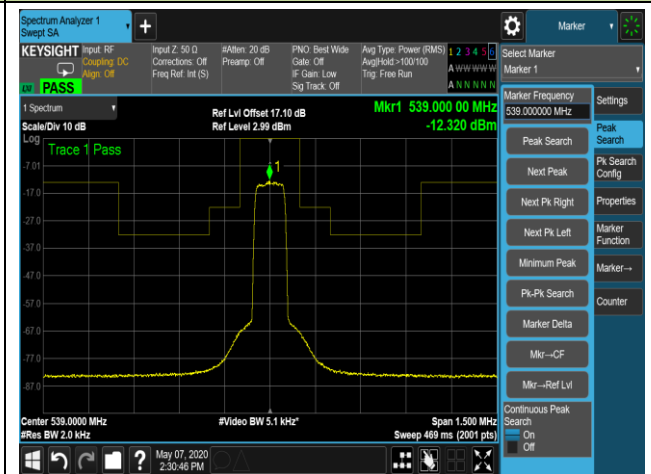

Channel 607.875 MHz

Reference Level



Emission Mask

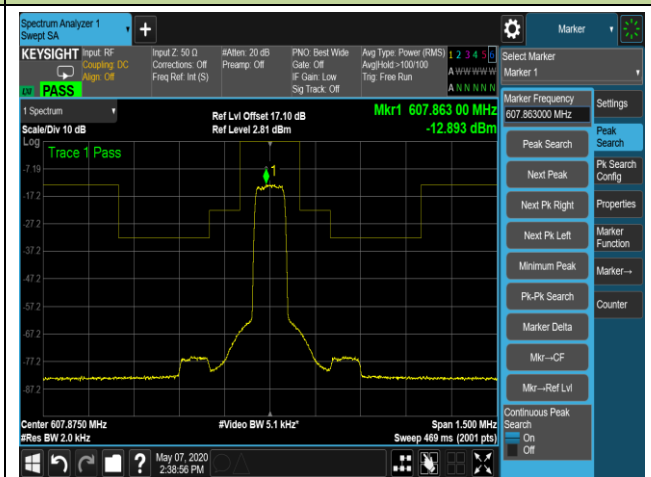

6.6. Necessary Bandwidth Measurement

6.6.1. Test Limit

Digital emissions within the band from one megahertz below to one megahertz above the carrier frequency shall comply with the emission mask in section 8.3.2.2 of the European Telecommunications Institute Standard ETSI EN 300 422-1 v1.4.2, the transmitter output spectrum shall be within the mask defined as below figure.

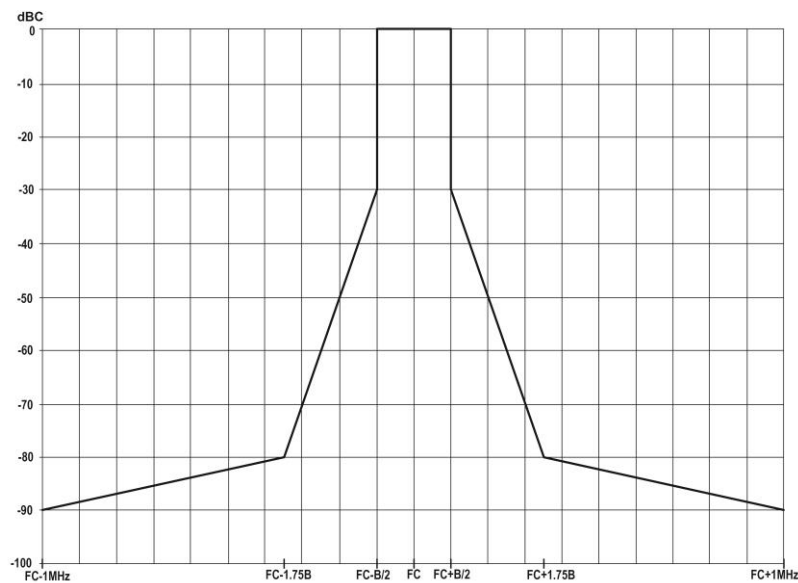

6.6.2. Test Procedure Used

EN 300 422-1 V1.4.2 clause 8.3.2.1.

6.6.3. Test Setting

The EUT was powered up and the transmit frequency & power output of the EUT were selected.

The spectrum analyzer center frequency is set to the nominal EUT channel center frequency.

6.6.4. Test Setup

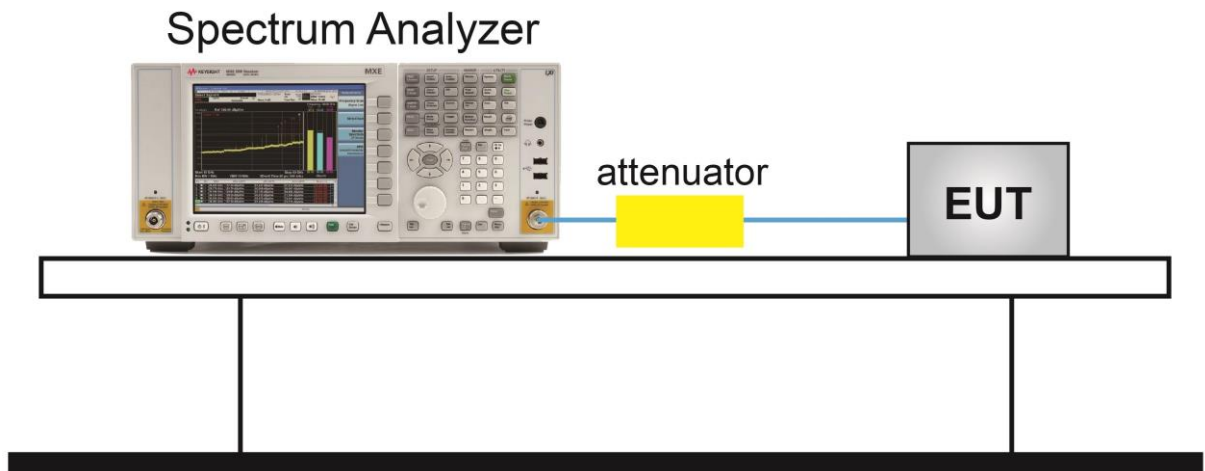

6.6.5. Test Result

Test Site	TR3	Temperature	25°C
Test Engineer	Eric Xu	Relative Humidity	52%
Model No.	AD3 G57+	Test Date	2020/04/30 ~ 2020/05/08

Necessary Bandwidth - STD Mode, 2mW, 470.125MHz

Step 1



Step 2

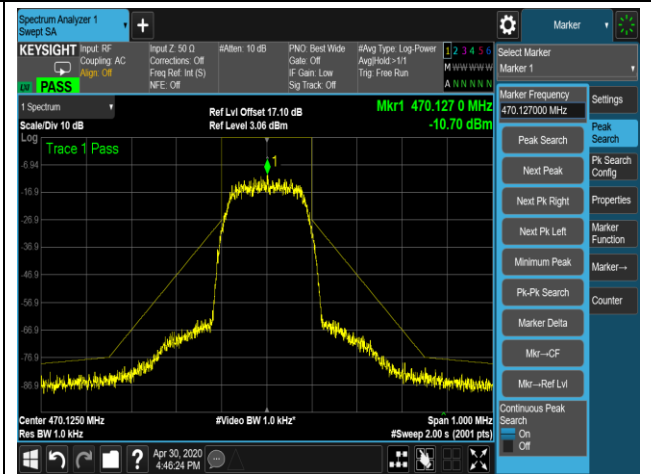

Step 3

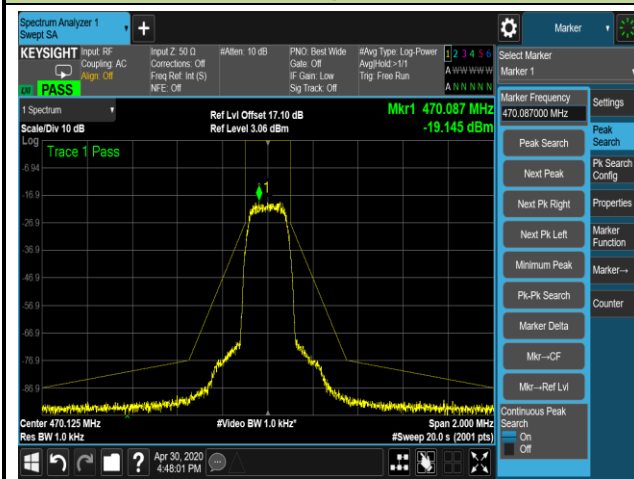

Necessary Bandwidth - STD Mode, 2mW, 539.000MHz

Step 1



Step 2

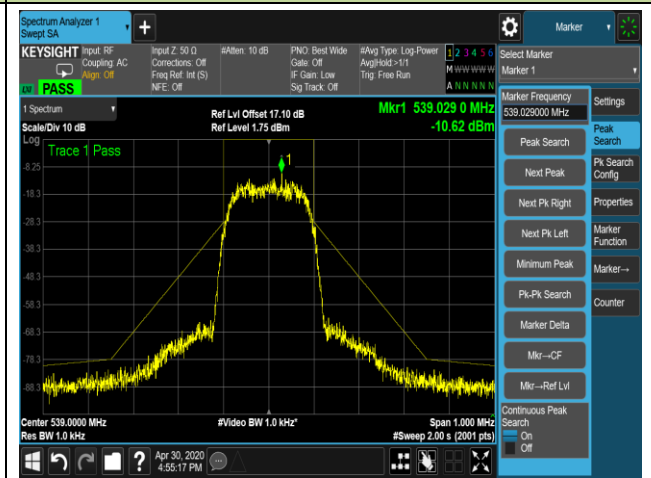

Step 3

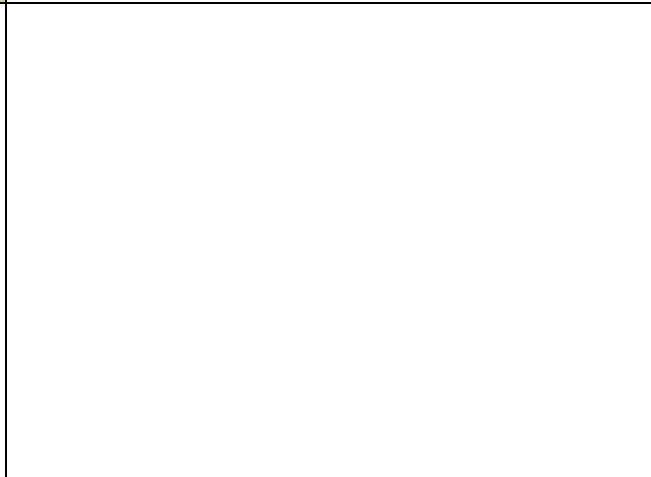
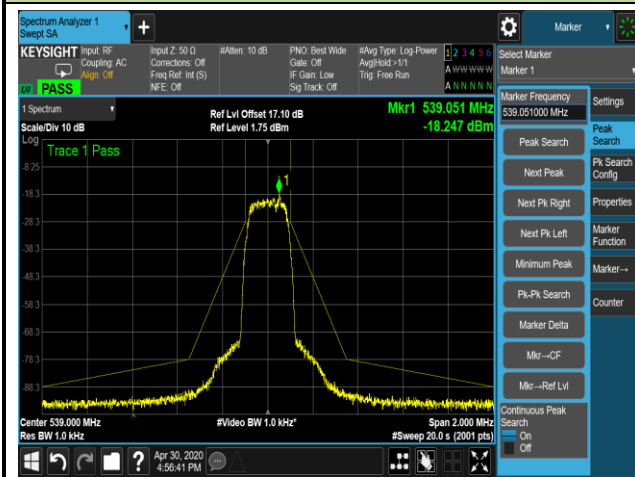

Necessary Bandwidth - STD Mode, 2mW, 607.875MHz

Step 1



Step 2

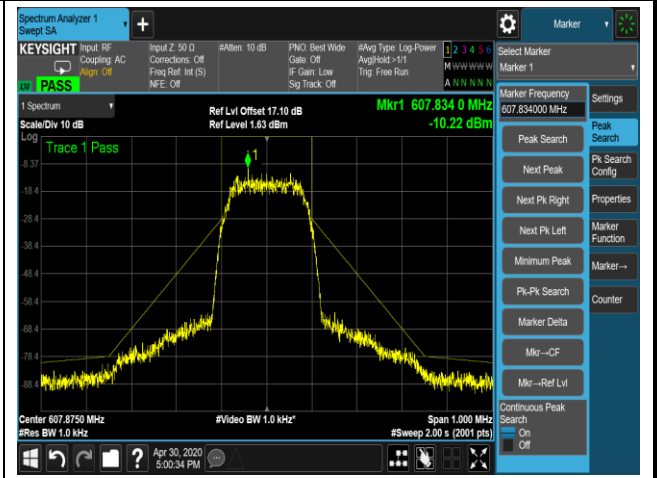

Step 3

