

MEASUREMENT REPORT

FCC PART 15.236 Wireless Microphone

FCC ID: DD4AD3G57

APPLICANT: Shure Incorporated

Application Type: Certification

Product: Digital Plug-on Transmitter

Model No.: AD3 G57, AD3 G57+

Brand Name: 

FCC Classification: Part 15 Wireless Microphone (DWM)

FCC Rule Part(s): Part 15 Subpart C (Section 15.236)

Test Procedure(s): ANSI C63.10-2013, KDB 206256 D01v02
ETSI EN 300 422-1 V1.4.2 (2011-08)

Test Date: April 24 ~ May 26, 2020

Reviewed By:



(Jame Yuan)

Approved By:

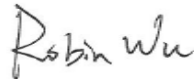

(Robin Wu)



The test results relate only to the samples tested.

The test results shown in the test report are traceable to the national/international standards through the calibration of the equipment and evaluated measurement uncertainty herein.

The test report shall not be reproduced except in full without the written approval of MRT Technology (Suzhou) Co., Ltd.

Revision History

Report No.	Version	Description	Issue Date	Note
2004RSU052-U1	Rev. 01	Initial Report	05-26-2020	Valid

CONTENTS

Description	Page
CONTENTS	3
1. INTRODUCTION	6
1.1. Scope	6
1.2. MRT Test Location	6
2. PRODUCT INFORMATION	7
2.1. Equipment Description.....	7
2.2. Product Specification Subjective to this Report.....	7
2.3. Working Frequencies for this report	8
2.4. Test Software	8
2.5. EMI Suppression Device(s) / Modifications	8
2.6. Labeling Requirements.....	8
3. DESCRIPTION of TEST	9
3.1. Evaluation Procedure	9
3.2. AC Line Conducted Emissions	9
3.3. Radiated Emissions	10
4. TEST EQUIPMENT CALIBRATION DATE	11
5. MEASUREMENT UNCERTAINTY	13
6. TEST RESULT	14
6.1. Summary	14
6.2. 99% Occupied Bandwidth Measurement	15
6.2.1. Test Limit	15
6.2.2. Test Procedure Used	15
6.2.3. Test Setting.....	15
6.2.4. Test Setup.....	15
6.2.5. Test Result.....	16
6.3. Frequency Tolerance Measurement.....	19
6.3.1. Test Limit	19
6.3.2. Test Procedure Used	19
6.3.3. Test Setting.....	19
6.3.4. Test Setup.....	20
6.3.5. Test Result.....	21
6.4. Necessary Bandwidth Measurement	24
6.4.1. Test Limit	24

6.4.2.	Test Procedure Used	24
6.4.3.	Test Setting	24
6.4.4.	Test Setup.....	25
6.4.5.	Test Result.....	26
6.5.	Output Power Measurement	44
6.5.1.	Test Limit	44
6.5.2.	Test Procedure Used	44
6.5.3.	Test Setting.....	44
6.5.4.	Test Setup.....	45
6.5.5.	Test Result.....	46
6.6.	Radiated Spurious Emission Measurement	48
6.6.1.	Test Limit	48
6.6.2.	Test Procedure Used	48
6.6.3.	Test Setting.....	48
6.6.4.	Test Setup.....	49
6.6.5.	Test Result.....	50
6.7.	AC Conducted Emissions Measurement.....	54
6.7.1.	Test Limit	54
6.7.2.	Test Setup.....	54
6.7.3.	Test Result of Conducted Emissions.....	55
7.	CONCLUSION.....	57
	Appendix A - Test Setup Photograph	58
	Appendix B - EUT Photograph.....	59

General Information

Applicant:	Shure Incorporated
Applicant Address:	5800 West Touhy Avenue, Niles, IL 60714-4608, USA
Manufacturer:	Shure Incorporated
Manufacturer Address:	5800 West Touhy Avenue, Niles, IL 60714-4608, USA
Test Site:	MRT Technology (Suzhou) Co., Ltd
Test Site Address:	D8 Building, No.2 Tian'edang Rd., Wuzhong Economic Development Zone, Suzhou, China
Test Device Serial No.:	N/A <input type="checkbox"/> Production <input checked="" type="checkbox"/> Pre-Production <input type="checkbox"/> Engineering

Test Facility / Accreditations

Measurements were performed at MRT Laboratory located in Tian'edang Rd., Suzhou, China.

- MRT facility is a FCC accredited (MRT Designation No. CN1166) test facility with the site description report on file and has met all the requirements specified in ANSI C63.4-2014.
- MRT facility is an IC registered (MRT Reg. No. 11384A-1) test laboratory with the site description on file at Industry Canada.
- MRT facility is a VCCI registered (R-20025, G-20034, C-20020, T-20020) test laboratory with the site description on file at VCCI Council.
- MRT Lab is accredited to ISO 17025 by the American Association for Laboratory Accreditation (A2LA) under the American Association for Laboratory Accreditation Program (A2LA Cert. No. 3628.01) in EMC, Telecommunications, Radio and SAR testing.



1. INTRODUCTION

1.1. Scope

Measurement and determination of electromagnetic emissions (EMC) of radio frequency devices including intentional and/or unintentional radiators for compliance with the technical rules and regulations of the Federal Communications Commission and the Innovation, Science and Economic Development Canada and Certification and Engineering Bureau.

1.2. MRT Test Location

The map below shows the location of the MRT LABORATORY, its proximity to the Taihu Lake. These measurement tests were conducted at the MRT Technology (Suzhou) Co., Ltd. Facility located at D8 Building, No.2 Tian'edang Rd., Wuzhong Economic Development Zone, Suzhou, China. The measurement facility compliant with the test site requirements specified in ANSI C63.4-2014.



2. PRODUCT INFORMATION

2.1. Equipment Description

Product Name	Digital Plug-on Transmitter
Model No.	AD3 G57, AD3 G57+
Frequency Range	470 ~ 608 MHz, 614 ~ 616 MHz
Power Type	Two AA batteries (3.0Vdc) or SB900A Li-ion battery
Working Voltage	1.9 ~ 4.2 Vdc
Working Mode	STD Mode and HD Mode (Note 3)
Operating Temperature	-10 ~ 50°C
Accessories	
Rechargeable Li-ion Battery	Model: SB900A Output: 3.7Vdc, 1320mAh, 4.88Wh

Note 1: Difference between models is only for different market, any others are same.

Note 2: We selected AD3 G57+ to perform all RF testing.

Note 3: STD means normal channel bandwidth mode, HD means high density channel bandwidth.

End user can switch working modes through the digital wireless receiver.

2.2. Product Specification Subjective to this Report

Frequency Range	470 ~ 608 MHz, 614 ~ 616 MHz
Declared Power Level	STD: 2mW & 10mW & 35mW, HD: 2mW
Type of Modulation	16QAM
Channel Spacing	25kHz

Note 1: For other features of this EUT, test report will be issued separately.

Note 2: Power level and transmit frequency can be selected using the front panel controls.

Note 3: 614 ~ 616 MHz frequency band support max power level is 10mW.

2.3. Working Frequencies for this report

Bottom Channel (MHz)	Middle Channel (MHz)	Top Channel (MHz)
470 - 608 MHz Band		
470.125	539.000	607.875
614 - 616 MHz Band		
614.125	N/A	615.875

Note 1: The frequency selection can be offset from the upper or lower band limits by 25 kHz. This upper or lower band means 470~616 MHz frequency range is defined in FCC Part 15.236 title.

Note 2: Refer ANSI C63.10 clause 5.6.1 table 4, frequency range fall within 1 – 10 MHz, only two channels (Top and Bottom) shall be tested.

2.4. Test Software

The test utility software used during testing was “IPOP”, and the version was V4.1, all test commands were provided by the manufacturer.

2.5. EMI Suppression Device(s) / Modifications

No EMI suppression device(s) were added and/or no modifications were made during testing.

2.6. Labeling Requirements

Per 2.1074 & 15.19; Docket 95-19

The label shall be permanently affixed at a conspicuous location on the device; instruction manual or pamphlet supplied to the user and be readily visible to the purchaser at the time of purchase.

However, when the device is so small wherein placement of the label with specified statement is not practical, only the FCC ID must be displayed on the device per Section 15.19(a)(5). Please see attachment for FCC ID label and label location.

3. DESCRIPTION of TEST

3.1. Evaluation Procedure

The measurement procedure described in the document titled “American National Standard of Procedures for Compliance Testing of Unlicensed Wireless Devices” (ANSI C63.10-2013) was used in the measurement.

3.2. AC Line Conducted Emissions

The line-conducted facility is located inside an 8'x4'x4' shielded enclosure. A 1m x 2m wooden table 80cm high is placed 40cm away from the vertical wall and 80cm away from the sidewall of the shielded room. Two 10kHz-30MHz, 50Ω/50uH Line-Impedance Stabilization Networks (LISNs) are bonded to the shielded room floor. Power to the LISNs is filtered by external high-current high-insertion loss power line filters. These filters attenuate ambient signal noise from entering the measurement lines. These filters are also bonded to the shielded enclosure.

The EUT is powered from one LISN and the support equipment is powered from the second LISN. All interconnecting cables more than 1 meter were shortened to a 1 meter length by non-inductive bundling (serpentine fashion) and draped over the back edge of the test table. All cables were at least 40cm above the horizontal reference ground-plane. Power cables for support equipment were routed down to the second LISN while ensuring that that cables were not draped over the second LISN.

Sufficient time for the EUT, support equipment, and test equipment was allowed in order for them to warm up to their normal operating condition. The RF output of the LISN was connected to the receiver and exploratory measurements were made to determine the frequencies producing the maximum emission from the EUT. The receiver was scanned from 150kHz to 30MHz. The detector function was set to peak mode for exploratory measurements while the bandwidth of the analyzer was set to 9kHz. The EUT, support equipment, and interconnecting cables were arranged and manipulated to maximize each emission. Each emission was also maximized by varying: power lines, the mode of operation or data exchange speed, or support equipment whichever determined the worst-case emission. Once the worst case emissions have been identified, the one EUT cable configuration/arrangement and mode of operation that produced these emissions were used for final measurements on the same test site. The analyzer is set to CISPR quasi-peak and average detectors with a 9kHz resolution bandwidth for final measurements.

An extension cord was used to connect to a single LISN which powered by EUT. The extension cord was calibrated with LISN, the impedance and insertion loss are compliance with the requirements as stated in ANSI C63.10-2013.

3.3. Radiated Emissions

The radiated test facilities consisted of an indoor 3 meter semi-anechoic chamber used for final measurements and exploratory measurements, when necessary. The measurement area is contained within the semi-anechoic chamber which is shielded from any ambient interference. For measurements above 1GHz absorbers are arranged on the floor between the turn table and the antenna mast in such a way so as to maximize the reduction of reflections. For measurements below 1GHz, the absorbers are removed. An MF Model 210SS turntable is used for radiated measurement. It is a continuously rotatable, remote controlled, metallic turntable and 2 meters (6.56 ft.) in diameter. The turn table is flush with the raised floor of the chamber in order to maintain its function as a ground plane. An 80cm high PVC support structure is placed on top of the turntable.

For all measurements, the spectrum was scanned through all EUT azimuths and from 1 to 4 meter receive antenna height using a broadband antenna from 30MHz up to the upper frequency shown in 15.33(b)(1) depending on the highest frequency generated or used in the device or on which the device operates or tunes. For frequencies above 1GHz, linearly polarized double ridge horn antennas were used. For frequencies below 30MHz, a calibrated loop antenna was used. When exploratory measurements were necessary, they were performed at 1 meter test distance inside the semi-anechoic chamber using broadband antennas, broadband amplifiers, and spectrum analyzers to determine the frequencies and modes producing the maximum emissions. Sufficient time for the EUT, support equipment, and test equipment was allowed in order for them to warm up to their normal operating condition. The test set-up for frequencies below 1GHz was placed on top of the 0.8 meter high, 1 x 1.5 meter table; and test set-up for frequencies 1-40GHz was placed on top of the 1.5 meter high, 1 x 1.5 meter table. The EUT, support equipment, and interconnecting cables were arranged and manipulated to maximize each emission. Appropriate precaution was taken to ensure that all emissions from the EUT were maximized and investigated. The system configuration, clock speed, mode of operation or video resolution, if applicable, turntable azimuth, and receive antenna height was noted for each frequency found.

Final measurements were made in the semi-anechoic chamber using calibrated, linearly polarized broadband and horn antennas. The test setup was configured to the setup that produced the worst case emissions. The spectrum analyzer was set to investigate all frequencies required for testing to compare the highest radiated disturbances with respect to the specified limits. The turntable containing the EUT was rotated through 360 degrees and the height of the receive antenna was varied 1 to 4 meters and stopped at the azimuth and height producing the maximum emission. Each emission was maximized by changing the orientation of the EUT through three orthogonal planes and changing the polarity of the receive antenna, whichever produced the worst-case emissions. According to 3dB Beam-Width of horn antenna, the horn antenna should be always directed to the EUT when rising height.

4. TEST EQUIPMENT CALIBRATION DATE

Conducted Emissions - SR2

Instrument	Manufacturer	Type No.	Asset No.	Cali. Interval	Cali. Due Date
EMI Test Receiver	R&S	ESR3	MRTSUE06185	1 year	2021/01/18
Two-Line V-Network	R&S	ENV 216	MRTSUE06002	1 year	2020/06/13
Two-Line V-Network	R&S	ENV 216	MRTSUE06003	1 year	2020/06/13
Thermohygrometer	Testo	608-H1	MRTSUE06404	1 year	2020/08/08
Shielding Room	MIX-BEP	Chamber-SR2	MRTSUE06215	N/A	N/A

Radiated Emissions - AC1

Instrument	Manufacturer	Type No.	Asset No.	Cali. Interval	Cali. Due Date
EMI Test Receiver	R&S	ESR7	MRTSUE06001	1 year	2020/08/01
PXA Signal Analyzer	Keysight	9030B	MRTSUE06395	1 year	2020/09/03
Loop Antenna	Schwarzbeck	FMZB 1519	MRTSUE06025	1 year	2020/11/10
Bilog Period Antenna	Schwarzbeck	VULB 9168	MRTSUE06172	1 year	2021/04/03
Broad Band Horn Antenna	Schwarzbeck	BBHA 9120D	MRTSUE06023	1 year	2020/10/13
Broad Band Horn Antenna	Schwarzbeck	BBHA 9170	MRTSUE06024	1 year	2020/12/29
Microwave System Amplifier	Agilent	83017A	MRTSUE06076	1 year	2020/11/15
Preamplifier	Schwarzbeck	BBV 9721	MRTSUE06121	1 year	2020/06/11
Thermohygrometer	Testo	608-H1	MRTSUE06403	1 year	2020/08/08
Anechoic Chamber	TDK	Chamber-AC1	MRTSUE06212	1 year	2021/04/30

Radiated Emission - AC2

Instrument	Manufacturer	Type No.	Asset No.	Cali. Interval	Cali. Due Date
Spectrum Analyzer	Keysight	N9038A	MRTSUE06125	1 year	2020/08/01
Loop Antenna	Schwarzbeck	FMZB 1519	MRTSUE06025	1 year	2020/11/10
Bilog Period Antenna	Schwarzbeck	VULB 9162	MRTSUE06022	1 year	2020/10/13
Horn Antenna	Schwarzbeck	BBHA9120D	MRTSUE06171	1 year	2020/10/27
Broad Band Horn Antenna	Schwarzbeck	BBHA 9170	MRTSUE06024	1 year	2020/12/29
Broadband Coaxial Preamplifier	Schwarzbeck	BBV 9718	MRTSUE06176	1 year	2020/11/15
Preamplifier	Schwarzbeck	BBV 9721	MRTSUE06121	1 year	2020/06/11
Temperature/Humidity Meter	Minggao	ETH529	MRTSUE06170	1 year	2020/12/15
Anechoic Chamber	RIKEN	Chamber-AC2	MRTSUE06213	1 year	2021/04/30

Conducted Test Equipment - TR3

Instrument	Manufacturer	Type No.	Asset No.	Cali. Interval	Cali. Due Date
EXA Signal Analyzer	Agilent	N9020A	MRTSUE06106	1 year	2021/04/14
EXA Signal Analyzer	Keysight	N9010B	MRTSUE06452	1 year	2020/07/11
Signal Analyzer	R&S	FSV40	MRTSUE06218	1 year	2021/04/14
Power Meter	Agilent	U2021XA	MRTSUE06030	1 year	2020/11/18
USB wideband power sensor	Keysight	U2021XA	MRTSUE06446	1 year	2020/06/30
USB wideband power sensor	Keysight	U2021XA	MRTSUE06447	1 year	2020/06/30
Bluetooth Test Set	Anritsu	MT8852B-042	MRTSUE06389	1 year	2020/06/13
Audio Analyzer	Agilent	U8903B	MRTSUE06143	1 year	2020/06/13
Modulation Analyzer	HP	8901A	MRTSUE06098	1 year	2020/10/10
Wideband Radio Communication Tester	R&S	CMW 500	MRTSUE06243	1 year	2020/11/07
DC Power Supply	GWINSTEK	DPS-3303C	MRTSUE06064	N/A	N/A
Temperature & Humidity Chamber	BAOYT	BYH-150CL	MRTSUE06051	1 year	2020/11/07
Thermohygrometer	testo	608-H1	MRTSUE06401	1 year	2020/08/08

Software	Version	Function
EMI Software	V3	EMI Test Software

5. MEASUREMENT UNCERTAINTY

Where relevant, the following test uncertainty levels have been estimated for tests performed on the EUT as specified in CISPR 16-4-2. This uncertainty represents an expanded uncertainty expressed at approximately the 95% confidence level using a coverage factor of $k = 2$.

Conducted Emission Measurement - SR2
<p>The maximum measurement uncertainty is evaluated as:</p> <p>9kHz~150kHz: 3.84dB</p> <p>150kHz~30MHz: 3.46dB</p>
Radiated Emission Measurement - AC1
<p>The maximum measurement uncertainty is evaluated as:</p> <p>Horizontal: 30MHz~300MHz: 4.07dB</p> <p> 300MHz~1GHz: 3.63dB</p> <p> 1GHz~18GHz: 4.16dB</p> <p>Vertical: 30MHz~300MHz: 4.18dB</p> <p> 300MHz~1GHz: 3.60dB</p> <p> 1GHz~18GHz: 4.76dB</p>
Radiated Emission Measurement - AC2
<p>The maximum measurement uncertainty is evaluated as:</p> <p>Horizontal: 30MHz~300MHz: 3.75dB</p> <p> 300MHz~1GHz: 3.53dB</p> <p> 1GHz~18GHz: 4.28dB</p> <p>Vertical: 30MHz~300MHz: 3.86dB</p> <p> 300MHz~1GHz: 3.53dB</p> <p> 1GHz~18GHz: 4.33dB</p>

6. TEST RESULT

6.1. Summary

FCC Part Section(s)	Test Description	Test Limit	Test Condition	Test Result	Reference
15.236(f)(2)	Occupied Bandwidth	< 200kHz	Conducted	Pass	Section 6.2
15.236(f)(3)	Frequency Tolerance	± 0.005%		Pass	Section 6.3
15.236(g)	Necessary Bandwidth	Refer to clause 6.4.1		Pass	Section 6.4
15.236(d)(1)	RF Output Power	Refer to clause 6.5.1	Radiated	Pass	Section 6.5
15.236(g)	Radiated Spurious Emission	Refer to clause 6.6.1		Pass	Section 6.6
15.207	AC Conducted Emissions 150kHz - 30MHz	< FCC 15.207 limits	Line Conducted	Pass	Section 6.7

Notes:

- 1) The analyzer plots shown in this section were all taken with a correction table loaded into the analyzer. The correction table was used to account for the losses of the cables and attenuators used as part of the system to connect the EUT to the analyzer at all frequencies of interest.
- 2) All modes of operation and data rates were investigated. For radiated emission test, every axis (X, Y, Z) was also verified. The test results shown in the following sections represent the worst case emissions.
- 3) For STD mode, besides necessary bandwidth test item was assessed three power level, any others test items were only assessed max power level.

6.2. 99% Occupied Bandwidth Measurement

6.2.1. Test Limit

The operating bandwidth shall not exceed 200 kHz.

6.2.2. Test Procedure Used

ANSI C63.10-2013 - Section 6.9.3

6.2.3. Test Setting

1. The frequency span for the spectrum analyzer shall be between 1.5 times and 5.0 times the OBW.
2. Set RBW \geq 1% to 5% of the OBW
3. VBW = Approximately three times RBW
4. Detector = Peak
5. Trace mode = Max hold
6. Sweep = Auto couple
7. Allow the trace to stabilize
8. Use the 99% power bandwidth function of the instrument and report the measured bandwidth.

6.2.4. Test Setup

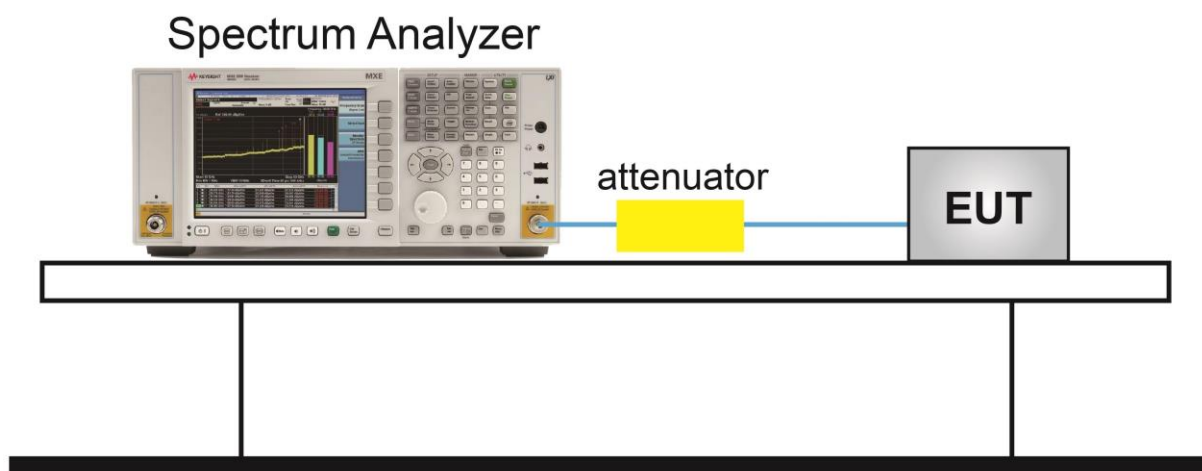

6.2.5. Test Result

Test Engineer	Selina Zhang	Temperature	25°C
Test Site	TR3	Relative Humidity	52%
Model No.	AD3 G57+	Test Date	2020/04/30

Mode	Frequency (MHz)	99% Bandwidth (kHz)	Limit (kHz)	Result
STD (35mW)	470.125	180.32	< 200	Pass
	539.000	180.30	< 200	Pass
	607.875	180.94	< 200	Pass
STD (10mW)	614.125	180.67	< 200	Pass
	615.875	180.45	< 200	Pass
HD (2mW)	470.125	97.77	< 200	Pass
	539.000	97.26	< 200	Pass
	607.875	97.36	< 200	Pass
	614.125	97.38	< 200	Pass
	615.875	97.34	< 200	Pass

STD Mode - 99% Occupied Bandwidth

470.125 MHz

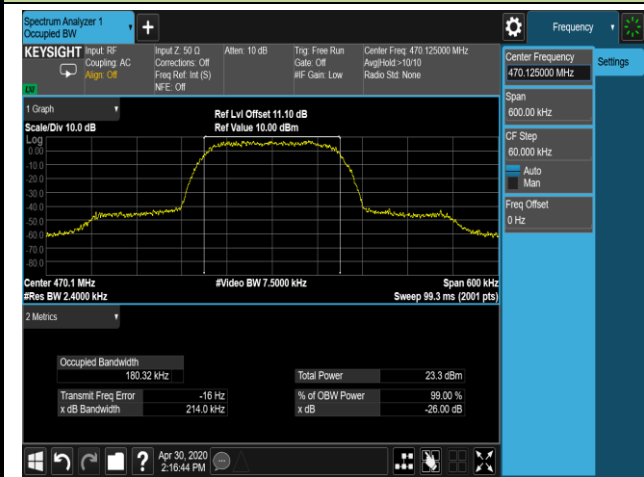

539.000MHz

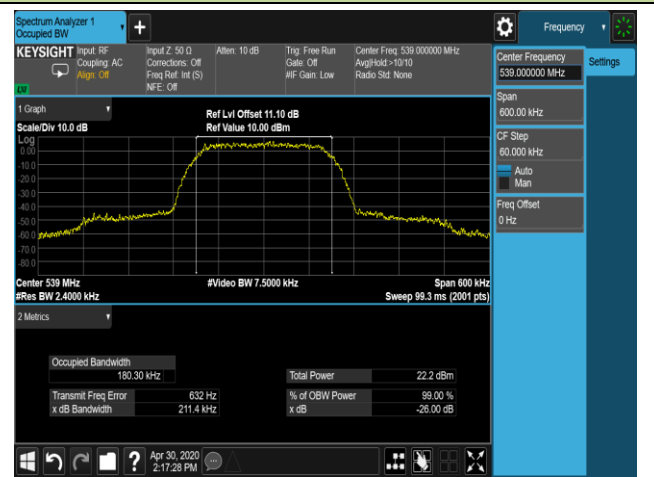

607.875MHz

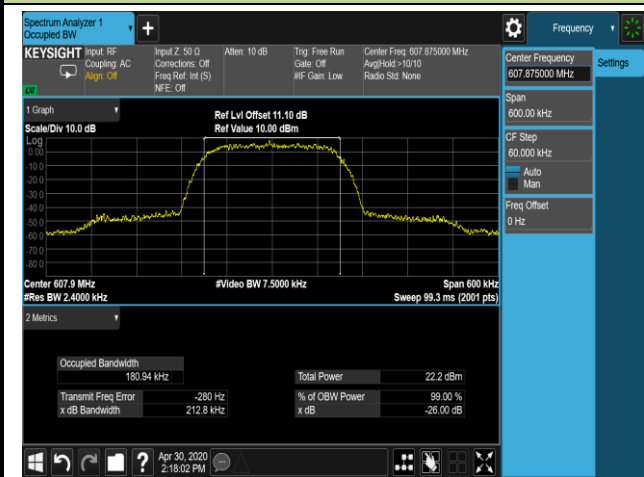

614.125MHz

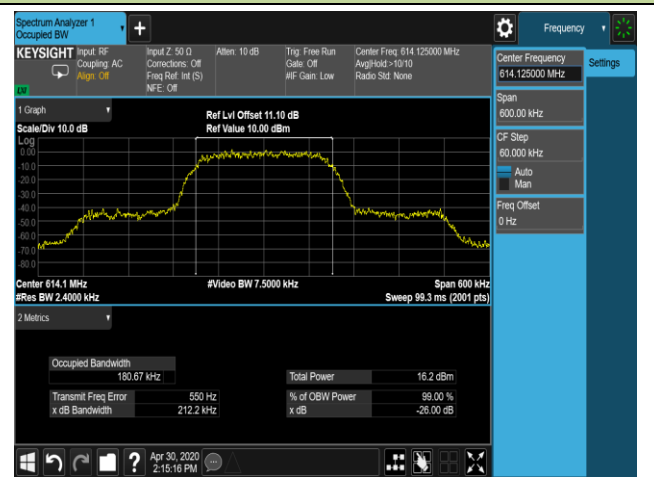

615.875MHz

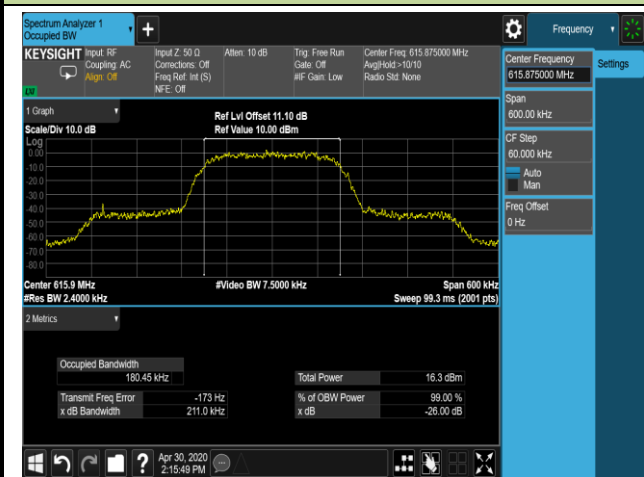

HD Mode - 99% Occupied Bandwidth

470.125 MHz

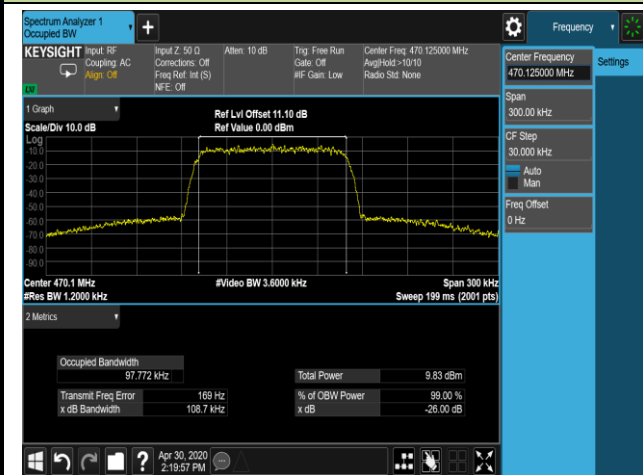

539.000MHz

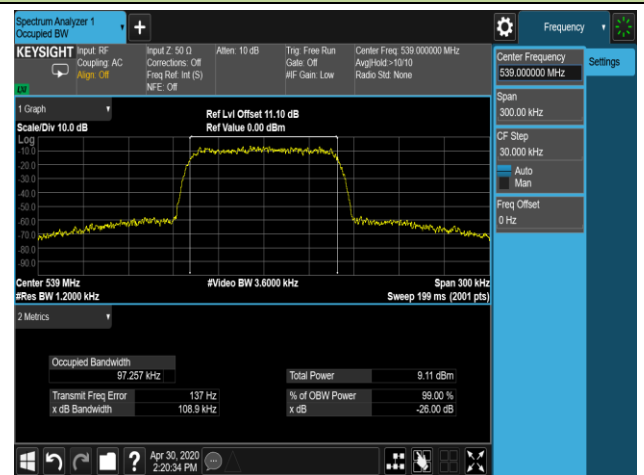

607.875MHz

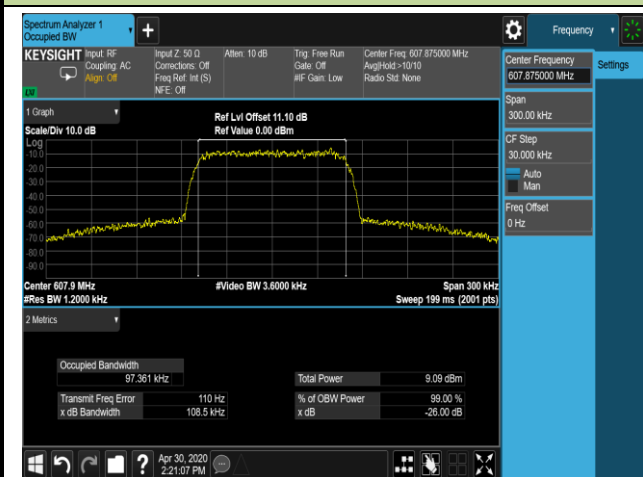

614.125MHz



615.875MHz

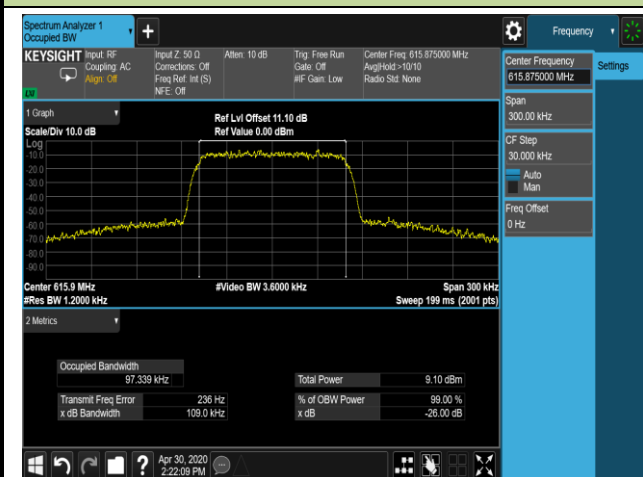

6.3. Frequency Tolerance Measurement

6.3.1. Test Limit

The frequency tolerance of the carrier signal shall be maintained within $\pm 0.005\%$ of the operating frequency over a temperature variation of -20 degrees to +50 degrees C at normal supply voltage, and for a variation in the primary supply voltage from 85% to 115% of the rated supply voltage at a temperature of 20 degrees C. Battery operated equipment shall be tested using a new battery.

6.3.2. Test Procedure Used

ANSI C63.10-2013 - Section 6.8

6.3.3. Test Setting

The EUT was programmed to transmit with an unmodulated carrier.

Frequency Stability Under Temperature Variations:

The equipment under test was connected to an external DC power supply and input rated voltage. RF output was connected to a frequency counter or spectrum analyzer via feed through attenuators. The EUT was placed inside the temperature chamber. Set the spectrum analyzer RBW low enough to obtain the desired frequency resolution and measure EUT 20°C operating frequency as reference frequency. While maintaining a constant temperature inside the environmental chamber, turn the EUT on and record the operating frequency at startup, and at 2 minutes, 5 minutes, and 10 minutes after the EUT is energized. Four measurements in total are made. Repeat step measure with 10°C decreased per stage until the lowest temperature reached.

Frequency Stability Under Voltage Variations:

Set chamber temperature to 20°C. Use a variable DC power source to power the EUT and set the voltage to rated voltage. Set the spectrum analyzer RBW low enough to obtain the desired frequency resolution and recorded the frequency.

Reduce the input voltage to specify extreme voltage variation ($\pm 15\%$) and endpoint, record the maximum frequency change.

6.3.4. Test Setup

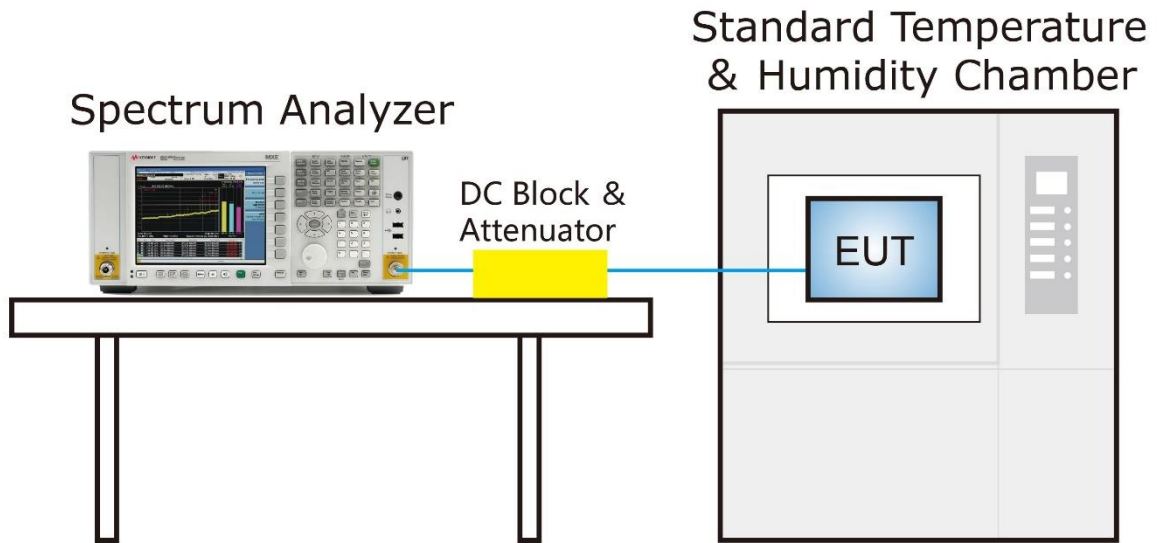

6.3.5. Test Result

Test Engineer	Selina Zhang	Temperature	-20 ~ 50°C
Test Site	TR3	Relative Humidity	48 ~ 55%RH
Test Mode	Carrier Wave	Test Date	2020/05/06

Voltage (%)	Power (V _{DC})	Temp (°C)	Nominal Frequency (MHz)	Measured Frequency (MHz)	Deviation (%)	Limit (%)	Result
100%	3.7	-20	470.125	470.125079	0.000017	-/+0.005	Pass
			539.000	539.000093	0.000017	-/+0.005	Pass
			607.875	607.874942	-0.000010	-/+0.005	Pass
		-10	470.125	470.125079	0.000017	-/+0.005	Pass
			539.000	539.000093	0.000017	-/+0.005	Pass
			607.875	607.874944	-0.000009	-/+0.005	Pass
		0	470.125	470.125079	0.000017	-/+0.005	Pass
			539.000	539.000094	0.000017	-/+0.005	Pass
			607.875	607.874942	-0.000010	-/+0.005	Pass
		+10	470.125	470.125079	0.000017	-/+0.005	Pass
			539.000	539.000093	0.000017	-/+0.005	Pass
			607.875	607.874944	-0.000009	-/+0.005	Pass
		+20 (Ref)	470.125	470.125080	0.000017	-/+0.005	Pass
			539.000	539.000094	0.000017	-/+0.005	Pass
			607.875	607.874942	-0.000010	-/+0.005	Pass
		+30	470.125	470.125080	0.000017	-/+0.005	Pass
			539.000	539.000094	0.000017	-/+0.005	Pass
			607.875	607.874943	-0.000009	-/+0.005	Pass
		+40	470.125	470.125081	0.000017	-/+0.005	Pass
			539.000	539.000094	0.000017	-/+0.005	Pass
			607.875	607.874945	-0.000009	-/+0.005	Pass
		+50	470.125	470.125080	0.000017	-/+0.005	Pass
			539.000	539.000093	0.000017	-/+0.005	Pass
			607.875	607.874945	-0.000009	-/+0.005	Pass

115%	4.2	+20	470.125	470.125081	0.000017	-/+0.005	Pass
			539.000	539.000094	0.000017	-/+0.005	Pass
			607.875	607.874944	-0.000009	-/+0.005	Pass
85%	3.1	+20	470.125	470.125081	0.000017	-/+0.005	Pass
			539.000	539.000094	0.000017	-/+0.005	Pass
			607.875	607.874944	-0.000009	-/+0.005	Pass

Note 1: Frequency Tolerance (%) = {[Measured Frequency (MHz) - Nominal Frequency (MHz)] / Nominal Frequency (MHz)} *10².

Note 2: Four measurements (0 & 2 & 5 & 10 minutes) test data was recorded and only show worst data in report.

Test Engineer	Selina Zhang	Temperature	-20 ~ 50°C
Test Site	TR3	Relative Humidity	48 ~ 55%RH
Test Mode	Carrier Wave	Test Date	2020/05/06

Voltage (%)	Power (V _{DC})	Temp (°C)	Nominal Frequency (MHz)	Measured Frequency (MHz)	Deviation (%)	Limit (%)	Result		
100%	3.70	-20	614.125	614.124951	-0.000008	-/+0.005	Pass		
			615.875	615.874951	-0.000008	-/+0.005	Pass		
		-10	614.125	614.124951	-0.000008	-/+0.005	Pass		
			615.875	615.874951	-0.000008	-/+0.005	Pass		
		0	614.125	614.124952	-0.000008	-/+0.005	Pass		
			615.875	615.874952	-0.000008	-/+0.005	Pass		
		+10	614.125	614.124951	-0.000008	-/+0.005	Pass		
			615.875	615.874953	-0.000008	-/+0.005	Pass		
		+20 (Ref)	614.125	614.124951	-0.000008	-/+0.005	Pass		
			615.875	615.874952	-0.000008	-/+0.005	Pass		
		+30	614.125	614.124951	-0.000008	-/+0.005	Pass		
			615.875	615.874952	-0.000008	-/+0.005	Pass		
		+40	614.125	614.124951	-0.000008	-/+0.005	Pass		
			615.875	615.874952	-0.000008	-/+0.005	Pass		
		+50	614.125	614.124952	-0.000008	-/+0.005	Pass		
			615.875	615.874952	-0.000008	-/+0.005	Pass		
		115%	4.2	+20	614.125	614.124950	-0.000008	-/+0.005	Pass
					615.875	615.874952	-0.000008	-/+0.005	Pass
85%	3.1	+20	614.125	614.124950	-0.000008	-/+0.005	Pass		
			615.875	615.874952	-0.000008	-/+0.005	Pass		

Note 1: Frequency Tolerance (%) = {[Measured Frequency (MHz) - Nominal Frequency (MHz)] / Nominal Frequency (MHz)} * 10².

Note 2: Four measurements (0 & 2 & 5 & 10 minutes) test data was recorded and only show worst data in report.

6.4. Necessary Bandwidth Measurement

6.4.1. Test Limit

According to EN 300 422-1 V1.4.2 clause 8.3.2.2, the transmitter output spectrum shall be within the mask defined as below figure.

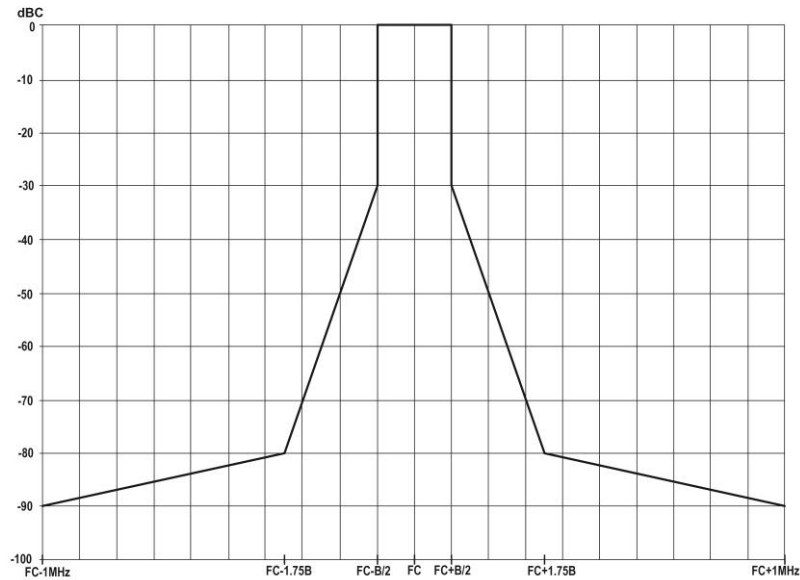

6.4.2. Test Procedure Used

ETSI EN 300 422-1 V1.4.2 clause 8.3.2.1.

6.4.3. Test Setting

The EUT was powered up and the transmit frequency & power output of the EUT were selected.

The spectrum analyzer center frequency is set to the nominal EUT channel center frequency.

Only bottom and top channel is required, at an output power level of 2mW & 10mW & 35mW.

6.4.4. Test Setup

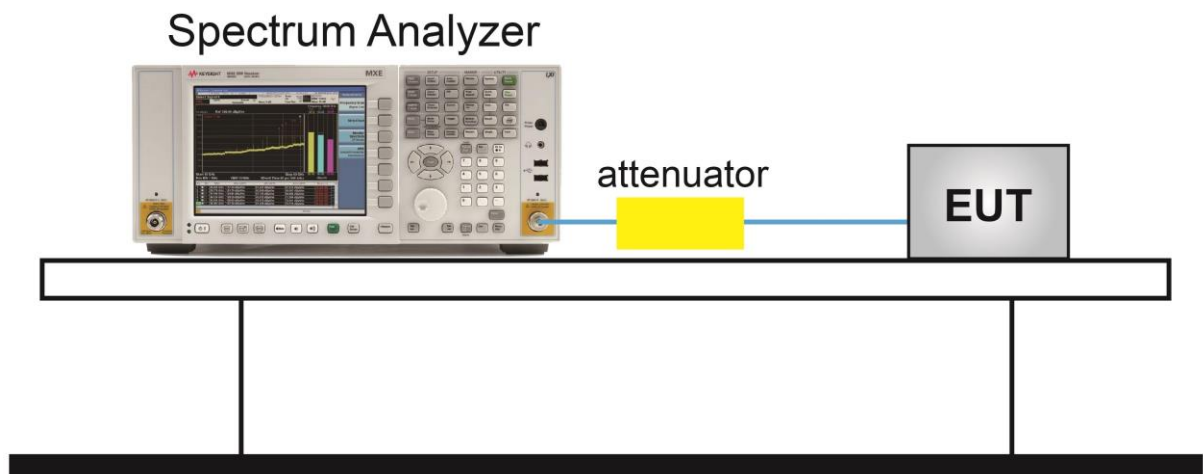

6.4.5. Test Result

Test Site	TR3	Temperature	25°C
Test Engineer	Eric Xu	Relative Humidity	52%
Model No.	AD3 G57+	Test Date	2020/04/30 ~ 2020/05/08

Necessary Bandwidth - STD Mode, 2mW, 470.125MHz

Step 1

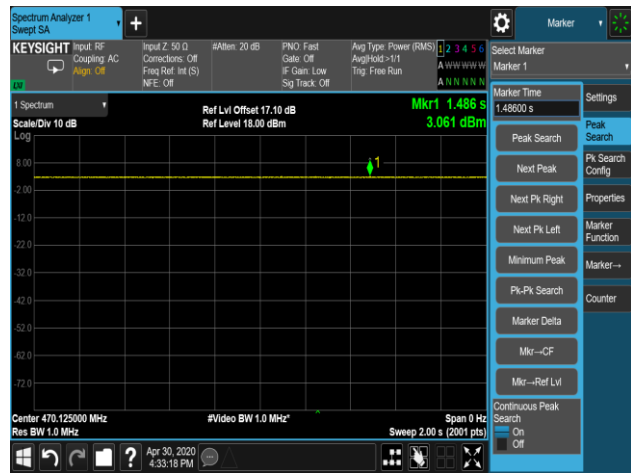

Step 2

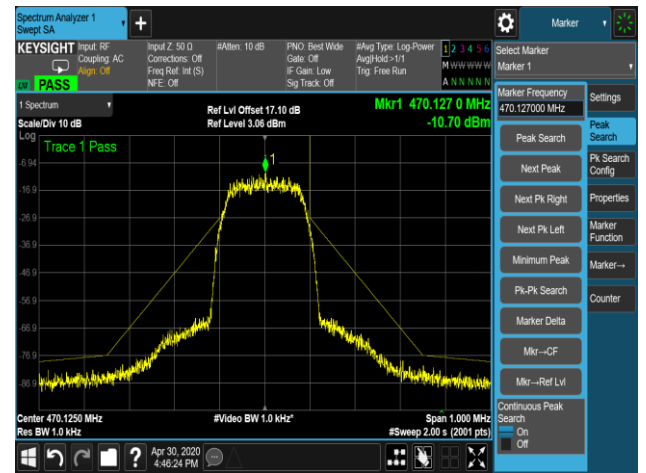

Step 3

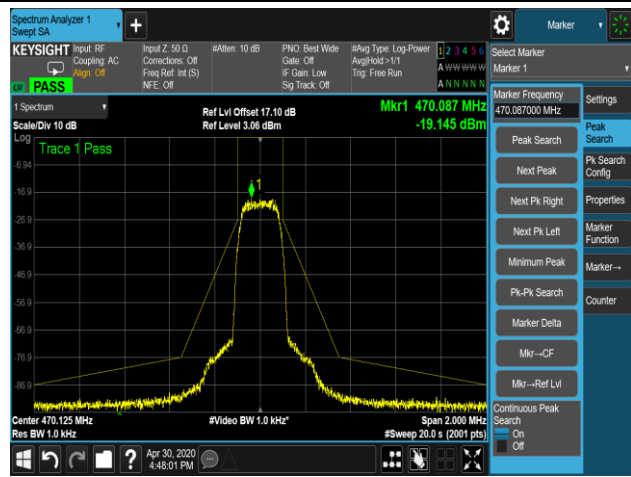

Necessary Bandwidth - STD Mode, 2mW, 539.000MHz

Step 1



Step 2

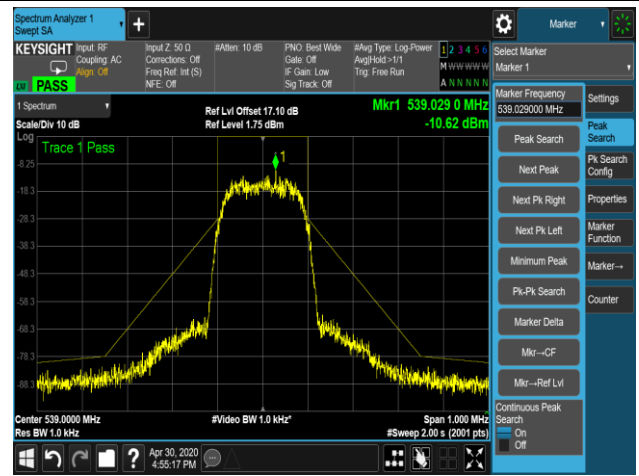

Step 3

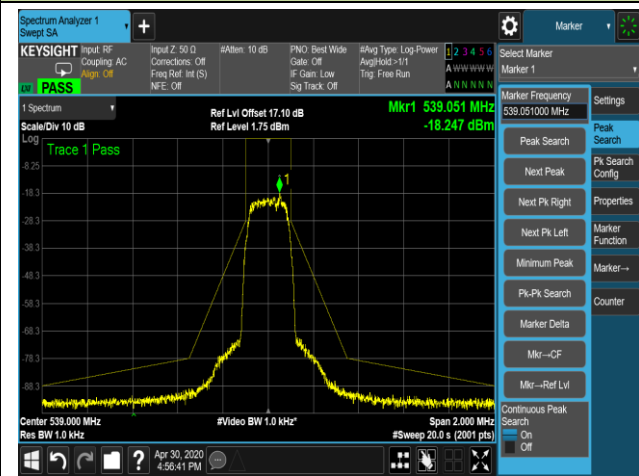

Necessary Bandwidth - STD Mode, 2mW, 607.875MHz

Step 1



Step 2

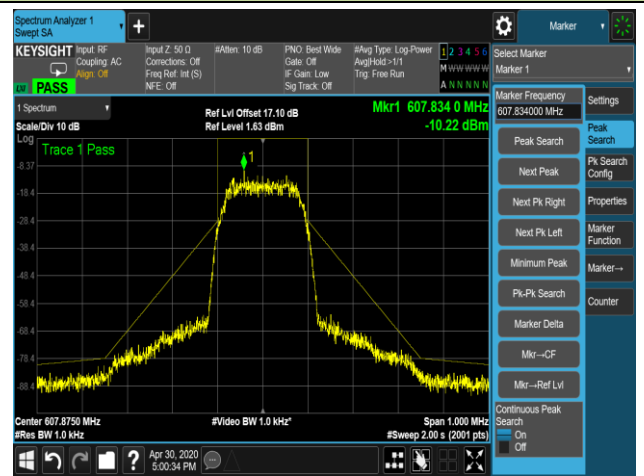

Step 3

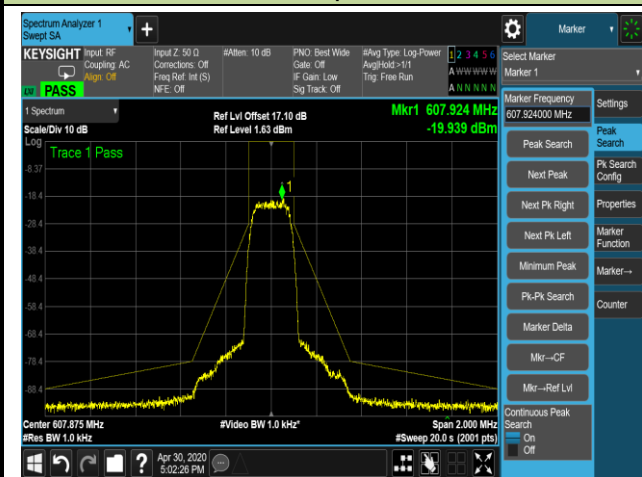

Necessary Bandwidth - STD Mode, 2mW, 614.125MHz

Step 1



Step 2

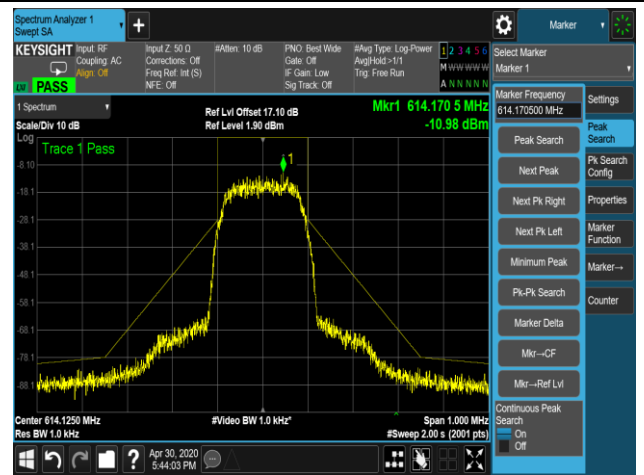

Step 3

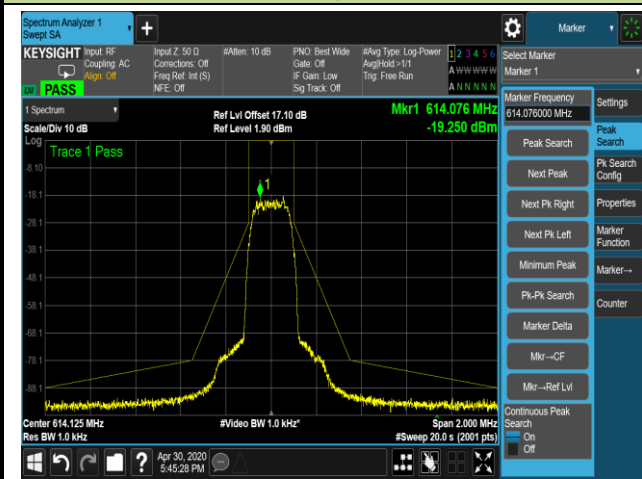

Necessary Bandwidth - STD Mode, 2mW, 615.875MHz

Step 1



Step 2

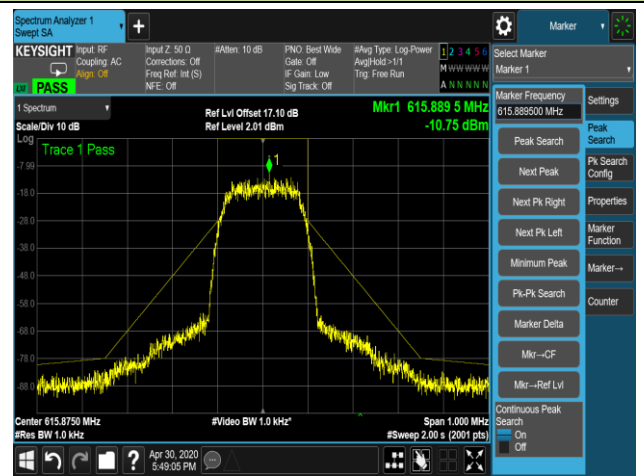

Step 3

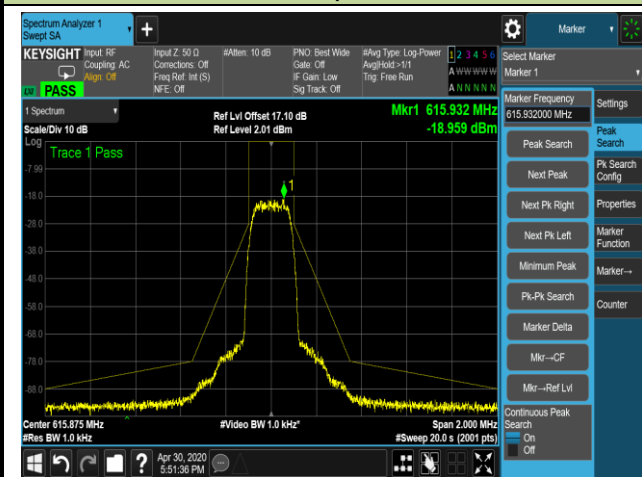

Necessary Bandwidth - STD Mode, 10mW, 470.125MHz

Step 1



Step 2

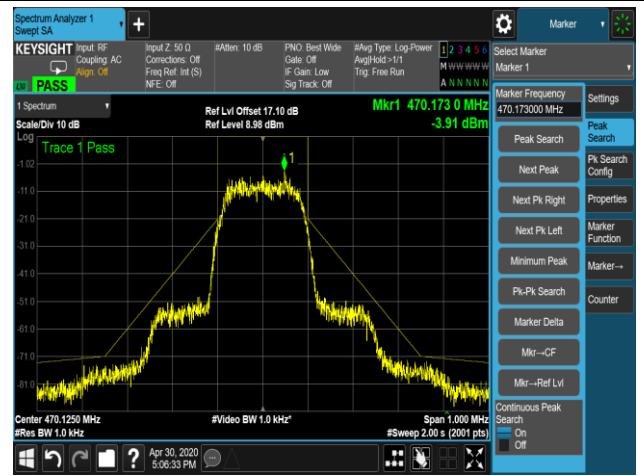

Step 3

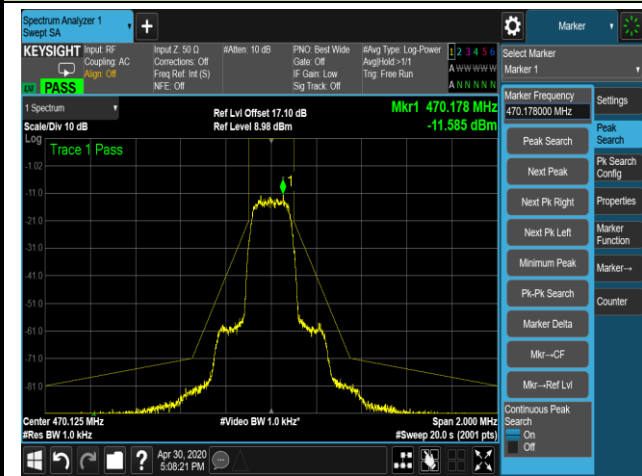

Necessary Bandwidth - STD Mode, 10mW, 539.000MHz

Step 1



Step 2

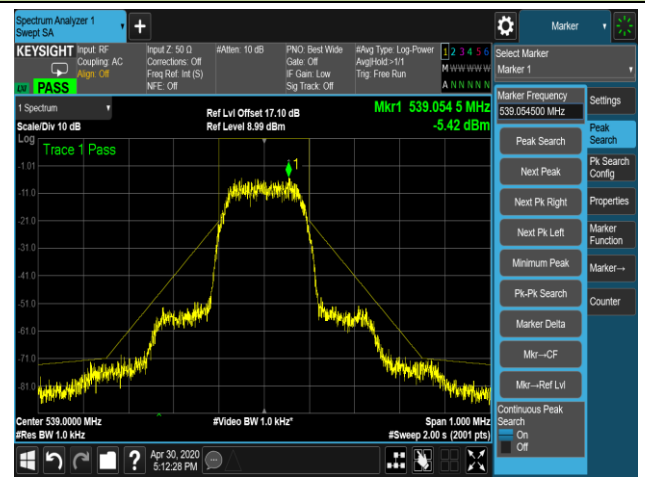

Step 3

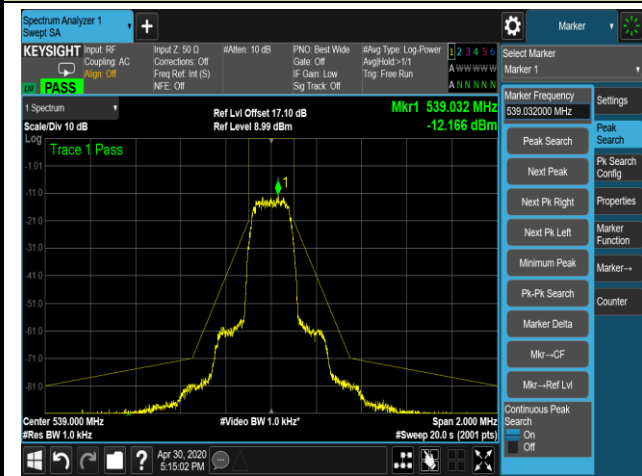

Necessary Bandwidth - STD Mode, 10mW, 607.875MHz

Step 1



Step 2

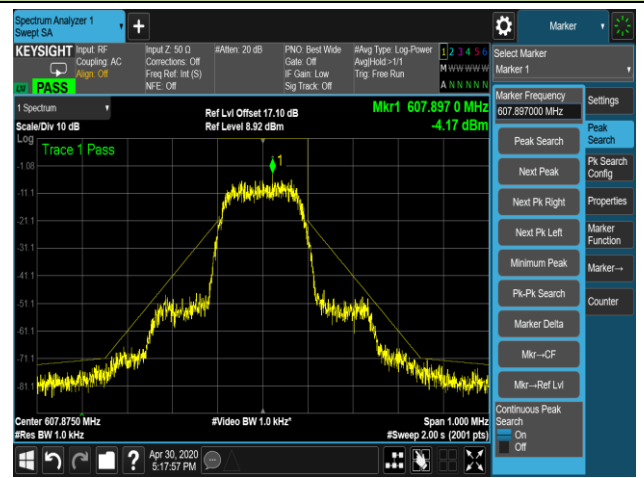

Step 3

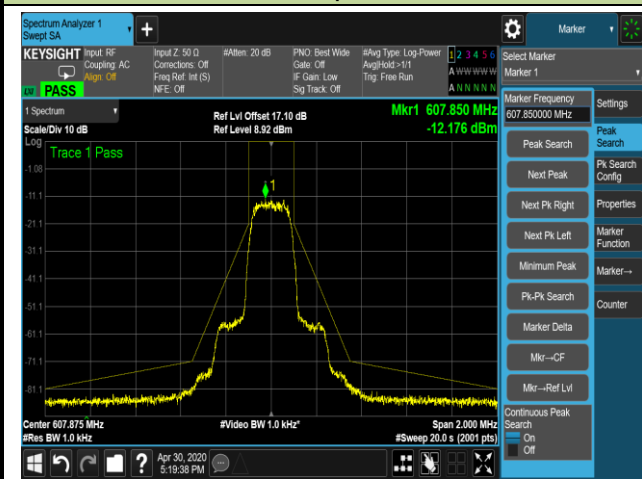

Necessary Bandwidth - STD Mode, 10mW, 614.125MHz

Step 1

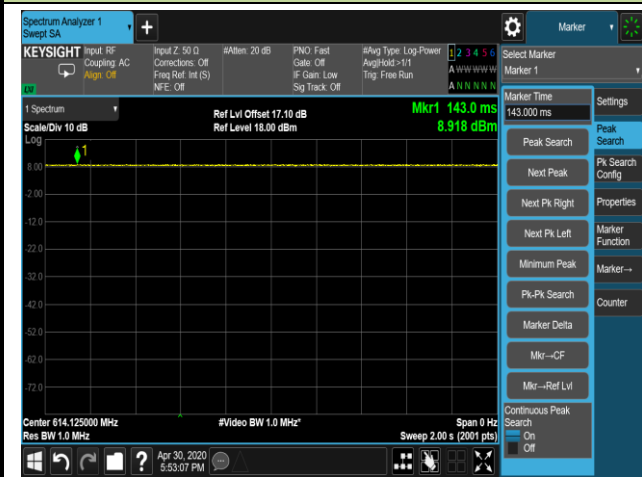

Step 2

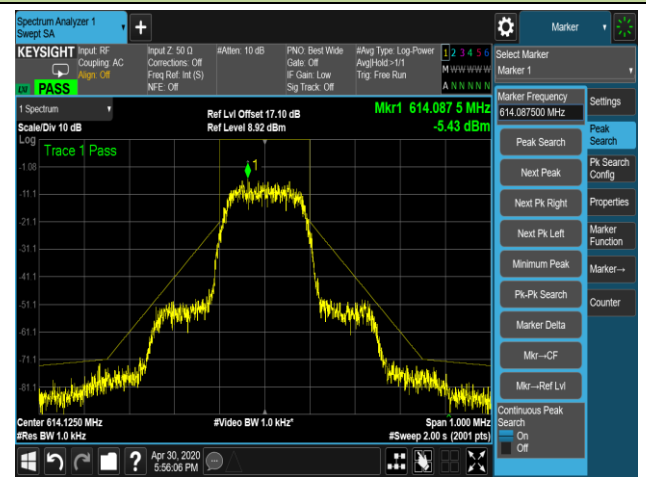

Step 3

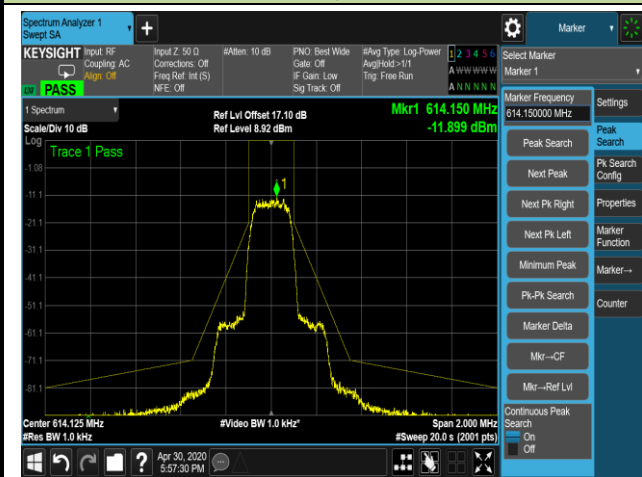

Necessary Bandwidth - STD Mode, 10mW, 615.875MHz

Step 1



Step 2

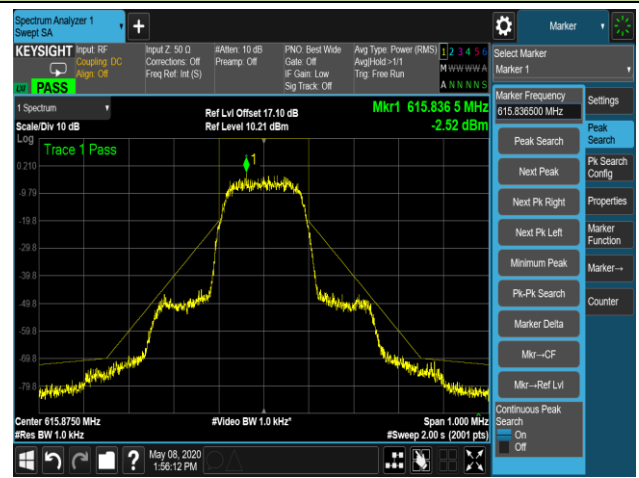

Step 3

