

# MEASUREMENT REPORT

## FCC PART 15.247 / Bluetooth BR & EDR

---

**FCC ID:** 616A-ITWR  
**Applicant:** Shure Incorporated  
**Application Type:** Certification  
**Product:** True Wireless Earphone  
**Model No.:** ITW-R  
**Trademark:**   
**FCC Classification:** FCC Part 15 Spread Spectrum Transmitter (DSS)  
**FCC Rule Part(s):** Part 15 Subpart C (Section 15.247)  
**Test Procedure(s):** ANSI C63.10-2013  
**Test Date:** June 19 ~ 24, 2021

**Reviewed By:**

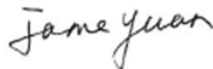

Jame Yuan

**Approved By:**

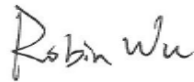

Robin Wu



The test results relate only to the samples tested.

This equipment has been shown to be capable of compliance with the applicable technical standards as indicated in the measurement report and was tested in accordance with the measurement procedures specified in ANSI C63.10-2013. Test results reported herein relate only to the item(s) tested.

The test report shall not be reproduced except in full without the written approval of MRT Technology (Suzhou) Co., Ltd.

---

## Revision History

Report No.	Version	Description	Issue Date	Note
2106RSU033-U1	Rev. 01	Initial Report	06-26-2021	Valid

---

## CONTENTS

Description	Page
<b>CONTENTS</b> .....	<b>3</b>
<b>1. GENERAL INFORMATION</b> .....	<b>6</b>
1.1. Applicant.....	6
1.2. Manufacturer .....	6
1.3. Testing Facility .....	6
1.4. Product Information .....	7
1.5. Radio Specification .....	7
1.6. Working Frequencies.....	8
1.7. Pseudorandom Frequency Hopping Sequence.....	9
1.8. Duty Cycle .....	10
1.9. Test Configuration and Software.....	11
1.10. EMI Suppression Device(s) / Modifications .....	11
1.11. Test Environment Condition.....	11
<b>2. ANTENNA REQUIREMENTS</b> .....	<b>12</b>
<b>3. TEST EQUIPMENT CALIBRATION DATE</b> .....	<b>13</b>
<b>4. MEASUREMENT UNCERTAINTY</b> .....	<b>16</b>
<b>5. TEST RESULT</b> .....	<b>17</b>
5.1. Summary .....	17
5.2. 20dB Bandwidth Measurement.....	18
5.2.1. Test Limit .....	18
5.2.2. Test Procedure Used .....	18
5.2.3. Test Setting.....	18
5.2.4. Test Setup.....	18
5.2.5. Test Result.....	19
5.3. Output Power Measurement.....	23
5.3.1. Test Limit .....	23
5.3.2. Test Procedure Used .....	23
5.3.3. Test Setting.....	23
5.3.4. Test Setup.....	24
5.3.5. Test Result.....	25
5.4. Carrier Frequency Separation Measurement .....	29
5.4.1. Test Limit .....	29
5.4.2. Test Procedure Used .....	29
5.4.3. Test Setting.....	29

5.4.4.	Test Setup.....	29
5.4.5.	Test Result.....	30
5.5.	Number of Hopping Channels Measurement.....	34
5.5.1.	Test Limit.....	34
5.5.2.	Test Procedure Used.....	34
5.5.3.	Test Setting.....	34
5.5.4.	Test Setup.....	34
5.5.5.	Test Result.....	35
5.6.	Time of Occupancy Measurement.....	38
5.6.1.	Test Limit.....	38
5.6.2.	Test Procedure Used.....	38
5.6.3.	Test Setting.....	38
5.6.4.	Test Setup.....	39
5.6.5.	Test Result.....	40
5.7.	Band-edge Compliance Measurement.....	42
5.7.1.	Test Limit.....	42
5.7.2.	Test Procedure Used.....	42
5.7.3.	Test Setting.....	42
5.7.4.	Test Setup.....	43
5.7.5.	Test Result.....	44
5.8.	Conducted Spurious Emissions Measurement.....	47
5.8.1.	Test Limit.....	47
5.8.2.	Test Procedure Used.....	47
5.8.3.	Test Setting.....	47
5.8.4.	Test Setup.....	48
5.8.5.	Test Result.....	49
5.9.	Radiated Spurious Emission Measurement.....	53
5.9.1.	Test Limit.....	53
5.9.2.	Test Procedure Used.....	53
5.9.3.	Test Setting.....	53
5.9.4.	Test Setup.....	55
5.9.5.	Test Result.....	56
5.10.	Radiated Restricted Band Edge Measurement.....	67
5.10.1.	Test Limit.....	67
5.10.2.	Test Procedure Used.....	68
5.10.3.	Test Setting.....	68
5.10.4.	Test Setup.....	69
5.10.5.	Test Result.....	70
5.11.	AC Conducted Emissions Measurement.....	94

---

5.11.1. Test Limit .....	94
5.11.2. Test Setup.....	94
5.11.3. Test Result.....	95
<b>6. CONCLUSION.....</b>	<b>97</b>
<b>Appendix A - Test Setup Photograph .....</b>	<b>98</b>
<b>Appendix B - EUT Photograph.....</b>	<b>99</b>

## 1. GENERAL INFORMATION

### 1.1. Applicant

Shure Incorporated

5800 West Touhy Avenue, Niles, IL 60714-4608, USA

### 1.2. Manufacturer

Shure Incorporated

5800 West Touhy Avenue, Niles, IL 60714-4608, USA

### 1.3. Testing Facility

<input checked="" type="checkbox"/>	<p><b>Test Site – MRT Suzhou Laboratory</b></p> <hr/> <p><b>Laboratory Location (Suzhou – Wuzhong)</b> D8 Building, No.2 Tian'edang Rd., Wuzhong Economic Development Zone, Suzhou, China</p> <p><b>Laboratory Location (Suzhou – SIP)</b> 4b Building, Liando U Valley, No.200 Xingpu Rd., Shengpu Town, Suzhou Industrial Park, China</p> <hr/> <p><b>Laboratory Accreditations</b></p> <p>A2LA: 3628.01 <span style="float: right;">CNAS: L10551</span>            FCC: CN1166 <span style="float: right;">ISED: CN0001</span>            VCCI: R-20025, G-20034, C-20020, T-20020</p>
<input type="checkbox"/>	<p><b>Test Site – MRT Shenzhen Laboratory</b></p> <hr/> <p><b>Laboratory Location (Shenzhen)</b> 1G, Building A, Junxiangda Building, Zhongshanyuan Road West, Nanshan District, Shenzhen, China</p> <hr/> <p><b>Laboratory Accreditations</b></p> <p>A2LA: 3628.02 <span style="float: right;">CNAS: L10551</span>            FCC: CN1284 <span style="float: right;">ISED: CN0105</span></p>
<input type="checkbox"/>	<p><b>Test Site – MRT Taiwan Laboratory</b></p> <hr/> <p><b>Laboratory Location (Taiwan)</b> No. 38, Fuxing 2<sup>nd</sup> Rd., Guishan Dist., Taoyuan City 333, Taiwan (R.O.C.)</p> <hr/> <p><b>Laboratory Accreditations</b></p> <p>TAF: L3261-190725            FCC: 291082, TW3261 <span style="float: right;">ISED: TW3261</span></p>

#### 1.4. Product Information

Product Name	True Wireless Earphone
Model No.	ITW-R
Bluetooth Version	v5.1 dual mode
Antenna Information	Refer to clause 1.5
Operating Temperature	0 ~ 45 °C
Power Type	Internal Li-ion Battery Input

Note: The information of EUT was provided by the manufacturer, and the accuracy of the information shall be the responsibility of the manufacturer.

#### 1.5. Radio Specification

Operating Frequency	2402~2480MHz
Channel Number	79
Type of modulation	GFSK, Pi/4 DQPSK, 8DPSK
Data Rate	1Mbps (GFSK), 2Mbps (Pi/4 DQPSK), 3Mbps (8DPSK)
Antenna Type	Monopole Antenna
Antenna Gain	-0.82dBi

Note: For other features of this EUT, test report will be issued separately.

- 15.247(g): In accordance with the Bluetooth Industry Standard, the system is designed to comply with all of the regulations in Section 15.247 when the transmitter is presented with a continuous data (or information) system.
- 15.247(h): In accordance with the Bluetooth Industry Standard, the system does not coordinate its channels selection/ hopping sequence with other frequency hopping systems for the express purpose of avoiding the simultaneous occupancy of individual hopping frequencies by multiple transmitters.
- 15.247(h): The EUT employs Adaptive Frequency Hopping (AFH) which identifies sources of interference namely devices operating in 802.11 WLAN and excludes them from the list of available channels. The process of re-mapping reduces the number of test channels from 79 channels to a minimum number of 20 channels.

### 1.6. Working Frequencies

Channel	Frequency	Channel	Frequency	Channel	Frequency
00	2402 MHz	01	2403 MHz	02	2404 MHz
03	2405 MHz	04	2406 MHz	05	2407 MHz
06	2408 MHz	07	2409 MHz	08	2410 MHz
09	2411 MHz	10	2412 MHz	11	2413 MHz
12	2414 MHz	13	2415 MHz	14	2416 MHz
15	2417 MHz	16	2418 MHz	17	2419 MHz
18	2420 MHz	19	2421 MHz	20	2422 MHz
21	2423 MHz	22	2424 MHz	23	2425 MHz
24	2426 MHz	25	2427 MHz	26	2428 MHz
27	2429 MHz	28	2430 MHz	29	2431 MHz
30	2432 MHz	31	2433 MHz	32	2434 MHz
33	2435 MHz	34	2436 MHz	35	2437 MHz
36	2438 MHz	37	2439 MHz	38	2440 MHz
39	2441 MHz	40	2442 MHz	41	2443 MHz
42	2444 MHz	43	2445 MHz	44	2446 MHz
45	2447 MHz	46	2448 MHz	47	2449 MHz
48	2450 MHz	49	2451 MHz	50	2452 MHz
51	2453 MHz	52	2454 MHz	53	2455 MHz
54	2456 MHz	55	2457 MHz	56	2458 MHz
57	2459 MHz	58	2460 MHz	59	2461 MHz
60	2462 MHz	61	2463 MHz	62	2464 MHz
63	2465 MHz	64	2466 MHz	65	2467 MHz
66	2468 MHz	67	2469 MHz	68	2470 MHz
69	2471 MHz	70	2472 MHz	71	2473 MHz
72	2474 MHz	73	2475 MHz	74	2476 MHz
75	2477 MHz	76	2478 MHz	77	2479 MHz
78	2480 MHz	--	--	--	--



### 1.7. Pseudorandom Frequency Hopping Sequence

The pseudorandom sequence may be generated in a nine-stage shift register whose 5<sup>th</sup> and 9<sup>th</sup> stage outputs are added in a modulo-two addition stage. And the result is fed back to the input of the first stage. The sequence begins with the first ONE of 9 consecutive ONES, i.e. the shift register is initialized with nine ones.

- Number of shift register stages: 9
- Length of pseudo-random sequence:  $2^9 - 1 = 511$  bits
- Longest sequence of zeros: 8 (non-inverted signal)

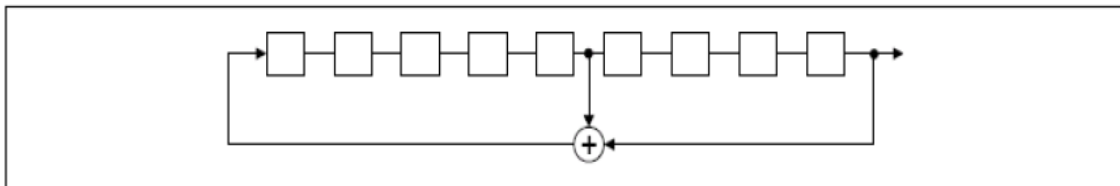

Linear Feedback Shift Register for Generation of the PRBS sequence

An example of Pseudorandom Frequency Hopping Sequence as follow:

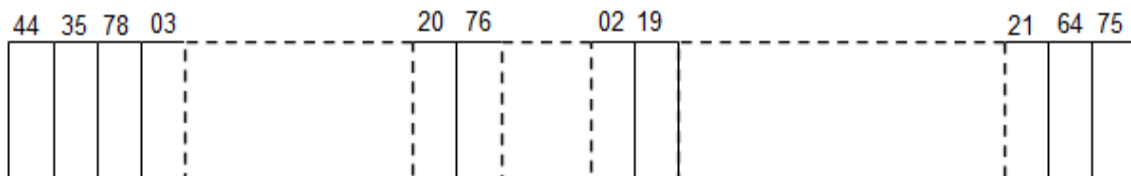

Each frequency used equally on the average by each transmitter.

The system receivers have input bandwidths that match the hopping channel bandwidths of their Corresponding transmitters and shift frequencies in synchronization with the transmitted signals.

### 1.8. Duty Cycle

The maximum achievable duty cycle was determined based on measurements performed on a spectrum analyzer in zero-span mode with RBW = 8MHz, VBW = 50MHz. The RBW and VBW were both greater than 50/T, where T is the minimum transmission duration, and the number of sweep points across T was greater than 100. The duty cycles are as follows:

Test Mode	Duty Cycle
DH5	76.53%
2DH5	76.60%
3DH5	76.80%

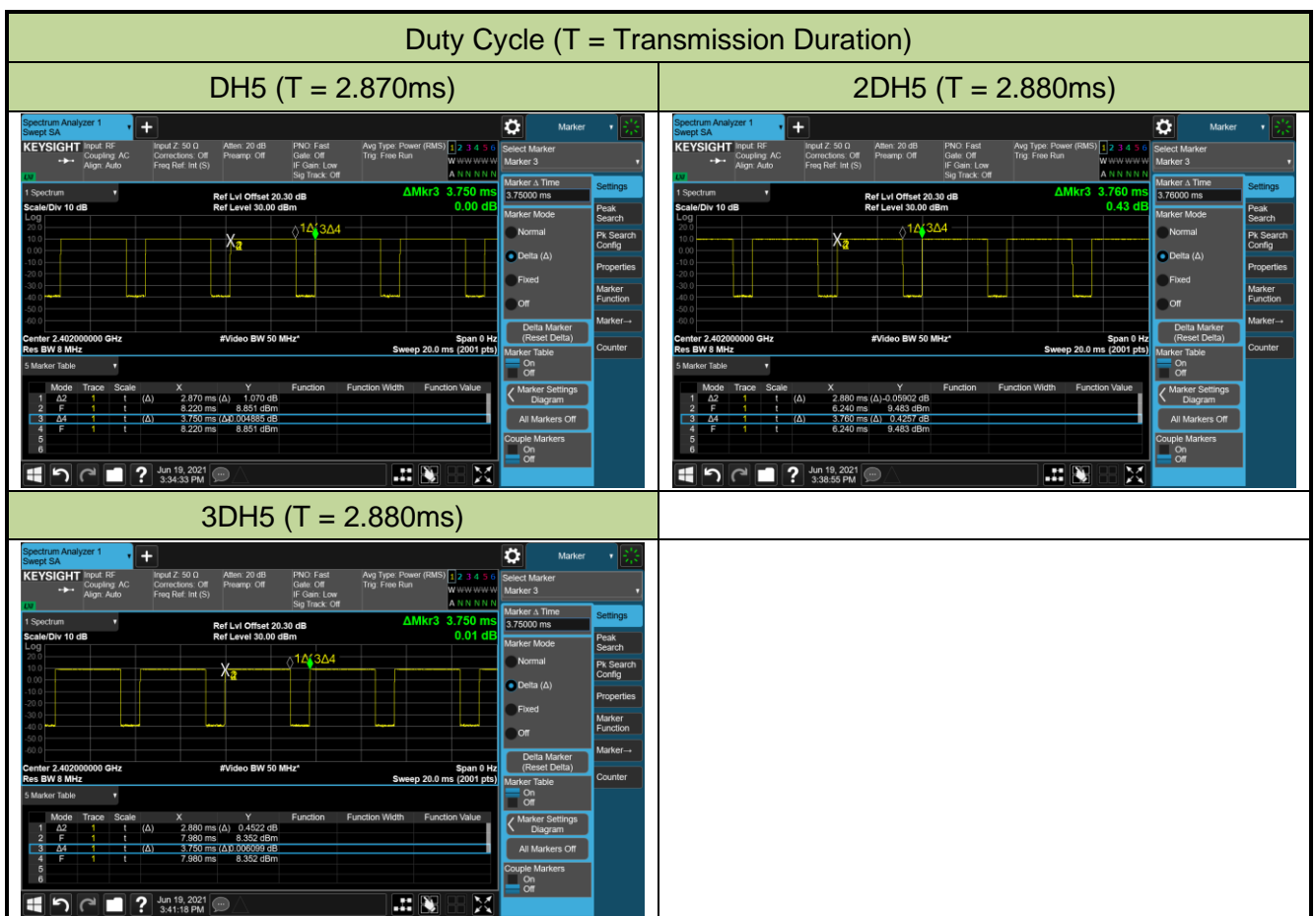

### 1.9. Test Configuration and Software

The device was tested per the guidance ANSI C63.10-2013 that was used to reference the appropriate EUT setup for radiated spurious emissions and AC line conducted emission testing.

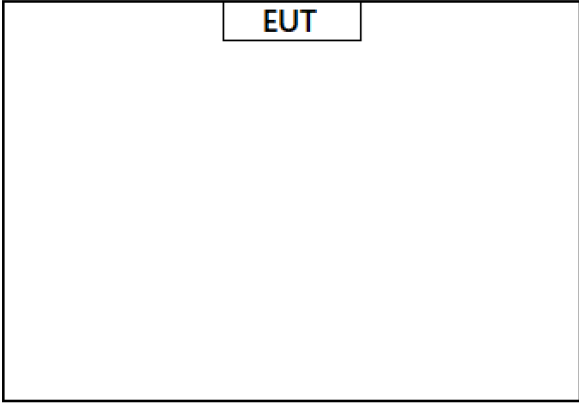
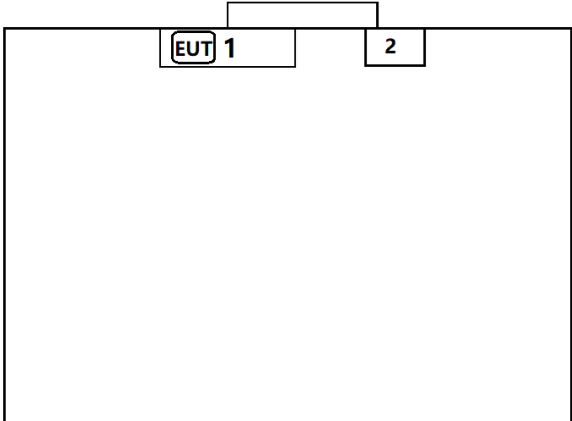
Radiated Spurious Emissions		AC line Conducted Emission	
			
Product	Manufacturer	Model No.	
1 Charging Case	Shure	ITW1	
2 Adapter	Shenzhen Honor Electronic Co., Ltd	ADS-12B-06 05010E	

Note 1: The test utility software used during testing was “BlueTest3”, and the version was 3.2.3.29.

Note 2: Detail power setting refer to operation description.

### 1.10. EMI Suppression Device(s) / Modifications

No EMI suppression device(s) were added and/or no modifications were made during testing.

### 1.11. Test Environment Condition

Ambient Temperature	15 ~ 35 °C
Relative Humidity	20 ~ 75 %RH

## 2. ANTENNA REQUIREMENTS

### **Excerpt from §15.203 of the FCC Rules/Regulations:**

“An intentional radiator antenna shall be designed to ensure that no antenna other than that furnished by the responsible party can be used with the device. The use of a permanently attached antenna or of an antenna that uses a unique coupling to the intentional radiator shall be considered sufficient to comply with the provisions of this section.”

- The antenna of the device is **permanently attached**.
- There are no provisions for connection to an external antenna.

### **Conclusion:**

The unit complies with the requirement of §15.203.

### 3. TEST EQUIPMENT CALIBRATION DATE

#### Conducted Emission (WZ-SR2)

Instrument	Manufacturer	Type No.	Asset No.	Cali. Interval	Cali. Due Date
EMI Test Receiver	R&S	ESR3	MRTSUE06909	1 year	2021/11/22
Two-Line V-Network	R&S	ENV216	MRTSUE06002	1 year	2022/06/08
Thermal Hygrometer	testo	608-H1	MRTSUE06404	1 year	2021/07/26

#### Conducted Emission (SIP-SR2)

Instrument	Manufacturer	Type No.	Asset No.	Cali. Interval	Cali. Due Date
EMI Test Receiver	R&S	ESR3	MRTSUE06613	1 year	2021/07/02
Two-Line V-Network	R&S	ENV216	MRTSUE06003	1 year	2022/06/08
Thermal Hygrometer	testo	608-H1	MRTSUE06621	1 year	2021/12/03

#### Radiated Emission (WZ-AC1)

Instrument	Manufacturer	Type No.	Asset No.	Cali. Interval	Cali. Due Date
EMI Test Receiver	R&S	ESR7	MRTSUE06001	1 year	2022/01/04
Loop Antenna	Schwarzbeck	FMZB 1519	MRTSUE06025	1 year	2021/11/08
Bilog Period Antenna	Schwarzbeck	VULB 9168	MRTSUE06172	1 year	2021/08/08
Horn Antenna	Schwarzbeck	BBHA 9120D	MRTSUE06023	1 year	2021/09/27
Horn Antenna	Schwarzbeck	BBHA9170	MRTSUE06597	1 year	2021/12/14
Microwave System Amplifier	Agilent	83017A	MRTSUE06076	1 year	2021/11/14
Preamplifier	Schwarzbeck	BBV 9721	MRTSUE06121	1 year	2022/06/10
Thermal Hygrometer	testo	608-H1	MRTSUE06403	1 year	2021/07/26
Anechoic Chamber	TDK	Chamber-AC1	MRTSUE06212	1 year	2022/04/29

#### Radiated Emission (WZ-AC2)

Instrument	Manufacturer	Type No.	Asset No.	Cali. Interval	Cali. Due Date
MXE EMI Receiver	Keysight	N9038A	MRTSUE06125	1 year	2021/07/02
Loop Antenna	Schwarzbeck	FMZB 1519	MRTSUE06025	1 year	2021/11/08
Bilog Period Antenna	Schwarzbeck	VULB 9162	MRTSUE06022	1 year	2022/05/24
Broad-Band Horn Antenna	Schwarzbeck	BBHA 9120D	MRTSUE06171	1 year	2021/10/25
Horn Antenna	Schwarzbeck	BBHA9170	MRTSUE06597	1 year	2021/12/14
Broadband Coaxial Preamplifier	Schwarzbeck	BBV 9718	MRTSUE06176	1 year	2021/11/14
Thermal Hygrometer	Minggao	ETH529	MRTSUE06170	1 year	2021/12/08
Anechoic Chamber	RIKEN	Chamber-AC2	MRTSUE06213	1 year	2022/04/29

## Radiated Emission (SIP-AC1)

Instrument	Manufacturer	Type No.	Asset No.	Cali. Interval	Cali. Due Date
EMI Test Receiver	R&S	ESR3	MRTSUE06612	1 year	2021/07/02
EXA Signal Analyzer	Keysight	N9010B	MRTSUE06559	1 year	2021/07/23
Loop Antenna	Schwarzbeck	FMZB 1519 B	MRTSUE06937	1 year	2022/03/09
Bilog Period Antenna	Schwarzbeck	VULB9168	MRTSUE06645	1 year	2021/08/30
Double Ridged Horn Antenna	R&S	HF907	MRTSUE06610	1 year	2021/08/30
Preamplifier	EMCI	EMC051845SE	MRTSUE06600	1 year	2021/11/09
Thermal Hygrometer	testo	608-H1	MRTSUE06620	1 year	2021/12/03
Anechoic Chamber	RIKEN	SIP-AC1	MRTSUE06554	1 year	2021/12/24

## Radiated Emission (SIP-AC2)

Instrument	Manufacturer	Type No.	Asset No.	Cali. Interval	Cali. Due Date
EMI Test Receiver	R&S	ESR3	MRTSUE06613	1 year	2021/07/02
MXA Signal Analyzer	Keysight	N9020B	MRTSUE06604	1 year	2021/09/26
Loop Antenna	Schwarzbeck	FMZB 1519 B	MRTSUE06937	1 year	2022/03/09
Bilog Period Antenna	Schwarzbeck	VULB9168	MRTSUE06646	1 year	2021/08/30
Horn Antenna	Schwarzbeck	BBHA9120D	MRTSUE06648	1 year	2021/11/26
Horn Antenna	Schwarzbeck	BBHA9170	MRTSUE06599	1 year	2021/11/26
Preamplifier	EMCI	EMC051845SE	MRTSUE06644	1 year	2021/11/09
Preamplifier	EMCI	EMC184045SE	MRTSUE06602	1 year	2021/10/12
Thermal Hygrometer	testo	608-H1	MRTSUE06624	1 year	2021/12/03
Anechoic Chamber	RIKEN	SIP-AC2	MRTSUE06781	1 year	2021/12/24

## Radiated Emission (SIP-AC3)

Instrument	Manufacturer	Type No.	Asset No.	Cali. Interval	Cali. Due Date
Preamplifier	Schwarzbeck	BBV 9721	MRTSUE06121	1 year	2022/06/10
EMI Test Receiver	R&S	ESR3	MRTSUE06612	1 year	2021/07/02
EXA Signal Analyzer	Keysight	N9010B	MRTSUE06559	1 year	2021/07/23
Loop Antenna	Schwarzbeck	FMZB 1519	MRTSUE06025	1 year	2021/11/08
Bilog Period Antenna	Schwarzbeck	VULB9168	MRTSUE06646	1 year	2021/08/30
Double Ridged Horn Antenna	R&S	HF907	MRTSUE06611	1 year	2021/09/13
Horn Antenna	Schwarzbeck	BBHA9170	MRTSUE06598	1 year	2021/11/26
Preamplifier	EMCI	EMC012645SE	MRTSUE06642	1 year	2022/01/14
Thermal Hygrometer	testo	608-H1	MRTSUE06622	1 year	2021/12/03
Anechoic Chamber	RIKEN	SIP-AC3	MRTSUE06782	1 year	2021/12/24

## Conducted Test Equipment (WZ-TR3)

Instrument	Manufacturer	Type No.	Asset No.	Cali. Interval	Cali. Due Date
EXA Signal Analyzer	Agilent	N9020A	MRTSUE06106	1 year	2022/04/13
EXA Signal Analyzer	Keysight	N9010B	MRTSUE06607	1 year	2022/01/06
Power Meter	Agilent	U2021XA	MRTSUE06030	1 year	2021/10/22
USB wideband power sensor	Keysight	U2021XA	MRTSUE06446	1 year	2022/06/08
USB wideband power sensor	Keysight	U2021XA	MRTSUE06447	1 year	2022/06/08
Bluetooth Test Set	Anritsu	MT8852B-042	MRTSUE06389	1 year	2022/06/08
Modulation Analyzer	HP	HP8901A	MRTSUE06098	1 year	2021/09/26
DC Power Supply	GWINSTEK	DPS-3303C	MRTSUE06064	N/A	N/A
Temperature & Humidity Chamber	BAOYT	BYH-150CL	MRTSUE06051	1 year	2021/10/22
Thermal Hygrometer	testo	608-H1	MRTSUE06401	1 year	2021/07/26

## Conducted Test Equipment (SIP-TR1)

Instrument	Manufacturer	Type No.	Asset No.	Cali. Interval	Cali. Due Date
EXA Signal Analyzer	KEYSIGHT	N9010B	MRTSUE06603	1 year	2021/11/23
PXA Signal Analyzer	Keysight	N9030B	MRTSUE06395	1 year	2021/08/30
USB wideband power sensor	Agilent	U2021XA	MRTSUE06595	1 year	2021/09/26
USB wideband power sensor	Agilent	U2021XA	MRTSUE06596	1 year	2021/09/26
Temperature Chamber	BAOYT	BYG-408CS	MRTSUE06847	1 year	2022/02/23
Thermal Hygrometer	testo	608-H1	MRTSUE11022	1 year	2021/11/25

Software	Version	Function
EMI Software	V3	EMI Test Software

## 4. MEASUREMENT UNCERTAINTY

Where relevant, the following test uncertainty levels have been estimated for tests performed on the EUT as specified in CISPR 16-4-2. This uncertainty represents an expanded uncertainty expressed at approximately the 95% confidence level using a coverage factor of  $k = 2$ .

<b>AC Conducted Emission Measurement</b>
Measurement Uncertainty for a Level of Confidence of 95% ( $U=2Uc(y)$ ): 9kHz~150kHz: 3.74dB 150kHz~30MHz: 3.44dB
<b>Radiated Disturbance</b>
Measurement Uncertainty for a Level of Confidence of 95% ( $U=2Uc(y)$ ): Horizontal: 9kHz~300MHz: 5.04dB 300MHz~1GHz: 4.95dB 1GHz~40GHz: 6.40dB Vertical: 9kHz~300MHz: 5.24dB 300MHz~1GHz: 6.03dB 1GHz~40GHz: 6.40dB
<b>Spurious Emissions, Conducted</b>
Measuring Uncertainty for a Level of Confidence of 95% ( $U=2Uc(y)$ ): 0.78dB
<b>Output Power</b>
Measuring Uncertainty for a Level of Confidence of 95% ( $U=2Uc(y)$ ): 1.13dB
<b>Occupied Bandwidth</b>
Measuring Uncertainty for a Level of Confidence of 95% ( $U=2Uc(y)$ ): 0.28%



## 5. TEST RESULT

### 5.1. Summary

FCC Part Section(s)	Test Description	Test Limit	Test Condition	Test Result	Reference
15.247(a)(1)	20dB Bandwidth	N/A	Conducted	Pass	Section 5.2
15.247(b)(1)	Peak Transmitter Output Power	<1 Watt if > 75 non-overlapping channels used or 125mW		Pass	Section 5.3
15.24207(a)(1)	Channel Separation	> 2/3 of 20 dB BW for systems with Output Power < 125mW		Pass	Section 5.4
15.247(a)(1)(iii)	Number of Channels	> 15 Channels		Pass	Section 5.5
15.247(a)(1)(iii)	Time of Occupancy	< 0.4 sec in 31.6 sec period		Pass	Section 5.6
15.247(d)	Band Edge / Out-of-Band Emissions	Conducted $\geq$ 20dBc		Pass	Section 5.7 Section 5.8
15.205, 15.209	General Field Strength (Restricted Bands and Radiated Emission)	Emissions in restricted bands must meet the radiated limits detailed in 15.209	Radiated	Pass	Section 5.9 Section 5.10
15.207	AC Conducted Emissions 150kHz - 30MHz	< FCC 15.207 limits	Line Conducted	Pass	Section 5.11

#### Notes:

- 1) The analyzer plots shown in this section were all taken with a correction table loaded into the analyzer. The correction table was used to account for the losses of the cables and attenuators used as part of the system to connect the EUT to the analyzer at all frequencies of interest.
- 2) All modes of operation and data rates were investigated. For radiated emission test, every axis (X, Y, Z) was also verified. The test results shown in the following sections represent the worst-case emissions.
- 3) "N/A" means no limit required.

## 5.2. 20dB Bandwidth Measurement

### 5.2.1. Test Limit

N/A

### 5.2.2. Test Procedure Used

ANSI C63.10-2013 - Section 6.9.2

### 5.2.3. Test Setting

1. Set RBW  $\geq$  1% to 5% of the OBW
2. VBW = Approximately three times RBW
3. Span = Approximately 2 to 5 times the OBW, centered on a hopping channel
4. Detector = Peak
5. Trace mode = Max hold
6. Sweep = Auto couple
7. Allow the trace to stabilize
8. Measure the maximum width of the emission that is constrained by the frequencies associated with the two outermost amplitude points (upper and lower frequencies) that are attenuated by 20 dB relative to the maximum level measured in the fundamental emission.

### 5.2.4. Test Setup

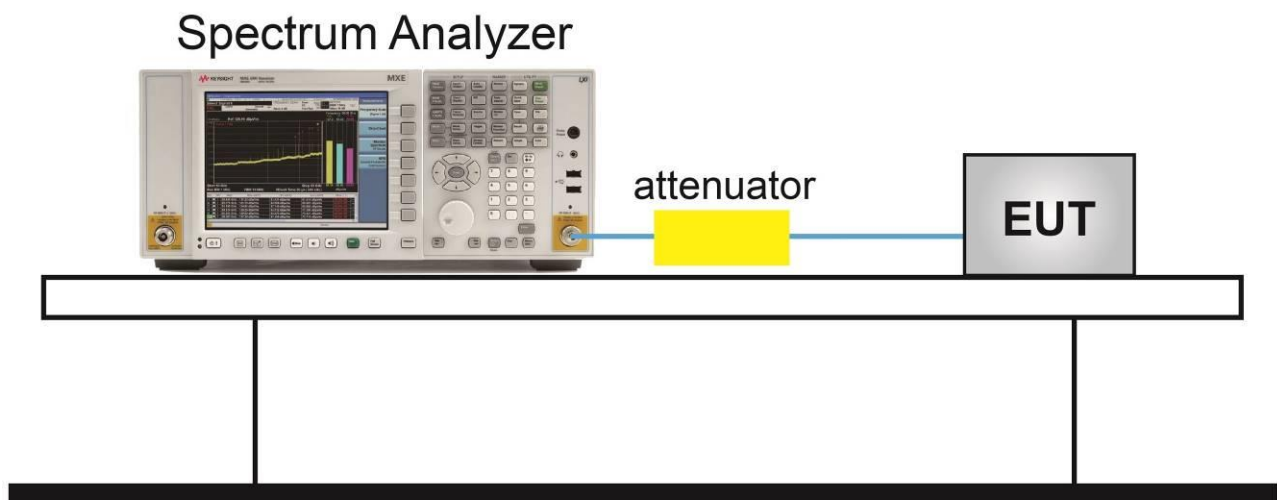

**5.2.5. Test Result**

Test Site	SIP-TR1	Test Engineer	Alisa Deng
Test Date	2021/06/19		

Test Mode	Channel No.	Frequency (MHz)	20dB Bandwidth (kHz)
DH5	00	2402	925.1
DH5	39	2441	926.8
DH5	78	2480	922.4
2DH5	00	2402	1316.0
2DH5	39	2441	1315.0
2DH5	78	2480	1316.0
3DH5	00	2402	1319.0
3DH5	39	2441	1292.0
3DH5	78	2480	1311.0

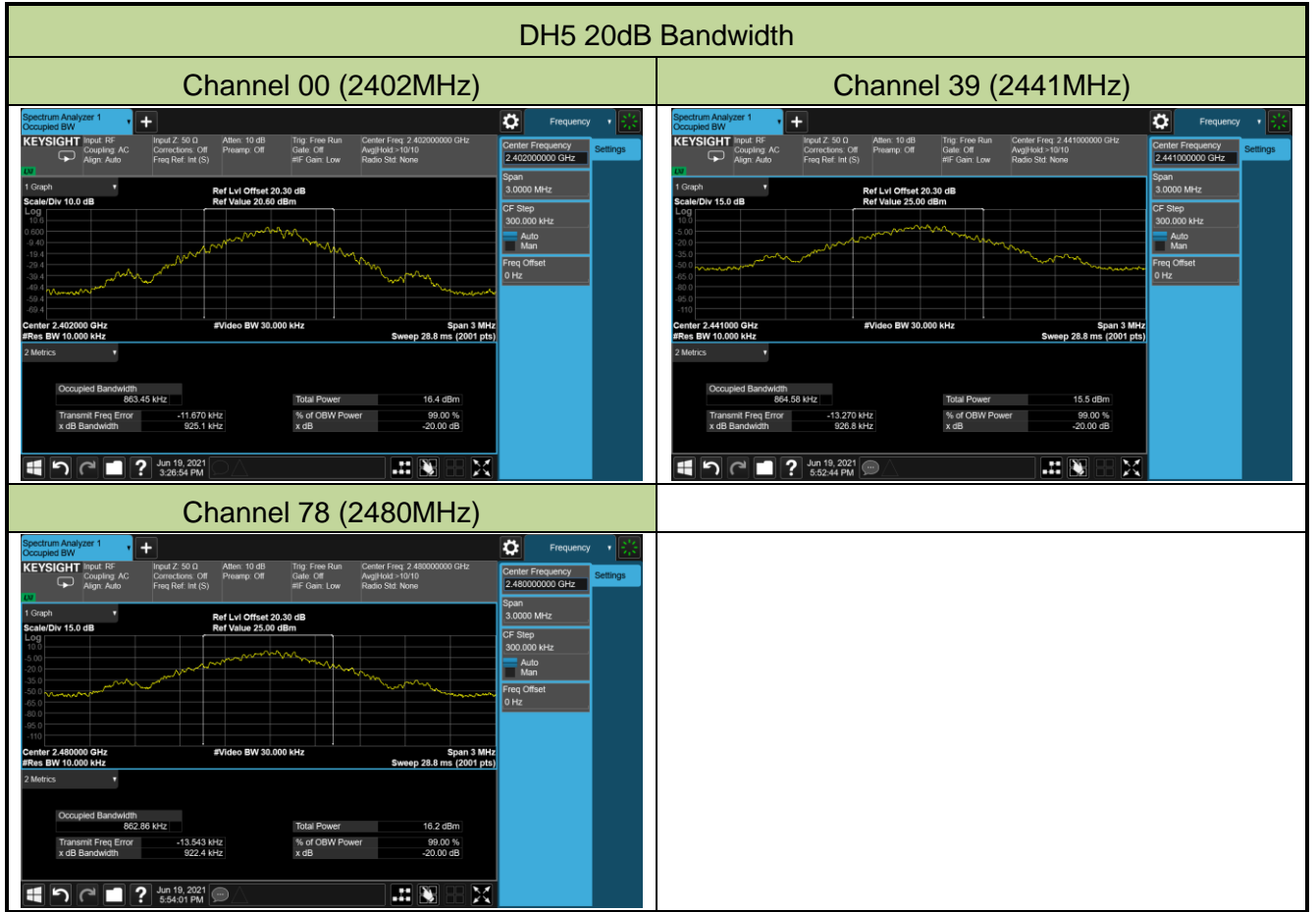

## 2DH5 20dB Bandwidth

## Channel 00 (2402MHz)



## Channel 39 (2441MHz)



## Channel 78 (2480MHz)

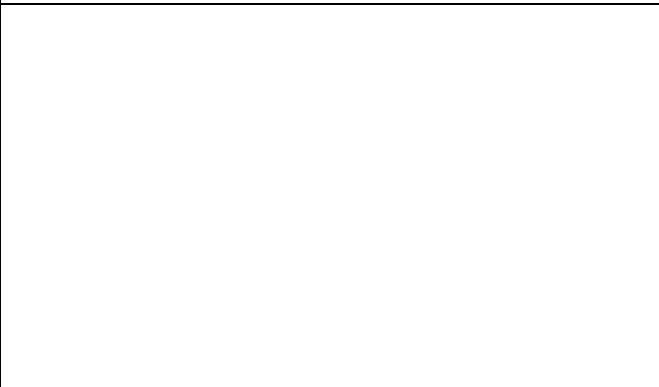
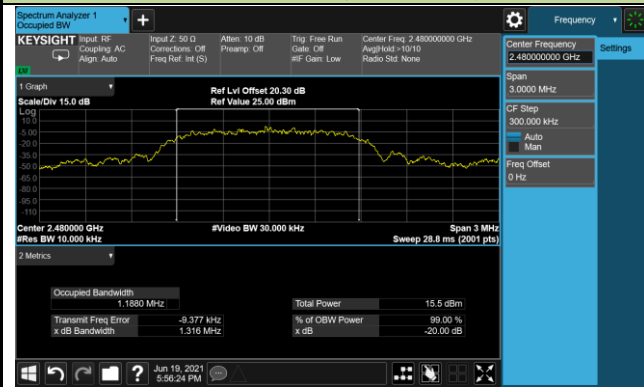

3DH5 20dB Bandwidth

Channel 00 (2402MHz)

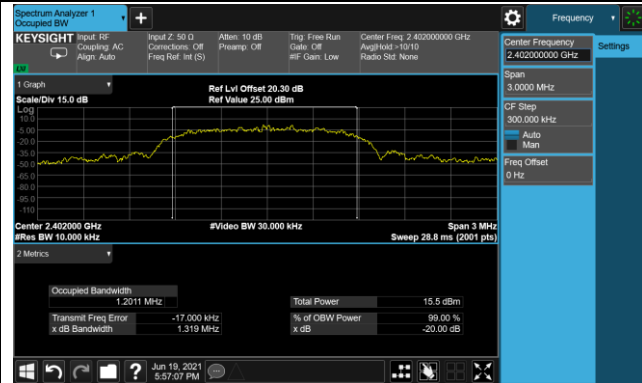

Channel 39 (2441MHz)



Channel 78 (2480MHz)

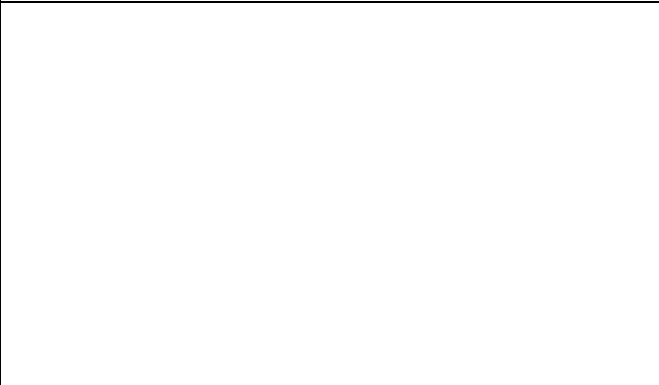
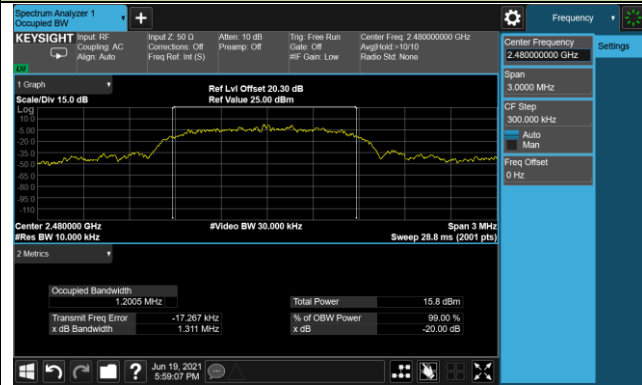

### **5.3. Output Power Measurement**

#### **5.3.1. Test Limit**

The maximum out power permissible output power is 1 Watt for all frequency hopping systems operating in the 2400-2483.5 MHz band employing at least 75 non-overlapping hopping channels. For all other frequency hopping systems in the 2400-2483.5 MHz band: 0.125 watts.

#### **5.3.2. Test Procedure Used**

ANSI C63.10-2013 - Section 7.8.5

ANSI C63.10-2013 - Section 11.9.2.3.2

#### **5.3.3. Test Setting**

1. Set RBW  $\geq$  the 20 dB bandwidth of the emission being measured.
2. VBW  $\geq$  RBW
3. Span = approximately five times the 20dB bandwidth, centered on a hopping channel
4. Detector = Peak
5. Trace mode = Max hold
6. Sweep = Auto couple
7. Allow the trace to stabilize. Use the marker-to-peak function to set the marker to the peak of the emission. The indicated level is the peak output power (don't forget added the external attenuation and cable loss)

#### **Method AVGPM-G (Measurement using a gated RF average-reading power meter)**

Measurements may be performed using a wideband gated RF power meter provided that the gate parameters are adjusted such that the power is measured only when the EUT is transmitting at its maximum power control level. Since this measurement is made only during the ON time of the transmitter, no duty cycle correction is required.

### 5.3.4. Test Setup

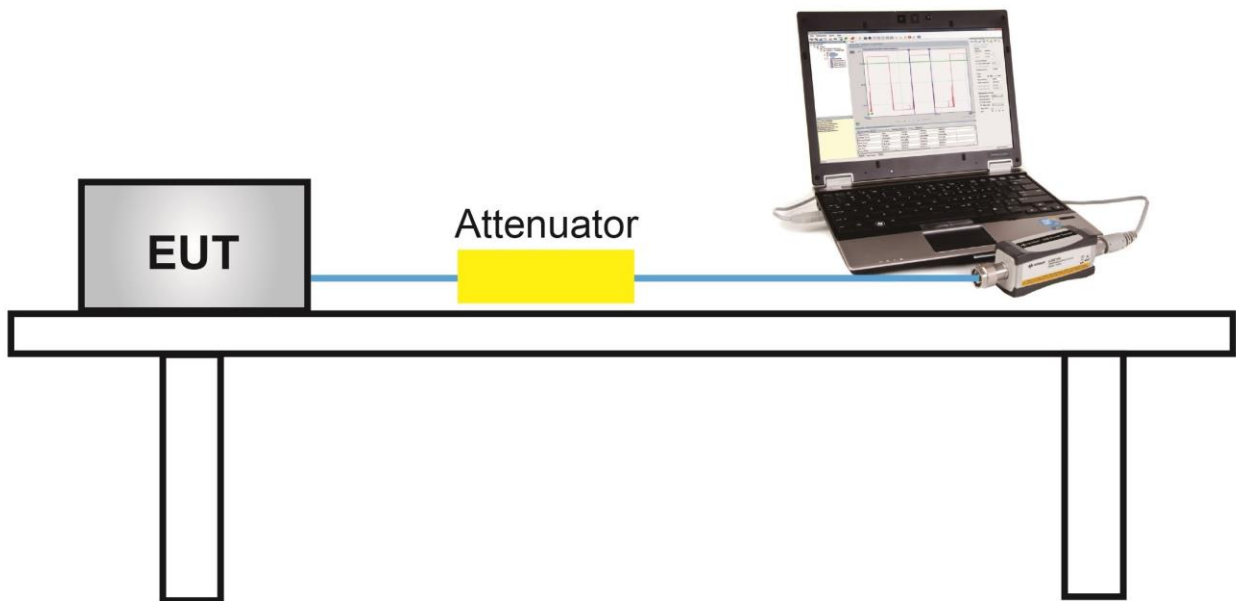
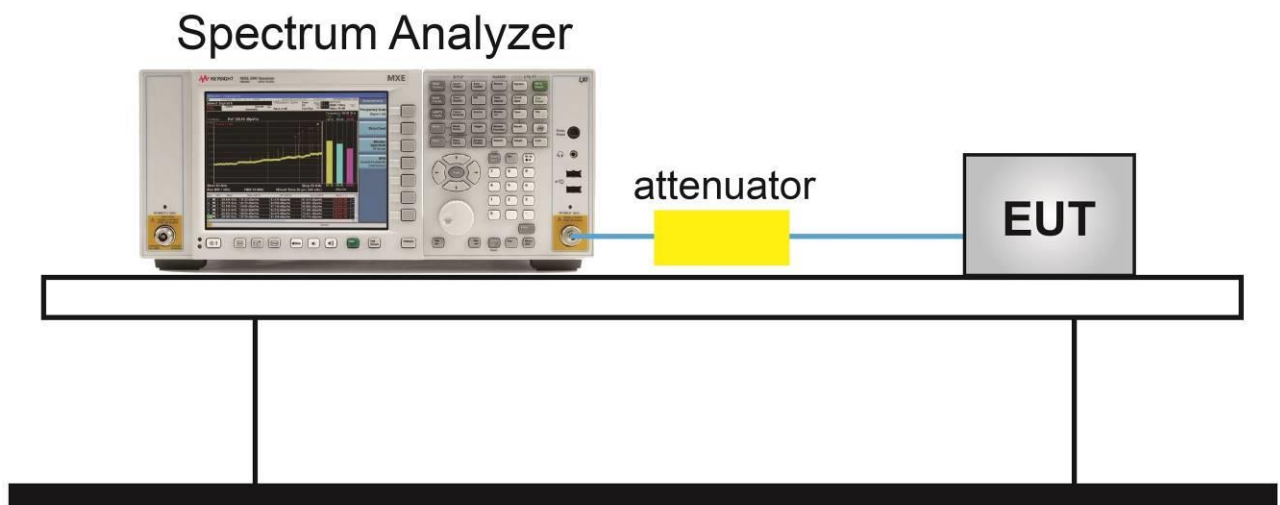



### 5.3.5. Test Result

Test Site	SIP-TR1	Test Engineer	Alisa Deng
Test Date	2021/06/21		

Test Mode	Channel No.	Frequency (MHz)	Peak Power (dBm)	Power Limit (dBm)
DH5	00	2402	10.09	≤ 20.97
DH5	39	2441	10.09	≤ 20.97
DH5	78	2480	10.20	≤ 20.97
2DH5	00	2402	11.46	≤ 20.97
2DH5	39	2441	11.36	≤ 20.97
2DH5	78	2480	11.53	≤ 20.97
3DH5	00	2402	12.00	≤ 20.97
3DH5	39	2441	12.01	≤ 20.97
3DH5	78	2480	12.01	≤ 20.97

### Test Result of Average Output Power (Reporting Only)

Test Mode	Channel No.	Frequency (MHz)	Average Power (dBm)	Limit (dBm)
DH5	00	2402	9.69	≤ 20.97
DH5	39	2441	9.72	≤ 20.97
DH5	78	2480	9.74	≤ 20.97
2DH5	00	2402	9.16	≤ 20.97
2DH5	39	2441	8.92	≤ 20.97
2DH5	78	2480	8.88	≤ 20.97
3DH5	00	2402	9.16	≤ 20.97
3DH5	39	2441	9.08	≤ 20.97
3DH5	78	2480	9.06	≤ 20.97

### DH5 Output Power

#### Channel 00 (2402MHz)

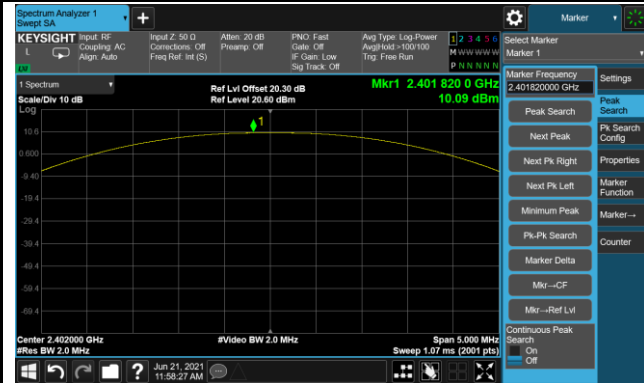

#### Channel 39 (2441MHz)

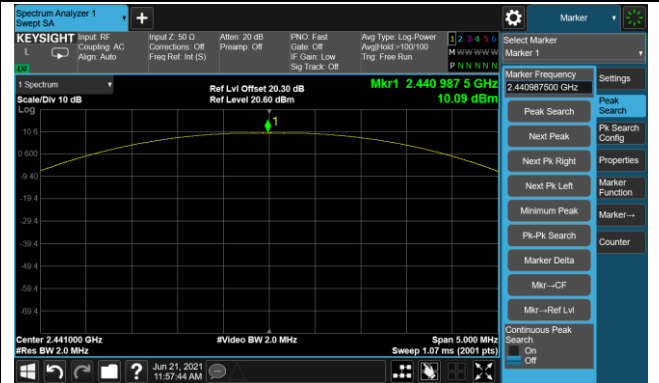

#### Channel 78 (2480MHz)

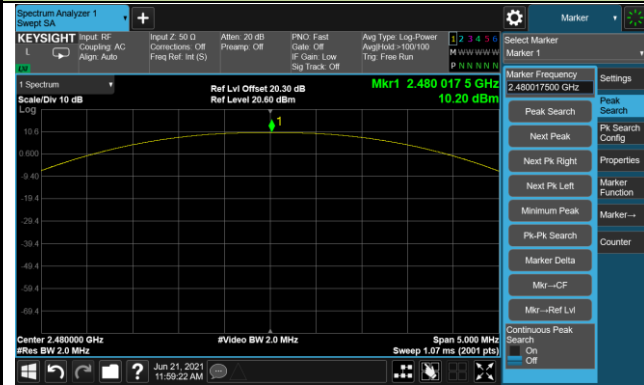

## 2DH5 Output Power

### Channel 00 (2402MHz)

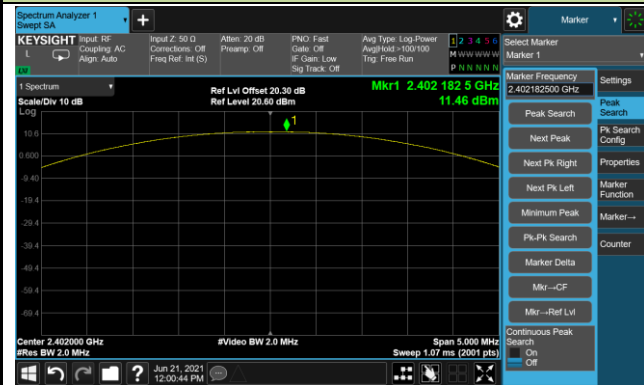

### Channel 39 (2441MHz)

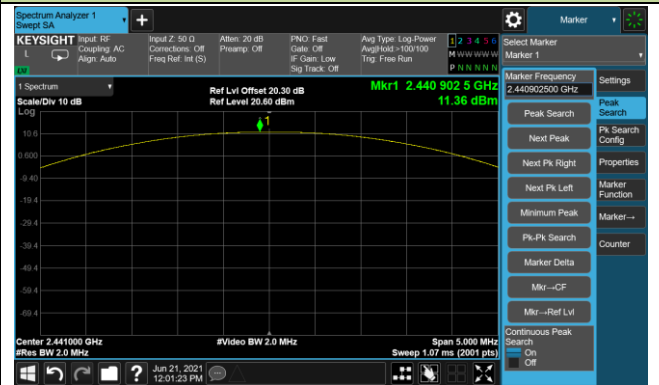

### Channel 78 (2480MHz)

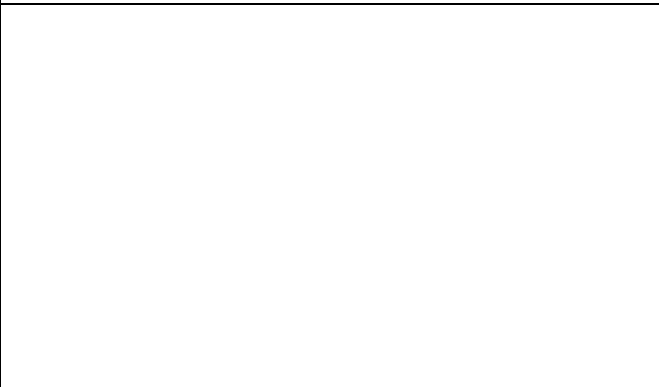
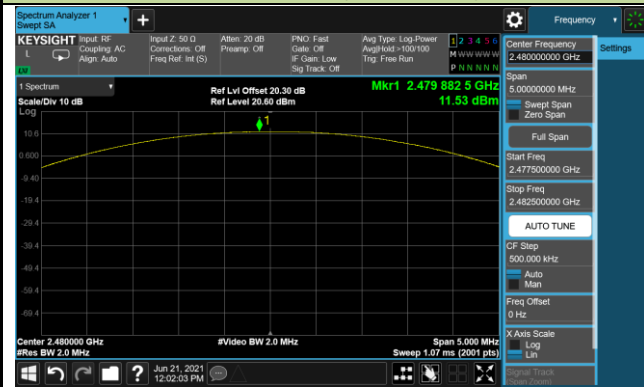

### 3DH5 Output Power

Channel 00 (2402MHz)

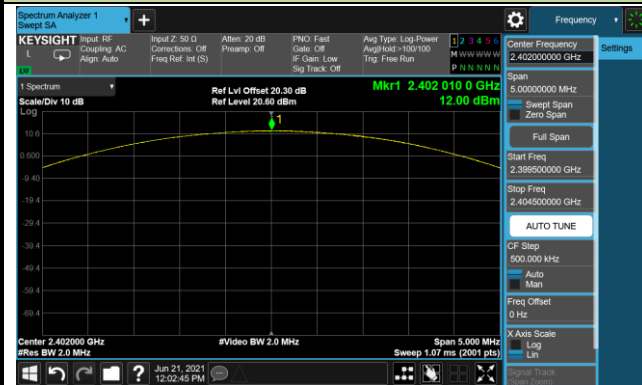

Channel 39 (2441MHz)

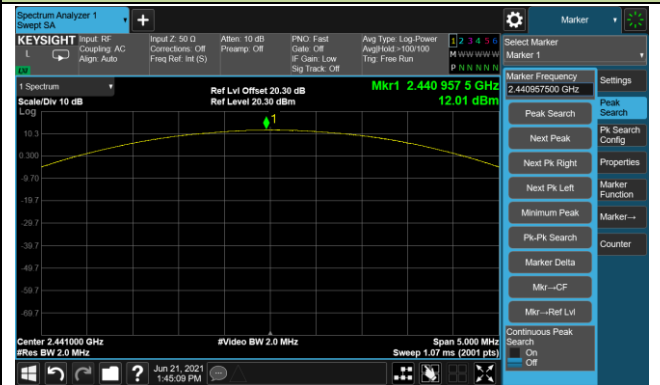

Channel 78 (2480MHz)

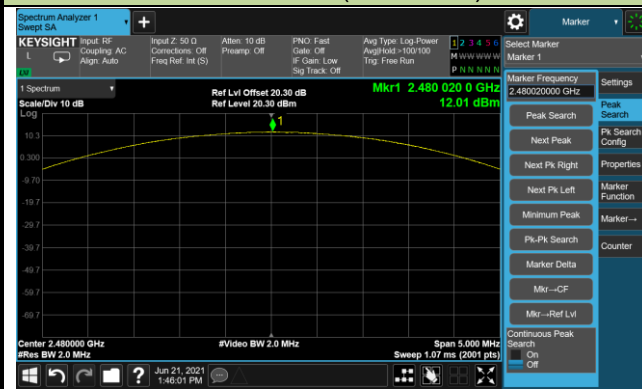

## 5.4. Carrier Frequency Separation Measurement

### 5.4.1. Test Limit

The minimum permissible channel separation for this system is  $2/3$  the value of the 20dB BW.

### 5.4.2. Test Procedure Used

ANSI C63.10-2013 - Section 7.8.2

### 5.4.3. Test Setting

1. Span = Wide enough to capture the peaks of two adjacent channels.
2. Start with the RBW set to approximately 30% of the channel spacing; adjust as necessary to best identify the center of each individual channel.
3. VBW  $\geq$  RBW
4. Sweep time = Auto couple
5. Detector = Peak
6. Trace mode = Max hold
7. Allowed the trace to stabilize
8. Use the marker-delta function to determine the separation between the peaks of the adjacent channels.

### 5.4.4. Test Setup

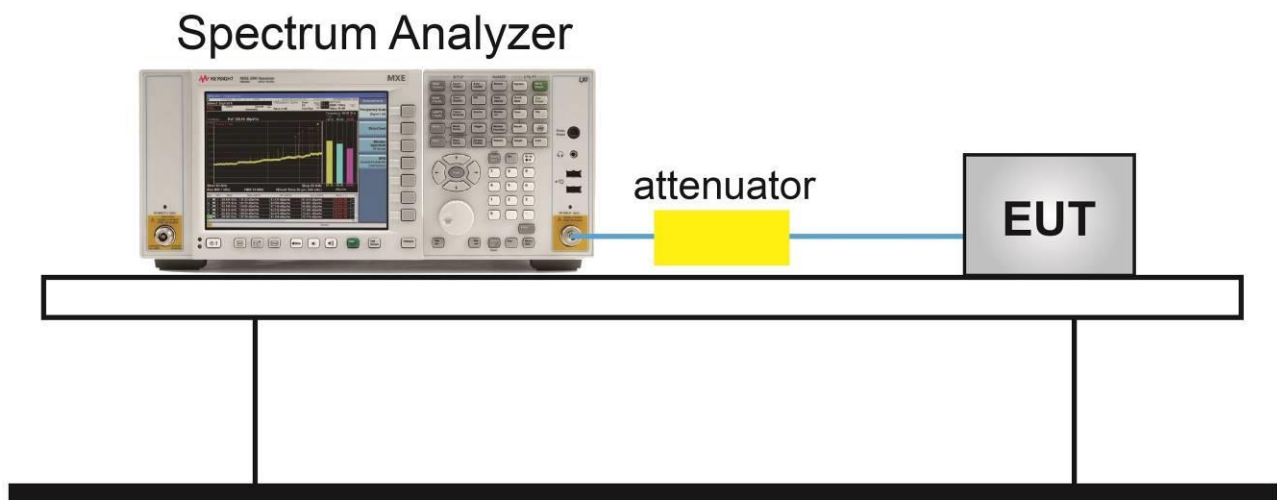

#### 5.4.5. Test Result

Test Site	SIP-TR1	Test Engineer	Alisa Deng
Test Date	2021/06/21		

Test Mode	Channel No.	Frequency (MHz)	Carrier Frequency Separation (kHz)	Limit (kHz)	Result
DH5	00	2402	1000	$\geq 616.7$	Pass
DH5	39	2441	1000	$\geq 617.9$	Pass
DH5	78	2480	1000	$\geq 614.9$	Pass
2DH5	00	2402	985	$\geq 877.3$	Pass
2DH5	39	2441	1000	$\geq 876.7$	Pass
2DH5	78	2480	1000	$\geq 877.3$	Pass
3DH5	00	2402	1000	$\geq 879.3$	Pass
3DH5	39	2441	1000	$\geq 861.3$	Pass
3DH5	78	2480	1000	$\geq 874.0$	Pass

Note: The Limit is 2/3 the value of the 20dB BW.

### DH5 Carrier Frequency Separation

Channel 00 (2402MHz)

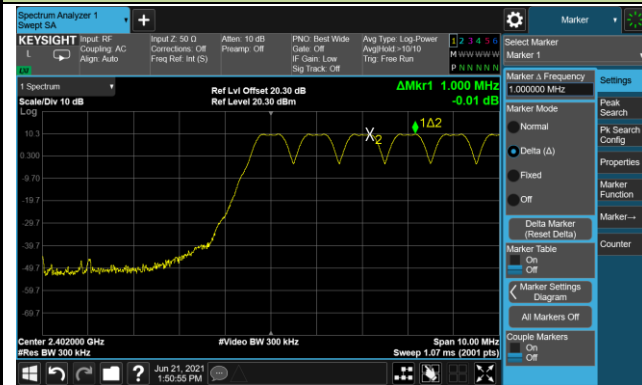

Channel 39 (2441MHz)

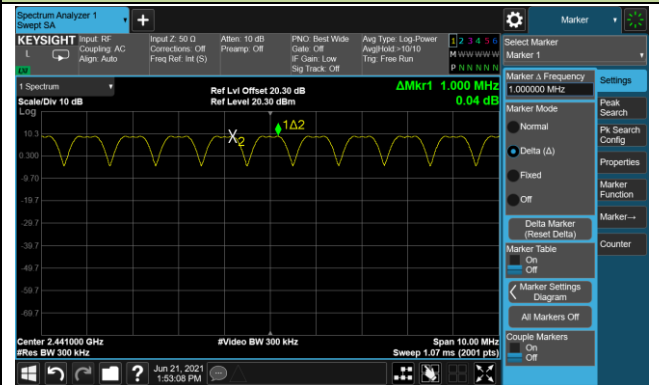

Channel 78 (2480MHz)

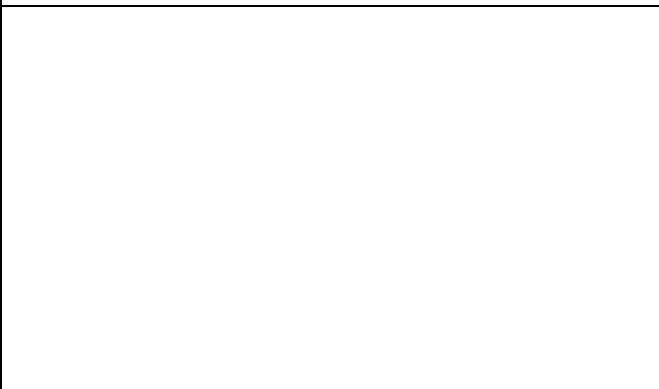

## 2DH5 Carrier Frequency Separation

### Channel 00 (2402MHz)

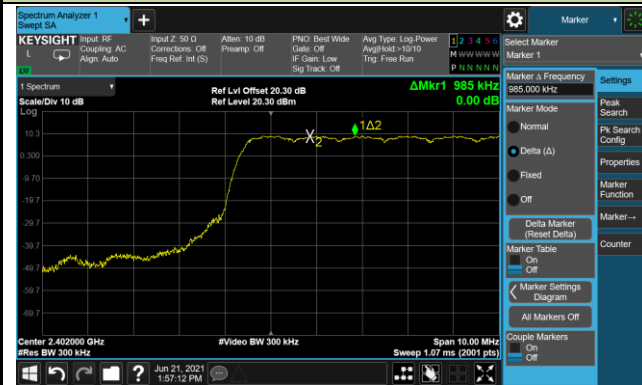

### Channel 39 (2441MHz)

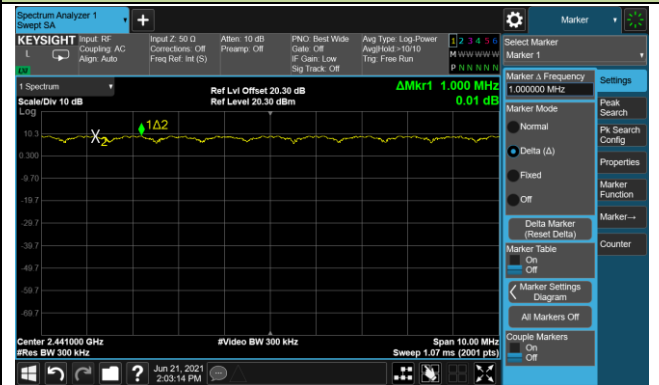

### Channel 78 (2480MHz)





### 3DH5 Carrier Frequency Separation

Channel 00 (2402MHz)

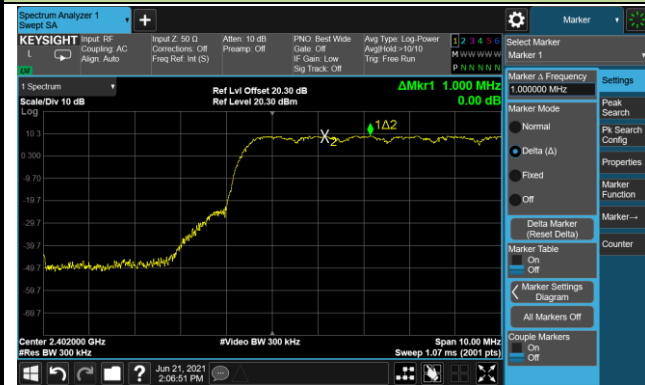

Channel 39 (2441MHz)

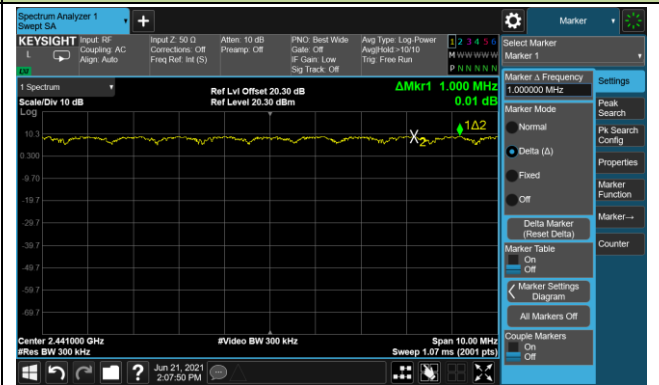

Channel 78 (2480MHz)



## 5.5. Number of Hopping Channels Measurement

### 5.5.1. Test Limit

This frequency hopping system must employ a minimum of 15 hopping channels.

### 5.5.2. Test Procedure Used

ANSI C63.10-2013 - Section 7.8.3

### 5.5.3. Test Setting

1. Span = The frequency band of operation. Depending on the number of channels the device supports, it may be necessary to divide the frequency range of operation across multiple spans, to allow the individual channels to be clearly seen.
2. RBW: To identify clearly the individual channels, set the RBW to less than 30% of the channel spacing or the 20 dB bandwidth, whichever is smaller.
3. VBW  $\geq$  RBW
4. Sweep time = Auto couple
5. Detector = Peak
6. Trace mode = Max hold
7. Allow the trace to stabilize

### 5.5.4. Test Setup

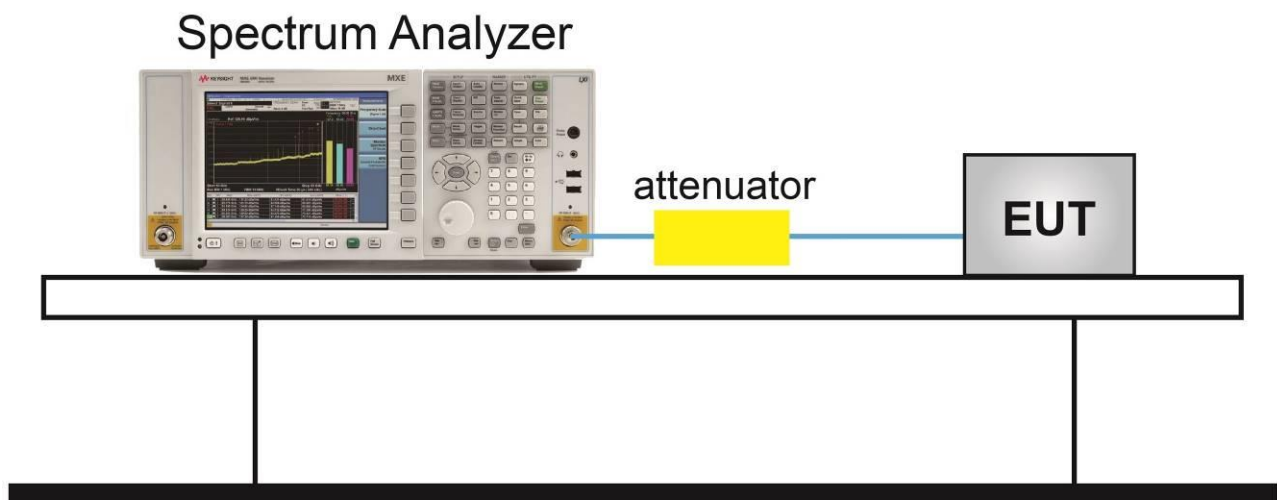

### 5.5.5. Test Result

Test Site	SIP-TR1	Test Engineer	Alisa Deng
Test Date	2021/06/21		

Test Mode (Hopping)	Channel Numbers	Frequency (MHz)	Limit (Hopping Channels)	Result
DH5	79	2402 ~ 2480	≥ 15	Pass
2DH5	79	2402 ~ 2480	≥ 15	Pass
3DH5	79	2402 ~ 2480	≥ 15	Pass

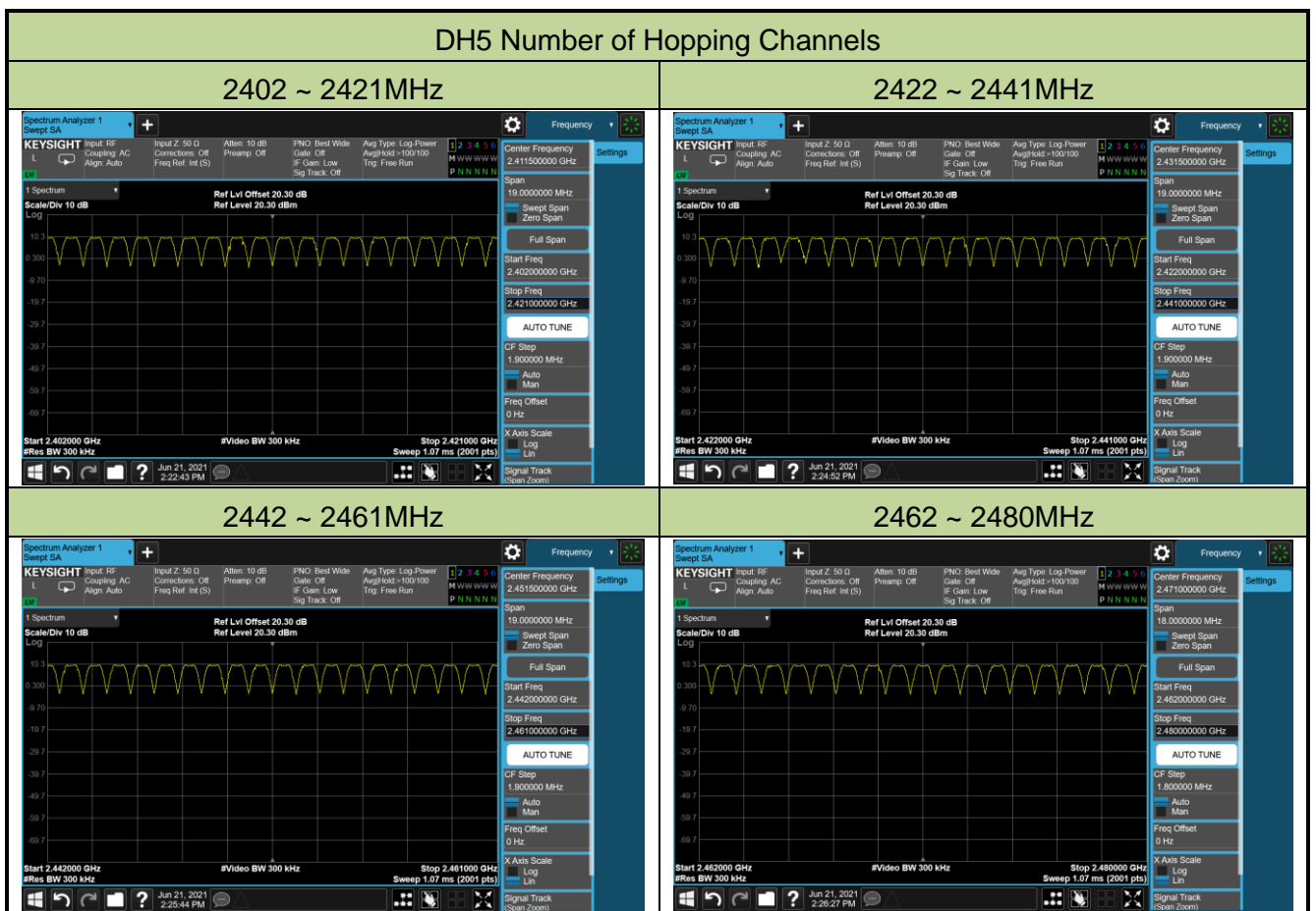

## 2DH5 Number of Hopping Channels

2402 ~ 2421MHz

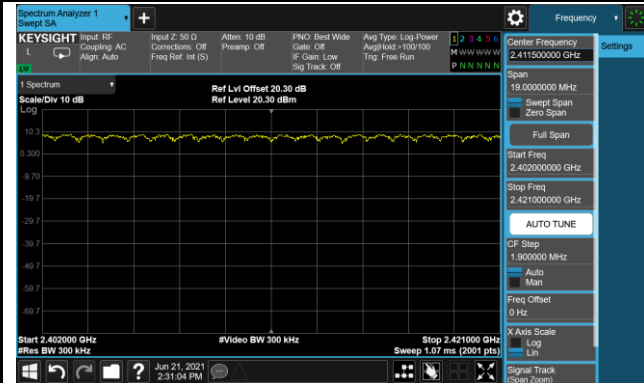

2422 ~ 2441MHz

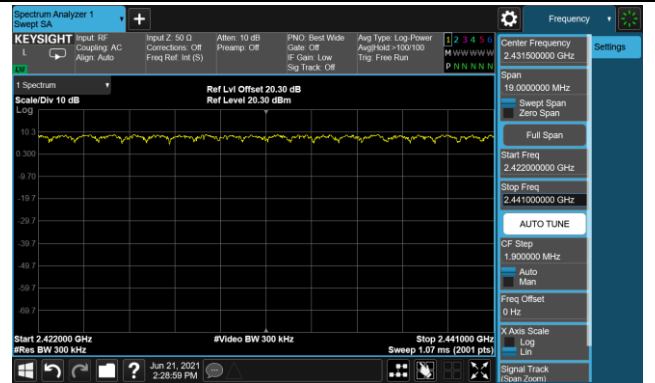

2442 ~ 2461MHz

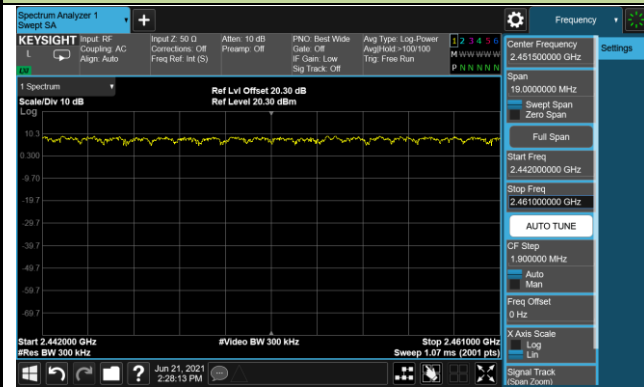

2462 ~ 2480MHz

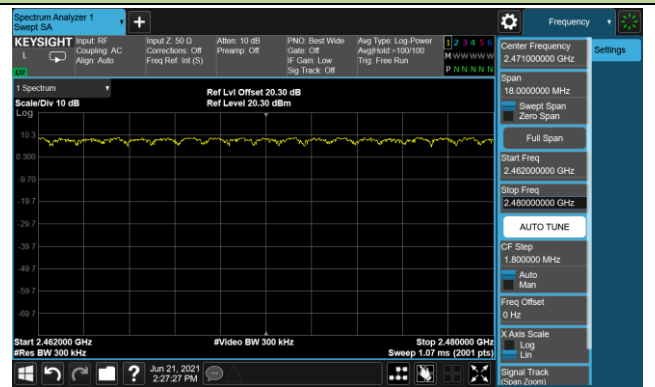

### 3DH5 Number of Hopping Channels

2402 ~ 2421MHz

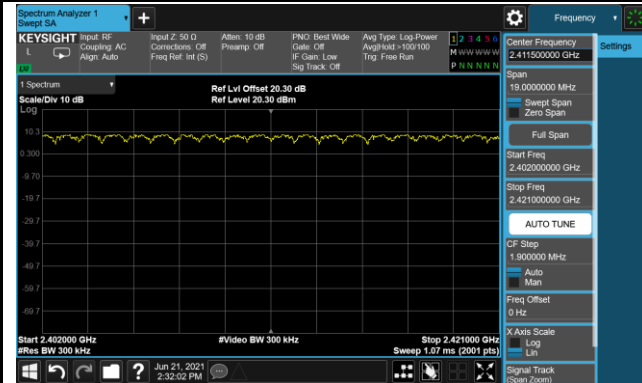

2422 ~ 2441MHz

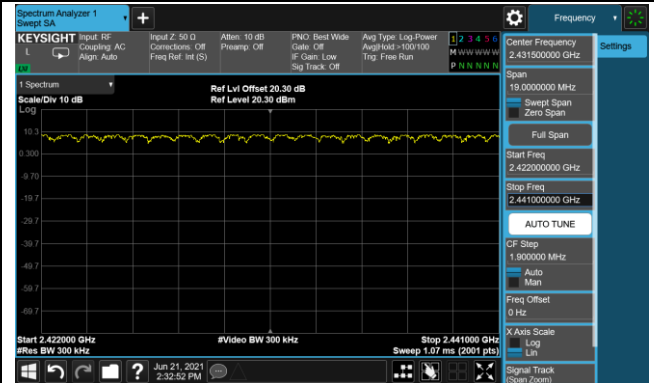

2442 ~ 2461MHz

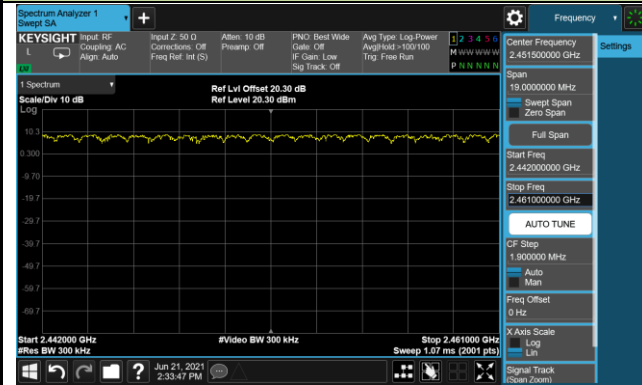

2462 ~ 2480MHz

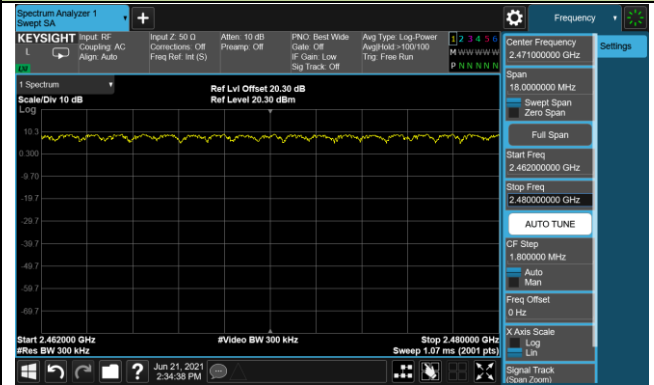

## **5.6. Time of Occupancy Measurement**

### **5.6.1. Test Limit**

The maximum permissible time of occupancy is 400ms within a period of 400ms multiplied by the number of hopping channels employed.

### **5.6.2. Test Procedure Used**

ANSI C63.10-2013 - Section 7.8.4

### **5.6.3. Test Setting**

1. Span = Zero span, centered on a hopping channel.
2. RBW shall be  $\leq$  channel spacing and where possible RBW should be set  $\gg 1 / T$ , where T is the expected dwell time per channel.
3. VBW  $\geq$  RBW
4. Sweep time = As necessary to capture the entire dwell time per hopping channel
5. Detector = Peak
6. Trace mode = Free run
7. Use the marker-delta function to determine the transmit time per hop. If this value varies with different modes of operation (data rate, modulation format, number of hopping channels, etc.), then repeat this test for each variation in transmit time. An oscilloscope may be used instead of a spectrum analyzer. The EUT shall show compliance with the appropriate regulatory limit for the number of hopping channels. A plot of the data shall be included in the test report.

### 5.6.4. Test Setup

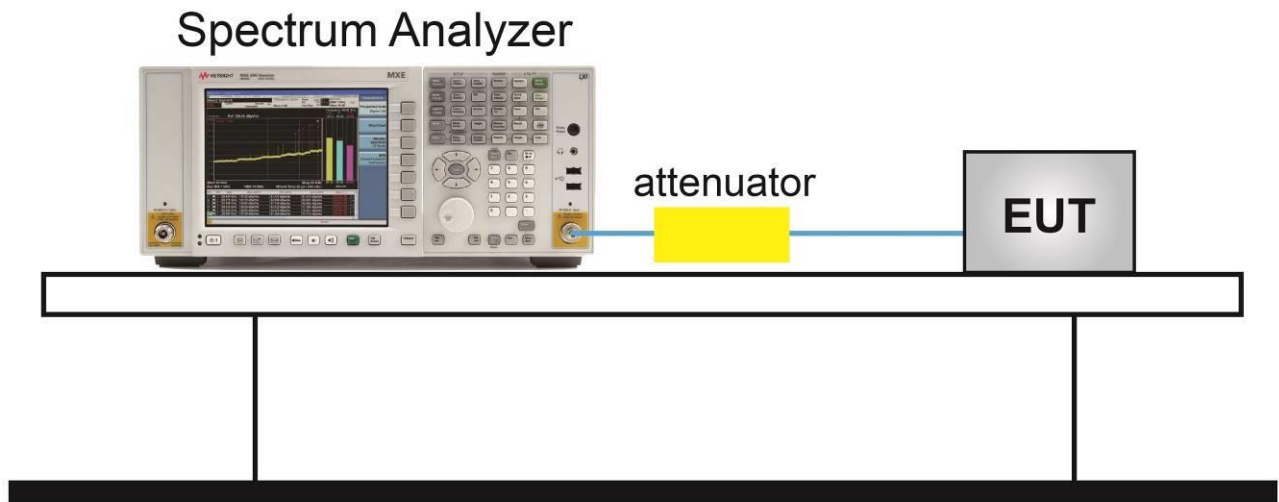

### 5.6.5. Test Result

Test Site	SIP-TR1	Test Engineer	Alisa Deng
Test Date	2021/06/21		

Test Mode	Channel No.	Frequency (MHz)	Transmit Time Per Hop (ms)	Observation Period (s)	Number of Hops in Sweep Time	Number of Hops in Observation Period	Time of Occupancy (ms)	Limit (ms)	Result
DH1	00~78	2402~2480	0.380	31.6	61	321	122.0	≤ 400	Pass
DH3	00~78	2402~2480	1.635	31.6	31	163	266.5	≤ 400	Pass
DH5	00~78	2402~2480	2.900	31.6	20	105	304.5	≤ 400	Pass

Note: Number of Hops in Observation Period = Number of Hops in Sweep Time \* (Observation Period / Sweep Time), Sweep Time = 6s.

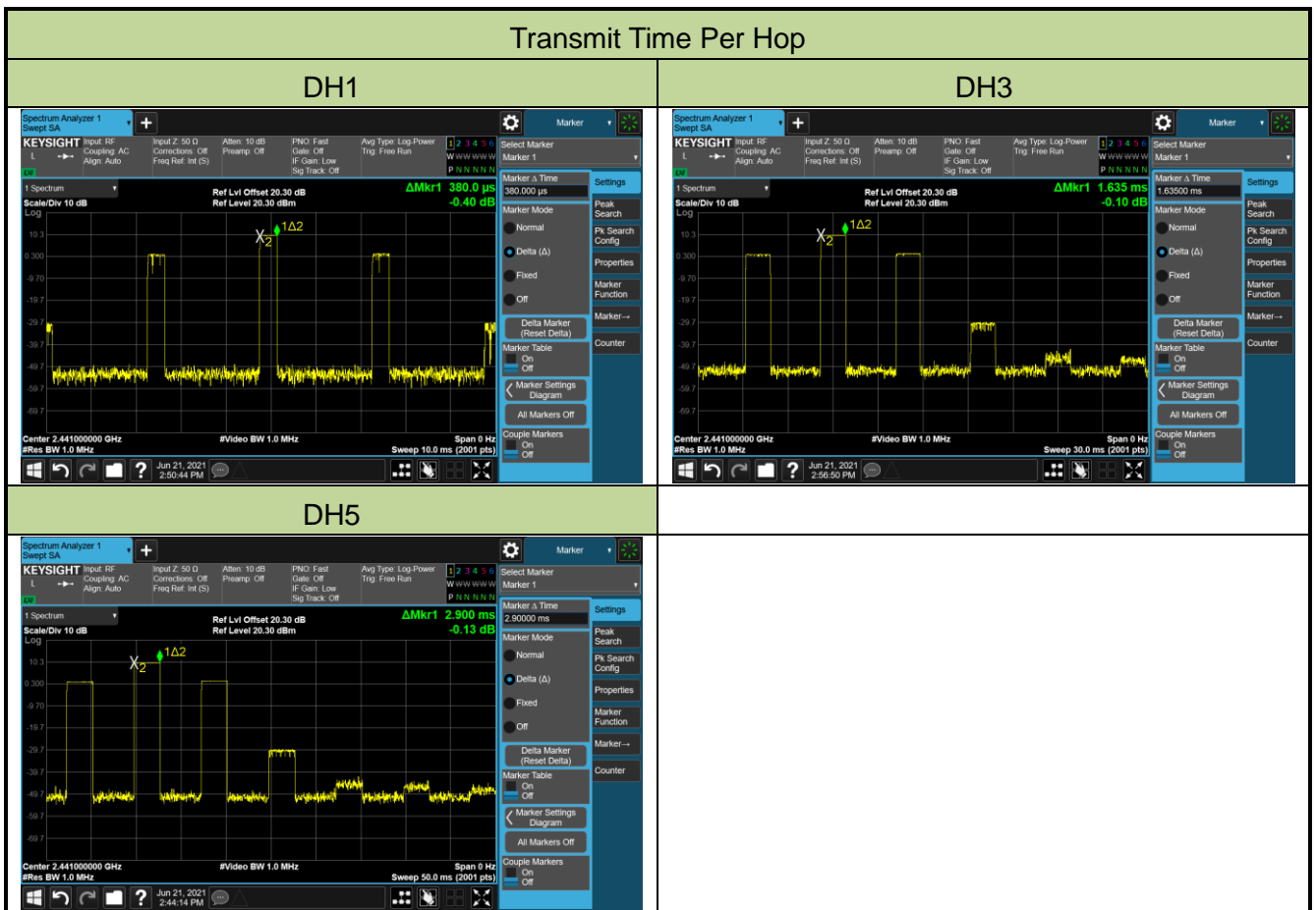



### Number of Hops in Sweep Time

DH1

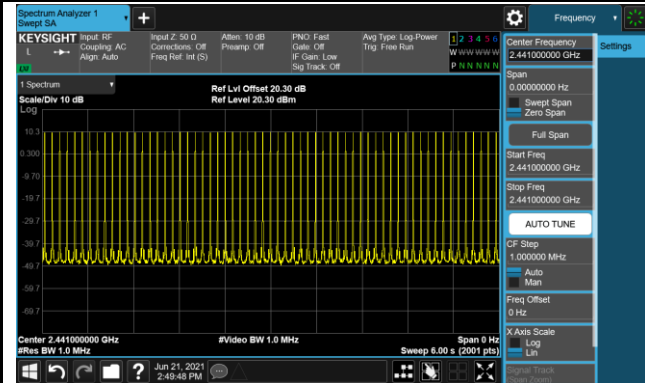

DH3



DH5

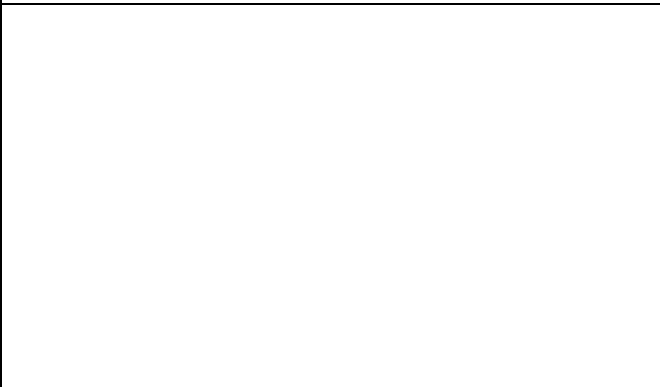

## **5.7. Band-edge Compliance Measurement**

### **5.7.1. Test Limit**

The maximum permissible emission level is 20dBc. Any emissions were lying outside of the emission bandwidth and in authorized band edges to a field strength limit specified in Section 15.209 of the Title 47 CFR.

### **5.7.2. Test Procedure Used**

ANSI C63.10-2013 - Section 6.10.4

### **5.7.3. Test Setting**

1. Span = Wide enough to capture the peak level of the emission operating on the channel closest to the band edge, as well as any modulation products which fall outside of the authorized band of operation.
2. RBW = 100kHz
3. VBW = 300kHz
4. Detector = Peak
5. Sweep time = Auto couple
6. Trace mode = Max hold
7. Allow the trace to stabilize. Set the marker on the emission at the band edge, or on the highest modulation product outside of the band, if this level is greater than that at the band edge. Enable the marker-delta function, then use the marker-to-peak function to move the marker to the peak of the in-band emission.

### 5.7.4. Test Setup

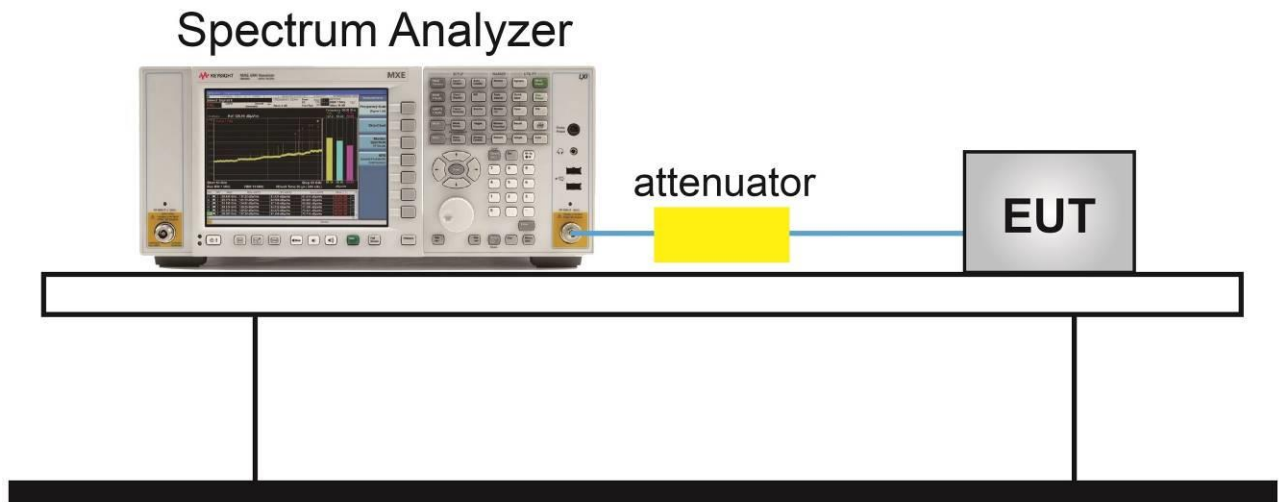

**5.7.5. Test Result**

Test Site	SIP-TR1	Test Engineer	Alisa Deng
Test Date	2021/06/21		

Test Mode	Channel No.	Frequency (MHz)	Limit	Result
DH5	00	2402	20dBc	Pass
DH5	78	2480	20dBc	Pass
2DH5	00	2402	20dBc	Pass
2DH5	78	2480	20dBc	Pass
3DH5	00	2402	20dBc	Pass
3DH5	78	2480	20dBc	Pass