



RADIO TEST REPORT

FCC ID : DC9WSOPMW
Equipment : Microwave Module
Brand Name : OPTEX
Model Name : WS-OPMW-WL X5
Applicant : Optex Co Ltd
5-8-12, Ogoto Otsu-Shi, Shiga-Ken, Japan 520-0101
Manufacturer : Optex Co Ltd
5-8-12, Ogoto Otsu-Shi, Shiga-Ken, Japan 520-0101
Standard : 47 CFR FCC Part 15.245

The product was received on Jan. 27, 2024, and testing was started from Jan. 27, 2024 and completed on Feb. 28, 2024. We, Sporton International Inc. Hsinchu Laboratory, would like to declare that the tested sample has been evaluated in accordance with the procedures given in ANSI C63.10-2013 and shown compliance with the applicable technical standards.

The test results in this variant report apply exclusively to the tested model / sample. Without written approval of Sporton International Inc. Hsinchu Laboratory, the test report shall not be reproduced except in full.

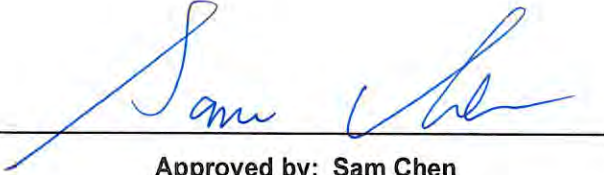

Approved by: Sam Chen

Sporton International Inc. Hsinchu Laboratory

No.8, Ln. 724, Bo'ai St., Zhubei City, Hsinchu County 302010, Taiwan (R.O.C.)



Table of Contents

History of this test report.....3

Summary of Test Result.....4

1 General Description5

1.1 Information.....5

1.2 Applicable Standards6

1.3 Testing Location Information6

1.4 Measurement Uncertainty6

2 Test Configuration of Equipment under Test.....7

2.1 Conformance Tests and Related Test Frequencies.....7

2.2 EUT Operation during Test8

2.3 Accessories8

2.4 Support Equipment.....8

2.5 EUT Setups9

3 Transmitter Test Result12

3.1 AC Power Conducted Emissions12

3.2 Field Strength of Fundamental17

3.3 Transmitter Spurious Emissions.....21

3.4 Antenna Requirements.....31

4 Test Equipment and Calibration Data32

Appendix A. Test Photos

Photographs of EUT v01



Summary of Test Result

Report Clause	Ref Std. Clause	Test Items	Result (PASS/FAIL)	Remark
3.1	15.207	AC Power Conducted Emissions	PASS	-
3.2	15.245(b)	Field Strength of Fundamental	PASS	-
3.3	15.245(b)	Transmitter Spurious Emissions	PASS	-
3.4	15.203	Antenna Requirements	PASS	-

Conformity Assessment Condition:

1. The test results (PASS/FAIL) with all measurement uncertainty excluded are presented against the regulation limits or in accordance with the requirements stipulated by the applicant/manufacturer who shall bear all the risks of non-compliance that may potentially occur if measurement uncertainty is taken into account.
2. The measurement uncertainty please refer to each test result in the chapter "Measurement Uncertainty".

Disclaimer:

The product specifications of the EUT presented in the test report that may affect the test assessments are declared by the manufacturer who shall take full responsibility for the authenticity.

Reviewed by: Sam Chen

Report Producer: Cathy Chiu



1 General Description

1.1 Information

1.1.1 RF General Information

RF General Information	
Frequency Range	10.5 - 10.55 GHz
Operation Frequency	10525 MHz
Channel Number	1
Modulation	CW
Antenna	Antenna Type: Printed Antenna (Without any antenna connector) Antenna Gain: 7.5dBi

Note: The above information was declared by manufacturer.

1.1.2 Field Strength of Fundamental

Field Strength of Fundamental							
Applicable power levels:	<input type="checkbox"/> Conducted <input type="checkbox"/> EIRP <input checked="" type="checkbox"/> Field Strength at 3m						
Frequency	Highest setting (P _{high}): (dBuV/m)						
	Power Setting	Modulation	Data Rate (Mb/s)	Average Level	Peak Level	Average Level Limit	Peak Level Limit
10525 MHz	N/A	CW	N/A	84.65	109.09	128	148

1.1.3 EUT Operational Condition

EUT Power Type	From host system
----------------	------------------

Note: The above information was declared by manufacturer.

1.1.4 Table for Permissive Change

This product is an extension of original one reported under Sporton project number: FR272029

Below is the table for the change of the product with respect to the original one.

Modifications	Performance Checking
Adding a host systems model names: IR-D-P2E	<ol style="list-style-type: none"> AC Power Conducted Emissions Field Strength of Fundamental Transmitter Spurious Emissions



1.2 Applicable Standards

According to the specifications of the manufacturer, the EUT must comply with the requirements of the following standards:

- ♦ ANSI C63.10-2013
- ♦ 47 CFR FCC Part 15.245

The following reference test guidance is not within the scope of accreditation of TAF.

- ♦ FCC KDB 414788 D01 v01r01

1.3 Testing Location Information

Testing Location Information	
Test Lab. : Sporton International Inc. Hsinchu Laboratory	
Hsinchu	ADD: No.8, Ln. 724, Bo'ai St., Zhubei City, Hsinchu County 302010, Taiwan (R.O.C.)
(TAF: 3787)	TEL: 886-3-656-9065 FAX: 886-3-656-9085
Test site Designation No. TW3787 with FCC.	
Conformity Assessment Body Identifier (CABID) TW3787 with ISED.	

Test Condition	Test Site No.	Test Engineer	Test Environment (°C / %)	Test Date
Radiated below 1GHz	03CH06-CB	Mark Xu	21.9-22.8 / 56-58	Feb. 28, 2024
Radiated above 1GHz	03CH05-CB	Jackson Peng	21-22 / 56-59	Jan. 27, 2024
AC Conduction	CO01-CB	Peter Wu	22~23 / 61~62	Feb. 08, 2024

1.4 Measurement Uncertainty

Test Items	Uncertainty	Remark
Conducted Emission (150kHz ~ 30MHz)	3.4 dB	Confidence levels of 95%
Radiated Emission (9kHz ~ 30MHz)	3.7 dB	Confidence levels of 95%
Radiated Emission (30MHz ~ 1,000MHz)	5.1 dB	Confidence levels of 95%
Radiated Emission (1GHz ~ 18GHz)	4.1 dB	Confidence levels of 95%
Radiated Emission (18GHz ~ 40GHz)	4.2 dB	Confidence levels of 95%



2 Test Configuration of Equipment under Test

2.1 Conformance Tests and Related Test Frequencies

Test	Test Frequencies	Mode
AC Power Conducted Emissions Test Voltage: 120Vac / 60Hz	10525 MHz	Normal Link
Field Strength of Fundamental	10525 MHz	CTX
Transmitter Spurious Emissions Below 1GHz	10525 MHz	Normal Link
Transmitter Spurious Emissions 1GHz~40GHz	10525 MHz	CTX

Note: **For Conducted Emission test:**

Mode 1. Normal link – EUT

For Radiated Emission below 1GHz test:

After evaluating, the worst case was found at Y axis. So the measurement will follow this same test configuration.

Mode 1. Normal link – EUT in Y axis

For Radiated Emission above 1GHz test:

After evaluating, the worst case was found at Y axis. So the measurement will follow this same test configuration.

Mode 1. CTX – EUT in Y axis



2.2 EUT Operation during Test

For CTX Mode:

The EUT was programmed to be in continuously transmitting mode.

For Normal Link:

During the test, the EUT operation to normal function.

2.3 Accessories

N/A

2.4 Support Equipment

Support Equipment				
No.	Equipment	Brand Name	Model Name	FCC ID
A	Power Supply	MOTECH	LPS-305	N/A

2.5 EUT Setups

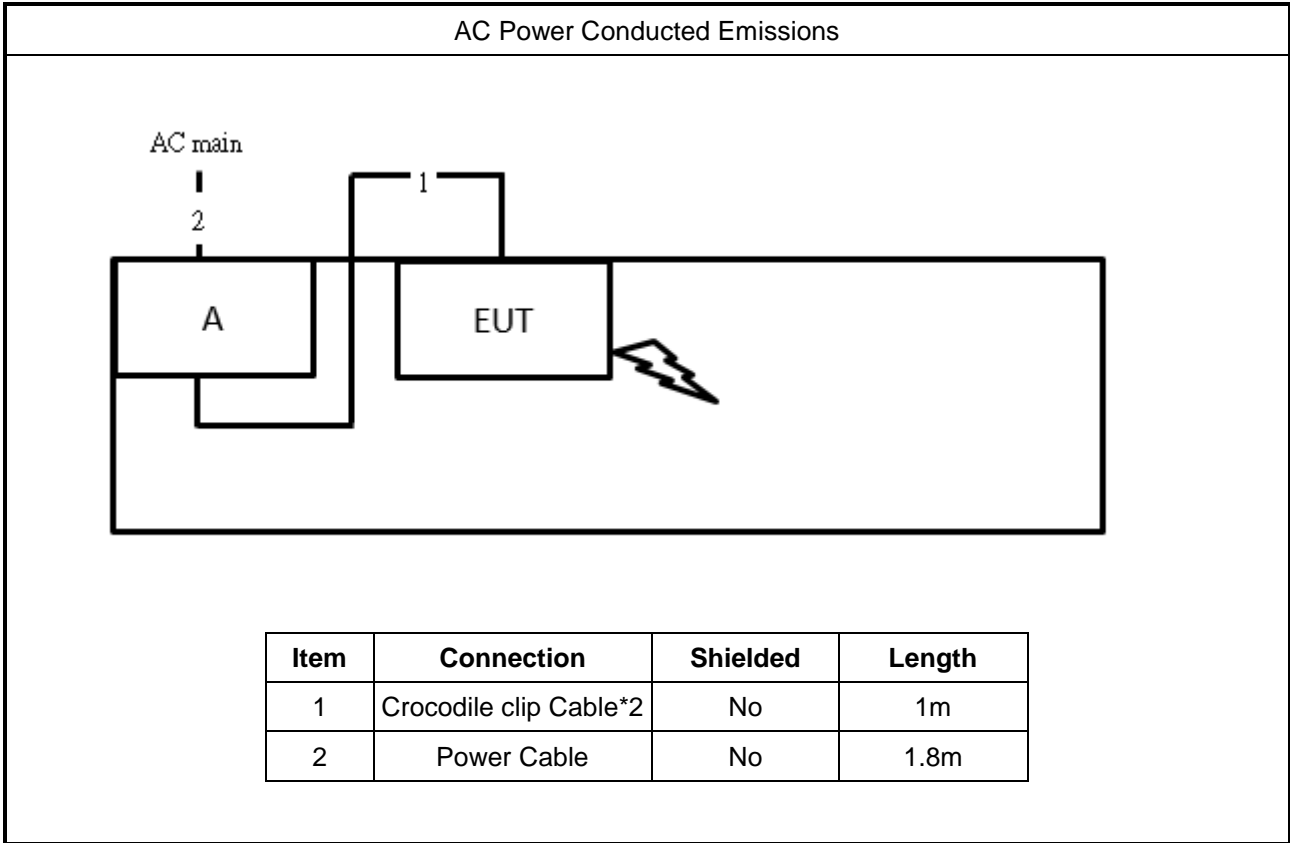

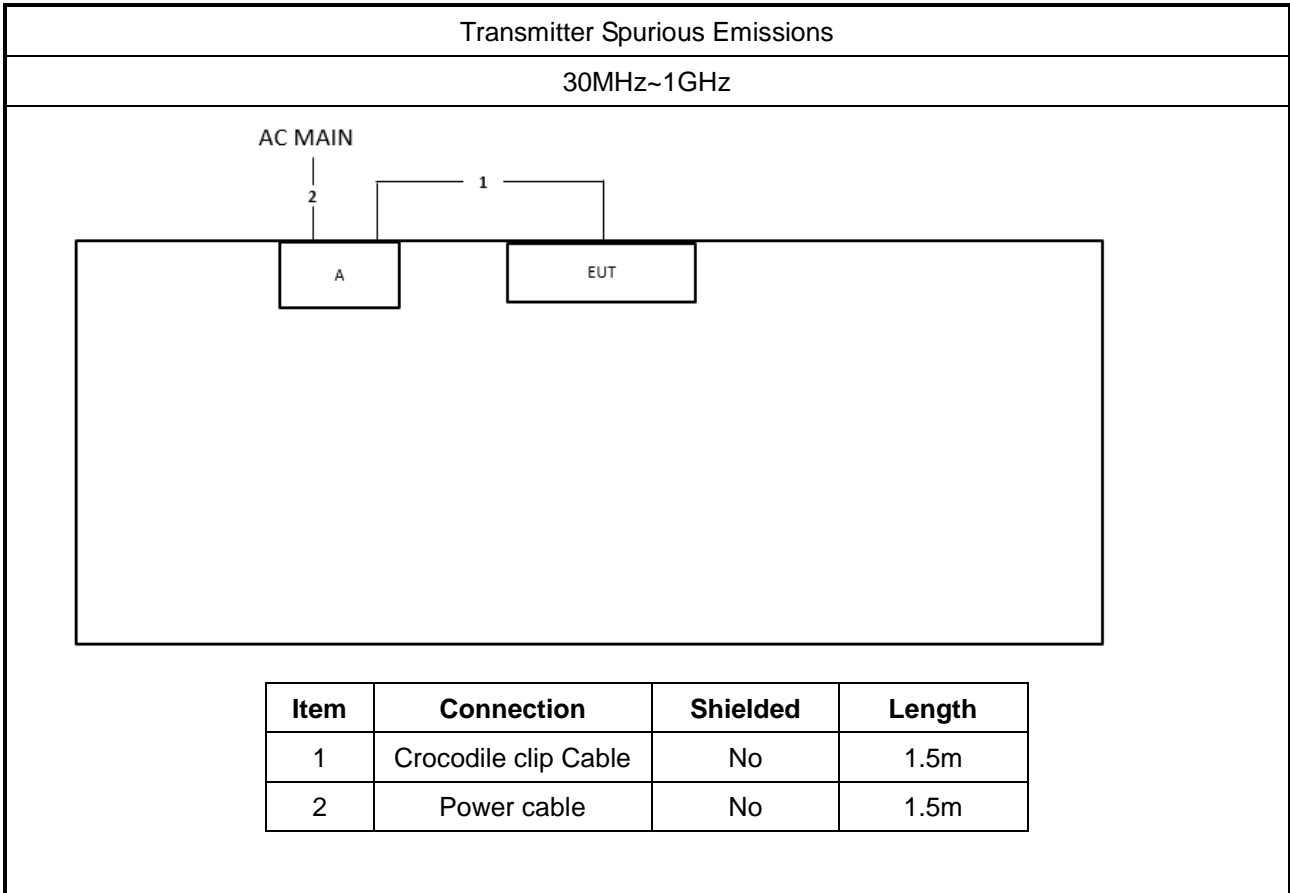

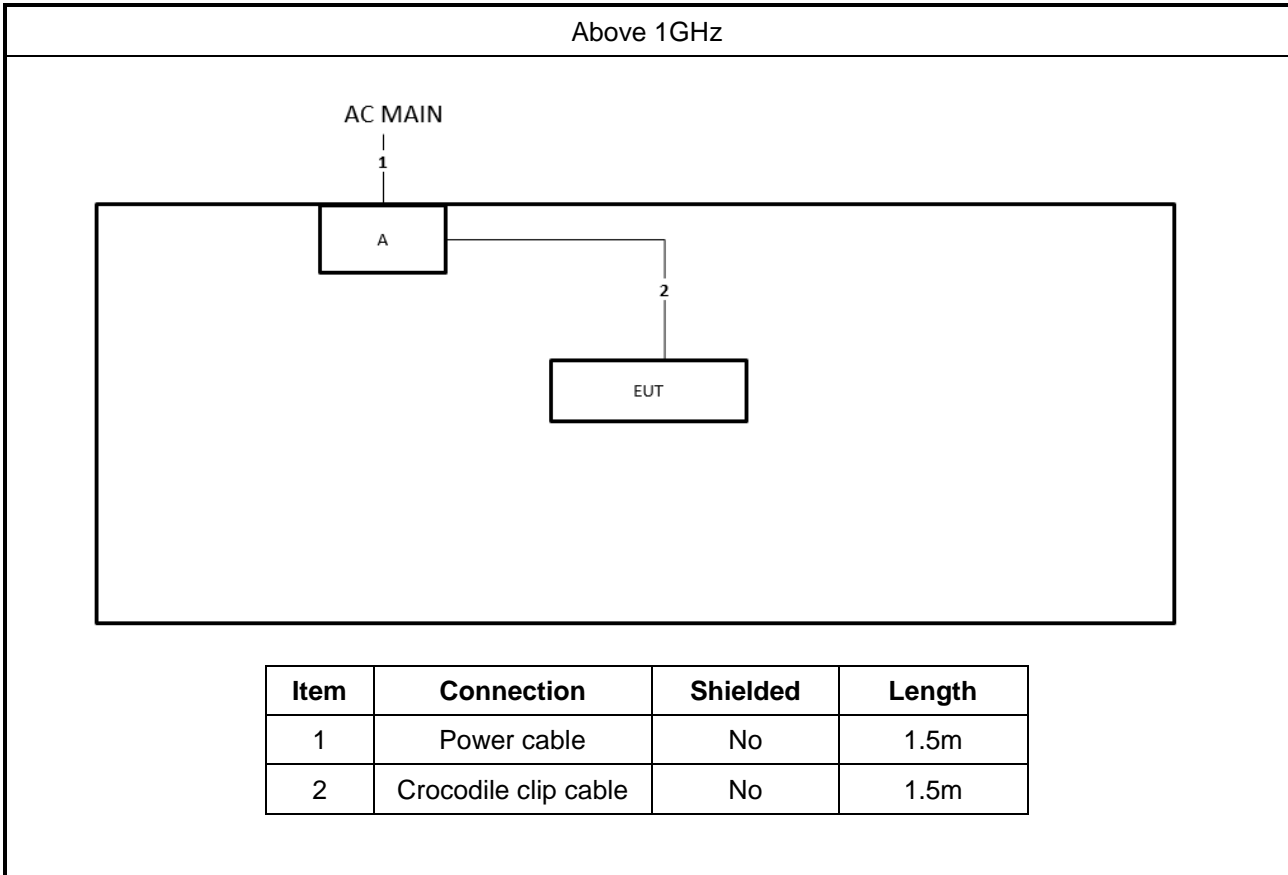



3 Transmitter Test Result

3.1 AC Power Conducted Emissions

3.1.1 Limit of AC Power Conducted Emissions

AC Power Conducted Emissions Limit		
Frequency Emission (MHz)	Quasi-Peak	Average
0.15-0.5	66 - 56 *	56 - 46 *
0.5-5	56	46
5-30	60	50

Note: * Decreases with the logarithm of the frequency.

3.1.2 Measuring Instruments

Refer a measuring instruments list in this test report.

3.1.3 Test Procedures

Method of measurement: Refer as ANSI C63.10-2013, clause 6.2.

3.1.4 Test Setup

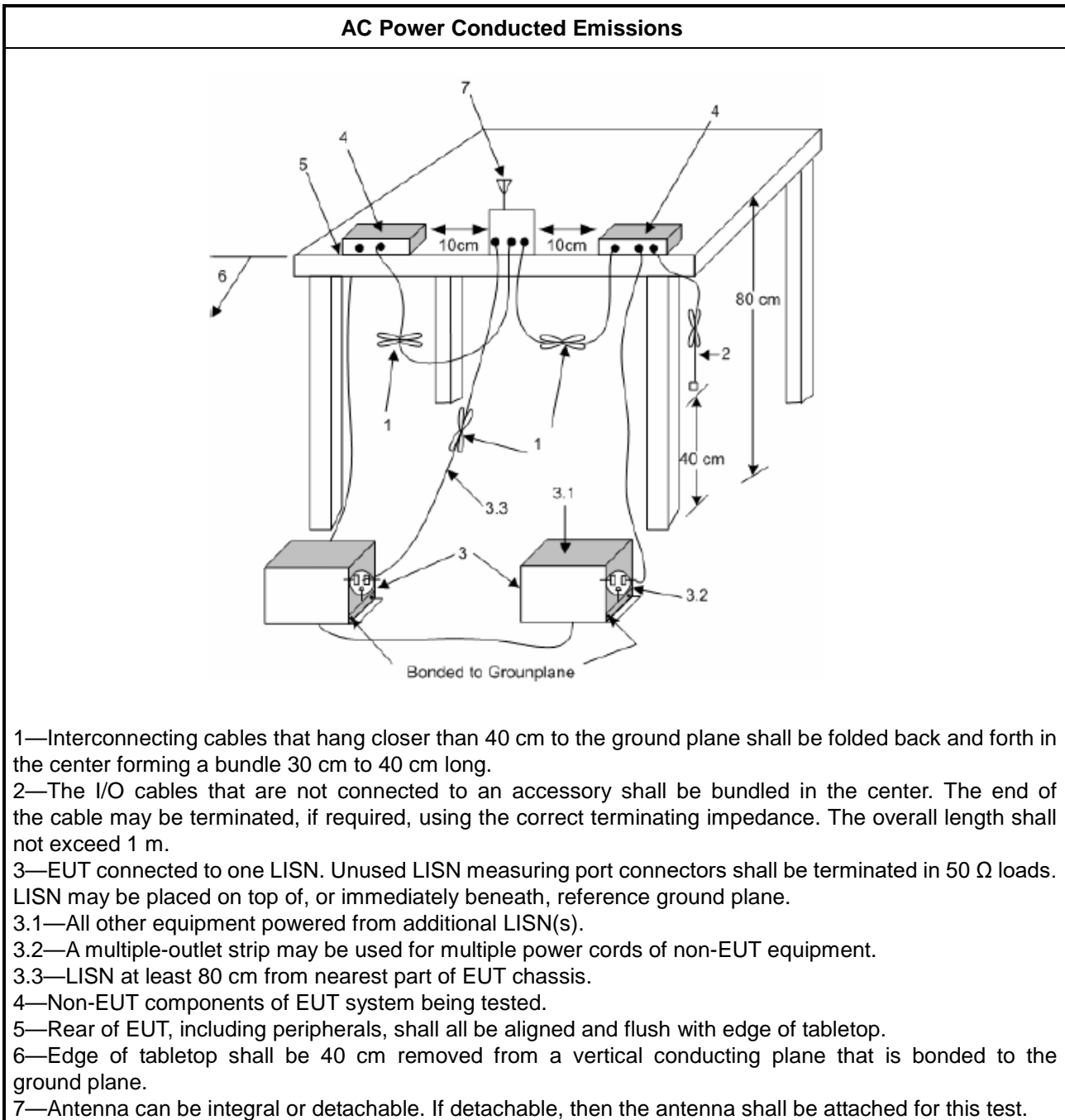

3.1.5 Measurement Results Calculation

The measured Level is calculated using:

- a. Corrected Reading: LISN Factor (LISN) + Attenuator (AT/AUX) + Cable Loss (CL) + Read Level (Raw) = Level
- b. Margin = -Limit + Level



3.1.6 Test Result of AC Power Conducted Emissions

Test Conditions:	see ANSI C63.10, clause 5.11
Test Setup:	see ANSI C63.10, clause 6.2.3
<p>Note 1: If equipment having different channel plan and nominal channel bandwidth modes, the measurements are uninfluenced by different channel plan and nominal channel bandwidth modes, may not need to be repeated for all modes. If equipment having different transmit operating modes, the measurements are uninfluenced by different transmit operating modes, may not need to be repeated for all the operating modes. Similar, if the equipment supports different modulations and/or data rates, the measurements described in ANSI C63.10, clause 5.12 may not need to be repeated for all these modulations and data rates. Simple comparison of engineering test across all operating modes, modulations and data rates may need to be performed to define the worse case combination to be used for the conformance testing.</p> <p>Note 2: “>20dB” means the tables in this clause should only list values of spurious emissions that exceed the level of 20 dB below the applicable limit, see ANSI C63.4, clause 10.1.8.1.</p>	



Phase	Line	Configuration	Normal Link
Test Mode	Mode1		

Mode 1

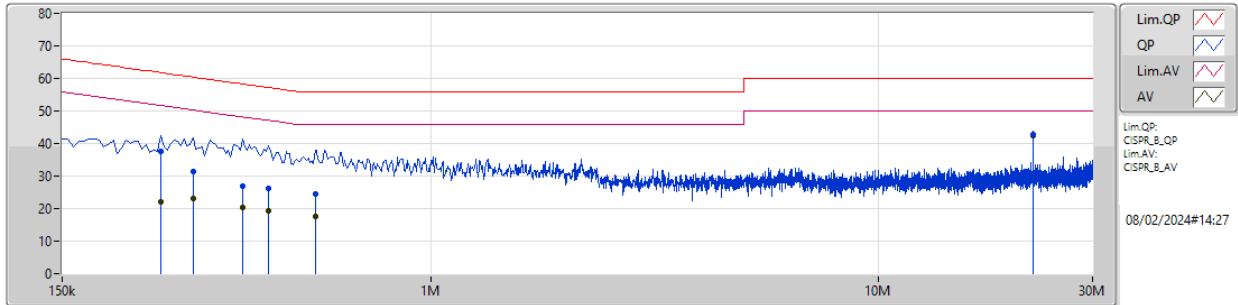

--	--	--	--	--	--	--	--	--	--	--	--

Type	Freq (Hz)	Level (dBuV)	Limit (dBuV)	Margin (dB)	Factor (dB)	Condition	Comment	Raw (dBuV)	LISN (dB)	CL (dB)	AT (dB)
QP	249k	37.66	61.79	-24.13	9.96	Line	-	27.70	0.08	0.02	9.86
AV	249k	22.01	51.79	-29.78	9.96	Line	-	12.05	0.08	0.02	9.86
QP	294k	31.38	60.42	-29.04	9.98	Line	-	21.40	0.09	0.02	9.87
AV	294k	22.98	50.42	-27.44	9.98	Line	-	13.00	0.09	0.02	9.87
QP	379.5k	26.99	58.29	-31.30	10.00	Line	-	16.99	0.09	0.02	9.89
AV	379.5k	20.30	48.29	-27.99	10.00	Line	-	10.30	0.09	0.02	9.89
QP	433.5k	26.06	57.19	-31.13	10.00	Line	-	16.06	0.09	0.02	9.89
AV	433.5k	19.32	47.19	-27.87	10.00	Line	-	9.32	0.09	0.02	9.89
QP	550.5k	24.54	56.00	-31.46	10.02	Line	-	14.52	0.10	0.02	9.90
AV	550.5k	17.63	46.00	-28.37	10.02	Line	-	7.61	0.10	0.02	9.90
QP	22.119M	42.70	60.00	-17.30	10.57	Line	-	32.13	0.31	0.23	10.03
AV	22.119M	42.51	50.00	-7.49	10.57	Line	"Worst"	31.94	0.31	0.23	10.03



Phase	Neutral	Configuration	Normal Link
Test Mode	Mode1		

Mode 1

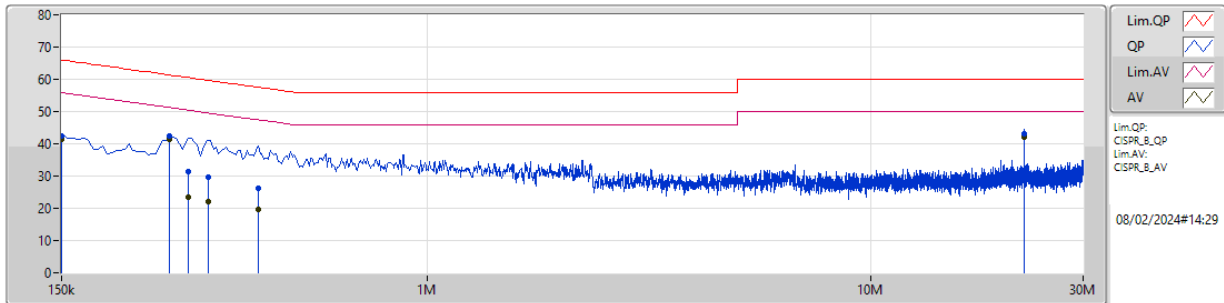

--	--	--	--	--	--	--	--	--	--	--	--

Type	Freq (Hz)	Level (dBuV)	Limit (dBuV)	Margin (dB)	Factor (dB)	Condition	Comment	Raw (dBuV)	LISN (dB)	CL (dB)	AT (dB)
QP	150k	42.54	66.00	-23.46	9.96	Neutral	-	32.58	0.07	0.02	9.87
AV	150k	41.54	56.00	-14.46	9.96	Neutral	-	31.58	0.07	0.02	9.87
QP	262.5k	42.54	61.35	-18.81	9.96	Neutral	-	32.58	0.07	0.02	9.87
AV	262.5k	41.54	51.35	-9.81	9.96	Neutral	-	31.58	0.07	0.02	9.87
QP	289.5k	31.53	60.53	-29.00	9.96	Neutral	-	21.57	0.07	0.02	9.87
AV	289.5k	23.58	50.53	-26.95	9.96	Neutral	-	13.62	0.07	0.02	9.87
QP	321k	29.81	59.67	-29.86	9.97	Neutral	-	19.84	0.07	0.02	9.88
AV	321k	21.92	49.67	-27.75	9.97	Neutral	-	11.95	0.07	0.02	9.88
QP	415.5k	26.30	57.53	-31.23	9.98	Neutral	-	16.32	0.07	0.02	9.89
AV	415.5k	19.52	47.53	-28.01	9.98	Neutral	-	9.54	0.07	0.02	9.89
QP	22.119M	43.18	60.00	-16.82	10.57	Neutral	-	32.61	0.31	0.23	10.03
AV	22.119M	42.16	50.00	-7.84	10.57	Neutral	"Worst"	31.59	0.31	0.23	10.03



3.2 Field Strength of Fundamental

3.2.1 Limit of Field Strength of Fundamental

Frequencies (MHz)	Field Strength (mV/meter)	Field Strength (dBuV/m) at 3m
902~928 MHz	500 at 3m	114 (Average)
902~928 MHz	5000 at 3m	134 (Peak)
2435~2465MHz	500 at 3m	114 (Average)
2435~2465MHz	5000 at 3m	134 (Peak)
5785~5815 MHz	500 at 3m	114 (Average)
5785~5815 MHz	5000 at 3m	134 (Peak)
10.5~10.55 GHz	2500 at 3m	128 (Average)
10.5~10.55 GHz	25000 at 3m	148 (Peak)
24.075~24.175 GHz	2500 at 3m	128 (Average)
24.075~24.175 GHz	25000 at 3m	148 (Peak)

Note1: For the applicable limit, see 15.245(b)
 Note2: The limit shall be extrapolated to the specified distance using an extrapolation factor of 20 dB/decade from 3m to 1m.
 Distance extrapolation factor = $20 \log(\text{specific distance [3m]} / \text{test distance [1m]})$ (dB);
 Limit line = specific limits (dBuV) + distance extrapolation factor [9.54 dB].

3.2.2 Measuring Instruments

Refer a measuring instruments list in this test report.

3.2.3 Test Procedures

Method of measurement: Refer as ANSI C63.10-2013, clause 6.6.

3.2.4 Test Setup

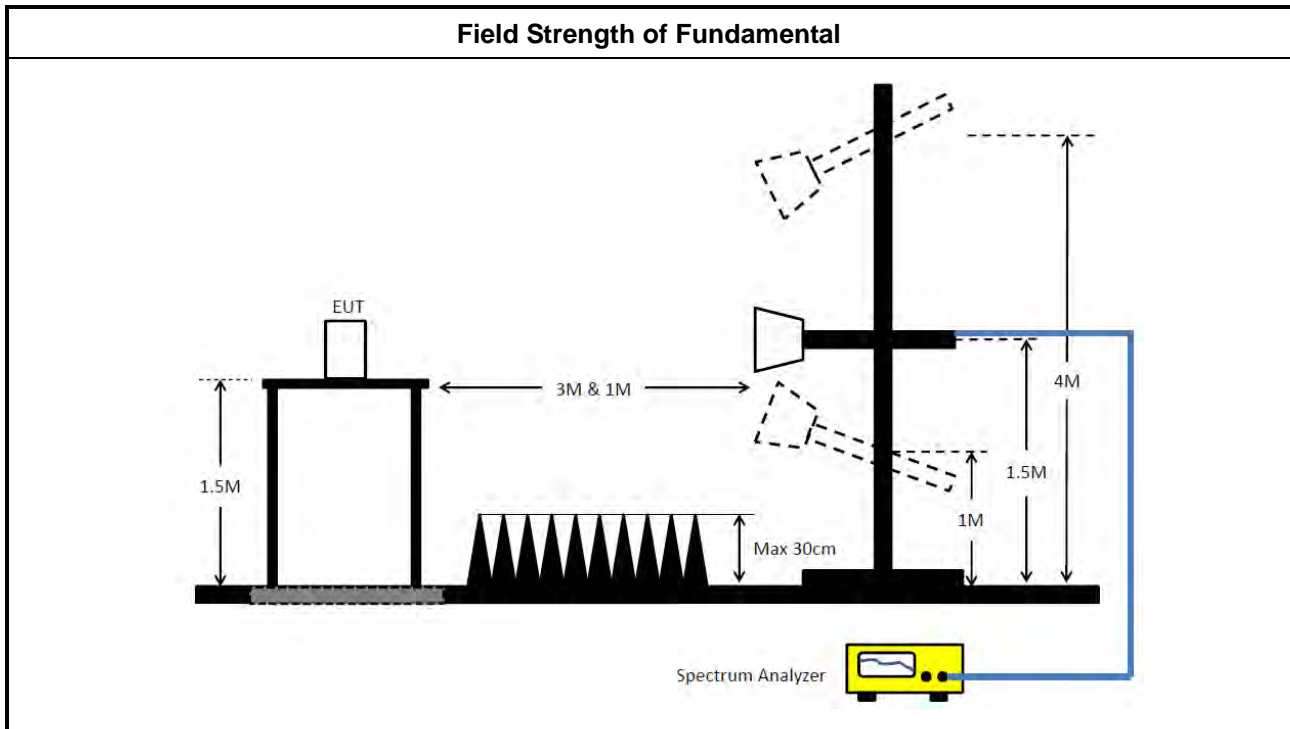

3.2.5 Measurement Results Calculation

The measured Level is calculated using:

Corrected Reading: Antenna factor (AF) + Cable loss (CL) + Read level (Raw) - Preamp factor (PA)(if applicable) = Level.

3.2.6 Test Result of Field Strength of Fundamental

Test Conditions:	see ANSI C63.10, clause 5.11
Test Setup:	see ANSI C63.10, clause 6.6
<p>Note1: If the equipment supports different modulations and/or data rates, the measurements described in ANSI C63.10, clause 5.12 may not need to be repeated for all these modulations and data rates. Simple comparison of engineering test across all operating modes, modulations and data rates may need to be performed to define the worse case combination to be used for the conformance testing.</p> <p>Note2: Conformance tests have to be performed over the frequency range(s) that has been declared with this Field Strength of Fundamental and using the antenna gain of the antenna with the highest gain among those that have been declared with this Field Strength of Fundamental. For smart antenna systems, the antenna beam forming gain may have to be taken into account as well.</p>	



3.2.7 Test Result of Field Strength of Fundamental

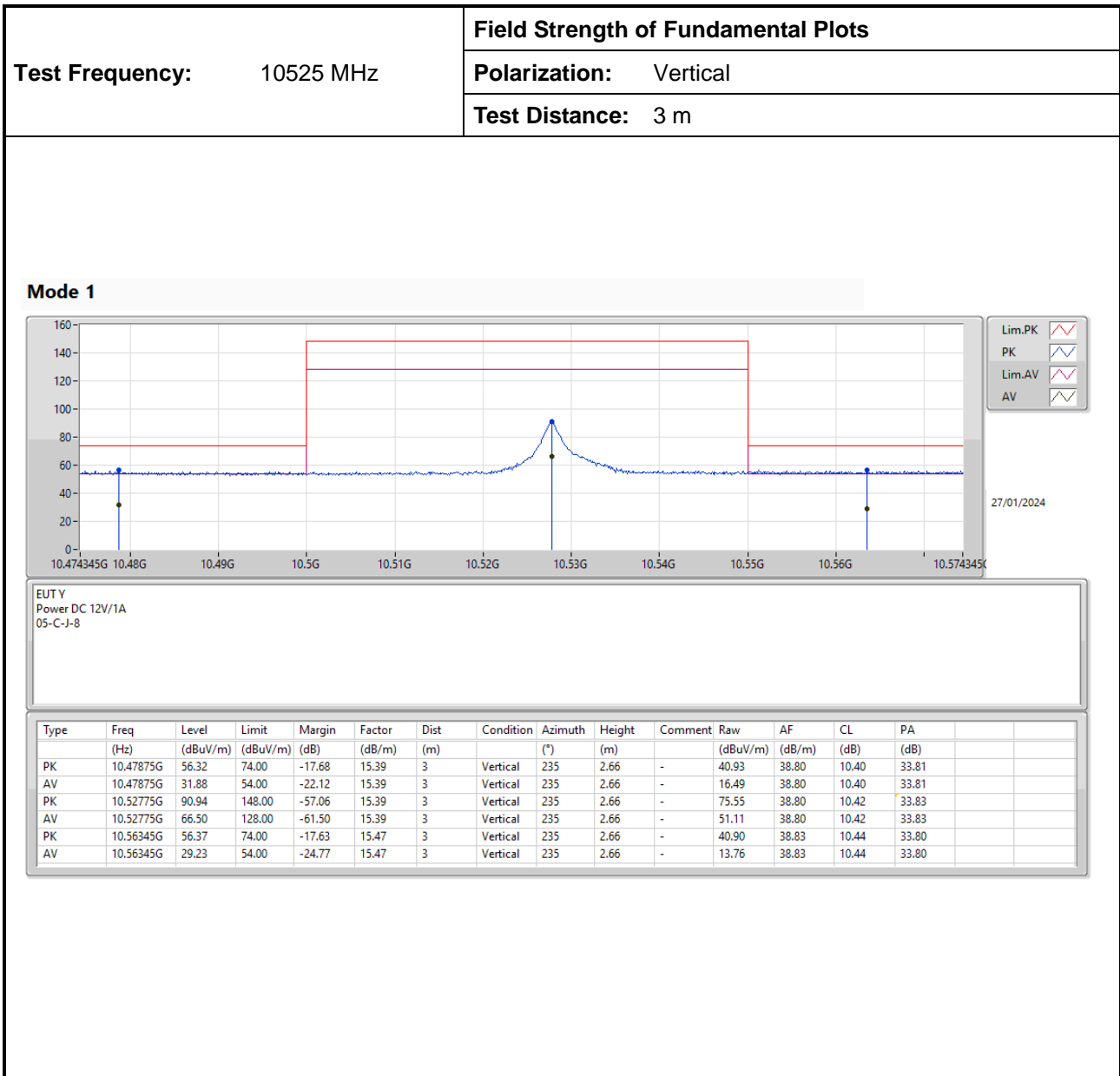



Test Frequency: 10525 MHz	Field Strength of Fundamental Plots
	Polarization: Horizontal
	Test Distance: 3 m

Mode 1

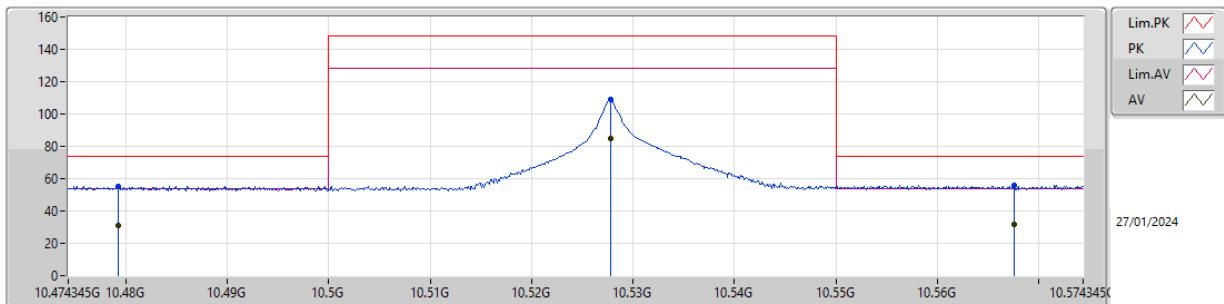

EUTY
Power DC 12V/1A
05-C-J-8

Type	Freq (Hz)	Level (dBuV/m)	Limit (dBuV/m)	Margin (dB)	Factor (dB/m)	Dist (m)	Condition	Azimuth (°)	Height (m)	Comment	Raw (dBuV/m)	AF (dB/m)	CL (dB)	PA (dB)
PK	10.47925G	55.47	74.00	-18.53	15.39	3	Horizontal	27	1.94	-	40.08	38.80	10.40	33.81
AV	10.47925G	31.03	54.00	-22.97	15.39	3	Horizontal	27	1.94	-	15.64	38.80	10.40	33.81
PK	10.52775G	109.09	148.00	-38.91	15.39	3	Horizontal	27	1.94	-	93.70	38.80	10.42	33.83
AV	10.52775G	84.65	128.00	-43.35	15.39	3	Horizontal	27	1.94	-	69.26	38.80	10.42	33.83
PK	10.56755G	55.94	74.00	-18.06	15.48	3	Horizontal	27	1.94	-	40.46	38.84	10.44	33.80
AV	10.56755G	31.50	54.00	-22.50	15.48	3	Horizontal	27	1.94	-	16.02	38.84	10.44	33.80



3.3 Transmitter Spurious Emissions

3.3.1 Limit of Transmitter Spurious Emissions

Transmitter Spurious Emissions	
1.	902 - 928MHz, Field disturbance sensors
	<ul style="list-style-type: none"> ♦ Harmonic emissions in the restricted bands: 15.209 limit ♦ Harmonic emissions in the non-restricted bands: 1.6mV/m ♦ Except harmonic emissions, spurious emissions: FCC 15.209 limit or 50 dB below the fundamental, whichever is the lesser attenuation.
2.	2435 - 2465MHz, 5785 - 5815MHz, Field disturbance sensors
	<ul style="list-style-type: none"> ♦ Harmonic emissions in the restricted bands at and below 17.7 GHz: 15.209 limit ♦ Harmonic emissions in the restricted bands at and above 17.7 GHz: 7.5mV/m ♦ Harmonic emissions in the non-restricted bands: 1.6mV/m ♦ Except harmonic emissions, spurious emissions: FCC 15.209 limit or 50 dB below the fundamental, whichever is the lesser attenuation.
3.	10500 – 10550MHz, Field disturbance sensors
	<ul style="list-style-type: none"> ♦ Harmonic emissions in the restricted bands at and above 17.7 GHz: 7.5mV/m ♦ Harmonic emissions in the non-restricted bands: 25mV/m ♦ Except harmonic emissions, spurious emissions: FCC 15.209 limit or 50 dB below the fundamental, whichever is the lesser attenuation.
4.	24075-24175 MHz, Field disturbance sensors
	<ul style="list-style-type: none"> ♦ Second and third harmonics: 25 mV/m ♦ Except harmonic emissions, spurious emissions: FCC 15.209 limit or 50 dB below the fundamental, whichever is the lesser attenuation.

Note: The limit shall be extrapolated to the specified distance using an extrapolation factor of 20 dB/decade from 3m to 1m.

Distance extrapolation factor = 20 log (specific distance [3m] / test distance [1m]) (dB);

Limit line = specific limits (dBuV) + distance extrapolation factor [9.54 dB].

3.3.2 Measuring Instruments

Refer a measuring instruments list in this test report.

3.3.3 Test Procedures

Method of measurement: Refer as ANSI C63.10-2013, clauses 6.3, 6.4, 6.5, 6.6 and 9.12.

3.3.4 Test Setup

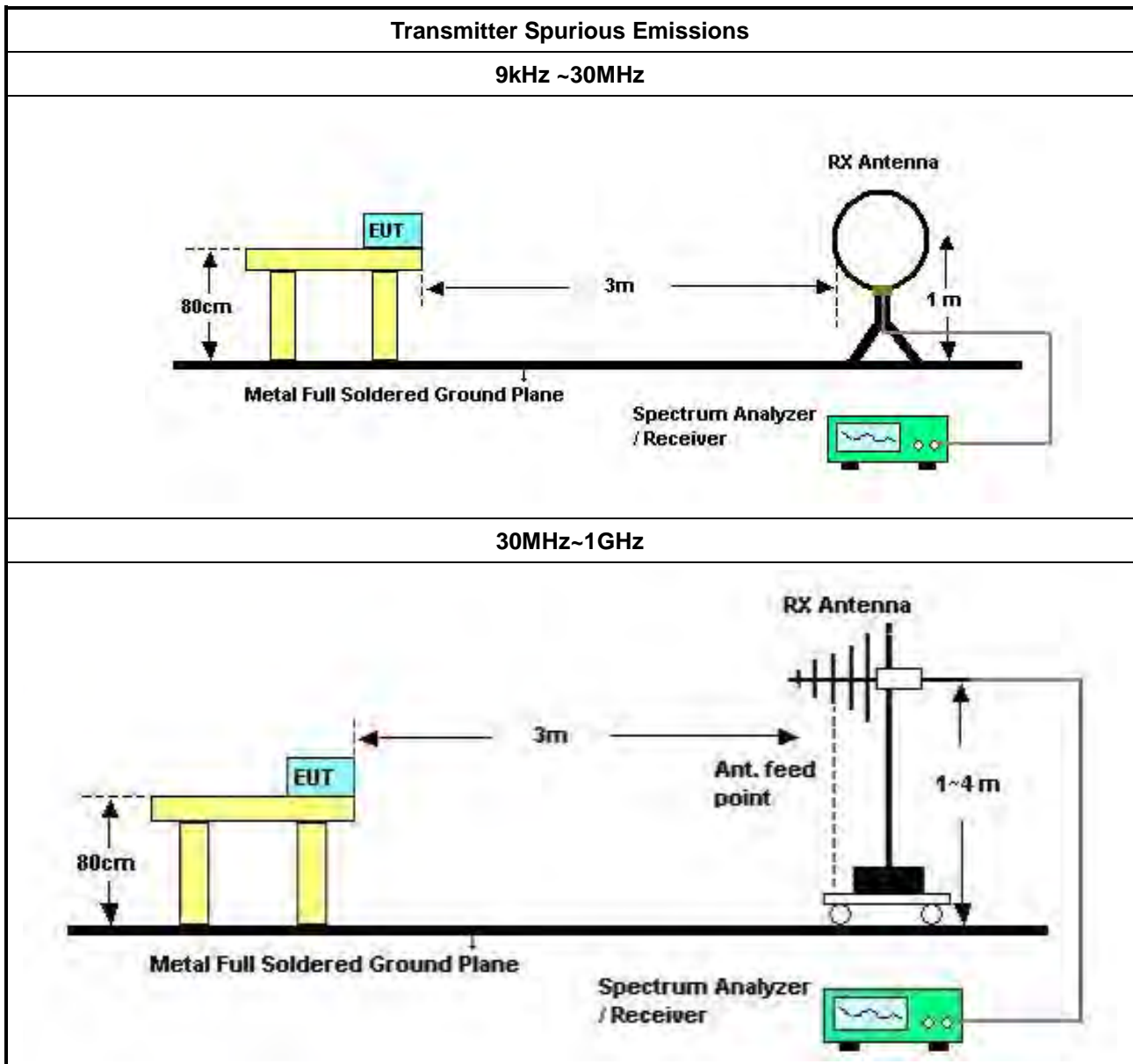

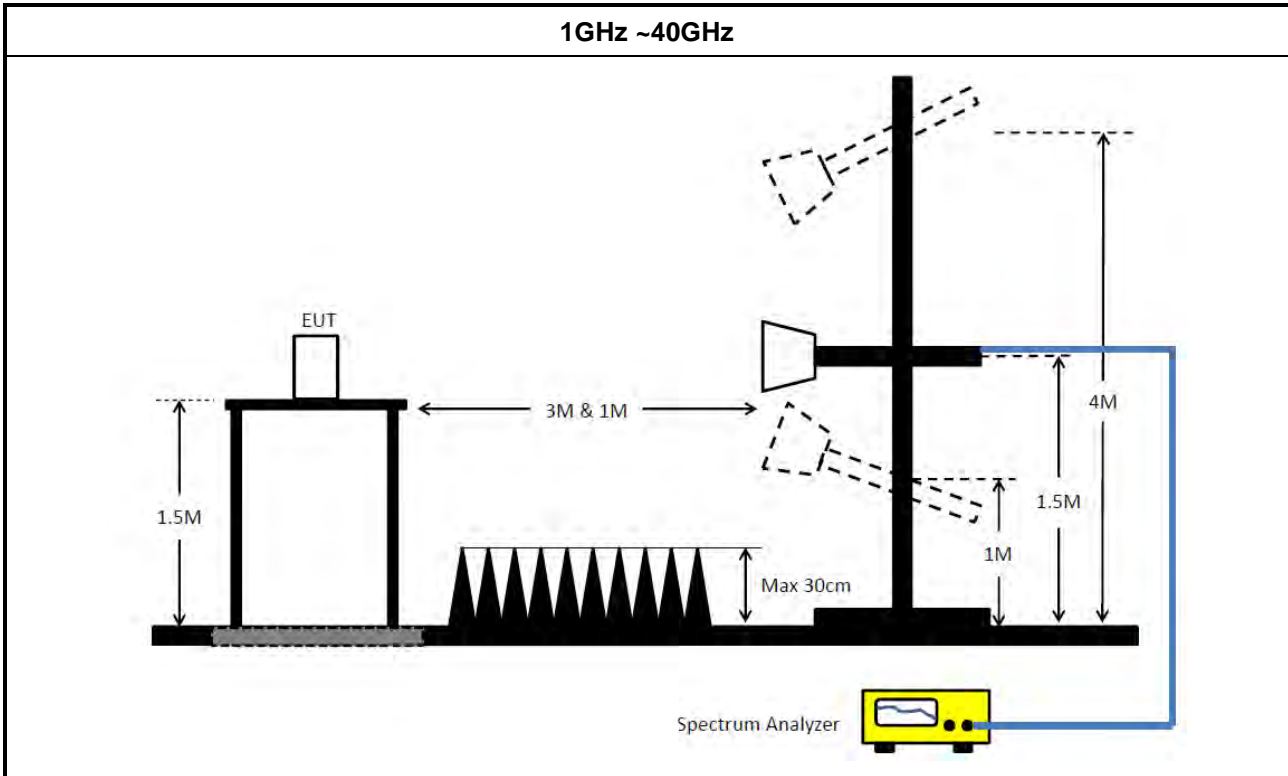

3.3.5 Measurement Results Calculation

The measured Level is calculated using:

For below 40GHz

Corrected Reading: Antenna factor (AF) + Cable loss (CL) + Read level (Raw) - Preamp factor (PA)(if applicable) = Level.

For above 40GHz

$$EIRP = \text{Meas. Level} - \text{RX Antenna Gain} + 20 \cdot \log(4 \cdot \pi \cdot (3.14159) \cdot D / (300 / (\text{Frequency} \cdot 1000)))$$



3.3.6 Test Result of Transmitter Spurious Emissions

Test Conditions:	see ANSI C63.10, clause 5.11
Test Setup:	see ANSI C63.10, clauses 6.3, 6.4, 6.5, 6.6 and 9.12
<p>Note1: If equipment having different channel plan and nominal channel bandwidth modes, the measurements are uninfluenced by different channel plan and nominal channel bandwidth modes, may not need to be repeated for all modes.</p> <p>Note2: Note: Conformance tests have to be performed over the frequency range(s) that has been declared with this Field Strength of Fundamental and using the antenna gain of the antenna with the highest gain among those that have been declared with this Field Strength of Fundamental. For smart antenna systems, the antenna beam forming gain may have to be taken into account as well.</p>	

Test Frequency: 10525 MHz		Test Range: 9 kHz - 30 MHz			
Test Results					
Test Range	Emission Frequency (MHz)	Emission Observed (dBuV/m)	Limit (dBuV/m)	Margin (dB)	Remark
9 kHz - 30 MHz	N/F	N/F	-	-	Peak
<p>Note:</p> <p>1. "N/F" means Nothing Found (No spurious emissions were detected.)</p> <p>2. There is a comparison data of both open-field test site and alternative test site - semi-Anechoic chamber according to KDB414788 Radiated Test Site, and the result came out very similar.</p>					



Test Frequency: 10525 MHz	Test Range: 30 MHz – 1000 MHz
	Polarization: Vertical
	Test Distance: 3m

Test Results

Mode 1

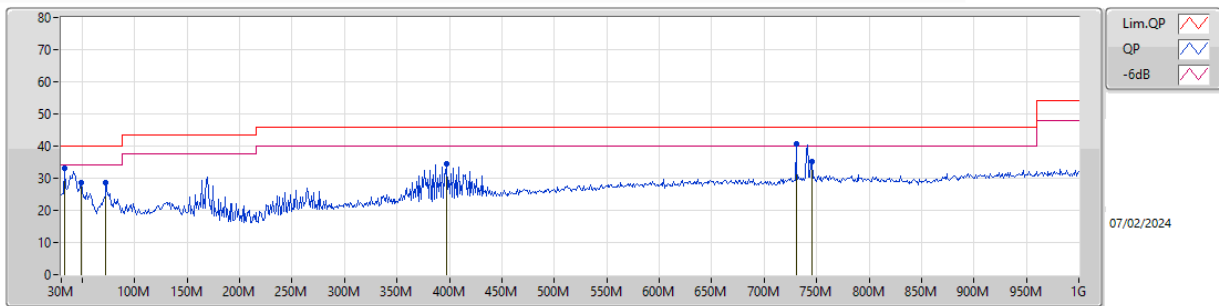

Type	Freq (Hz)	Level (dBuV/m)	Limit (dBuV/m)	Margin (dB)	Factor (dB/m)	Dist (m)	Condition	Azimuth (°)	Height (m)	Comment	Raw (dBuV/m)	AF (dB/m)	CL (dB)	PA (dB)
PK	32.91M	33.12	40.00	-6.88	-8.66	3	Vertical	86	1.00	-	41.78	22.58	1.17	32.41
PK	49.4M	28.48	40.00	-11.52	-16.24	3	Vertical	165	1.00	-	44.72	14.77	1.32	32.33
PK	72.68M	28.49	40.00	-11.51	-18.37	3	Vertical	19	1.50	-	46.86	12.44	1.50	32.31
PK	397.63M	34.57	46.00	-11.43	-7.54	3	Vertical	158	1.25	-	42.11	21.47	3.00	32.01
PK	730.34M	40.56	46.00	-5.44	-2.29	3	Vertical	285	1.25	"Worst"	42.85	25.39	3.88	31.56
PK	745.86M	35.04	46.00	-10.96	-1.98	3	Vertical	246	1.25	-	37.02	25.56	3.92	31.46



Test Frequency: 10525 MHz	Test Range: 30 MHz – 1000 MHz
	Polarization: Horizontal
	Test Distance: 3m

Test Results

Mode 1

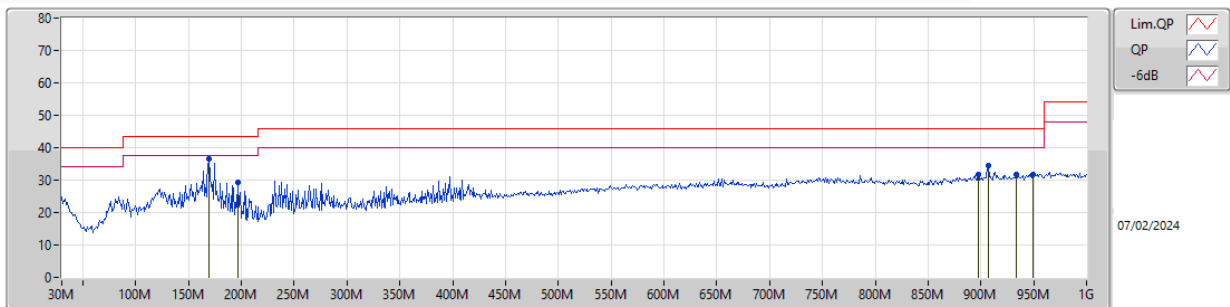

Type	Freq (Hz)	Level (dBuV/m)	Limit (dBuV/m)	Margin (dB)	Factor (dB/m)	Dist (m)	Condition	Azimuth (°)	Height (m)	Comment	Raw (dBuV/m)	AF (dB/m)	CL (dB)	PA (dB)
PK	169.68M	36.63	43.50	-6.87	-14.44	3	Horizontal	119	1.25	"Worst"	51.07	15.86	2.03	32.33
PK	196.84M	29.41	43.50	-14.09	-14.91	3	Horizontal	131	1.00	-	44.32	15.18	2.17	32.26
PK	897.18M	31.78	46.00	-14.22	-0.80	3	Horizontal	1	1.00	-	32.58	26.46	4.31	31.57
PK	906.88M	34.63	46.00	-11.37	-0.56	3	Horizontal	246	1.00	-	35.19	26.50	4.33	31.39
PK	933.07M	31.71	46.00	-14.29	0.03	3	Horizontal	232	1.25	-	31.68	26.48	4.37	30.82
PK	949.56M	31.89	46.00	-14.11	0.59	3	Horizontal	4	1.00	-	31.30	26.66	4.39	30.46



Test Frequency: 10525 MHz	Test Range: 1 GHz – 18 GHz
	Polarization: Vertical
	Test Distance: 3m

Test Results

Mode 1

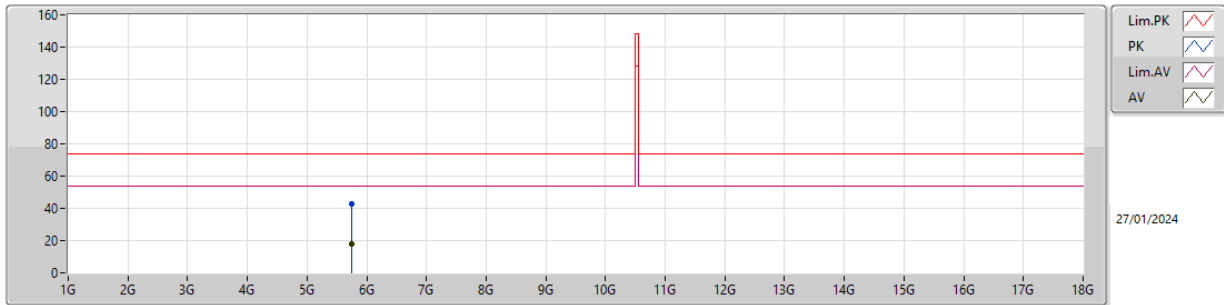

EUTY
Power DC 12V/1A
05-C-J-8

Type	Freq (Hz)	Level (dBuV/m)	Limit (dBuV/m)	Margin (dB)	Factor (dB/m)	Dist (m)	Condition	Azimuth (°)	Height (m)	Comment	Raw (dBuV/m)	AF (dB/m)	CL (dB)	PA (dB)
PK	5.752G	42.64	74.00	-31.36	6.14	3	Vertical	360	1.50	-	36.50	33.71	7.95	35.52
AV	5.752G	18.20	54.00	-35.80	6.14	3	Vertical	360	1.50	-	12.06	33.71	7.95	35.52



Test Frequency: 10525 MHz	Test Range: 1 GHz – 18 GHz
	Polarization: Horizontal
	Test Distance: 3m

Test Results

Mode 1

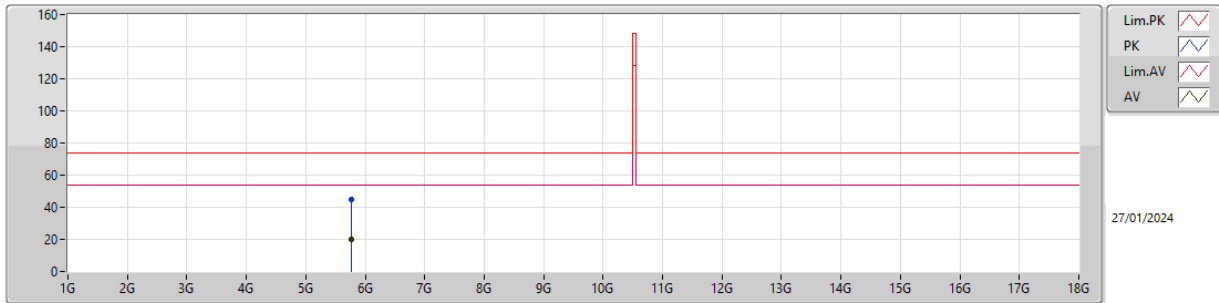

EUTY
Power DC 12V/1A
05-C-J-8

Type	Freq (Hz)	Level (dBuV/m)	Limit (dBuV/m)	Margin (dB)	Factor (dB/m)	Dist (m)	Condition	Azimuth (°)	Height (m)	Comment	Raw (dBuV/m)	AF (dB/m)	CL (dB)	PA (dB)
PK	5.761G	44.76	74.00	-29.24	6.19	3	Horizontal	223	1.78	-	38.57	33.74	7.97	35.52
AV	5.761G	20.32	54.00	-33.68	6.19	3	Horizontal	223	1.78	-	14.13	33.74	7.97	35.52



Test Frequency: 10525 MHz	Test Range: 18 GHz – 40 GHz
	Polarization: Vertical
	Test Distance: 1m

Test Results

Mode 1

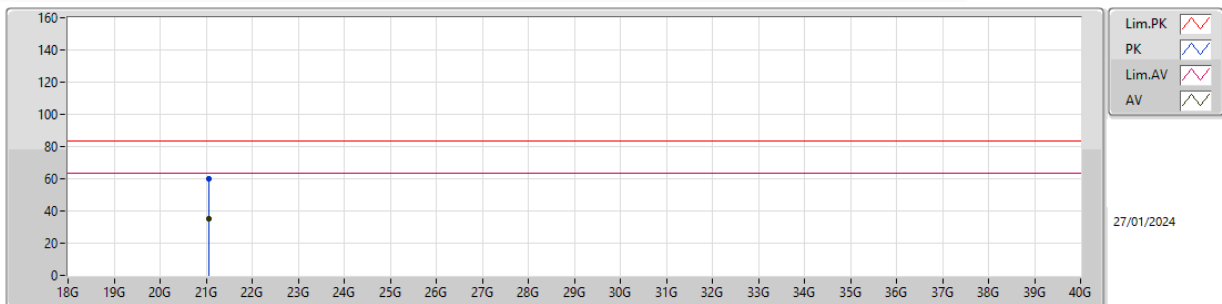

EUT Y
Power DC 12V/1A
05-C-J-8

Type	Freq (Hz)	Level (dBuV/m)	Limit (dBuV/m)	Margin (dB)	Factor (dB/m)	Dist (m)	Condition	Azimuth (°)	Height (m)	Comment	Raw (dBuV/m)	AF (dB/m)	CL (dB)	PA (dB)
PK	21.0555G	59.81	83.54	-23.73	2.21	1	Vertical	266	1.50	-	57.60	38.37	16.04	52.20
AV	21.0555G	35.37	63.54	-28.17	2.21	1	Vertical	266	1.50	-	33.16	38.37	16.04	52.20



Test Frequency: 10525 MHz	Test Range: 18 GHz – 40 GHz
	Polarization: Horizontal
	Test Distance: 1m

Test Results

Mode 1

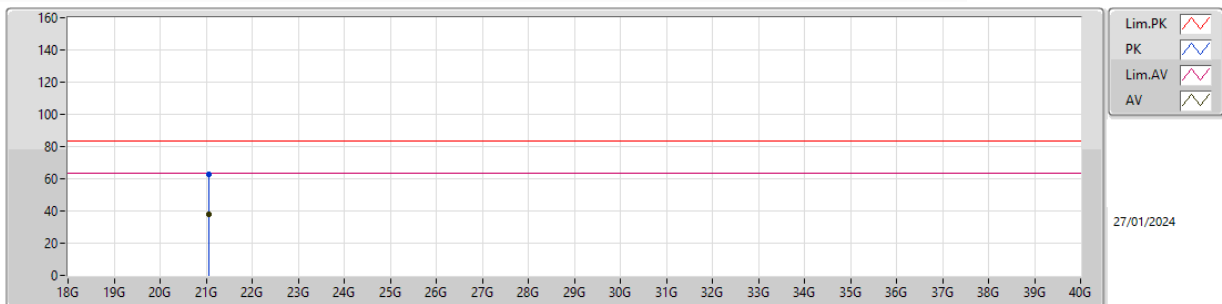

EUT Y
Power DC 12V/1A
05-C-J-8

Type	Freq (Hz)	Level (dBuV/m)	Limit (dBuV/m)	Margin (dB)	Factor (dB/m)	Dist (m)	Condition	Azimuth (°)	Height (m)	Comment	Raw (dBuV/m)	AF (dB/m)	CL (dB)	PA (dB)
PK	21.05545G	62.55	83.54	-20.99	2.21	1	Horizontal	302	1.49	-	60.34	38.37	16.04	52.20
AV	21.05545G	38.11	63.54	-25.43	2.21	1	Horizontal	302	1.49	-	35.90	38.37	16.04	52.20



3.4 Antenna Requirements

3.4.1 Limit of Antenna Requirements

Limits for Antenna Requirements
The use of a permanently attached antenna or of an antenna that uses a unique coupling to the intentional radiator. The manufacturer may design the unit so that a broken antenna can be replaced by the user, but the use of a standard antenna jack or electrical connector is prohibited

3.4.2 EUT Antenna

See test report clause 1.1.1, EUT antenna complied with antenna requirements.



4 Test Equipment and Calibration Data

Instrument	Brand	Model No.	Serial No.	Characteristics	Calibration Date	Calibration Due Date	Remark
EMI Receiver	Agilent	N9038A	My52260123	9kHz ~ 8.4GHz	Feb. 20, 2023	Feb. 19, 2024	Conduction (CO01-CB)
LISN	F.C.C.	FCC-LISN-50-16-2	04083	150kHz ~ 100MHz	Feb. 16, 2023	Feb. 15, 2024	Conduction (CO01-CB)
LISN	Schwarzbeck	NSLK 8127	8127647	9kHz ~ 30MHz	Apr. 27, 2023	Apr. 26, 2024	Conduction (CO01-CB)
Pulse Limiter	Rohde&Schwarz	ESH3-Z2	100430	9kHz ~ 30MHz	Feb. 08, 2024	Feb. 07, 2025	Conduction (CO01-CB)
COND Cable	Woken	Cable	Low cable-CO 01	9kHz ~ 30MHz	Oct. 17, 2023	Oct. 16, 2024	Conduction (CO01-CB)
Software	SPORTON	SENSE	V5.10	-	N.C.R.	N.C.R.	Conduction (CO01-CB)
Loop Antenna	Teseq	HLA 6121	65417	9kHz - 30 MHz	Oct. 13, 2023	Oct. 12, 2024	Radiation (03CH06-CB)
3m Semi Anechoic Chamber NSA	TDK	SAC-3M	03CH06-CB	30 MHz ~ 1 GHz	Aug. 03, 2023	Aug. 02, 2024	Radiation (03CH06-CB)
Bilog Antenna with 6 dB attenuator	TESEQ & EMCI	CBL6112D & N-6-06	37878 & AT-N0606	20MHz ~ 2GHz	Jul. 30, 2023	Jul. 29, 2024	Radiation (03CH06-CB)
Pre-Amplifier	Agilent	310N	187290	0.1MHz ~ 1GHz	Nov. 03, 2023	Nov. 02, 2024	Radiation (03CH06-CB)
Signal Analyzer	R&S	FSV40	101904	9kHz ~ 40GHz	Apr. 21, 2023	Apr. 20, 2024	Radiation (03CH06-CB)
EMI Test Receiver	R&S	ESCS	826547/017	9kHz ~ 2.75GHz	Jun. 13, 2023	Jun. 12, 2024	Radiation (03CH06-CB)
RF Cable-low	Woken	RG402	Low Cable-24+68	30MHz~1GHz	Oct. 02, 2023	Oct. 01, 2024	Radiation (03CH06-CB)
Test Software	SPORTON	SENSE	V5.10	-	N.C.R.	N.C.R.	Radiation (03CH06-CB)
3m Semi Anechoic Chamber VSWR	TDK	SAC-3M	03CH05-CB	1GHz ~18GHz 3m	Sep. 29, 2023	Sep. 28, 2024	Radiation (03CH05-CB)
Horn Antenna	SCHWARZBECK	BBHA9120D	BBHA 9120 D-1291	1GHz~18GHz	Jun. 08, 2023	Jun. 07, 2024	Radiation (03CH05-CB)
Horn Antenna	Schwarzbeck	BBHA 9170	BBHA9170252	15GHz ~ 40GHz	Sep. 04, 2023	Sep. 03, 2024	Radiation (03CH05-CB)
Pre-Amplifier	EMCI	EMC12630SE	980287	1GHz – 26.5GHz	Jun. 30, 2023	Jun. 29, 2024	Radiation (03CH05-CB)
Pre-Amplifier	SGH	SGH184	20221107-3	18GHz ~ 40GHz	Nov. 24, 2023	Nov. 23, 2024	Radiation (03CH05-CB)



Instrument	Brand	Model No.	Serial No.	Characteristics	Calibration Date	Calibration Due Date	Remark
Spectrum Analyzer	R&S	FSP40	100304	9kHz ~ 40GHz	Apr. 18, 2023	Apr. 17, 2024	Radiation (03CH05-CB)
RF Cable-high	Woken	RG402	High Cable-28	1GHz~18GHz	Oct. 02, 2023	Oct. 01, 2024	Radiation (03CH05-CB)
RF Cable-high	Woken	RG402	High Cable-04+28	1GHz~18GHz	Oct. 02, 2023	Oct. 01, 2024	Radiation (03CH05-CB)
High Cable	Woken	WCA0929M	40G#5+6	1GHz ~ 40 GHz	Jan. 11, 2024	Jan. 10, 2025	Radiation (03CH05-CB)
Test Software	SPORTON	SENSE	V5.10	-	N.C.R.	N.C.R.	Radiation (03CH05-CB)

Note: Calibration Interval of instruments listed above is one year.
NCR means Non-Calibration required.