

WM

Watertight Transmitter

With Digital Hybrid Wireless® Technology
US Patent 7,225,135



Fill in for your records:

Serial Number:

Purchase Date:

Introduction

The WM transmitter is designed to resist damage when used in wet or dusty conditions and also offer a comprehensive feature set that makes it equally at home in film and television production and on stage.

A solid machined aluminum housing with a corrosion resistant finish hosts dual battery compartments, a moisture sealed control panel with backlit LCD and enlarged membrane switches. Recessed seats for the O-rings in the battery caps and input jack allow the caps and mic connector to be tightened securely without excessive deformation of the O-rings.

The antenna is made of an extremely durable, multi-strand alloy that will withstand heavy abuse. It is mounted with a compression sealed strain relief that prevents dust and moisture from entering the housing.

As the first stage in the signal processing chain, the input preamp section includes very high quality, low noise components with a wide range of gain adjustment in 1 dB increments and a DSP-controlled input limiter. Dual color LEDs on the control panel accurately indicate audio input level for precise gain adjustment. Easily accessed screens on the LCD simplify setup and adjustments.

Output power is adjustable to provide either extended operating range or extended battery life as needed for the application.

The Digital Hybrid Wireless® design (US Patent 7,225,135) combines 24-bit digital audio with analog FM resulting in a system that has the same operating range as analog systems, the same spectral efficiency as analog systems, the same long battery life as analog systems, plus the excellent audio fidelity typical of pure digital systems.

The DSP-based design works with all Digital Hybrid receivers, and is backward compatible for use with Lectrosonics 200 Series, 100 Series, IFB receivers and some other brands of analog wireless receivers.

Table of Contents

| | |
|---|-----------|
| Introduction | 2 |
| General Technical Description | 4 |
| Servo Bias Input..... | 4 |
| No Pre-Emphasis/De-Emphasis | 4 |
| Low Frequency Roll-Off | 4 |
| Input Limiter | 4 |
| Signal Encoding and Pilot Tone | 5 |
| Microprocessor Control..... | 5 |
| Compatibility Modes..... | 5 |
| Control Panel | 5 |
| Wide-Band Deviation | 5 |
| Variable Power Output | 5 |
| Battery Operation..... | 5 |
| Output Isolator | 5 |
| Controls and Functions | 6 |
| LCD Screen | 6 |
| Power LED..... | 6 |
| Audio Input Jack..... | 6 |
| Battery Compartment and Thumb Screw..... | 6 |
| Modulation LEDs..... | 6 |
| AUDIO Button | 6 |
| FREQ Button..... | 6 |
| Up/Down Arrows | 6 |
| Antenna..... | 6 |
| Battery Compartments | 7 |
| About Batteries | 7 |
| Input Connector | 7 |
| Equivalent Input Circuit Diagram | 7 |
| Operating Instructions | 8 |
| Power Up and Boot Sequence..... | 8 |
| Power Down..... | 8 |
| Standby Mode..... | 8 |
| Menus and Settings | 9 |
| UP Arrow Settings | 9 |
| Compatibility Mode | 9 |
| Input Type..... | 9 |
| RF Power Output | 9 |
| LCD Backlight | 9 |
| Frequency Step Size..... | 10 |
| DOWN Arrow Settings | 10 |
| Remote Control..... | 10 |
| Auto Power Restore | 10 |
| Audio Mute..... | 11 |
| FREQ Button Settings | 12 |
| AUDIO Button Settings | 12 |
| Low Frequency Roll-off | 12 |
| Input Gain | 12 |
| LectroRM | 13 |
| Troubleshooting | 14 |
| Accessories and Replacement Parts | 16 |
| Straight Whip Antennas | 17 |
| Preventing Corrosion | 18 |
| Desiccant Battery Caps | 18 |
| Battery Door Update | 18 |
| Re-conditioning (drying out) the caps and desiccant beads | 19 |
| Replacing the desiccant beads..... | 19 |
| Specifications..... | 20 |
| Service and Repair | 22 |
| Returning Units for Repair | 22 |

General Technical Description

Servo Bias Input

The voltage and current requirements of the wide variety of electret microphones used in professional applications has caused confusion and compromises in the wiring needed for wireless transmitters. To address this problem, the unique Servo Bias input circuit provides an automatically regulated voltage over a very wide range of current for compatibility with all microphones.

Digital Hybrid Wireless® Technology

All wireless links suffer from channel noise to some degree, and all wireless microphone systems seek to minimize the impact of that noise on the desired signal. Conventional analog systems use compandors for enhanced dynamic range, at the cost of subtle artifacts (typically “pumping” and “breathing”). Wholly digital systems defeat the noise by sending the audio information in digital form, at the cost of some combination of power, bandwidth and resistance to interference.

Digital Hybrid systems overcome channel noise in a dramatically new way, digitally encoding the audio in the transmitter and decoding it in the receiver, yet still sending the encoded information via an analog FM wireless link. This proprietary algorithm is not a digital implementation of an analog compandor but a technique that can be accomplished only in the digital domain, even though the inputs and outputs are analog.

Because it uses an analog FM link, the Digital Hybrid system enjoys all the benefits of conventional FM wireless systems and it does away with the analog compandor and its artifacts.

No Pre-Emphasis/De-Emphasis

The Digital Hybrid design results in a signal-to-noise ratio high enough to preclude the need for conventional pre-emphasis (HF boost) in the transmitter and de-emphasis (HF roll off) in the receiver. This eliminates the potential for distortion of signals with abundant high-frequency information.

Low Frequency Roll-Off

The low frequency roll-off can be set for a 3 dB down point at 35, 50, 70, 100, 120 and 150 Hz to control subsonic and very low frequency audio content in the audio. The actual roll-off frequency will vary slightly depending upon the low frequency response of the microphone.

Excessive low frequency content can drive the transmitter into limiting, or in the case of high output sound systems, it can even cause damage to loudspeaker systems. The roll-off is normally adjusted by ear while listening as the system is operating.

Input Limiter

A DSP-controlled analog audio limiter is employed before the A-D converter. The limiter has a range of more than 30 dB for excellent overload protection. A dual release envelope makes the limiter acoustically transparent while maintaining low distortion. It can be thought of as two limiters in series, a fast attack and release limiter followed by a slow attack and release limiter. The limiter recovers quickly from brief transients, with no audible side effects, and also recovers slowly from sustained high levels to keep audio distortion low while preserving short term dynamics.

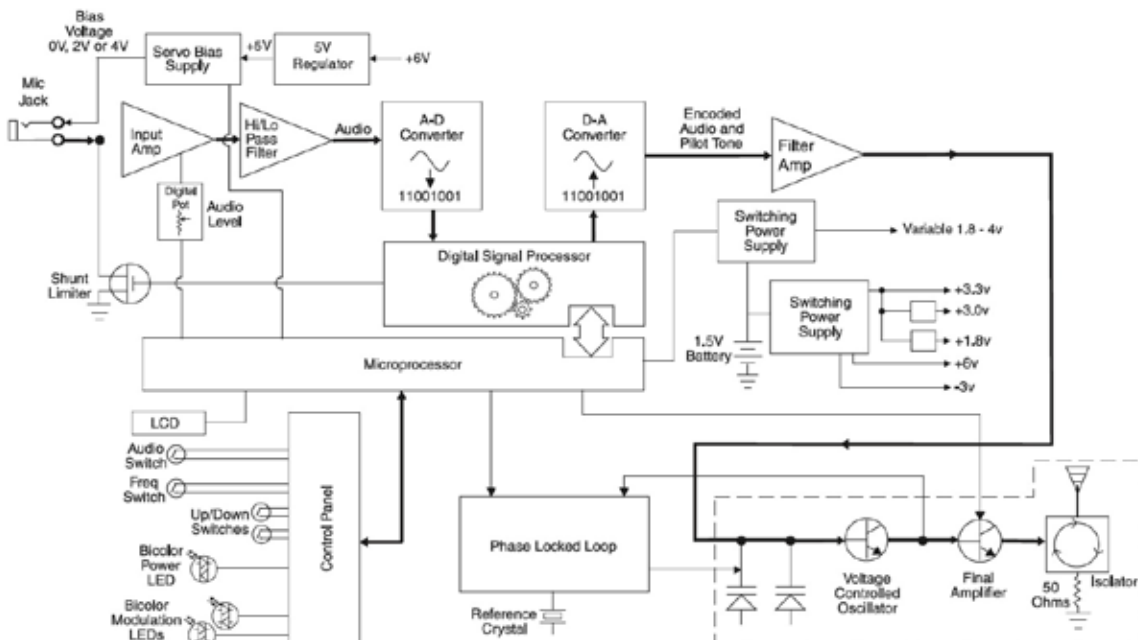

Signal Encoding and Pilot Tone

In addition to controlling the limiter, the DSP also encodes the digitized audio from the A/D converter and adds an ultrasonic pilot tone to control the squelch in the receiver. A pilot tone squelch system provides a reliable method of keeping a receiver output muted (audio mute) even in the presence of significant interference. When the system is operating in the Nu Hybrid mode, a different pilot tone frequency is generated for each carrier frequency to prevent inadvertent squelch problems in multi-channel systems.

Microprocessor Control

A microprocessor monitors user command inputs from the control panel buttons and numerous other internal signals. It works intimately with the DSP to ensure the audio is encoded according to the selected Compatibility Mode and that the correct pilot tone is added to the encoded signal.

Compatibility Modes

Along with providing peerless audio quality with wide frequency response and dynamic range in Nu Hybrid mode, the technology used in the WM Transmitter includes compatibility modes for Lectrosonics Mode 3 and IFB receivers.

Control Panel

The control panel includes four membrane switches and an LCD screen to adjust the operational settings. Multi-color LEDs are used to indicate audio signal levels for accurate gain adjustment and for battery status.

Wide-Band Deviation

± 75 kHz deviation improves the signal to noise ratio and audio dynamic range of a wireless system dramatically, compared to other designs that use ± 30 kHz to 40 kHz deviation. Wide deviation combined with a high powered transmitters makes a significant improvement in signal to noise ratio and operating range.

Variable Power Output

This advanced feature allows the operator to optimize the transmitter for maximum battery life, or for maximum operating range. Power output is selected using the LCD in a setup mode while the RF output of the transmitter is turned off.

Battery Operation

Switching power supplies convert battery voltages to operate various circuit stages with maximum efficiency.

The firmware “remembers” the settings when the batteries are exhausted. After new batteries are installed, a quick press of the AUDIO and FREQ buttons will turn the power back on and return to the previous settings. This is a unique behavior that takes place only when the batteries fail during operation. If the unit is turned off manually, a quick press of the buttons will turn it on in the “standby” mode instead.

Because the battery caps make contact with the battery before the cap is seated, the power does not turn back on automatically. This allows both batteries to be installed and the caps tightened before power is restored.

Output Isolator

The RF output circuit includes a magnetically polarized ferrite called an *isolator* that suppresses IM (inter-modulation) that can take place in the final amplifier. IM in this case would result from external RF signals from outside sources entering a transmitter through its antenna and appearing in the final amplifier. These signals can then mix with the transmitter’s output signal to create new interfering signals.

The isolator works like a one-way “check valve” that lets the intended signal generated in the transmitter travel to the antenna to be transmitted, but it directs RF signals coming back into the antenna from outside sources to ground and keeps them from entering the final amplifier. This greatly reduces IM produced when multiple transmitters are used in close proximity to one another (several feet apart). The isolator also provides additional RF output stage protection against static shock.

Controls and Functions

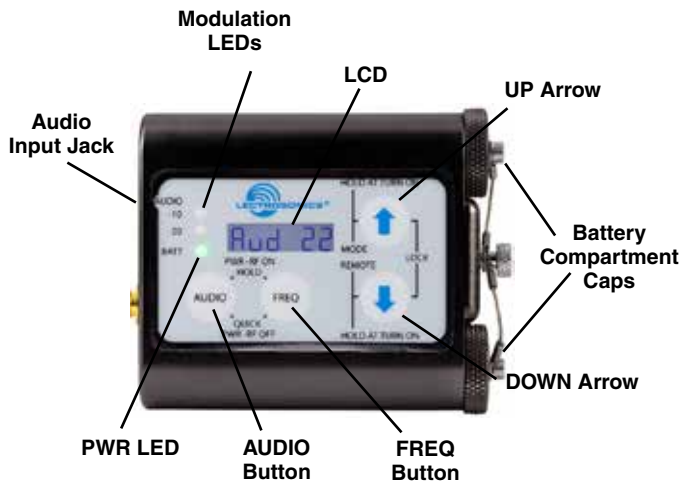

LCD Screen

The display is a highly visible, backlit LCD with screens for making all setup and level adjustments. The transmitter can be powered up with or without the RF output turned on. With the RF output turned off, all adjustments can be made without creating interference for other wireless systems in the vicinity.

For normal powering up and down, a countdown appears in the LCD. The buttons must be pressed for the duration of the countdown, which helps to prevent accidentally turning the transmitter on or off.

Power LED

The PWR LED glows green when the battery is good. The color changes to red when there is about 30 minutes of operation left with the recommended lithium battery. When the LED begins to blink red, there are only a few minutes of life.

A weak battery will sometimes cause the PWR LED to glow green immediately after the unit is turned on, but will soon discharge to the point where the LED will turn red or the unit will turn off completely. When the transmitter is in SLEEP mode, the LED blinks green every few seconds.

Audio Input Jack

This is a threaded locking connector that accepts the Lectrosonics watertight WP connector.

Battery Compartment and Thumb Screw

The large knurled thumbscrews are retain the batteries and maintain solid battery contact. The lanyard keeps the battery caps attached, but it can be removed if desired using a 1/16 inch hex key (Allen wrench).

Modulation LEDs

Proper input gain adjustment is critical to ensure the best audio quality. Two red/green LEDs will glow to accurately indicate modulation levels. The input circuitry includes a wide range DSP-controlled limiter to prevent distortion during high peak levels.

It is important to set the gain (audio level) high enough to achieve full modulation during louder peaks in the audio. The DSP-controlled limiter can handle peaks over 30 dB above full modulation, so with an optimum setting, the LEDs will flash red during use. If the LEDs never flash red, the gain is too low. The **-20 LED** turns red at 0 dB (full modulation).

| Signal Level | -20 LED | -10 LED |
|---------------------|---------|---------|
| Less than -20 dB | ● Off | ● Off |
| -20 dB to -10 dB | ● Green | ● Off |
| -10 dB to +0 dB | ● Green | ● Green |
| +0 dB to +10 dB | ● Red | ● Green |
| Greater than +10 db | ● Red | ● Red |

AUDIO Button

The AUDIO button is used to display the gain and low frequency roll-off settings. The UP and DOWN arrows adjust the values. This button is also used with the FREQ button to enter standby mode and to power the transmitter on or off.

FREQ Button

The FREQ Button displays the selected operating frequency and also toggles the LCD between displaying the actual operating frequency in MHz and a two-digit hexadecimal number that corresponds to the equivalent Lectrosonics Frequency Switch Setting. This button is also used with the AUDIO button to enter standby mode and to power the transmitter on or off.

Up/Down Arrows

The Up and Down arrow buttons are used to select the values on the various setup screens and to lock out the control panel. Pressing both arrows simultaneously enters the lock countdown. When an attempt is made to change a setting while the control panel is locked, a message will flash on the LCD as a reminder that the unit is locked. Once locked, the buttons can only be unlocked by removing the batteries, or with the RM remote control.

Antenna

The fixed whip antenna is constructed with a flexible, woven, galvanized steel mesh cable.

Battery Compartments

The battery compartments are a rugged, straight-forward design with a recessed entry that captures the O-ring on the cap. The spring contact on the cap maintains solid contact on the battery regardless of its exact length.



The O-rings should be kept clean and dry, and coated with petroleum jelly on a regular basis. See page 11 for more information on preventing corrosion.

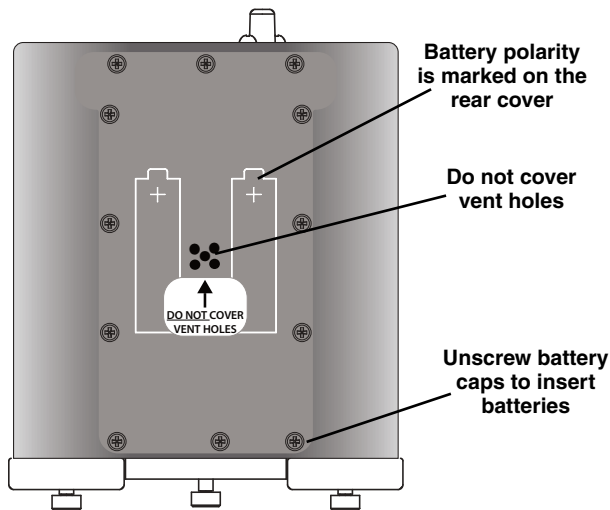

Input Connector

The threaded WP watertight plug on the microphone cable fits into a recessed jack on the top panel. The recess in the opening retains the O-ring when the plug is tightened. The Lectrosonics M152WP lavalier microphone is supplied with the WP plug already installed. Other microphones can also be terminated with this plug by following the instructions included with the WP connector kits.



Treat O-ring with petroleum jelly before connecting (see page 11)

Equivalent Input Circuit Diagram

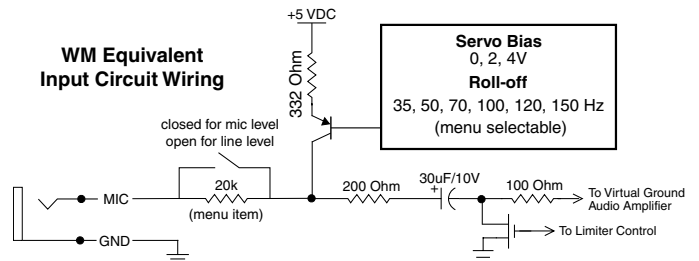

About Batteries

The transmitter is powered by two AA batteries. Lithium batteries are recommended for longest life, which typically provides over 7.5 hours of operation at room temperature with the output set to 250 mW. At 50 mW, the runtime is typically over 14 hours with lithium batteries.

The PWR LED glows green when the battery is good. The color changes to red at a mid-point of operating life, and will continue to glow red until the battery gets close to the end of its life. When the LED begins to blink red, there are only a few minutes remaining.

The exact point at which the LED turns red will vary with battery brand and condition, temperature and current drain. The LED is simply a reminder intended to catch your attention, not an exact indicator of remaining time.

Operating Instructions

Power Up and Boot Sequence

Simultaneously press and hold the AUDIO and FREQ buttons until the startup count is completed. The screen will display a count from 1 to 3 as the unit boots up, then it switches to the Audio screen. As the unit turns on, the Modulation LEDs and PWR LED all glow red, then green, and then revert to normal operation.



The LCD displays a boot sequence which consists of four screens ending with the audio screen similar to this example:

- Company name: Lectro
- Frequency block/Firmware Ver.: b22r2.4
- Power level: Pr 100
- Compatibility mode: CP IFB
- Audio (Input gain): Aud 22

Power Down



Simultaneously press and hold the AUDIO and FREQ buttons while observing that

the word “OFF” appears in the LCD along with a counter. The screen will display a countdown from 3 to 1 and the unit will then turn off.

Note: If the AUDIO and FREQ buttons are released before the LCD goes blank at the end of the countdown, the unit will not turn off. Instead, it will stay energized and the display will return to the previous screen.

Standby Mode



With the unit off, quickly press both AUDIO and FREQ buttons, and release

before counter reaches “0” to enter the “standby” mode. In this mode the RF output is turned off so adjustments can be made without interfering with other systems operating in the same location. The LCD displays **rf OFF** to remind you that the unit is not transmitting.

Use the AUDIO and FREQ buttons to access the various setup screens. When the adjustments are complete, press both the AUDIO and FREQ buttons briefly to save the settings and turn the unit off.

Lock/Unlock the Keypad

The control panel buttons can be locked out to avoid inadvertent changes in the settings or turning the unit off unintentionally. Simultaneously pressing and holding both the UP and DOWN arrow buttons during normal operation starts a countdown timer.



The timer starts at three and counts down to zero. When the timer reaches zero, the transmitter’s controls are locked.

With the controls locked, the AUDIO and FREQ buttons can still be used to display current settings. Any attempt to change a setting by pressing either the Up or Down arrow button will result in an on-screen **Loc** reminder that the controls are locked.



Once the transmitter is locked, it cannot be unlocked or powered off using the buttons. The only ways to unlock a locked transmitter are to remove the battery or unlock it via the RM remote control.

Menus and Settings

There are four locations for setup options and settings accessed with the control panel:

- UP Arrow Menu and Settings
- DOWN Arrow Menu and Settings
- AUDIO button settings
- FREQ button settings

UP Arrow Settings

With the unit turned off, hold the UP arrow button and simultaneously press the AUDIO and FREQ buttons. Each successive press of the AUDIO button will step through the setup screens.

- **Compatibility Mode**
- **Input Type**
- **RF Power Output**
- **LCD Backlight**
- **Frequency Step Size**

Use the UP and DOWN arrow buttons to scroll through the options. The selected options will automatically be stored when the power is turned off. Press both the AUDIO and FREQ buttons to exit the menu and turn the power off.



Then press the AUDIO and FREQ buttons at the same time

Note: The unit is automatically set to “standby” in this setup mode; with **rF OFF** not displayed.

Compatibility Mode



These modes provide DSP-based emulations for use with earlier Lectrosonics equipment and with some models from other manufacturers.

- **CP NU Hybr:** Nu Hybrid mode
- **CP IFb:** IFB Series mode
- **CP 3:** Mode 3 (contact the factory for details)

Input Type



The input can be configured for electret or dynamic microphones or a line level input.

The transmitter features unique Servo Bias input circuitry that automatically adjusts the current to maintain a selected bias voltage for electret microphone. This effectively overcomes a traditional problem with variations in output levels and power supply currents of different microphones.

Press the UP and DOWN arrows to select the desired input type:

- **LInE** Bias turned off; line level impedance
- **PH off** Bias turned off for dynamic mics
- **PH 2** Bias at 2 volts for electret mics
- **PH 4** Bias at 4 volts for electret mics

The correct bias is specified by the microphone manufacturer. 4 volts is typical for most electret lavalier microphones. 2 volts is preferred by some mic manufacturers such as Countryman for the very small B6 and E6 models.

RF Power Output



This setting provides an option for the trade-off between operating range and battery life. The lowest power setting provides maximum battery life, and the highest power setting provides maximum operating range and can also help to suppress some types of interference from broadband RF noise.

NOTE: See the specifications for typical operating times for each power level.

- **Pr 50** for maximum battery life
- **Pr 100** is an intermediate setting
- **Pr 250** for maximum operating range

LCD Backlight



The backlight on the display can be set to stay on all the time or to turn off after either 30 seconds or 5 minutes of

inactivity on the panel switches. The backlight will turn on and the timer will start over when a button is pressed. Use the UP and DOWN arrow buttons to select the desired setting.

- **bl 5** Stay on for five minutes
- **bl 30** Stay on for 30 seconds
- **bl on** Stay on continuously

Frequency Step Size



This menu item allows frequencies to be selected in either 25 kHz or 100 kHz increments. If the desired frequency ends in .025, .050 or .075 MHz, the 25 kHz step size must be selected.

Normally, the receiver is used to find a clear operating frequency. All Lectrosonics Digital Hybrid receivers provide a scanning function to quickly find prospective frequencies with little or no RF interference. In other cases, a frequency may be specified by officials at a large event such as the Olympics or a major league ball game. Once the frequency is determined, set the transmitter to match the associated receiver.

- **Stp 100** Frequency steps in 100kHz increments
- **Stp 25** Frequency steps in 25 kHz increments

DOWN Arrow Settings

Hold the DOWN arrow button and simultaneously press the AUDIO and FREQ buttons. Each successive press of the AUDIO button will step through the setup screens.

- **Remote Control**
- **Auto Power Restore**
- **Audio Mute**

Use the UP and DOWN arrow buttons to scroll through the options. The selected options will automatically be stored when the power is turned off. Press both the AUDIO and FREQ buttons to exit the menu and turn the power off.



Then press the AUDIO and FREQ buttons at the same time

Remote Control



Transmitter settings can be configured using special tones generated by a smartphone using a remote control application such as Lectro RM (available on the AppStore or Google Play). Enable this feature on the transmitter with the following menu items:

- **rc on** Enables the remote function
- **rc off** Disables the remote function

If a remote control signal is detected but the function is turned off, the message **rc off** will be displayed briefly on the transmitter's LCD to confirm that a valid signal was received, but that the transmitter is not configured to respond to it.

Auto Power Restore



This setting determines how the transmitter is powered up again after the batteries have become exhausted in normal operation.

When this function is turned on, the unit will power up to normal operation with a brief press of the AUDIO and FREQ buttons after the batteries have been replaced.

When this function is turned off, the AUDIO and FREQ buttons need to be held in for the completion of the count to turn the unit back on for normal operation.

This is a unique behavior that takes place only when the batteries fail during operation. If the unit is turned off manually, a quick press of the buttons will turn it on in the "standby" mode instead.

The firmware is written this way because the battery caps make contact with the battery before the cap is seated, and the fact that there are two separate battery caps to tighten. This allows both batteries to be installed and the caps tightened before power is restored. It also makes turning the unit back on easier when wearing gloves since the buttons do not need to be held in.

- **PbAc 1** Turns power restore ON

- **PbAc 0** Turns power restore OFF

Audio Mute



Beginning with firmware v2.6 on the US version, the AUDIO button can be configured to work as a mute button by turning this setting on. A quick press of the AUDIO button will then mute the audio and a message will appear on the LCD confirming that the audio is muted. Another quick press turns the audio back on.

- **At on** Enables the audio mute function
- **At off** Disables the audio mute function

During operation, the LCD will continuously display the state of audio muting as a reminder, showing the audio as ON or OFF.



The AUDIO button will still work to set Input Gain by pressing and holding it in for a few seconds, however, if the audio is muted, no sound will be heard during the adjustment.

If the transmitter is in “standby,” the Low Frequency Roll-off can be adjusted whether or not the audio mute function is enabled. When the audio mute function is enabled and the unit is turned on and transmitting, only the audio level (input gain) can be adjusted by holding the AUDIO button in for a few seconds.

FREQ Button Settings

The frequency can be displayed either in MHz or as a two-digit hexadecimal number and it can be set when the unit is in “standby” or when the transmitter is powered up in the normal operating mode.

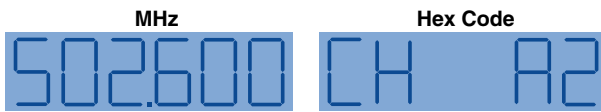

The hexadecimal numbering system is unique to Lectrosonics where two alphanumeric characters correspond to the left and right switch settings on earlier analog transmitters that had mechanical rotary switches to adjust frequency.

- Press the FREQ button repeatedly to toggle between either the MHz screen or the Hex Code screen.
- While holding the FREQ button, use the UP or DOWN arrow buttons to move the operating frequency up or down from the current setting.

The two-digit hex code is easier to remember, which can be handy when setting up a multi-channel system.

AUDIO Button Settings

Low Frequency Roll-off



It is possible that the low frequency roll-off point could affect the gain setting, so it's generally good practice to make this adjustment before adjusting the input gain. Press and hold the AUDIO button while selecting the desired roll-off frequency with the UP and DOWN arrows.

- **LF 35** 35 Hz
- **LF 50** 50 Hz
- **LF 70** 70 Hz
- **LF 100** 100 Hz
- **LF 120** 120 Hz
- **LF 150** 150 Hz

The roll-off is often adjusted by ear while monitoring the audio.

Input Gain



Properly set, this adjustment maximizes the signal to noise ratio of the system, and prevents loud peaks from being distorted. The input gain can be adjusted with the unit in the “standby” mode or while powered up in normal operation. The control panel Modulation LEDs indicate the audio level and limiter activity.

This gain adjustment matches the transmitter gain with the microphone's output level, the user's voice level and the position of the microphone.

It is desirable to set the gain so that some limiting occurs on louder peaks. The limiter is very transparent and its effect is not audible until the system is close to overload. In other words, don't be shy about turning up the gain. You can turn the gain up to maximum and listen for distortion or compression to get a feel for how much headroom is available.

| Signal Level | -20 LED | -10 LED |
|---------------------|---------|---------|
| Less than -20 dB | ● Off | ● Off |
| -20 dB to -10 dB | ● Green | ● Off |
| -10 dB to +0 dB | ● Green | ● Green |
| +0 dB to +10 dB | ● Red | ● Green |
| Greater than +10 db | ● Red | ● Red |

Note: Different voices will usually require different gain settings, so check this adjustment as each new person uses the system. If several different people will be using the transmitter and there is not time to make the adjustment for each individual, adjust it for the loudest voice.

Warning: If the wireless system is connected to a live sound system, turn the sound system level down first to avoid severe feedback.

- 1) Position the microphone in the location where it will be used in actual operation.
- 2) Place the transmitter in the “standby” mode or turn it on for normal use.
- 3) While speaking or singing into the microphone at the same voice level that will be used, observe the LEDs on the control panel. Hold the AUDIO button and press the UP or DOWN arrow buttons to adjust the gain until the -20 LED flickers red on louder peaks. This LED turns red at the instant full modulation takes place and the very onset of limiting. The red color does not indicate overload or clipping.



If the unit was set up in “standby” mode, it will be necessary to turn the transmitter off, then power it up again in normal operation so the RF output will be on. Then the other components in the sound or recording system can be adjusted.

NOTE: Do not use the gain adjustment to control the volume of the sound system or the recorder level.

LectroRM

By New Endian LLC

LectroRM is a mobile application for iOS and Android operating systems. Its purpose is to remotely control a variety of Lectrosonics transmitters.

The app remotely changes settings on the transmitter through the use of encoded audio tones, which when received by the attached microphone, will alter the configured setting. The app was released by New Endian, LLC in September 2011. The app is available for download and sells for about \$20 US on the Apple App Store and Google Play Store.

LectroRM's remote control mechanism is the use of an audio sequence of tones (dweedles) that are interpreted by the transmitter as a configuration change. The settings available in LectroRM are:

- Audio Level (input gain)
- Frequency
- Sleep Mode
- Lock Mode
- RF output power
- Low frequency roll-off
- LEDs ON/OFF

User Interface

The user interface is different between the iOS and Android versions, although the available settings are essentially the same.

iOS



The iOS version keeps each available setting on a separate page with the list of options for that setting. The "Activate" toggle switch must be enabled to show the button which will then generate the "dweedle" tone. The iOS version's default orientation is upside-down but can be configured to orient right-side up. The purpose for this is to orient the device's speaker, which is at the bottom of the device, closer to the transmitter microphone.

Android

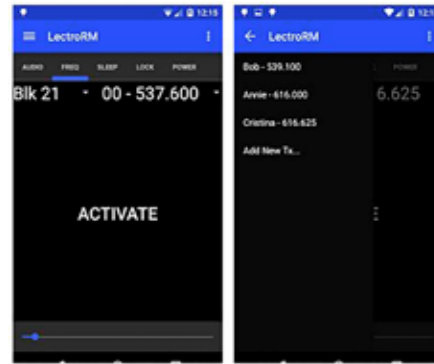

The Android version keeps all settings on the same page and allows the user to navigate between the activation buttons for each setting. The activation button must be long pressed to activate. The Android version also allows users to keep a configurable list of full sets of settings.

Activation

For a transmitter to respond to remote control audio tones, the transmitter must meet certain requirements:

- The transmitter must be turned on in either standby or operating mode.
- The WM transmitter must have firmware version 2.4 or later for all settings to be available.
- The transmitter microphone must be within range.
- The transmitter must be configured to enable remote control activation.

Please be aware this app is not a Lectrosonics product. It is privately owned and operated by New Endian LLC, www.newendian.com.

Troubleshooting

Before going through the following chart, be sure that you have a good battery in the transmitter. It is important that you follow these steps in the sequence listed.

SYMPTOM

POSSIBLE CAUSE

TRANSMITTER PWR LED OFF

- 1) Battery is inserted backwards or dead.
- 2) Transmitter not powered up. (See *Operating Instructions, Power UP and Boot Sequence.*)

TRANSMITTER PWR LED BLINKS GREEN EVERY FEW SECONDS, TRANSMITTER DOES NOT RESPOND OTHERWISE

- 1) Transmitter has been put to sleep by the remote control. Either use the remote control to wake it up again or remove and reinsert the transmitter battery.

AUDIO LEVEL LEDs NOT LIGHTING

- 1) Gain control set to minimum.
- 2) Wrong input type selected (such as **Line** instead of **PH 4**)
- 3) Batteries are dead or installed backwards. Check PWR LED.
- 4) Mic capsule is damaged or malfunctioning.
- 5) Mic cable damaged or mis-wired.

RECEIVER RF INDICATOR OFF

- 1) Transmitter not turned on, or is in Standby mode.
- 2) Transmitter battery is dead.
- 3) Receiver antenna missing or improperly positioned.
- 4) Transmitter and receiver not on same frequency or block. Check switches/display on transmitter and receiver.
- 5) Operating range is too great.
- 6) Defective transmitter antenna.

NO SOUND (OR LOW SOUND LEVEL), RECEIVER INDICATES PROPER AUDIO MODULATION

- 1) Receiver output level set too low.
- 2) Receiver output disconnected, or cable defective or mis-wired.
- 3) Sound system or recorder input is turned down.

DISTORTED SOUND

- 1) Transmitter gain (audio level) is far too high. Check audio level LEDs and receiver audio levels during use.
- 2) Receiver output may be mismatched with the sound system or recorder input. Adjust output level on receiver to the correct level for the recorder, mixer or sound system. (Use the receiver's Tone function to check level.)
- 3) Transmitter is not set to same frequency as receiver. Check that operating frequency on receiver and transmitter match.
- 4) Receiver/Transmitter Compatibility mode mismatched.

EXCESSIVE FEEDBACK

- 1) Transmitter gain (audio level) too high. Check gain adjustment and/or reduce receiver output level.
- 2) Talent standing too close to speaker system.
- 3) Mic is too far from user's mouth.

SYMPTOM**POSSIBLE CAUSE****HISS AND NOISE -- AUDIBLE DROPOUTS**

- 1) Transmitter gain (audio level) far too low.
- 2) Receiver antenna missing or obstructed.
- 3) Transmitter antenna broken or missing.
- 4) Operating range too great.
- 5) Signal interference. Turn off transmitter. If receiver's signal strength indicator does not drop to nearly zero, this indicates an interfering signal may be the problem. Try a different operating frequency.

“Loc” APPEARS IN DISPLAY WHEN ANY BUTTON IS PRESSED

- 1) Control Panel is locked.
(See *Operating Instructions, Lock/Unlock the Keypad*)

“Hold” APPEARS IN DISPLAY WHEN ARROW BUTTONS ARE PRESSED

- 1) Reminder that it is necessary to hold down the AUDIO or FREQ button to make adjustments to the audio gain or frequency settings.

“PLL” APPEARS IN DISPLAY

- 1) Indication that the PLL is not locked. This is a serious condition that requires factory repair. It may be possible to operate on another frequency far removed from the one that was selected when the condition was indicated.

TRANSMITTER WON'T RESPOND TO REMOTE CONTROL

- 1) If LCD blinks “rc oFF”, transmitter has not been configured to respond to the remote control.
See **Down Arrow Settings** and **LectroRM**.
- 2) If LCD blinks “- - - - -”, transmitter is already set as requested by the remote control.
- 3) If transmitter does not respond at all, try moving the remote control closer to the microphone or increasing the remote control's loudness setting.
- 4) Make sure transmitter is not in Sleep mode.

Accessories and Replacement Parts

Spring Loaded Belt Clip

Model WMBCSL spring loaded belt clip. Includes hardware kit shown below.



Wire Belt Clip

Model WMBCWIRE includes hardware kit shown below.



Belt Clip Hardware Kit



Included with SL and WIRE type belt clips. Provides mounting of belt clips with either set screws using allen wrench, or thumb screws.

WPMC-3

Watertight connector kit, 3 piece, to terminate lavalier microphones for use with the WM transmitter.



WPMC-10

Watertight connector kit, 10 piece, to terminate lavalier microphones for use with the WM transmitter.



Replacement O-rings

Model ORINGKIT/WM Includes replacement O-rings for battery caps and microphone plug with WM style connector, and petroleum jelly pouch.



Separate parts:

P/N 35877 O-ring; .433" ID x .623" OD

P/N 35750 O-ring; .312" ID x .437" OD

P/N 32408 petroleum jelly pouch; 5 grams

Replacement battery caps

Model WMDESIKIT includes replacement battery caps, O-rings, lanyards, thumbscrew and allen wrench.

Includes moisture absorbing desiccant beads inside caps



See page 18 for details.

Straight Whip Antennas

This is a full size cutting template used to cut the length of the whip for a particular frequency. Lay the uncut antenna on top of this drawing and trim the whip length to the desired frequency.

After cutting the antenna to the desired length, mark the antenna by installing a color cap or sleeve to indicate the color listed in the table below

The supplied caps can be used several different ways:

- 1) A color cap on the end of the whip
- 2) A color sleeve next to the connector with a black cap on the end of the whip (trim the closed end of the colored cap off with scissors to make a sleeve).
- 3) A color sleeve and color cap (cut the cap in half with scissors).

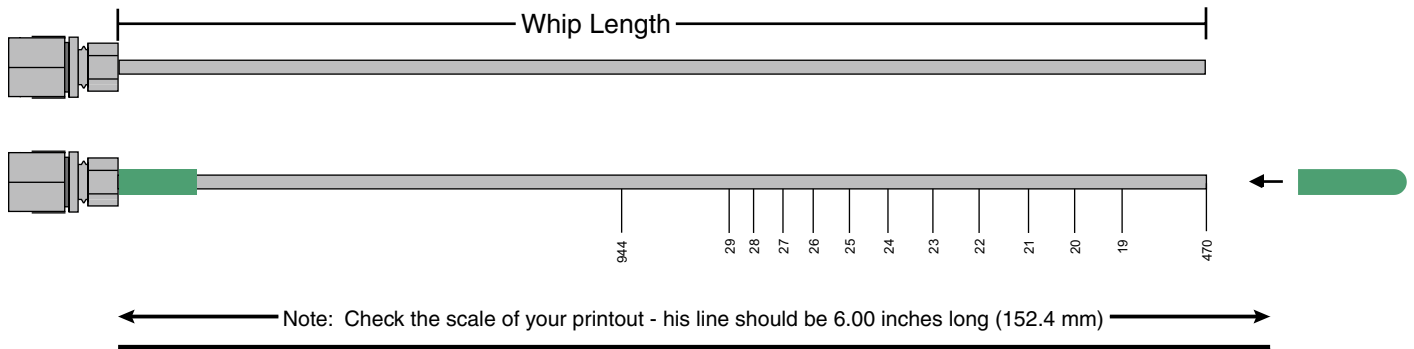

| BLOCK | FREQUENCY RANGE | CAP/SLEEVE COLOR | ANTENNA WHIP LENGTH |
|-------|-------------------|------------------|---------------------|
| 470 | 470.100 - 495.600 | Black w/ Label | 5.67" |
| 19 | 486.400 - 511.900 | Black w/ Label | 5.23" |
| 20 | 512.000 - 537.500 | Black w/ Label | 4.98" |
| 21 | 537.600 - 563.100 | Brown w/ Label | 4.74" |
| 22 | 563.200 - 588.700 | Red w/ Label | 4.48" |
| 23 | 588.800 - 607.950 | Orange w/ Label | 4.24" |

NOTE:

Not all Lectrosonics products are built on all of the blocks covered in this table.

Factory supplied antennas precut to length include a label with the frequency range. Label is not supplied with this kit.

Preventing Corrosion

Whenever the transmitter has been exposed to moisture or perspiration, follow the instructions below to minimize the risk of corrosion.

DRY THE UNIT BEFORE REMOVING THE MICROPHONE CONNECTOR OR BATTERY CAPS.

If the transmitter has been exposed to salt water, rinse it with fresh water and then dry the exterior of the transmitter thoroughly with a clean paper towel or cloth. Remove all moisture around the battery caps and microphone cable connector.

After removing the battery caps and microphone connector, wipe off any residual moisture around the battery compartment and microphone jack openings and on the battery caps and microphone connector.

The O-rings should be coated with Vaseline® or an equivalent petroleum jelly* before each use to ensure the seals are watertight.

DO NOT USE ANYTHING OTHER THAN PURE PETROLEUM JELLY TO LUBRICATE THE O-RINGS. Silicon-based lubricants will dissolve the O-rings.

Store the unit with no batteries installed, battery caps removed and the microphone disconnected to allow any buildup of humidity and moisture to evaporate.

Also see the section in the back of this manual entitled **Desiccant Battery Caps**.

Desiccant Battery Caps

Early WM transmitters were shipped with standard battery caps. Later engineering developed an updated battery cap design that contained moisture absorbing desiccant beads to protect the interior of the transmitter from excess humidity. These caps are available as a kit to update early WM transmitters, or to replace lost or damaged caps.

Beads are amber/orange in color when able to absorb moisture.



Beads are stored inside the cap to absorb moisture through the vent holes.

These battery doors on the WM will absorb small amounts of moisture and humidity from the inside of the transmitter. You must still be careful to keep moisture out of the WM by opening it only in dry or sheltered areas and by making sure the battery surfaces are dry before installing them. Always use the WP waterproof mic connector in wet conditions. The desiccant doors will only remove a few drops of moisture.

Battery Door Update

Early WM transmitters were supplied with standard battery door caps. The newer battery caps include a drying agent in a cavity to help absorb moisture inside the transmitter. The caps are available in a kit for updating older transmitters.



Kit consists of pre-assembled battery doors with thumbscrew and hex key (Allen wrench)

Remove old center screw with the supplied hex key (Allen wrench).



Install new battery caps and tighten the thumb screw **by hand**. The thumbscrew is removed to recondition (dry out) the desiccant beads.



Eventually, the desiccant beads absorb enough moisture that they will become ineffective and turn green or blue instead of the normally dry color of amber/orange. To recharge the desiccant, it must be heated to 200 to 400 degrees F for at least an hour, preferably more. The desiccant, the silicone O-ring seals and the doors can withstand maximum temperatures up to 400 degrees F (205 degrees C).

The doors can be put into an oven at 200 degrees F for several hours. As the heat drives out the absorbed moisture, the desiccant will turn back to its normal amber/orange color.

Do not put the WM transmitter itself into any oven or heating device.

After heating, particularly at higher temperatures, the O-rings will likely need a tiny dab of petroleum jelly (Vaseline*) to replace the lubricant that may migrate in the heat.

Re-conditioning (drying out) the caps and desiccant beads

An easy way to heat the doors is to use a coffee mug warmer, which typically costs about \$10. The surface temperature of about 220 degrees (F) will dry the doors and desiccant, but it will not disturb any light lubricant (like the **Vaseline** petroleum provided with the WM) that is on the O-ring seals.



It is also possible to use the mug warmer to dry out the doors without removing them from the case as shown below. **Do not place the transmitter on this heated surface.** Lay it to one side as shown.



The mug warmer used for testing consumed 17 watts, so it could even be used on a sound cart AC supply without being a huge drain on the batteries.

The color of the desiccant beads can be observed by shining a pen light on one edge of the battery cap to illuminate the desiccant. Ideally, they will be an amber/orange color at room temperature.

Replacing the desiccant beads

When the beads remain darker green or blue, they may not be absorbent any longer and should be replaced. Remove the screw that retains the spring and vented cover with a small Phillips screwdriver.



While the cap assembly is apart and the beads removed, the parts can be cleaned to remove dust and corrosion. The best way to clean the parts is with petroleum jelly (Vaseline). Apply the petroleum jelly and then wipe the parts clean.



Do not use a silicone based oil or grease as it will dissolve the O-rings.

Do not expose the desiccant beads to any cleaning liquids or other materials.

Replace the beads with new, amber colored ones. Fill the cavity to just below the top of the threaded stem that holds the cover in place so that the cavity is full, but the beads are not compressed when the vented cover is replaced.

The desiccant beads are silica gel grade 52, manufactured by a US Company named ADCOA under part number SG52002. Large containers can be purchased from ADCOA, and small quantities are available from Lectrosonics. Contact Lectrosonics for details.

*Vaseline is a registered trademark of Conopco, Inc.

Specifications

Operating frequencies:

| | |
|-----------|-------------------|
| Block 470 | 470.100 - 495.675 |
| Block 19 | 486.400 - 511.975 |
| Block 20 | 512.000 - 537.575 |
| Block 21 | 537.600 - 563.175 |
| Block 22 | 563.200 - 588.775 |
| Block 23a | 588.800 - 607.950 |

| | |
|--------------------------------|--|
| Channel Spacing: | 25 kHz or 100 kHz |
| Frequency selection: | Control panel mounted membrane switches |
| RF Power output: | Switchable; 50, 100 or 250 mW |
| Compatibility Modes (3) | Nu Hybrid, IFB, Mode 3 |
| Pilot tone: | 3.5 kHz deviation (Nu Hybrid) |
| Frequency stability: | ± 0.002% |
| Spurious radiation: | Compliant with ETSI EN 300 422-1 v1.4.2 |
| Equivalent input noise: | -125 dBV, A-weighted |
| Input level: | |
| Dynamic mic: | 0.5 mV to 50 mV before limiting. Greater than 1 V with limiting. |
| Electret lavalier mic: | 1.7 uA to 170 uA before limiting. Greater than 5000 uA (5 mA) with limiting. |
| Line level input: | 17 mV to 1.7 V before limiting. Greater than 5 V with limiting. |
| Input impedance: | |
| Dynamic mic: | 300 Ohms |
| Electret lavalier: | Input is virtual ground with servo adjusted constant current bias > 2.7 k Ohms |
| Line level: | > 2.7 k Ohms |
| Input limiter: | Soft limiter, 30 dB range |
| Bias voltages: | Selectable; 2V, 4V and Off |
| Gain control range: | 44 dB; panel mounted membrane switches |
| Modulation indicators: | Dual bicolor LEDs indicate modulation of -20, -10, 0, +10 dB referenced to full modulation |
| Controls: | Control panel with LCD and four membrane switches |



The recess in the battery compartment traps the O-ring for a tight seal.



AA battery compartments are O-ring sealed

Low frequency roll-off:

Adjustable from 35 to 150 Hz

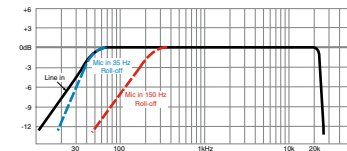

Audio Frequency Response:

35 Hz to 20 kHz, ±1 dB (The low frequency roll-off is adjustable - see graph above)

Signal to Noise Ratio (dB):

| SmartNR | No Limiting | w/Limiting |
|---------|-------------|------------|
| OFF | 103.5 | 108.0 |
| NORMAL | 107.0 | 111.5 |
| FULL | 108.5 | 113.0 |

(Note: the dual envelope "soft" limiter provides exceptionally good handling of transients using variable attack and release time constants. The gradual onset of limiting in the design begins below full modulation, which reduces the measured figure for SNR without limiting by 4.5 dB)

Total Harmonic Distortion:

0.2% typical (Nu Hybrid mode)

Audio Input Jack:

2.5 mm locking micro; threaded for stainless sleeve on WP connector

Antenna:

Flexible, unbreakable steel cable.

Batteries:

1.5 Volt AA (lithium recommended)

| Power Setting: | Battery Life: (HH:MM) |
|----------------|-----------------------|
| 50 mW (2 AA): | 13:00 |
| 100 mW (2 AA): | 10:45 |
| 250 mW (2 AA): | 5:45 |

Weight: 5.33 oz. (151 grams) with lithium batteries

Housing Dimensions: 2.98 x 2.55 x 0.77 inches
75.7 x 64.8 x 19.6 mm (including battery caps)

Emission Designator: 110KF3E

Specifications subject to change without notice.

Service and Repair

If your system malfunctions, you should attempt to correct or isolate the trouble before concluding that the equipment needs repair. Make sure you have followed the setup procedure and operating instructions. Check the inter-connecting cables and then go through the **Troubleshooting** section in this manual.

We strongly recommend that you **do not** try to repair the equipment yourself and **do not** have the local repair shop attempt anything other than the simplest repair. If the repair is more complicated than a broken wire or loose connection, send the unit to the factory for repair and service. Don't attempt to adjust any controls inside the units. Once set at the factory, the various controls and trimmers do not drift with age or vibration and never require readjustment. **There are no adjustments inside that will make a malfunctioning unit start working.**

LECTROSONICS' Service Department is equipped and staffed to quickly repair your equipment. In warranty repairs are made at no charge in accordance with the terms of the warranty. Out-of-warranty repairs are charged at a modest flat rate plus parts and shipping. Since it takes almost as much time and effort to determine what is wrong as it does to make the repair, there is a charge for an exact quotation. We will be happy to quote approximate charges by phone for out-of-warranty repairs.

Returning Units for Repair

For timely service, please follow the steps below:

- A.** DO NOT return equipment to the factory for repair without first contacting us by email or by phone. We need to know the nature of the problem, the model number and the serial number of the equipment. We also need a phone number where you can be reached 8 A.M. to 4 P.M. (U.S. Mountain Standard Time).
- B.** After receiving your request, we will issue you a return authorization number (R.A.). This number will help speed your repair through our receiving and repair departments. The return authorization number must be clearly shown on the **outside** of the shipping container.
- C.** Pack the equipment carefully and ship to us, shipping costs prepaid. If necessary, we can provide you with the proper packing materials. UPS is usually the best way to ship the units. Heavy units should be "double-boxed" for safe transport.
- D.** We also strongly recommend that you insure the equipment, since we cannot be responsible for loss of or damage to equipment that you ship. Of course, we insure the equipment when we ship it back to you.

Lectrosonics USA:

Mailing address:

Lectrosonics, Inc.
PO Box 15900
Rio Rancho, NM 87174
USA

Shipping address:

Lectrosonics, Inc.
561 Laser Rd. Ste. 102
Rio Rancho, NM 87124
USA

Telephone:

(505) 892-4501
(800) 821-1121 Toll-free
(505) 892-6243 Fax

Web:

www.lectrosonics.com

E-mail:

sales@lectrosonics.com

Lectrosonics Canada:

Mailing Address:

720 Spadina Avenue,
Suite 600
Toronto, Ontario M5S 2T9

Telephone:

(416) 596-2202
(877) 753-2876 Toll-free
(877-7LECTRO)
(416) 596-6648 Fax

E-mail:

Sales: colinb@lectrosonics.com
Service: joeb@lectrosonics.com

LIMITED ONE YEAR WARRANTY

The equipment is warranted for one year from date of purchase against defects in materials or workmanship provided it was purchased from an authorized dealer. This warranty does not cover equipment which has been abused or damaged by careless handling or shipping. This warranty does not apply to used or demonstrator equipment.

Should any defect develop, Lectrosonics, Inc. will, at our option, repair or replace any defective parts without charge for either parts or labor. If Lectrosonics, Inc. cannot correct the defect in your equipment, it will be replaced at no charge with a similar new item. Lectrosonics, Inc. will pay for the cost of returning your equipment to you.

This warranty applies only to items returned to Lectrosonics, Inc. or an authorized dealer, shipping costs prepaid, within one year from the date of purchase.

This Limited Warranty is governed by the laws of the State of New Mexico. It states the entire liability of Lectrosonics Inc. and the entire remedy of the purchaser for any breach of warranty as outlined above. **NEITHER LECTROSONICS, INC. NOR ANYONE INVOLVED IN THE PRODUCTION OR DELIVERY OF THE EQUIPMENT SHALL BE LIABLE FOR ANY INDIRECT, SPECIAL, PUNITIVE, CONSEQUENTIAL, OR INCIDENTAL DAMAGES ARISING OUT OF THE USE OR INABILITY TO USE THIS EQUIPMENT EVEN IF LECTROSONICS, INC. HAS BEEN ADVISED OF THE POSSIBILITY OF SUCH DAMAGES. IN NO EVENT SHALL THE LIABILITY OF LECTROSONICS, INC. EXCEED THE PURCHASE PRICE OF ANY DEFECTIVE EQUIPMENT.**

This warranty gives you specific legal rights. You may have additional legal rights which vary from state to state.

