





FCC PART 74, SUBPART H TEST AND MEASUREMENT REPORT

For

Lectrosonics, Inc.

581 Laser Road NE, Rio Rancho, NM 87124, USA

FCC ID: DBZSSMA1A

Report Type: Original Report	Product Type: Wireless Microphone Transmitter
Prepared By: Vincent Licata Test Engineer	
Report Number: R1808219-74	
Report Date: 2018-10-03	
Reviewed By: Xiao Lin RF Engineer	
Test Laboratory: Bay Area Compliance Laboratories Corp. 1274 Anvilwood Avenue, Sunnyvale, CA 94089, USA Tel: (408) 732-9162 Fax: (408) 732 9164	

Note: This test report is prepared for the customer shown above and for the device described herein. It may not be duplicated or used in part without prior written consent from Bay Area Compliance Laboratories Corp. This report must not be used by the customer to claim product certification, approval, or endorsement by A2LA* or any agency of the Federal Government. * This report may contain data that are not covered by the A2LA accreditation and are marked with an asterisk "*" (Rev.3)

TABLE OF CONTENTS

1	GENERAL DESCRIPTION	5
1.1	PRODUCT DESCRIPTION FOR EQUIPMENT UNDER TEST (EUT)	5
1.2	MECHANICAL DESCRIPTION OF EUT	5
1.3	OBJECTIVE.....	5
1.4	RELATED SUBMITTAL(S)/GRANT(S).....	5
1.5	TEST METHODOLOGY	5
1.6	MEASUREMENT UNCERTAINTY.....	6
1.7	TEST FACILITY REGISTRATIONS	6
1.8	TEST FACILITY ACCREDITATIONS.....	6
2	EUT TEST CONFIGURATION.....	9
2.1	JUSTIFICATION.....	9
2.2	EUT EXERCISE SOFTWARE.....	9
2.3	SPECIAL EQUIPMENT	9
2.4	EQUIPMENT MODIFICATIONS	9
2.5	LOCAL SUPPORT EQUIPMENT.....	9
2.6	INTERFACE PORTS AND CABLES	9
3	SUMMARY OF TEST RESULTS.....	10
4	FCC §2.1093 - RF EXPOSURE	11
5	FCC §74.861(E) (1) - RF OUTPUT POWER	12
5.1	APPLICABLE STANDARDS	12
5.2	TEST PROCEDURE	12
5.3	TEST EQUIPMENT LIST AND DETAILS	12
5.4	TEST ENVIRONMENTAL CONDITIONS.....	12
5.5	TEST RESULTS	13
6	FCC §74.861(E) (5) (7) - OCCUPIED BANDWIDTH & EMISSION MASK.....	17
6.1	APPLICABLE STANDARDS	17
6.2	TEST PROCEDURE	17
6.3	TEST EQUIPMENT LIST AND DETAILS	17
6.4	TEST ENVIRONMENTAL CONDITIONS.....	18
6.5	TEST RESULTS	18
7	FCC §74.861(E) (7) - CONDUCTED SPURIOUS EMISSIONS AT ANTENNA PORT	22
7.1	APPLICABLE STANDARDS	22
7.2	TEST PROCEDURE	22
7.3	TEST EQUIPMENT LIST AND DETAILS	22
7.4	TEST ENVIRONMENTAL CONDITIONS.....	23
7.5	TEST RESULTS	23
8	FCC §74.861(E) (7) - FIELD STRENGTH OF SPURIOUS RADIATION	25
8.1	APPLICABLE STANDARDS	25
8.2	TEST PROCEDURE	25
8.3	TEST EQUIPMENT LIST AND DETAILS	25
8.4	TEST ENVIRONMENTAL CONDITIONS.....	26
8.5	TEST RESULTS	26
9	FCC §74.861(E) (4) - FREQUENCY STABILITY.....	27
9.1	APPLICABLE STANDARDS	27
9.2	TEST PROCEDURE	27

9.3 TEST EQUIPMENT LIST AND DETAILS28

9.4 TEST ENVIRONMENTAL CONDITIONS28

9.5 TEST RESULTS29

10 FCC §74.861(E) (3) - MODULATION CHARACTERISTIC.....30

10.1 APPLICABLE STANDARDS30

10.2 TEST PROCEDURE30

10.3 TEST EQUIPMENT LIST AND DETAILS31

10.4 TEST ENVIRONMENTAL CONDITIONS31

10.5 TEST RESULTS32

11 APPENDIX A - FCC EQUIPMENT LABELING REQUIREMENTS.....35

11.1 FCC ID LABEL REQUIREMENTS.....35

11.2 LABEL CONTENTS AND LOCATION.....36

12 APPENDIX B - EUT PHOTOGRAPHS37

13 APPENDIX C (NORMATIVE) - A2LA ELECTRICAL TESTING CERTIFICATE38

DOCUMENT REVISION HISTORY

Revision Number	Report Number	Description of Revision	Date of Revision
0	R1808219-74	Original Report	2018-10-03

1 General Description

1.1 Product Description for Equipment Under Test (EUT)

This test and measurement report has been compiled on behalf of *Lectrosonics, Inc.* and their product model: *SSM-A1, FCC ID: DBZSSMA1A*, which henceforth is referred to as the EUT (Equipment Under Test). The EUT is a wireless microphone transmitter. The EUT operates in the frequency range: 470.1 to 537.575 MHz.

1.2 Mechanical Description of EUT

The SSM-A1 (EUT) measures approximately 5.84 cm (L) x 3.80 cm (W) x 1.42 cm (H) and weighs approximately 0.065 kg with rechargeable battery.

The data gathered are from a typical production sample provided by the Lectrosonics, Inc. with serial number: 2415

1.3 Objective

The following type approved report is prepared on behalf of *Lectrosonics, Inc.* in accordance with Part 74, Subparts H of the Federal Communications Commission rules.

The objective is to determine compliance with Part 74 of the FCC Rules, limits for RF output power, Modulation characteristics, Emission bandwidth, Field strength of spurious radiation and Frequency stability for license-exempt, low-power radio apparatus operating in the television bands.

1.4 Related Submittal(s)/Grant(s)

N/A

1.5 Test Methodology

All measurements contained in this report were conducted in accordance with ANSI/TIA-603-E-2016, FCC KDB 971168 D01 Power Meas License Digital Systems v03r01, and EN 300 422-1 v1.4.2 Electromagnetic compatibility and Radio Spectrum Matters; Wireless microphones in the 25MHz to 3GHz frequency range.

All tests were performed at Bay Area Compliance Laboratories Corp.

1.6 Measurement Uncertainty

All measurements involve certain levels of uncertainties, especially in the field of EMC. The factors contributing to uncertainties are spectrum analyzer, cable loss, antenna factor calibration, antenna directivity, antenna factor variation with height, antenna phase center variation, antenna factor frequency interpolation, measurement distance variation, site imperfections, mismatch (average), and system repeatability.

Based on CISPR16-4-2:2011, The Treatment of Uncertainty in EMC Measurements, the values ranging from ± 2.0 dB for Conducted Emissions tests and ± 4.0 dB for Radiated Emissions tests are the most accurate estimates pertaining to uncertainty of EMC measurements at BACL Corp.

1.7 Test Facility Registrations

BACLs test facilities that are used to perform Radiated and Conducted Emissions tests are currently recognized by the Federal Communications Commission as Accredited with NIST Designation Number US1129.

BACL's test facilities that are used to perform Radiated and Conducted Emissions tests are currently registered with Innovation, Science and Economic development Canada under Registration Numbers: 3062A-1, 3062A-2, and 3062A-3.

BACL is a Chinese Taipei Bureau of Standards Metrology and Inspection (BSMI) validated Conformity Assessment Body (CAB), under Appendix B, Phase I Procedures of the APEC Mutual Recognition Arrangement (MRA). BACL's BSMI Lab Code Number is: SL2-IN-E-1002R

BACL's test facilities that are used to perform AC Line Conducted Emissions, Telecommunications Line Conducted Emissions, Radiated Emissions from 30 MHz to 1 GHz, and Radiated Emissions from 1 GHz to 6 GHz are currently recognized as Accredited in accordance with the Voluntary Control Council for Interference [VCCI] Article 15 procedures under Registration Number A-0027.

1.8 Test Facility Accreditations

Bay Area Compliance Laboratories Corp. (BACL) is:

A- An independent, 3rd-Party, Commercial Test Laboratory accredited to ISO/IEC 17025:2005 by A2LA (Test Laboratory Accreditation Certificate Number 3279.02), in the fields of: Electromagnetic Compatibility and Telecommunications. Unless noted by an Asterisk (*) in the Compliance Matrix (See Section 3 of this Test Report), BACL's ISO/IEC 17025:2005 Scope of Accreditation includes all of the Test Method Standards and/or the Product Family Standards detailed in this Test Report..

BACL's ISO/IEC 17025:2005 Scope of Accreditation includes a comprehensive suite of EMC Emissions, EMC Immunity, Radio, RF Exposure, Safety and wireline Telecommunications test methods applicable to a wide range of product categories. These product categories include Central Office Telecommunications Equipment [including NEBS - Network Equipment Building Systems], Unlicensed and Licensed Wireless and RF devices, Information Technology Equipment (ITE); Telecommunications Terminal Equipment (TTE); Medical Electrical Equipment; Industrial, Scientific and Medical Test Equipment; Professional Audio and Video Equipment; Industrial and Scientific Instruments and Laboratory Apparatus; Cable Distribution Systems, and Energy Efficient Lighting.

B- A Product Certification Body accredited to ISO/IEC 17065:2012 by A2LA (Product Certification Body

-- For the USA (Federal Communications Commission):

- 1- All Unlicensed radio frequency devices within FCC Scopes A1, A2, A3, and A4;
- 2- All Licensed radio frequency devices within FCC Scopes B1, B2, B3, and B4;

- 3- All Telephone Terminal Equipment within FCC Scope C.
- For the Canada (Innovation, Science and Economic development Canada):
 - 1- All Scope 1-Licence-Exempt Radio Frequency Devices;
 - 2- All Scope 2-Licensed Personal Mobile Radio Services;
 - 3- All Scope 3-Licensed General Mobile & Fixed Radio Services;
 - 4- All Scope 4-Licensed Maritime & Aviation Radio Services;
 - 5- All Scope 5-Licensed Fixed Microwave Radio Services
 - 6- All Broadcasting Technical Standards (BETS) in the Category I Equipment Standards List.
- For Singapore (Infocomm Media Development Authority - IMDA):
 - 1 All Line Terminal Equipment: All Technical Specifications for Line Terminal Equipment – Table 1 of IMDA MRA Recognition Scheme: 2011, Annex 2
 - 2. All Radio-Communication Equipment: All Technical Specifications for Radio-Communication Equipment – Table 2 of IMDA MRA Recognition Scheme: 2011, Annex 2
- For the Hong Kong Special Administrative Region:
 - 1 All Radio Equipment, per KHCA 10XX-series Specifications;
 - 2 All GMDSS Marine Radio Equipment, per HKCA 12XX-series Specifications;
 - 3 All Fixed Network Equipment, per HKCA 20XX-series Specifications.
- For Japan:
 - 1 MIC Telecommunication Business Law (Terminal Equipment):
 - All Scope A1 - Terminal Equipment for the Purpose of Calls;
 - All Scope A2 - Other Terminal Equipment
 - 2 Radio Law (Radio Equipment):
 - All Scope B1 - Specified Radio Equipment specified in Article 38-2-2, paragraph 1, item 1 of the Radio Law
 - All Scope B2 - Specified Radio Equipment specified in Article 38-2-2, paragraph 1, item 2 of the Radio Law
 - All Scope B3 - Specified Radio Equipment specified in Article 38-2-2, paragraph 1, item 3 of the Radio Law

C- A Product Certification Body accredited to ISO/IEC 17065:2012 by A2LA (Product Certification Body Accreditation Certificate Number 3279.01) to certify Products to USA's Environmental Protection Agency (EPA) ENERGY STAR Product Specifications for:

- 1 Electronics and Office Equipment:
 - for Telephony (ver. 3.0)
 - for Audio/Video (ver. 3.0)
 - for Battery Charging Systems (ver. 1.1)
 - for Set-top Boxes & Cable Boxes (ver. 4.1)
 - for Televisions (ver. 6.1)
 - for Computers (ver. 6.0)
 - for Displays (ver. 6.0)
 - for Imaging Equipment (ver. 2.0)
 - for Computer Servers (ver. 2.0)
- 2 Commercial Food Service Equipment
 - for Commercial Dishwashers (ver. 2.0)
 - for Commercial Ice Machines (ver. 2.0)
 - for Commercial Ovens (ver. 2.1)
 - for Commercial Refrigerators and Freezers
- 3 Lighting Products
 - For Decorative Light Strings (ver. 1.5)
 - For Luminaires (including sub-components) and Lamps (ver. 1.2)
 - For Compact Fluorescent Lamps (CFLs) (ver. 4.3)

- For Integral LED Lamps (ver. 1.4)
- 4 Heating, Ventilation, and AC Products
 - for Residential Ceiling Fans (ver. 3.0)
 - for Residential Ventilating Fans (ver. 3.2)
- 5 Other
 - For Water Coolers (ver. 3.0)

D. A NIST Designated Phase-I and Phase-II Conformity Assessment Body (CAB) for the following economies and regulatory authorities under the terms of the stated MRAs/Treaties:

- Australia: ACMA (Australian Communication and Media Authority) – APEC Tel MRA -Phase I;
- Canada: (Innovation, Science and Economic development Canada - ISEDC) Foreign Certification Body – FCB – APEC Tel MRA -Phase I & Phase II;
- Chinese Taipei (Republic of China – Taiwan):
 - o BSMI (Bureau of Standards, Metrology and Inspection) APEC Tel MRA -Phase I;
 - o NCC (National Communications Commission) APEC Tel MRA -Phase I;
- European Union:
 - o EMC Directive 2014/30/EU US-EU EMC & Telecom MRA CAB (NB)
 - o Radio Equipment (RE) Directive 2014/53/EU US-EU EMC & Telecom MRA CAB (NB)
 - o Low Voltage Directive (LVD) 2014/35/EU
- Hong Kong Special Administrative Region: (Office of the Telecommunications Authority – OFTA) APEC Tel MRA -Phase I & Phase II
- Israel – US-Israel MRA Phase I
- Republic of Korea (Ministry of Communications - Radio Research Laboratory) APEC Tel MRA -Phase I
- Singapore: (Infocomm Media Development Authority - IMDA) APEC Tel MRA -Phase I & Phase II;
- Japan: VCCI - Voluntary Control Council for Interference US-Japan Telecom Treaty VCCI Side Letter
- USA:
 - o ENERGY STAR Recognized Test Laboratory – US EPA
 - o Telecommunications Certification Body (TCB) – US FCC;
 - o Nationally Recognized Test Laboratory (NRTL) – US OSHA
- Vietnam: APEC Tel MRA -Phase I

2 EUT Test Configuration

2.1 Justification

The EUT was configured for testing according to ANSI/TIA-603-E-2016 and KDB 971168 D01 v03r01.

2.2 EUT Exercise Software

None

2.3 Special Equipment

There were no special accessories were required, included, or intended for use with EUT during these tests.

2.4 Equipment Modifications

A SMA connector was made available at the antenna port for conducted testing.

2.5 Local Support Equipment

None

2.6 Interface Ports and Cables

Manufacturer	Model Number	Cable Description	Length (m)	From	To
Lectrosonics	MC41	Microphone Adapter XLR with Cable	<1	Audio Signal Generator	EUT

3 Summary of Test Results

FCC Rules	Descriptions of Test	Result (s)
FCC §2.1093	RF exposure	Compliant ¹
FCC §74.861(e)(1)	RF output power	Compliant
FCC §74.861(e)(3)	Modulation characteristics	Compliant
FCC §74.861(e)(5)(7)	Operating bandwidth & Emission mask	Compliant
FCC §74.861(e)(7)	Spurious emissions at the antenna port	Compliant
FCC §74.861(e)(7)	Field strength of spurious emissions	Compliant
FCC §74.861(e)(4)	Frequency Tolerance	Compliant

Note¹: Please refer to report R1808219-SAR

4 FCC §2.1093 - RF Exposure

Please refer to report R1808219-SAR for results.

5 FCC §74.861(e) (1) - RF Output Power

5.1 Applicable Standards

According to FCC §74.861 (e) (1): the power may not exceed the following values:

- (i) 54-72, 76-88, and 174-216 MHz bands—50 mW EIRP
- (ii) 470-608 and 614-698 MHz bands—250 mW Conducted power
- (iii) 600 MHz duplex gap: 20 mW EIRP

5.2 Test Procedure

KDB 971168 D01 v03r01

5.3 Test Equipment List and Details

Manufacturer	Description	Model	Serial Number	Calibration Date	Calibration Interval
Agilent	Spectrum Analyzer	E4446A	MY48250238	2018-05-08	1 year
-	20dB attenuator	-	-	Each time ¹	N/A

Note¹: attenuator included in the test set-up will be checked each time before testing.

Statement of Traceability: *BACL Corp.* attests that all of the calibrations on the equipment items listed above were traceable to NIST or to another internationally recognized National Metrology Institute (NMI), and were compliant with A2LA Policy P102 (dated 09 June 2016) "A2LA Policy on Metrological Traceability".

5.4 Test Environmental Conditions

Temperature:	22 °C
Relative Humidity:	45 %
ATM Pressure:	101.2 kPa

The testing was performed by Vincent Licata on 2018-09-07 at RF site.

5.5 Test Results

Channel	Frequency (MHz)	Conducted Output Power (dBm)	Limits (dBm)	Rated Power (mW/dBm)
Low	470.1	16.90	24	50/17
		13.51	24	25/14
Middle	503.85	16.66	24	50/17
		13.53	24	25/14
High	537.575	17.12	24	50/17
		13.99	24	25/14

SSM-A1 470.1 MHz 50 mW Output Power

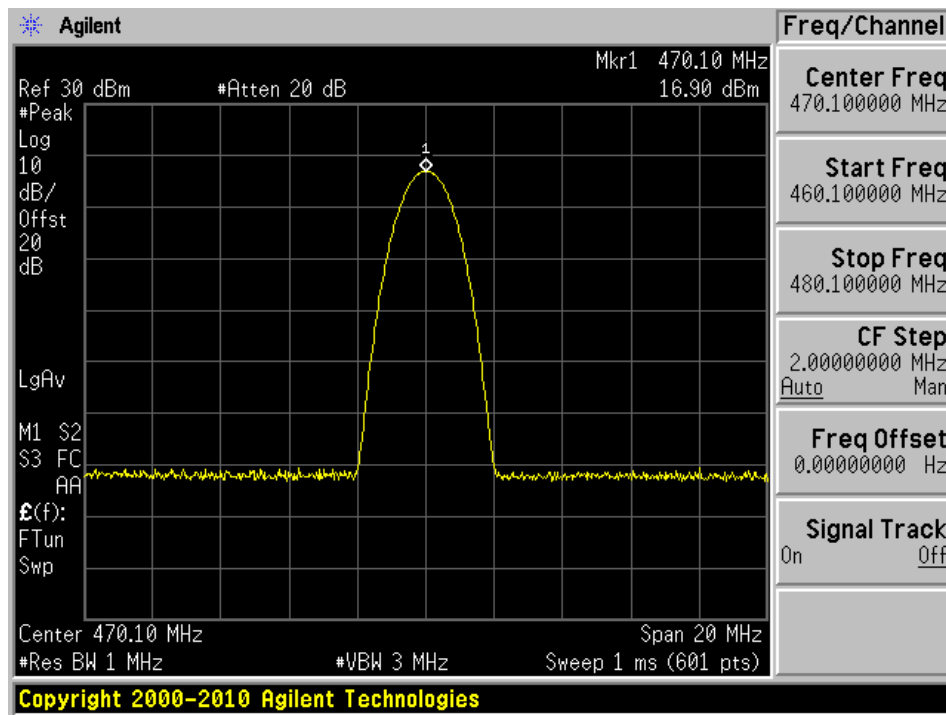

SSM-A1 503.85 MHz 50 mW Output Power

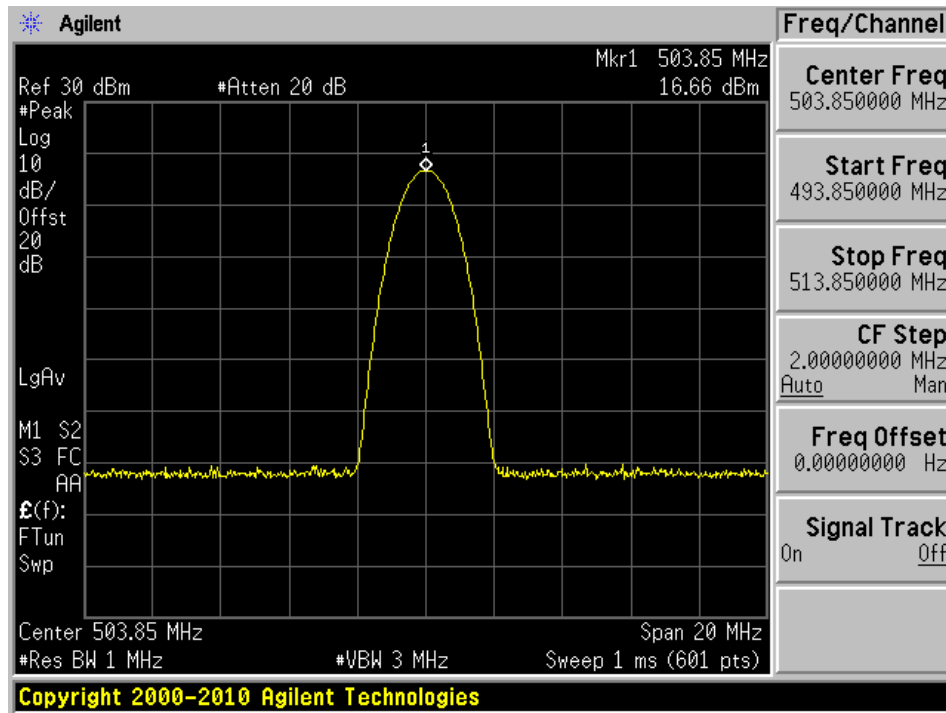

SSM-A1 537.575 MHz 50 mW Output Power

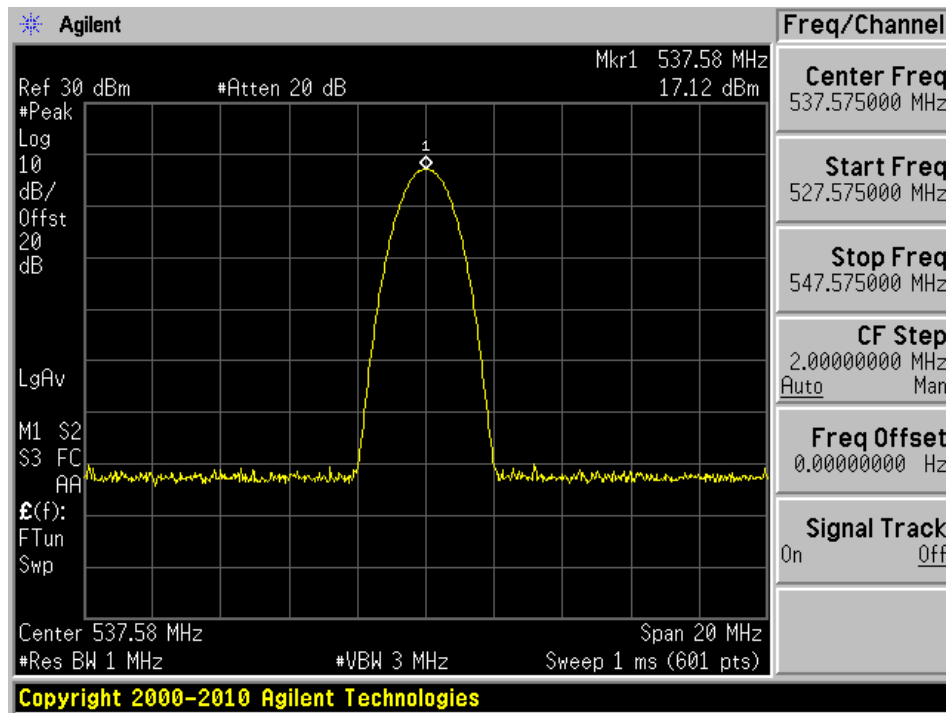

SSM-A1 470.1 MHz 25 mW Output Power

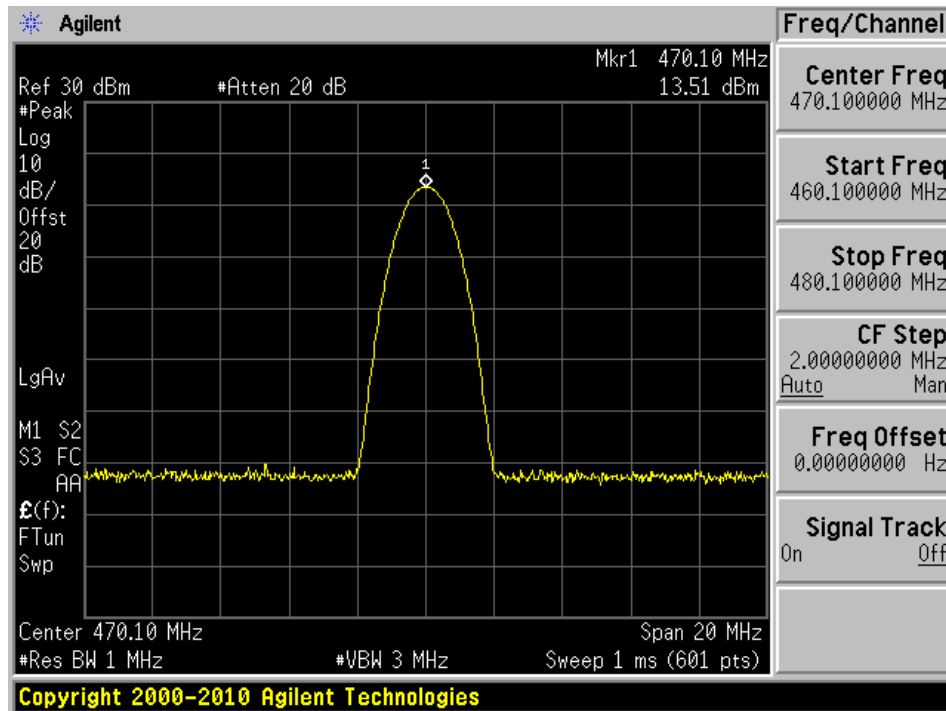

SSM-A1 503.85 MHz 25 mW Output Power

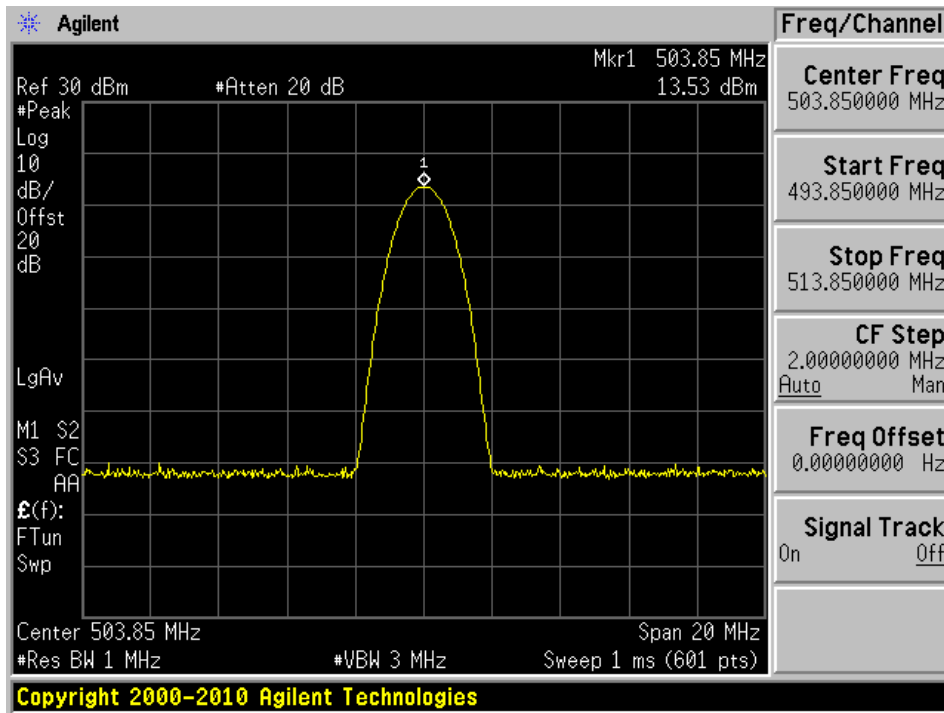

SSM-A1 537.575 MHz 25 mW Output Power

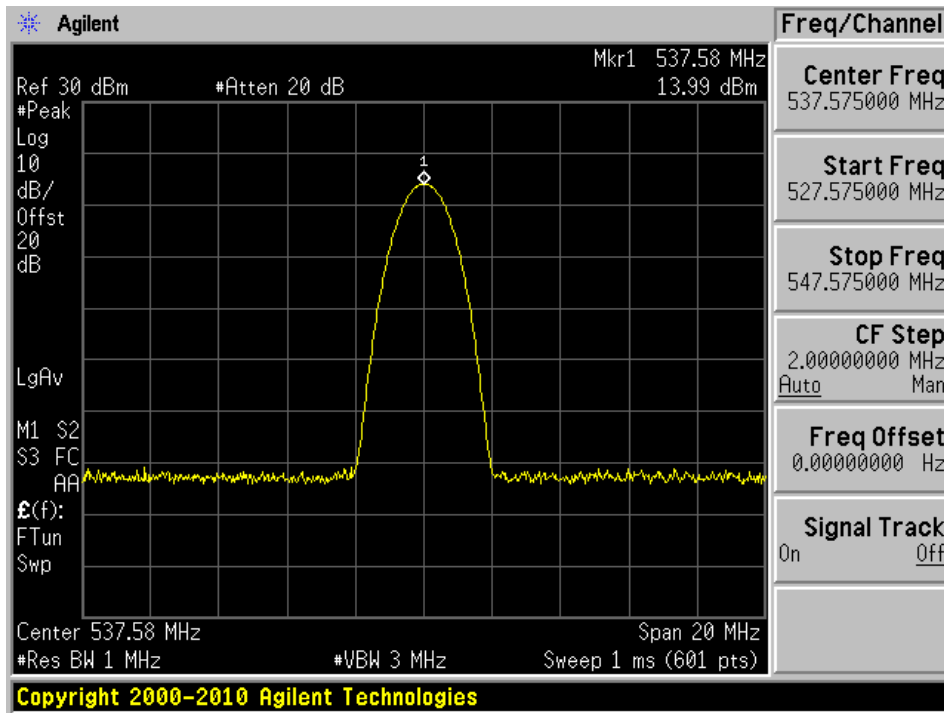

6 FCC §74.861(e) (5) (7) - Occupied Bandwidth & Emission Mask

6.1 Applicable Standards

According to FCC §74.861 (e) (5) (7):

The operating bandwidth shall not exceed 200 kHz.

Analog emissions within the band from one megahertz below to one megahertz above the carrier frequency shall comply with the emission mask in section 8.3.1.2 of the European Telecommunications Institute Standard ETSI EN 300 422-1 v1.4.2 (2011-08), Electromagnetic compatibility and Radio spectrum Matters (ERM); Wireless microphones in the 25 MHz to 3 GHz frequency range; part 1: Technical characteristics and methods of measurement. Digital emissions within the band from one megahertz below to one megahertz above the carrier frequency shall comply with the emission mask in section 8.3.2.2 (Figure 4) of the European Telecommunications Institute Standard ETSI EN 300 422-1 v1.4.2 (2011-08), Electromagnetic compatibility and Radio spectrum Matters (ERM); Wireless microphones in the 25 MHz to 3 GHz frequency range; part 1: Technical characteristics and methods of measurement. Beyond one megahertz below and above the carrier frequency, emissions shall comply with the limits specified in section 8.4 of ETSI EN 300 422-1 v1.4.2 (2011-08). The requirements of this paragraph (e)(7) shall not apply to applications for certification of equipment in these bands until nine months after release of the Commission's Channel Reassignment Public Notice, as defined in §73.3700(a)(2) of this chapter.

6.2 Test Procedure

The OBW is according to KDB 971168 D01 v03r01

The Emission mask is according to sections 8.3 of ETSI EN 300 422-1 V1.4.2 (2011-08).

6.3 Test Equipment List and Details

Manufacturer	Description	Model	Serial Number	Calibration Date	Calibration Interval
Rohde & Schwarz	Spectrum Analyzer	FSQ26	200749	2017-06-08	2 years
HP	RF Communications Test Set	8920A	3438A05338	2018-01-09	2 years
HP	Modulation Analyzer	8901A	2026A00847	2018-01-06	2 years
Krohn-Hite	Active Dual Channel Filter	3940	3212	2017-09-06	13 months
Agilent	Function Generator	33220A	MY43004878	2018-01-09	1 year
HP	TIMS	4934A	3737U15141	2018-01-09	1 year
-	20dB attenuator	-	-	Each time ¹	N/A

Note¹: attenuator included in the test set-up will be checked each time before testing.

Statement of Traceability: *BACL Corp.* attests that all of the calibrations on the equipment items listed above were traceable to NIST or to another internationally recognized National Metrology Institute (NMI), and were compliant with A2LA Policy P102 (dated 09 June 2016) "A2LA Policy on Metrological Traceability".

6.4 Test Environmental Conditions

Temperature:	22 °C
Relative Humidity:	45 %
ATM Pressure:	101.2 kPa

The testing was performed by Vincent Licata on 2018-09-21 and 2018-09-25 at RF site.

6.5 Test Results

Center Frequency (MHz)	99% Bandwidth (kHz)	Limit (kHz)	Result	Power Setting
503.85	59.6154	200	Pass	High (50 mW)
503.85	59.6154	200	Pass	Low (25 mW)

Please refer to the following plots for detailed test results

SSM-A1 50 mW OBW

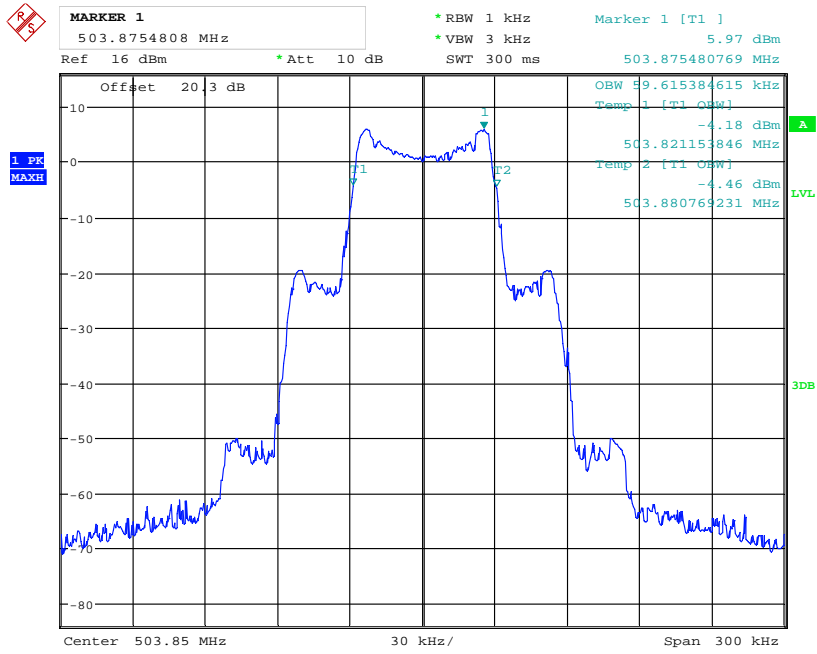

Date: 25.SEP.2018 09:03:08

SSM-A1 25 mW OBW

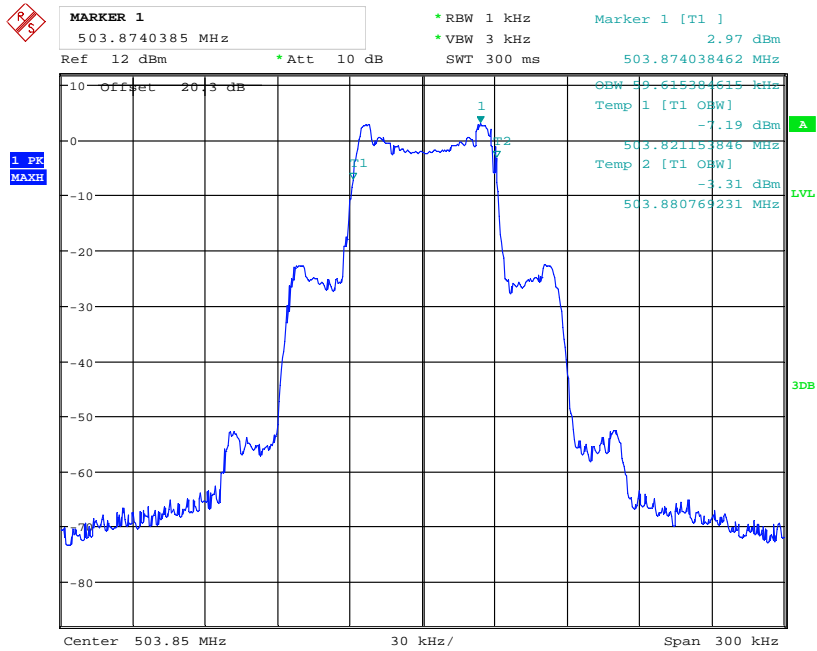

Date: 25.SEP.2018 09:02:21

SSM-A1 50 mW Reference Level

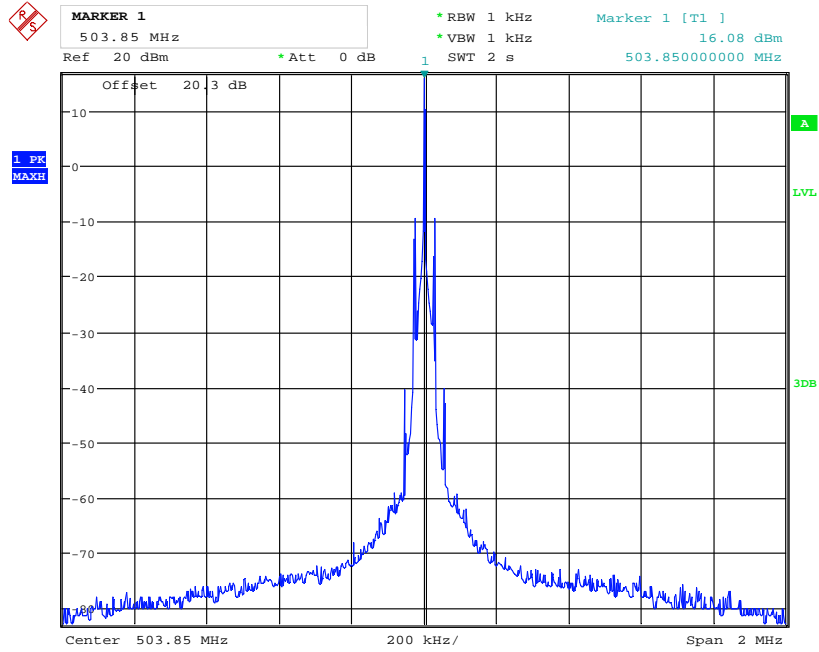

Date: 21.SEP.2018 14:39:07

SSM-A1 50 mW Emission Mask

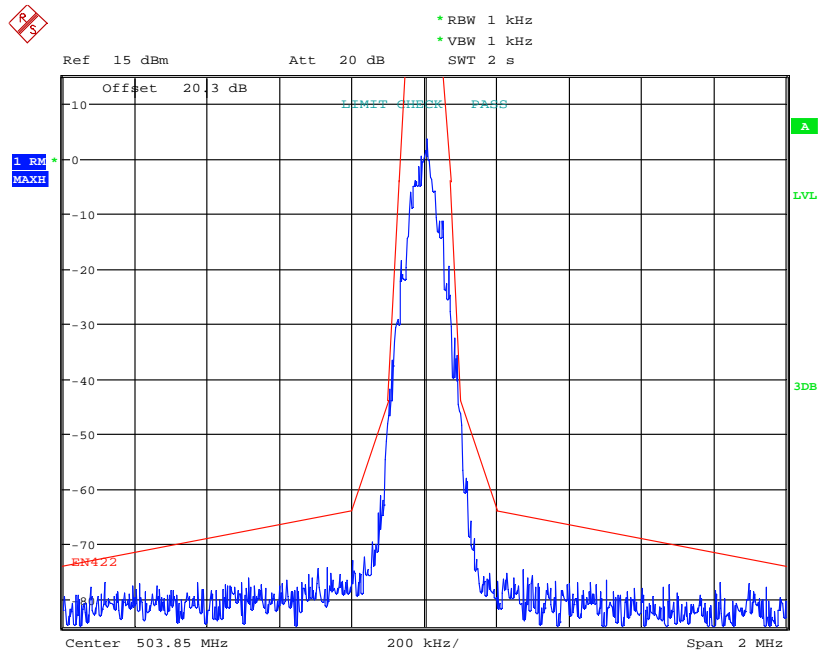

Date: 27.SEP.2018 17:12:13

SSM-A1 25 mW Reference Level

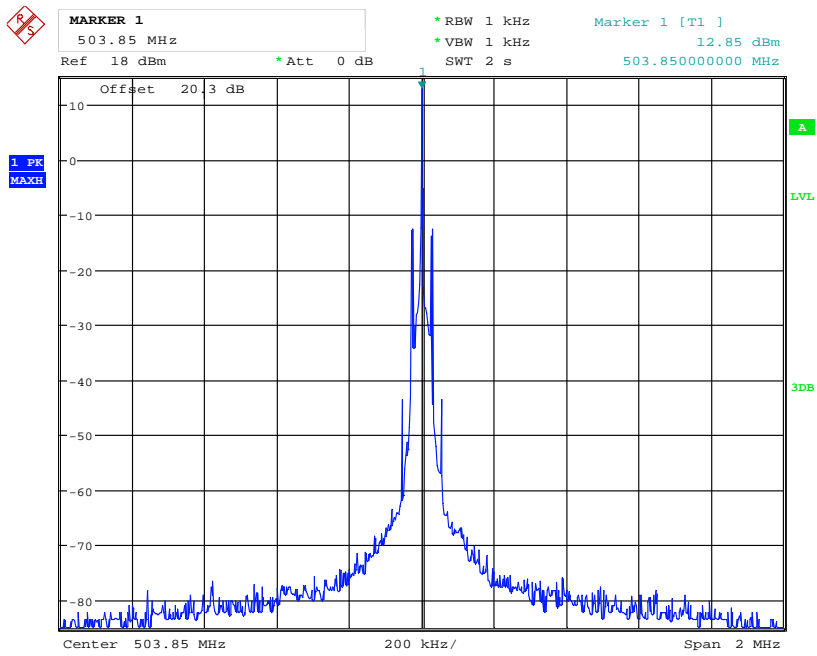

Date: 21.SEP.2018 14:46:54

SSM-A1 25 mW Emission Mask

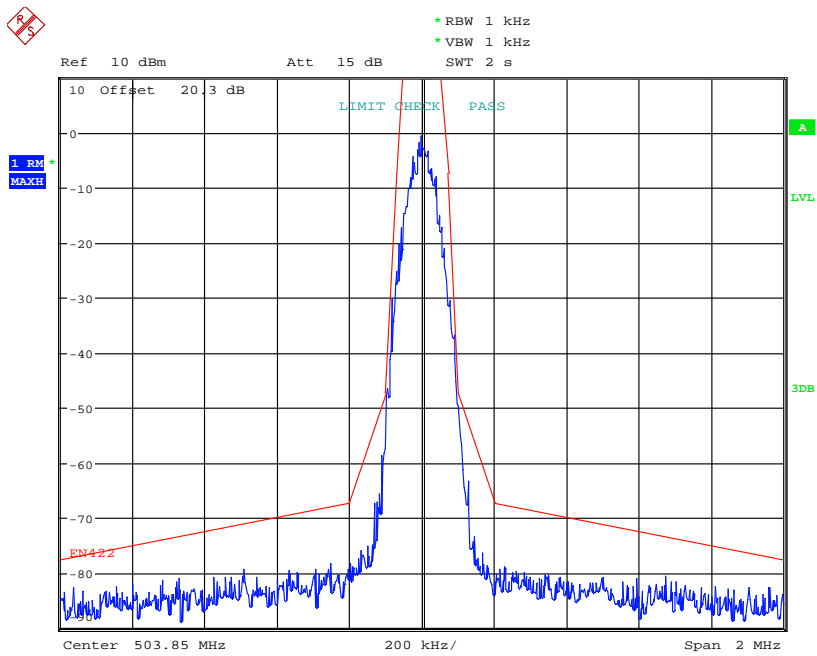

Date: 27.SEP.2018 17:16:05

7 FCC §74.861(e) (7) - Conducted Spurious Emissions at Antenna Port

7.1 Applicable Standards

According to FCC §74.861 (e) (7):

Analog emissions within the band from one megahertz below to one megahertz above the carrier frequency shall comply with the emission mask in section 8.3.1.2 of the European Telecommunications Institute Standard ETSI EN 300 422-1 v1.4.2 (2011-08), Electromagnetic compatibility and Radio spectrum Matters (ERM); Wireless microphones in the 25 MHz to 3 GHz frequency range; part 1: Technical characteristics and methods of measurement. Digital emissions within the band from one megahertz below to one megahertz above the carrier frequency shall comply with the emission mask in section 8.3.2.2 (Figure 4) of the European Telecommunications Institute Standard ETSI EN 300 422-1 v1.4.2 (2011-08), Electromagnetic compatibility and Radio spectrum Matters (ERM); Wireless microphones in the 25 MHz to 3 GHz frequency range; part 1: Technical characteristics and methods of measurement. Beyond one megahertz below and above the carrier frequency, emissions shall comply with the limits specified in section 8.4 of ETSI EN 300 422-1 v1.4.2 (2011-08). The requirements of this paragraph (e)(7) shall not apply to applications for certification of equipment in these bands until nine months after release of the Commission's Channel Reassignment Public Notice, as defined in §73.3700(a)(2) of this chapter.

7.2 Test Procedure

KDB 971168 D01 v03r01 and ETSI EN 300 422-1 V1.4.2 (2011-08).

7.3 Test Equipment List and Details

Manufacturer	Description	Model	Serial Number	Calibration Date	Calibration Interval
Agilent	Spectrum Analyzer	E4446A	MY48250238	2018-05-08	1 year
-	20dB attenuator	-	-	Each time ¹	N/A

Note¹: attenuator included in the test set-up will be checked each time before testing.

Statement of Traceability: BACL Corp. attests that all of the calibrations on the equipment items listed above were traceable to NIST or to another internationally recognized National Metrology Institute (NMI), and were compliant with A2LA Policy P102 (dated 09 June 2016) "A2LA Policy on Metrological Traceability".

7.4 Test Environmental Conditions

Temperature:	22 °C
Relative Humidity:	45 %
ATM Pressure:	101.2 kPa

The testing was performed by Vincent Licata on 2018-09-06 at RF site.

7.5 Test Results

Please refer to the following table plots for detailed test results, testing was done at the highest power setting and limits from ETSI EN 300 422-1 v1.4.2 (2011-08), Electromagnetic compatibility and radio spectrum matters (ERM); Wireless microphones in the 25 MHz to 3 GHz frequency range; Part 1: Technical characteristics and methods of measurement were used for worst case limits.

SSM-A1 503.85 MHz SE_1

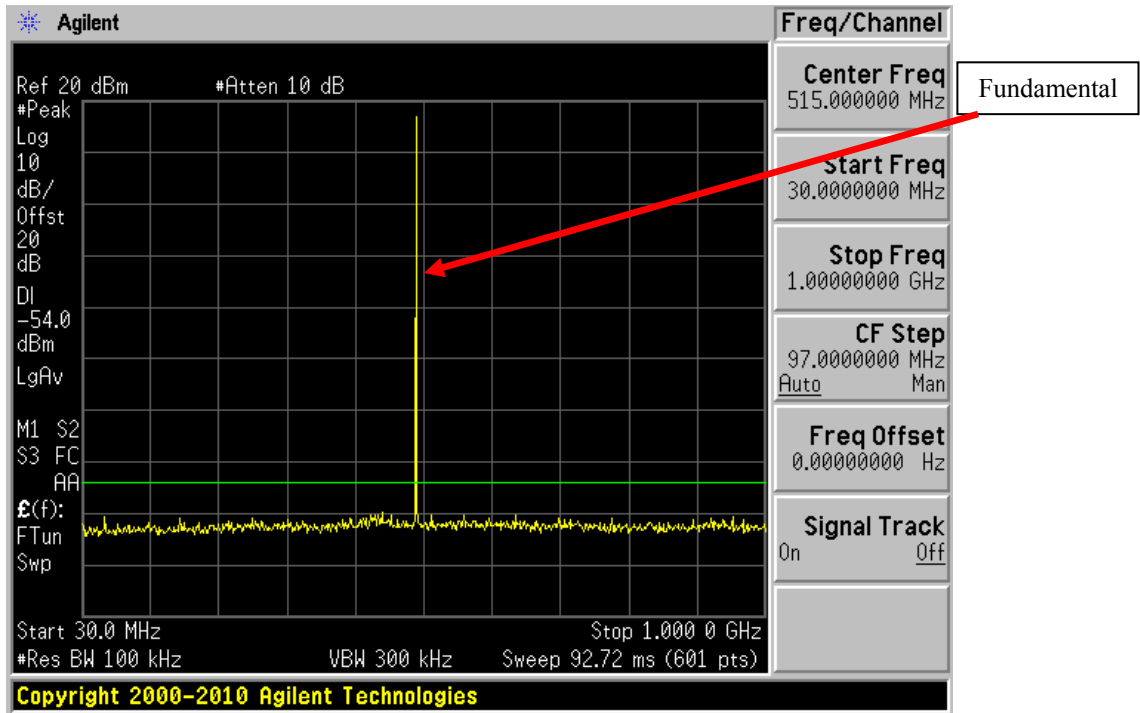

SSM-A1 503.85 MHz SE_2

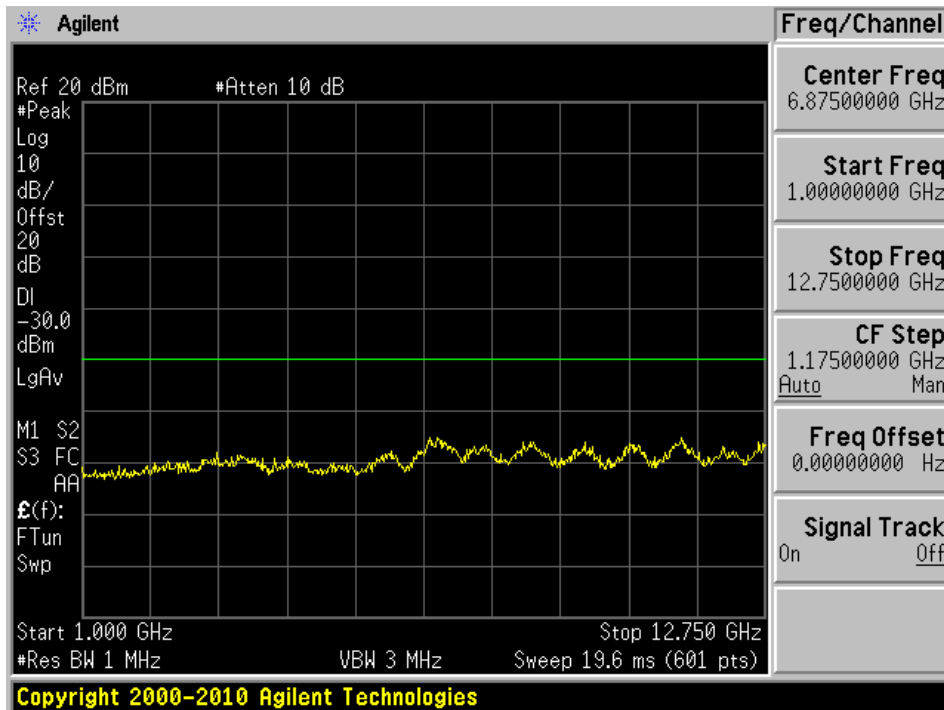

8 FCC §74.861(e) (7) - Field Strength of Spurious Radiation

8.1 Applicable Standards

According to FCC §74.861 (e) (7):

Analog emissions within the band from one megahertz below to one megahertz above the carrier frequency shall comply with the emission mask in section 8.3.1.2 of the European Telecommunications Institute Standard ETSI EN 300 422-1 v1.4.2 (2011-08), Electromagnetic compatibility and Radio spectrum Matters (ERM); Wireless microphones in the 25 MHz to 3 GHz frequency range; part 1: Technical characteristics and methods of measurement. Digital emissions within the band from one megahertz below to one megahertz above the carrier frequency shall comply with the emission mask in section 8.3.2.2 (Figure 4) of the European Telecommunications Institute Standard ETSI EN 300 422-1 v1.4.2 (2011-08), Electromagnetic compatibility and Radio spectrum Matters (ERM); Wireless microphones in the 25 MHz to 3 GHz frequency range; part 1: Technical characteristics and methods of measurement. Beyond one megahertz below and above the carrier frequency, emissions shall comply with the limits specified in section 8.4 of ETSI EN 300 422-1 v1.4.2 (2011-08). The requirements of this paragraph (e)(7) shall not apply to applications for certification of equipment in these bands until nine months after release of the Commission's Channel Reassignment Public Notice, as defined in §73.3700(a)(2) of this chapter.

8.2 Test Procedure

KDB 971168 D01 v03r01 and ETSI EN 300 422-1 V1.4.2 (2011-08).

8.3 Test Equipment List and Details

Manufacturer	Description	Model	Serial Number	Calibration Date	Calibration Interval
Agilent	Spectrum Analyzer	E4446A	MY48250238	2018-05-08	1 year
Sunol Science Corp	System Controller	SC99V	011003-1	N/R	N/A
Sunol Sciences	Biconi-Log Antenna	JB1	A013105-3	2018-02-26	2 years
Agilent	Pre Amplifier	8447D	2944A10187	2018-04-02	1 year
HP	Pre-Amplifier	8449B	3147A00400	2018-02-02	1 year
Sunol Sciences	Horn Antenna	DRH-118	A052704	2017-03-27	2 years
EMCO	Horn Antenna	3115	9511-4627	2018-03-28	2 years
HP	Signal Generator	83650B	3614A00276	2017-11-06	1 year
-	RF Cable	-	-	Each time ¹	N/A
COM-POWER	Dipole Antenna	AD-100	721033DB1, 2, 3, 4	2017-2-13	2 years

Note¹: cable included in the test set-up will be checked each time before testing.

Statement of Traceability: BACL Corp. attests that all of the calibrations on the equipment items listed above were traceable to NIST or to another internationally recognized National Metrology Institute (NMI), and were compliant with A2LA Policy P102 (dated 09 June 2016) "A2LA Policy on Metrological Traceability".

8.4 Test Environmental Conditions

Temperature:	22 °C
Relative Humidity:	40 %
ATM Pressure:	101.0 kPa

The testing was performed by Frank Wang from 2018-08-29 to 2018-09-03 at 5 meter chamber 3.

8.5 Test Results

EUT was configured to the highest power setting on worst case channel.

TX Middle channel (503.85 MHz) at the maximum output power:

Freq. (MHz)	S.A. Amp. (dBμV)	Table Azimuth (Degrees)	Test Antenna		Substitution				Absolute Level (dBm)	Limit (dBm)	Margin (dB)
			Height (cm)	Polar (H/V)	Freq. (MHz)	S.G. Level (dBm)	Antenna Gain (dB)	Cable Loss (dB)			
800	28.45	0	100	H	800	-68.4	0	0.335	-68.735	-54	-14.735
800	28.78	0	100	V	800	-68.06	0	0.335	-68.395	-54	-14.395
1007.7	48.57	0	100	H	1007.7	-61.46	6.052	0.335	-55.743	-30	-25.743
1007.7	48.68	0	100	V	1007.7	-61.03	6.052	0.335	-55.313	-30	-25.313
3017	45.72	0	100	H	3017	-58.11	9.689	0.786	-49.207	-30	-19.207
3017	45.31	0	100	V	3017	-56.69	9.689	0.786	-47.787	-30	-17.787

Standby mode:

Freq. (MHz)	S.A. Amp. (dBμV)	Table Azimuth (Degrees)	Test Antenna		Substitution				Absolute Level (dBm)	Limit (dBm)	Margin (dB)
			Height (cm)	Polar (H/V)	Freq. (MHz)	S.G. Level (dBm)	Antenna Gain (dB)	Cable Loss (dB)			
850	27.94	0	100	V	850	-67.73	0	0.335	-68.065	-57	-11.065
850	28.09	0	100	H	850	-66.96	0	0.335	-67.295	-57	-10.295
1200	47.33	0	100	V	1200	-61.39	6.506	0.335	-55.219	-47	-8.219
1200	47.27	0	100	H	1200	-61.24	6.506	0.335	-55.069	-47	-8.069

9 FCC §74.861(e) (4) - Frequency Stability

9.1 Applicable Standards

According to FCC §74.861 (e) (4):

The frequency tolerance of the transmitter shall be 0.005 percent

9.2 Test Procedure

According to FCC 2.1055, (a) the frequency stability shall be measured with variation of ambient temperature as follows:

- (1) From -30° to $+50^{\circ}$ centigrade for all equipment except that specified in paragraphs (a) (2) and (3) of this section.
- (2) From -20° to $+50^{\circ}$ centigrade for equipment to be licensed for use in the Maritime Services under part 80 of this chapter, except for Class A, B, and S Emergency Position Indicating Radio beacons (EPIRBS), and equipment to be licensed for use above 952 MHz at operational fixed stations in all services, stations in the Local Television Transmission Service and Point-to-Point Microwave Radio Service under part 21 of this chapter, equipment licensed for use aboard aircraft in the Aviation Services under part 87 of this chapter, and equipment authorized for use in the Family Radio Service under part 95 of this chapter.
- (3) From 0° to $+50^{\circ}$ centigrade for equipment to be licensed for use in the Radio Broadcast Services under part 73 of this chapter.

(b) Frequency measurements shall be made at the extremes of the specified temperature range and at intervals of not more than 10° centigrade through the range. A period of time sufficient to stabilize all of the components of the oscillator circuit at each temperature level shall be allowed prior to frequency measurement. The short term transient effects on the frequency of the transmitter due to keying (except for broadcast transmitters) and any heating element cycling normally occurring at each ambient temperature level also shall be shown. Only the portion or portions of the transmitter containing the frequency determining and stabilizing circuitry need be subjected to the temperature variation test.

(d) The frequency stability shall be measured with variation of primary supply voltage as follows:

- (2) For hand carried, battery powered equipment, reduce primary supply voltage to the battery operating end point which shall be specified by the manufacturer.

If an unmodulated carrier is not available, the measurement method shall be described in the test report.

9.3 Test Equipment List and Details

Manufacturer	Description	Model	Serial Number	Calibration Date	Calibration Interval
Agilent	Spectrum Analyzer	E4446A	US44300386	2018-06-01	1 year
Tenney	Environmental Chamber	TUJR	27445-06	2017-10-02	1 year
KEPCO	DC Source	25-10M	H1334526	Cal. Not Required	N/A
Fluke	Digital Multi-meter	189	89920092	2018-03-22	1 year
-	20dB attenuator	-	-	Each time ¹	N/A
-	RF Cable	-	-	Each time ¹	N/A

Note¹: cable and attenuator included in the test set-up will be checked each time before testing.

Statement of Traceability: BACL Corp. attests that all of the calibrations on the equipment items listed above were traceable to NIST or to another internationally recognized National Metrology Institute (NMI), and were compliant with A2LA Policy P102 (dated 09 June 2016) "A2LA Policy on Metrological Traceability".

9.4 Test Environmental Conditions

Temperature:	23 °C
Relative Humidity:	43 %
ATM Pressure:	101.1 kPa

The testing was performed by Vincent Licata on 2018-09-06 at RF site.

9.5 Test Results

503.85 MHz:

Varying temperature:

Temperature (°C)	Measured Frequency (MHz)	Channel Frequency (MHz)	Frequency Tolerance (%)	Limits (%)
-30	503.85359	503.85	0.00071251	0.005
-20	503.85249	503.85	0.00049419	0.005
-10	503.85249	503.85	0.00049419	0.005
0	503.85144	503.85	0.00028580	0.005
10	503.85132	503.85	0.00026198	0.005
20	503.84966	503.85	-0.00006748	0.005
30	503.85021	503.85	0.00004168	0.005
40	503.84856	503.85	-0.00028580	0.005
50	503.84850	503.85	-0.00029771	0.005

Varying supply voltage:

Voltage	Measured Frequency (MHz)	Channel Frequency (MHz)	Frequency Tolerance (%)	Limits (%)
Low Voltage	503.85236	503.85	0.00046839	0.005
High Voltage	503.84948	503.85	-0.00010321	0.005

10 FCC §74.861(e) (3) - Modulation Characteristic

10.1 Applicable Standards

According to FCC §74.861 (e) (3):

Any form of modulation may be used. A maximum deviation of ± 75 kHz is permitted when frequency modulation is employed.

10.2 Test Procedure

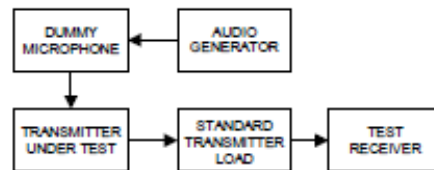

- a) Connect the equipment as illustrated.
- b) Adjust the transmitter per the manufacturer's procedure for full rated system deviation.
- c) Set the test receiver to measure peak positive deviation. Set the audio bandwidth for ≤ 0.25 Hz to $\geq 15,000$ Hz. Turn the de-emphasis function off.
- d) Apply a 1000 Hz modulating signal to the transmitter from the audio frequency generator, and adjust the level to obtain 60% of full rated system deviation.
- e) Increase the level from the audio frequency generator by 20 dB in one step (rise time between the 10% and 90% points shall be 0.1 second maximum).
- f) Measure both the instantaneous and steady-state deviation at and after the time of increasing the audio input level.
- g) With the level from the audio frequency generator held constant at the level obtained in step e), slowly vary the audio frequency from 300 Hz to 3000 Hz and observe the steady-state deviation. Record the maximum deviation.
- h) Set the test receiver to measure peak negative deviation and repeat steps d) through g).
- i) The values recorded in steps g) and h) are the modulation limiting.

10.3 Test Equipment List and Details

Manufacturer	Description	Model	Serial Number	Calibration Date	Calibration Interval
HP	RF Communications Test Set	8920A	3438A05338	2018-01-09	2 years
HP	Modulation Analyzer	8901A	2026A00847	2018-01-06	2 years
-	RF Cable	-	-	-	Each time

Note¹: attenuator included in the test set-up will be checked each time before testing.

Statement of Traceability: *BACL Corp.* attests that all of the calibrations on the equipment items listed above were traceable to NIST or to another internationally recognized National Metrology Institute (NMI), and were compliant with A2LA Policy P102 (dated 09 June 2016) "A2LA Policy on Metrological Traceability".

10.4 Test Environmental Conditions

Temperature:	23 °C
Relative Humidity:	36 %
ATM Pressure:	101.4 kPa

The testing was performed by Vincent Licata on 2018-09-20 at RF site.

10.5 Test Results

MODULATION LIMITING

Carrier Frequency: 503.85 MHz

Peak Positive

AF Level (dB)	AF Frequency (Hz)/Peak Deviation (kHz)				Limit (kHz)
	300 Hz	1000 Hz	5000 Hz	15000 Hz	
20	62.0	60.2	62.1	65.4	±75
15	61.8	63.0	61.9	64.9	±75
10	57.0	61.7	61.7	64.1	±75
5	43.7	59.6	60.0	63.5	±75
0	33.7	45.0	49.7	59.7	±75
-5	31.1	36.0	37.7	35.6	±75
-10	30.0	33.6	35.9	35.5	±75
-15	31.2	33.5	37.3	37.1	±75
-20	31.6	34.7	40.8	40.4	±75

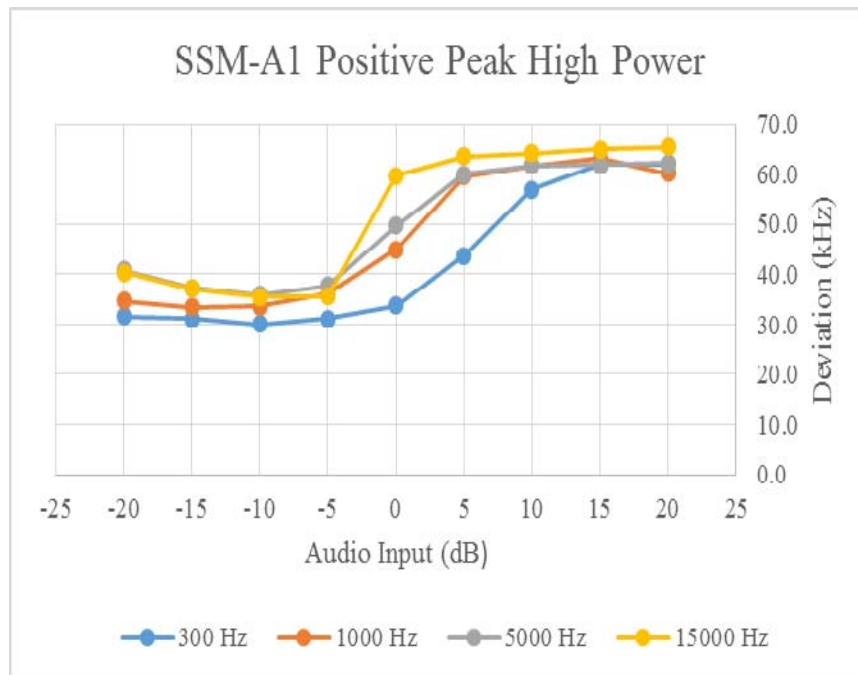

Carrier Frequency: 503.85 MHz

Peak Negative

AF Level (dB)	AF Frequency (Hz)/Peak Deviation (kHz)				Limit (kHz)
	300 Hz	1000 Hz	5000 Hz	15000 Hz	
20	62.4	65.8	62.4	65.3	±75
15	61.6	62.2	61.7	65.0	±75
10	57.2	60.6	61.6	63.3	±75
5	43.5	58.8	60.1	63.0	±75
0	33.7	45.0	49.4	59.1	±75
-5	30.6	34.9	35.9	35.6	±75
-10	29.6	33.4	33.7	33.9	±75
-15	30.4	33.3	33.9	34.1	±75
-20	31.6	34.2	34.9	35.0	±75

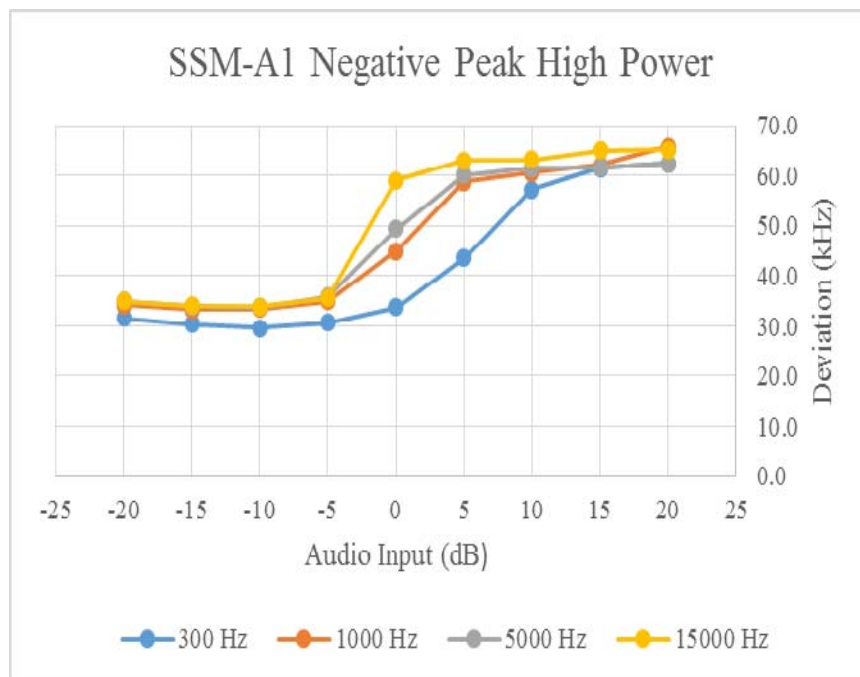

Audio Frequency Response, Middle Channel

AF Frequency (Hz)	AF Level (kHz)	AF Response (dB)
100	5.29	-1.108
200	4.81	-1.935
300	4.97	-1.650
400	5.16	-1.324
500	5.64	-0.552
600	5.82	-0.279
700	5.75	-0.384
800	6.00	-0.014
900	5.93	-0.116
1000	6.01	0.000
1200	6.14	0.186
1400	5.84	-0.249
1600	5.38	-0.962
1800	5.60	-0.614
2000	5.87	-0.205
2200	5.74	-0.399
2400	5.49	-0.786
2600	6.03	0.029
2800	5.73	-0.414
3000	5.69	-0.475
3250	5.77	-0.354
3500	5.76	-0.369
3750	5.51	-0.754
4000	6.11	0.143
4250	5.64	-0.552
4500	5.72	-0.430
4750	5.67	-0.506
5000	5.800	-0.309

Note: AF Response = $20 \cdot \log(\text{AF Level} / \text{AF Level of 1 kHz})$

11 Appendix A - FCC Equipment Labeling Requirements

11.1 FCC ID Label Requirements

As per FCC §2.925,

(a) Each equipment covered in an application for equipment authorization shall bear a nameplate or label listing the following:

(1) FCC Identifier consisting of the two elements in the exact order specified in §2.926. The FCC Identifier shall be preceded by the term FCC ID in capital letters on a single line, and shall be of a type size large enough to be legible without the aid of magnification.

Example: FCC ID: XXX123

Where: XXX—Grantee Code, 123—Equipment Product Code

As per FCC §15.19,

(a) In addition to the requirements in part 2 of this chapter, a device subject to certification, or verification shall be labeled as follows:

(3) All other devices shall bear the following statement in a conspicuous location on the device:

This device complies with part 15 of the FCC Rules. Operation is subject to the following two conditions: (1) This device may not cause harmful interference, and (2) this device must accept any interference received, including interference that may cause undesired operation.

(4) Where a device is constructed in two or more sections connected by wires and marketed together, the statement specified above is required to be affixed only to the main control unit. If the EUT is integrated within another device then a label affixed to the host shall also state, "Contains FCC ID: XXXXXX"

(5) When the device is so small or for such use that it is not practicable to place the statement specified under paragraph (a) of this section on it, the information required by this paragraph shall be placed in a prominent location in the instruction manual or pamphlet supplied to the user or, alternatively, shall be placed on the container in which the device is marketed. However, the FCC identifier or the unique identifier, as appropriate, must be displayed on the device.

11.2 Label Contents and Location

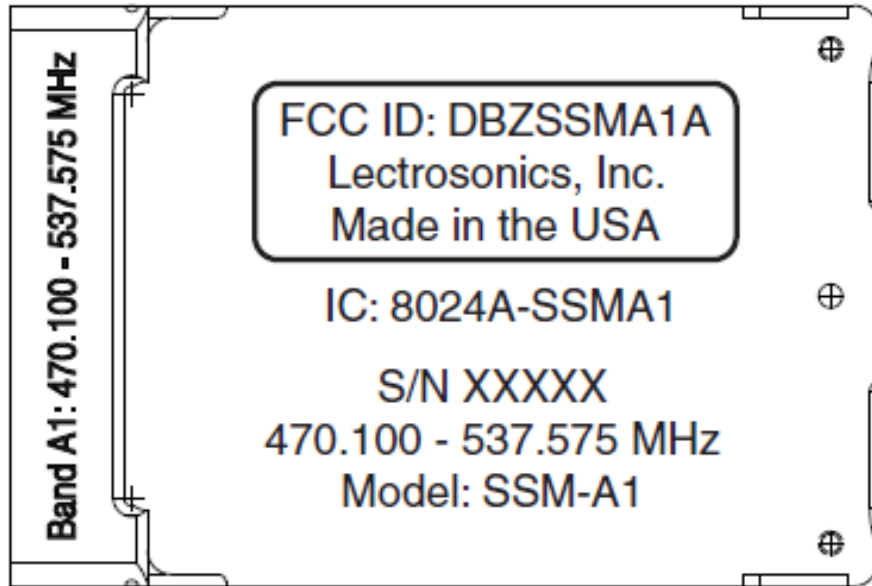

12 Appendix B - EUT Photographs

Please refer to the following exhibits:

Exhibit- EUT Test Setup Photographs

Exhibit- EUT External Photographs

Exhibit- EUT Internal Photographs

13 Appendix C (Normative) - A2LA Electrical Testing Certificate



Accredited Laboratory

A2LA has accredited

BAY AREA COMPLIANCE LABORATORIES CORP.

Sunnyvale, CA

for technical competence in the field of

Electrical Testing

This laboratory is accredited in accordance with the recognized International Standard ISO/IEC 17025:2005 General requirements for the competence of testing and calibration laboratories. This laboratory also meets A2LA R222 - Specific Requirements EPA ENERGY STAR Accreditation Program. This accreditation demonstrates technical competence for a defined scope and the operation of a laboratory quality management system (refer to joint ISO-ILAC-IAF Communiqué dated April 2017).



Presented this 2nd day of October 2018.

A handwritten signature in black ink, appearing to be 'L. S. ...', written over a horizontal line.

President and CEO
 For the Accreditation Council
 Certificate Number 3297.02
 Valid to September 30, 2020

For the tests to which this accreditation applies, please refer to the laboratory's Electrical Scope of Accreditation.

--- END OF REPORT ---