

HMA-941 Series

Plug-on UHF Transmitter

Digital Hybrid Wireless®

US Patent 7.225.135



Follow Us On:



Fill in for your records:

Serial Number:

Purchase Date:

Introduction

Thank you for selecting a Lectrosonics HMa plug-On transmitter. The unique design provides several distinct features for professional applications:

- Outstanding RF operating range
- Superb audio quality
- Corrosion-resistant housing
- Programmable compatibility modes for use with a variety of different receivers

The Digital Hybrid Wireless® design (US Patent 7,225,135) combines 24-bit digital audio with analog FM resulting in a system that has the same operating range as analog systems, the same spectral efficiency as analog systems, the same long battery life as analog systems, plus the excellent audio fidelity typical of pure digital systems.

The transmitter uses a standard 3-pin XLR input jack for use with any microphone with a mating XLR connector. An LCD, membrane switches and multi-color LEDs on the control panel make input gain adjustments and frequency and compatibility mode selection quick and accurate, without having to view the receiver. The housing is machined from a solid aluminum block to provide a lightweight and rugged package. A special non-corrosive finish resists salt water exposure and perspiration in extreme environments.

The DSP-based design works with Digital Hybrid receivers, and is also compatible with Lectrosonics IFB receivers. Companion receivers are covered in separate manuals.

Table of Contents

- Introduction..... 2**
- General Technical Description 4**
 - Digital Hybrid Wireless® Technology 4
 - Low Frequency Roll-Off 4
 - No Pre-Emphasis/De-Emphasis 5
 - Input Limiter 5
 - Signal Encoding and Pilot Tone 5
 - Microprocessor and DSP 5
 - Compatibility Modes..... 5
 - Control Panel 5
- Controls and Functions 6**
 - LCD Screen 6
 - Power LED 6
 - Audio Input Jack..... 6
 - Battery Compartment..... 6
 - Modulation LEDs..... 6
 - Audio Button 6
 - Freq Button 6
 - UP/DOWN Arrows and Panel Lockout 6
 - Antenna..... 6
- Battery Installation 7**
- Attaching/Removing a Microphone 7**
- Operating Instructions 8**
 - Power Up and Boot Sequence..... 8
 - Power Down..... 8
 - Standby Mode..... 8
 - Menus 8
 - Hold UP arrow at turn on..... 8
 - Hold DOWN arrow at turn on..... 9
 - FREQ Button..... 10
 - Locking/Unlocking the Control Panel 10
- Accessories 11**
 - P/N 21750 Barrel Adapter..... 11
 - MCA-M30 Barrel Adapter..... 11
 - PHTRAN3 11
 - MCA5X..... 11
 - MCA-TPOWER 11
- Firmware Update 12**
- Specifications and Features..... 14**
 - Specifications..... 14
- Troubleshooting..... 16**
- Service and Repair 18**
 - Returning Units for Repair 18

For body worn operation, this transmitter has been tested and meets the FCC RF exposure guidelines when used with the Lectrosonics accessories supplied or designated for this product. Use of other accessories may not ensure compliance with FCC RF exposure guidelines. Contact Lectrosonics if you have any questions or need more information about RF exposure using this product..

This device complies with FCC radiation exposure limits as set forth for an uncontrolled environment. This device should be installed and operated so that its antenna(s) are not co-located or operating in conjunction with any other antenna or transmitter.

General Technical Description

The DSP controlled input limiter features a wide range dual envelope design which cleanly limits input signal peaks up to 30 dB above full modulation. Switching power supplies to provide constant voltages to the transmitter circuits from the beginning (3 Volts) to the end (1.7 Volts) of battery life, and an ultra low noise input amplifier for quiet operation.

Digital Hybrid Wireless® Technology

All wireless links suffer from channel noise to some degree, and all wireless microphone systems seek to minimize the impact of that noise on the desired signal. Conventional analog systems use companders for enhanced dynamic range, at the cost of subtle artifacts (known as “pumping” and “breathing”). Wholly digital systems defeat the noise by sending the audio information in digital form, at the cost of some combination of power, bandwidth and resistance to interference.

Lectrosonics Digital Hybrid Wireless® systems overcome channel noise in a dramatically new way, digitally encoding the audio in the transmitter and decoding it in the receiver, yet still sending the encoded information via an analog FM wireless link. This proprietary algorithm is not a digital implementation of an analog compander but a technique that can be accomplished only in the digital domain, even though the inputs and outputs are analog.

Channel noise still impacts received signal quality and will eventually overwhelm a receiver. Digital Hybrid Wireless® simply encodes the signal to use a noisy channel as efficiently and robustly as possible, yielding audio performance that rivals that of wholly digital systems, without the power and bandwidth problems inherent in digital transmission.

Because it uses an analog FM link, Digital Hybrid Wireless® enjoys all the benefits of conventional FM wireless systems, such as excellent range, efficient use of RF spectrum, and resistance to interference. However, unlike conventional FM systems, it does away with the analog compander and its artifacts.

Low Frequency Roll-Off

The low frequency roll-off can be set for a 3 dB down point at 35, 50, 70, 100, 120 and 150 Hz to control subsonic and very low frequency audio content in the audio. The actual roll-off frequency will vary slightly depending upon the low frequency response of the microphone.

Excessive low frequency content can drive the transmitter into limiting, or in the case of high level sound systems, even cause damage to loudspeaker systems. The roll-off is normally adjusted by ear while listening as the system is operating.

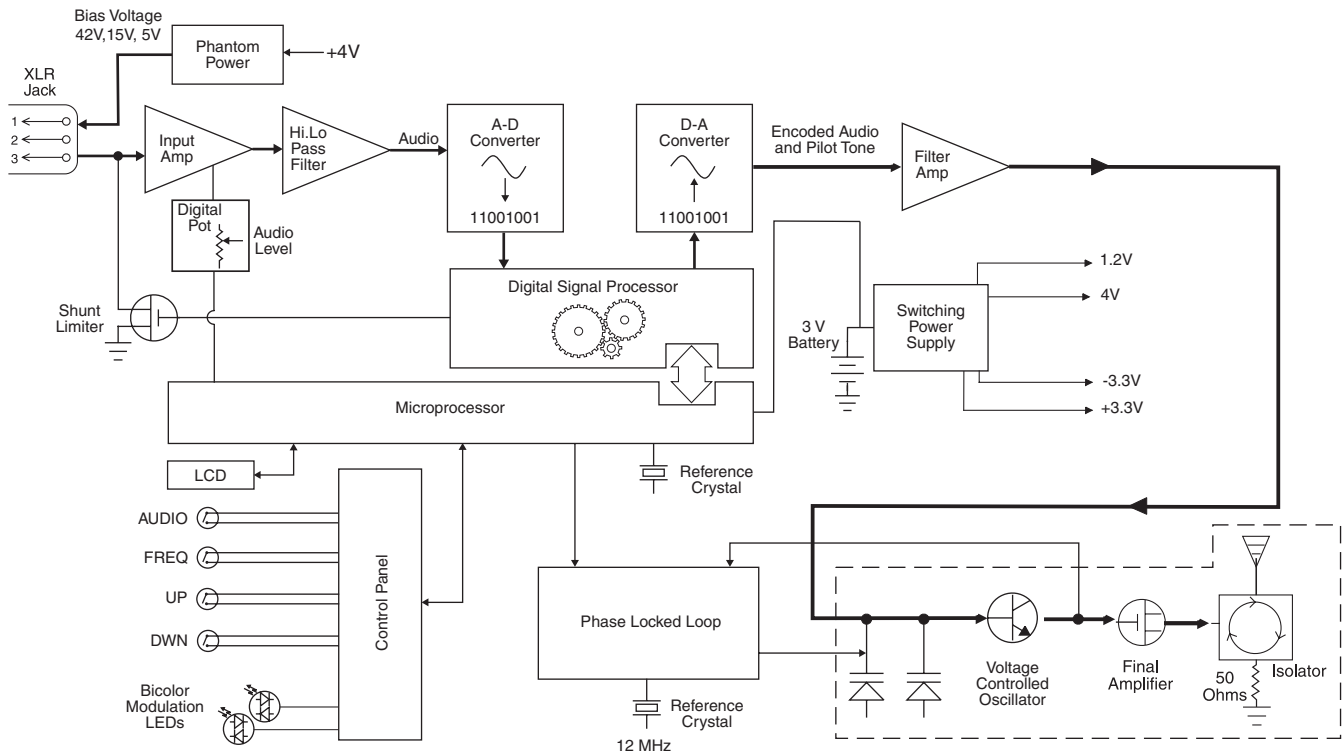

No Pre-Emphasis/De-Emphasis

The Digital Hybrid Wireless® design results in a signal-to-noise ratio high enough to preclude the need for conventional pre-emphasis (HF boost) in the transmitter and de-emphasis (HF roll-off) in the receiver. This eliminates the potential for distortion on signals with abundant high-frequency information.

Input Limiter

A DSP-controlled analog audio limiter is employed before the analog-to-digital (A-D) converter. The limiter has a range of more than 30 dB for excellent overload protection. A dual release envelope makes the limiter acoustically transparent while maintaining low distortion. It can be thought of as two limiters in series, a fast attack and release limiter followed by a slow attack and release limiter. The limiter recovers quickly from brief transients, with no audible side effects, and also recovers slowly from sustained high levels, to keep audio distortion low and while preserving short term dynamics.

Signal Encoding and Pilot Tone

In addition to controlling the limiter, the DSP also encodes the digitized audio from the A-D converter and adds an ultrasonic pilot tone to control the receiver's squelch. A pilot tone squelch system provides a reliable method of keeping a receiver output muted (squelched) even in the presence of significant interference. When the system is operating in the hybrid mode, a different pilot tone frequency is generated for each carrier frequency in 100 kHz increments to prevent inadvertent squelch problems and simplify frequency coordination.

Microprocessor and DSP

A microprocessor monitors user command inputs from the control panel buttons and numerous other internal signals. It works intimately with the DSP to ensure the audio is encoded according to the selected Compatibility Mode and that the correct pilot tone is added to the encoded signal.

Compatibility Modes

The transmitter was designed to operate with Lectrosonics Digital Hybrid Wireless® receivers and will yield the best performance when doing so. However, due to the flexibility of digital signal processing, the transmitter can also operate with Lectrosonics IFB receivers that may be available in the future.

Control Panel

The control panel includes four membrane switches and an LCD screen to adjust the operational settings. Multi-color LEDs are used to indicate audio signal levels for accurate gain adjustment and for battery status.

Controls and Functions



LCD Screen

The LCD is a numeric-type Liquid Crystal Display with several screens that allow settings to be made with the **AUDIO** and **FREQ** buttons, and the UP and DOWN arrow buttons to configure the transmitter. The transmitter can be turned on in a “standby” mode with the carrier turned off to make adjustments without the risk of interfering with other wireless systems nearby.

Power LED

The PWR LED glows green when the batteries are good. The color changes to red when there is about 20 minutes of life left. When the LED begins to blink red, there are only a few minutes of life.

A weak battery will sometimes cause the PWR LED to glow green immediately after being put into the unit, but will soon discharge to the point where the LED will go red or shut off completely.

Audio Input Jack

The XLR input jack on the transmitter accommodates hand-held, shotgun and measurement microphones. Phantom power can be set at various levels for use with a wide variety of electret microphones.

Battery Compartment

The battery compartment door is made of machined aluminum and is hinged to the housing to prevent it being damaged or lost.

Modulation LEDs

The Modulation LEDs provide a visual indication of the input audio signal level from the microphone. These two bicolor LEDs can glow either red or green to indicate modulation levels. Full modulation (0 dB) occurs when the -20 LED first turns red.

Signal Level	-20 LED	-10 LED
Less than -20 dB	● Off	● Off
-20 dB to -10 dB	● Green	● Off
-10 dB to +0 dB	● Green	● Green
+0 dB to +10 dB	● Red	● Green
Greater than +10 dB	● Red	● Red

Audio Button

The **AUDIO** button is used to display the audio level setting, low frequency roll-off and phantom power mode. Repeatedly pressing the button will cycle through the available settings, allowing the UP and DOWN arrow buttons to adjust the values.

Freq Button

The **FREQ** Button displays the selected operating frequency and also toggles the LCD between displaying the actual operating frequency in MHz and a two-digit hexadecimal number. Frequencies can be selected in either 100kHz or 25kHz steps. The appearance of the hexadecimal number is different in the 100kHz step size mode than in the 25kHz step size mode.

NOTE: The FREQ and AUDIO buttons are used together to enter the standby mode and to turn the power on or off.

UP/DOWN Arrows and Panel Lockout

The UP and DOWN arrow buttons are used to select the operating frequency, adjust the audio level, or set the Compatibility Mode.

Pressing both arrows simultaneously enters the lock countdown. Holding the two buttons in until the countdown is completed locks the control panel buttons so they can only be used to display current settings. “Loc” is displayed to indicate the controls are locked when a button is pressed while the panel is locked.

Once locked, the control panel is unlocked by removing the battery or using the remote control “dweedle” tones.

Antenna

An antenna is formed between the housing and the attached microphone, operating much like a dipole. At UHF frequencies the length of the housing is similar to 1/4 wavelength of the operating frequency, so the antenna is surprisingly efficient, which helps extend the operating range and suppress noise and interference.

Battery Installation

The transmitter is powered by two AA batteries.

Note: Standard zinc-carbon batteries marked “heavy-duty” or “long-lasting” are not adequate.



Batteries operate in series, with a connecting plate built into the battery door

To install new batteries:

1. Slide open the Battery Cover and remove any old batteries.
2. Insert the new batteries into the housing. One battery goes in positive (+) end first, the other negative (-) end first. Look into the battery compartment to determine which end goes in which side. The side with the circular insulator is the side which accepts the positive end of the battery.

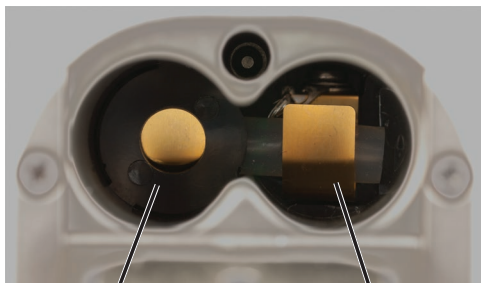

positive (+)
terminal

negative (-)
terminal

Note: It is possible to install the batteries backward and close the battery door, but the batteries will not make contact and the unit will not work.

3. Slide the Battery Cover until it snaps securely shut.

Attaching/Removing a Microphone

The spring loaded coupler under the XLR jack maintains a secure fit to the microphone jack with continuous pressure applied by an internal spring.

To attach the microphone, simply align the XLR pins and press the microphone onto the transmitter until the coupler retracts and latches. A click sound will be heard as the connector latches.

To remove the microphone, hold the transmitter body in one hand with the microphone pointing upward. Use your other hand to rotate the coupler until the latch releases and the coupler rises slightly.

Do not pull on the microphone while releasing the locking collar.

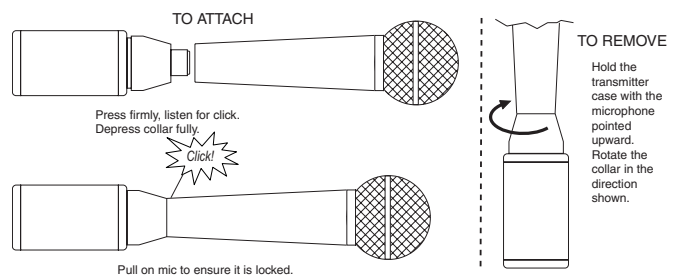

NOTE: Do not hold or apply any pressure to the microphone body while trying to remove it, as this may prevent the latch from releasing.

Operating Instructions

Power Up and Boot Sequence

- 1) Ensure that good batteries are installed in the unit.
- 2) Simultaneously press and hold the AUDIO and FREQ buttons until the power on boot sequence is initiated.



The count will progress from 1 through 3 and the unit will then power up with the RF output turned on. During this turn on sequence, the modulation and power LEDs all glow red, then green, and then revert to normal operation. If the buttons are released before the count is complete, the unit will boot up into the standby mode (see below).

The LCD displays the following information during the boot sequence:

Company Name:	LECTro
Frequency Block and Firmware Version (rX.X):	941r1.1 (typical)
Compatibility Mode:	CP nHb (typical)

When the boot sequence is complete, the display will switch to the frequency currently set.

Power Down



Initial Power Off
Timer Screen

- 1) Simultaneously press and hold the AUDIO and FREQ buttons while observing that the word “Off” appears in the LCD along with a counter.
- 2) When the counter reaches “0”, the unit turns off.

Note: If the AUDIO and FREQ buttons are released before the LCD goes blank at the end of the countdown, the unit will not turn off. Instead, it will stay energized and the display will return to the previous screen.

Standby Mode



Standby Screen

With the power turned off, pressing the AUDIO and FREQ buttons briefly places the unit in Standby Mode.

In this mode the RF output is turned off so all setup adjustments can be made without interfering with other systems operating in the same location. The screen displays “rF OFF” to remind the user that the unit is not transmitting.

While the unit is in the standby mode, access the setup screens using the AUDIO and FREQ buttons and make adjustments using the UP and DOWN arrows.

Menus

Setup is accomplished using menus and setup screens accessed by holding the UP and DOWN arrow buttons at turn on, and by pressing the AUDIO and FREQ buttons when the unit is turned on.

Hold UP arrow at turn on.

Hold the UP arrow button in while pressing both AUDIO and FREQ buttons to access the setup screens below. It’s easier if you lay the unit on a flat surface and use two hands to press all three buttons at the same time. After the first screen loads, press the AUDIO button repeatedly to switch between the settings. Press the UP and DOWN arrow buttons for the desired selection.

After the settings are made, press both AUDIO and FREQ buttons together to exit and turn the power off.

CP (compatibility modes)

Allows the transmitter to be used with 941 Series receivers or IFB systems in the 941 MHz band.

nHb	Digital hybrid mode
IFb	Lectrosonics IFB systems

Pr (power output)

Can be set at 250 for extended range or at 50 for longer battery life.

50	50 mW output and longer battery life when maximum range is not necessary
100	100 mW for slightly increased range

NOTE: See battery life table in the specifications

AP (audio polarity)

The polarity of the audio input (sometimes referred to as “phase”) can be reversed for compatibility with other microphones.

P	Denotes positive polarity
n	Denotes negative polarity

StP (Frequency step size)

Sets the increments of frequency adjustment.

100	100 kHz steps
25	25 kHz steps

Hold DOWN arrow at turn on.

Hold the DOWN arrow button in while pressing both AUDIO and FREQ buttons to access the setup screens below. It's easier if you lay the unit on a flat surface and use two hands to press all three buttons at the same time. After the first screen loads, press the AUDIO button repeatedly to switch between the settings. Press the UP and DOWN arrow buttons for the desired selection.

After the settings are made, press both AUDIO and FREQ buttons together to exit and turn the power off.

rc (remote control with mobile app)

Allows the transmitter to respond to remote control "dweedle" tones from a mobile device, or from tones generated by the Lectrosanics RM and RM2 devices.

on	Enables the remote function.
oFF	Disables the remote function.

PbAc (auto power restore)

Sets the transmitter to automatically turn back on and return to the previous state after a battery change or power interruption when it is in the operating mode.

1	Restores power automatically
0	Does not restore power automatically

bL (backlight settings)

Adjusts how long the LCD stays lit after pressing buttons.

5	5 minutes
30	30 seconds
on	Stays on

AUDIO Button

When the unit is turned on in either the Standby or Operating Mode, pressing the AUDIO button repeatedly switches between the available settings.

- **LF (XX)** adjusts the low frequency roll-off of the audio signal.
- **AUD (XX)** adjusts the input gain

LF (XX) - Adjusting the Low Frequency Roll-off

Repeatedly press the AUDIO button until the LF roll-off adjustment screen appears. Then press and hold the AUDIO button while selecting the desired roll-off frequency with the UP and DOWN arrows.



The roll-off frequency can be set to 35, 50, 70, 100, 120 and 150 Hz.

AUD (XX) - Adjusting Audio Level (Gain)

It's generally a good idea to adjust the low frequency roll-off before setting the gain, since it could affect the gain adjustment. The control panel modulation LEDs marked -10 and -20 indicate the audio level and limiter activity. Once adjusted according to the following procedure, the transmitter's audio level setting **should not** be used to control the volume of your sound system or recorder levels. This gain adjustment matches the transmitter gain with the microphone's output level, the user's voice level and the position of the microphone. The audio input level (gain) should be adjusted with the unit in the Standby Mode while observing the LEDs.

It is generally best to set the LF roll-off before adjusting the gain, since low frequency energy can affect the input level to the transmitter.

It is desirable to to set the gain so that some limiting occurs on louder peaks. The limiter is very transparent over a 43 dB range, and its effect is not audible until the system is close to overload. In other words, don't be shy about turning up the gain.

It is actually a good idea to turn the gain up to maximum and listen for distortion or compression to get a feel for how much headroom is available.

Signal Level	-20 LED	-10 LED
Less than -20 dB	● Off	● Off
-20 dB to -10 dB	● Green	● Off
-10 dB to +0 dB	● Green	● Green
+0 dB to +10 dB	● Red	● Green
Greater than +10 dB	● Red	● Red

Note: If several different people will be using the transmitter and there is not time to make the adjustment for each individual, adjust it for the loudest voice.

- 1) With the transmitter in the Standby Mode, plug in the microphone and make sure the connector is firmly seated.

Warning: If the wireless system is powered up while connected to a live sound system, be careful to turn the sound system level down first or severe feedback can occur.
- 2) Position the microphone in the location where it will be used in actual operation.
- 3) Observe the modulation LEDs while speaking or singing into the microphone at the same voice level that will be used during operation. While holding the AUDIO button, press the UP or DOWN arrow buttons until the both the -20 and -10 LEDs glow green, with the -20 LED flickering red during louder peaks in the audio. This will maximize the signal to noise ratio of the system with full modulation.
- 4) If the unit was set up in Standby Mode, it will be necessary to turn the transmitter off, then power it up again in normal operation so the RF output will be on. Then the other components in the sound or recording system can be adjusted.

PH (phantom power supply)



The transmitter input jack can provide phantom power for the attached microphone if needed, with voltages at 5, 15 or 48 or be turned off. Use the UP and DOWN arrow buttons to select the desired setting. Phantom power will consume a slight amount of battery power.

About the Phantom Power Supply

Three phantom voltages are selectable from the control panel. The voltages are:

- **5 Volts** for lavalier microphones,
- **15 Volts** for some professional mics requiring high current and for many common stage mics that will operate over a wide phantom Voltage range of 12 to 48 Volts. With the proper adapter, this position can also be used with T power microphones. See our web site for details on finding or making the proper adapter.
- **48 Volts** for microphones that do in fact require a supply greater than 18 Volts. (See below for a discussion of why 42 and not a “true” 48 Volts.)

For longest battery life use the minimum phantom voltage necessary for the microphone. Many stage microphones regulate the 48 Volts down to 10 Volts internally anyway, so you might as well use the 15 Volt setting and save some battery power. If you are not using a microphone for the input device, or are using a microphone that does not require phantom power, turn the phantom power off.

Phantom power should only be used with a fully floating, balanced device such as most microphones with a 3-pin XLR connector. If you use the phantom power with an unbalanced device or if pins 2 or 3 are DC connected to ground, then you will draw maximum current from the power supply. The HM is fully protected against such shorts but the batteries will be drained at twice the normal rate.

The transmitter can supply 4 mA at 42 Volts, 8 mA at 15 Volts, and 8 mA at 5 Volts. The 42 Volts setting actually supplies the same voltage to a 48 Volt microphone as the DIN standard arrangement due to a dynamic biasing scheme that does not have as much voltage drop as the DIN standard. The 48 Volt DIN standard arrangement protects against shorts and high fault current with high resistance in the power supply feeds to pins 2 and 3. This provides protection if the supply current is accidentally shorted to ground and also keeps the microphone from being attenuated by the power supply.

The HMa improves on those functions and is able to use less power from the battery by using constant current sources and current limiters. With this dynamic arrangement the HMa can also supply more than twice the current of competing 48 Volt plug on units and provide four times the current for some very high end 15 Volt microphones.

FREQ Button

The operating frequency can be adjusted according to the frequency in MHz or a two-digit hexadecimal code. Press the button repeatedly to switch between the two displays. The display switches when the button is first pushed; push and hold the button in the desired mode and use the UP and DOWN arrow buttons to make the adjustment.

Hex code numbering came about years ago when the first synthesized wireless equipment was introduced. Two 16-position rotary switches were used to set the frequency. 16 on one switch and 16 on the other switch yielded 256 frequencies (16x16=256). While there are no 941 band models that use these switches, hex code numbering is easier way to remember than frequencies expressed in MHz with six numerals.

In this example, the same frequency is displayed in MHz and the equivalent hex code.



The hex code is a hexadecimal numbering sequence that progresses upward from lowest to highest frequency using the numerals and letters from 0 through F. When the frequency is on a 100 kHz step, the hex code will display two **00**'s for the last two digits, which is easy to remember (3A in the example above). When the step size is set to 25 kHz, the last two digits will be 00, 25, 50 or 75 (3A.25 in the example below), which is still easier to remember than all six numerals of the frequency in MHz.



Locking/Unlocking the Control Panel



Simultaneously pressing and holding both the UP and DOWN arrow buttons during normal operation starts the Lock timer. The timer starts at three and counts down to zero.

When the timer reaches zero, the buttons on the control panel are locked.

With the controls locked, the AUDIO and FREQ buttons can still be used to display current settings. Any attempt to change a setting by pressing either the UP or DOWN arrow button will result in an on-screen reminder (**Loc**) that the controls are locked. Remove the batteries to unlock the control panel.

Important: Once the transmitter is locked, it cannot be unlocked or powered off using the buttons. The only ways to unlock a locked transmitter are to remove the battery or unlock it via the remote control.

Accessories

P/N 21750 Barrel Adapter



Mic adapter for Earthworks M30 microphone with HM, HMa and UH400a/TM transmitters.

This polarity reversing adapter may be needed to correct for asymmetrical current draw in some P48 powered condenser microphones, including older Neumann 100 Series, Rode NTG3 and others. If your microphone does not power on correctly when used with these transmitters, insert the adapter between the transmitter and microphone.

MCA-M30 Barrel Adapter



This adapter may be needed if you are experiencing noise or distortion with measurement microphones, particularly the Earthworks M30. The adapter has common mode checks for suppressing RF noise. If your microphone signal exhibits the problems listed above when connected to a UH400, HM or HMa transmitter, insert the adapter between the microphone and the transmitter.

Insert the adapter between the transmitter and microphone to alleviate the problems listed above.



PHTRAN3

Replacement leather pouch with clear plastic screen cover, rotating belt clip and snap closure. Included with transmitter at purchase.



MCA5X

Optional adapter for connecting a lavalier microphone to the HMa or HM transmitters. TA5M to XLR3-M connectors. Passes transmitter phantom power to bias the electret lavalier microphone. Includes zener protection to limit bias voltage to protect the microphone if transmitter phantom power is set too high.



MCA-TPOWER

This cable adapter is to be used with the UH200D, UH400, HM and HMa plug-on transmitters with T-powered microphones. It will protect a T-power mic against the 48V phantom power setting in the transmitter while allowing normal operation. The transmitter should be set to the 15V position for best operation and minimum battery drain.



Firmware Update

Updating the firmware is a simple matter of downloading a utility program and file from the website and running the program on a **Windows operating system** with the transmitter connected to a computer via the USB port.

Go to www.lectrosonics.com/US. In the top menu, hover the mouse over Support, and click on Wireless Support. On the right-hand-side Wireless Support Menu, choose Wireless Downloads. Choose your product (HMa), then choose Firmware.

Step 1:

Begin by downloading the USB Firmware Updater Program.

Firmware

Below are links to the current firmware versions for the HMa transmitter.

These are zip files, after downloading extract it into a temporary folder. Use the [USB Firmware Updater program](#) to update firmware.

[Click here to see HMa Firmware Revision History](#)

[Click here to see HMa/E01 Firmware Revision History](#)

HMa/E01 Firmware Update v1.03

[hma_e01_v1_03.zip](#) [DETAILS](#) [DOWNLOAD](#)

HMa Firmware Update v1.03

[hma_v1_03.zip](#) [DETAILS](#) [DOWNLOAD](#)

USB Firmware Updater

Below is a link to the current USB Firmware Updater installer. This program is used to update firmware on these products:

- DB transmitter
- LT transmitter
- LR receiver
- SSM transmitter
- HMa transmitter

Instructions for updating firmware is found in the Instruction Manual for these products.

Download into a temporary folder. Uninstall any previous version of USB Firmware Updater before running the downloaded installer.

Note: This program requires that the FTDI *D2XX Direct* USB driver be installed on your PC. This is normally pre-installed but if not you will need to download and run a driver installer from the [official FTDI download page](#). Installers for both 64-bit and 32-bit Windows® PCs are available there.

USB Firmware Updater v1.0.6

[UsbFwUpdater-v1.0.6-setup.exe](#) [DETAILS](#) [DOWNLOAD](#)

Lectrosonics

USB Firmware Updater

Welcome to the USB Firmware Updater Setup Wizard

This wizard will guide you through the installation of USB Firmware Updater.

It is recommended that you close all other applications before starting Setup. This will make it possible to update relevant system files without having to reboot your computer.

Click Next to continue.

Step 2:

Next, test the Updater by opening the icon: If the driver opens automatically, proceed to Step 3.

WARNING: If you receive the following error, the Updater is not installed on your system. Follow the **TROUBLESHOOTING** steps to fix the error.

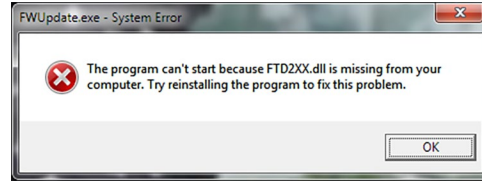

TROUBLESHOOTING:

USB Firmware Updater

Below is a link to the current USB Firmware Updater installer. This program is used to update firmware on these products:

- DB transmitter
- LT transmitter
- LR receiver
- SSM transmitter
- HMa transmitter

Instructions for updating firmware is found in the Instruction Manual for these products.

Download into a temporary folder. Uninstall any previous version of USB Firmware Updater before running the downloaded installer.

Note: This program requires that the FTDI *D2XX Direct* USB driver be installed on your PC. This is normally pre-installed but if not you will need to download and run a driver installer from the [official FTDI download page](#). Installers for both 64-bit and 32-bit Windows® PCs are available there.

USB Firmware Updater v1.0.6

[UsbFwUpdater-v1.0.6-setup.exe](#) [DETAILS](#) [DOWNLOAD](#)

If you receive the FTDI D2XX error shown above, download and install the driver by clicking on this link.

Then click here to download.

NOTE: This website, <http://www.ftdichip.com/Drivers/D2XX.htm>, is not associated with Lectrosonics.com. It is a third party site used only for D2XX drivers currently available for Lectrosonics' devices' upgrades.

Operating System	Release Date	x86 (32-bit)	x64 (64-bit)	ARM	MIPS	SH4	Comments
Windows*	2016-03-16	2.12.16	2.12.16	-	-	-	WHQL Certified. Available as a setup executable. Please read the WHQL Certified Driver Installation Guides .

Step 3:

Refer to Step 1 to return to Firmware web page. Download Firmware Update and save to a local file on your PC for easy locating when updating.

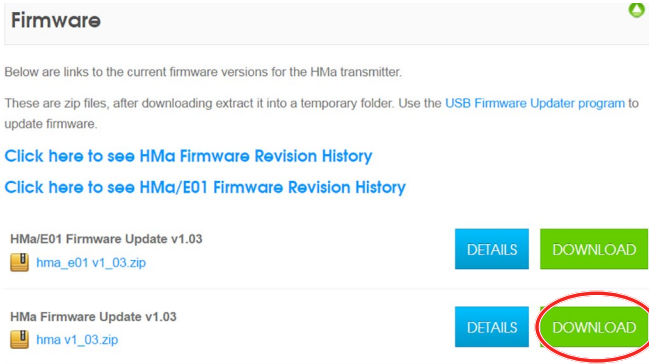

Step 4:

Open Lectrosionics USB Firmware Updater.

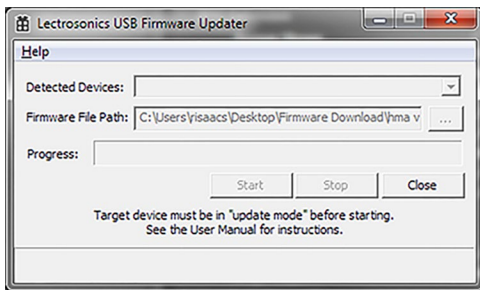

Step 5:



With the unit powered OFF, put the transmitter in UPDATE mode by simultaneously holding down the **UP** arrow, **DOWN** arrow, **AUDIO** and **FREQ** buttons.

Step 6:

Using a microUSB cable, connect the transmitter to your PC.

Step 7:

In Lectrosionics USB Firmware Updater, choose the detected device, browse to local Firmware File and click Start.

NOTE: It may take up to a minute or so for the Updater to recognize the transmitter.

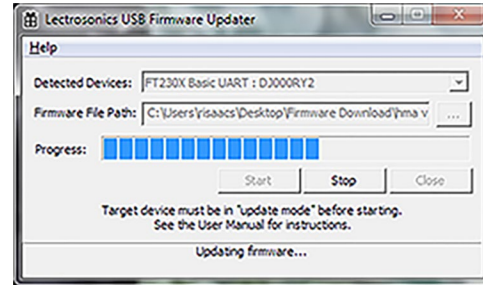

WARNING: Do not disrupt the microUSB cable during updating.

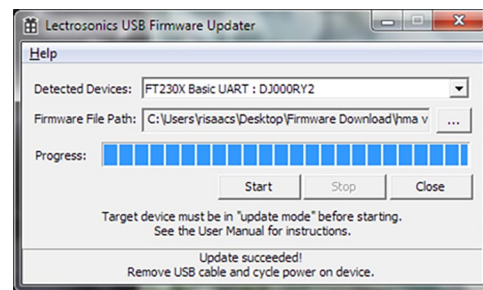

The Updater alerts with progress and completion.

Step 8:

Once the Updater has completed, turn off the transmitter, then turn it back on to verify that the firmware version on the transmitter LCD matches the firmware version shown on the web site. The firmware is the second LCD display during bootup sequence.



Step 9:

Close Updater and disconnect microUSB cable.

Specifications and Features

Specifications

Operating Frequency Range: 941.525 - 951.975 MHz
 952.875 - 956.225 MHz
 956.475 - 959.825 MHz

Frequency Selection Steps: Selectable; 100 kHz or 25 kHz

RF Power output: Selectable 50/100 mW

Pilot tone: 27 to 32 kHz; 3.0 kHz deviation (in the Digital Hybrid mode)

Frequency stability: ± 0.002%

Spurious radiation: Compliant with ETSI EN 300 422-1 v1.4.2

Equivalent input noise: -125 dBV (A-weighted)

Input level: Nominal 2 mV to 300 mV, before limiting. Greater than 1V maximum, with limiting.

Input impedance: 300 Ohms

Input limiter: Dual envelope "soft" limiter; greater than 30 dB range

Gain control range: 55 dB; panel mounted membrane switches

Modulation indicators: Dual bi-color LEDs indicate modulation of -20, -10, 0, +10 dB referenced to full modulation

Audio Performance (overall system):

Frequency Response: 35 Hz to 20 kHz (+/-1dB)

Low frequency Roll-off: Adjustable for -3dB @30, 50, 70, 100, 120 or 150 Hz)

THD: 0.2% (typ.) 100 Hz to 20 kHz

System Dynamic Range:

SmartNR	no limiting	w/limiting
OFF	103.5	108.0
NORMAL	107.0	111.5
FULL	108.5	113.0

Note: The dual envelope "soft" limiter provides exceptionally good handling of transients using variable attack and release time constants.

Once activated, the limiter compresses 30+ dB of transmitter input range into 4.5 dB of receiver output range, thus reducing the measured figure for SNR without limiting by 4.5 dB.

- Controls & Indicators:**
- Power/Phantom "ON-OFF"
 - Phantom voltage selector
 - Audio input gain
 - LCD w/membrane switches
 - LED audio level indicators

Audio Input Jack: Standard 3-pin XLR (female)

Phantom Power: 5V @ 18 mA max., 15V @ 15 mA max. and 48 V @ 4 mA max., plus "OFF"

USB port: Used for firmware updates

IR (infrared) port: For quick setup by transferring settings from an IR enabled receiver

Antenna: Housing and attached microphone/cable form the antenna

Battery: Two 1.5 Volt AA alkaline

Battery Life (Duracell Quantum):
 AA alkaline; No Phantom Power: 5h 0m*
 AA alkaline; 48V Phantom Power: 3h 30m**

*Tested with a dynamic microphone
 **Tested with a Sanken CS1 for a phantom-powered microphone

Weight: 6.7 oz (190 grams) without batteries

Dimensions: 4.25x1.62x1.38 inches

Emission Designator: 180KF3E

Digital Hybrid Wireless® is a revolutionary design that combines digital audio with an analog FM radio link to provide outstanding audio quality and the exemplary RF performance of the finest analog wireless systems.

The design overcomes channel noise in a dramatically different way, digitally encoding the audio in the transmitter and decoding it in the receiver, yet still sending the encoded information via an analog FM wireless link. This proprietary algorithm is not a digital implementation of an analog compandor. Instead, it is a technique which can be accomplished only in the digital domain.

The process eliminates compandor artifacts, expanding the applications to include test and measurement of acoustic spaces.

*US Patent 7,225,135

Troubleshooting

Before going through the following chart, be sure that you have a good battery in the transmitter. It is important that you follow these steps in the sequence listed.

SYMPTOM

POSSIBLE CAUSE

TRANSMITTER PWR LED OFF

- 1) Battery is inserted backwards or dead.
- 2) Transmitter not powered up.

TRANSMITTER PWR LED BLINKS GREEN EVERY FEW SECONDS, TRANSMITTER DOES NOT RESPOND OTHERWISE

- 1) Transmitter has been put to sleep by the remote control. Either use the remote control to wake it up or remove and reinsert the transmitter's battery.

AUDIO LEVEL LEDs NOT LIGHTING

- 1) Gain control set to low or at minimum.
- 2) Batteries are dead or installed backwards. Check PWR LED.
- 3) Mic capsule is damaged or malfunctioning.
- 4) Mic cable damaged or mis-wired.

RECEIVER RF INDICATOR OFF

- 1) Transmitter not turned on, or is in Standby Mode.
- 2) Transmitter battery is dead.
- 3) Receiver antenna missing or improperly positioned.
- 4) Transmitter and receiver not on same frequency. Check switches/display on transmitter and receiver.
- 5) Operating range is too great.
- 6) Defective transmitter or receiver antenna.

NO SOUND (OR LOW SOUND LEVEL), RECEIVER INDICATES PROPER AUDIO MODULATION

- 1) Receiver output level set too low.
- 2) Receiver output disconnected, or cable defective or mis-wired.
- 3) Sound system or recorder input is turned down.

DISTORTED SOUND

- 1) Transmitter gain (audio level) is far too high. Check audio level LEDs and receiver audio levels during use.
- 2) Receiver output may be mismatched with the sound system or recorder input. Adjust output level on receiver to the correct level for the recorder, mixer or sound system. (Use the receiver's Tone function to check level.)
- 3) Transmitter is not set to same frequency as receiver. Check that operating frequency on receiver and transmitter match.
- 4) Receiver/Transmitter Compatibility Mode mismatched.

EXCESSIVE FEEDBACK

- 1) Transmitter gain (audio level) too high. Check gain adjustment and/or reduce receiver output level.
- 2) Talent standing too close to speaker system.
- 3) Mic is too far from user's mouth.

SYMPTOM

POSSIBLE CAUSE

HISS AND NOISE -- AUDIBLE DROPOUTS

- 1) Transmitter gain (audio level) far too low.
- 2) Defective transmitter or receiver antenna.
- 3) Operating range too great.
- 4) Signal interference. Turn off transmitter. If receiver's signal strength indicator does not drop to nearly zero, this indicates an interfering signal may be the problem. Try a different operating frequency.

“Loc” APPEARS IN DISPLAY WHEN ANY BUTTON IS PRESSED

- 1) Control Panel is locked.
- 2) Unlock the control panel with remote or removing and replacing the batteries.

“Hold” APPEARS IN DISPLAY WHEN ARROW BUTTONS ARE PRESSED

- 1) Reminder that it is necessary to hold down the AUDIO or FREQ button to make adjustments to the audio gain or frequency settings.

“PLL” APPEARS IN DISPLAY

- 1) Indication that the PLL is not locked. This is a serious condition that requires factory repair. It may be possible to operate on another frequency far removed from the one that was selected when PLL appeared on the display.

TRANSMITTER WON'T RESPOND TO REMOTE CONTROL

- 1) If LCD blinks “rc oFF”, transmitter has not been configured to respond to the remote control.
- 2) If LCD blinks “- - - - -”, transmitter is already set as requested by the remote control.
- 3) If transmitter does not respond at all, try moving the remote control closer to the microphone or increasing the remote control's loudness setting, or increasing the input gain on the transmitter.
- 4) Make sure volume of the remote device and proximity of microphone are sufficient to engage transmitter.
- 5) Make sure transmitter is not in Sleep mode.

Service and Repair

If your system malfunctions, you should attempt to correct or isolate the trouble before concluding that the equipment needs repair. Make sure you have followed the setup procedure and operating instructions. Check the interconnecting cables and then go through the **Troubleshooting** section in this manual.

We strongly recommend that you **do not** try to repair the equipment yourself and **do not** have the local repair shop attempt anything other than the simplest repair. If the repair is more complicated than a broken wire or loose connection, send the unit to the factory for repair and service. Don't attempt to adjust any controls inside the units. Once set at the factory, the various controls and trimmers do not drift with age or vibration and never require readjustment. **There are no adjustments inside that will make a malfunctioning unit start working.**

LECTROSONICS' Service Department is equipped and staffed to quickly repair your equipment. In warranty repairs are made at no charge in accordance with the terms of the warranty. Out-of-warranty repairs are charged at a modest flat rate plus parts and shipping. Since it takes almost as much time and effort to determine what is wrong as it does to make the repair, there is a charge for an exact quotation. We will be happy to quote approximate charges by phone for out-of-warranty repairs.

Returning Units for Repair

For timely service, please follow the steps below:

- A. DO NOT return equipment to the factory for repair without first contacting us by email or by phone. We need to know the nature of the problem, the model number and the serial number of the equipment. We also need a phone number where you can be reached 8 A.M. to 4 P.M. (U.S. Mountain Standard Time).
- B. After receiving your request, we will issue you a return authorization number (R.A.). This number will help speed your repair through our receiving and repair departments. The return authorization number must be clearly shown on the **outside** of the shipping container.
- C. Pack the equipment carefully and ship to us, shipping costs prepaid. If necessary, we can provide you with the proper packing materials. UPS is usually the best way to ship the units. Heavy units should be "double-boxed" for safe transport.
- D. We also strongly recommend that you insure the equipment, since we cannot be responsible for loss of or damage to equipment that you ship. Of course, we insure the equipment when we ship it back to you.

Lectrosonics USA:

Mailing address:

Lectrosonics, Inc.
PO Box 15900
Rio Rancho, NM 87174
USA

Shipping address:

Lectrosonics, Inc.
581 Laser Rd.
Rio Rancho, NM 87124
USA

Telephone:

(505) 892-4501
(800) 821-1121 Toll-free
(505) 892-6243 Fax

Web:

www.lectrosonics.com

E-mail:

sales@lectrosonics.com

Lectrosonics Canada:

Mailing Address:

720 Spadina Avenue,
Suite 600
Toronto, Ontario M5S 2T9

Telephone:

(416) 596-2202
(877) 753-2876 Toll-free
(877-7LECTRO)
(416) 596-6648 Fax

E-mail:

Sales: colinb@lectrosonics.com
Service: joeb@lectrosonics.com

LIMITED ONE YEAR WARRANTY

The equipment is warranted for one year from date of purchase against defects in materials or workmanship provided it was purchased from an authorized dealer. This warranty does not cover equipment which has been abused or damaged by careless handling or shipping. This warranty does not apply to used or demonstrator equipment.

Should any defect develop, Lectrosonics, Inc. will, at our option, repair or replace any defective parts without charge for either parts or labor. If Lectrosonics, Inc. cannot correct the defect in your equipment, it will be replaced at no charge with a similar new item. Lectrosonics, Inc. will pay for the cost of returning your equipment to you.

This warranty applies only to items returned to Lectrosonics, Inc. or an authorized dealer, shipping costs prepaid, within one year from the date of purchase.

This Limited Warranty is governed by the laws of the State of New Mexico. It states the entire liability of Lectrosonics Inc. and the entire remedy of the purchaser for any breach of warranty as outlined above. NEITHER LECTROSONICS, INC. NOR ANYONE INVOLVED IN THE PRODUCTION OR DELIVERY OF THE EQUIPMENT SHALL BE LIABLE FOR ANY INDIRECT, SPECIAL, PUNITIVE, CONSEQUENTIAL, OR INCIDENTAL DAMAGES ARISING OUT OF THE USE OR INABILITY TO USE THIS EQUIPMENT EVEN IF LECTROSONICS, INC. HAS BEEN ADVISED OF THE POSSIBILITY OF SUCH DAMAGES. IN NO EVENT SHALL THE LIABILITY OF LECTROSONICS, INC. EXCEED THE PURCHASE PRICE OF ANY DEFECTIVE EQUIPMENT.

This warranty gives you specific legal rights. You may have additional legal rights which vary from state to state.

