

DBSM/DBSMD

Digital Transcoder

DBSM-A1B1, DBSM/E01-A1B1, DBSMD-A1B1, DBSMD/E01-A1B1

NEED NEW PICS. THESE ARE PROTOTYPES



DBSM

DBSMD

Featuring
Digital Hybrid Wireless® Technology
US Patent 7,225,135



Fill in for your records:

Serial Number:

Purchase Date:



Table of Contents

Introduction	2
About Digital Hybrid Wireless®.....	2
Servo Bias Input and Wiring	3
DSP-controlled Input Limiter	3
Recorder function.....	3
Compatibility with microSDHC memory cards	3
Features	4
Battery Status LED Indicator	4
Menu Shortcuts.....	4
IR (infrared) Sync.....	4
Battery Installation	5
Formatting SD Card	5
IMPORTANT	5
iXML HEADER SUPPORT	5
Turning Power ON	6
Short Button Press.....	6
Long Button Press	6
Menu Shortcuts.....	6
Transmitter Operating Instructions	7
Recorder Operating Instructions	7
SMWB Main Menu	8
SMWB Power Button Menu	9
Setup Screen Details	10
Locking/Unlocking Changes to Settings.....	10
Main Window Indicators.....	10
Connecting the Signal Source	10
Turning Control Panel LEDs ON/OFF	10
Helpful Features on Receivers.....	10
Files	10
Record or Stop	11
Adjusting the Input Gain.....	11
Selecting Frequency	11
Selecting Frequency Using Two Buttons.....	12
About Overlapping Frequency Bands	12
Selecting the Low Frequency Roll-off	12
Selecting the Compatibility (Compat) Mode.....	12
Selecting Step Size.....	13
Selecting Audio Polarity (Phase).....	13
Setting Transmitter Output Power	13
Setting Scene and Take Number	13
Choosing Takes for Replay	13
Recorded File Naming	13
SD Info	13
Restoring Default Settings	13
5-Pin Input Jack Wiring	14
Microphone Cable Termination	15
for Non-Lectrosonics Microphones.....	15
Input Jack Wiring for Different Sources	16
Microphone RF Bypassing.....	17
Line Level Signals.....	17
Firmware Update	18
Recovery Process	19
Declaration of Conformity	19
Silver Paste on SM Series Transmitter Thumbscrews	20
Straight Whip Antennas	21
Belt Clips and Pouches	22
DBSM Single Battery Model	22
DBSMD Dual Battery Model	22
Miscellaneous Accessories	23
LectroRM	24
Specifications	25
Troubleshooting	26
Service and Repair	28
Returning Units for Repair	28

Introduction

The design of the DBSM/DBSMD transmitter delivers the advanced technology and features of Digital Hybrid Wireless® in a Lectrosonics belt-pack transmitter at a modest cost. Digital Hybrid Wireless® combines a 24-bit digital audio chain with an analog FM radio link to eliminate a compandor and its artifacts, yet preserve the extended operating range and noise rejection of the finest analog wireless systems.

The housing is a rugged, machined aluminum package with a standard Lectrosonics 5-pin input jack for use with electret lavalier mics, dynamic mics, musical instrument pickups and line level signals. The LEDs on the keypad allow quick and accurate level settings without having to view the receiver. The unit is powered by AA batteries, and the antenna port uses a standard 50 ohm SMA connector.

Switching power supplies provide constant voltages to the transmitter circuits from the beginning to the end of battery life, with output power remaining constant over the life of the battery. The input amplifier uses an ultra low noise op amp. Input gain is adjustable over a 44 dB range, with a DSP-controlled dual envelope input limiter providing a clean 30 dB range to prevent overload from signal peaks.

About Digital Hybrid Wireless®

All wireless links suffer from channel noise to some degree, and all wireless microphone systems seek to minimize the impact of that noise on the desired signal. Conventional analog systems use compandors for enhanced dynamic range, at the cost of subtle artifacts (known as “pumping” and “breathing”). Wholly digital systems defeat the noise by sending the audio information in digital form, at the cost of some combination of power, bandwidth, operating range and resistance to interference.

The Lectrosonics Digital Hybrid Wireless system overcomes channel noise in a dramatically new way, digitally encoding the audio in the transmitter and decoding it in the receiver, yet still sending the encoded information via an analog FM wireless link. This proprietary algorithm is not a digital implementation of an analog compandor but a technique which can be accomplished only in the digital domain.

Since the RF link between transmitter and receiver is FM, channel noise will increase gradually with increased operating range and weak signal conditions, however, the Digital Hybrid Wireless system handles this situation elegantly with rarely audible audio artifacts as the receiver approaches its squelch threshold.

In contrast, a purely digital system tends to drop the audio suddenly during brief dropouts and weak signal conditions. The Digital Hybrid Wireless system simply encodes the signal to use a noisy channel as efficiently and robustly as possible, yielding audio performance

that rivals that of purely digital systems, without the power, noise and bandwidth problems inherent in digital transmission. Because it uses an analog FM link, Digital Hybrid Wireless enjoys all the benefits of conventional FM wireless systems, such as excellent range, efficient use of RF spectrum, and long battery life.

Servo Bias Input and Wiring

The input preamp is a unique design that delivers audible improvements over conventional transmitter inputs. Two different microphone wiring schemes are available to simplify and standardize the configuration. Simplified 2-wire and 3-wire configurations provide several arrangements designed for use only with servo bias inputs to take full advantage of the preamp circuitry.

A line level input wiring provides an extended frequency response with an LF roll-off at 35 Hz for use with instruments and line level signal sources.

DSP-controlled Input Limiter

The transmitter employs a digitally-controlled analog audio limiter prior to the analog-to-digital converter. The limiter has a range greater than 30 dB for excellent overload protection. A dual release envelope makes the limiter acoustically transparent while maintaining low distortion. It can be thought of as two limiters in series, connected as a fast attack and release limiter followed by a slow attack and release limiter. The limiter recovers quickly from brief transients, so that its action is hidden from the listener, but recovers slowly from sustained high levels to keep audio distortion low and preserve short term dynamic changes in the audio.

Recorder function

The DBSM/DBSMD has a built in recording function for use in situations where RF may not be possible or to work as a stand alone recorder. The record function and transmit functions are exclusive of each other - you cannot record AND transmit at the same time. When the unit is transmitting and recording is turned on, the audio in the RF transmission will stop, but the battery status will still be sent to the receiver.

The recorder samples at 44.1kHz rate with a 24 bit sample depth. (the rate was selected due to the required 44.1kHz rate used for the digital hybrid algorithm). The micro SDHC card also offers easy firmware update capabilities without the need for a USB cable or driver issues.

Compatibility with microSDHC memory cards

Please note that the DBSM/DBSMD are designed for use with **microSDHC memory cards**. There are several types of SD card standards (as of this writing) based on capacity (storage in GB).

SDSC: standard capacity, up to and including 2 GB – **DO NOT USE!**

SDHC: high capacity, more than 2 GB and up to and including 32 GB – **USE THIS TYPE.**

SDXC: extended capacity, more than 32 GB and up to and including 2 TB – **DO NOT USE!**

SDUC: extended capacity, more than 2TB and up to and including 128 TB – **DO NOT USE!**

The larger XC and UC cards use a different formatting method and bus structure and are NOT compatible with the recorder. These are typically used with later generation video systems and cameras for image applications (video and high resolution, high speed photography).

ONLY microSDHC memory cards should be used. They are available in capacities from 4GB to 32GB. Look for the Speed Class 10 cards (as indicated by a C wrapped around the number 10), or the UHS Speed Class I cards (as indicated by the numeral 1 inside a U symbol). Also note the **microSDHC** Logo.

If you are switching to a new brand or source of card, we always suggest testing first before using the card on a critical application.

The following markings will appear on compatible memory cards. One or all of the markings will appear on the card housing and the packaging.

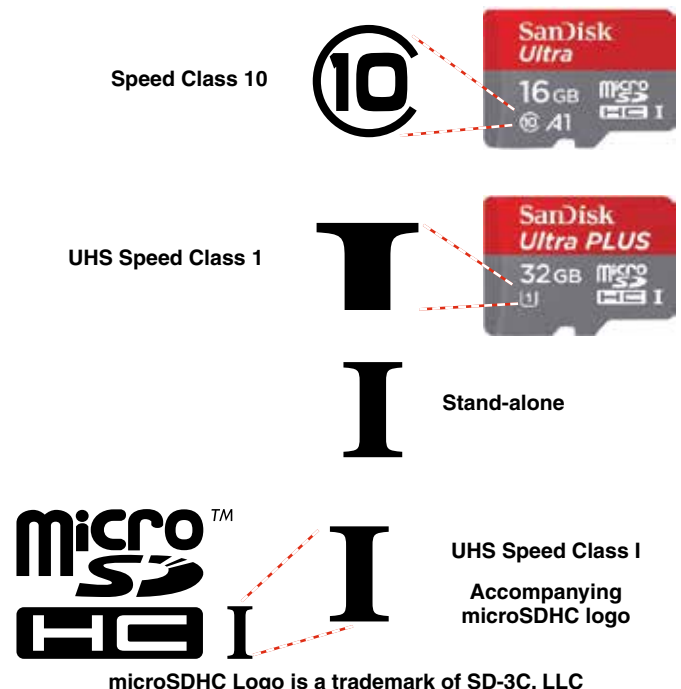

Features

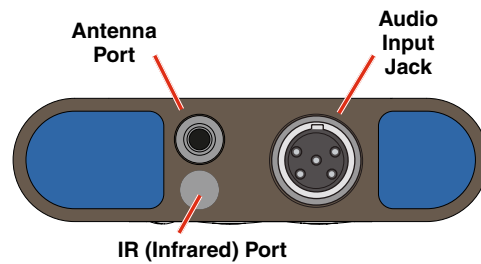
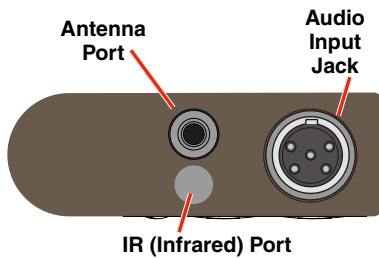
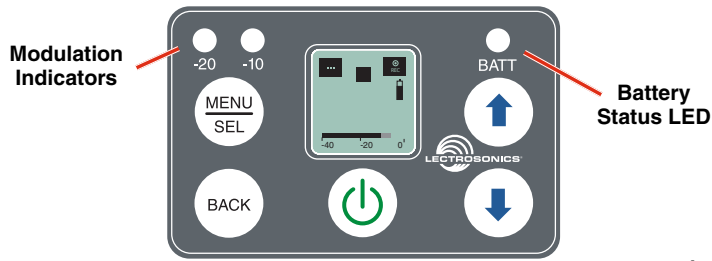

Battery Status LED Indicator

AA batteries can be used to power the transmitter. The LED labeled BATT on the keypad glows green when the batteries are good. The color changes to red when the battery voltage drops down and stays red through most of the battery life. When the LED begins to *blink* red, there will be only a few minutes remaining. The exact point at which the LEDs turn red will vary with battery brand and condition, temperature and power consumption. The LEDs are intended to simply catch your attention, not to be an exact indicator of remaining time.

A weak battery will sometimes cause the LED to glow green immediately after the transmitter is turned on, but it will soon discharge to the point where the LED will turn red or the unit will turn off completely.

Some batteries give little or no warning when they are depleted. If you wish to use these batteries in the transmitter, you will need to manually keep track of the operating time to prevent interruptions caused by dead batteries.

Start with a fully charged battery, then measure the time it takes for the Power LED to go out completely.

NOTE: The battery timer feature in many Lectrosonics receivers is very helpful in measuring battery runtime. Refer to the receiver instructions for details on using the timer.

Menu Shortcuts

From the Main/Home Screen, the following shortcuts are available:

- **Record:** Press the MENU/SEL + UP arrow simultaneously
- **Stop Recording:** Press the MENU/SEL + DOWN arrow simultaneously

NOTE: The shortcuts are only available from the main/home screen AND when a microSDHC memory card is installed.

IR (infrared) Sync

The IR port is for quick setup using a receiver with this function available. IR Sync will transfer the settings for frequency, step size and compatibility mode from the receiver to the transmitter. This process is initiated by the receiver. When the sync function is chosen on the receiver, hold the IR port of the transmitter near the IR port of the receiver. (There is no menu item available on the transmitter to initiate the sync.)

NOTE: If a mismatch exists between the receiver and transmitter, an error message will appear on the transmitter LCD stating what the problem is.

Battery Installation

The transmitter is powered by AA batteries. We recommend using lithium for longest life.

Because some batteries run down quite abruptly, using the Power LED to verify battery status will not be reliable. However, it is possible to track battery status using the battery timer function available in Lectrosonics Digital Hybrid Wireless receivers.

The battery door opens by simply unscrewing the knurled knob part way until the door will rotate. The door is also easily removed by unscrewing the knob completely, which is helpful when cleaning the battery contacts. The battery contacts can be cleaned with alcohol and a cotton swab, or a clean pencil eraser. Be sure not to leave any remnants of the cotton swab or eraser crumbs inside the compartment.

A small pinpoint dab of silver conductive grease on the thumbscrew threads can improve battery performance and operation. **See page 20.** Do this if you experience a drop in battery life or an increase in operating temperature.

If you are unable to locate a supplier of this type of grease - a local electronics shop for example - contact the factory for a small maintenance vial.

Insert the batteries according to the markings on the back of the housing. If the batteries are inserted incorrectly, the door may close but the unit will not operate.

Formatting SD Card

New microSDHC memory cards come pre-formatted with a FAT32 file system which is optimized for good performance. The PDR relies on this performance and will never disturb the underlying low level formatting of the SD card. When the DBSM/DBSMD “formats” a card, it performs a function similar to the Windows “Quick Format” which deletes all files and prepares the card for recording. The card can be read by any standard computer but if any write, edit or deletions are made to the card by the computer, the card must be re-formatted with the DBSM/DBSMD to prepare it again for recording. The DBSM/DBSMD never low level formats a card and we strongly advise against doing so with the computer.

To format the card with the DBSM/DBSMD, select Format Card in the menu and press MENU/SEL on the keypad.

WARNING: Do not perform a low level format (complete format) with a computer. Doing so may render the memory card unusable with the DBSM/DBSMD recorder.

With a windows based computer, be sure to check the quick format box before formatting the card.

With a Mac, choose MS-DOS (FAT).

IMPORTANT

The formatting of the SD card sets up contiguous sectors for maximum efficiency in the recording process. The file format utilizes the BEXT (Broadcast Extension) wave format which has sufficient data space in the header for the file information and the time code imprint.

The SD card, as formatted by the DBSM/DBSMD recorder, can be corrupted by any attempt to directly edit, change, format or view the files on a computer.

The simplest way to prevent data corruption is to copy the .wav files from the card to a computer or other Windows or OS formatted media **FIRST. Repeat – COPY THE FILES FIRST!**

Do not rename files directly on the SD card.

Do not attempt to edit the files directly on the SD card.

Do not save **ANYTHING** to the SD card with a computer (such as the take log, note files etc) - it is formatted for DBSM recorder use only.

Do not open the files on the SD card with any third party program such as Wave Agent or Audacity and permit a save. In Wave Agent, do not IMPORT - you can OPEN and play it but do not save or Import - Wave Agent will corrupt the file.

In short - there should be NO manipulation of the data on the card or addition of data to the card with anything other than an DBSM/DBSMD recorder. Copy the files to a computer, thumb drive, hard drive, etc. that has been formatted as a regular OS device FIRST - then you can edit freely.

iXML HEADER SUPPORT

Recordings contain industry standard iXML chunks in the file headers, with the most commonly used fields filled in.

Turning Power ON

Short Button Press

When the unit is turned off, a short press of the power button (⏻) will turn the unit on in the Standby Mode with the RF output turned off.

RF indicator blinks

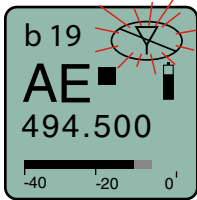

To enable RF output from the Standby Mode, press the Power button, select Rf On? option, then select yes.

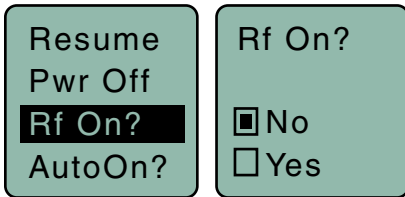

Long Button Press

When the unit is turned off, a long press of the power button will start a countdown to turn the unit on with the RF output turned on. Continue to hold the button until the countdown is complete.



Hold power button until the counter reaches 3

RF indicator not blinking

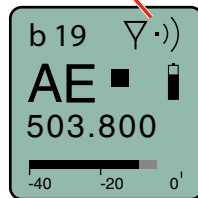

If the button is released before the countdown is completed, the unit will power up with the RF output turned off.

Power Button Menu

When the unit is already turned on, the Power Button is used to turn the unit off, or to access a setup menu.

A long press of the button turns the power off.

A short press of the button opens a menu for the following setup options. Select the option with the UP and DOWN arrow buttons then press MENU/SEL.

- **Resume** returns the unit to the previous screen and operating mode
- **Pwr Off** turns the unit off
- **Rf On?** turns the RF output on or off
- **AutoOn?** selects whether or not the unit will turn on automatically after a battery change
- **Blk606?** - enables Block 606 legacy mode for use with Block 606 receivers.
- **Remote** enables or disables the audio remote control (dweedle tones)
- **Bat Type** selects the type of battery in use
- **Backlit** sets the duration of the LCD backlight
- **Clock** sets the Year/Month/Day/Time
- **Locked** disables the control panel buttons
- **LED Off** enables/disables control panel LEDs

NOTE: The Blk606? feature is only available on Bands B1 or C1.

Menu Shortcuts

From the Main/Home Screen, the following shortcuts are available:

- **Record:** Press the MENU/SEL + UP arrow simultaneously
- **Stop Recording:** Press the MENU/SEL + DOWN arrow simultaneously

NOTE: The shortcuts are only available from the main/home screen AND when a microSDHC memory card is installed.

Transmitter Operating Instructions

- Install battery(s)
- Turn power on in the Standby mode (see previous section)
- Connect microphone and place it in the position where it will be used.
- Have the user talk or sing at the same level that will be used in the production, and adjust the input gain so that the **-20 LED blinks red on louder peaks**.

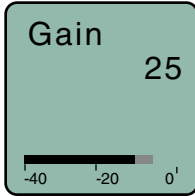

Use the UP and DOWN arrow buttons to adjust the gain until the -20 LED blinks red on louder peaks

Signal Level	-20 LED	-10 LED
Less than -20 dB	● Off	● Off
-20 dB to -10 dB	● Green	● Off
-10 dB to +0 dB	● Green	● Green
+0 dB to +10 dB	● Red	● Green
Greater than +10 dB	● Red	● Red

- Set the frequency and compatibility mode to match the receiver.
- Turn the RF output on with the **Rf On?** item in the power menu, or by turning the power off and then back on while holding the power button in and waiting for the counter to reach 3.

Recorder Operating Instructions

- Install battery(s)
- Insert microSDHC memory card
- Turn power on
- Format memory card
- Connect microphone and place it in the position where it will be used.
- Have user talk or sing at the same level that will be used in the production, and adjust the input gain so that the **-20 LED blinks red on louder peaks**

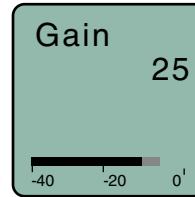

Use the UP and DOWN arrow buttons to adjust the gain until the -20 LED blinks red on louder peaks

Signal Level	-20 LED	-10 LED
Less than -20 dB	● Off	● Off
-20 dB to -10 dB	● Green	● Off
-10 dB to +0 dB	● Green	● Green
+0 dB to +10 dB	● Red	● Green
Greater than +10 dB	● Red	● Red

- Press MENU/SEL and choose Record from the menu

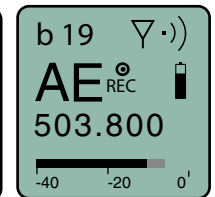
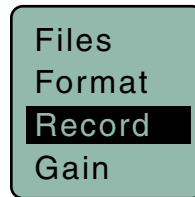

- To stop recording, press MENU/SEL and choose Stop; the word SAVED appears on the screen

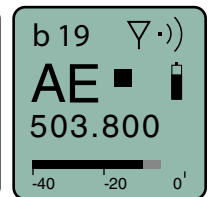
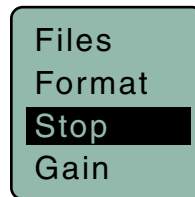

To play back the recordings, remove the memory card and copy the files onto a computer with video or audio editing software installed.

DBSM/DBSMD Main Menu

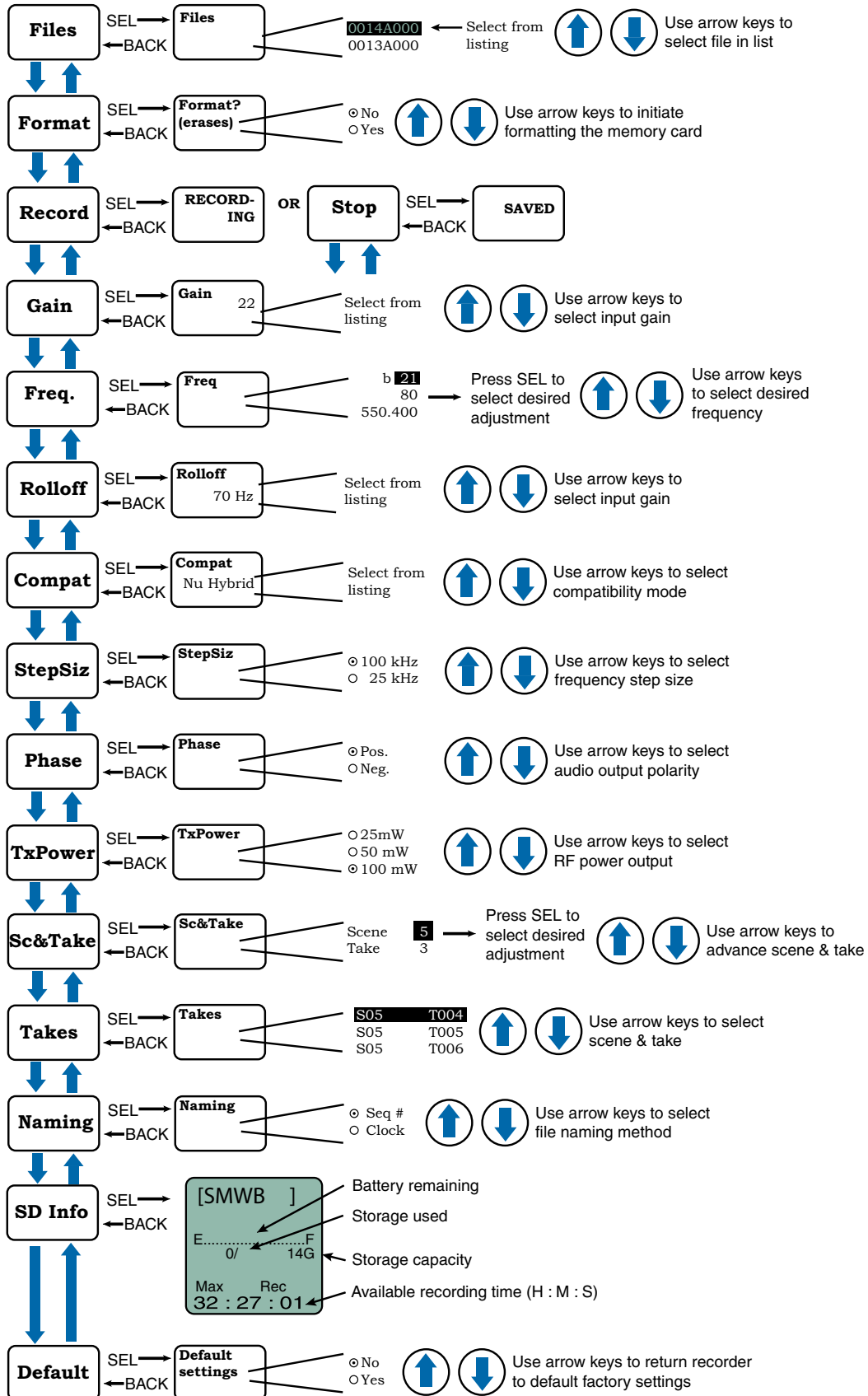

From the Main Window press MENU/SEL.

Use the UP/Down arrow keys to select the item.



DBSM/DBSMD Power Button Menu

From the Main Window press the power button. 

Use the UP/DOWN arrow keys to select the item.  

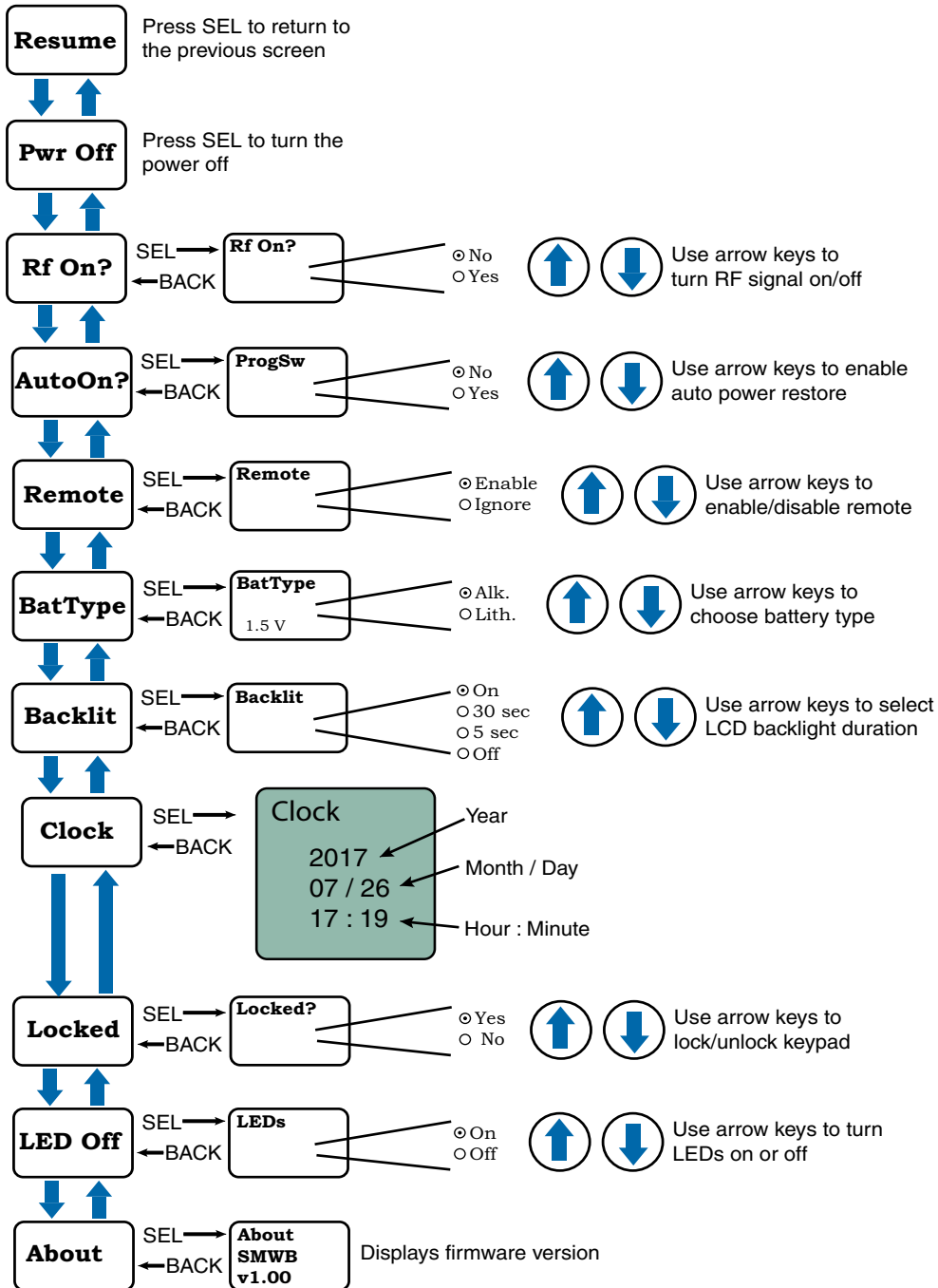

Setup Screen Details

Locking/Unlocking Changes to Settings

Changes to the settings can be locked in the Power Button Menu.

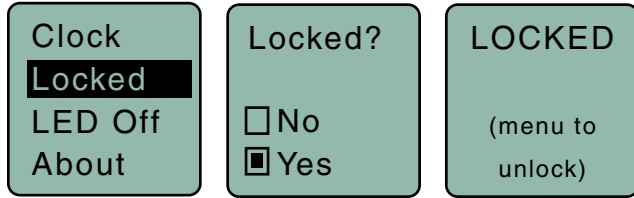

When changes are locked, several controls and actions can still be used:

- Settings can still be unlocked
- Menus can still be browsed
- When locked, **POWER CAN ONLY BE TURNED OFF** by removing the batteries.

Main Window Indicators

The Main Window displays the block number, Standby or Operating mode, operating frequency, audio level, battery status and programmable switch function. When the frequency step size is set at 100 kHz, the LCD will look like the following.

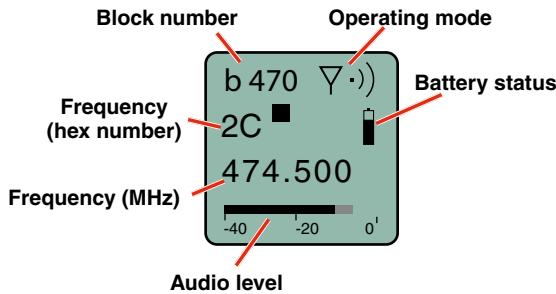

When the frequency step size is set to 25 kHz, the hex number will appear smaller and may include a fraction.

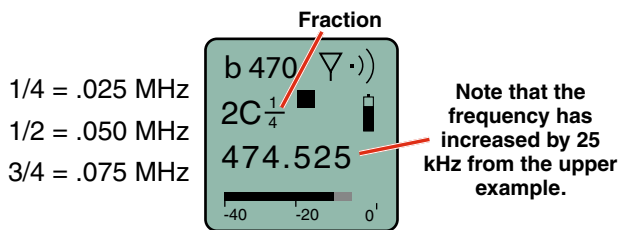

- 1/4 = .025 MHz
- 1/2 = .050 MHz
- 3/4 = .075 MHz

Changing the step size never changes the frequency. It only changes the way the user interface works. If the frequency is set to a fractional increment between even 100 kHz steps and the step size is changed to 100 kHz, the hex code will be replaced by two asterisks on the main screen and the frequency screen.

Frequency set to fractional 25 kHz step, but step size changed to 100 kHz.

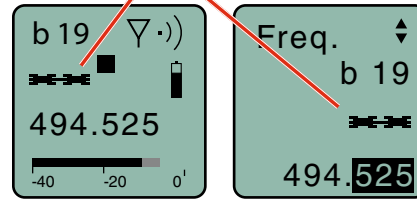

Connecting the Signal Source

Microphones, line level audio sources, and instruments can be used with the transmitter. Refer to the section entitled **Input Jack Wiring for Different Sources** for details on the correct wiring for line level sources and microphones to take full advantage of the Servo Bias circuitry.

Turning Control Panel LEDs ON/OFF

From the main menu screen, a quick press of the UP arrow button turns the control panel LEDs on. A quick press of the DOWN arrow button turns them off. The buttons will be disabled if the LOCKED option is selected in the Power Button menu.

The control panel LEDs can also be turned on and off with the **LED Off** option in the Power Button menu.

Helpful Features on Receivers

To aid in finding clear frequencies, several Lectrosonics receivers offer a **SmartTune** feature that scans the tuning range of the receiver and displays a graphical report that shows where RF signals are present at different levels, and areas where there is little or no RF energy present. The software then automatically selects the best channel for operation.

Lectrosonics receivers equipped with an **IR Sync** function allow the receiver to set frequency, step size and compatibility modes on the transmitter via an infrared link between the two units.

Files

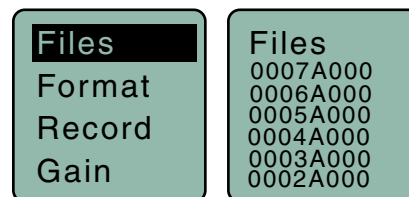

Select recorded files on microSDHC memory card.

Format

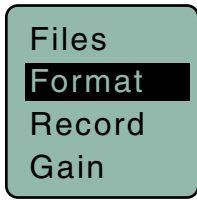

Formats the microSDHC memory card.

WARNING: This function erases any content on the microSDHC memory card.

Record or Stop

Begins recording or stops recording. (See page 7.)

Adjusting the Input Gain

The two bicolor Modulation LEDs on the control panel provide a visual indication of the audio signal level entering the transmitter. The LEDs will glow either red or green to indicate modulation levels as shown in the following table.

Signal Level	-20 LED	-10 LED
Less than -20 dB	● Off	● Off
-20 dB to -10 dB	● Green	● Off
-10 dB to +0 dB	● Green	● Green
+0 dB to +10 dB	● Red	● Green
Greater than +10 dB	● Red	● Red

NOTE: Full modulation is achieved at 0 dB, when the “-20” LED first turns red. The limiter can cleanly handle peaks up to 30 dB above this point.

It is best to go through the following procedure with the transmitter in the standby mode so that no audio will enter the sound system or recorder during adjustment.

- 1) With fresh batteries in the transmitter, power the unit on in the standby mode (see previous section **Turning Power ON and OFF**).
- 2) Navigate to the Gain setup screen.

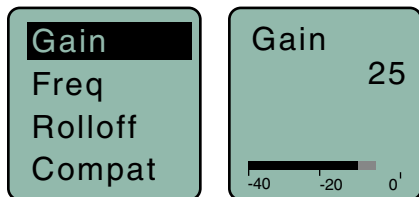

- 3) Prepare the signal source. Position a microphone the way it will be used in actual operation and have the user speak or sing at the loudest level that will occur during use, or set the output level of the instrument or audio device to the maximum level that will be used.
- 4) Use the \uparrow and \downarrow arrow buttons to adjust the gain until the **-10 dB** glows green and the **-20 dB** LED starts to flicker red during the loudest peaks in the audio.
- 5) Once the audio gain has been set, the signal can be sent through the sound system for overall level adjustments, monitor settings, etc.

- 6) If the audio output level of the receiver is too high or low, use only the controls on the receiver to make adjustments. Always leave the transmitter gain adjustment set according to these instructions, and do not change it to adjust the audio output level of the receiver.

Selecting Frequency

The setup screen for frequency selection offers several ways to browse the available frequencies.

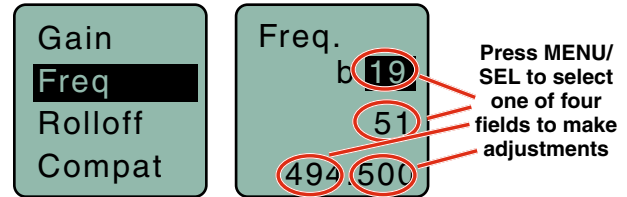

Each field will step through the available frequencies in a different increment. The increments are also different in the 25 kHz mode from the 100 kHz mode.

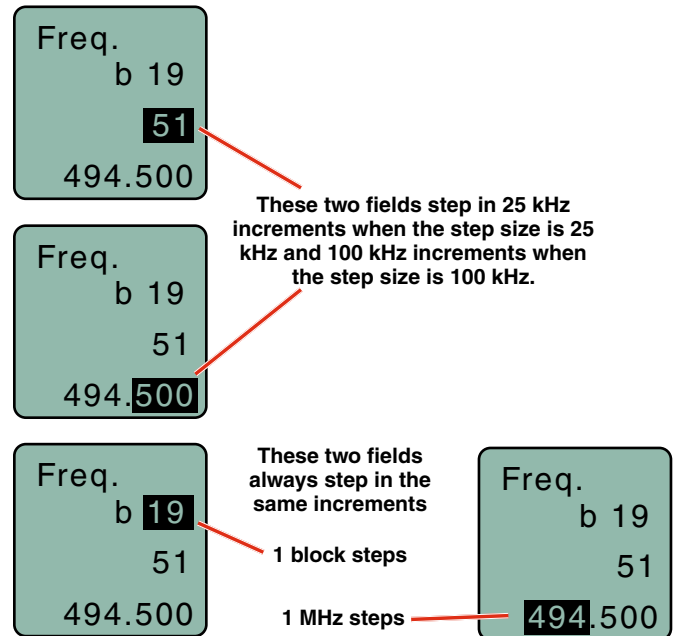



A fraction will appear next to the hex code in the setup screen and in the main window when the frequency ends in .025, .050 or .075 MHz.



All Lectrosonics Digital Hybrid Wireless® receivers provide a scanning function to quickly and easily find prospective frequencies with little or no RF interference. In other cases, a frequency may be specified by officials at a large event such as the Olympics or a major league ball game. Once the frequency is determined, set the transmitter to match the associated receiver.

Selecting Frequency Using Two Buttons

Hold the MENU/SEL button in, then use the  and  arrow buttons for alternate increments.

NOTE: You must be in the FREQ menu to access this feature. It is not available from the main/home screen.

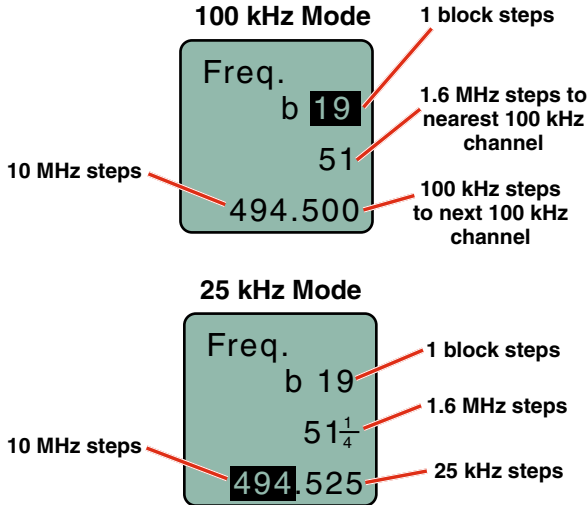

If the Step Size is 25 kHz with the frequency set between even 100 kHz steps and the Step Size is then changed to 100 kHz, the mismatch will cause the hex code to display as two asterisks.

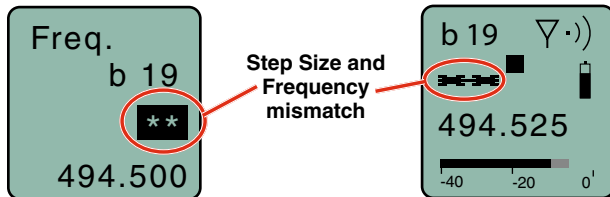

About Overlapping Frequency Bands

When two frequency bands overlap, it is possible to select the same frequency at the upper end of one and the lower end of the other. While the frequency will be the same, the pilot tones will be different, as indicated by the hex codes that appear.

In the following examples, the frequency is set to 494.500 MHz, but one is in band 470 and the other in band 19. This is done intentionally to maintain compatibility with receivers that tune across a single band. The band number and hex code must match the receiver to enable the correct pilot tone.

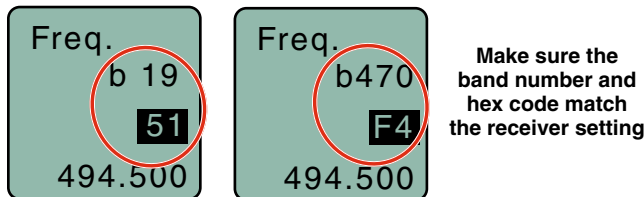

Selecting the Low Frequency Roll-off

It is possible that the low frequency roll-off point could affect the gain setting, so it's generally good practice to make this adjustment before adjusting the input gain. The point at which the roll-off takes place can be set to:

- LF 35 35 Hz
- LF 50 50 Hz
- LF 70 70 Hz
- LF 100 100 Hz
- LF 120 120 Hz
- LF 150 150 Hz

The roll-off is often adjusted by ear while monitoring the audio.

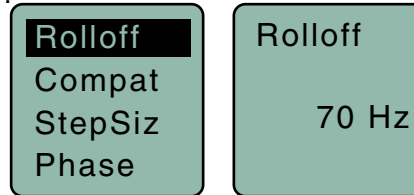

Selecting the Compatibility (Compat) Mode

When used with a Lectrosonics Digital Hybrid Wireless® receiver, the best audio quality will be achieved with the system set to the Nu Hybrid compatibility mode.

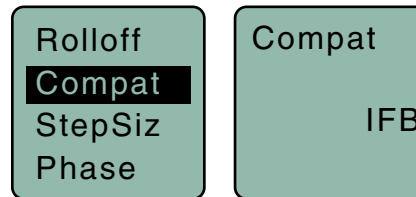

Use the UP and DOWN arrows to select the desired mode, then press the BACK button twice to return to the Main Window.

Compatibility modes are as follows:

Receiver Models	LCD menu item
SMWB/SMDWB:	
• Nu Hybrid:	Nu Hybrid
• Mode 3:*	Mode 3
• IFB Series:	IFB Mode

Mode 3 works with certain non-Lectrosonics models. Contact the factory for details.

NOTE: If your Lectrosonics receiver does not have Nu Hybrid mode, set the receiver to Euro Digital Hybrid Wireless® (EU Dig. Hybrid).

Receiver Models	LCD menu item
SMWB/SMDWB/E01:	
• Digital Hybrid Wireless®:	EU Hybr
• Mode 3:	Mode 3*
• IFB Series:	IFB Mode

* Mode works with certain non-Lectrosonics models. Contact the factory for details.

Receiver Models LCD menu item

SMWB/SMDWB/X:

- Digital Hybrid Wireless®: NA Hybr
- Mode 3:* Mode 3
- 200 Series: 200 Mode
- 100 Series: 100 Mode
- Mode 6:* Mode 6
- Mode 7:* Mode 7
- IFB Series: IFB Mode

Modes 3, 6 and 7 work with certain non-Lectrosonics models. Contact the factory for details.

Selecting Step Size

This menu item allows frequencies to be selected in either 100 kHz or 25 kHz increments.

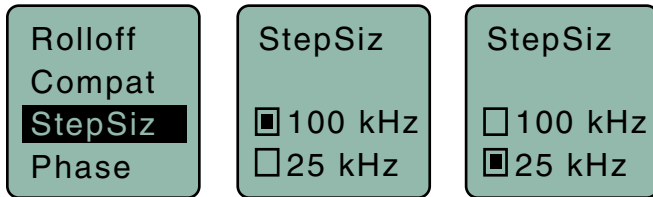

If the desired frequency ends in .025, .050 or .075 MHz, the 25 kHz step size must be selected.

Selecting Audio Polarity (Phase)

Audio polarity can be inverted at the transmitter so the audio can be mixed with other microphones without comb filtering. The polarity can also be inverted at the receiver outputs.

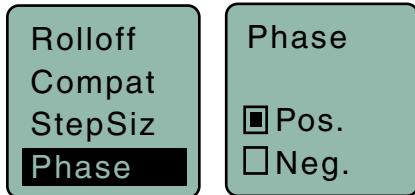

Setting Transmitter Output Power

The output power can be set to:

SMWB/SMDWB, /X

- 25, 50 or 100 mW

/E01

- 10, 25 or 50 mW

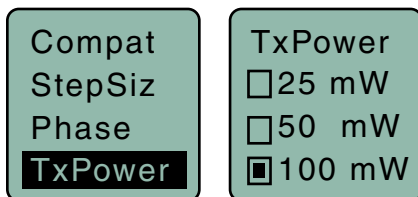

Setting Scene and Take Number

Use UP and DOWN arrows to advance Scene and Take and MENU/SEL to toggle. Press the BACK button to return to menu.

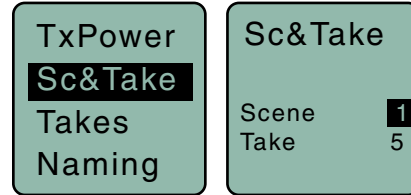

Choosing Takes for Replay

Use UP and DOWN arrows to toggle and MENU/SEL to play back.

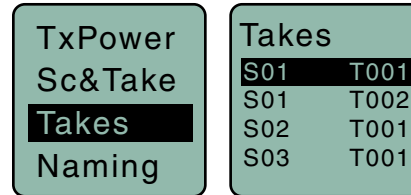

Recorded File Naming

Choose to name the recorded files by the sequence number or by the clock time.

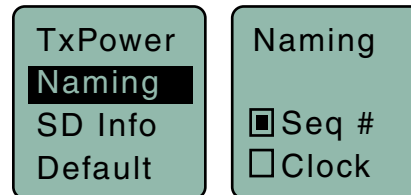

SD Info

Information regarding the microSDHC memory card including space remaining on card.

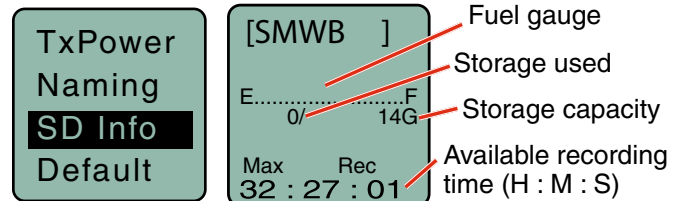

Restoring Default Settings

This is used to restore the factory settings.

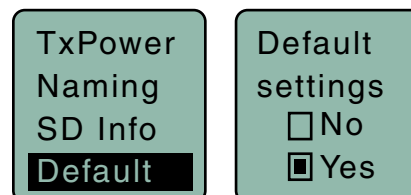

5-Pin Input Jack Wiring

The wiring diagrams included in this section represent the basic wiring necessary for the most common types of microphones and other audio inputs. Some microphones may require extra jumpers or a slight variation on the diagrams shown.

It is virtually impossible to keep completely up to date on changes that other manufacturers make to their products, thus you may encounter a microphone that differs from these instructions. If this occurs please call our toll-free number listed under Service and Repair in this manual or visit our web site at:

www.lectrosonics.com

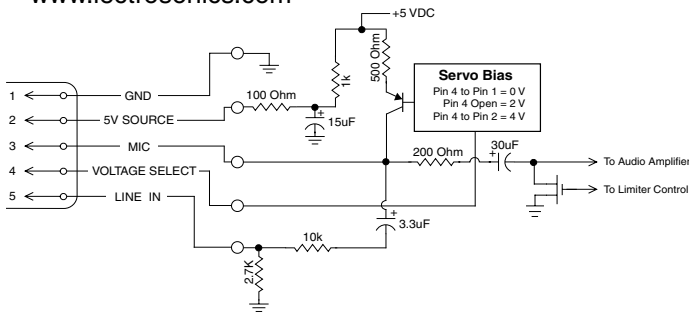

Audio input jack wiring:

PIN 1

Shield (ground) for positive biased electret lavalier microphones. Shield (ground) for dynamic microphones and line level inputs.

PIN 2

Bias voltage source for positive biased electret lavalier microphones that are not using servo bias circuitry and voltage source for 4 volt servo bias wiring.

PIN 3

Microphone level input and bias supply.

PIN 4

Bias voltage selector for Pin 3.
Pin 3 voltage depends on Pin 4 connection.

Pin 4 tied to Pin 1: 0 V

Pin 4 Open: 2 V

Pin 4 to Pin 2: 4 V

PIN 5

Line level input for tape decks, mixer outputs, musical instruments, etc.

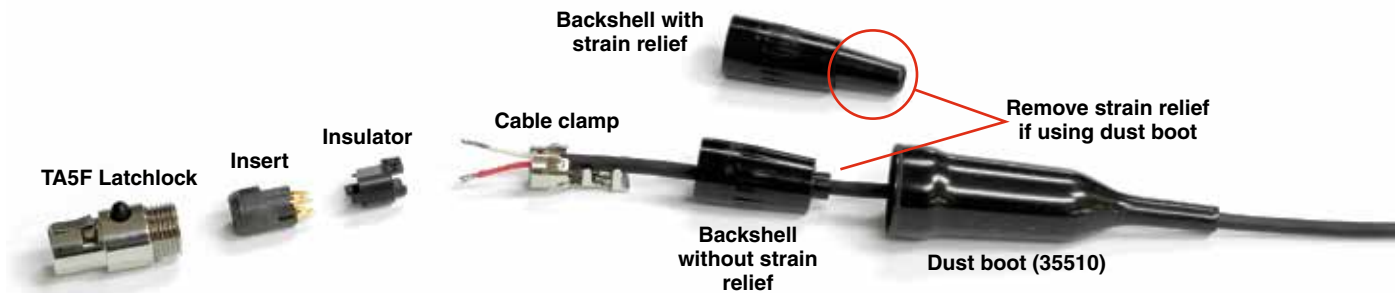

Note: If you use the dust boot, remove the rubber strain relief that is attached to the TA5F cap, or the boot will not fit over the assembly.

Installing the Connector:

- 1) If necessary, remove the old connector from the microphone cable.
- 2) Slide the dust boot onto microphone cable with the large end facing the connector.
- 3) If necessary, slide the 1/8-inch black shrink tubing onto the microphone cable. This tubing is needed for some smaller diameter cables to ensure there is a snug fit in the dust boot.
- 4) Slide the backshell over the cable as shown above. Slide the insulator over the cable before soldering the wires to the pins on the insert.
- 5) Solder the wires and resistors to the pins on the insert according to the diagrams shown in **Wiring Hookups for Different Sources**. A length of .065 OD clear tubing is included if you need to insulate the resistor leads or shield wire.
- 6) If necessary, remove the rubber strain relief from the TA5F backshell by simply pulling it out.
- 7) Seat the insulator on the insert. Slide the cable clamp over the end of the insulator and crimp as shown on the next page.
- 8) Insert the assembled insert/insulator/clamp into the latchlock. Make sure the tab and slot align to allow the insert to fully seat in the latchlock. Thread the backshell onto the latchlock.

Microphone Cable Termination for Non-Lectrosonics Microphones

TA5F Connector Assembly

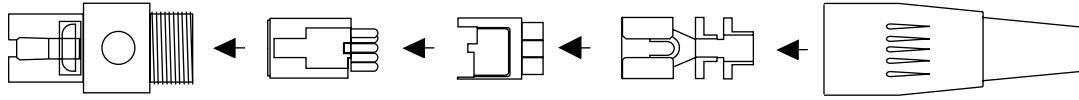

Mic Cord Stripping Instructions

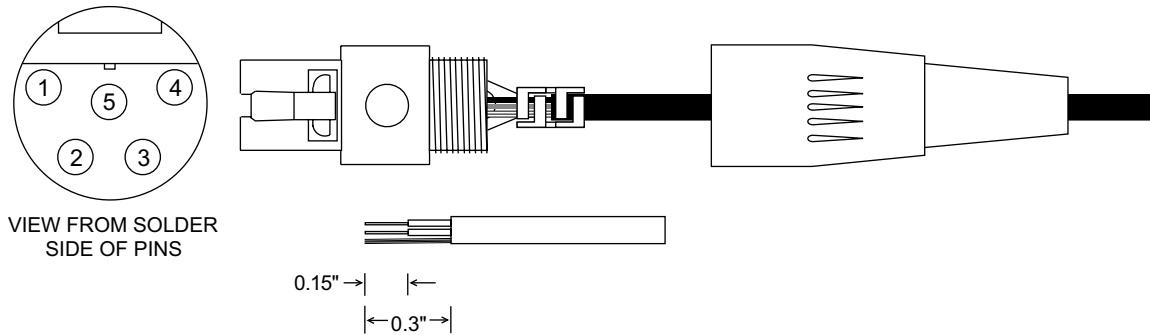

Crimping to Shield and Insulation

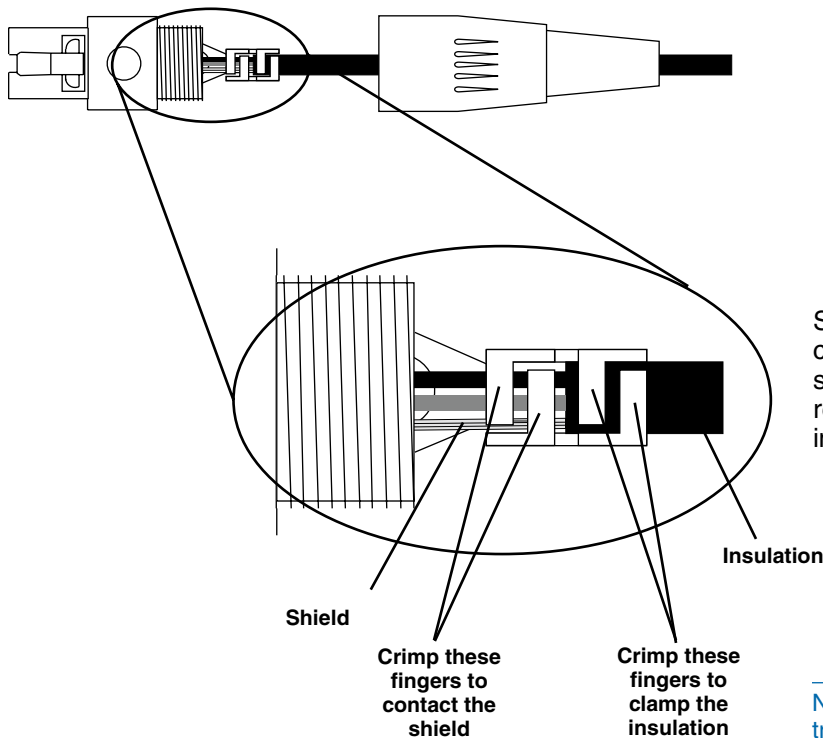

Strip and position the cable so that the clamp can be crimped to contact both the mic cable shield and the insulation. The shield contact reduces noise with some microphones and the insulation clamp increases ruggedness.

NOTE: This termination is intended for UHF transmitters only. VHF transmitters with 5-pin jacks require a different termination. Lectrosonics lavalier microphones are terminated for compatibility with VHF and UHF transmitters, which is different from what is shown here.

Input Jack Wiring for Different Sources

In addition to the microphone and line level wiring hooks-ups illustrated below, Lectrosonics makes a number of cables and adapters for other situations such as connecting musical instruments (guitars, bass guitars, etc.) to the transmitter. Visit www.lectrosonics.com and click on Accessories, or download the master catalog.

A lot of information regarding microphone wiring is also available in the FAQ section of the web site at:

<http://www.lectrosonics.com/faqdb>

Follow the instructions to search by model number or other search options.

Compatible Wiring for Both Servo Bias Inputs and Earlier Transmitters:

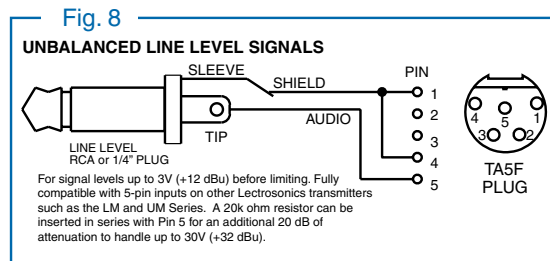
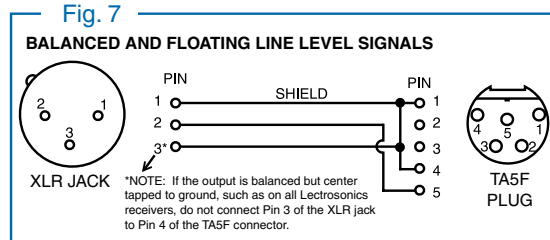
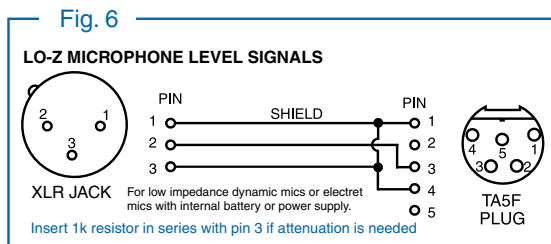
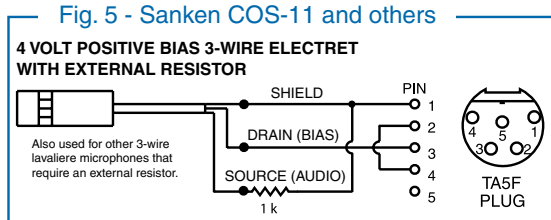
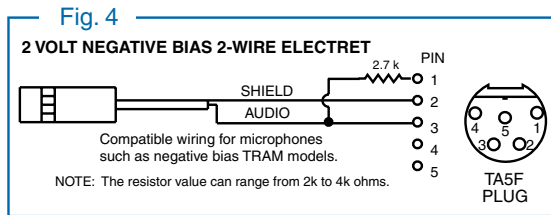
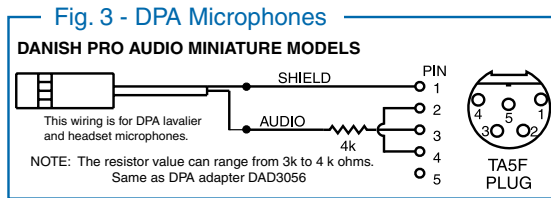
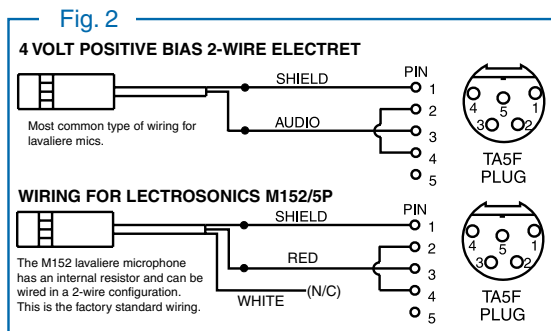
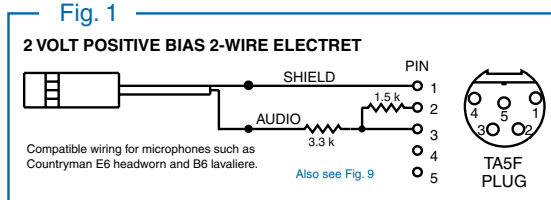

Simple Wiring - Can ONLY be used with Servo Bias Inputs:

Servo Bias was introduced in 2005 and all transmitters with 5-pin inputs have been built with this feature since 2007.

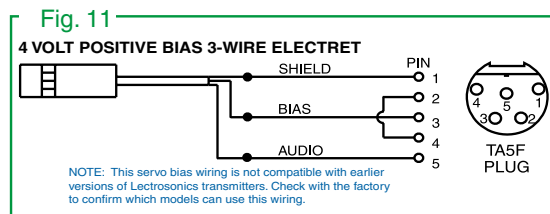
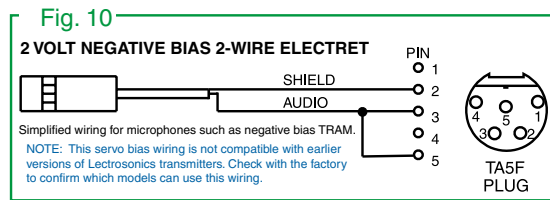
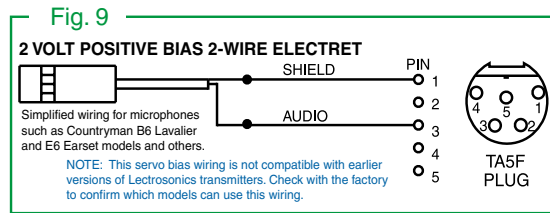

Microphone RF Bypassing

When used on a wireless transmitter, the microphone element is in the proximity of the RF coming from the transmitter. The nature of electret microphones makes them sensitive to RF, which can cause problems with microphone/transmitter compatibility. If the electret microphone is not designed properly for use with wireless transmitters, it may be necessary to install a chip capacitor in the mic capsule or connector to block the RF from entering the electret capsule.

Some mics require RF protection to keep the radio signal from affecting the capsule, even though the transmitter input circuitry is already RF bypassed.

If the mic is wired as directed, and you are having difficulty with squealing, high noise, or poor frequency response, RF is likely to be the cause.

The best RF protection is accomplished by installing RF bypass capacitors at the mic capsule. If this is not possible, or if you are still having problems, capacitors can be installed on the mic pins inside the TA5F connector housing. Refer to the diagram below for the correct locations of capacitors.

Use 330 pF capacitors. Capacitors are available from Lectrosonics. Please specify the part number for the desired lead style.

Leaded capacitors: P/N 15117

Leadless capacitors: P/N SCC330P

All Lectrosonics lavalier mics are already bypassed and do not need any additional capacitors installed for proper operation.

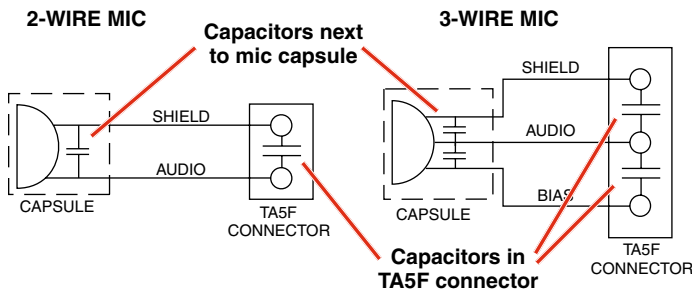

Line Level Signals

The wiring for line level and instrument signals is:

- Signal Hot to pin 5
- Signal Gnd to pin 1
- Pin 4 jumped to pin 1

This allows signal levels up to 3V RMS to be applied without limiting.

NOTE for line level inputs only (not instrument): If more headroom is needed, insert a 20 k resistor in series with pin 5. Put this resistor inside the TA5F connector to minimize noise pickup. The resistor will have little or no effect on the signal if the input is set for instrument.

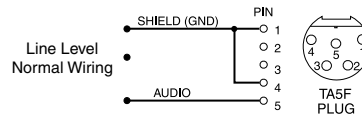

See Fig. 8 on previous page

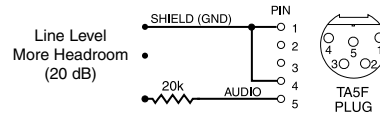

Firmware Update

Firmware updates are made using a microSDHC memory card. Download and copy the following firmware update files to a drive on your computer.

- **smwb vX_xx.ldr** is the firmware update file, where “X_xx” is the revision number.

In the computer:

- 1) Perform a **Quick Format** of the card. On a Windows-based system, this will automatically format the card to the FAT32 format, which is the Windows standard. On a Mac, you may be given several options. If the card is already formatted in Windows (FAT32) - it will be greyed out - then you do not need to do anything. If the card is in another format, choose Windows (FAT32) and then click “Erase”. When the quick format on the computer is complete, close the dialogue box and open the file browser.
- 2) Copy the **smwb vX_xx.ldr** file to the memory card, then safely eject the card from the computer.

In the SMWB:

- 1) Leave the SMWB turned off and insert the microSDHC memory card into the slot.
- 2) Hold down both the UP and DOWN arrow buttons on the recorder and turn the power on.
- 3) The recorder will boot up into the firmware update mode with the following options on the LCD:
 - **Update** - Displays a scrollable list of the .ldr files on the card.
 - **Power Off** - Exits the update mode and turns the power off.

NOTE: If the unit screen shows **FORMAT CARD?**, power the unit off and repeat step 2. You were not properly pressing UP, DOWN and Power at the same time.

- 4) Use the arrow buttons to select **Update**. Use the UP and DOWN arrow buttons to select the desired file and press MENU/SEL to install the firmware. The LCD will display status messages while the firmware is being updated.
- 5) When the update is complete, the LCD will display this message: **UPDATE SUCCESSFUL REMOVE CARD**. Open the battery door and remove the memory card.
- 6) Re-attach the battery door and power the unit back on. Verify that the firmware version was updated by opening the Power Button Menu and navigating to the **About** item. **See page 6.**

- 7) If you re-insert the update card and turn the power back on for normal use, the LCD will display a message prompting you to format the card:

Format Card? (files lost)

- No
- Yes

If you wish to record audio on the card, you must re-format it. Select **Yes** and press MENU/SEL to format the card. When the process is complete, the LCD will return to the Main Window and be ready for normal operation.

If you choose to keep the card as is, you may remove the card at this time.

The firmware update process is managed by a bootloader program - on very rare occasions, you might need to update the bootloader.

WARNING: Updating the bootloader can corrupt your unit if interrupted. Don't update the bootloader unless advised to do so by the factory.

- **smwb_boot vX_xx.ldr** is the bootloader file

Follow the same process as with a firmware update and select the smwbboot file.

Recovery Process

In the event of a battery failure while the unit is recording, a recovery process is available to restore the recording in proper format. When a new battery is installed and the unit is turned back on, the recorder will detect the missing data and prompt you to run the recovery process. ***The file must be recovered or the card will not be usable in the DBSM/DBSMD.***

First it will read:

***Interrupted Recording
Found***

The LCD message will ask:

***Recover?
for safe use
see manual***

You will have the choice of **No** or **Yes** (No is selected as the default). If you wish to recover the file, use the DOWN arrow button to select **Yes**, then press MENU/SEL.

The next window will give you the option to recover all or part of the file. The default times shown are the best guess by the processor where the file stopped recording. The hours will be highlighted and you can either accept the value shown or select a longer or shorter time. If you are unsure, simply accept the value shown as the default.

Press MENU/SEL and the minutes are then highlighted. You can increase or decrease the time to be recovered. In most cases you can simply accept the values shown and the file will be recovered. After you have made your time choices, press MENU/SEL again. A small **GO!** symbol will appear next to the DOWN arrow button. Pressing the button will initiate the file recovery. The recovery will happen quickly and you will see:

***Recovery
Successful***

Special Note:

Files under 4 minutes long may recover with additional data “tacked on” to the end of the file (from previous recordings or data if the card had been used previously). This can be effectively eliminated in post with a simple delete of the unwanted extra “noise” at the end of the clip. The minimum recovered length will be one minute. For example, if the recording is only 20 seconds long, and you have selected one minute there will be the desired 20 recorded seconds with an additional 40 seconds of other data and or artifacts in the file. If you are uncertain about the length of the recording you can save a longer file - there will simply be more “junk” at the end of the clip. This “junk” may include audio data recorded in earlier sessions that were discarded. This “extra” information can be easily deleted in post production editing software at a later time.

Silver Paste on Transmitter Thumbscrews

Silver paste is applied to thumbscrew threads on new units at the factory to improve the electrical connection from the battery compartment through the housing on any DBSM/DBSMD transmitter. This applies to the standard battery door and the battery eliminator.



The small enclosed vial contains a tiny amount (25 mg) of silver conductive paste. A small speck of this paste will improve the conductivity between the battery cover plate thumbscrew and the case of the DBSM/DBSMD.



With improved conductivity (lower resistance) more of the battery voltage can get to the internal power supplies causing reduced current drain and longer battery life. Though the amount seems very small, it is enough for years of use. It is, in fact, 25 times the amount that we use on the thumbscrews at the factory.

To apply the silver paste, first completely remove the cover plate from the housing by backing the thumbscrew completely out of the case. Use a **clean, soft cloth** to clean the threads of the thumbscrew.

NOTE: Do NOT use alcohol or a liquid cleaner.

Simply hold the cloth around the threads and turn the thumbscrew. Move to a new spot on the cloth and do it again. Do this until the cloth remains clean. Now, clean the threads in the case by using a dry cotton swab (Q-tip) or equivalent. Again, clean the case threads until a fresh cotton swab comes away clean.

Open the vial, and transfer a pinhead speck of silver paste to the second thread from the end of the thumbscrew. A easy way to pickup a speck of paste is to partially unfold a paper clip and use the end of the wire to acquire a tiny bit of paste. A toothpick will also work. An amount that covers the end of the wire is sufficient.

Apply paste to second thread from end of thumbscrew



It is not necessary to spread the paste more than a little bit on the thread as the paste will spread itself every time the thumbscrew is screwed in and out of the case during battery changes.

Do not apply the paste to any other surfaces. The cover plate itself can be cleaned with a clean cloth by rubbing the slightly raised rings on the plate where it contacts the battery terminal. All you want to do is to remove any oils or dirt on the rings. Do not abrade these surfaces with a harsh material such as a pencil eraser, emery paper, etc., as this will remove the conductive nickel plating and expose the underlying aluminum, which is a poor contact conductor.

Straight Whip Antennas

Antennas are supplied by the factory according to the following table:

BAND	BLOCKS COVERED	SUPPLIED ANTENNA
A1	470, 19, 20	AMM19
B1	21, 22, 23	AMM22

The supplied caps can be used several different ways:

- 1) A color cap on the end of the whip
- 2) A color sleeve next to the connector with a black cap on the end of the whip (trim the closed end of the colored cap off with scissors to make a sleeve).
- 3) A color sleeve and color cap (cut the cap in half with scissors).

This is a full size cutting template used to cut the length of the whip for a particular frequency. Lay the uncut antenna on top of this drawing and trim the whip length to the desired frequency.

After cutting the antenna to the desired length, mark the antenna by installing a color cap or sleeve to indicate the frequency. Factory labeling and marking is listed in the table below.

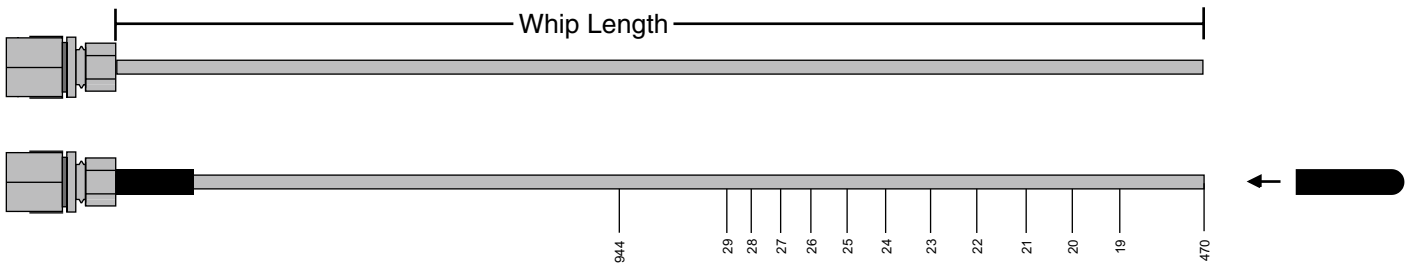

Note: Check the scale of your printout. This line should be 6.00 inches long (152.4 mm).

Factory Marking and Labeling

BLOCK	FREQUENCY RANGE	CAP/SLEEVE COLOR	ANTENNA LENGTH
470	470.100 - 495.600	Black w/ Label	5.67 in./144.00 mm.
19	486.400 - 511.900	Black w/ Label	5.23 in./132.80 mm.
20	512.000 - 537.575	Black w/ Label	4.98 in./126.50 mm.
21	537.600 - 563.100	Brown w/ Label	4.74 in./120.40 mm.
22	563.200 - 588.700	Red w/ Label	4.48 in./113.80 mm.
23	588.800 - 607.950	Orange w/ Label	4.24 in./107.70 mm.

 Shaded cells are factory supplied antennas

NOTE: Not all Lectrosonics products are built on all of the blocks covered in this table. Factory supplied antennas pre-cut to length include a label with the frequency range.

Belt Clips and Pouches

SMWB Single Battery Model

SMWBBCUP



Wire clip for single battery model; antenna points UP when unit is worn on a belt.

SMWBBCDN



Wire clip for single battery model; antenna points DOWN when unit is worn on a belt.

SMWBBCUPSL



Spring-loaded clip; antenna points UP when unit is worn on a belt.

SMWBBCDNSL



Spring-loaded clip; antenna points DOWN when unit is worn on a belt.

PSMWB



Sewn leather pouch for single battery model; plastic window allows access to control panel.

SMDWB Dual Battery Model

SMDWBBCSL



Wire clip for dual battery model antenna points UP when unit is worn on a belt; can be installed for UP or DOWN antenna.

SMDWBBCSL



Spring-loaded clip for dual battery model; can be installed for UP or DOWN antenna.

PSMDWB



Sewn leather pouch for dual battery model; plastic window allows access to control panel.

Miscellaneous Accessories

SMKITTA5



Mic cable not included

TA5 connector kit; with sleeves for small or larger cable; mic cable not included

SMSILVER



Small vial of silver paste for use on battery door retaining knob threads

Add cable accessories for 5-pin LEMO to TA5 and BNC to TA5 for TC jam sync. Four accessory cables will be required to accommodate both style connectors:

- 1) 5-pin LEMO to TA5
- 2) BNC to TA5
- 3) 5-pin LEMO to 3-pin LEMO
- 4) BNC to 3-pin LEMO

55010



MicroSDHC memory card with SD adapter. UHS-I; Class 10; 16 GB. Brand may vary.

35924



Foam insulating pads attached to the side of the transmitter when it is worn very close to or on the user's skin.
(pkg of two)

LectroRM

By New Endian LLC

LectroRM is a mobile application for iOS and Android smart phone operating systems. Its purpose is to make changes to the settings on select Lectrosonics transmitters by delivering encoded audio tones to the microphone attached to the transmitter. When the tone enters the transmitter, it is decoded to make a change to a variety of different settings such as input gain, frequency and a number of others.

The app was released by New Endian, LLC in September 2011. The app is available for download and sells for about \$25 on the Apple App Store and Google Play Store.

The settings and values that can be changed vary from one transmitter model to another. The complete list of available tones in the app is as follows:

- Input gain
- Frequency
- Sleep Mode
- Panel LOCK/UNLOCK
- RF output power
- Low frequency audio roll-off
- LEDs ON/OFF

The user interface involves selecting the audio sequence related to the desired change. Each version has an interface for selecting the desired setting and the desired option for that setting. Each version also has a mechanism to prevent accidental activation of the tone.

iOS



The iPhone version keeps each available setting on a separate page with the list of options for that setting. On iOS, the “Activate” toggle switch must be enabled to show the button which will then activate the tone. The iOS version’s default orientation is upside-down but can be configured to orient right-side up. The purpose for this is to orient the phone’s speaker, which is at the bottom of the device, closer to the transmitter microphone.

Android

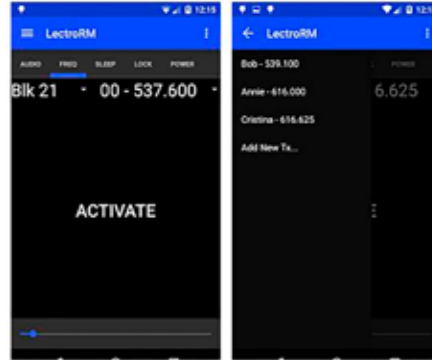

The Android version keeps all settings on the same page and allows the user to toggle between the activation buttons for each setting. The activation button must be pressed and held to activate the tone. The Android version also allows users to keep a configurable list of full sets of settings.

Activation

For a transmitter to respond to remote control audio tones, the transmitter must meet certain requirements:

- The transmitter must be turned on.
- The transmitter must have firmware version 1.5 or later for Audio, Frequency, Sleep and Lock changes.
- The transmitter microphone must be within range.
- The remote control function must be enabled on the transmitter.

Please be aware this app is not a Lectrosonics product. It is privately owned and operated by New Endian LLC, www.newendian.com.

Specifications

Operating frequencies:

DBSM(D)-A1B1: Band A1-B1: 470.100 - 607.950
DBSMD(D)/E01-A1B1: Band A1-B1: 470.100 - 614.375

NOTE: It's the user's responsibility to select the approved frequencies for the region where the transmitter is operating

Channel Spacing: 25 kHz
RF Power output: DBSM-A1B1: 10, 25 or 50 mW
 DBSMD-A1B1: 10, 25 or 50 mW
Compatibility Modes: DBSM-A1B1/DBSMD-A1B1: Encrypted digital and high density
Modulation Type: 8 PSK
Frequency stability: ± 0.002%
Spurious radiation: Compliant with ETSI EN 300 422-1
Equivalent input noise: -125 dBV, A-weighted
Input level:
 If set for dynamic mic: 0.5 mV to 50 mV before limiting
 Greater than 1 V with limiting
 If set for electret lavaliere mic: 1.7 uA to 170 uA before limiting
 Greater than 5000 uA (5 mA) with limiting
Line level input: 17 mV to 1.7 V before limiting
 Greater than 50 V with limiting
Input impedance:
 Dynamic mic: 300 Ohms
 Electret lavaliere: Input is virtual ground with servo adjusted constant current bias
Line level: 2.7 k ohms
Input limiter: Soft limiter, 30 dB range
Bias voltages: Fixed 5 V at up to 5 mA
 Selectable 2 V or 4 V servo bias for any electret lavaliere
Gain control range: -7 to 44 dB; panel mounted membrane switches
Modulation indicators: Dual bicolor LEDs indicate modulation
 -20, -10, 0, +10 dB referenced to full modulation
Controls: Control panel w/ LCD and 4 membrane switches
Low frequency roll-off: Adjustable from 20 to 150 Hz
Input
 Type: Analog mic/line level compatible; servo bias preamp for 2V and 4V lavaliere microphones
 Input level: • Dynamic mic: 0.5 mV to 50 mV
 • Electret mic: Nominal 2 mV to 300 mV
 • Line level: 17 mV to 1.7 V
 Input connector: TA5M 5-pin male
Audio Performance
 Frequency response: 20Hz to 20kHz, +/- 1dB: Encrypted Digital Mode.
 20Hz to 11.3KHz, +/- 3dB: High Density (HD) Mode (CH)
 Dynamic range: 110 dB (A), before limiting
 Distortion: < 0.035%
Antenna: Flexible, unbreakable steel cable.
Battery: AA, disposable, Lithium recommended
Battery Life w/ AA:

DBSM-A1B1 (1 AA):	4.4hrs
DBSMD-A1B1 (2 AA):	11.2 hrs

Weight w/ battery(s):

DBSM-A1B1: 3.2 oz. (90.719 grams)
 DBSMD-A1B1: 4.8 oz. (136.078 grams)

Overall Dimensions: (without microphone)

DBSM-A1B1: 2.366 x 1.954 x 0.642 inches;
 60.096 x 49.632 x 16.307 mm
 DBSMD-A1B1: 2.366 x 2.475 x 0.642 inches;
 60.096 x 62.865 x 16.307 mm

Emission Designator:

DBSM-A1B1/DBSMD-A1B1: 170KG1E

Recorder

Storage media: microSDHC memory card

File format: .wav files (BWF)

A/D converter: 24-bit

Sampling rate: 44.1 kHz

Recording modes/Bit rate:
 • HD mono mode: 24 bit - 144 kbytes/s

Input

Type: Analog mic/line level compatible; servo bias preamp for 2V and 4V lavaliere microphones

Input level:
 • Dynamic mic: 0.5 mV to 50 mV
 • Electret mic: Nominal 2 mV to 300 mV
 • Line level: 17 mV to 1.7 V

Input connector: TA5M 5-pin male

Audio Performance

Frequency response: 20Hz to 20kHz, +/- 1dB: Encrypted Digital Mode.
 20Hz to 11.3KHz, +/- 3dB: High Density (HD) Mode (CH)

Dynamic range: 110 dB (A), before limiting

Distortion: < 0.035%

Operating temperature range

Celsius: -20 to 50

Fahrenheit: -5 to 122

Specifications subject to change without notice.

Available Recording Time

Using a microSDHC* memory card, the approximate recording times are as follows. The actual time may vary slightly from the values listed in the tables.

(HD mono mode)

Size	Hrs:Min
8GB	11:12
16GB	23:00
32GB	46:07



*microSDHC Logo is a trademark of SD-3C, LLC

Troubleshooting

Symptom:

Transmitter Battery LED off when Power Switch “ON”

No Transmitter Modulation LEDs when Signal Should be Present

Receiver Indicates RF But No Audio

Receiver RF Indicator Off

No Sound (Or Low Sound Level), Receiver Indicates Proper Audio Modulation

Distorted Sound

Wind Noise or Breath “Pops”

Hiss and Noise -- Audible Dropouts

It is important that you follow these steps in the sequence listed.

Possible Cause:

1. Batteries are inserted incorrectly.
 2. Batteries are low or dead.
1. Gain control turned all the way down.
 2. Batteries are inserted incorrectly. Check power LED.
 3. Mic capsule is damaged or malfunctioning.
 4. Mic cable damaged or miswired.
 5. Instrument Cable damaged or not plugged in.
 6. Musical instrument output level set too low.
1. Audio source or cable connected to transmitter is defective. Try using an alternate source or cable.
 2. Make sure the compatibility mode is the same on transmitter and receiver.
 3. Ensure musical instrument volume control is not set to minimum.
 4. Check for correct pilot tone indication on the receiver. See item on page 16 entitled **About Overlapping Frequency Bands**.
1. Ensure that the transmitter and receiver are set to the same frequency, and that the hex code matches.
 2. Transmitter not turned on, or battery is dead.
 3. Receiver antenna missing or improperly positioned.
 4. Operating distance is too great.
 5. Transmitter may be set to the Standby Mode. See page 8.
1. Receiver output level set too low.
 2. Receiver output is disconnected; cable is defective or miswired.
 3. Sound system or recorder input is turned down.
1. Transmitter gain (audio level) is too high. Check Modulation LEDs on transmitter and receiver while distortion is being heard.
 2. Receiver output level may be mismatched with the sound system or recorder input. Adjust output level on receiver to the correct level for the recorder, mixer or sound system.
 3. Transmitter and receiver may not be set to the same compatibility mode. Some mis-matched combinations will pass audio.
 4. RF interference. Reset both transmitter and receiver to a clear channel. Use scanning function on receiver if available.
1. Reposition microphone, or use a larger windscreen, or both.
 2. Omni-directional mics produce less wind noise and breath pops than directional types.
1. Transmitter gain (audio level) far too low.
 2. Receiver antenna missing or obstructed.
 3. Operating distance too great.
 4. RF interference. Reset both transmitter and receiver to a clear channel. Use scanning function on receiver if available.
 5. Musical instrument output set too low.
 6. Microphone capsule picking up RF noise. See item on page 21 entitled **Microphone RF Bypassing**.

Excessive Feedback (With Microphone)

1. Transmitter gain (audio level) too high. Check gain adjustment and/or reduce receiver output level.
2. Microphone too close to speaker system.
3. Microphone is too far from user's mouth.

Slow Card Warning While Recording



1. This error alerts the user to the fact that the card is unable to keep up with the speed at which the SMWB is recording data.
2. This creates tiny gaps in the recording.
3. This may present an issue when the recording is to be synchronized with other audio or video.

Service and Repair

If your system malfunctions, you should attempt to correct or isolate the trouble before concluding that the equipment needs repair. Make sure you have followed the setup procedure and operating instructions. Check the interconnecting cables and then go through the **Troubleshooting** section in this manual.

We strongly recommend that you **do not** try to repair the equipment yourself and **do not** have the local repair shop attempt anything other than the simplest repair. If the repair is more complicated than a broken wire or loose connection, send the unit to the factory for repair and service. Don't attempt to adjust any controls inside the units. Once set at the factory, the various controls and trimmers do not drift with age or vibration and never require readjustment. **There are no adjustments inside that will make a malfunctioning unit start working.**

LECTROSONICS' Service Department is equipped and staffed to quickly repair your equipment. In warranty repairs are made at no charge in accordance with the terms of the warranty. Out-of-warranty repairs are charged at a modest flat rate plus parts and shipping. Since it takes almost as much time and effort to determine what is wrong as it does to make the repair, there is a charge for an exact quotation. We will be happy to quote approximate charges by phone for out-of-warranty repairs.

Returning Units for Repair

For timely service, please follow the steps below:

- A.** DO NOT return equipment to the factory for repair without first contacting us by email or by phone. We need to know the nature of the problem, the model number and the serial number of the equipment. We also need a phone number where you can be reached 8 A.M. to 4 P.M. (U.S. Mountain Standard Time).
- B.** After receiving your request, we will issue you a return authorization number (R.A.). This number will help speed your repair through our receiving and repair departments. The return authorization number must be clearly shown on the **outside** of the shipping container.
- C.** Pack the equipment carefully and ship to us, shipping costs prepaid. If necessary, we can provide you with the proper packing materials. UPS is usually the best way to ship the units. Heavy units should be "double-boxed" for safe transport.
- D.** We also strongly recommend that you insure the equipment, since we cannot be responsible for loss of or damage to equipment that you ship. Of course, we insure the equipment when we ship it back to you.

Lectrosonics USA:

Mailing address:

Lectrosonics, Inc.
PO Box 15900
Rio Rancho, NM 87174
USA

Web:

www.lectrosonics.com

Shipping address:

Lectrosonics, Inc.
581 Laser Rd.
Rio Rancho, NM 87124
USA

E-mail:

sales@lectrosonics.com

Telephone:

(505) 892-4501
(800) 821-1121 Toll-free
(505) 892-6243 Fax

Lectrosonics Canada:

Mailing Address:

720 Spadina Avenue,
Suite 600
Toronto, Ontario M5S 2T9

Telephone:

(416) 596-2202
(877) 753-2876 Toll-free
(877-7LECTRO)
(416) 596-6648 Fax

E-mail:

Sales: colinb@lectrosonics.com
Service: joe@lectrosonics.com

For body worn operation, this transmitter model has been tested and meets the FCC RF exposure guidelines when used with the Lectrosonics accessories supplied or designated for this product. Use of other accessories may not ensure compliance with FCC RF exposure guidelines. Contact Lectrosonics if you have any questions or need more information about RF exposure using this product..

This device complies with FCC radiation exposure limits as set forth for an uncontrolled environment. This device should be installed and operated so that its antenna(s) are not co-located or operating in conjunction with any other antenna or transmitter.

ISED Notices:

Per RSS-210

This device operates on a no-protection no-interference basis. Should the user seek to obtain protection from other radio services operating in the same TV bands, a radio licence is required. Please consult Industry Canada's document CPC-2-1-28, Optional Licensing for Low-Power Radio Apparatus in the TV Bands, for details.

Ce dispositif fonctionne selon un régime de non-brouillage et de non-protection. Si l'utilisateur devait chercher à obtenir une certaine protection contre d'autres services radio fonctionnant dans les mêmes bandes de télévision, une licence radio serait requise. Pour en savoir plus, veuillez consulter le document CPC-2-1-28 d'Industrie Canada intitulé, Délivrance de licences sur une base volontaire pour les appareils radio de faible puissance exempts de licence et exploités dans les bandes de télévision.

Per RSS-Gen

This device complies with Industry Canada's license-exempt RSSs. Operation is subject to the following two conditions:

- 1) This device may not cause interference*
- 2) This device must accept any interference, including interference that may cause undesired operation of the device.*

Le présent appareil est conforme aux CNR d'Industrie Canada applicables aux appareils radio ex-empts de licence. L'exploitation est autorisée aux deux conditions suivantes :

- 1) l'appareil ne doit pas produire de brouillage;*
- 2) l'appareil doit accepter tout brouillage radioélectrique subi, même si le brouillage est susceptible d'en compromettre le fonctionnement.*

LIMITED ONE YEAR WARRANTY

The equipment is warranted for one year from date of purchase against defects in materials or workmanship provided it was purchased from an authorized dealer. This warranty does not cover equipment which has been abused or damaged by careless handling or shipping. This warranty does not apply to used or demonstrator equipment.

Should any defect develop, Lectrosonics, Inc. will, at our option, repair or replace any defective parts without charge for either parts or labor. If Lectrosonics, Inc. cannot correct the defect in your equipment, it will be replaced at no charge with a similar new item. Lectrosonics, Inc. will pay for the cost of returning your equipment to you.

This warranty applies only to items returned to Lectrosonics, Inc. or an authorized dealer, shipping costs prepaid, within one year from the date of purchase.

This Limited Warranty is governed by the laws of the State of New Mexico. It states the entire liability of Lectrosonics Inc. and the entire remedy of the purchaser for any breach of warranty as outlined above. NEITHER LECTROSONICS, INC. NOR ANYONE INVOLVED IN THE PRODUCTION OR DELIVERY OF THE EQUIPMENT SHALL BE LIABLE FOR ANY INDIRECT, SPECIAL, PUNITIVE, CONSEQUENTIAL, OR INCIDENTAL DAMAGES ARISING OUT OF THE USE OR INABILITY TO USE THIS EQUIPMENT EVEN IF LECTROSONICS, INC. HAS BEEN ADVISED OF THE POSSIBILITY OF SUCH DAMAGES. IN NO EVENT SHALL THE LIABILITY OF LECTROSONICS, INC. EXCEED THE PURCHASE PRICE OF ANY DEFECTIVE EQUIPMENT.

This warranty gives you specific legal rights. You may have additional legal rights which vary from state to state.

