



Test Report

Prepared for: Lectrosonics, Inc.

Model: DBa

Description: Wireless Microphone Transmitter

Serial Number: 1 and 2

FCC ID: DBZDBA

IC: 8024A-DBA

To

FCC Part 74H

And

IC RSS-123 Issue 2

Date of Issue: May 17, 2016

On the behalf of the applicant:

Lectrosonics Inc
581 Laser Rd NE
Rio Rancho, NM 87174

Attention of:

Bob Cunnings, VP of Engineering
Ph: (505)892-4501
E-Mail: bob.cunnings@lectrosonics.com

Prepared by
Compliance Testing, LLC
1724 S. Nevada Way
Mesa AZ 85204
(480) 926-3100 phone / (480) 926-3598 fax
www.compliancetesting.com
Project No: p1610024

Alex Macon
Project Test Engineer

This report may not be reproduced, except in full, without written permission from Compliance Testing.
All results contained herein relate only to the sample tested.

Test Report Revision History

Revision	Date	Revised By	Reason for Revision
1.0	April 8, 2016	Alex Macon	Original Document
2.0	May 12, 2016	Alex Macon	Corrected power table. Added Formula to Annex B
3.0	May 17, 2016	Alex Macon	Added Annex D for Measured Occupied Bandwidth

Table of Contents

<u>Description</u>	<u>Page</u>
Standard Test Conditions and Engineering Practices	6
Test Result Summary	7
Carrier Output Power (Conducted)	8
Conducted Spurious Emissions	9
Field Strength of Spurious Radiation	10
Emission Masks (Occupied Bandwidth)	12
Frequency Stability	13
Measured Occupied Bandwidth	14
Test Equipment Utilized	15

ILAC / A2LA

Compliance Testing, LLC, has been accredited in accordance with the recognized International Standard ISO/IEC 17025:2005. This accreditation demonstrates technical competence for a defined scope and the operation of a laboratory quality management system (refer to the joint ISO-ILAC-IAF Communiqué dated January 2009).

The tests results contained within this test report all fall within our scope of accreditation, unless noted in the table below.

Please refer to <http://www.compliancetesting.com/labscope.html> for current scope of accreditation.

Testing Certificate Number: **2152.01**



FCC Site Reg. #349717

IC Site Reg. #2044A-2

Non-accredited tests contained in this report:

N/A

The Applicant has been cautioned as to the following

15.21: Information to the User

The user's manual or instruction manual for an intentional radiator shall caution the user that changes or modifications not expressly approved by the party responsible for compliance could void the user's authority to operate the equipment.

15.27(a): Special Accessories

Equipment marketed to a consumer must be capable of complying with the necessary regulations in the configuration in which the equipment is marketed. Where special accessories, such as shielded cables and/or special connectors are required to enable an unintentional or intentional radiator to comply with the emission limits in this part, the equipment must be marketed with, i.e. shipped and sold with, those special accessories. However, in lieu of shipping or packaging the special accessories with the unintentional or intentional radiator, the responsible party may employ other methods of ensuring that the special accessories are provided to the consumer, without an additional charge.

Information detailing any alternative method used to supply the special accessories for a grant of equipment authorization or retained in the verification records, as appropriate. The party responsible for the equipment, as detailed in § 2.909 of this chapter, shall ensure that these special accessories are provided with the equipment. The instruction manual for such devices shall include appropriate instructions on the first page of text concerned with the installation of the device that these special accessories must be used with the device. It is the responsibility of the user to use the needed special accessories supplied with the equipment.

Test and Measurement Data

Subpart 2.1033(c)(14):

All tests and measurement data shown were performed in accordance with FCC Rules and Regulations, Volume II, Part 2, Sub-part J, Sections 2.947, 2.1033(c), 2.1041, 2.1046, 2.1047, 2.1079, 2.1051, 2.1053, 2.1055, 2.1057, and the following individual Parts: 74.

Standard Test Conditions and Engineering Practices

Unless otherwise indicated, the procedures contained in ANSI C63.4-2009 were observed during testing.

In accordance with ANSI C63.4-2009, and unless otherwise indicated in the specific measurement results, the ambient temperature of the actual EUT was maintained within the range of 10° to 40°C (50° to 104°F) unless the particular equipment requirements specified testing over a different temperature range. Also, unless otherwise indicated, the humidity levels were in the range of 10% to 90% relative humidity.

Measurement results, unless otherwise noted, are worst-case measurements.

Environmental Conditions		
Temperature (°C)	Humidity (%)	Pressure (mbar)
22.4 – 24.7	23.8 – 38.1	961.7 – 965.7

EUT Description

Model: DBa

Description: Wireless Microphone Transmitter

Serial Number: 1 and 2

Firmware: N/A

Software: N/A

Additional Information:

N/A

EUT Operation during Tests

EUT is equipped with test software in order to have the device I continuous transmission

Accessories: None

Cables: None

Modifications: None

Test Result Summary

Specification	Test Name	Pass, Fail, N/A	Comments
2.1046(a) 74.861(e)(1)(i) RSS-123 (4.2.1.1)	Carrier Output Power (Conducted)	Pass	
2.1051, 74.861(e)(6) RSS-123 (5.5.1)	Unwanted Emissions (Transmitter Conducted)	Pass	
2.1053 74.861(e)(6) RSS-123 (5.5.1)	Field Strength of Spurious Radiation	Pass	
74.861(e)(6) RSS-123 (5.5.1)	Emission Masks (Occupied Bandwidth)	Pass	
2.1047(a)	Audio Low Pass Filter (Voice Input)	N/A	
2.1047(a)	Audio Frequency Response	N/A	
2.1047(b)	Modulation Limiting	N/A	
2.1055, 74.861(e)(4) RSS-123 (5.4)	Frequency Stability (Temperature Variation)	Pass	
2.1055 RSS-123 (5.4)	Frequency Stability (Voltage Variation)	Pass	
RSS-Gen	Receiver Spurious Emissions	Pass	

Carrier Output Power (Conducted)
Engineer: Alex Macon

Test Date: 4/6/16

Measurement Procedure

The Equipment Under Test (EUT) was connected directly to a spectrum analyzer. The test cable and attenuator were entered into the spectrum analyzer as a reference level offset before recording the peak conducted output power for the FCC and the average conducted output power for Industry Canada.

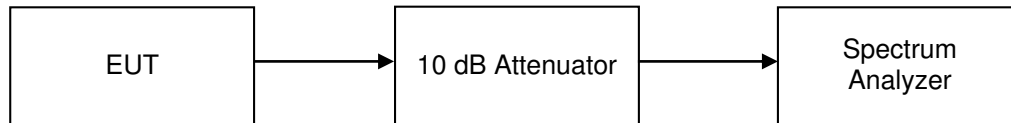
Test Setup

FCC Transmitter Output Power

Tuned Frequency (MHz)	Recorded Measurement (dBm)	Limit (dBm)	Result
470.1	16.93	24	Pass
539.0	16.98	24	Pass
607.9	16.17	24	Pass
614.1	15.97	24	Pass
656.0	15.96	24	Pass
691.175	16.47	24	Pass

Conducted Spurious Emissions

Engineer: Alex Macon

Test Date: 4/6/16

Test Procedure

The EUT was connected directly to a spectrum analyzer to verify that the EUT met the requirements for spurious emissions. For the FCC the RBW was set to 100 KHz for measurements up to 1 GHz and 1 MHz for measurements above 1 GHz using a peak detector.

The reference level was adjusted to ensure the system had sufficient dynamic range to measure spurious emissions. The frequency range from 30 MHz to the 10th harmonic of the fundamental transmitter was observed and plotted.

The limit line was set for -25 dBm for comparison to RSS-210 which is the more stringent limit.

Test Setup

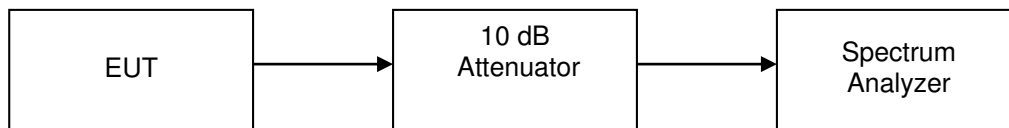

See Annex A for test results

Field Strength of Spurious Radiation

Engineer: Alex Macon

Test Date: 4/6/16

Test Procedure

- A) Connect the equipment as illustrated
- B) Adjust the spectrum analyzer for the following settings:
 - 1) Resolution Bandwidth 100 kHz (< 1 GHz), 1 MHz (> 1GHz) unless otherwise specified.
 - 2) Video Bandwidth ≥ 3 times Resolution Bandwidth
 - 3) Sweep Speed ≤ 2000 Hz/second
 - 4) Detector Mode = Average
- C) Place the transmitter to be tested on the turntable in the standard test site. Transmitters without antennas were transmitting into a non-radiated load. The RF cable to this load should be of minimum length. Transmitters with antennas were transmitting into the manufacturer's supplied antenna.
- D) For each spurious measurement the test antenna should be adjusted to the correct length for the frequency involved. This length may be determined from a calibration ruler supplied with the equipment. Measurements shall be made from the lowest radio frequency generated in the equipment to the tenth harmonic of the carrier, except for the region close to the carrier equal to \pm the test bandwidth (see section 1.3.4.4).
- E) For each spurious frequency, raise and lower the test antenna from 1 m to 4 m to obtain a maximum reading on the spectrum analyzer with the test antenna at horizontal polarity. Repeat this procedure to obtain the highest possible reading. Record this maximum reading.
- F) Repeat step E) for each spurious frequency with the test antenna polarized vertically.
- G) Reconnect the equipment as illustrated.
- H) Keep the spectrum analyzer adjusted as in step B).
- I) Remove the transmitter and replace it with a substitution antenna (the antenna should be half wavelength for each frequency involved). The center of the substitution antenna should be approximately at the same location as the center of the transmitter. At lower frequencies, where the substitution antenna is very long, this will be impossible to achieve when the antenna is polarized vertically. In such case the lower end of the antenna should be 0.3 m above the ground.
- J) Feed the substitution antenna at the transmitter end with a signal generator connected to the antenna by means of a non-radiating cable. With the antennas at both ends horizontally polarized and with the signal generator tuned to a particular spurious frequency, raise and lower the test antenna to obtain a maximum reading at the spectrum analyzer. Adjust the level of the signal generator output until the previously recorded maximum reading for this set of conditions is obtained. This should be done carefully repeating the adjustment of the test antenna and generator output.
- K) Repeat step J) with both antennas vertically polarized for each spurious frequency.
- L) Calculate power in dBm into a reference ideal half-wave dipole antenna by reducing the readings obtained in steps J) and K) by the power loss in the cable between the generator and the antenna and further corrected for the gain of the substitution antenna used relative to an ideal half-wave dipole antenna.
- M) The levels recorded in step L) are absolute levels of radiated spurious emissions in dBm. The radiated spurious emissions in dB can be calculated by the following:

Radiated spurious emissions dB = $10\log_{10}$ (TX power in watts/0.001) – the levels in step I)

NOTE: It is permissible that the other antennas provided can be referenced to a dipole.

Test Setup

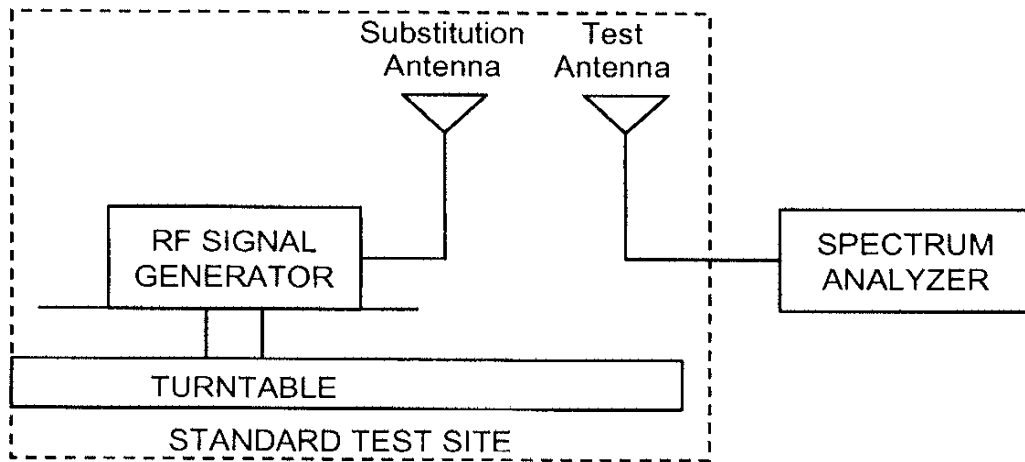
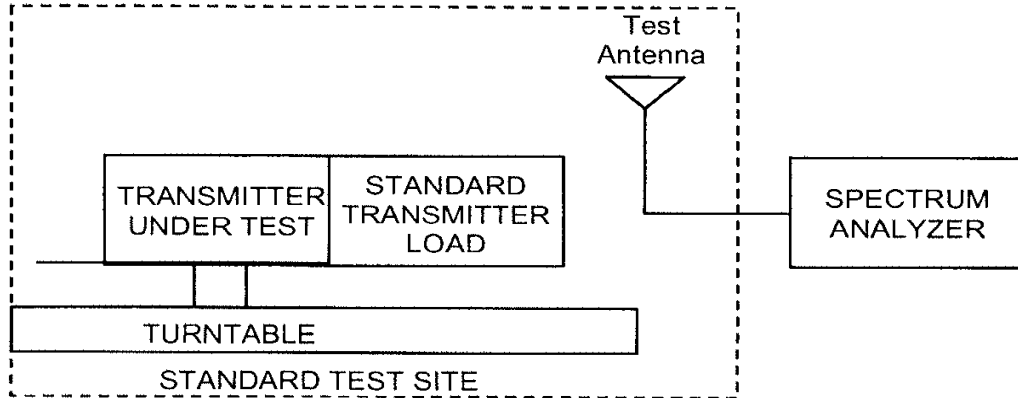

The limit was set for -25 dBm for comparison to RSS-210 which is the more stringent limit. No other emissions were detected. All emissions were greater than -25 dBm.

See Annex B for test results

Emission Masks (Occupied Bandwidth)

Engineer: Alex Macon

Test Date: 4/6/16

Test Procedure

The EUT was connected directly to a spectrum analyzer to verify that the EUT meets the required emissions mask.

Test Setup

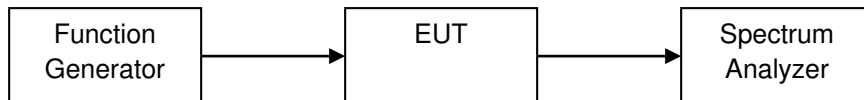

See Annex C for test results

Frequency Stability

Engineer: Alex Macon

Test Date: 4/7/16

Measurement Procedure

The EUT was placed in an environmental test chamber and the RF output was connected directly to a frequency counter. The temperature was varied from -30°C to 50°C in 10°C increments. After a sufficient time for temperature stabilization the RF output frequency was measured. The power supply voltage to the EUT was varied from 85% to 115% of the nominal value and the RF output was measured.

Measurement Setup

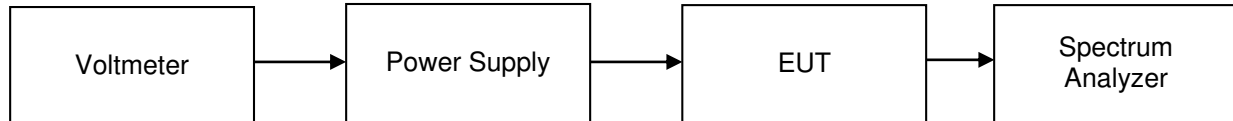

Measurement Results

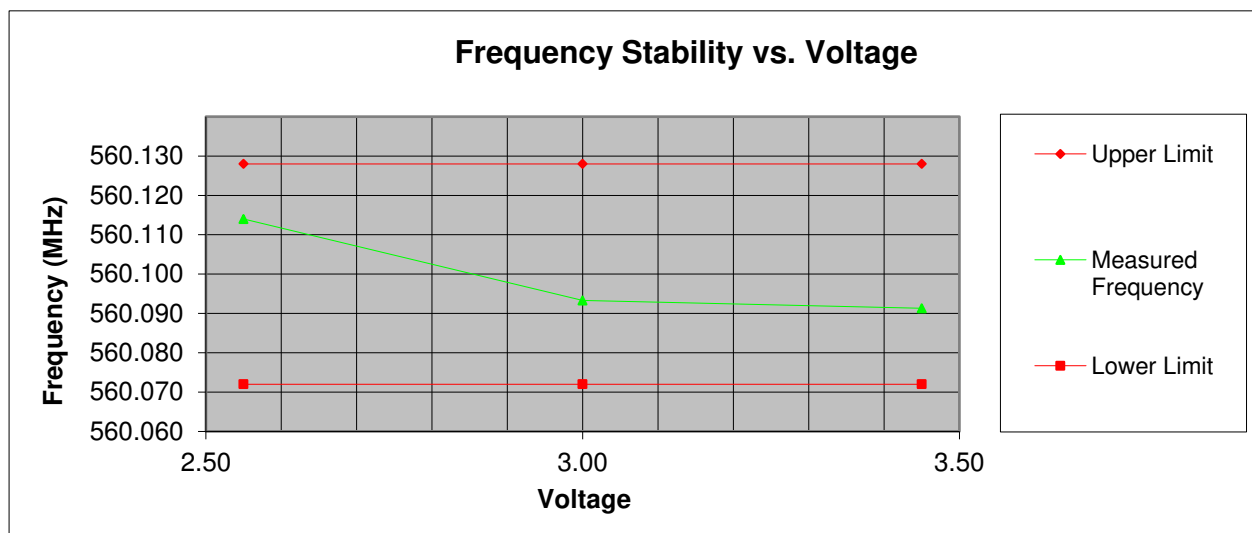
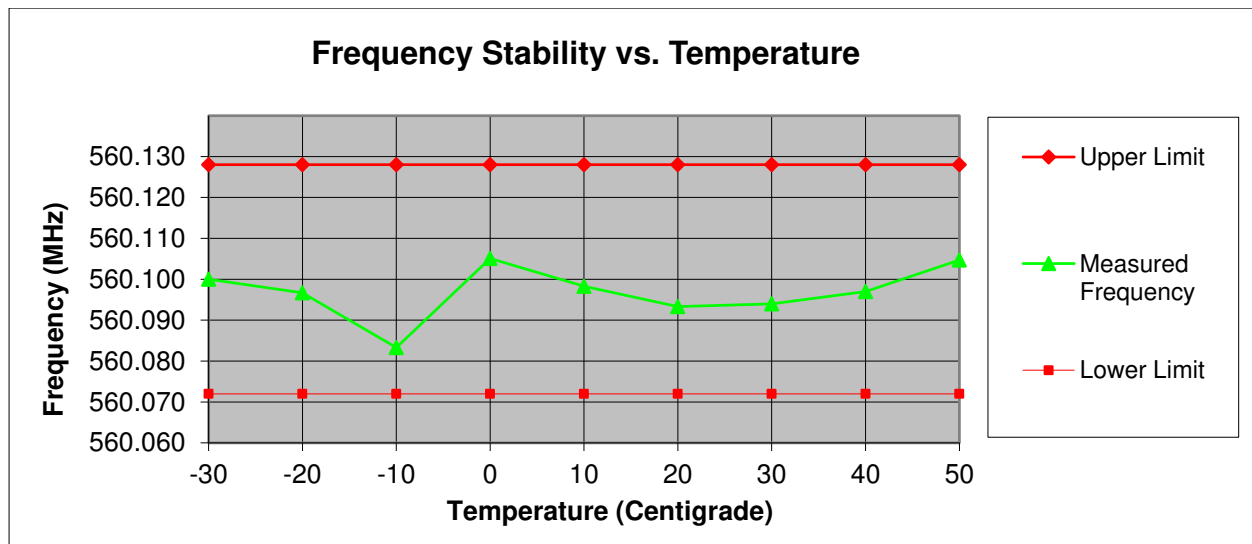

Test frequency: 560.1 MHz

Upper Limit: 560.1280050

Lower Limit: 560.0719950



Measured Occupied Bandwidth

Engineer: Alex Macon

Test Date: 4/8/16

See Annex D for test results

Test Equipment Utilized

Description	Manufacturer	Model #	CT Asset #	Last Cal Date	Cal Due Date
Power Supply	Kenwood	PR18-3A	i00008	Verified on: 4/6/16	
Temperature Chamber	Tenney	Tenney Jr	i00027	Verified on: 4/7/16	
Horn Antenna	EMCO	3115	i00103	1/20/15	1/20/17
Harmonic Mixer	HP	11970A	i00193	6/4/15	6/4/16
Signal Generator	Rohde & Schwarz	SMT-03	i00266	5/18/15	5/18/16
Horn Antenna, Amplified	ARA	DRG-118/A	i00271	5/8/14	5/8/16
Horn Antenna, Amplified	ARA	MWH-1826/B	i00273	4/22/15	4/22/18
Spectrum Analyzer	Agilent	E4407B	i00331	9/18/15	9/18/16
Data Logger	Fluke	Hydra Data Bucket	i00343	4/5/16	4/5/17
Bi-Log Antenna	Schaffner	CBL 6111D	i00349	10/19/15	10/19/17
EMI Analyzer	Agilent	E7405A	i00379	2/11/16	2/11/17
3 Meter Semi-Anechoic Chamber	Panashield	3 Meter Semi-Anechoic Chamber	i00428	7/27/14	7/27/16
PSA Spectrum Analyzer	Agilent	E4445A	i00471	8/26/15	8/26/16

In addition to the above listed equipment standard RF connectors and cables were utilized in the testing of the described equipment. Prior to testing these components were tested to verify proper operation.

END OF TEST REPORT