

ALPS®

Label

Control UNIT (TWD1U630)

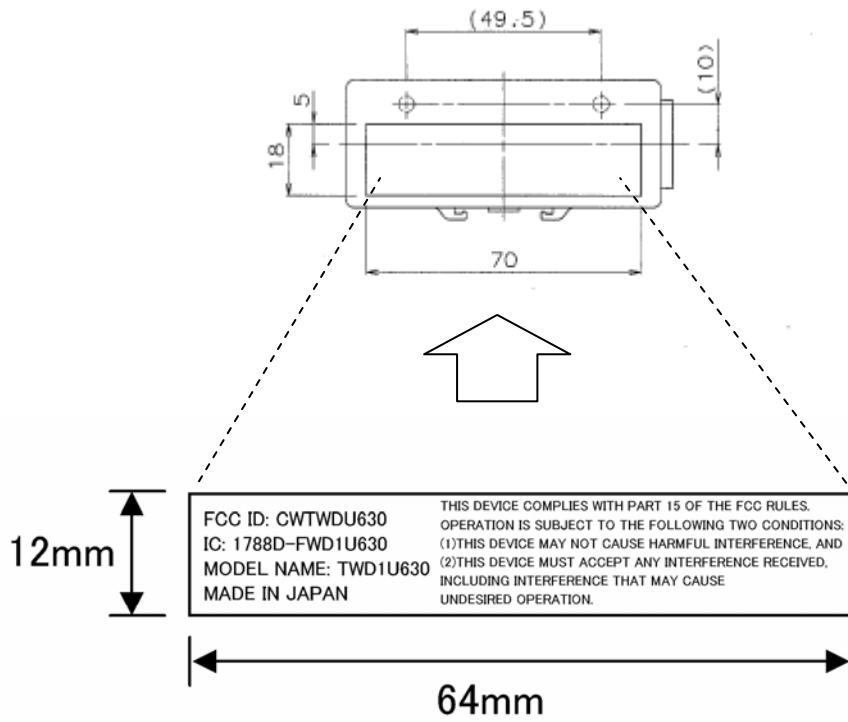

*The way of attaching FCC ID is "Seal".
Material of seal is PET.