



**EMI TEST REPORT**

JQA File No. : 400-60543

Model No. : CECHZR1U

Type of Equipment : BD REMOTE CONTROL

Regulations Applied : CFR 47 FCC Rules and Regulations Part 15

FCC ID : CWTSAZY1002

Applicant : ALPS ELECTRIC CO., LTD.

Address : 41-25 AZA YANAGI-MACHI NODA ONAHAMA IWAKI-CITY  
FUKUSHIMA 971-8615 JAPAN

Manufacturer : ALPS ELECTRONICS HONG KONG LTD.  
DONGGUAN CHANGAN RIHUA ELECTRONICS FTY

Address : XINXINGGONGYEYUAN LIWUDI 6 GONGYEDADAO CHANGANZHEN,  
WUSHAGUANLIQU DONGGUAN GUANGDONG CHINA

Received date of EUT : November 13, 2006

**Test Result : Passed**

Test results in this report are obtained in use of equipment that is traceable to National Institute of Advanced Industrial Science and Technology (AIST) of Japan and National Institute of Information and Communications Technology (NICT) of Japan.

The test results only respond to the tested sample. This report should not be reproduced except in full, without the written approval of JQA EMC Engineering Dept. Testing Div.

---

**TABLE OF CONTENTS**

	Page
<b>1 Documentation</b>	
1.1 Test Regulation	<u>4</u>
1.2 General Information	<u>4 - 5</u>
1.3 Test Condition	<u>6 - 12</u>
1.4 EUT Modifications / Deviation from Standard	<u>13</u>
1.5 Test results	<u>14 - 15</u>
1.6 Summary	<u>16</u>
1.7 Test Configuration / Operation of EUT	<u>17 - 18</u>
1.8 EUT Arrangement (Drawing)	<u>19</u>
1.9 Preliminary Test and Test-setup (Drawings)	<u>20 - 28</u>
1.10 EUT Arrangement (Photographs)	<u>29 - 32</u>

**2 Test Data**

2.1 Channel Separation	<u>33</u>
2.2 Minimum Hopping Channel	<u>34 - 35</u>
2.3 Occupied Bandwidth	<u>36 - 38</u>
2.4 Dwell Time	<u>39 - 41</u>
2.5 Peak Output Power (Conduction)	<u>42</u>
2.6 Peak Output Power (Radiation)	<u>N/A</u>
2.7 Peak Power Density (Conduction)	<u>43 - 45</u>
2.8 Peak Power Density (Radiation)	<u>N/A</u>
2.9 Spurious Emissions (Conduction)	<u>46 - 51</u>
2.10 Spurious Emissions (Radiation)	<u>52 - 59</u>
2.11 AC Power Line Conducted Emissions	<u>N/A</u>
2.12 RF Exposure Compliance	<u>N/A</u>
2.13 Spurious Emissions for Receiver (Radiation)	<u>60 - 62</u>
2.14 AC Power Line Conducted Emissions for Receiver	<u>N/A</u>

**3 Appendix**

Test instruments List	<u>63 - 66</u>
-----------------------	----------------

## **1. DOCUMENTATION**

### **1.1 TEST REGULATION**

FCC Rules and Regulations Part 15 Subpart B and C Radiated Spurious Emissions

#### **Test procedure :**

The tests were performed with reference to the FCC Public Notice DA 00-705, released March 30, 2000. The test set-up was made in accordance to the general provisions of ANSI C63.4-2003.

### **1.2 GENERAL INFORMATION**

#### **1.2.1 Test facility :**

JQA Safety & EMC Center EMC Engineering Department is recognized under ISO/IEC 17025 by NVLAP and VLAC.

- 1) Test Facility located at EMC Engineering Dept. Testing Div. :
  - No.A and B Anechoic Chambers(3 meters Site).
  - Shielded Enclosure.

Open Area Test Site Industry Canada No.: 2079-7

- 2) EMC Engineering Dept. Testing Div. is accredited under the National Voluntary Laboratory accreditation Program for satisfactory compliance established in title 15, Part 285 Code of Federal Regulations.  
NVLAP Lab Code : 200189-0 (Effective through : June 30, 2007)

**1.2.2 Description of the Equipment Under Test (EUT) :**

1) Type of Equipment	: BD REMOTE CONTROL
2) Product Type	: Pre-production
3) Category	: Spread Spectrum Transmitter (FHSS)
4) EUT Authorization	: Certification
5) FCC ID	: CWTSAZY1002
6) Trade Name	: SONY
7) Model No.	: CECHZR1U
8) Operating Frequency Range	: 2402 MHz - 2480 MHz
9) Highest Frequency Used in the EUT	: 2480 MHz
10) RF Output Power	: -2.69 dBm (measured value)
11) Serial No.	: None
12) Date of Manufacture	: None
13) Power Rating	: 3.0VDC (Battery)
14) EUT Grounding	: None
15) Antenna Type	: Integral Internal antenna (not accessible to the user)
16) Antenna Gain	: 2.0 dBi

**1.2.3 Definitions for symbols used in this test report :**

- x - indicates that the listed condition, standard or equipment is applicable for this report.
- - indicates that the listed condition, standard or equipment is not applicable for this report.

### 1.3 TEST CONDITION

#### 1.3.1 The measurement of Channel Separation

  x   - was performed.  
     - was not applicable.

**Used test instruments :**

Type	Number of test instruments (Refer to Appendix)
Test Receiver	13
Spectrum Analyzer	N/A
Cable	48
Attenuator	80
Antenna	N/A
DC Power Supply	77

#### 1.3.2 The measurement of Minimum Hopping Channel

  x   - was performed.  
     - was not applicable.

**Used test instruments :**

Type	Number of test instruments (Refer to Appendix)
Test Receiver	13
Spectrum Analyzer	N/A
Cable	48
Attenuator	80
Antenna	N/A
DC Power Supply	77

#### 1.3.3 The measurement of Occupied Bandwidth

  x   - was performed.  
     - was not applicable.

**Used test instruments :**

Type	Number of test instruments (Refer to Appendix)
Test Receiver	13
Spectrum Analyzer	N/A
Cable	48
Attenuator	80
Antenna	N/A
DC Power Supply	77

**1.3.4 The measurement of Dwell Time**

  x   - was performed.  
     - was not applicable.

**Used test instruments :**

<b>Type</b>	<b>Number of test instruments (Refer to Appendix)</b>
Test Receiver	13
Spectrum Analyzer	N/A
Cable	48
Attenuator	80
Antenna	N/A
DC Power Supply	77

**1.3.5 The measurement of Peak Output Power and Density (Conduction)**

  x   - was performed.  
     - was not applicable.

**Used test instruments :**

<b>Type</b>	<b>Number of test instruments (Refer to Appendix)</b>
Test Receiver	13
Spectrum Analyzer	N/A
Cable	48
Attenuator	80
Antenna	N/A
Digitizing Oscilloscope	163
RF Detector	85
Signal Generator	60
DC Power Supply	77

**1.3.6 The measurement of Peak Output Power and Density (Radiation)**

- was performed in the following test site.

- was not applicable.

**Test location :**

Safety & EMC Center EMC Engineering Dept. Testing Div.  
21-25, Kinuta 1-chome, Setagaya-ku, Tokyo 157-8573, Japan

- No. A site (3 meters)

- No. B site (3 meters)

**Validation of Site Attenuation :**

1) Last Confirmed Date : N/A

2) Interval : N/A

**Used test instruments :**

Type	Number of test instruments (Refer to Appendix)
Test Receiver	N/A
Spectrum Analyzer	N/A
Cable	N/A
Attenuator	N/A
Antenna	N/A
Power Meter	N/A
Power Sensor	N/A
Signal Generator	N/A
DC Power Supply	N/A



**1.3.7 The measurement of Spurious Emissions (Conduction)**

  x   - was performed.  
     - was not performed.

**Used test instruments :**

Type	Number of test instruments (Refer to Appendix)
Test Receiver	13
Spectrum Analyzer	N/A
Cable	48
Attenuator	80
DC Power Supply	77

**1.3.8 The measurement of Spurious Emissions (Radiation) (9 kHz - 30 MHz)**

  x   - was performed in the following test site.  
     - was not applicable.

**Test location :**

Safety & EMC Center EMC Engineering Dept. Testing Div.  
21-25, Kinuta 1-chome, Setagaya-ku, Tokyo 157-8573, Japan

  x   - Anechoic Chamber No. A (3 meters)  
     - Anechoic Chamber No. B (3 meters)

**Validation of Site Attenuation :**

- 1) Last Confirmed Date : N/A
- 2) Interval : N/A

**Used test instruments :**

Type	Number of test instruments (Refer to Appendix)
Test Receiver	13
Cable	43
Antenna	21
DC Power Supply	N/A

**1.3.9 The measurement of Spurious Emissions (Radiation) (30 MHz - 1000 MHz)**

- x   - was performed in the following test site.  
      - was not applicable.

**Test location :**

Safety & EMC Center EMC Engineering Dept. Testing Div.  
21-25, Kinuta 1-chome, Setagaya-ku, Tokyo 157-8573, Japan

- x   - Anechoic Chamber No. A (3 meters)  
      - Anechoic Chamber No. B (3 meters)

**Validation of Site Attenuation :**

- 1) Last Confirmed Date :March, 2006  
2) Interval :1 year

**Used test instruments :**

Type	Number of test instruments (Refer to Appendix)
Test Receiver	11
Cable	38
Antenna	26, 28
RF Amplifier	N/A
DC Power Supply	N/A

**1.3.10 The measurement of Spurious Emissions (Radiation) (Above 1000 MHz)**

- x   - was performed in the following test site.  
      - was not applicable.

**Test location :**

Safety & EMC Center EMC Engineering Dept. Testing Div.  
21-25, Kinuta 1-chome, Setagaya-ku, Tokyo 157-8573, Japan

- x   - No. A site (3 meters)  
      - No. B site (3 meters)

**Validation of Site Attenuation :**

- 1) Last Confirmed Date :March, 2006  
2) Interval :1 year

**Used test instruments :**

Type	Number of test instruments (Refer to Appendix)
Test Receiver	13
Spectrum Analyzer	N/A
Cable	48, 50
Antenna	31, 32
RF Amplifier	57
Band Reject Filter	78
High Pass Filter	79
DC Power Supply	N/A

**1.3.11 The measurement of AC Power Line Conducted Emissions**

- was performed in the following test site.  
 - was not applicable.

**Test location :**

Safety & EMC Center EMC Engineering Dept. Testing Div.  
21-25, Kinuta 1-chome, Setagaya-ku, Tokyo 157-8573, Japan

- Shielded Enclosure  
 - Anechoic Chamber No. A (portable Type)

**Used test instruments :**

Type	Number of test instruments (Refer to Appendix)
Test Receiver	N/A
Spectrum Analyzer	N/A
Cable	N/A
AMN(for EUT)	N/A
AMN(for Peripheral)	N/A
Termination	N/A
DC Power Supply	N/A

**1.4 EUT MODIFICATION / Deviation from Standard****1.4.1 EUT MODIFICATION**

- No modifications were conducted by JQA to achieve compliance to Class B levels.  
 - To achieve compliance to Class B levels, the following changes were made by JQA during the compliance test.

The modifications will be implemented in all production models of this equipment.

Applicant :

Date :

Typed Name :

Position :

Signatory : \_\_\_\_\_

**1.4.2 Deviation from Standard:**

- No deviations from the standard described in clause 1.1.  
 - The following deviations were employed from the standard described in clause 1.1:

\_\_\_\_\_  
\_\_\_\_\_

### 1.5 TEST RESULTS

<b>Channel Separation</b> [§15.247 (a) (1)]	<u>  x  </u> - Applicable	<u>    </u> - NOT Applicable
The requirements are	<u>  x  </u> - PASSED	<u>    </u> - NOT PASSED
Remarks :		
<b>Minimum Hopping Channel</b> [§15.247 (a) (1) (iii)]	<u>  x  </u> - Applicable	<u>    </u> - NOT Applicable
The requirements are	<u>  x  </u> - PASSED	<u>    </u> - NOT PASSED
Remarks:		
<b>Occupied Bandwidth</b> [§15.247 (a) (2)]	<u>  x  </u> - Applicable	<u>    </u> - NOT performed
The requirements are	<u>  x  </u> - PASSED	<u>    </u> - NOT PASSED
Remarks:		
<b>Dwell Time</b> [§15.247 (a) (1) (iii) / (g)]	<u>  x  </u> - Applicable	<u>    </u> - NOT Applicable
The requirements are	<u>  x  </u> - PASSED	<u>    </u> - NOT PASSED
Remarks:		
<b>Peak Output Power (Conduction)</b> [§15.247 (b) (3)]	<u>  x  </u> - Applicable	<u>    </u> - NOT Applicable
The requirements are	<u>  x  </u> - PASSED	<u>    </u> - NOT PASSED
Remarks:		
<b>Peak Output Power (Radiation)</b> [§15.247 (b) (1)]	<u>    </u> - Applicable	<u>  x  </u> - NOT Applicable
The requirements are	<u>    </u> - PASSED	<u>    </u> - NOT PASSED
Remarks:		
<b>Peak Power Density (Conduction)</b> [§15.247 (d)]	<u>  x  </u> - Applicable	<u>    </u> - NOT Applicable
The requirements are	<u>  x  </u> - PASSED	<u>    </u> - NOT PASSED
Remarks:		
<b>Peak Power Density (Radiation)</b> [§15.247 (d)]	<u>    </u> - Applicable	<u>  x  </u> - NOT Applicable
The requirements are	<u>    </u> - PASSED	<u>    </u> - NOT PASSED
Remarks:		

---

<b>Spurious Emissions (Conduction)</b> [§15.247(c)]	<input checked="" type="checkbox"/> - Applicable	<input type="checkbox"/> - NOT performed
The requirements are	<input checked="" type="checkbox"/> - PASSED	<input type="checkbox"/> - NOT PASSED
Remarks:		
<b>Spurious Emissions (Radiation)</b> [§15.247(c), §15.35(b), §15.209(a)]	<input checked="" type="checkbox"/> - Applicable	<input type="checkbox"/> - NOT Applicable
The requirements are	<input checked="" type="checkbox"/> - PASSED	<input type="checkbox"/> - NOT PASSED
Remarks:		
<b>AC Power Line Conducted Emissions</b> [§15.207(a)]	<input type="checkbox"/> - Applicable	<input checked="" type="checkbox"/> - NOT Applicable
The requirements are	<input type="checkbox"/> - PASSED	<input type="checkbox"/> - NOT PASSED
Remarks:		
<b>RF Exposure Compliance</b> [§15.247(b)(5)]	<input type="checkbox"/> - Applicable	<input checked="" type="checkbox"/> - NOT Applicable
The requirements are	<input type="checkbox"/> - PASSED	<input type="checkbox"/> - NOT PASSED
Remarks:		
<b>Spurious Emissions for Receiver</b> (Radiation) [§15.109(a)]	<input checked="" type="checkbox"/> - Applicable	<input type="checkbox"/> - NOT Applicable
The requirements are	<input checked="" type="checkbox"/> - PASSED	<input type="checkbox"/> - NOT PASSED
Remarks:		
<b>AC Power Line Conducted Emissions</b> for Receiver [§15.107(a)]	<input type="checkbox"/> - Applicable	<input checked="" type="checkbox"/> - NOT Applicable
The requirements are	<input type="checkbox"/> - PASSED	<input type="checkbox"/> - NOT PASSED
Remarks:		

**1.6 SUMMARY****General Remarks :**

The EUT was tested according to the requirements of FCC Rules and Regulations Part 15 Subpart B, Subpart under the test configuration, as shown in clause 1.7 to 1.10. The conclusion for the test items which are required by the applied regulation is indicated under the test result.

**Test Result :**

The "as received" sample;

- x   - fulfill the test requirements of the regulation mentioned on clause 1.1.
- fulfill the test requirements of the regulation mentioned on clause 1.1, but with certain qualifications.
- doesn't fulfill the test regulation mentioned on clause 1.1.

Begin of testing : November 13, 2006

End of testing : November 20, 2006

- JAPAN QUALITY ASSURANCE ORGANIZATION -

Approved by:

Issued by:



Takaharu Hada  
Manager  
Testing Division  
JQA EMC Engineering Dept.



Shigeru Osawa  
Assistant Manager  
Testing Division  
JQA EMC Engineering Dept.



**1.7 TEST CONFIGURATION / OPERATION OF EUT**

**1.7.1 Test Configuration**

**The equipment under test (EUT) consists of :**

Symbol	Item	Manufacturer	Model No.	FCC ID	Serial No.
A	BD REMOTE CONTROL	ALPS ELECTRONICS HONG KONG LTD.	CECHZR1U	CWTSAZY1002	None

**The measurement was carried out with the following support equipment connected :**

Symbol	Item	Manufacturer	Model No.	FCC ID	Serial No.
B	Personal Computer	IBM	2662-28J	DoC	FX-64867 01/02
C	AC Adapter	IBM	02K6554	None	1Z0RM9156HD
D	Bluetooth Test Set	Anritsu	MT8852B	None	6K00005585
E	PCMCIA-GPIB Cable	NATIONAL INSTRUMENTS	182362-02	None	None
F	Especially Antenna	ALPS	None	None	None

**Type of Cable :**

Symbol	Description	Identification (Manufacturer etc.)	Connector Shielded YES / NO	Cable Shielded YES / NO	Ferrite Core	Length (m)
1	DC Cable	-	NO	NO	NO	0.60
2	AC Cable	-	NO	NO	NO	1.00
3	DC Cable	-	NO	NO	YES	1.85
4	AC Cable	-	NO	NO	NO	2.30

Note: The DC Cable of the symbol 1 is connected of the test sample for the conducted measurement.  
 Other cables are cables of support equipment to use at the time of the TX mode measurement.

### 1.7.2 Operating condition

Power supply Voltage : 3.0VDC operate with Fresh Alkaline Battery or DC power supply

The tests have been carried out the following mode.

- 1) TX mode ( 0ch: 2402 MHz)
- 2) TX mode (39ch: 2441 MHz)
- 3) TX mode (78ch: 2480 MHz)
- 4) RX mode

Used application to controlled and support equipment:

- 1) Broadcom BlueTool (Version 0.9.7.6)  
(The detail is as follows. Other setting is default position.)  
Transport : HCI Control  
TX mode : 7.3 Host Controller / Write\_Scan\_Enable / Inquiry and Page Scan enable  
7.6 Testing Commands / Enable\_Device\_Under\_Test\_Mode  
RX mode : 0 Vender Specific
- 2) BlueSuite Professional (Version 2.05)  
(Only the TX mode, the detail is as follows. Other setting is default position.)  
Method : TX Test  
Packet Type : DH1, DH3 or DH5  
Data Pattern : DATAPRBS9  
Hopping Type : Hopping ON or Fixed Channel (Tx and Rx Channel : 0, 39 or 78)

### 1.7.3 Generating and Operating frequency of EUT

24 MHz and 2402 MHz to 2480 MHz

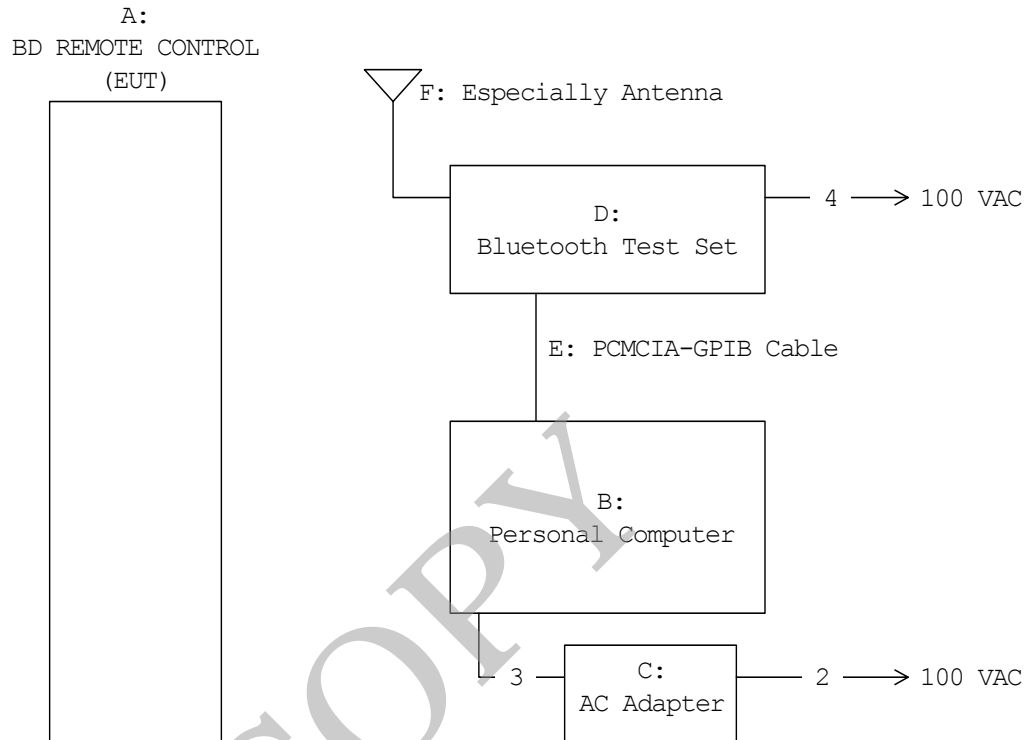
**1.8 EUT ARRANGEMENT (DRAWINGS)**

## 1.9 PRELIMINARY TEST AND TEST-SETUP (DRAWINGS)

### 1.9.1 Channel Separation

The EUT have its hopping function enabled.

Use the following spectrum analyzer settings:

Span = wide enough to capture the peaks of two adjacent channels

Resolution (or IF) Bandwidth (RBW)  $\geq 1\%$  of the span

Video (or Average) Bandwidth (VBW)  $\geq$  RBW

Sweep = auto

Detector function = peak

Trace = max hold

Allow the trace to stabilize. Use the marker-delta function to determine the separation between the peaks of the adjacent channels.

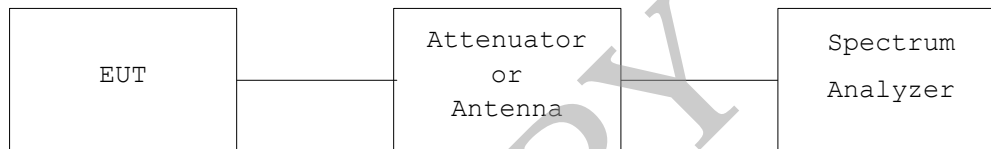

### 1.9.2 Minimum Hopping Channel

The EUT have its hopping function enabled.

Use the following spectrum analyzer settings:

Span = the frequency band of operation

RBW  $\geq 1\%$  of the span

VBW  $\geq$  RBW

Sweep = auto

Detector function = peak

Trace = max hold

Allow the trace to stabilize. It may prove necessary to break the span up to sections, in order to clearly show all of the hopping frequencies.

Measurement setup is same as sub-clause 1.9.1.

### 1.9.3 Occupied Bandwidth

Use the following spectrum analyzer settings:

Span = approximately 2 to 3 times the 6 dB or 20 dB bandwidth, centered on a channel

RBW  $\geq$  1% of the 6 dB or 20 dB bandwidth

VBW  $\geq$  RBW

Sweep = auto

Detector function = peak

Trace = max hold

The EUT should be transmitting at its maximum data rate. Allow the trace to stabilize. Use the marker-to-peak function to set the marker to the peak of the emission. Use the marker-delta function to measure 6 dB or 20 dB down one side of the emission. Reset the marker-delta function, and move the marker to the other side of the emission, until it is (as close as possible to) even with the reference marker level. The marker-delta reading at this point is the 6 dB or 20 dB bandwidth of the emission. If this value varies with different modes of operation (e.g., data rate, modulation format, etc.), repeat this test for each variation.

Measurement setup is same as sub-clause 1.9.1.

### 1.9.4 Dwell Time

The EUT must have its hopping function enabled.

Use the following spectrum analyzer settings:

Span = zero span, centered on a hopping channel

RBW  $\leq$  Channel Separation

VBW  $\geq$  RBW

Sweep = as necessary to capture the entire dwell time per hopping channel

Detector function = peak

Trace = max hold

If possible, use the marker-delta function to determine the dwell time. If this value varies with different modes of operation (e.g., data rate, modulation format, etc.), repeat this test for each variation.

Measurement setup is same as sub-clause 1.9.1.

### 1.9.5 Peak Output Power (Conduction)

In case of conducted measurements, the transmitter shall be connected to the measuring equipment via a suitable attenuator. The measurement shall be performed using normal operation of the equipment with the test modulation applied.

The test procedure shall be as follows;

(step 1):

- using a suitable means, the output of the transmitter shall be coupled to a diode detector;
- the output of the diode detector shall be connected to the vertical channel of an oscilloscope;
- the combination of the diode detector and the oscilloscope shall be capable of faithfully reproducing the envelope peaks and the duty cycle of the transmitter output signal;
- The observed value shall be recorded as "A" (in dBm);

(step 2):

- the transmitter shall be replaced by a signal generator. The output frequency of the signal shall be made equal to the centre of the frequency range occupied by the transmitter;
- the signal generator shall be unmodulated. The output power of the signal generator shall be raised to a level such that the deviation of the Y-trace of the oscilloscope reaches level A, as indicated in step 1;
- The signal generator output level shall be recorded;

The measurement shall be repeated at the lowest, the middle, and the highest frequency of the stated frequency range.

#### 1.9.6 Peak Power Density (Conduction)

Use the following spectrum analyzer settings:

Span = approximately 5 times the 20 dB bandwidth, centered on a channel

RBW = Specified Value

VBW ≥ RBW

Sweep = auto

Detector function = peak

Trace = max hold

Allow the trace to stabilize. Use the marker-to-peak function to set the marker to the peak of the emission.

Measurement setup is same as sub-clause 1.9.1.

#### 1.9.7 Peak Output Power and Peak Power Density (Radiation)

The radiated power output and the field strength of the transmitter radiation were measured at the distance at 3 meters away from the transmitter under test which was placed on a turntable 0.8 meter in height. The receiving antenna was oriented for vertical polarization and raised or lowered through 1 to 4 meters until the maximum signal level was detected on the measuring instrument. The transmitter under test was rotated through 360° until the maximum signal was received. The measurement was repeated with the receiving antenna in the horizontal polarization.

The transmitter was removed and replaced with the antenna. The center of the antenna was placed approximately at the same location as the center of the transmitter. The antenna was fed with a signal generator, and the output level of the signal generator was adjusted to obtain the previously recorded maximum reading at the particular frequency and recorded. This procedure was repeated with the receiving antenna and the antenna in the orthogonal polarization.

The input power into the antenna was measured using the power meter. The level of the emissions in dBm(EIRP) were calculated from the following formula:

$$\text{Transmitter Power [dBm] (EIRP)} = (\text{Meter Reading of Power Meter}) + (\text{Antenna Gain [dBi]})$$

Use the following spectrum analyzer settings:

Span = approximately 5 times the 20 dB bandwidth, centered on a channel

RBW : Greater then the 20 dB bandwidth of the emission being measured  
or Specified Value

VBW ≥ RBW

Sweep = auto

Detector function = peak

Trace = max hold

Allow the trace to stabilize. Use the marker-to-peak function to set the marker to the peak of the emission.

### 1.9.8 Spurious Emission (Conduction)

#### Band-edge Compliance of RF Conducted Emissions

Use the following spectrum analyzer settings:

Span = wide enough to capture the peak level of the emission operating on the channel closest to the band edge, as well as any modulation products which fall outside of the authorized band of operation

RBW  $\geq$  1% of the span

VBW  $\geq$  RBW

Sweep = auto

Detector function = peak

Trace = max hold

Allow the trace to stabilize. Set the marker on the emission at the band edge, or on the highest modulation product outside of the band, if this level is greater than that at the band edge. Enable the marker-delta function, then use the marker-to-peak function to move the marker to the peak of the in-band emission.

Now, using the same instrument settings, enable the hopping function of the EUT. Allow the trace to stabilize. Follow the same procedure listed above to determine if any spurious emissions caused by the hopping function also comply with the specified limit.

#### Spurious RF Conducted Emissions

Use the following spectrum analyzer settings:

Span = wide enough to capture the peak level of the in-band emission and all spurious emissions (e.g., harmonics) from the lowest frequency generated in the EUT up through the 10th harmonic. Typically, several plots are required to cover this entire span.

RBW = 100 kHz

VBW  $\geq$  RBW

Sweep = auto

Detector function = peak

Trace = max hold

Allow the trace to stabilize. Set the marker on the peak of any spurious emission recorded. The level displayed must comply with the limit specified in this Section.

Measurement setup is same as sub-clause 1.9.1.



**1.9.9 Radiated Emission ( 9 kHz - 30 MHz ) :**

According to description of ANSI C63.4-2003 sec.13.1.4, the preliminary radiated emissions measurement were carried out. The preliminary radiated measurements were performed at the measurement distance that specified for compliance to determine the emission characteristics of the EUT.

The EUT configuration, cable configuration and mode of operation were determined for producing the maximum level of emissions. These configurations were used for the final radiated emissions measurements.

- Side View -

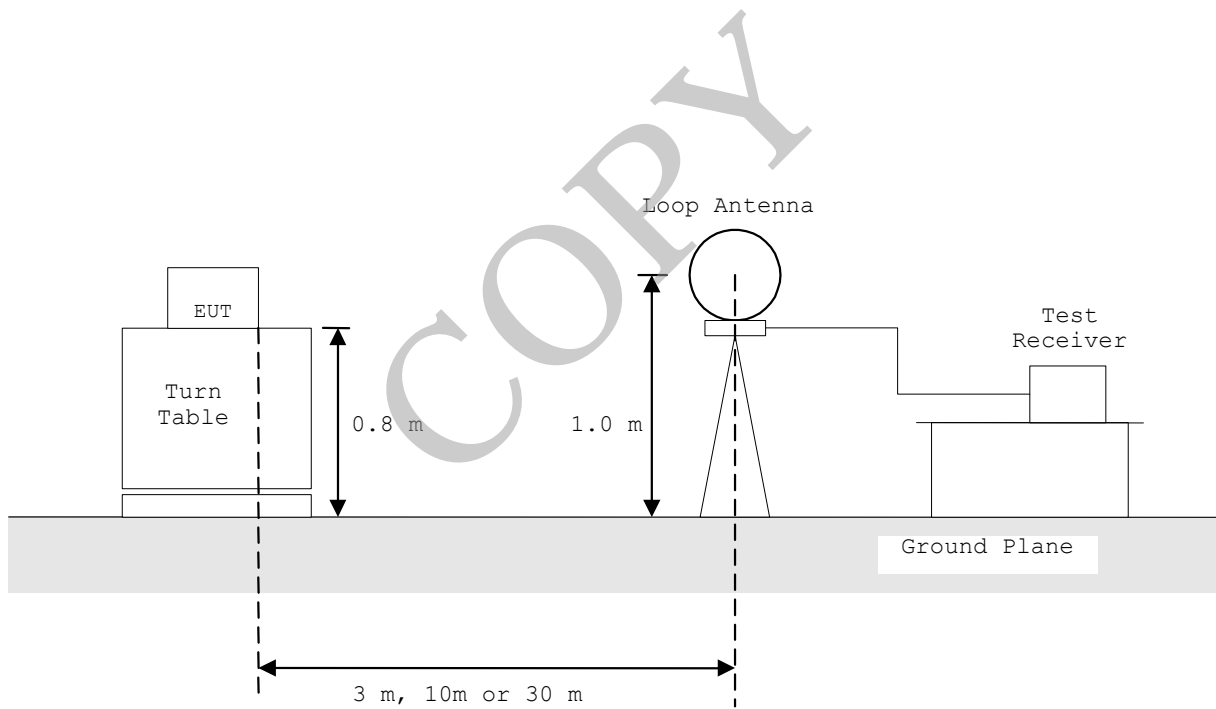

**1.9.10 Radiated Emission ( 30 MHz - 1000 MHz ) :**

According to description of ANSI C63.4-2003 sec.13.1.4, the preliminary radiated emissions measurement were carried out. The preliminary radiated measurements were performed at the measurement distance that specified for compliance to determine the emission characteristics of the EUT.

The EUT configuration (in X, Y and Z axis), cable configuration and mode of operation were determined for producing the maximum level of emissions. These configurations were used for the final radiated emissions measurements.

**Anechoic Chamber**

- Side View -

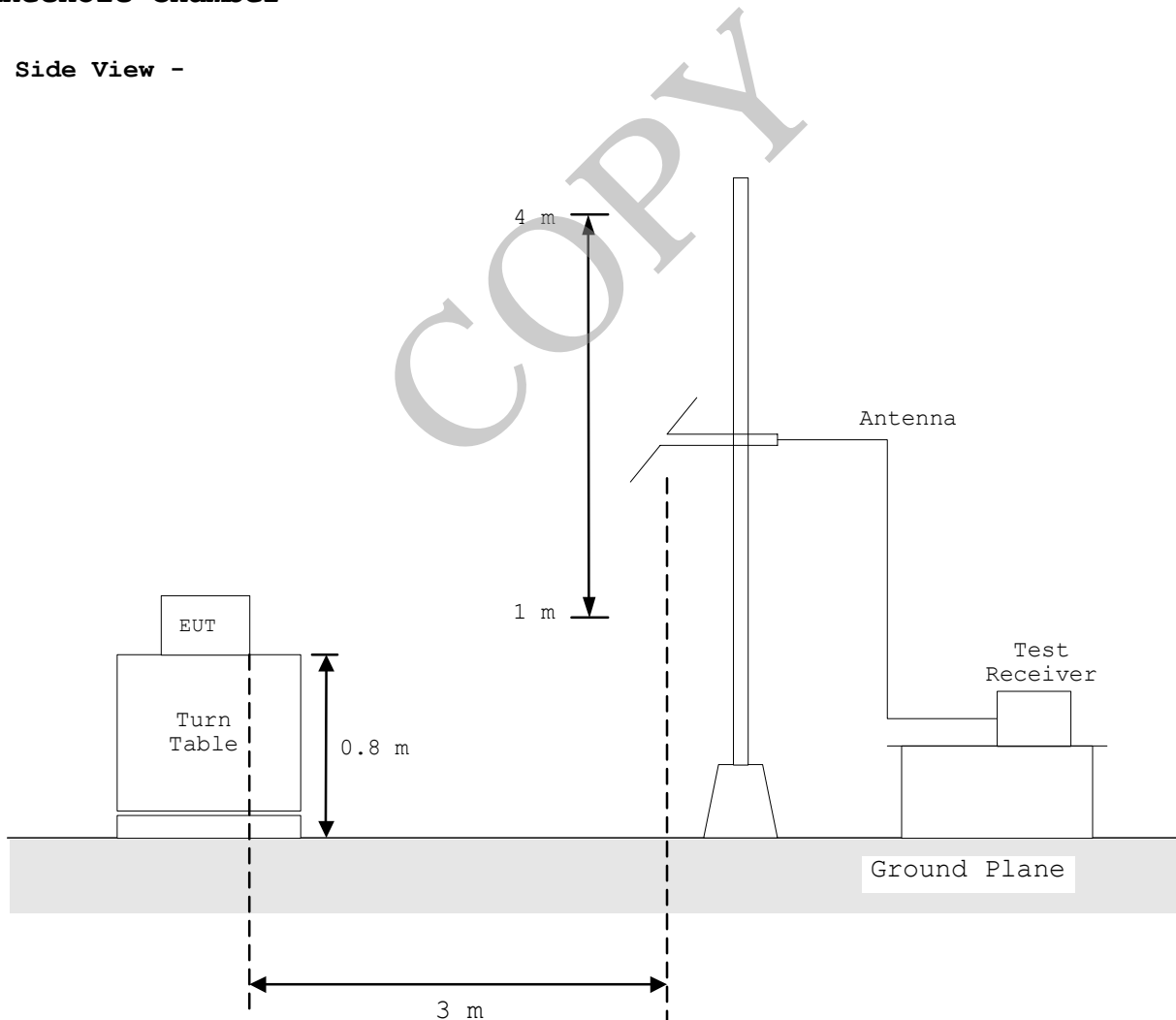

**1.9.11 Radiated Emission (Above 1 GHz) :**

According to description of ANSI C63.4-2003 sec.13.1.4, the preliminary radiated emissions measurements were carried out. The preliminary radiated measurements were performed at the measurement distance that specified for compliance to determine the emission characteristics of the EUT.

The EUT configuration (in X, Y and Z axis), cable configuration and mode of operation were determined for producing the maximum level of emissions. These configurations were used for the final radiated emissions measurements.

**Anechoic Chamber**

- Side View -

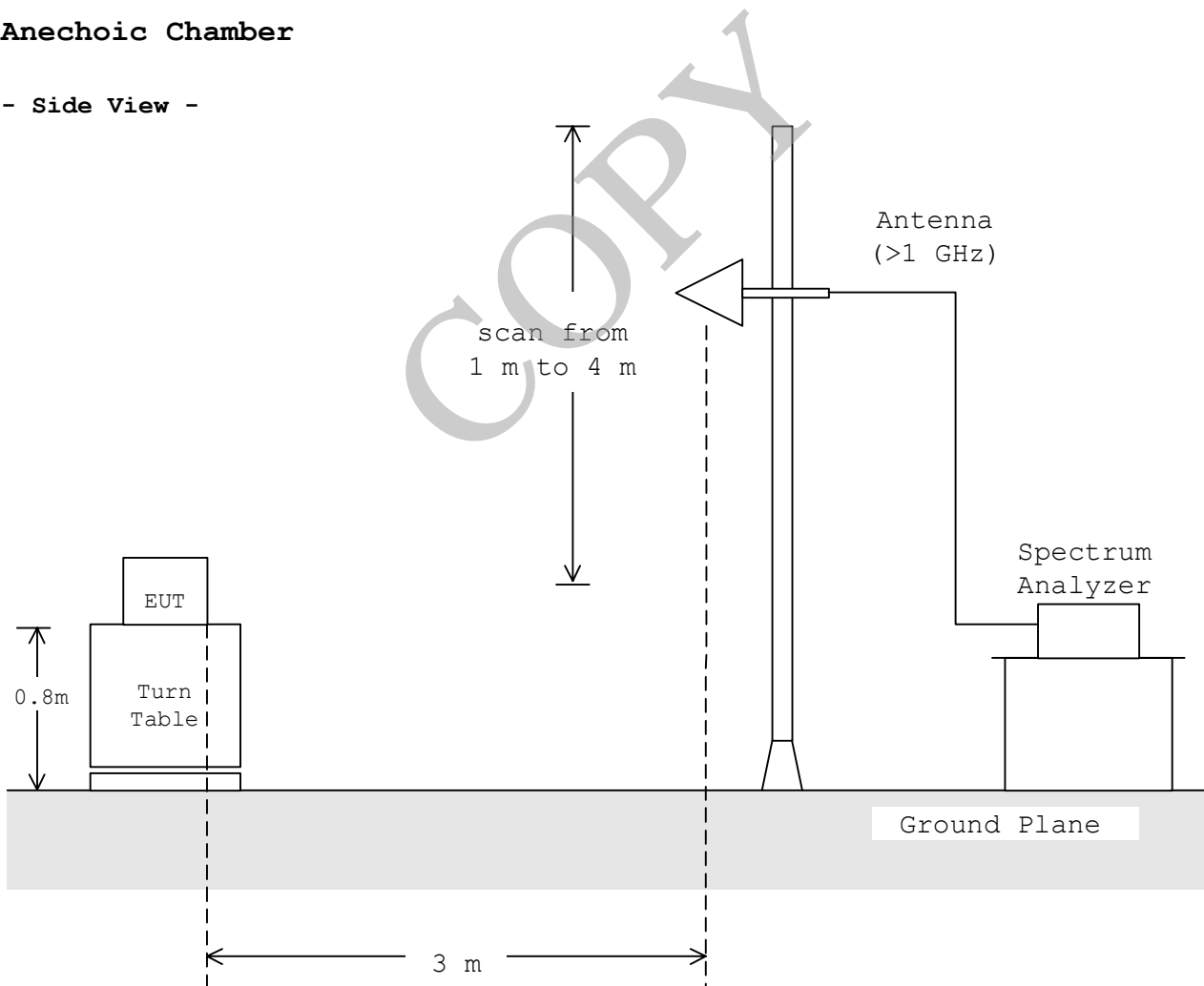

**1.9.12 AC Power Line Conducted Emission ( 150 kHz - 30 MHz ) :**

According to description of ANSI C63.4-2003 sec.13.1.3, the AC power line preliminary conducted emissions measurements were carried out. The preliminary conducted measurements were performed using the spectrum analyzer to observe the emission characteristics of the EUT. The EUT configuration, cable configuration and mode of operation were determined for producing the maximum level of emissions. These configurations were used for final AC power line conducted emissions measurements.

**Shielded Enclosure**

- Side View -

Vertical  
Ground  
Plane

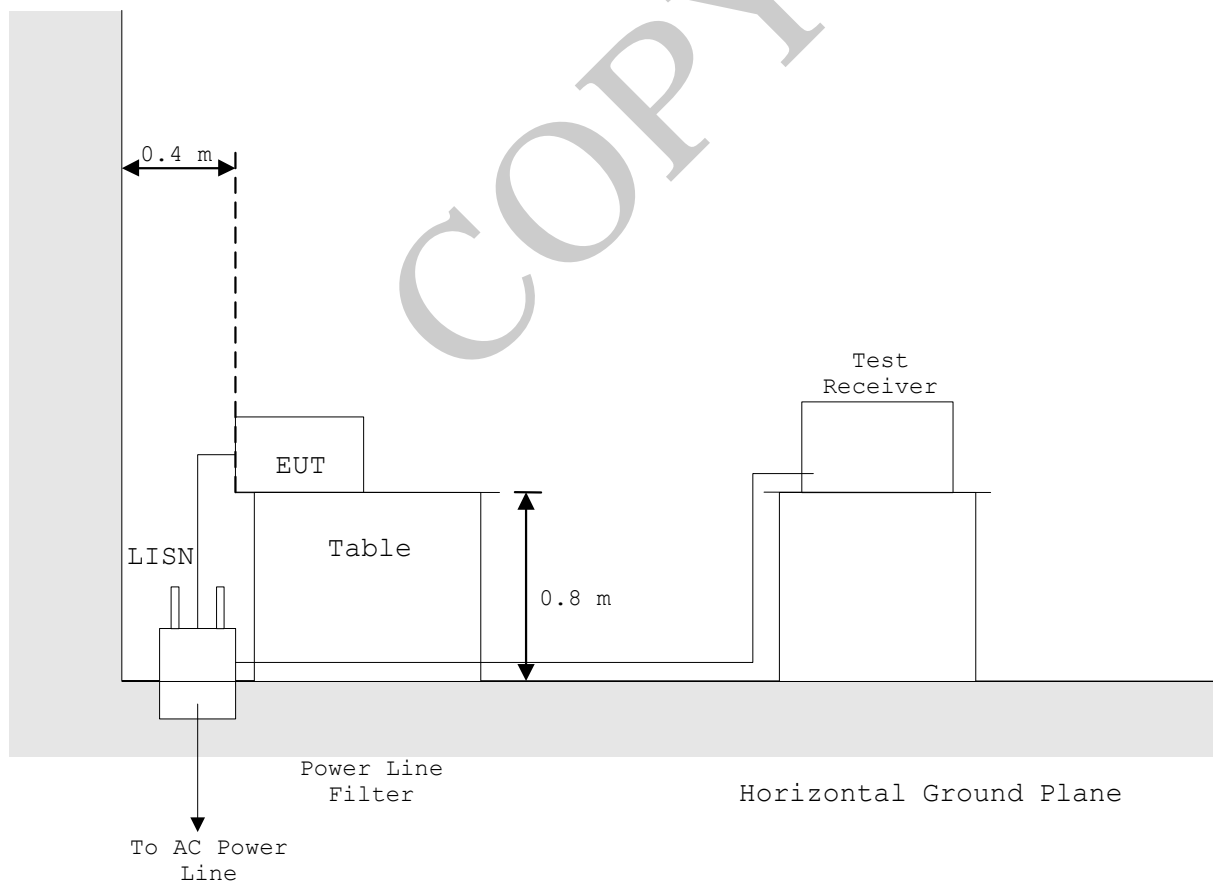

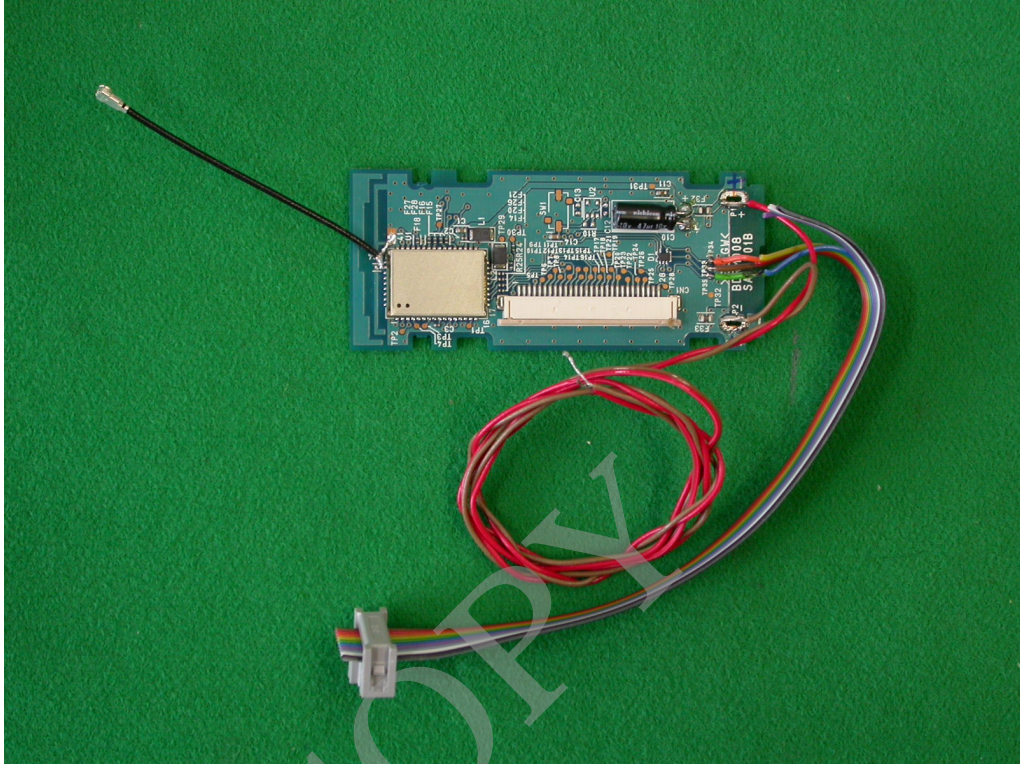
**1.10 TEST ARRANGEMENT (PHOTOGRAPHS)****PHOTOGRAPHS OF THE CONDUCTED TEST**

**PHOTOGRAPHS OF EUT CONFIGURATION FOR RADIATED EMISSIONS MEASUREMENT**

Photograph present configuration with maximum emission



- X axis -



- X axis -

**PHOTOGRAPHS OF EUT CONFIGURATION FOR RADIATED EMISSIONS MEASUREMENT**

Photograph present configuration with maximum emission



- Y axis -



- Y axis -

**PHOTOGRAPHS OF EUT CONFIGURATION FOR RADIATED EMISSIONS MEASUREMENT**

Photograph present configuration with maximum emission



- Z axis -



## 2. TEST DATA

### 2.1 Channel Separation

Date : November 16, 2006  
 Temp.: 24 °C Humi.: 36 %

Mode of EUT : Hopping  
 Test Port : Temporary antenna connector

Channel Separation (kHz)	Limit
1004.008	25 kHz or 20 dB bandwidth of hopping channel

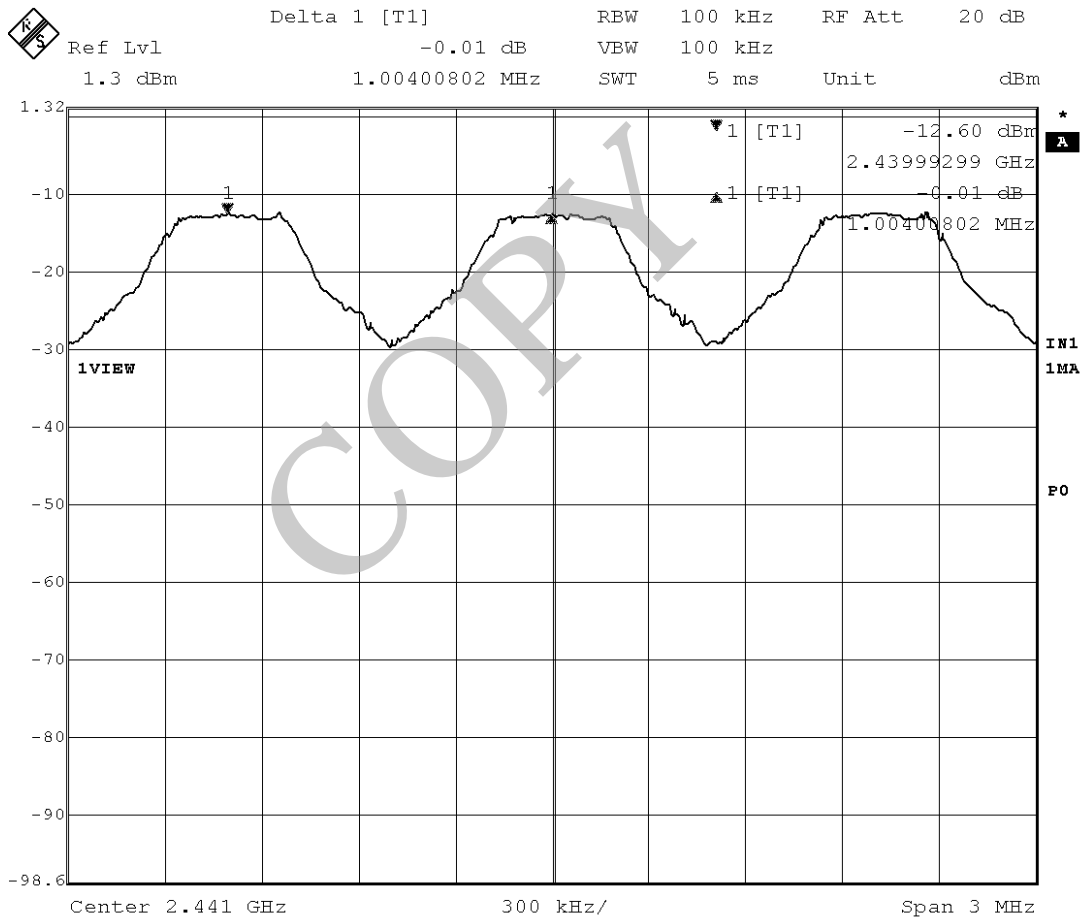

Tested by : *K. Miura*  
 Katsunori Miura  
 Testing Engineer

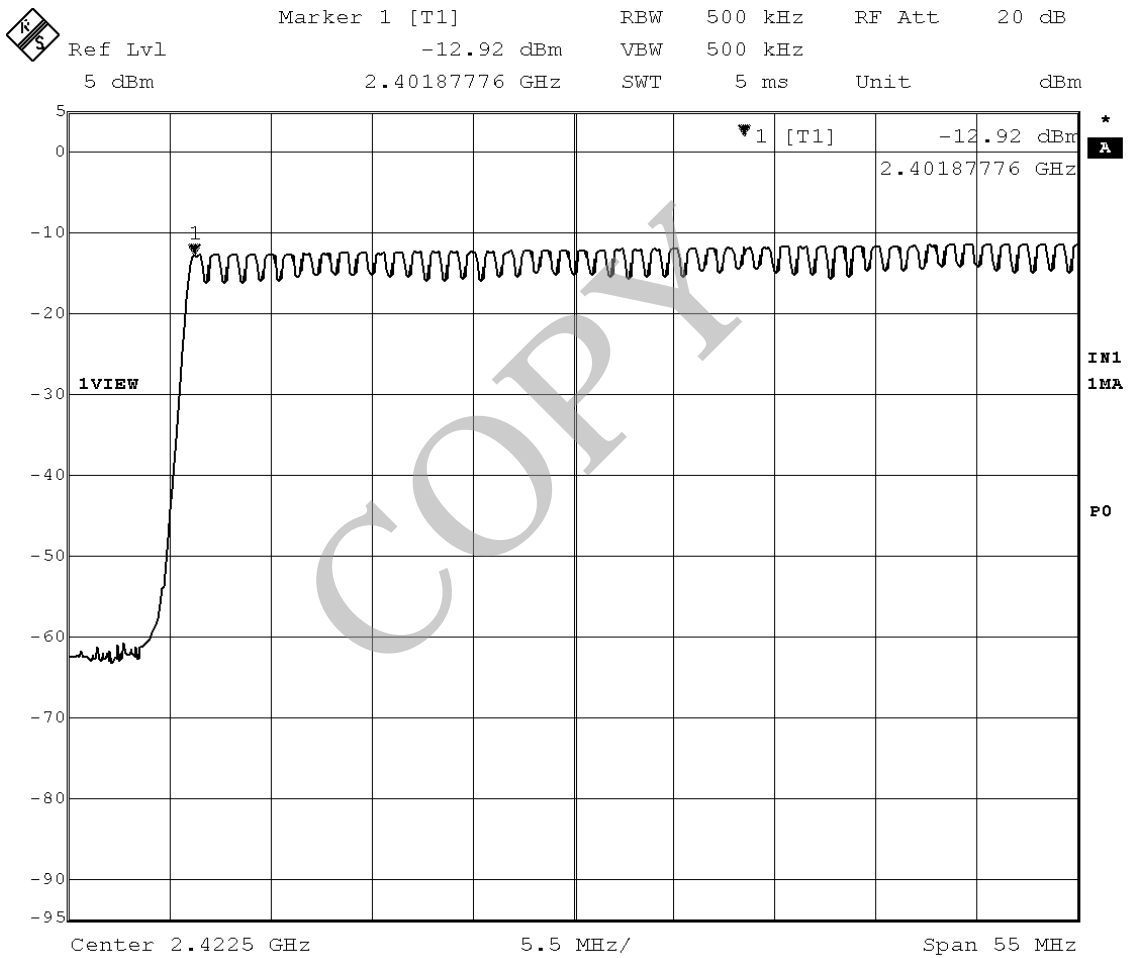
**2.2 Minimum Hopping Channel**Date : November 16, 2006  
Temp.: 24 °C Humi.: 36 %Mode of EUT : Hopping  
Test Port : Temporary antenna connectorHopping Channel                      Limit  
79    15

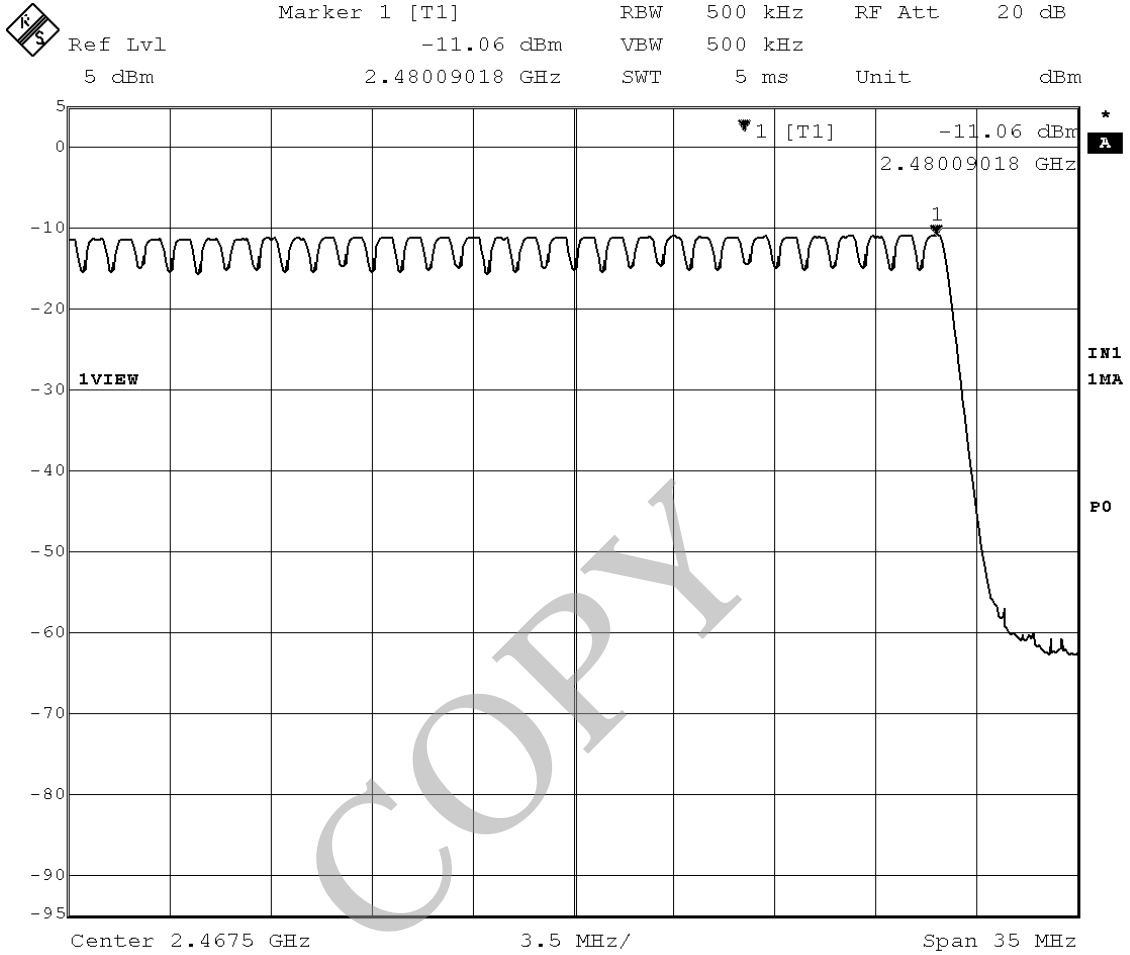

Tested by : *K. Miura*  
 Katsunori Miura  
 Testing Engineer

### 2.3 Occupied Bandwidth

Date : November 16, 2006  
 Temp.: 24 °C Humi.: 36 %

Mode of EUT : TX (0ch: 2402 MHz)  
 Test Port : Temporary antenna connector

Bandwidth (kHz)	Limit (kHz)
949.9	N/A

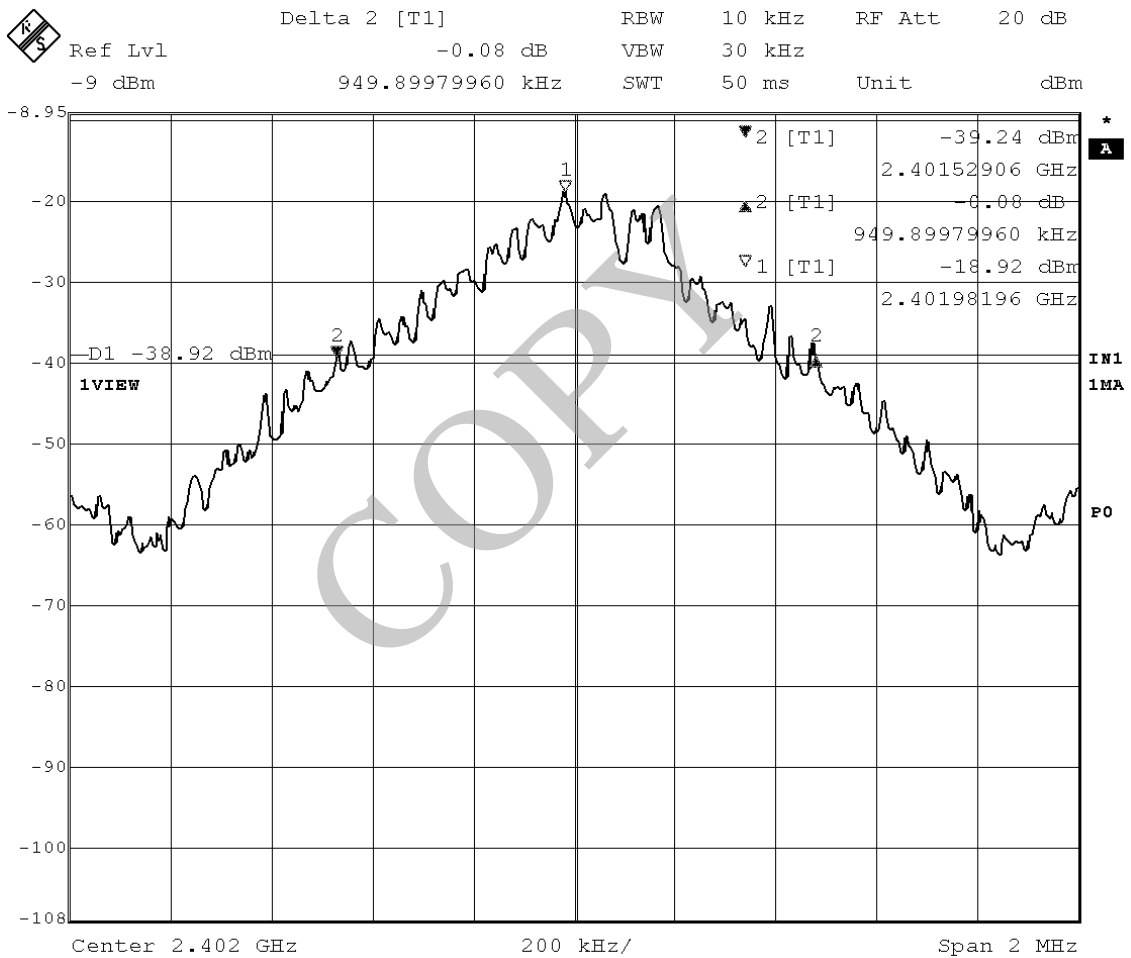

Mode of EUT : TX (39ch: 2441 MHz)  
 Test Port : Temporary antenna connector

Bandwidth	Limit
(kHz)	(kHz)
953.9	N/A

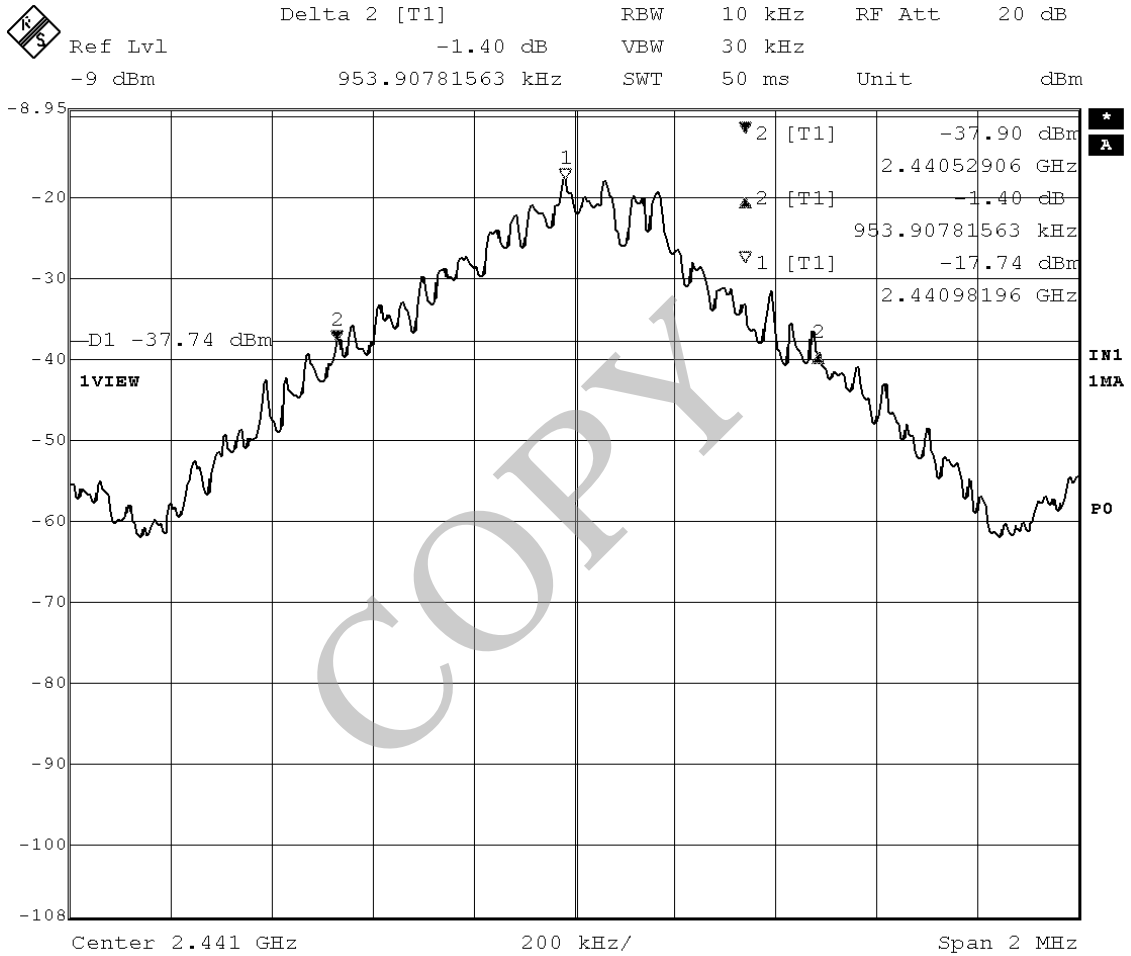

Mode of EUT : TX (78ch: 2480 MHz)  
 Test Port : Temporary antenna connector

Bandwidth (kHz)	Limit (kHz)
929.9	N/A

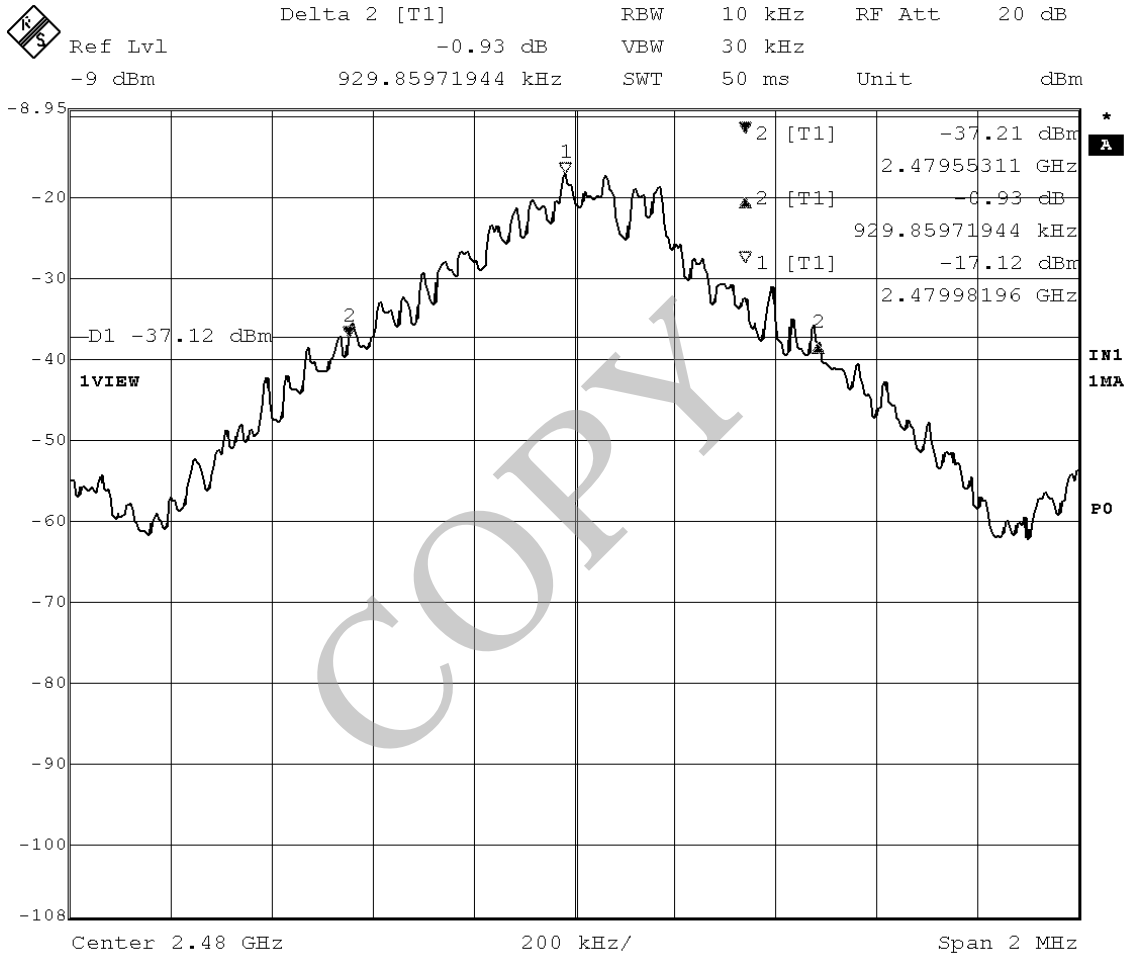

Tested by : *K. Miura*  
 Katsunori Miura  
 Testing Engineer

## 2.4 Dwell Time

Date : November 16, 2006  
 Temp.: 24 °C Humi.: 36 %

Mode of EUT : Hopping(DH1 packet)  
 Test Port : Temporary antenna connector

Dwell Time (ms)	Limit
123.1	400 ms per 31.6 s

Note : The system makes worst case 1600 hops per second or 1 time slot has a length of 625  $\mu$ s with 79 channels. A DH1 Packet need 1 time slot for transmitting and 1 time slot for receiving. Then the system makes worst case 800 hops per second with 79 channels. So the system has each channel 10.1266 times per second and so for 31.6 seconds the system have 320.0 times of appearance. Each tx-time per appearance is 0.3848 ms.  
 Dwell time = 320.0 \* 0.3848 = 123.1 ms

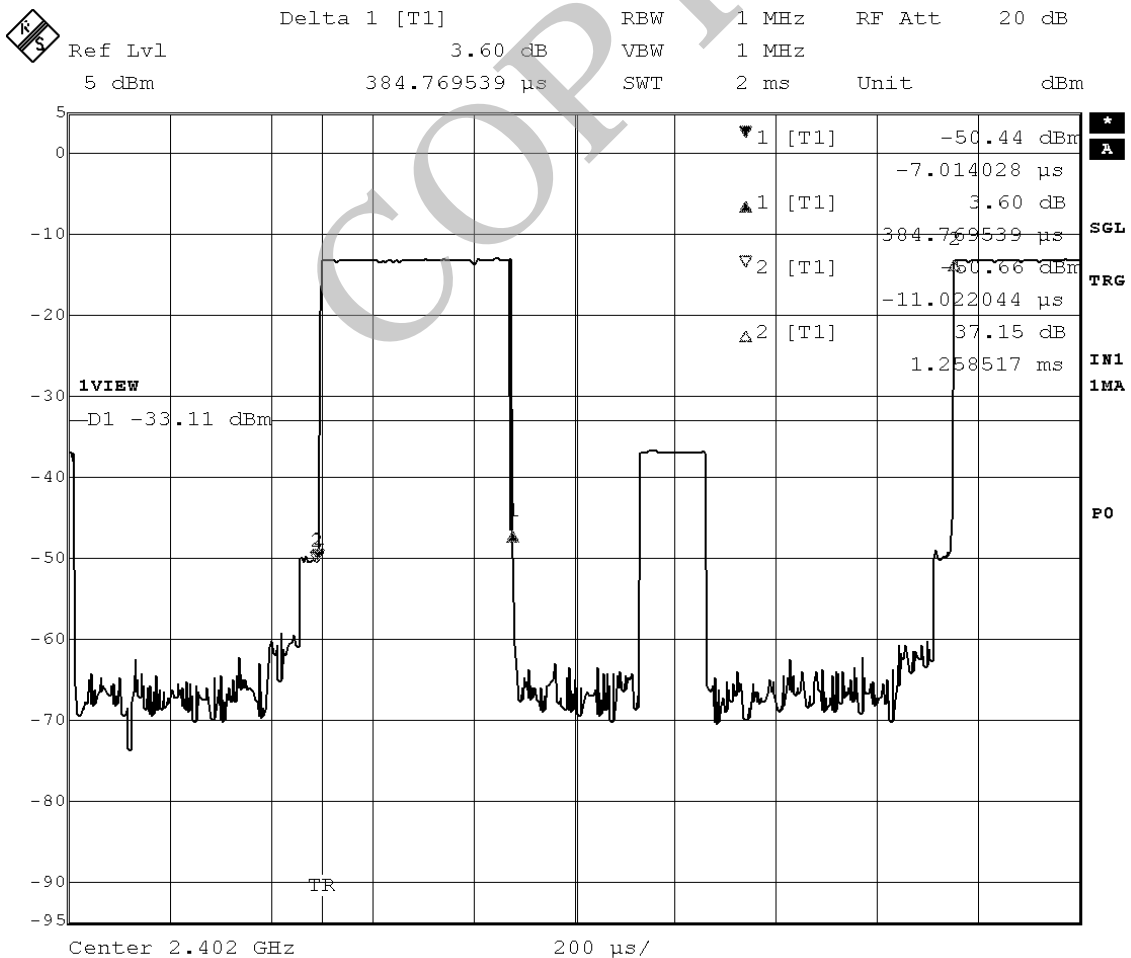

Mode of EUT : Hopping(DH3 packet)  
 Test Port : Temporary antenna connector

Dwell Time	Limit
(ms)	
264.5	400 ms per 31.6 s

Note : A DH3 Packet need 3 time slot for transmitting and 1 time slot for receiving.  
 Then the system makes worst case 400 hops per second with 79 channels. So the system have each channel 5.063 times per second and so for 31.6 seconds the system have 160.0 times of appearance.  
 Each tx-time per appearance is 1.653 ms.  
 Dwell time = 160.0 \* 1.653 = 264.5 ms

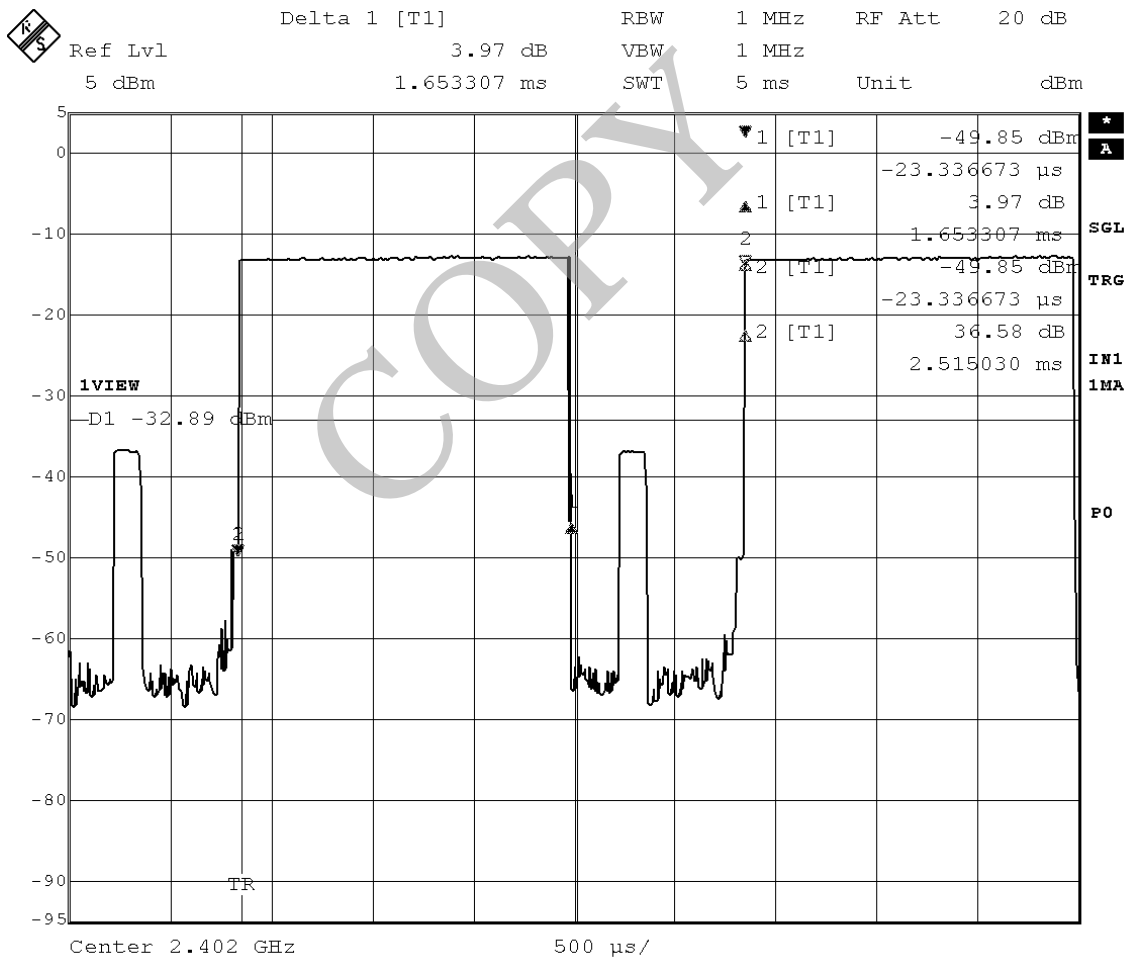



Mode of EUT : Hopping(DH5 packet)  
 Test Port : Temporary antenna connector

Dwell Time                      Limit  
 (ms)  
 308.6                      400 ms per 31.6 s

Note : A DH5 Packet need 5 time slot for transmitting and 1 time slot for receiving.  
 Then the system makes worst case 266.667 hops per second with 79 channels.  
 So the system have each channel 3.3755 times per second and so for 31.6 seconds  
 the system have 106.7 times of appearance.  
 Each tx-time per appearance is 2.892 ms.  
 Dwell time = 106.7 \* 2.892 = 308.6 ms

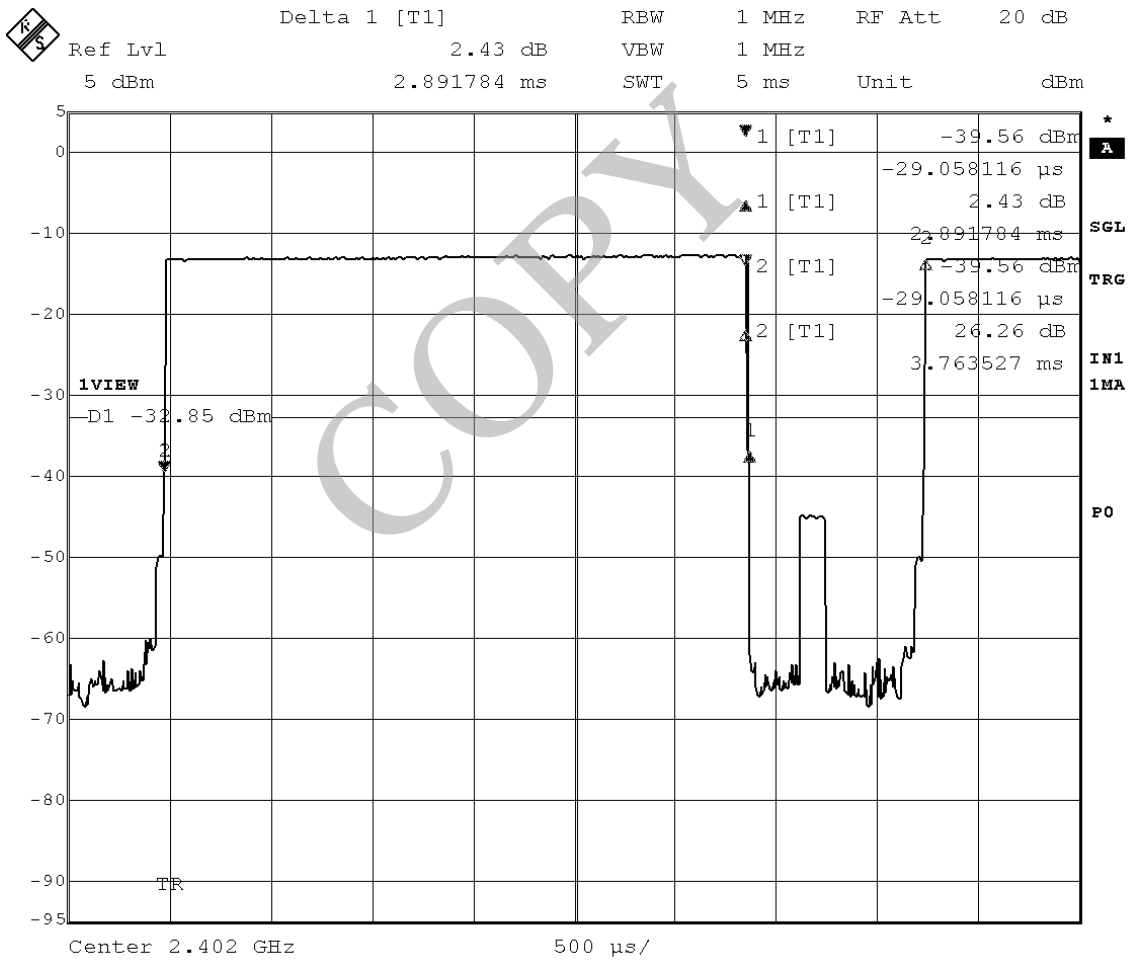

Tested by : *K. Miura*  
 Katsunori Miura  
 Testing Engineer

**2.5 Peak Output Power (Conduction)**Date : November 16, 2006  
Temp.: 24 °C Humi.: 36 %

Test Port : Temporary antenna connector

Mode of EUT	Cable Loss (dB)	Att. Loss (dB)	Meter Reading (dBm)	Peak Power (dBm)	Limit (dBm)
TX (2402 MHz)	0.2	10.48	-13.65	-2.97	30
TX (2441 MHz)	0.2	10.48	-13.72	-3.04	30
TX (2480 MHz)	0.2	10.48	-13.37	-2.69	30

- Note : 1) Rated Supply Voltage : Flash Battery was used  
2) A sample calculation was made at 2402 MHz.  
 $CL + AL + MR = 0.2 + 10.48 + (-13.65) = -2.97$  (dBm)  
CL : Cable Loss  
AL : Attenuator Loss  
MR : Meter Reading  
3) Measuring Instruments Setting :
- |                   |                      |
|-------------------|----------------------|
| Detector Function | Resolution Bandwidth |
| Peak              | 1 MHz                |

Tested by :

Katsunori Miura  
Testing Engineer

## 2.6 Peak Output Power (Radiation)

Not Applicable

## 2.7 Peak Power Density (Conduction)

Date : November 16, 2006  
 Temp.: 24 °C Humi.: 36 %

Mode of EUT : TX (0ch: 2402 MHz)  
 Test Port : Temporary antenna connector

Cable Loss (dB)	Att. Loss (dB)	Meter Reading (dBm)	Peak Power (dBm)	Limit (dBm)
0.2	10.48	-24.89	-14.21	8

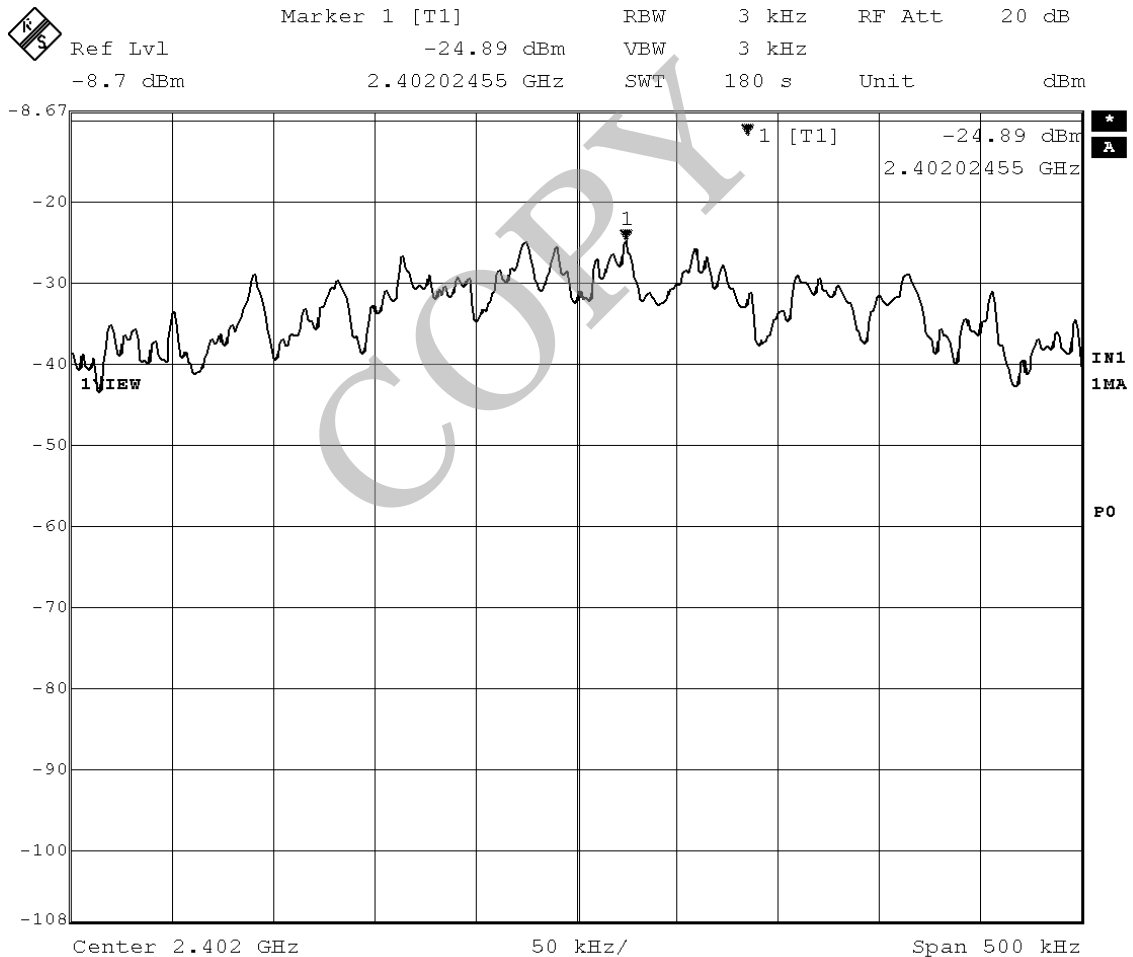

Mode of EUT : TX (39ch: 2441 MHz)  
 Test Port : Temporary antenna connector

Cable Loss (dB)	Att. Loss (dB)	Meter Reading (dBm)	Peak Power (dBm)	Limit (dBm)
0.2	10.48	-23.78	-13.10	8

	Marker 1 [T1]	RBW	3 kHz	RF Att	20 dB
	Ref Lvl	-23.78 dBm	VBW	3 kHz	
	-8.7 dBm	2.44102555 GHz	SWT	180 s	Unit dBm

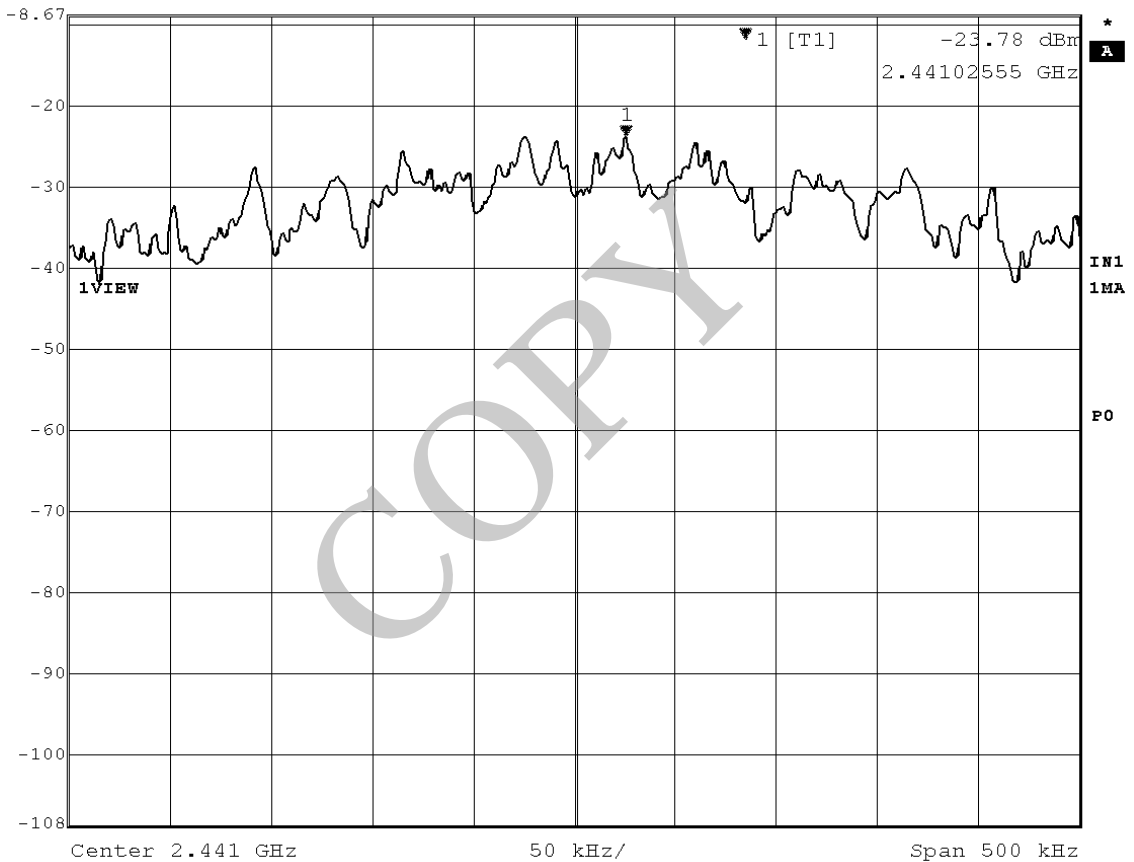

Mode of EUT : TX (78ch: 2480 MHz)  
 Test Port : Temporary antenna connector

Cable Loss (dB)	Att. Loss (dB)	Meter Reading (dBm)	Peak Power (dBm)	Limit (dBm)
0.2	10.48	-23.21	-12.53	8



- Note : 1) A sample calculation was made.  
 $CL + AL + MR = 0.2 + 10.08 + (-24.89) = -14.21$  (dBm)  
 CL : Cable Loss  
 AL : Attenuator Loss  
 MR : Meter Reading
- 2) Measuring Instruments Setting :  
 Detector Function Resolution Bandwidth  
 Peak 3 kHz

Tested by :   
 Katsunori Miura  
 Testing Engineer

## 2.8 Peak Power Density (Radiation)

Not Applicable

## 2.9 Spurious Emissions (Conduction)

Date : November 16, 2006  
 Temp.: 24 °C Humi.: 36 %

### 2.9.1 Band Edge Compliance

Mode of EUT : Hopping  
 Test Port : Temporary antenna connector

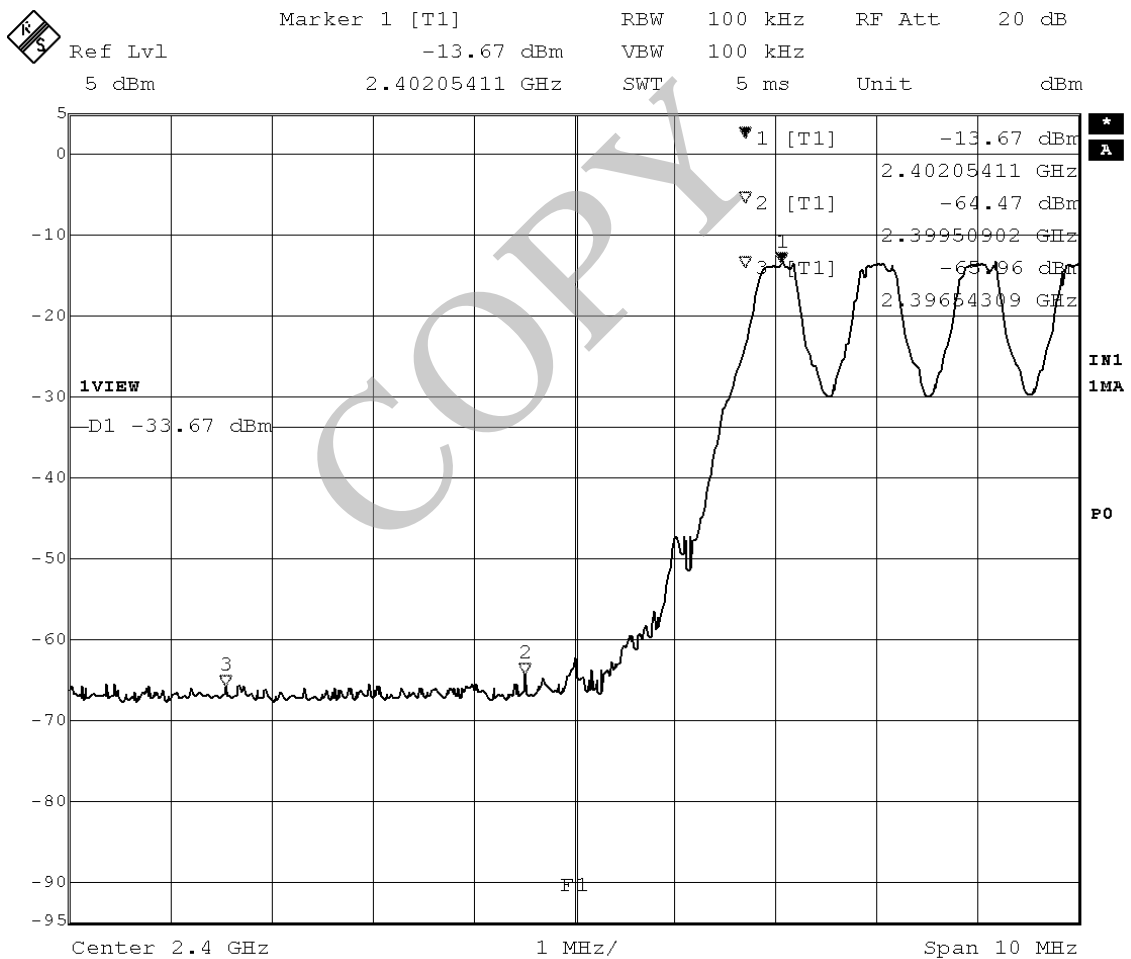

Mode of EUT : Hopping  
 Test Port : Temporary antenna connector

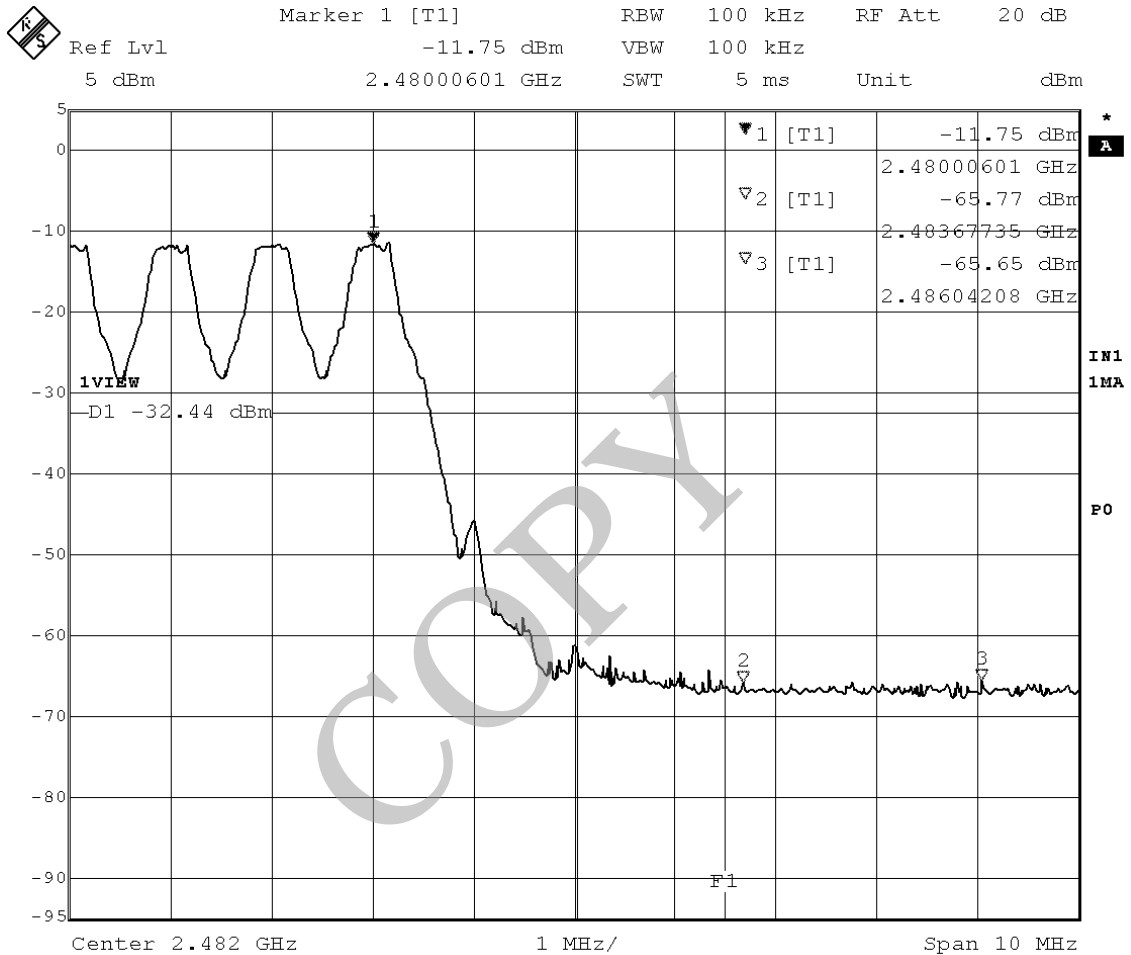

**2.9.2 Other Spurious Emissions**

Mode of EUT : TX (0ch: 2402 MHz)  
 Test Port : Temporary antenna connector

Measurement Frequency (MHz)	Cable Loss (dB)	Att. Loss (dB)	Meter Reading (dBm)	Peak Power (dBm)	Limit (dBm)
2402	0.2	10.48	-13.68	-3.00	--

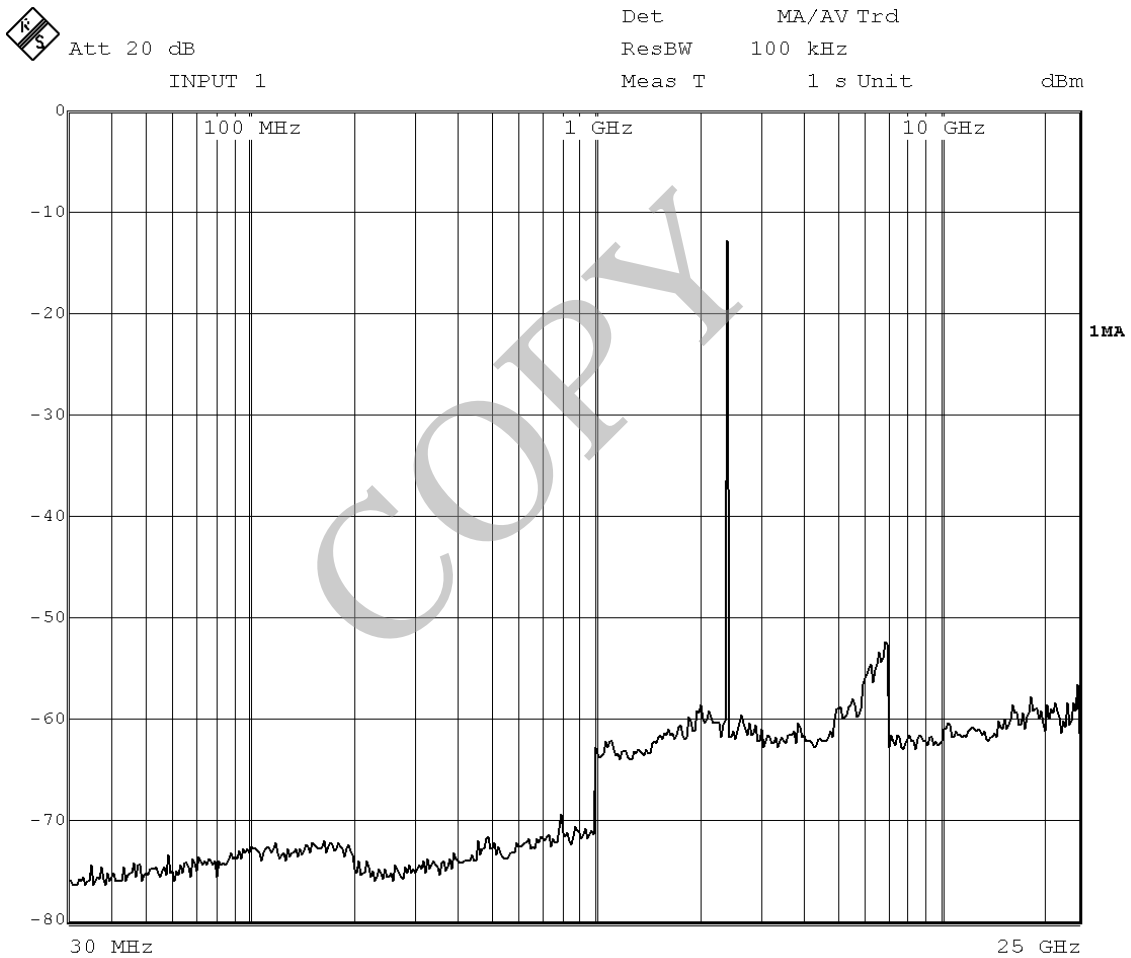



Mode of EUT : TX (39ch: 2441 MHz)  
 Test Port : Temporary antenna connector

Measurement Frequency (MHz)	Cable Loss (dB)	Att. Loss (dB)	Meter Reading (dBm)	Peak Power (dBm)	Limit (dBm)
2441	0.2	10.48	-12.55	-1.87	--

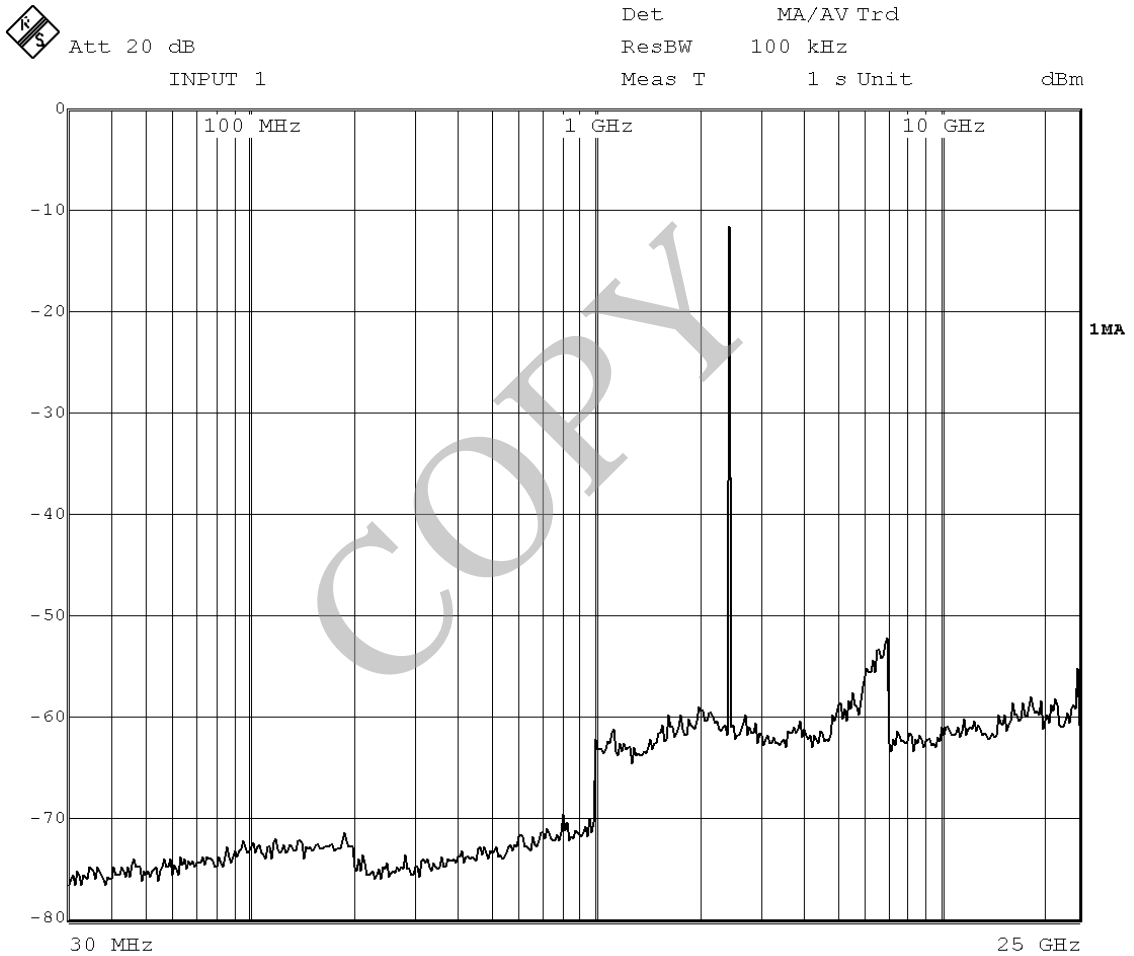

Mode of EUT : TX (78ch: 2480 MHz)  
 Test Port : Temporary antenna connector

Measurement Frequency (MHz)	Cable Loss (dB)	Att. Loss (dB)	Meter Reading (dBm)	Peak Power (dBm)	Limit (dBm)
2480	0.2	10.48	-11.59	-0.91	--

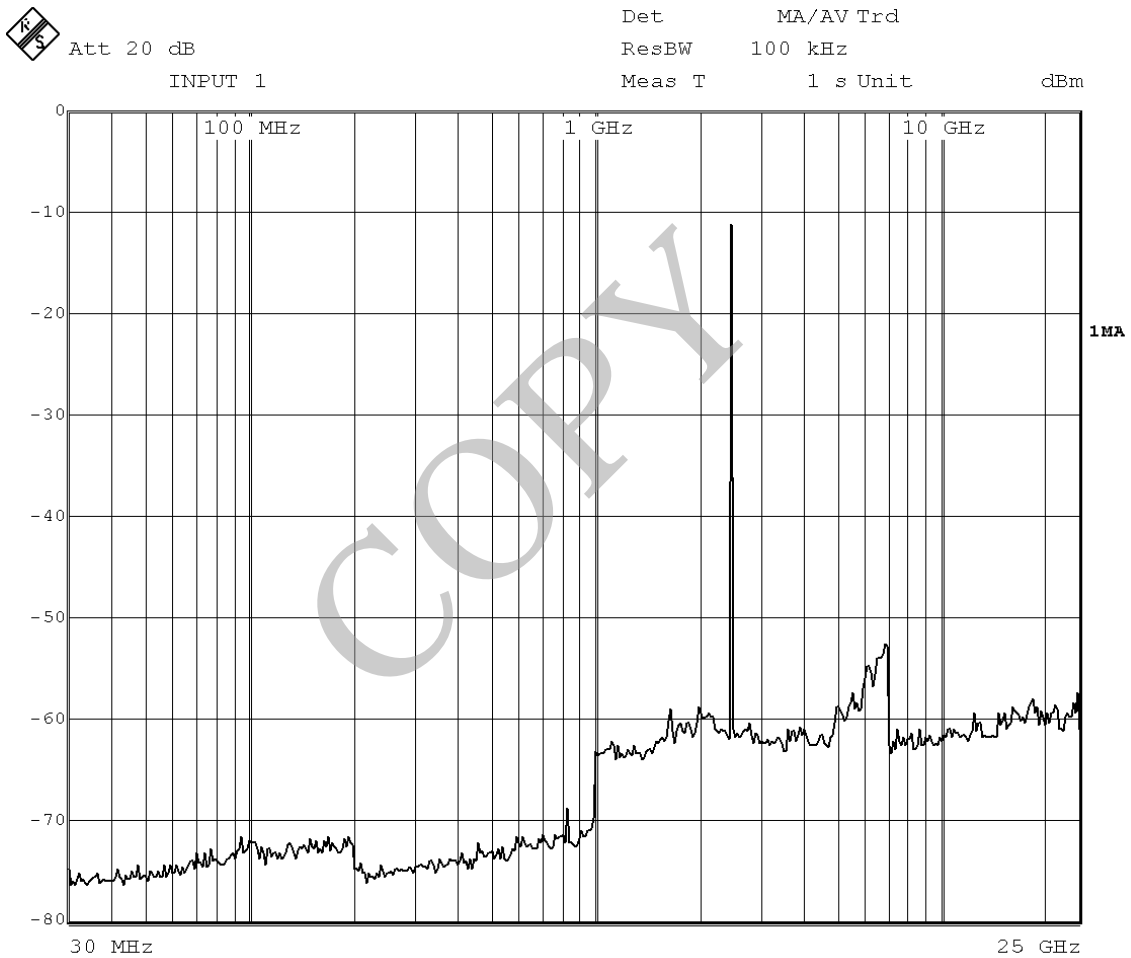

Note : 1) A sample calculation was made.

$$CL + AL + MR = 0.2 + 10.48 + (-13.68) = -3.00 \text{ (dBm)}$$

CL : Cable Loss

AL : Attenuator Loss

MR : Meter Reading

2) Measuring Instruments Setting :

Detector Function	Resolution Bandwidth
Peak	100 kHz

Tested by :

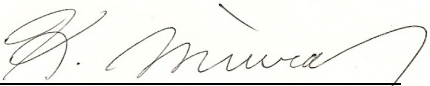
  
Katsunori Miura  
Testing Engineer

COPY

**2.10 Spurious Emissions (Radiation)**

**2.10.1 Band Edge Compliance**

Date : November 19, 2006  
 Temp.: 24 °C Humi.: 53 %

Mode of EUT : Hopping  
 Test Port : Enclosure  
 Antenna Polarization: Horizontal

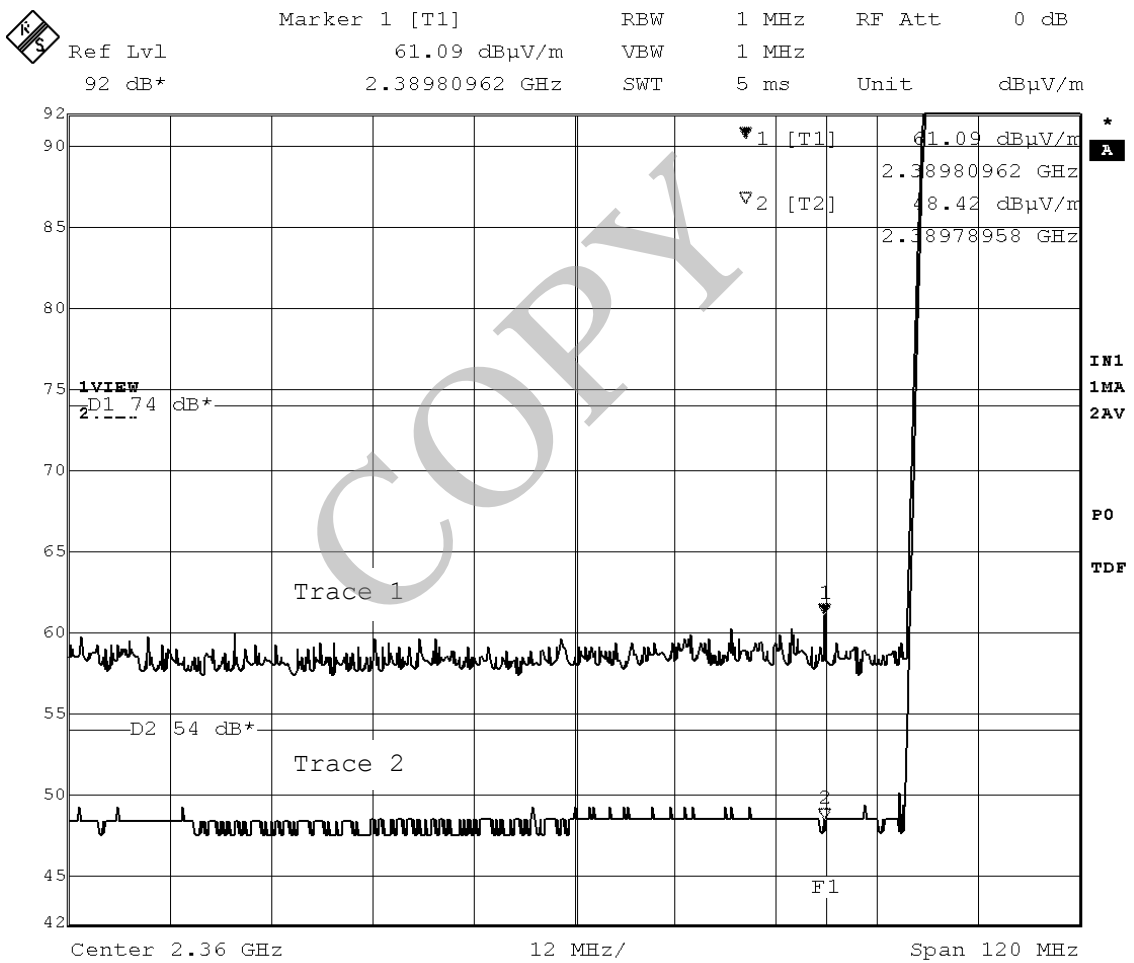

Note: The trace 1 is Peak detection. The trace 2 is Average detection.

Mode of EUT : Hopping  
 Test Port : Enclosure  
 Antenna Polarization: Vertical

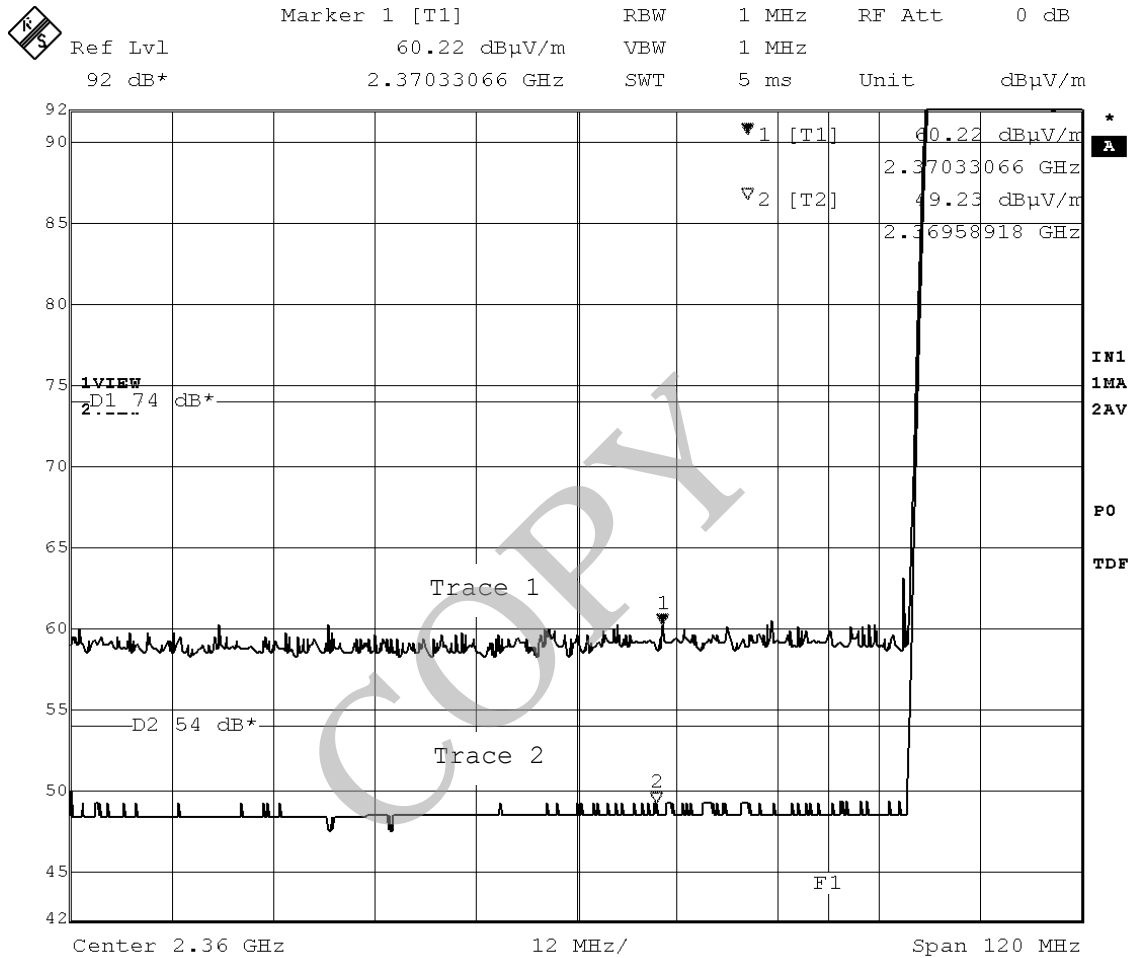

Note: The trace 1 is Peak detection. The trace 2 is Average detection.

Mode of EUT : Hopping  
 Test Port : Enclosure  
 Antenna Polarization: Horizontal

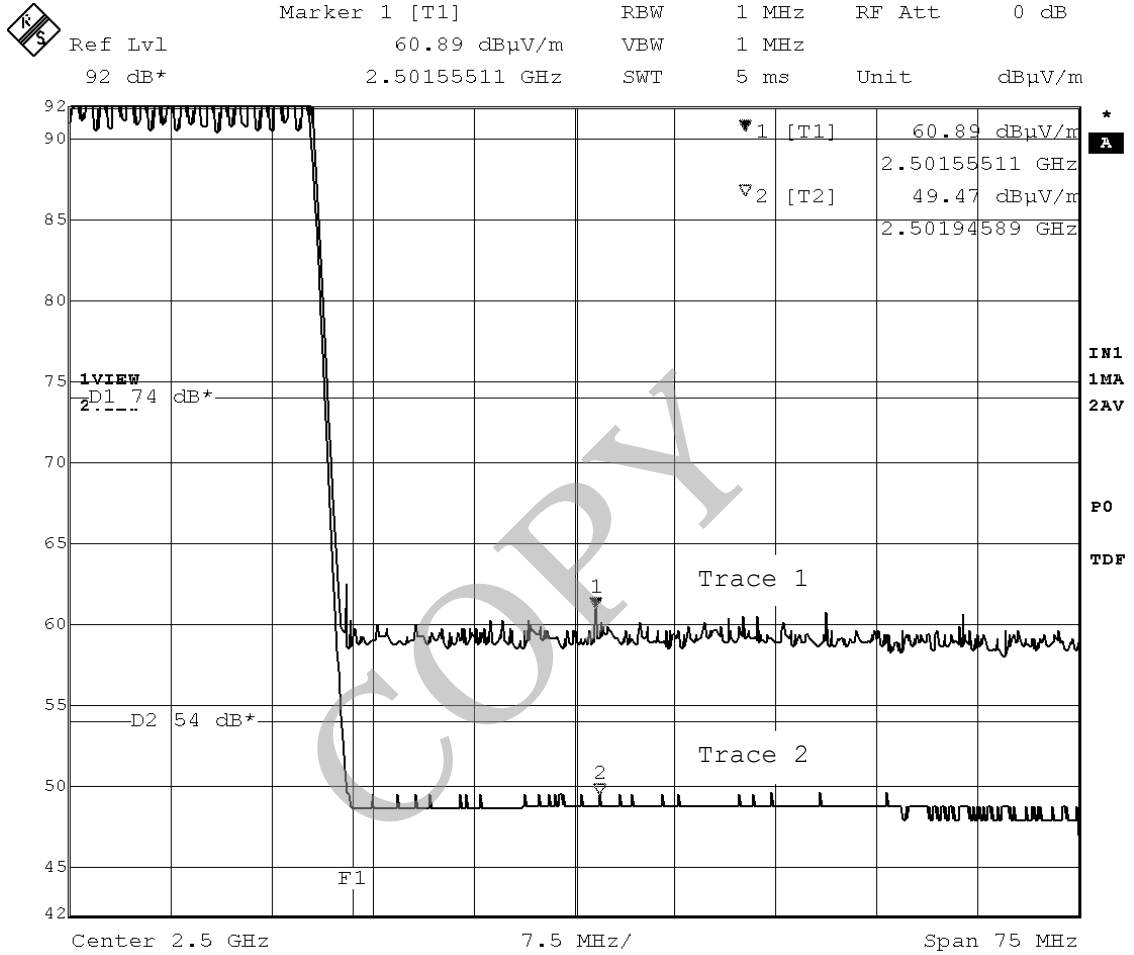

Note: The trace 1 is Peak detection. The trace 2 is Average detection.

Mode of EUT : Hopping  
 Test Port : Enclosure  
 Antenna Polarization: Vertical

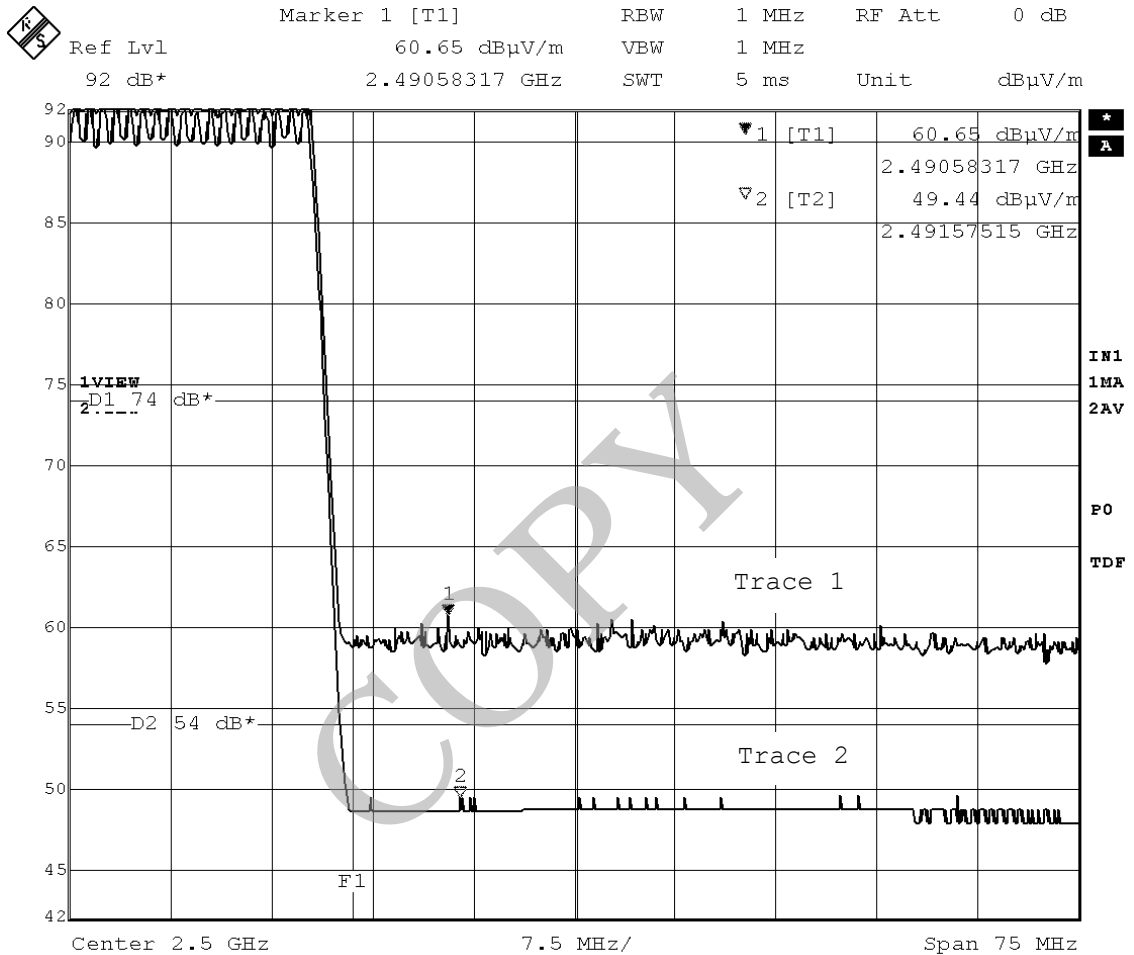

Note: The trace 1 is Peak detection. The trace 2 is Average detection.

---

**2.10.2 Other Spurious Emissions****2.10.2.1 Spurious Emissions in the frequency range from 9 kHz to 30 MHz**Date : November 19, 2006  
Temp.: 24 °C Humi.: 53 %

Test Port : Enclosure

Mode of EUT : All modes have been investigated and the worst case mode for  
Channel (78ch: 2480 MHz) has been listed.

No spurious emissions in the range 20 dB below the limit.

COPY



**2.10.2.2 Spurious Emissions in the frequency range from 30 MHz to 1000 MHz**

Date : November 19, 2006  
 Temp.: 24 °C Humi.: 53 %

Test Port : Enclosure

Mode of EUT : All modes have been investigated and the worst case mode for Channel (78ch: 2480 MHz) has been listed.

Frequency (MHz)	P-A Factor (dB)	Correction Factor (dB)	Polarization	Meter Reading (dBuV)			Limits (dBuV/m)		Emission Levels (dBuV/m)		Margins (dB)	
				QP	AV	Peak	QP/AV	Peak	QP/AV	Peak	QP/AV	Peak
33.35	0.0	20.8	V	7.1	-	-	40.0	-	27.9	-	12.1	-
53.35	0.0	13.9	V	12.8	-	-	40.0	-	26.7	-	13.3	-
80.02	0.0	10.4	H	17.9	-	-	40.0	-	28.3	-	11.7	-
93.34	0.0	12.8	V	18.0	-	-	43.5	-	30.8	-	12.7	-
200.01	0.0	21.2	V	5.6	-	-	43.5	-	26.8	-	16.7	-
240.00	0.0	21.8	V	5.8	-	-	46.0	-	27.6	-	18.4	-
264.01	0.0	22.6	H	1.3	-	-	46.0	-	23.9	-	22.1	-
276.00	0.0	23.2	H	2.2	-	-	46.0	-	25.4	-	20.6	-
288.02	0.0	23.9	H	2.1	-	-	46.0	-	26.0	-	20.0	-
300.03	0.0	19.0	H	5.5	-	-	46.0	-	24.5	-	21.5	-
312.02	0.0	18.9	H	7.6	-	-	46.0	-	26.5	-	19.5	-
324.02	0.0	19.0	H	6.7	-	-	46.0	-	25.7	-	20.3	-
336.02	0.0	19.3	H	5.0	-	-	46.0	-	24.3	-	21.7	-
480.02	0.0	22.9	V	12.0	-	-	46.0	-	34.9	-	11.1	-
504.02	0.0	23.3	V	8.2	-	-	46.0	-	31.5	-	14.5	-
528.02	0.0	23.8	V	10.8	-	-	46.0	-	34.6	-	11.4	-
720.02	0.0	26.8	H	9.0	-	-	46.0	-	35.8	-	10.2	-
744.02	0.0	26.8	H	7.2	-	-	46.0	-	34.0	-	12.0	-
792.01	0.0	27.3	H	7.0	-	-	46.0	-	34.3	-	11.7	-
840.03	0.0	28.3	H	5.6	-	-	46.0	-	33.9	-	12.1	-

- Notes :
- 1) The spectrum was checked from 30 MHz to 1000 MHz.
  - 2) The cable loss, amp. gain and antenna factor are included in the correction factor.
  - 3) The symbol of "<" means "or less".
  - 4) The symbol of ">" means "or greater".
  - 5) A sample calculation (QP/AV) was made at 33.35 (MHz).  
 $PA + Cf + Mr = 0 + 20.8 + 7.1 = 27.9$  (dBuV/m)  
 PA = Peak to Average Factor (P-A Factor)  
 Cf = Correction Factor  
 Mr = Meter Reading

6) Measuring Instrument Setting :

<u>Detector function</u>	<u>Resolution Bandwidth</u>	<u>Video Bandwidth</u>
Quasi-peak (QP)	120 kHz	-

**2.10.2.3 Spurious Emissions in the frequency above 1000 MHz**

Date : November 19, 2006  
 Temp.: 24 °C Humi.: 53 %

Test Port : Enclosure

Mode of EUT : TX (0ch: 2402 MHz)

Frequency (GHz)	P-A Factor (dB)	Correction Factor (dB)	Polarization	Meter Reading (dBuV)		Limits (dBuV/m)		Emission Levels (dBuV/m)		Margins (dB)	
				AV	Peak	AV	Peak	AV	Peak	AV	Peak
1.6013	0.0	-1.1	H	36.9	43.6	54.0	74.0	35.8	42.5	18.2	31.5
4.8043	0.0	7.4	V	31.4	40.9	54.0	74.0	38.8	48.3	15.2	25.7

Mode of EUT : TX (39ch: 2441 MHz)

Frequency (GHz)	P-A Factor (dB)	Correction Factor (dB)	Polarization	Meter Reading (dBuV)		Limits (dBuV/m)		Emission Levels (dBuV/m)		Margins (dB)	
				AV	Peak	AV	Peak	AV	Peak	AV	Peak
1.6274	0.0	-1.0	H	36.7	43.3	54.0	74.0	35.7	42.3	18.3	31.7
4.8823	0.0	7.5	H	32.3	42.2	54.0	74.0	39.8	49.7	14.2	24.3

Mode of EUT : TX (78ch: 2480 MHz)

Frequency (GHz)	P-A Factor (dB)	Correction Factor (dB)	Polarization	Meter Reading (dBuV)		Limits (dBuV/m)		Emission Levels (dBuV/m)		Margins (dB)	
				AV	Peak	AV	Peak	AV	Peak	AV	Peak
1.6534	0.0	-1.0	H	36.9	43.4	54.0	74.0	35.9	42.4	18.1	31.6
4.9603	0.0	7.7	H	32.1	41.9	54.0	74.0	39.8	49.6	14.2	24.4

- Notes :
- 1) The spectrum was checked from 1.0 GHz to 26.5 GHz.
  - 2) The cable loss, amp. gain and antenna factor are included in the correction factor.
  - 3) The symbol of "<" means "or less".
  - 4) The symbol of ">" means "or greater".
  - 5) A sample calculation (Peak) was made at 1.60134 (GHz).  
 $PA + Cf + Mr = 0 + -1.1 + 43.6 = 42.5$  (dBuV/m)  
PA = Peak to Average Factor (P-A Factor)  
Cf = Correction Factor  
Mr = Meter Reading

## 6) Measuring Instrument Setting :

<u>Detector function</u>	<u>Resolution Bandwidth</u>	<u>Video Bandwidth</u>
Average (AV)	1 MHz	10 Hz
Peak	1 MHz	1 MHz

Tested by :

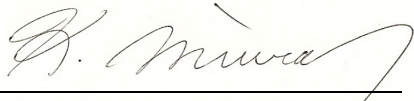
  
Katsunori Miura  
Testing Engineer**2.11 AC Power Line Conducted Emissions**

Not Applicable

**2.12 RF Exposure Compliance**

Not Applicable

## 2.13 Spurious Emissions for Receiver (Radiation)

### 2.13.1 Spurious Emissions in the frequency range from 30 MHz to 1000 MHz

Date : November 19, 2006  
 Temp.: 24 °C Humi.: 53 %

Test Port : Enclosure

Mode of EUT : All modes have been investigated and the worst case mode for Channel (78ch: 2480 MHz) has been listed.

Frequency (MHz)	P-A Factor (dB)	Correction Factor (dB)	Polarization	Meter Reading (dBuV)			Limits (dBuV/m)		Emission Levels (dBuV/m)		Margins (dB)	
				QP	AV	Peak	QP/AV	Peak	QP/AV	Peak	QP/AV	Peak
264.01	0.0	22.6	H	1.3	-	-	46.0	-	23.9	-	22.1	-
276.00	0.0	23.2	H	2.2	-	-	46.0	-	25.4	-	20.6	-
288.02	0.0	23.9	H	2.1	-	-	46.0	-	26.0	-	20.0	-
300.03	0.0	19.0	H	5.5	-	-	46.0	-	24.5	-	21.5	-
312.02	0.0	18.9	H	7.6	-	-	46.0	-	26.5	-	19.5	-
324.02	0.0	19.0	H	6.7	-	-	46.0	-	25.7	-	20.3	-
336.02	0.0	19.3	H	5.0	-	-	46.0	-	24.3	-	21.7	-
480.02	0.0	22.9	V	12.0	-	-	46.0	-	34.9	-	11.1	-
504.02	0.0	23.3	V	8.2	-	-	46.0	-	31.5	-	14.5	-
528.02	0.0	23.8	V	10.8	-	-	46.0	-	34.6	-	11.4	-
720.02	0.0	26.8	H	9.0	-	-	46.0	-	35.8	-	10.2	-
744.02	0.0	26.8	H	7.2	-	-	46.0	-	34.0	-	12.0	-
792.01	0.0	27.3	H	7.0	-	-	46.0	-	34.3	-	11.7	-
840.03	0.0	28.3	H	5.6	-	-	46.0	-	33.9	-	12.1	-

- Notes :
- 1) The spectrum was checked from 30 MHz to 1000 MHz.
  - 2) The cable loss, amp. gain and antenna factor are included in the correction factor.
  - 3) The symbol of "<" means "or less".
  - 4) The symbol of ">" means "or greater".
  - 5) A sample calculation(QP/AV) was made at 264.01 (MHz).  
 $PA + Cf + Mr = 0 + 22.6 + 1.3 = 23.9$  (dBuV/m)  
 PA = Peak to Average Factor(P-A Factor)  
 Cf = Correction Factor  
 Mr = Meter Reading

6) Measuring Instrument Setting :

<u>Detector function</u>	<u>Resolution Bandwidth</u>	<u>Video Bandwidth</u>
Quasi-peak (QP)	120 kHz	-

**2.13.2 Spurious Emissions in the frequency above 1000 MHz**

Date : November 19, 2006  
 Temp.: 24 °C Humi.: 53 %

Test Port : Enclosure

Mode of EUT : RX (0ch: 2402 MHz)

Frequency (GHz)	P-A Factor (dB)	Correction Factor (dB)	Polarization	Meter Reading (dBuV)		Limits (dBuV/m)		Emission Levels (dBuV/m)		Margins (dB)	
				AV	Peak	AV	Peak	AV	Peak	AV	Peak
1.6027	0.0	-1.3	H	37.9	43.0	54.0	74.0	36.6	41.7	17.4	32.3
2.4040	0.0	1.6	H	36.1	41.1	54.0	74.0	37.7	42.7	16.3	31.3

Mode of EUT : RX (39ch: 2441 MHz)

Frequency (GHz)	P-A Factor (dB)	Correction Factor (dB)	Polarization	Meter Reading (dBuV)		Limits (dBuV/m)		Emission Levels (dBuV/m)		Margins (dB)	
				AV	Peak	AV	Peak	AV	Peak	AV	Peak
1.6287	0.0	-1.2	H	39.8	44.4	54.0	74.0	38.6	43.2	15.4	30.8
2.4430	0.0	1.7	H	36.3	41.7	54.0	74.0	38.0	43.4	16.0	30.6

Mode of EUT : RX (78ch: 2480 MHz)

Frequency (GHz)	P-A Factor (dB)	Correction Factor (dB)	Polarization	Meter Reading (dBuV)		Limits (dBuV/m)		Emission Levels (dBuV/m)		Margins (dB)	
				AV	Peak	AV	Peak	AV	Peak	AV	Peak
1.6547	0.0	-1.1	H	40.8	45.0	54.0	74.0	39.7	43.9	14.3	30.1
2.4820	0.0	1.8	H	37.9	42.6	54.0	74.0	39.7	44.4	14.3	29.6

- Notes :
- 1) The spectrum was checked from 1.0 GHz to 26.5 GHz.
  - 2) The cable loss, amp. gain and antenna factor are included in the correction factor.
  - 3) The symbol of "<" means "or less".
  - 4) The symbol of ">" means "or greater".
  - 5) A sample calculation (Peak) was made at 1.60268 (GHz).  
 $PA + Cf + Mr = 0 + -1.3 + 43 = 41.7$  (dBuV/m)  
PA = Peak to Average Factor (P-A Factor)  
Cf = Correction Factor  
Mr = Meter Reading

- 6) Measuring Instrument Setting :

<u>Detector function</u>	<u>Resolution Bandwidth</u>	<u>Video Bandwidth</u>
Average (AV)	1 MHz	10 Hz
Peak	1 MHz	1 MHz

Tested by :

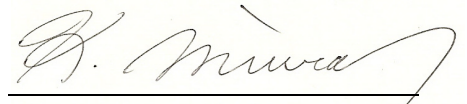
  
Katsunori Miura  
Testing Engineer

#### 2.14 AC Power Line Conducted Emissions for Receiver

Not Applicable

# Appendix

## Test Instruments List

COPY

No	Type	Model	Manufacturer	Serial	ID	Last Cal.	Interval
31-Oct-2006							
<b>Test Facilities:</b>							
1	Anechoic Chamber A	-	TDK	-	800-01-502E0	Mar 2006	1 Year
2	Anechoic Chamber B	-	TDK	-	800-01-503E0	Mar 2006	1 Year
3	Shield Room A	-	TDK	-	800-01-501E0	-	-
4	Shield Room B	-	Ray Proof	-	800-01-010E0	-	-
5	Shield Room C	-	TDK	-	800-01-504E0	-	-
6	Shield Room D	-	Emerson	-	800-01-022E0	-	-
7	Shield Room E	-	TDK	-	800-01-505E0	-	-

**Measuring Instruments:**

10	Test Receiver	ESHS10	Rohde & Schwarz	835871/004	119-01-505E0	Apr 2006	1 Year
11	Test Receiver	ESVS10	Rohde & Schwarz	826148/002	119-03-504E0	Apr 2006	1 Year
12	Test Receiver	ESVS10	Rohde & Schwarz	832699/001	119-03-506E0	Apr 2006	1 Year
13	Test Receiver	ESI26	Rohde & Schwarz	100043	119-04-511E0	Aug 2006	1 Year
14	Spectrum Analyzer	R3182	Advantest	120600581	122-02-521E0	Mar 2006	1 Year
17	Spectrum Analyzer	8566B	Hewlett Packard	2747A05855	122-02-517E0	Apr 2006	1 Year
18	RF Pre-selector	85685A	Hewlett Packard	2901A00933	122-02-519E0	Apr 2006	1 Year
19	Spectrum Analyzer	R3132	Advantest	120500072	122-02-520E0	Sep 2006	1 Year
20	Spectrum Analyzer	R3132	Advantest	150400998	122-02-523E0	Jul 2006	1 Year
65	Power Meter	436A	Hewlett Packard	1725A01930	100-02-501E0	Apr 2006	1 Year
66	Power Sensor	8482A	Hewlett Packard	1551A01013	100-02-501E0	Apr 2006	1 Year
67	Power Sensor	8485A	Hewlett Packard	2942A08969	100-04-021E0	Apr 2006	1 Year
68	FM Linear Detector	MS61A	Anritsu	M77486	123-02-008E0	Oct 2006	1 Year
69	Level Meter	ML422C	Anritsu	M87571	114-02-501E0	Jun 2006	1 Year
70	Measuring Amplifier	2636	B & K	1614851	082-01-502E0	May 2006	1 Year
75	Frequency Counter	53131A	Hewlett Packard	3546A11807	102-02-075E0	May 2006	1 Year
83	FFT Analyzer	R9211C	Advantest	02020253	122-02-506E0	Jun 2006	1 Year
84	Noise Meter	MN-446	Meguro	53030478	082-01-144E0	Apr 2006	1 Year
86	Peak Power Analyzer	8990A/84815A	Hewlett Packard	3220A00486/ 3227A00118	100-02-016E0	Apr 2006	1 Year
163	Digital Oscilloscope	54502A	Hewlett Packard	2934A05573	121-02-502E0	May 2006	1 Year
165	Multimeter	VOAC7413	Iwatsu Electric	0267973	114-02-502E0	Apr 2006	1 Year
172	Test Receiver	ESCI	Rohde & Schwarz	100408	119-04-512E0	Sep 2006	1 Year

**Antennas:**

21	Loop Antenna	HFH2-Z2	Rohde & Schwarz	881058/62	119-05-033E0	Jun 2006	1 Year
22	Dipole Antenna	KBA-511	Kyoritsu	0-170-1	119-05-506E0	Oct 2006	1 Year
23	Dipole Antenna	KBA-511A	Kyoritsu	0-201-13	119-05-504E0	Oct 2006	1 Year
24	Dipole Antenna	KBA-611	Kyoritsu	0-147-14	119-05-507E0	Oct 2006	1 Year
25	Dipole Antenna	KBA-611	Kyoritsu	0-170-1	119-05-505E0	Oct 2006	1 Year
26	Biconical Antenna	BBA9106	Schwarzbeck	VHA91031150	119-05-111E0	Nov 2005	1 Year
27	Biconical Antenna	BBA9106	Schwarzbeck	-	119-05-078E0	Nov 2005	1 Year
28	Log-periodic Antenna	UHALP9107	Schwarzbeck	-	119-05-079E0	Nov 2005	1 Year
29	Log-periodic Antenna	UHALP9107	Schwarzbeck	-	119-05-110E0	Nov 2005	1 Year
30	Log-periodic Antenna	HL025	Rohde & Schwarz	340182/015	119-05-100E0	Jun 2006	1 Year
31	Horn Antenna	3115	EMC Test Systems	6442	119-05-514E0	Jan 2006	2 Year
32	Horn Antenna	3116	EMC Test Systems	2547	119-05-515E0	May 2005	2 Year
167	Biconical Antenna	BBA9106	Schwarzbeck	VHA91032325	119-05-520E0	May 2006	1 Year
168	Log-periodic Antenna	UHALP9108A	Schwarzbeck	0666	119-05-521E0	May 2006	1 Year
169	Biconical Antenna	BBA9106	Schwarzbeck	VHA91032399	119-05-522E0	May 2006	1 Year
170	Log-periodic Antenna	UHALP9108A	Schwarzbeck	0724	119-05-523E0	May 2006	1 Year



31-Oct-2006

No	Type	Model	Manufacturer	Serial	ID	Last Cal.	Interval
<b><u>Cables:</u></b>							
38	RF Cable	5D-2W	Fujikura	-	155-21-001E0	Feb 2006	1 Year
39	RF Cable	5D-2W	Fujikura	-	155-21-002E0	Feb 2006	1 Year
40	RF Cable	3D-2W	Fujikura	-	155-21-005E0	Apr 2006	1 Year
41	RF Cable	3D-2W	Fujikura	-	155-21-006E0	Apr 2006	1 Year
42	RF Cable	3D-2W	Fujikura	-	155-21-007E0	Apr 2006	1 Year
43	RF Cable	RG213/U	Rohde & Schwarz	-	155-21-010E0	Apr 2006	1 Year
44	RF Cable(10m)	S 04272B	Suhner	-	155-21-011E0	May 2006	1 Year
45	RF Cable(1.5m 18GHz)	S 04272B	Suhner	-	155-21-012E0	May 2006	1 Year
46	RF Cable(1m 18GHz)	SUCOFLEX	Suhner	-	155-21-013E0	May 2006	1 Year
47	RF Cable(1m N)	S 04272B	Suhner	-	155-21-015E0	Jun 2006	1 Year
48	RF Cable(1m 26GHz)	SUCOFLEX 104E	Suhner	14543/4E	155-21-016E0	Dec 2005	1 Year
49	RF Cable(4m 26GHz)	SUCOFLEX	Suhner	190630	155-21-017E0	Dec 2005	1 Year
50	RF Cable(10m)	F130-S1S1-394	MEGA PHASE	10510	155-21-018E0	Dec 2005	1 Year
51	RF Cable(7m)	3D-2W	Fujikura	-	155-21-009E0	Apr 2006	1 Year
52	RF Cable(7m)	RG223/U	Suhner	-	155-21-021E0	May 2006	1 Year
<b><u>Networks:</u></b>							
33	LISN	KNW-407	Kyoritsu	8-833-6	149-04-052E0	Apr 2006	1 Year
34	LISN	KNW-407	Kyoritsu	8-855-2	149-04-055E0	Apr 2006	1 Year
35	LISN	KNW-407	Kyoritsu	8-1130-6	149-04-062E0	Apr 2006	1 Year
36	LISN	KNW-242C	Kyoritsu	8-837-13	149-04-054E0	Apr 2006	1 Year
37	Absorbing Clamp	MDS21	Luthi	03293	119-06-506E0	Aug 2006	1 Year
164	LISN	KNW-403D	Kyoritsu	8-1474-3	149-04-059E0	Apr 2006	1 Year
173	Pulse Limiter	ESH3-Z2	Rohde & Schwarz	-	156-01-501E0	Apr 2006	1 Year
174	Pulse Limiter	ESH3-Z2	Rohde & Schwarz	-	156-01-502E0	Apr 2006	1 Year
175	Pulse Limiter	ESH3-Z2	Rohde & Schwarz	-	156-01-503E0	Apr 2006	1 Year
<b><u>Amplifiers:</u></b>							
53	AF Amplifier	P-500L	Accuphase	BOY806	127-01-501E0	Feb 2006	1 Year
54	RF Amplifier	WJ-6882-814	Watkins-Johnson	0414	127-04-017E0	Jun 2006	1 Year
55	RF Amplifier	WJ-5315-556	Watkins-Johnson	106	127-04-006E0	Jun 2006	1 Year
56	RF Amplifier	WJ-5320-307	Watkins-Johnson	645	127-04-005E0	Jun 2006	1 Year
57	RF Amplifier	JS4-00102600- 28-5A	MITEQ	669167	127-04-502E0	Apr 2006	1 Year
<b><u>Generators:</u></b>							
58	Function Generator	3325B	Hewlett Packard	2847A03284	118-08-124E0	Jul 2006	1 Year
59	Function Generator	VP-7422A	Matsushita Communication	050351E122	118-08-503E0	Jul 2006	1 Year
60	Signal Generator	8664A	Hewlett Packard	3035A00140	118-03-014E0	May 2006	1 Year
61	Signal Generator	8664A	Hewlett Packard	3438A00756	118-04-502E0	May 2006	1 Year
62	Signal Generator	6061A	Gigatronics	5130593	118-04-024E0	Mar 2006	1 Year

No	Type	Model	Manufacturer	Serial	ID	31-Oct-2006 Last Cal.	Interval
<b>Others:</b>							
63	Termination(50)	-	Suhner	-	154-06-501E0	Jan 2006	1 Year
64	Termination(50)	-	Suhner	-	154-06-502E0	Jan 2006	1 Year
71	Microphone	4134	B & K	1253497	147-01-502E0	May 2006	1 Year
72	Preamplifier	2639	B & K	1268763	127-01-504E0	-	-
73	Pistonphone	4220	B & K	1165008	147-02-501E0	Mar 2006	1 Year
74	Artificial Mouth	4227	B & K	1274869	-	-	-
76	Oven	-	Ohnishi	-	023-02-018E0	-	-
77	DC Power Supply	6628A	Hewlett Packard	3224A00284	072-05-503E0	Jun 2006	1 Year
78	Band RejectFilter	BRM12294	Micro-tronics	003	149-01-501E0	Jan 2006	1 Year
79	High Pass Filter	F-100-4000-5-	RLC Electronics	0149	149-01-502E0	Feb 2006	1 Year
80	Attenuator	43KC-10	Anritsu	-	148-03-506E0	Feb 2006	1 Year
81	Attenuator	43KC-20	Anritsu	-	148-03-507E0	Feb 2006	1 Year
82	Attenuator	355D	Hewlett Packard	219-10782	148-03-065E0	Apr 2006	1 Year
85	RF Detector	75KC-50	Anritsu	305002	100-02-506E0	Jul 2006	1 Year

COPY